

KENWOOD

CD-RECEIVER

XXV-01D

INSTRUCTION MANUAL

Kenwood Corporation

25th Anniversary



© B64-3151-00/00 (EW)

CH 01

Contents

Safety precautions **4**

Notes **5**

About CDs **7**

About AAC, MP3 and WMA **8**

Notes on Multi-function System **9**

General features **10**

- Power
- Selecting the Source
- Volume
- Attenuator
- Audio Control
- Audio Setup
- Subwoofer Output
- Sound Field Control
- Sound Management system
- Equalizer Control
- WOW Control
- Bypass Control
- Memory mode
- Memory Recall mode
- Theft Deterrent Faceplate
- Faceplate Angle Adjustment
- Display Type Selection
- Graphic part/ Spectrum Analyzer Display Switching
- Wallpaper selecting
- Text Selection for Display
- Text Display Switching
- Icon Display Switching
- Font Color Select
- External Display Switching
- TEL Mute

Tuner features **28**

- Tuning
- Direct Access Tuning
- Station Preset Memory
- Auto Memory Entry
- Preset Tuning

RDS features **30**

- Traffic Information
- Radio Text Scroll
- PTY (Program Type)
- Program Type preset
- Changing Language for PTY Function

CD/Audio file/External disc control features **33**

- Playing CD & Audio file
- Playing External Disc
- Fast Forwarding and Reversing
- Track/File Search
- Disc Search/Folder Search
- Direct Track/File Search
- Direct Disc Search
- Track/File/Disc/Folder Repeat
- Scan Play
- Random Play
- Magazine Random Play
- Disc Random Play
- Folder Select
- Switching the Play mode
- Letter Seek
- Disc Naming (DNPS)
- Text/Title Scroll

DAB tuner control features **39**

- About DAB Tuner control
- Service Preset Memory
- Recalling a Preset Service
- Program Type (PTY) Function
- Program Type preset

Menu system

42

Menu System
Security Code
Touch Sensor Tone
Manual Clock Adjustment
Date Adjustment
Date Mode
Synchronize Clock
DSI (Disabled System Indicator)
Selectable Illumination
Dimmer
Contrast Adjustment
Display-reversing Setting
Built-in Amp Setting
Dual Zone System Setting
B.M.S. (Bass Management System)
B.M.S. Frequency Offset
AMP Control
News Bulletin with Timeout Setting
Local Seek
Tuning Mode
AF (Alternative Frequency)
Restricting RDS Region (Region Restrict
Function)
Auto TP Seek
Monaural Reception
Auxiliary Input Display Setting & Disc Naming
Text Scroll
Built-in Auxiliary input Setting
Power OFF Timer
CD Read Setting
Picture downloading
Voice Index
ACDrive firmware version display
Unique ID display
Demonstration mode Setting
Menu Added for DAB

Basic Operations of remote control 51

Accessories/ Installation Procedure 53

Connecting Wires to Terminals 54

Installation 56

Removing the Unit 57

Troubleshooting Guide 58

Specifications 61

WOW, SRS and  symbol are trademarks of SRS Labs, Inc.
WOW technology is incorporated under license from SRS Labs, Inc.

The "AAC" logo is trademark of Dolby Laboratories.

Safety precautions

▲WARNING

To prevent injury or fire, take the following precautions:

- To prevent a short circuit, never put or leave any metallic objects (such as coins or metal tools) inside the unit.

▲CAUTION

To prevent damage to the machine, take the following precautions:

- Make sure to ground the unit to a negative 12V DC power supply.
- Do not install the unit in a spot exposed to direct sunlight or excessive heat or humidity. Also avoid places with too much dust or the possibility of water splashing.
- Do not place the faceplate or the faceplate case in areas exposed to direct sunlight, excessive heat or humidity. Also avoid places with too much dust or the possibility of water splashing.
- To prevent deterioration, do not touch the terminals of the unit or faceplate with your fingers.
- Do not subject the faceplate to excessive shock, as it is a piece of precision equipment.
- When replacing a fuse, only use a new fuse with the prescribed rating. Using a fuse with the wrong rating may cause your unit to malfunction.
- Do not apply excessive force to the open faceplate or place objects on it. Doing so will cause damage or breakdown.
- Do not use your own screws. Use only the screws provided. If you use the wrong screws, you could damage the unit.

Attach the panel while you are on the vehicle

The panel lock arm appears when the panel is removed. Therefore, the panel must be attached while the electrical system of the car is operating.

Do Not Load 8 cm (3 in.) CDs in the CD slot

If you try to load a 8 cm (3 in.) CD with its adapter into the unit, the adapter might separate from the CD and damage the unit.

About CD players/disc changers connected to this unit

KENWOOD disc changers/ CD players released in 1998 or later can be connected to this unit.

Refer to the catalog or consult your Kenwood dealer for connectable models of disc changers/ CD players.

Note that any KENWOOD disc changers/ CD players released in 1997 or earlier and disc changers made by other makers cannot be connected to this unit.

Connecting unsupported disc changers/CD players to this unit may result in damage.

Set the "O-N" Switch to the "N" position for the applicable KENWOOD disc changers/ CD players.

The functions you can use and the information that can be displayed may differ depending on the models being connected.



- You can damage both your unit and the CD changer if you connect them incorrectly.

Lens Fogging

When you turn on the car heater in cold weather, dew or condensation may form on the lens in the CD player of the unit. Called lens fogging, this condensation on the lens may not allow CDs to play. In such a situation, remove the disc and wait for the condensation to evaporate. If the unit still does not operate normally after a while, consult your Kenwood dealer.

Notes

- If you experience problems during installation, consult your Kenwood dealer.
- If the unit fails to operate properly, press the Reset button. The unit returns to factory settings when the Reset button is pressed.
- Press the reset button if the disc auto changer fails to operate correctly. Normal operation should be restored.

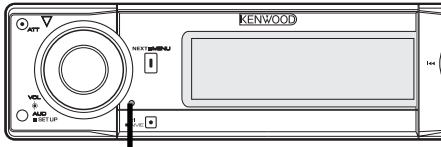

Reset button

- The characters which can be displayed by ISO 8859-1.
- There are places in this manual where lit indicators are described; however, the only time an indicator will light is in the following settings. When Indicator is selected as mentioned in <Text Display Switching> (page 22)
- The illustrations of the display and the panel appearing in this manual are examples used to explain more clearly how the controls are used. Therefore, what appears on the display in the illustrations may differ from what appears on the display on the actual equipment, and some of the illustrations on the display may represent something impossible in actual operation.

Cleaning the Unit

If the faceplate of this unit is stained, wipe it with a dry soft cloth such as a silicon cloth.

If the faceplate is stained badly, wipe the stain off with a cloth moistened with neutral cleaner, then wipe neutral detergent off.



- Applying spray cleaner directly to the unit may affect its mechanical parts. Wiping the faceplate with a hard cloth or using a volatile liquid such as thinner or alcohol may scratch the surface or erase characters.

Cleaning the Faceplate Terminals

If the terminals on the unit or faceplate get dirty, wipe them with a dry, soft cloth.

Before using this unit for the first time

This unit is initially set on the Demonstration mode. When using this unit for the first time, cancel the <Demonstration mode Setting> (page 49).

About ODD (Offset Dual Differential) D/A System

You can enjoy high quality sound play when playing music CDs with the ODD D/A System enabled. ODD D/A System has two built-in D/A converters and each D/A converter processes D/A conversion separately on the front left and right channel. Since digital processing is performed for each channel separately, noise occurrence from interference between channels is completely suppressed and the separation of audio sound output from two channels is distinguished and clear. Also, the ODD/A System produces the data by which the sound data is offset on the minus side and converts the two signals (original and offset data) to the analog signal, which has less noise and distortion, by the synthetic process.

However, ODD D/A System will be disabled if the following settings are selected.

- When "2ZONE" of <Audio Setup> (page 11) is "ON".
- When <Bypass Control> (page 16) is "Bypass".

Notes

About "Media Manager" of PC application

- "Media Manager" is recorded in the CD-ROM attached to this unit.
- Refer to the attached installation manual for the installation method of "Media Manager".
- Refer to the user's manual recorded in the installation CD-ROM and Help of "Media Manager" for the operation method of "Media Manager".
- The unit can play CD (hereafter called "ACDrive disc") created by "Media Manager".
- Refer to the following site for the updated information of "Media Manager".
<http://www.kenwood.mediamanager.jp>
- Contact Kenwood for the function and operation of the "Media Manager".
- "Media Manager" is a product of PhatNoise.

The marking of products using lasers (Except for some areas)



**CLASS 1
LASER PRODUCT**

The label is attached to the chassis/case and says that the component uses laser beams that have been classified as Class 1. It means that the unit is utilizing laser beams that are of a weaker class. There is no danger of hazardous radiation outside the unit.

This Product is not installed by the manufacturer of a vehicle on the production line, nor by the professional importer of a vehicle into an EU Member State.

About CDs

Handling CDs

- Don't touch the recording surface of the CD.



- CD-R and CD-RW are easier to damage than a normal music CD. Use a CD-R or a CD-RW after reading the caution items on the package etc.
- Do not stick tape etc. on the CD, or use a CD with tape stuck on it.

When using a new CD

If the CD center hole or outside rim has burrs, use the CD only after removing the burrs with a ballpoint pen, etc.

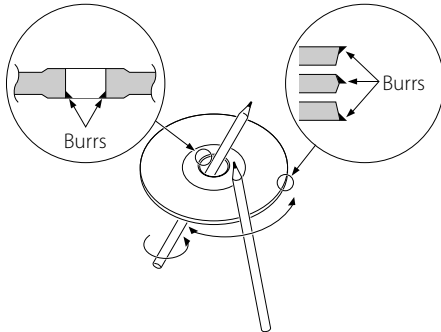

CD accessories

Don't use disc type accessories.

CD cleaning

Clean from the center of the disc and move outward.

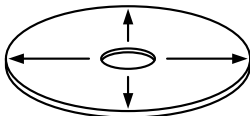

Removing CDs

When removing CDs from this unit pull them out horizontally.

CDs that can't be used

- CDs that aren't round can't be used.

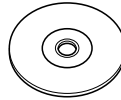

- CDs with coloring on the recording surface or that are dirty can't be used.
- This unit can only play the CDs with



It may not correctly play discs which do not have the mark.

- A CD-R or CD-RW that hasn't been finalized can't be played. (For the finalization process refer to your CD-R/CD-RW writing software, and your CD-R/CD-RW recorder instruction manual.)

CD storage

- Don't place them in direct sunlight (On the seat or dashboard etc.) and where the temperature is high.
- Store CDs in their cases.

About AAC, MP3 and WMA

The playable AAC/MP3/WMA file (hereafter called Audio file) and the media format has the following limitation. The Audio file, which is not conforming to the specification, may not play normally, or the file and folder names may not display correctly.



- Attach the correct extension for the Audio file (AAC: ".M4A", MP3: ".MP3", WMA: ".WMA")
- Do not attach the extensions to files other than the Audio file. If the extension is attached, the file, which is not the Audio file, will play and outputs a loud noise, causing damage to the speaker.
- The files with copy protection cannot be played.

Playable AAC file

- ".m4a" file encoded by AAC-LC format.
Refer to <http://www.kenwood.mediamanager.jp> for the details.

Playable MP3 file

- MPEG 1/2 Audio Layer 3 file
- Transfer bit rate: 8-320 kbps
- Sampling frequency
: 16, 22.05, 24, 32, 44.1, 48 kHz

Playable WMA file

- The file in accordance with Windows Media Audio (Except for the file for Windows Media Player 9 or after which applies the new functions)
- Transfer bit rate: 48-192 kbps
- Sampling frequency: 32, 44.1, 48 kHz

Playable media

- CD-ROM, CD-R, CD-RW



- CD-RW discs which are quick formatted by the writing software cannot be used.
- When recording to the maximum media capacity at once, the writing software is set to "Disc at once".

Playable disc format

- ISO 9660 Level 1/2
- Joliet
- Romeo
- Long file name.

The maximum number of characters for display

File/Folder name: 128 characters

MP3 ID3 Tag/ WMA Contents property
: 30 characters

AAC song information: 60 characters



- File/Folder name is the number of the characters including the extensions
- AAC ID3 Tag cannot be displayed.

Limitation of structure for the file and the folder

- Maximum number of directory levels: 8
- Maximum number of folders: 100
- Maximum number of files per folder: 4096

Playing order of the Audio file

The Audio file plays in the order which is written by writing software. You may be able to set the playing order by writing the play sequence numbers such as "01" to "99" at the beginning of the file name.

Example

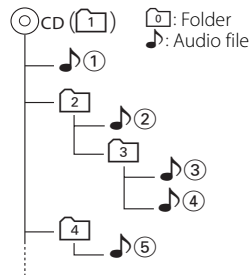

• Playing order

Playing order after 1 play.

➡ 2, 3, 4, 5...

• File search

Forward file search during 3 play.

Push the Control knob toward ➡ 4

• Folder search

Forward folder search during 2 play.

Push the Control knob toward [FM] ➡ 3, 4...

• Folder select

When the selection is set to directory 1, and you want to skip to the folder 2 at the same level.

Push the Control knob towards ➡ 2

When the selection is set to directory 3, moves the level up by folder select.

Push the Control knob towards [FM] ➡ 2

Notes on Multi-function System

What is the Multi-function System?

Multi-function System shows the Multi-function display, allowing you to select various functions and settings.

Functions available for the current source are displayed.

Operational

1 Press the [NEXT] button to Show the Multi-function display

Each time you press the [NEXT] button, the Multi-function display is switched among the Source Function display, System Function display, and blank display.

Example: Multi-function display for CD source

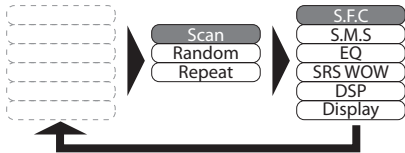

- The operation ends automatically if you do not operate within 10 seconds:

2 Turn the [VOL] knob to highlight the item you want to select.

3 Press the [VOL] knob to select the highlighted item.



- In the body text, steps 2 and 3 are described as follows:

Turn the [VOL] knob to select the item you want to select.

Press the [VOL] knob.

- During Multi-function System mode, the [VOL] knob or Control knob flashes to indicate that it is available for multi-function setting.

Returning to the Previous Display

Select "Return" on the Multi-function display, or press the [NEXT] button.

Real operational example of the Multi-function System

Example: Turning ON/OFF the Random Play during CD play.

1. Show the Multi-function display of the Random Play.

Press the [NEXT] button.



2. Select the "Random" item

Rotate the [VOL] knob.

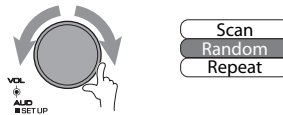

3. Turn ON/OFF the Random Play.

Press the [VOL] knob.

Each time you press the [VOL] knob under the "Random" function display the Random Play is turned ON/OFF.

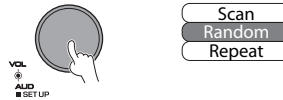

- In the body text, steps 2 and 3 are described as follows:

Turn the [VOL] knob to select "Random".

Press the [VOL] knob.

General features

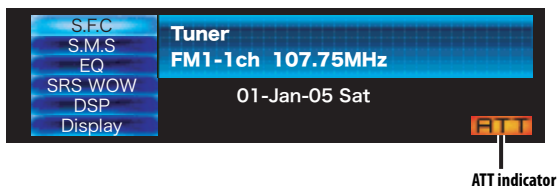
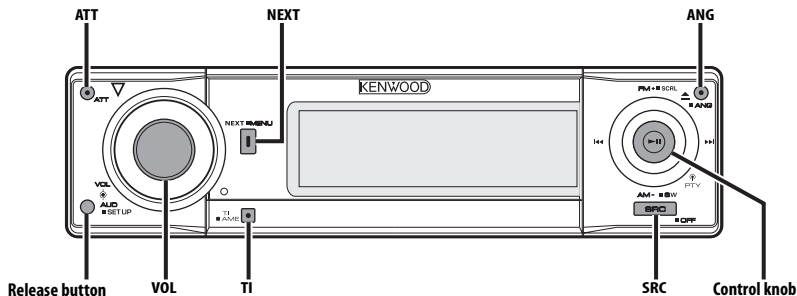

Power

Turning ON the Power

Press the [SRC] button.



- When the power is ON, the <Security Code> (page 42) is displayed as "CODE ON" or "CODE OFF".

Turning OFF the Power

Press the [SRC] button for at least 1 second.

Selecting the Source

Press the [SRC] button.

Source required	Display
DAB (Optional accessory)	"DAB"
Tuner	"TUNER"
CD	"Compact Disc"
External disc (Optional accessory)	"CD Changer"
Auxiliary input	"AUX"
Auxiliary input (Optional accessory)	"AUX EXT"
Standby (Illumination only mode)	"STANDBY"



- This unit automatically turns full power OFF after 20 minutes lapses in Standby mode in order to save the vehicle's battery. The time until full power OFF can be set in <Power OFF Timer> (page 48).

Volume

Increasing Volume

Turn the [VOL] knob clockwise.

Decreasing Volume

Turn the [VOL] knob counterclockwise.

Attenuator

Turning the volume down quickly.

Press the [ATT] button.

Each time you press the button is pressed, the

Attenuator turns ON and OFF.
When the Attenuator is ON, the "ATT" indicator blinks.

Audio Control

1 Select the source to adjust

Press the [SRC] button.

2 Enter Audio Control mode

Press the [VOL] knob.

3 Select the Audio item to adjust

Press the [VOL] knob.

Each time you press the knob, the item to be adjusted alternates between the items shown in the table below.

4 Adjust the Audio item

Turn the [VOL] knob.

Adjustment Item	Display	Range
Rear Volume *1	"REAR VOLUME"	0 — 35
Subwoofer level *2:*3	"SW LEVEL"	-15 — +15
Balance	"BALANCE"	Left 15 — Right 15
Fader*3	"FADER"	Rear 15 — Front 15

Exit Audio Control mode



- *1 You can control this item when "2ZONE" of <Audio Setup> (page 11) is set to "ON".
- *2 You can control this item when Speaker Select Subwoofer of <Sound Management system> (page 13) is set to any item other than "None".
- *2 You can control this item when <Subwoofer Output> (page 12) is set to "SUBWOOFER ON".
- *3 You can control this item when "2ZONE" of <Audio Setup> (page 11) is set to "OFF".

5 Exit Audio Control mode

Press the [TI] or [NEXT] button.

Audio Setup

Setting the Sound system, such as Volume offset and Dual Zone.

1 Select the source to adjust

Press the [SRC] button.

2 Enter Audio Setup mode

Press the [VOL] knob for at least 1 second.

3 Select the Audio Setup item to adjust

Press the [VOL] knob.

Each time you press the knob, the item to be adjusted alternates between the items shown in the table below.

4 Setup the Audio item

Turn the [VOL] knob.

Adjustment Item	Display	Range
Volume offset	"VOLUME OFFSET"	-8 — 0
Dual Zone System	"2ZONE"	ON/OFF



- Volume offset: Sets each source's volume as a difference from the basic volume.
- Dual Zone System
Main source and sub source (Auxiliary input) output Front channel and Rear channel separately.
- Set up the channel of sub source by <Dual Zone System Setting> (page 45).
- Select Main source by [SRC] button.
- Adjust the volume of Front channel by [VOL] knob.
- Adjust the volume of Rear channel by <Audio Control> (page 11).
- The Audio Control has no effect on sub source.
- You can use the Dual Zone System with the Auxiliary input sources listed below.
- Internal auxiliary input
- You can use the Dual Zone System only when you have set the rear speaker to any mode other than "None" in the <Sound Management system> (page 13).
- When the "2ZONE" is ON, ignore the following setups.
- <Sound Field Control> (page 12)
- <Sound Management system> (page 13)
- <Equalizer Control> (page 14)
- <WOW Control> (page 15)
- <Bypass Control> (page 16)
- ODD D/A System is not effective when the "2ZONE" is ON.

5 Exit Audio Setup mode

Press the [VOL] knob for at least 1 second.

Subwoofer Output

Turning the Subwoofer output ON or OFF.

Hold down on [AM] of the Control knob for at least 1 second.

Each time you press the button, Subwoofer output switches ON and OFF.

When it is ON, "SUBWOOFER ON" is displayed.



- You can control this function when "2ZONE" of <Audio Setup> (page 11) is set to "OFF".
- You can control this item when Speaker Select Subwoofer of <Sound Management system> (page 13) is set to any item other than "None".

Sound Field Control

1 Select the source to adjust

Press the [SRC] button.

2 Show the Multi-function display

Press the [NEXT] button repeatedly until "S.F.C" appears.

Refer to <Notes on Multi-function System> (page 9).

3 Enter Sound Field Control mode

Turn the [VOL] knob to select "S.F.C".

Press the [VOL] knob.



- To get the best sound, first set the Cabin Setting and Speaker Select Front/Rear parameters using the <Sound Management system> (page 13).
- When "2ZONE" of <Audio Setup> (page 11) is ON, you cannot select "S.F.C".

4 Select the Sound Field Control item to adjust

1 Turn the [VOL] knob to select the item you want to select. Press the [VOL] knob.

2 Press the Control knob.

3 Push the Control knob towards [FM] or [AM].

1	2	3	Sound Field control item
"X'Over"	"HPF Front"	"fc" "SLP"	Front High Pass Filter Frequency Front High Pass Filter Slope
	"HPF Rear"*1	"fc" "SLP"	Rear High Pass Filter Frequency Rear High Pass Filter Slope
	"LPF SubWoofe*r"*2	"fc" "SLP"	Subwoofer Low Pass Filter Frequency Subwoofer Low Pass Filter Slope
		"Phase"	Subwoofer Low Pass Filter Phase
"DTA"	"DTA Front"		DTA Front
	"DTA Rear"*1		DTA Rear
	"DTA SubWoofe*r"*2		DTA Subwoofer
"POSI"			Position Setting
"Preset"			Preset value storage/recalling



- "Preset": You can store an adjusted sound control value by selecting "Memory". Refer to <Memory mode> (page 16). Also, you can recall it by selecting "Recall". Refer to <Memory Recall mode> (page 16).
- You can adjust "SubWoofe*r" when <Subwoofer Output> (page 12) is set to "SUBWOOFER ON".
- X'Over (Crossover Network Setup)
You can manually set a crossover frequency for the speakers.
- DTA (Digital Time Alignment)
Manually set the sound output timing of each channel.
- *1 You can control this item when Speaker Select Rear of <Sound Management system> (page 13) is set to any item other than "None".
- *2 You can control this item when Speaker Select Subwoofer of <Sound Management system> (page 13) is set to any item other than "None".

5 Adjust the Sound Field Control item

Push the Control knob towards [◀◀] or [▶▶].

Each time you push the knob, the setting alternates between the settings shown in the table below.

Sound Field Control Item	Range
Front High Pass Filter Frequency/ Rear High Pass Filter Frequency	Through/30 — 100/120/150/ 180/220/250 (Hz)
Front High Pass Filter Slope/ Rear High Pass Filter Slope/ Subwoofer Low Pass Filter Slope	-12/-18/-24 dB/Oct
Subwoofer Low Pass Filter Frequency	30 — 100/120/150/180/220/ 250 (Hz)/Through
Subwoofer Low Pass Filter Phase	Normal/ Reverse

DTA Front/DTA Rear DTA Subwoofer	0 — 610 (cm)
Position Setting	Front-Left/ Front-Right/ Front/ ALL



- When the "2ZONE" of <Audio Setup> (page 11) is "ON", the following setups are ignored.
 - "X'Over"
 - "DTA"
 - "POSI"
 - "Preset"

6 Exit Sound Field Control mode

Turn the [VOL] knob to select "Return".
Press the [VOL] knob.

Sound Management system

1 Select the source to adjust

Press the [SRC] button.

2 Show the Multi-function display

Press the [NEXT] button repeatedly until "S.M.S" appears.

Refer to <Notes on Multi-function System> (page 9).

3 Enter Sound Management mode

Turn the [VOL] knob to select "S.M.S".

Press the [VOL] knob.



- When "2ZONE" of <Audio Setup> (page 11) is ON, you cannot select "S.M.S".

4 Select the Sound Management item to adjust

Turn the [VOL] knob to select the item you want to select.

Press the [VOL] knob.

Multi-function item	Sound Management Item
"Cabin"	Cabin Setting
"Front"	Speaker Select Front
"Rear"	Speaker Select Rear
"Sub-W"	Speaker Select Subwoofer
"Preset"	Preset value storage/recalling



- "Preset": You can store an adjusted sound control value by selecting "Memory". Refer to <Memory mode> (page 16). Also, you can recall it by selecting "Recall". Refer to <Memory Recall mode> (page 16).

5 Adjust the Sound Management item

Push the Control knob towards [◀◀] or [▶▶].

Each time you push the knob, the setting alternates between the settings shown in the table below.

Sound Management Item	Range
Cabin Setting	OFF/ Compact/ Sedan/ Wagon1/ Wagon2/ Minivan1/ Minivan2/ SUV/ Passenger Van
Speaker Select Front	16cm/ 17cm/ 18cm/ 4x6/ 5x7/ 6x8/ 6x9/ 7x10/ O.E.M./ 10cm/ 13cm
Speaker Select Rear	16cm/ 17cm/ 18cm/ 4x6/ 5x7/ 6x8/ 6x9/ 7x10/ None/ O.E.M./ 10cm/ 13cm
Speaker Select Subwoofer	25cm/ 30cm/ 38cm over/ None/ 16cm/ 20cm

6 Exit Sound Management mode

Turn the [VOL] knob to select "Return".
Press the [VOL] knob.

Equalizer Control

1 Select the source to adjust

Press the [SRC] button.

2 Show the Multi-function display

Press the [NEXT] button repeatedly until "EQ" appears.

Refer to <Notes on Multi-function System> (page 9).

3 Enter Equalizer Control mode

Turn the [VOL] knob to select "EQ".

Press the [VOL] knob.



- When "2ZONE" of <Audio Setup> (page 11) is ON, you cannot select "EQ".

4 Select the Equalizer Control item to adjust

Turn the [VOL] knob to select the item you want to select.

Press the [VOL] knob.

Multi-function item	Equalizer Control Item
"SystemQ"	System Q Setting
"Front"	Equalizer Front Setting
"Rear"*	Equalizer Rear Setting
"Preset"	Preset value storage/recalling



- "Preset": You can store an adjusted sound control value by selecting "Memory". Refer to <Memory mode> (page 16). Also, you can recall it by selecting "Recall". Refer to <Memory Recall mode> (page 16).
- * You can control this item when Speaker Select Rear of <Sound Management system> (page 13) is set to any item other than "None".

5 Adjust the Equalizer control item

System Q Setting (Sound Type)

Push the Control knob towards [◀◀] or [▶▶].

Each time you push the knob, the setting alternates between the settings shown in the table below.

Sound setting	Display
User memory	"User"
Natural	"Natural"
Rock	"Rock"
Pops	"Pops"
Easy	"Easy"

Top 40	"Top40"
Jazz	"Jazz"



- User memory:
The values set on the <Equalizer Front Setting/ Equalizer Rear Setting>.
- Change each setting value with the <Sound Management system> (page 13).
First, select the speaker type with the Speaker setting.

Equalizer Front Setting/

Equalizer Rear Setting

1 Select a frequency band you wish to adjust

Press the Control knob.

Each time you press the button is pressed, the band alternates between "Band 1" and "Band 4".

2 Select the items to adjust for Equalizer.

Press the [FM] or [AM] button.

Each time you press the button is pressed, the item to be adjusted alternates between the items shown in the table below.

1	2	Equalizer Control Item
"Band1"/	"FREQ"	Equalizer Frequency
"Band2"/	"Level"	Equalizer Level
"Band3"/	"Q Factor"	Equalizer Quality
"Band4"		

3 Adjust the Equalizer.

Push the Control knob towards [◀◀] or [▶▶].

Each time you push the knob, the setting alternates between the settings shown in the table below.

Equalizer adjustment item	Range
Equalizer Front Frequency/ Equalizer Rear Frequency	Refer to the followings.
Equalizer Front Level/ Equalizer Rear Level	-9 — +9
Equalizer Front Quality/ Equalizer Rear Quality	0.25/ 0.50/ 1.00/ 2.00



- The frequency which can be selected by each Frequency band is shown below.

Band	Frequency
Band1	60/ 80/ 100/ 120/ 160/ 200 (Hz)
Band2	250/ 315/ 400/ 500/ 630/ 800/ 1k (Hz)
Band3	1.25/ 1.6/ 2/ 2.5/ 3.15/ 4 (kHz)
Band4	5/ 6.3/ 8/ 10/ 12.5/ 16 (kHz)



- To get the best sound, first set the Cabin Setting and Speaker Select Front/Rear parameters using the <Sound Management system> (page 13).

6 Exit Equalizer Control mode

Turn the [VOL] knob to select "Return".

Press the [VOL] knob.

WOW Control

1 Select the source to adjust

Press the [SRC] button.

2 Show the Multi-function display

Press the [NEXT] button repeatedly until "SRS WOW" appears.

Refer to <Notes on Multi-function System> (page 9).

3 Enter WOW Control mode

Turn the [VOL] knob to select "SRS WOW".

Press the [VOL] knob.



- When "2ZONE" of <Audio Setup> (page 11) is ON, you cannot select "SRS WOW".

4 Select the WOW Control item to adjust

Turn the [VOL] knob to select the item you want to select.

Press the [VOL] knob.

Multi-function item	WOW Control Item
"Effect"	Effect
"FOCUS"	FOCUS
"TB-F"	TruBass Front
"TB-R"*	TruBass Rear
"SRS 3D"	SRS 3D



- * You can control this item when Speaker Select Rear of <Sound Management system> (page 13) is set to any item other than "None".

5 Adjust the WOW control item

Push the Control knob towards [◀◀] or [▶▶].

Each time you push the knob, the setting alternates between the settings shown in the table below.

WOW Control Item	Range
Effect	Middle/High/User/Through/Low
FOCUS	OFF/1 — 9
TruBass Front	OFF/1 — 4
TruBass Rear	OFF/1 — 4
SRS 3D	OFF/1 — 4



- Effect: TruBass, FOCUS and SRS 3D are all set to values shown in the table below.

Effect	TruBass	FOCUS	SRS 3D
High	4	8	4
Middle	3	6	2
Low	2	3	1

- FOCUS: Adjusts the vertical position of the front speaker and sound image by virtual adjustment.
- TruBass: Assists the playback for the super bass sound.
- SRS 3D: Makes a natural 3D sound field.
- You cannot set SRS 3D in tuner source.

6 Exit WOW Control mode

Turn the [VOL] knob to select "Return".

Press the [VOL] knob.



- To get the best sound, first set the Speaker select.

General features

Bypass Control

Temporarily bypassing DSP (Digital Signal Processor) System.

1 Select the source to adjust

Press the [SRC] button.

2 Show the Multi-function display

Press the [NEXT] button repeatedly until "DSP" appears.

Refer to <Notes on Multi-function System> (page 9).

3 Enter Bypass Control mode

Turn the [VOL] knob to select "DSP".
Press the [VOL] knob.



- When "2ZONE" of <Audio Setup> (page 11) is ON, you cannot select "DSP".

4 Set up Bypass

Press the [VOL] knob.

"Bypass": There is no effect by DSP.

"Through": There is an effect by DSP.



- When the mode is set to "Bypass", DSP System cannot be adjusted.
- When the mode is set to "Bypass", ODD D/A System is not effective.

Memory mode

Storing the values of Sound Control in memory.

1 Setup Sound Control

Refer to the following operations to setup the Sound Control.

- <Audio Control> (page 11)
- <Sound Field Control> (page 12)
- <Sound Management system> (page 13)
- <Equalizer Control> (page 14)

2 Select the Preset Memory item

Turn the [VOL] knob to select "Preset".
Press the [VOL] knob.

3 Enter Memory mode

Turn the [VOL] knob to select "Memory".
Press the [VOL] knob.

4 Put in the memory

Turn the [VOL] knob to select "Memory1" or "Memory2".

Press the [VOL] knob for at least 2 seconds.

The "MEMORY" display blinks 1 time.

5 Exit Memory mode

Turn the [VOL] knob to select "Return".

Press the [VOL] knob.



- "Memory1": When you press the Reset, all the sources will be the setting value which is registered.
- The following items cannot be registered.
Rear Volume, Balance, Fader, Position Setting, System Q Setting

Memory Recall mode

Recall the value in the memory by the memory mode.

1 Select the source to adjust

Press the [SRC] button.

2 Show the Multi-function display

Press the [NEXT] button repeatedly until "S.F.C" appears.

Refer to <Notes on Multi-function System> (page 9).

3 Select the key function which contains the item you wish to recall

Turn the [VOL] knob to select "S.F.C" / "S.M.S" / "EQ".

Press the [VOL] knob.

4 Select the Preset Memory item

Turn the [VOL] knob to select "Preset".
Press the [VOL] knob.

5 Enter recall mode

Turn the [VOL] knob to select "Recall".
Press the [VOL] knob.

6 Select the recall item

Turn the [VOL] knob to select "Recall1" or "Recall2".

Press the [VOL] knob for at least 2 seconds.
The "RECALL" display blinks 1 time.

"Recall1": Recall the value put in "Memory1" by
<Memory mode> (page 16).

"Recall2": Recall the value put in "Memory2" by
<Memory mode> (page 16).

7 Exit Memory Recall mode

Turn the [VOL] knob to select "Return".

Press the [VOL] knob.

Theft Deterrent Faceplate

The faceplate of the unit can be detached and taken with you, helping to deter theft.

Removing the Faceplate

Press the Release button.

The faceplate is unlocked, allowing you to detach it.

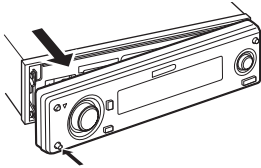

- The faceplate is a precision piece of equipment and can be damaged by shocks or jolts. For that reason, keep the faceplate in its special storage case while detached.
- Do not expose the faceplate or its storage case to direct sunlight or excessive heat or humidity. Also avoid places with too much dust or the possibility of water splashing.

Reattaching the Faceplate

1 Align the shaft on the unit with the depression on the faceplate.

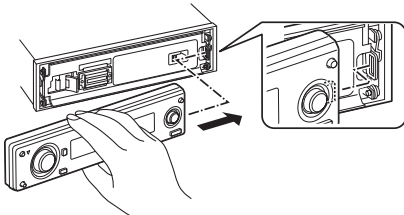

2 Push the faceplate in until it clicks.

The faceplate is locked in place, allowing you to use the unit.

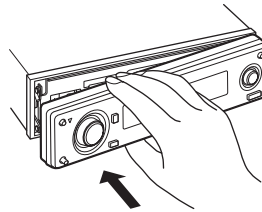

Faceplate Angle Adjustment

Press the [ANG] button for at least 1 second.



- Do not apply excessive force to the faceplate. It can cause damage.

Display Type Selection

Changing the display mode.

1 Show the Multi-function display

Press the [NEXT] button repeatedly until "Display" appears.

Refer to <Notes on Multi-function System> (page 9).

2 Enter display control mode

Turn the [VOL] knob to select "Display".
Press the [VOL] knob.



3 Select the display mode

Turn the [VOL] knob to select "Mode".
Press the [VOL] knob.

4 Select the display Type

Push the Control knob towards [◀◀] or [▶▶].

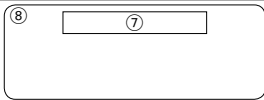
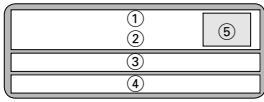
Each time you push the knob, the display mode alternates between the display modes shown in the table below.

Display Mode	Display
"Display type A"	
"Display Type B"	
"Display type C"	
"Display type D"	

- ① 1st text display part
- ② 2nd text display part
- ③ 3rd text display part
- ④ 4th text display part
- ⑤ Indicator display part
- ⑥ Icon display part
- ⑦ Text display part
- ⑧ Graphic display part

5 Exit display control mode

Turn the [VOL] knob to select "Return".
Press the [VOL] knob.



- Change the information by the Display Type. Refer to the page on the following table for the methods to alternate by the Display Type.

Display Type	A	B	C	D
1st text ①	—	—	22	22
2nd text ②	—	—	22	22
3rd text ③	—	—	22	22
4th text ④	—	—	22	22
Icon ⑥	—	—	—	26
Text ⑦	—	20	—	—
Graphic ⑧	18	18	—	—

Display Type A/ Display Type B

Graphic part/ Spectrum Analyzer Display Switching

Changing the graphic Display/ Spectrum analyzer display.

1 Show the Multi-function display

Press the [NEXT] button repeatedly until "Display" appears.

Refer to <Notes on Multi-function System> (page 9).

2 Enter display control mode

Turn the [VOL] knob to select "Display".
Press the [VOL] knob.

3 Select the display mode

Turn the [VOL] knob to select "Mode".
Press the [VOL] knob.

4 Select the display Type

Push the Control knob towards [◀◀] or [▶▶].

Select the "Display Type A"/ "Display Type B" display.

5 Select the graphic/ spectrum analyzer display

Turn the [VOL] knob to select "SA/GRPH".
Press the [VOL] knob.

6 Select the graphic/ spectrum analyzer display part display

Push the Control knob towards [◀◀] or [▶▶].

Each time you press the button, the graphic display/ spectrum analyzer display alternates between the displays shown in the table below.

Graphic display/ Spectrum Analyzer display

Movie 1

Movie 2

Movie 3 (Movie 1 and Movie 2)

Spectrum analyzer 1

⋮

Spectrum analyzer 8

Wallpaper & *Downloaded Wallpaper

7 Exit display control mode

Turn the [VOL] knob to select "Return".
Press the [VOL] knob.



- * For Download Wall Paper, refer to <Picture downloading> (page 48).
- During standby, Spectrum analyzer cannot be selected.

Display Type A/ Display Type B

Wallpaper selecting

Selecting a wallpaper to display when Display Type is set to "Display Type A"/ "Display Type B".

1 Select the wallpaper display

Refer to <Graphic part/ Spectrum Analyzer Display Switching> (page 18).

2 Select the wallpaper

Display the wallpapers one after another
Press the Control knob.

Each time you press the knob, the Wallpaper scan is turned ON and OFF.

When scan is ON, "SCAN" is displayed.

When scan is ON, each wallpaper is displayed every several seconds.

Select wallpaper manually

1 Turn the wallpaper scan OFF.

Press the Control knob.

Each time you press the knob, the Wallpaper scan is turned ON and OFF.

2 Select the wallpaper.

Push the Control knob towards [FM] or [AM].

Each time you push the knob, the Wallpaper changes.

3 Exit Display Control mode

Turn the [VOL] knob to select "Return".

Press the [VOL] knob.

General features

Display Type B

Text Selection for Display

Selecting the text display.

1 Show the Multi-function display

Press the [NEXT] button repeatedly until "Display" appears.

Refer to <Notes on Multi-function System> (page 9).

2 Enter display control mode

Turn the [VOL] knob to select "Display".
Press the [VOL] knob.

3 Select the display mode

Turn the [VOL] knob to select "Mode".
Press the [VOL] knob.

4 Select the display Type

Push the Control knob towards [◀◀] or [▶▶].

Select the "Display Type B" display.

5 Enter text select mode

Turn the [VOL] knob to select "Text".
Press the [VOL] knob.

6 Select the text

Push the Control knob towards [◀◀] or [▶▶].

In Tuner source

Information	Display
Program Service name (FM)	"BAND+ch+PS"*
Radio text or Program Service name (FM)	"Radio Text"*
Frequency (MW, LW)	"BAND+ch+FREQ"
Clock	"Clock"
Date	"Date"

In CD & External disc source

Information	Display
Disc title	"Disc Title"*
Track title	"Track Title"*
Track number & Play time	"P-Time"
Disc Name	"DNPS"*1
Clock	"Clock"
Date	"Date"

In Audio file source

Information	Display
Song title & Artist name	"Title/Artist"*
Album name & Artist name	"Album/Artist"*
Folder name	"Folder Name"
File name	"File Name"
File number & Play time	"P-Time"
Clock	"Clock"
Date	"Date"

In DAB source

Information	Display
Service label	"Service Label"*
Dynamic label	"Dynamic Label"*2
PTY label	"PTY Label"*2
Component label	"Component Label"*
Audio quality	"Audio Quality"*2
Ensemble label	"Ensemble Label"*
Region label	"Region Label"*
Received Frequency	"Frequency"
Clock	"Clock"
Date	"Date"

In Auxiliary input source

Information	Display
Auxiliary input name	"AUX Name"/ "AUX EXT"
Clock	"Clock"
Date	"Date"

In Standby mode

Information	Display
Source name	"Standby"
Clock	"Clock"
Date	"Date"

7 Exit Display Control mode

Turn the [VOL] knob to select "Return".
Press the [VOL] knob.



- Auxiliary input name is displayed for the Auxiliary input source.
- * If the contents of the information cannot be displayed, Play time or Frequency is displayed.
- *¹ If the contents of the information cannot be displayed, "No Name" is displayed.
- *² If the contents of the information cannot be displayed, "No Text"/"None"/"Obscure Audio" is displayed.
- When LX-AMP is connected, the item setup by the Display mode of LX-AMP is displayed.
- Track number at Audio file displays the last 3 digits when the track number exceeds 1000 songs.

General features

Display Type C/ Display Type D

Text Display Switching

Changing the text display.

1 Show the Multi-function display

Press the [NEXT] button repeatedly until "Display" appears.

Refer to <Notes on Multi-function System> (page 9).

2 Enter display control mode

Turn the [VOL] knob to select "Display".
Press the [VOL] knob.

3 Select the display mode

Turn the [VOL] knob to select "Mode".
Press the [VOL] knob.

4 Select the display Type

Push the Control knob towards [◀◀] or [▶▶].

Select the "Display Type C"/"Display Type D" display.

5 Enter text select mode

Turn the [VOL] knob to select "Text".
Press the [VOL] knob.

6 Select the text display part

Select the display mode
Press the Control knob.

Each time you push the knob, the display mode alternates between the display modes shown in the table below.

	Display Type C	Display Type D
a		
b		
c		

a) Source display and 2-item display

b) 4-item display

c) 1-item 4-row display

① 1st text display part

② 2nd text display part

③ 3rd text display part

④ 4th text display part

⑤ Indicator display part

⑥ Icon display part

Select the row

Push the Control knob towards [FM] or [AM].

The cursor (▶) moves to the selected text display part.

Select the text

Push the Control knob towards [◀◀] or [▶▶].

Refer to the table described later for setting items.

7 Exit Display Control mode

Turn the [VOL] knob to select "Return".
Press the [VOL] knob.



- Same information cannot be displayed in 1st – 4th text display part. However, the blank display is able to have multiple selections.
- * If the contents of the information cannot be displayed, either of the following is displayed:
 - In the 1st text display part①, the play time or frequency is displayed.
 - In other modes, blank is displayed.
- *1 If the contents of the information cannot be displayed, "No Name" is displayed.
- *2 If the contents of the information cannot be displayed, "No Text"/"None"/"Obscure Audio" is displayed.
- When LX-AMP is connected, the item setup by the Display mode of LX-AMP is displayed. (Other than 1-item 4-row display©)
- Setting in some rows cannot be changed during interrupt mode (e.g., traffic information).

Texts displayed on Display Type C/D display in 2-item display^a mode

In Tuner source

Information (① ②)	
Source name	
Frequency	
Information (③ ④)	Display
Radio text (FM)	"Radio Text"*
Program Service name (FM)	"Program Service Name"*
Spectrum Analyzer & Clock	"Speana/Clock"
Date	"Date"
No display	"Blank"

In CD & External disc source

Information (① ②)	
Source name	
Track number & Play time	
Information (③ ④)	Display
Disc title	"Disc Title"*
Track title	"Track Title"*
Disc name	"DNPS"* ¹
Spectrum Analyzer & Clock	"Speana/Clock"
Date	"Date"
No display	"Blank"

In Audio file source

Information (① ②)	
Source name	
Folder number, File number & Play time	
Information (③ ④)	Display
Song title & Artist name	"Title/Artist"*
Album name & Artist name	"Album/Artist"*
Folder name	"Folder Name"
File name	"File Name"
Spectrum Analyzer & Clock	"Speana/Clock"
Date	"Date"
No display	"Blank"

In Standby

Information (① ②)	
Source name	
Information (③ ④)	Display
Clock	"Clock"
Date	"Date"
No display	"Blank"

In Auxiliary input source

Information (① ②)	
Source name	
Information (③ ④)	Display
Spectrum Analyzer & Clock	"Speana/Clock"
Date	"Date"
No display	"Blank"

In DAB source

Information (① ②)	
Source name	
Frequency	
Information (③ ④)	Display
Service label	"Service Label"*
Dynamic label	"Dynamic Label"* ²
PTY label	"PTY Label"* ²
Component label	"Component Label"*
Audio quality	"Audio Quality"* ²
Ensemble label	"Ensemble Label"*
Region label	"Region Label"*
Spectrum Analyzer & Clock	"Speana/Clock"
Date	"Date"
No display	"Blank"

General features

Texts displayed on Display Type C/D display in 4-item display mode

In Tuner source

Information	Display	Condition
Program Service name (FM)	"BAND+ch+PS"*	①
Radio text or Program Service name (FM)	"Radio Text"*	①
Radio text (FM)	"Radio Text"*	②③④
Program Service name (FM)	"Program Service Name"*	②③④
Frequency	"BAND+ch+FREQ"	①
Indicator	"Indicator"	①②③④
Spectrum Analyzer & Clock	"Speana/Clock"	①②③④
Date	"Date"	①②③④
No display	"Blank"	②③④

In CD & External disc source

Information	Display	Condition
Disc title	"Disc Title"*	①②③④
Track title	"Track Title"*	①②③④
Track number & Play time	"P-Time"	①
Disc name	"DNPS"*1	①②③④
Indicator	"Indicator"	①②③④
Spectrum Analyzer & Clock	"Speana/Clock"	①②③④
Date	"Date"	①②③④
No display	"Blank"	②③④

In Audio file source

Information	Display	Condition
Song title & Artist name	"Title/Artist"*	①②③④
Album name & Artist name	"Album/Artist"*	①②③④
Folder name	"Folder Name"	①②③④
File name	"File Name"	①②③④
File number & Play time	"P-Time"	①
Indicator	"Indicator"	①②③④
Spectrum Analyzer & Clock	"Speana/Clock"	①②③④
Date	"Date"	①②③④
No display	"Blank"	②③④

In Standby

Information	Display	Condition
Standby	"Standby"	①
Indicator	"Indicator"	①②③④
Clock	"Clock"	①②③④
Date	"Date"	①②③④
No display	"Blank"	②③④

In Auxiliary input source

Information	Display	Condition
Auxiliary input name	"AUX Name"/"AUX EXT"	①
Indicator	"Indicator"	①②③④
Spectrum Analyzer & Clock	"Speana/Clock"	①②③④
Date	"Date"	①②③④
No display	"Blank"	②③④

In DAB source

Information	Display	Condition
Service label	"Service Label"*	①②③④
Dynamic label	"Dynamic Label"*2	①②③④
PTY label	"PTY Label"*2	①②③④
Component label	"Component Label"*	①②③④
Audio quality	"Audio Quality"*2	①②③④
Ensemble label	"Ensemble Label"*	①②③④
Region label	"Region Label"*	①②③④
Received Frequency	"Frequency"	①
Indicator	"Indicator"	①②③④
Spectrum Analyzer & Clock	"Speana/Clock"	①②③④
Date	"Date"	①②③④
No display	"Blank"	②③④

Texts displayed on Display Type C/D in 1-item 4-rowⓈ mode

In Tuner source

Information	Display
Radio text or Program Service name (FM)	"Radio Text"*

In CD & External disc source

Information	Display
Disc title	"Disc Title"*
Track title	"Track Title"*

In Audio file source

Information	Display
Song title & Artist name	"Title/Artist"*
Album name & Artist name	"Album/Artist"*
Folder name	"Folder Name"
File name	"File Name"

In DAB source

Information	Display
Dynamic label	"Dynamic Label"*



- If whole information cannot be displayed within four rows, hold down on [FM] of the Control knob for at least 1 second to display the remaining portion of the information.
- External disc source can be selected when a unit supporting the text display function is connected.

General features

Display Type D

Icon Display Switching

Changing the Icon Display⑥.

1 Show the Multi-function display

Press the [NEXT] button repeatedly until "Display" appears.

Refer to <Notes on Multi-function System> (page 9).

2 Enter display control mode

Turn the [VOL] knob to select "Display".
Press the [VOL] knob.

3 Select the display mode

Turn the [VOL] knob to select "Mode".
Press the [VOL] knob.

4 Select the display Type

Push the Control knob towards [◀◀] or [▶▶].

Select the "Display Type D" display.

5 Enter Icon select mode

Turn the [VOL] knob to select "Side".
Press the [VOL] knob.

6 Switch the Icon display

Push the Control knob towards [◀◀] or [▶▶].

Each time you press the button is pressed, the setting alternates as shown below.

Icon display	Display
Source graphic	"Source"
Text label	"Text"
Play mode label (ACDrive disc)	"Play Mode"
Album art (ACDrive disc)	"Photograph"

7 Exit display control mode

Turn the [VOL] knob to select "Return".
Press the [VOL] knob.



- The Album art display function displays the image attached to the file by Media Manager. This function cannot display the image contained in the play list.
- The Album art display function is not used to display the image corresponding to the tag recorded in the Audio file.
- If Album art display is selected during playback of an ACDrive disc on which no album art is recorded, a source icon is displayed.

- During album art downloading, "Down-loading" is displayed. Downloading requires a maximum of 30 seconds.

Display Type B/ Display Type C/ Display Type D

Font Color Select

Selecting the display font color.

1 Show the Multi-function display

Press the [NEXT] button repeatedly until "Display" appears.

Refer to <Notes on Multi-function System> (page 9).

2 Enter display control mode

Turn the [VOL] knob to select "Display".
Press the [VOL] knob.

3 Select the display mode

Turn the [VOL] knob to select "Mode".
Press the [VOL] knob.

4 Select the display Type

Push the Control knob towards [◀◀] or [▶▶].

Select the "Display Type B"/"Display Type C"/"Display Type D" display.

5 Enter Font Color select mode

Turn the [VOL] knob to select "FontCOL".
Press the [VOL] knob.

6 Select the text display part

Select the Font Color mode
Press the Control knob.

Each time you press the knob, the font color mode is switched between Basic (12 colors) and Detail (115 colors).

The cursor (▶) is displayed in blue. In the Detail mode, it is displayed in red.

Select the row (Display Type C/Display Type D only)

Push the Control knob towards [FM] or [AM].
The cursor (▶) moves to the selected text display part.

Select the Font Color

Push the Control knob towards [◀◀] or [▶▶].

7 Exit display control mode

Turn the [VOL] knob to select "Return".
Press the [VOL] knob.



- When you selected the Display Type B display, select an easy viewable font color.
- The "Indicator" item of Display type C/D can be set; however, the actual display color does not change.
- This function can be set for each display type.

External Display Switching

Changing the display in the connected External Display.

1 Show the Multi-function display

Press the [NEXT] button repeatedly until "Display" appears.

Refer to <Notes on Multi-function System> (page 9).

2 Enter display control mode

Turn the [VOL] knob to select "Display".
Press the [VOL] knob.

3 Enter External display select mode

Turn the [VOL] knob to select "OEMDISP".
Press the [VOL] knob.

"OEM Display Out" is displayed.

4 Select the display

Push the Control knob towards [◀◀] or [▶▶].

5 Exit display control mode

Turn the [VOL] knob to select "Return".
Press the [VOL] knob.

TEL Mute

The audio system automatically mutes when a call comes in.

When a call comes in

"Call" is displayed.

The audio system pauses.

Listening to the audio during a call

Press the [SRC] button.

The "Call" display disappears and the audio system comes back ON.

When the call ends

Hang up the phone.

The "Call" display disappears and the audio system comes back ON.

Tuner features

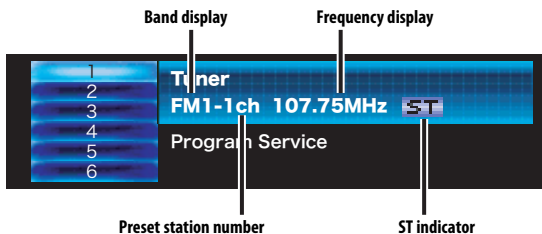
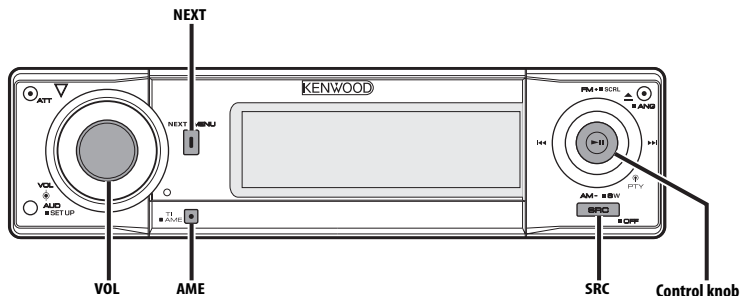

Tuning

Selecting the station.

1 Select tuner source

Press the [SRC] button.

Select the "TUNER" display.

2 Select the band

Push the Control knob towards [FM] or [AM].

Each time you push the knob toward [FM], it switches between the FM1, FM2, and FM3 bands.

3 Tune up or down band

Push the Control knob towards [◀◀] or [▶▶].



- During reception of stereo stations the "ST" indicator is ON.

Function of remote control

Direct Access Tuning

Entering the frequency and tuning.

1 Select the band

Press the [FM] or [AM] button.

2 Enter Direct Access Tuning mode

Press the [DIRECT] button on the remote control.

"- - - -" is displayed.

3 Enter the frequency

Press the number buttons on the remote control.

Example:

Desired frequency	Press button
92.1 MHz (FM)	[0], [9], [2], [1]
810 kHz (AM)	[0], [8], [1], [0]

Canceling Direct Access Tuning

Press the [DIRECT] button on the remote control.

Station Preset Memory

Putting the station in the memory.

1 Select the band

Push the Control knob towards [FM] or [AM].

2 Select the frequency to put in the memory

Push the Control knob towards [◀◀] or [▶▶].

3 Show the Multi-function display

Press the [NEXT] button repeatedly until "1" — "6" appears.

Refer to <Notes on Multi-function System> (page 9).

4 Select a preset number

Turn the [VOL] knob.

5 Put the frequency in the memory

Press the [VOL] knob for at least 2 seconds.

The preset number display blinks 1 time.
On each band, 1 station can be put in the memory on each [1] — [6] number.

Auto Memory Entry

Putting stations with good reception in the memory automatically.

1 Select the band for Auto Memory Entry

Push the Control knob towards [FM] or [AM].

2 Open Auto Memory Entry

Press the [AME] button for at least 2 seconds.

When 6 stations that can be received are put in the memory Auto Memory Entry closes.



- When the <AF (Alternative Frequency)> (page 46) is ON, only RDS stations are put in the memory.
- When Auto Memory Entry is done in the FM2 band, the RDS stations preset in the FM1 band are not put in the memory.
Likewise, when Auto Memory Entry is done in the FM3 band, RDS stations preset in FM1 or FM2 are not put in the memory.

Preset Tuning

Recalling the stations in the memory.

1 Select the band

Push the Control knob towards [FM] or [AM].

2 Show the Multi-function display

Press the [NEXT] button repeatedly until "1" — "6" appears.

Refer to <Notes on Multi-function System> (page 9).

3 Select a preset number

Turn the [VOL] knob.

4 Recall the station

Press the [VOL] knob.

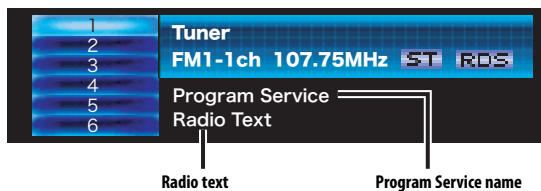
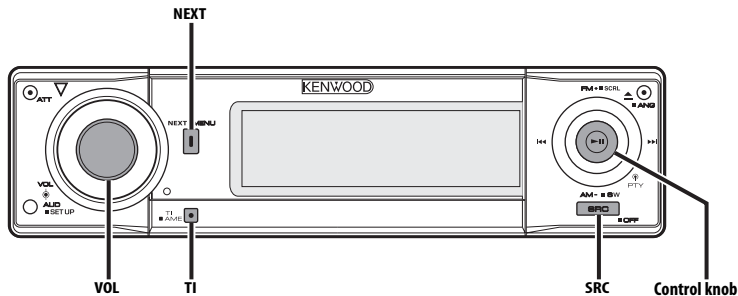

Traffic Information

Changing to traffic information automatically when a traffic bulletin starts even when you are not listening to the radio.

Press the [TI] button.

Each time you press the button, the Traffic information function turns ON and OFF. When traffic information is ON, "Traffic INFO ON" is displayed.

When a traffic bulletin starts, "Traffic INFO" is displayed and the audio changes to traffic information.



- During reception of an AM station when the Traffic Information function is turned ON, the frequency changes to an FM station.
- During reception of traffic information the adjusted volume is automatically remembered, and the next time the audio changes to traffic information, the volume automatically becomes the remembered volume.

Receiving other traffic information stations

Push the Control knob towards [◀◀] or [▶▶].



- Traffic information can be switched when it is on the Tuner Source. However, you cannot switch the Traffic information during reception of the Traffic bulletin switched from the source other than the Tuner.

Radio Text Scroll

Scrolling the displayed radio text.

Hold down on [FM] of the Control knob for at least 1 second.

PTY (Program Type)

Selecting the Program Type and searching for a station.

1 Enter PTY mode

Press the Control knob.

"PTY Select" is displayed.



- This function cannot be used during a traffic bulletin or AM reception.

2 Select the Program Type

Push the Control knob towards [FM] or [AM].

Each time you push the knob, the Program Type alternates between the program types shown in the table below.

No.	Program Type	Display
1.	Speech	"All Speech"
2.	Music	"All Music"
3.	News	"News"
4.	Current Affairs	"Current Affairs"
5.	Information	"Information"
6.	Sport	"Sport"
7.	Education	"Education"
8.	Drama	"Drama"
9.	Culture	"Cultures"
10.	Science	"Science"
11.	Varied	"Varied Speech"
12.	Pop Music	"Pop Music"
13.	Rock Music	"Rock Music"
14.	Easy Listening Music	"Easy Listening M"
15.	Light Classical	"Light Classic M"
16.	Serious Classical	"Serious Classics"
17.	Other Music	"Other Music"
18.	Weather	"Weather & Metr"
19.	Finance	"Finance"
20.	Children's programs	"Children's Prog"
21.	Social Affairs	"Social Affairs"
22.	Religion	"Religion"
23.	Phone In	"Phone In"
24.	Travel	"Travel & Touring"
25.	Leisure	"Leisure & Hobby"
26.	Jazz Music	"Jazz Music"
27.	Country Music	"Country Music"
28.	National Music	"National Music"
29.	Oldies Music	"Oldies Music"
30.	Folk Music	"Folk Music"
31.	Documentary	"Documentary"



- Speech and Music include the Program type shown below.
Music: No.12 — 17, 26 — 30
Speech: No.3 — 11, 18 — 25, 31
- You can put the Program Type in the [1] — [6] number memory and for quick recall. Refer to the <Program Type preset> (page 32).
- You can change the display language. Refer to <Changing Language for PTY Function> (page 32).

3 Search for the selected Program Type station

Push the Control knob towards [◀◀] or [▶▶].

When you want to search for other stations, push [◀◀] or [▶▶] of the Control knob again.



- When the selected Program Type is not found, "No PTY" is displayed. Select another Program Type.

4 Exit PTY mode

Press the Control knob.

Program Type preset

Putting the Program Type in the Preset button memory and quick recall.

Presetting the Program Type

1 Select the Program Type to preset

Refer to <PTY (Program Type)> (page 31).

2 Select a preset number

Turn the [VOL] knob.

3 Preset the Program Type

Press the [VOL] knob for at least 2 seconds.

Recalling the preset Program Type

1 Enter PTY mode

Refer to <PTY (Program Type)> (page 31).

2 Select a preset number

Turn the [VOL] knob.

3 Recall the Program Type

Press the [VOL] knob.

Changing Language for PTY Function

Selecting the Program Type display language.

1 Enter PTY mode

Refer to <PTY (Program Type)> (page 31).

2 Enter Changing Language mode

Press the [TI] button.

3 Select the language

Push the Control knob towards [FM] or [AM].

Each time you push the knob, the language alternates between the languages shown in the table below.

Language	Display
English	"English"
Spanish	"Spanish"
French	"French"
Dutch	"Dutch"
Norwegian	"Norwegian"
Portuguese	"Portuguese"
Swedish	"Swedish"
German	"German"

4 Exit Changing Language mode

Press the [TI] button.

CD/Audio file/External disc control features

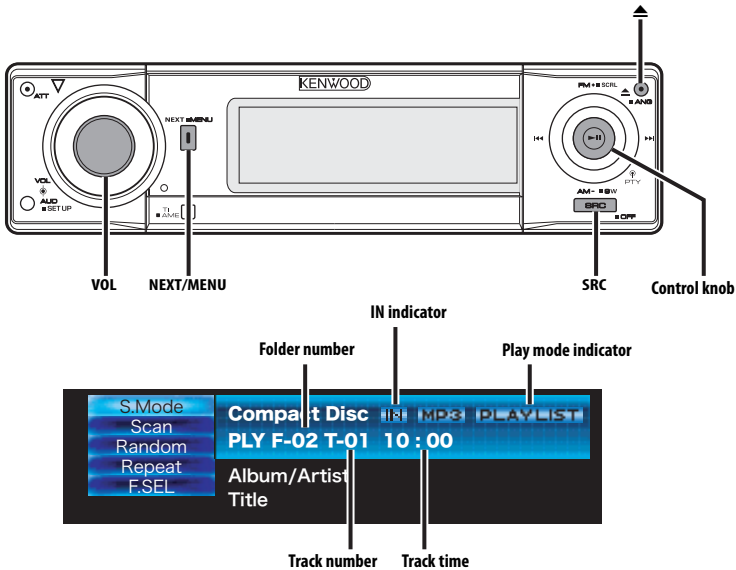

Playing CD & Audio file

When there is no disc inserted

- 1 Open the panel.
Press the [▲] button.
- 2 Insert a disc.



- When the faceplate slides open, it might interfere with the shift lever or other vehicle function. If this happens, pay attention to safety and move the shift lever or take an appropriate action to remove the obstacle, then operate the unit.
- Insert the disc horizontal to the slot. If you insert the Disc as you push down on the Disc, it may scratch the Disc.



- Refer to <About AAC, MP3 and WMA> (page 8) for the Audio file by models you can play.
- You can play the disc (ACDrive disc) made by Media Manager by the same operation.
- You can cancel the announcement when selecting the folder by <Voice Index> (page 49) during the play of the ACDrive.
- When a disc is inserted the "IN" indicator is ON.

- During AAC/MP3/WMA file playback, the AAC, MP3, and WMA indicators are lit.

When a disc is inserted

- 1 Press the [SRC] button.
Select the "Compact Disc" display.

Pause and play

- 1 Press the Control knob
Each time you press the knob, the audio pauses or plays.

Eject the disc

- 1 Eject the disc
Press the [▲] button.
- 2 Return the panel to the original position
Press the [▲] button.

CD/Audio file/External disc control features

Playing External Disc

Playing discs set in the optional accessory disc player connected to this unit.

Press the [SRC] button.

Select the display for the disc player you want.

Display examples:

Display	Disc player
"CD Changer"	CD changer
"MD Changer"	MD changer

Pause and play

Press the Control knob.

Each time you press the knob, the audio pauses or plays.



- The functions that can be used and the information that can be displayed will differ depending on the external disc players being connected.

Fast Forwarding and Reversing

Fast Forwarding

Hold down toward [▶▶] with the Control knob.

Release your finger to play the disc at that point.

Reversing

Hold down toward [◀◀] with the Control knob.

Release your finger to play the disc at that point.



- There is no sound while the Audio file is being searched.
- You cannot fast Forwarding and Reversing depending on AAC file format.

Track/File Search

Searching for a song on the disc or in the Audio file folder.

Push the Control knob towards [◀◀] or [▶▶].

Function of disc changer/ Audio file

Disc Search/Folder Search

Selecting the disc set in the Disc changer or the folder recorded on the Audio file media.

Push the Control knob towards [FM] or [AM].

Function of remote control

Direct Track/File Search

Doing Track/File Search by entering the track/file number.

1 Enter the track/file number

Press the number buttons on the remote control.



- You can select Direct File Search up to 999.

2 Do Track/File Search

Press the [◀◀] or [▶▶] button.

Canceling Direct Track/File Search

Press the [▶II] button.

Function of disc changers with remote control

Direct Disc Search

Doing Disc Search by entering the disc number.

1 Enter the disc number

Press the number buttons on the remote control.

2 Do Disc Search

Press the [+] or [-] button.

Canceling Direct Disc Search

Press the [▶II] button.

Track/File/Disc/Folder Repeat

Replaying the song, disc in the Disc changer or Audio file folder you are listening to.

- 1 Show the Multi-function display**
Press the [NEXT] button repeatedly until "Repeat" appears.

Refer to <Notes on Multi-function System> (page 9).

- 2 Turn ON/OFF the Repeat Play**
Turn the [VOL] knob to select "Repeat".
Press the [VOL] knob.

Each time you press the button, the Repeat Play alternates between the modes shown in the tables below.

In CD & External disc source

Repeat play	Display
Track Repeat	"Repeat ON"/ "Track Repeat ON"
Disc Repeat (In Disc Changer)	"Disc Repeat ON"
OFF	"Repeat OFF"

In Audio file

Repeat play	Display
File Repeat	"File Repeat ON"
Folder Repeat	"Folder Repeat ON"
OFF	"Repeat OFF"

Scan Play

Playing the first part of each song on the disc or Audio file folder you are listening to and searching for the song you want to hear.

- 1 Show the Multi-function display**
Press the [NEXT] button repeatedly until "Scan" appears.

Refer to <Notes on Multi-function System> (page 9).

- 2 Start Scan Play**
Turn the [VOL] knob to select "Scan".
Press the [VOL] knob.

"Scan ON"/"Track Scan ON" is displayed.

- 3 Release the button when the song you want to hear is played**
Press the Control knob.

Random Play

Play all the songs on the disc or Audio file folder in random order.

- 1 Show the Multi-function display**
Press the [NEXT] button repeatedly until "Random" appears.

Refer to <Notes on Multi-function System> (page 9).

- 2 Turn ON/OFF the Random Play**
Turn the [VOL] knob to select "Random".
Press the [VOL] knob.

Each time you press the button, Random Play turns ON or OFF.

When the Random mode is ON, "Random ON" is displayed.



- When you push the Control knob toward [▶▶], the next random song starts.

Function of disc changer

Magazine Random Play

Play the songs on all the discs in the disc changer in random order.

- 1 Show the Multi-function display**
Press the [NEXT] button repeatedly until "M.RDM" appears.

Refer to <Notes on Multi-function System> (page 9).

- 2 Turning ON/OFF the Magazine Random Play**
Turn the [VOL] knob to select "M.RDM".
Press the [VOL] knob.

Each time you press the button, the Magazine Random Play turns ON or OFF.

When the Magazine Random mode is ON, "Magazine Random ON" is displayed.



- When you push the Control knob toward [▶▶], the next random song starts.

CD/Audio file/External disc control features

Function of Audio file

Disc Random Play

Playing randomly from all of the Audio files recorded in the disc.

1 Show the Multi-function display

Press the [NEXT] button repeatedly until "Random" appears.

Refer to <Notes on Multi-function System> (page 9).

2 Turn ON the Disc Random Play

Turn the [VOL] knob to select "Random".
Press the [VOL] knob for at least 1 second.
When the random mode is ON, "Disc Random ON" is displayed.

Cancelling the Disc Random Play

Turn the [VOL] knob to select "Random".
Press the [VOL] knob.



- When you push the Control knob toward [▶▶], the next random song starts.

Function of Audio file

Folder Select

Quickly selecting the folder you want to hear.

1 Show the Multi-function display

Press the [NEXT] button repeatedly until "F.SEL" appears.

Refer to <Notes on Multi-function System> (page 9).



- The Folder Select does not function when <Disc Random Play> (page 36) is ON.

2 Enter Folder Select mode

Turn the [VOL] knob to select "F.SEL".
Press the [VOL] knob.

During Select mode the folder information is displayed as shown below.

Folder number display

Displays the number in the folder belonging to the currently selected folder.



Folder name display

Displays the current folder name.

3 Select the folder level*

Push the Control knob towards [FM] or [AM].

With the [AM] button, you move 1 level down and with the [FM] button, 1 level up.

Selecting a folder in the same level

Push the Control knob towards [◀◀] or [▶▶].

With the [◀◀] of the Control knob, you move to the previous folder, and with the [▶▶] of the Control knob, to the next folder.

Returning to the top level*

Turn the [VOL] knob to select "Home".
Press the [VOL] knob.



- * You cannot operate this function when <Switching the Play mode> (page 37) is set to other than "Folder Mode" while playing ACDrive.

Scrolling the folder name display

Hold down on [FM] of the Control knob for at least 1 second.

4 Decide the folder to play

Turn the [VOL] knob to select "OK".
Press the [VOL] knob.

The Folder Select mode releases, and the Audio file in the folder being displayed plays.

Cancelling the Folder Select mode

Turn the [VOL] knob to select "EXIT".
Press the [VOL] knob.

Function of ACDrive disc

Switching the Play mode

Arrange the playing orders of the songs by categories.

1 Show the Multi-function display

Press the [NEXT] button repeatedly until "S.Mode" appears.

Refer to <Notes on Multi-function System> (page 9).

2 Select the Play mode

Turn the [VOL] knob to select "S.Mode". Press the [VOL] knob.

Each time you press the button, the Play mode alternates between the modes shown on the table below.

The Play mode indicator is ON.

Play mode	Category which is to be arranged
"PlayList Mode"	Play list order.
"Genre Mode"	By genre.
"Artist Mode"	By artist.
"Album Mode"	By album.
"Folder Mode"	By the folder recorded in Disc.



- The category information of each song is the data registered in Media Manager when ACDrive disc is being generated.
- You can cancel the announcement made when the mode is changed by <Voice Index> (page 49).
- You can select the advancement of the Play mode information by [AM] and [FM] keys.

Function of the ACDrive disc

Letter Seek

You can search for the song, you want to play, by selecting the initial of Genre name, Artist name, or Album name.

1 Show the Multi-function display

Press the [NEXT] button repeatedly until "S.Mode" appears.

Refer to <Notes on Multi-function System> (page 9).

2 Enter the Letter Seek mode

Turn the [VOL] knob to select "S.Mode".

Press the [VOL] knob for at least 1 second.



- This operation does not function when <Disc Random Play> (page 36) is ON.
- This function is available only when the Play mode is set Genre, Artist, or Album.

3 Cancelling the Letter Seek

Press the [VOL] knob.

3 Start the Letter Seek

Push the Control knob towards [◀◀] or [▶▶].

The initial of Genre name, Artist name, or Album name is displayed and announced in order.



- The announcement of the initial can be canceled by <Voice Index> (page 49).
- When you push the Control knob to the reverse [◀◀] or [▶▶] during Letter Seek, the initial is displayed and announced in the reversed order.
- Once Letter Seek starts, it cannot be cancelled.

4 Select the song to play

Press the Control knob when the initial of the song you are searching is displayed and announced.

The selected initial group plays.

CD/Audio file/External disc control features

Disc Naming (DNPS)

Attaching a title to a CD.

1 Play the disc you want to attach a name to



- A title cannot be attached to MD or Audio file media.

2 Enter Menu mode

Press the [MENU] button for at least 1 second.

"MENU" is displayed.

3 Select Name set mode

Push the Control knob towards [◀◀] or [▶▶].

Select the "Name Set" display.

4 Enter Name set mode

Press the Control knob for at least 1 second.

5 Move the cursor to the enter character position

Push the Control knob towards [◀◀] or [▶▶].

6 Select the character type

Press the Control knob.

Each time you press the knob, the character type alternates between the types shown in the table below.

Character type	Display
Alphabet upper case	"A-Z"
Alphabet lower case	"a-z"
Numbers and symbols	"1.*"
Special characters (Accent characters)	"è"

7 Select the characters

Push the Control knob towards [FM] or [AM].



- You can enter characters by using a remote control with a number button.

Example: If you are entering "DANCE".

Character	Button	Times pressed
"D"	[3]	1
"A"	[2]	1
"N"	[6]	2
"C"	[2]	3
"E"	[3]	2

8 Repeat steps 5 through 7 and enter the name.

9 Exit Menu mode

Press the [MENU] button.



- When operation stops for 10 seconds after that time is registered, and Menu mode closes.
- Media that you can attach a name to
 - Internal CD player: 10 discs.
 - External CD changer/ player: Varies according to the CD changer/ player. Refer to the CD changer/ player manual.
- You can change the name of a CD by the same operation you used to name it.

Text/Title Scroll

Scrolling the displayed CD text, Audio file text, or MD title.

Push the Control knob toward [FM] for at least 1 second.

DAB tuner control features

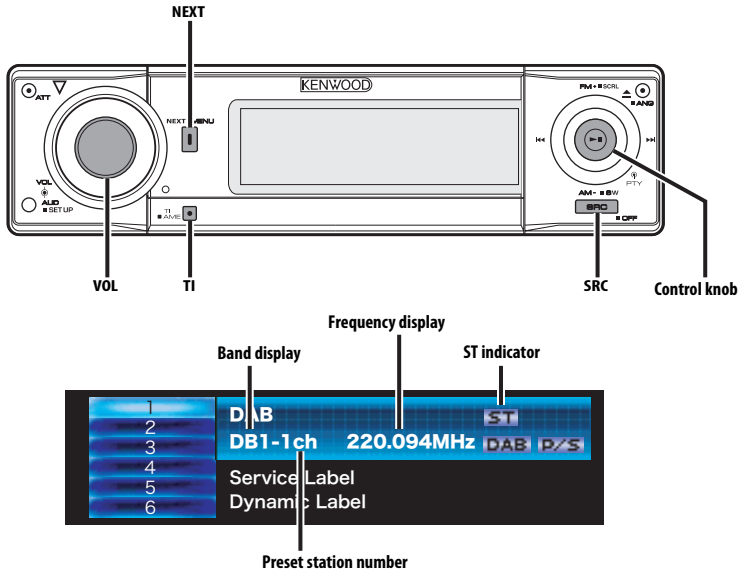

About DAB Tuner control

Refer to **[A]*1*3** group on the Instruction manual of DAB Tuner KTC-9090DAB (optional accessory) for the control method of DAB Tuner function. However, the following control methods of the function for this unit may be differed from the Instruction manual; therefore, refer to the following supplemental instruction.

Service Preset Memory

Recalling the services in the memory.

1 Select the preset band

Push the **Control knob** toward **[FM]**.

Each time you press the button, the preset band switches between DB1, DB2, and DB3.

2 Receive the service to be preset.

3 Show the Multi-function display

Press the **[NEXT]** button repeatedly until "1" — "6" appears.

Refer to <Notes on Multi-function System> (page 9).

4 Select a preset number

Turn the **[VOL]** knob.

5 Put the service in the memory

Press the **[VOL]** knob for at least 2 seconds.

The preset number display blinks 1 time.

On each band, 1 service can be put in the memory on each [1] — [6] number.

Recalling a Preset Service

- 1 Select the preset band**
Push the Control knob toward [FM].
- 2 Show the Multi-function display**
Press the [NEXT] button repeatedly until "1"
— "6" appears.
Refer to <Notes on Multi-function System> (page 9).
- 3 Select a preset number**
Turn the [VOL] knob.
- 4 Recall the service**
Press the [VOL] knob.

Program Type (PTY) Function

This function permits desired program types from within the received Ensemble to be searched and monitored.

- 1 Enter PTY Mode**
Press the Control knob.
"PTY Select" is displayed.

 - This function cannot be used during the interruption of the announcement/ PTY Watch.
- 2 Select the program type**
Push the Control knob towards [FM] or [AM].
Each time you push the knob, the program type changes.
Refer to the instruction manual of DAB tuner for <Program Type Display>.

- 3 Search a service of the selected program type**
Push the Control knob towards [◀◀] or [▶▶].
When you want to search for other service, push [◀◀] or [▶▶] of the Control knob again.



- If the selected program type is not found, the message ("No PTY", etc.) is displayed.
When searching for a service of another program type, repeat procedures 2 and 3.

Switching to Another Service:

Repeat procedure 3.

Another service of the same program type will be searched.

Canceling Search In the Middle:

Press the Control knob.

Searching by program type and language

- 1 Press the button while in program type selection mode.**
Press the [TI] button.
- 2 Selecting a language**
Push the Control knob towards [FM] or [AM].
As for the available languages, refer to the instruction manual of DAB tuner for <Language Filter Search Mode>.
- 3 Searching by the selected program type and language**
Push the Control knob towards [◀◀] or [▶▶].
- 4 Exiting:** Press the [TI] button.

Languages to be displayed

Select English, French, German, Dutch, Spanish, Portuguese, Norwegian or Swedish in <Language Filter Search Mode> to display in the selected language. (Refer to the instruction manual of DAB tuner)

Program Type preset

Putting the Program Type in the Preset memory and quick recall.

Presetting the Program Type

1 Select the Program Type to preset

Refer to <Program Type (PTY) Function> (page 40).

2 Select a preset number

Turn the [VOL] knob.

3 Preset the Program Type

Press the [VOL] knob for at least 2 seconds.

Recalling the preset Program Type

1 Enter PTY mode

Refer to <Program Type (PTY) Function> (page 40).

2 Select a preset number

Turn the [VOL] knob.

3 Recall the Program Type

Press the [VOL] knob.

Menu system

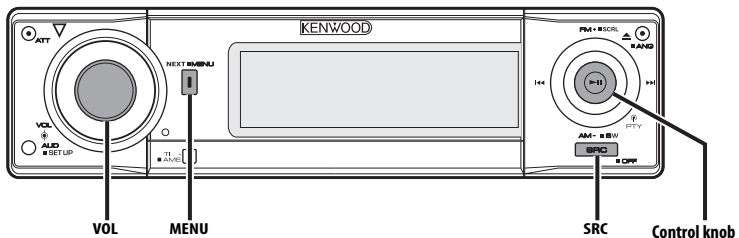

Menu System

Setting beep sound during operation, etc. functions.

The Menu system basic operation method is explained here. The reference for the Menu items and their setting content is after this operation explanation.

1 Enter Menu mode

Press the [MENU] button for at least 1 second.

"MENU" is displayed.

2 Select the menu item

Push the Control knob towards [◀◀] or [▶▶].

Example: When you want to set the beep sound select the "Beep" display.

3 Set the menu item

Push the Control knob towards [FM] or [AM].

Example: When you select "Beep", each time you push the knob it alternates between "Beep: ON" or "Beep: OFF". Select 1 of them as the setting.

You can continue by returning to step 2 and

setting other items.

4 Exit Menu mode

Press the [MENU] button.



- When other items --those applicable to the basic operation method above--are displayed, their setting content chart is entered. (Normally the setting listed at the top of the chart is the original setting.) Also, the explanation for items that are not applicable (<Manual Clock Adjustment> etc.) are entered step by step.

In Standby mode

Security Code

Because authorization by the Security Code is required when the audio unit is removed from the vehicle, personalizing this unit by using the Security Code is helpful in preventing theft.



- Setup Security Code when the <Demonstration mode Setting> (page 49) is set as OFF.

- When you activate the Security Code function, it cannot be released.

Note, your Security Code is the 4 digit number entered in your "Car Audio Passport" in this package.

1 Enter Standby

Press the [SRC] button.

Select the "STANDBY" display.

2 Enter Menu mode

Press the [MENU] button for at least 1 second.

When "MENU" is displayed, "Security" is displayed.

3 Enter Security Code mode

Press the Control knob for at least 1 second.

When "Enter" is displayed, "CODE" is also displayed.

4 Select the digits to enter

Push the Control knob towards [◀◀] or [▶▶].

5 Select the Security Code numbers

Push the Control knob towards [FM] or [AM].

6 Repeat steps 4 and 5, and complete the Security Code.

7 Confirm the Security Code

Press the Control knob for at least 3 seconds.

When "Re-Enter" is displayed, "CODE" is also displayed.

8 Do the step 4 through 7 step operation, and reenter the security code.

"Approved" is displayed.

The Security Code function activates.



- If you enter a Code different from your Security Code, you have to start over from step 4.

9 Exit Security Code mode

Press the [MENU] button.

Press the Reset button when the audio unit is removed from the battery power source

1 Turn the power ON.

2 Do the step 4 through 7 step operation, and reenter the security code.

"Approved" is displayed.

You can begin using the unit.



- If an incorrect code is entered, "Waiting" is displayed, and the input prohibition periods shown in the table below is generated.

After the input prohibition time lapses, "CODE" is displayed, and you can reenter the code.

Number of times the incorrect code was input	Input prohibited time
1	—
2	5 minutes
3	1 hour
4	24 hours

In Standby mode

Touch Sensor Tone

Setting the operation check sound (beep sound) ON/OFF.

Display	Setting
"Beep: ON"	Beep is heard.
"Beep: OFF"	Beep canceled.

In Standby mode

Manual Clock Adjustment



- You can do this adjustment when the <Synchronize Clock> (page 44) is set as OFF.

1 Select Clock Adjustment mode

Push the Control knob towards [◀◀] or [▶▶].

Select the "Clock Adjust" display.

2 Enter Clock Adjust mode

Press the Control knob for at least 1 second.

The clock display blinks.

3 Adjust the hours

Push the Control knob towards [FM] or [AM].

Adjust the minutes

Push the Control knob towards [◀◀] or [▶▶].

4 Exit Clock adjustment mode

Press the [MENU] button.

Menu system

In Standby mode

Date Adjustment

1 Select Date Adjust mode

Push the Control knob towards [◀◀] or [▶▶].

Select the "Date Adjust" display.

2 Enter Date Adjust mode

Press the Control knob for at least 1 second.

The date display blinks.

3 Selecting the item (day, month, or year) to adjust

Push the Control knob towards [◀◀] or [▶▶].

The items that are blinking are items that you can adjust.

4 Adjust each item

Push the Control knob towards [FM] or [AM].

5 Repeat step 3 and 4 operation and adjust the date.

6 Exit Date adjustment mode

Press the [MENU] button.

In Standby mode

Date Mode

Setting the date format.

1 Select Date Mode

Push the Control knob towards [◀◀] or [▶▶].

Select the "Date Mode" display.

2 Select the date format

Push the Control knob towards [FM] or [AM].

3 Exit Menu mode

Press the [MENU] button.

In Standby mode

Synchronize Clock

Synchronizing the RDS station time data and this unit's clock.

Display	Setting
"SYNC: ON"	Synchronizes the time.
"SYNC: OFF"	Adjust the time manually.



- It takes 3 to 4 minutes to synchronize the clock.

In Standby mode

DSI (Disabled System Indicator)

A red indicator will blink on the unit after the faceplate is removed, warning potential thieves.

Display	Setting
"DSI: ON"	LED flashes.
"DSI: OFF"	LED OFF.

In Standby mode

Selectable Illumination

Selecting the button illumination color as green or red.

Display	Setting
"Button: Red"	The illumination color is red.
"Button: Green"	The illumination color is green.



- You can change the illumination color of [EJECT], [NEXT], [TI], and [ATT] buttons.

In Standby mode

Dimmer

Dimming this unit's display automatically when the vehicle light switch is turned ON.

Display	Setting
"Dimmer: ON"	The display dims.
"Dimmer: OFF"	The display doesn't dim.

In Standby mode

Contrast Adjustment

Adjusting the display contrast.

Display and Setting

"Contrast: 1"

⋮

"Contrast: 4" (Original setting)

In Standby mode

Display-reversing Setting

If no operation is performed for a predetermined period of time, switching between negative and positive display modes takes place automatically. Display-reversing maintains the initial brightness of the display for a long period of time.

Display	Setting
"Display N/P: Auto"	Auto reverse display
"Display N/P: POSI"	Positive display only



- Switching between negative and positive display may not take place depending on the displayed mode.

In Standby mode

Built-in Amp Setting

Controlling the built-in amplifier.

Turning OFF this control enhances the preout quality.

Display	Setting
"AMP: ON"	The built-in amplifier activates.
"AMP: OFF"	The built-in amplifier deactivates.

Other than Standby mode/

When the Dual Zone System is ON

Dual Zone System Setting

Setting the Front channel and Rear channel sound in the Dual Zone System.

Display	Setting
"Zone2: Rear"	Sub source (Auxiliary input source) is to be rear channel.
"Zone2: Front"	Sub source (Auxiliary input source) is to be front channel.

Other than Standby mode

B.M.S. (Bass Management System)

Adjust the bass boost level of the external amplifier using the main unit.

Display	Setting
"AMP Bass: Flat"	Bass boost level is flat.
"AMP Bass: +6"	Bass boost level is low (+6dB).
"AMP Bass: +12"	Bass boost level is mid (+12dB).
"AMP Bass: +18"	Bass boost level is high (+18dB).



- Refer to the catalog or instruction manual for power amplifiers that can be controlled from this unit.
- For amplifiers, there are the models you can set from Flat to +18 dB, and the models you can set from Flat to +12 dB.

When an amplifier that can only be set to +12 is connected to the unit, "AMP Bass: +18" will not work correctly even if it is selected.

Other than Standby mode

B.M.S. Frequency Offset

Setting the central frequency, boosted by B.M.S.

Display	Setting
"AMP FREQ: Normal"	Boost with the normal central frequency.
"AMP FREQ: Low"	Drop the normal central frequency 20%.

Menu system

When LX AMP unit connecting

AMP Control

You can control the LX AMP connected to the unit.

1 Select AMP Control mode

Push the Control knob towards [◀◀] or [▶▶].

Select the "AMP Control" display.

2 Enter AMP Control mode

Press the Control knob for at least 1 second.

3 Select the AMP Control item for adjustment

Push the Control knob towards [FM] or [AM].



- For the details on the AMP Control item, see the Instruction manual attached to the LX AMP.

4 Adjust the AMP Control item

Push the Control knob towards [◀◀] or [▶▶].

5 Exit AMP Control mode

Press the [MENU] button.



- You cannot use the LX AMP operation during standby mode.

News Bulletin with Timeout Setting

The tuner automatically changes when a news bulletin starts even if the radio is not being listened to. Also, you can set the time interval when interruption is prohibited.

Display and Setting

"News: OFF"
"News: 00min"
:
"News: 90min"

When you set "News: 00min" — "News: 90min", the News Bulletin Interrupt function is ON.

When the news bulletin starts, "NEWS" is displayed, and the tuner changes to the news bulletin.



- If you choose the "20min" setting, further news bulletins will not be received for 20 minutes once the

first news bulletin is received.

- The news bulletin volume is the same level that was set for <Traffic Information> (page 30).
- This news bulletin function is only available if the desired station sends PTY-code for news bulletin or belongs to <Enhanced Other Network>-Network sending PTY-code for news bulletin.
- When the News Bulletin Interrupt function is ON, the tuner changes to an FM station.

In Tuner mode

Local Seek

Only stations whose reception is good are searched in auto seek tuning.

Display	Setting
"Local.Seek: OFF"	The local seek function is OFF.
"Local.Seek: ON"	The local seek function is ON.

In Tuner mode

Tuning Mode

Sets the tuning mode.

Tuning mode	Display	Operation
Auto seek	"Seek Mode: Auto 1"	Automatic search for a station.
Preset station seek	"Seek Mode: Auto 2"	Search in order of the stations in the Preset memory.
Manual	"Seek Mode: Manual"	Normal manual tuning control.

AF (Alternative Frequency)

When the reception is poor, automatically alternate to another frequency broadcasting the same program in the same RDS network with better reception.

Display	Setting
"AF: ON"	The AF function is ON.
"AF: OFF"	The AF function is OFF.

When the AF function is ON, the "RDS" indicator is ON.



- When no other stations with stronger reception are available for the same program in the RDS network, you may hear the incoming broadcast in bits and snatches. Turn OFF the AF function in such a case.

Restricting RDS Region (Region Restrict Function)

You can choose whether or not to restrict the RDS channels, received with the AF function for a particular network, to a specific region.

Display	Setting
"Regional: ON"	The Region Restrict Function is ON.
"Regional: OFF"	The Region Restrict Function is OFF.



- If AF function is not restricted to the specified region and network, the AF function sets up to search the station with good reception in the same RDS network.

Auto TP Seek

When the TI function is ON and the reception is poor when listening to a traffic information station, another traffic information station with better reception will be searched for automatically.

Display	Setting
"Auto TP Seek: ON"	The Auto TP Seek Function is ON.
"Auto TP Seek: OFF"	The Auto TP Seek Function is OFF.

In FM reception

Monaural Reception

You can reduce the noise when stereo broadcasts are received as monaural.

Display	Setting
"MONO: OFF"	The monaural reception is OFF.
"MONO: ON"	The monaural reception is ON.

Auxiliary Input Display Setting & Disc Naming

Selecting the display when alternating to Auxiliary input source. For the Disc Naming refer to the <Disc Naming (DNPS)> (page 38).

1 Select Auxiliary input source

Press the [SRC] button.

Select the "AUX"/ "AUX EXT" display.

2 Enter Menu mode

Press the [MENU] button for at least 1 second.

"MENU" is displayed.

3 Select Auxiliary input display setting mode

Push the Control knob towards [◀◀] or [▶▶].

Select the "Name Set" display.

4 Enter Auxiliary input display setting mode

Press the Control knob for at least 1 second.

The selected Auxiliary input display is displayed.

5 Select the Auxiliary input display

Push the Control knob towards [◀◀] or [▶▶].

Each time you press the button, the display alternates as listed below.

- "AUX"/ "AUX EXT"
- "DVD"
- "Portable"
- "Game"
- "Video"
- "TV"

6 Exit Menu mode

Press the [MENU] button.



- When operation stops for 10 seconds, the name at that time is registered, and the Menu mode closes.
- The Auxiliary Input Display can be set only when the built-in auxiliary input or the auxiliary input of optional KCA-S210A is used.

Menu system

Text Scroll

Setting the displayed text scroll.

Display	Setting
"Scroll: Manual"	Doesn't scroll.
"Scroll: Auto"	Scrolls when the display changes.



- The text scrolled is listed below.
 - CD text
 - Folder name/ File name/ Song title/ Artist name/ Album name
 - MD title
 - Radio text
 - Dynamic Lable for the DAB tuner source

In Standby mode

Built-in Auxiliary input Setting

Set the Built-in Auxiliary Input function.

Display	Setting
"Built in AUX: OFF"	When selecting the source there's no Auxiliary Input.
"Built in AUX: ON"	When selecting the source there's Auxiliary Input.

In Standby mode

Power OFF Timer

Setting the timer to turn this unit's power OFF automatically when Standby mode continues. Using this setting can save the vehicle's battery power.

Display	Setting
"Power OFF: ----"	Power OFF Timer function is OFF.
"Power OFF: 20min" (Original setting)	Turns the power OFF after 20 minutes.
"Power OFF: 40min"	Turns the power OFF after 40 minutes.
"Power OFF: 60min"	Turns the power OFF after 60 minutes.



- Do this setting after setting <Security Code> (page 42).

In Standby mode

CD Read Setting

When there is a problem with playing a CD with special format, this setting plays the CD by force.

Display	Setting
"CD Read: 1"	Play CD and Audio file.
"CD Read: 2"	Play CD by force.



- Setting "CD Read 2" cannot play Audio file. Some music CDs may not play even in the "CD Read 2" mode.

In Standby mode

Picture downloading

Downloading wallpapers. You can use downloaded pictures for the display of this unit.

1 Inset a CD-R/CD-RW.

Insert a CD-R/CD-RW containing files to be downloaded into this unit.

Refer to <Playing CD & Audio file> (page 33) for details.

Our URL <http://www.kenwood.net-disp.com> describes how to make CD-R/CD-RW.

2 Enter Standby

Press the [SRC] button.

Select the "STANDBY" display.

3 Enter Menu mode

Press the [MENU] button for at least 1 second.

"MENU" is displayed.

4 Select the downloading mode

Push the Control knob towards [◀◀] or [▶▶].

Select the "DISP Data Download" display.

5 Enter the downloading mode

Press the Control knob for at least 1 second.

"File Check!!" is displayed.

6 Select files to be downloaded

Push the Control knob towards [◀◀] or [▶▶].

7 Start downloading

Press the Control knob for at least 1 second.

"Downloading" is displayed.

When the downloading finishes, "Finished Download" is displayed.



- Picture downloading may take as long as 20 minutes.
Quantity Gradation Level



Canceling Downloading

Press the [MENU] button.

8 Exit the downloading mode

Press the [MENU] button.



- Do not operate this unit, while "Downloading" is displayed to prevent data from being damaged.
- The number of files that can be downloaded.
- Wallpaper: 1 file
- When a new wallpaper is downloaded, it will overwrite the currently downloaded wallpaper. There is no way to delete the downloaded pictures.
- The downloaded pictures can be used for display.
<Graphic part/ Spectrum Analyzer Display Switching> (page 18)
<Wallpaper selecting> (page 19)
- When you cannot download the pictures to this unit, there may be a problem with the CD-R/CD-RW write method.
Refer to the URL <http://www.kenwood.net-disp.com>, and rewrite the CD-R/CD-RW.

Function of ACDrive disc

Voice Index

Setting the announcement during the play of ACDrive disc.

Display	Setting
"Voice Index: ON"	Guide is announced.
"Voice Index: OFF"	Not be announced.

In CD mode

ACDrive firmware version display

Displaying the firmware version with the ACDrive function.

1 Select the firmware version display mode

Push the Control knob towards [◀◀] or [▶▶].

Select the "ACD F/W Version" display.

2 Display the ACDrive firmware version

Push the Control knob towards [FM] or [AM].

In CD mode

Unique ID display

Displaying the serial number for each product.

1 Select the unique ID display mode

Push the Control knob towards [◀◀] or [▶▶].

Select the "ACD Unique ID" display.

2 Display the unique ID

Push the Control knob towards [FM] or [AM].

In Standby mode

Demonstration mode Setting

Sets the demonstration mode.

1 Select the Demonstration mode

Push the Control knob towards [◀◀] or [▶▶].

Select the "DEMO Mode" display.

2 Set the Demonstration mode

Press the Control knob for at least 2 seconds.

Each time you press the knob at least 2 seconds, the Demonstration mode alternates between the settings shown in the table below.

Display	Setting
"DEMO Mode: ON"	The Demonstration mode function is ON.
"DEMO Mode: OFF"	Exit Demonstration mode (Normal mode).

Menu system

In DAB mode

Menu Added for DAB

When you connect the DAB tuner, the following menu is displayed:

Display	Feature
"Seek Mode:"	Selecting DAB Seek Mode
"Priority DAB:"	Automatic Switching DAB priority
"DRC:"	Dynamic Range Control (DRC)
"Regional ASW:"	Regional Announcement Function
"ASW Select"	Announcement select mode
"PTY Watch"	PTY Watch Select Mode
"Language Search"	Language Filter Search Mode



- For details on menu items, refer to the instruction manual of the DAB tuner.

Basic Operations of remote control

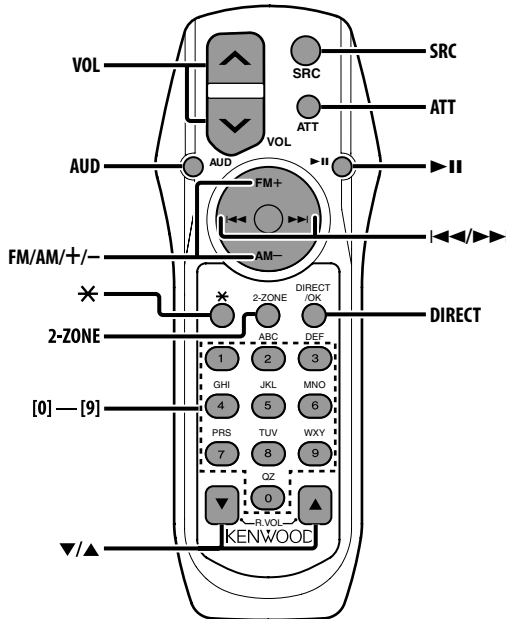

Loading and Replacing the battery

Use two "AA"-size batteries.

Slide the cover while pressing downwards to remove it as illustrated.

Insert the batteries with the + and - poles aligned properly, following the illustration inside the case.

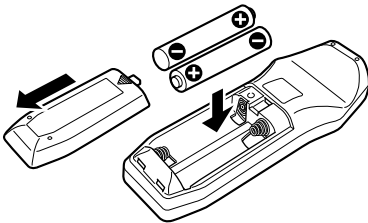

⚠ WARNING

- Store unused batteries out of the reach of children. Contact a doctor immediately if the battery is accidentally swallowed.



- Do not set the remote control in hot places such as above the dashboard.

Basic operations

[VOL] buttons

Adjusts the volume.

[SRC] button

Each time you press the button, the source alternates.

For the source alternating order refer to <Selecting the Source> (page 10).

[ATT] button

Turns the volume down quickly.

When the button is pressed again, the volume returns to the previous level.

[*] button

Adjusts the Faceplate Angle.

Basic Operations of remote control

Audio Control

[AUD] button

Selects the Audio item to be adjusted.

[VOL] buttons

Adjusts the Audio item.



- Refer to <Audio Control> (page 11) for the operation method, such as the procedures for Audio control and others operations.
- The remote control can only select and adjust the Basic Audio item. Selecting and adjusting of the Detail Audio item cannot be done.

Dual Zone System

[2-ZONE] button

Each time you press the button, "2ZONE" of <Audio Setup> (page 11) is turned ON or OFF.

[▲]/ [▼] buttons

Adjusts the volume of the rear channel.
The rear channel activates while the Dual Zone System is ON.

In Tuner source

[FM]/ [AM] buttons

Selects the band.
Each time you press the [FM] button, the band alternates between the FM1, FM2, and FM3 bands.

[◀◀]/ [▶▶] buttons

Tune up or down band.

[0] — [9] buttons

Press buttons [1] — [6] to recall preset stations.

[DIRECT] button

Enters and cancels the <Direct Access Tuning> (page 28) mode.

[▶II] button

Enters and cancels the <PTY (Program Type)> (page 31) mode.

In Disc source

[◀◀]/ [▶▶] buttons

Going forwards and backwards between track/ files.

[+]/ [-] buttons

Going forwards and backwards between disc/ folders.

[▶II] button

Each time you press the button, the song pauses or plays.

[0] — [9] buttons

When in <Direct Track/File Search> (page 34) and <Direct Disc Search> (page 34), enters the track/ file/disc number.

In DAB source

[FM] button

Preset Band Switching.
Each press of the [FM] button switches one step among the DB1, DB2, and DB3 bands.

[AM] button

Primary/Secondary Switching.
Each press of the [AM] button switches between Primary/secondary within the services.

[◀◀]/ [▶▶] buttons

Service Switching.
Each press of the button switches the services from within the Ensemble.

Switching the ensemble.

Each time the button is pressed and held for longer than 1 seconds, the Ensemble changes.

[0] — [9] buttons

Press buttons [1] — [6] to recall preset services.

Accessories/ Installation Procedure

Accessories

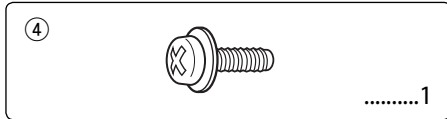
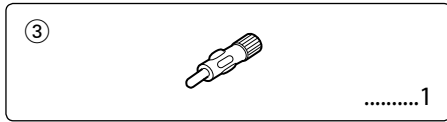
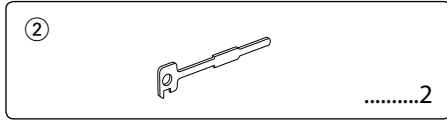
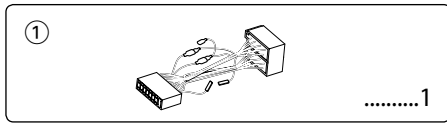

Installation Procedure

1. To prevent short circuits, remove the key from the ignition and disconnect the ⊖ terminal of the battery.
2. Connect the proper input and output wire to each unit.
3. Connect the wire on the wiring harness.
4. Take Connector B on the wiring harness and connect it to the speaker connector in your vehicle.
5. Take Connector A on the wiring harness and connect it to the external power connector on your vehicle.
6. Connect the wiring harness connector to the unit.
7. Install the unit in your car.
8. Reconnect the ⊖ terminal of the battery.
9. Press the reset button.



- If the power is not turned ON (or it is ON, but will be OFF immediately), the speaker wire may have a short-circuit or touched the chassis of the vehicle and the protection function may have been activated. Therefore, check the speaker wire.
- If your car is not prepared for this special connection-system, consult your Kenwood dealer.
- Only use antenna conversion adapters (ISO-JASO) when the antenna cord has an ISO plug.
- Make sure that all wire connections are securely made by inserting jacks until they lock completely.
- If your vehicle's ignition does not have an ACC position, or if the ignition wire is connected to a power source with constant voltage such as a battery wire, the power will not be linked with the ignition (i.e., it will not turn on and off along with the ignition). If you want to link the unit's power with the ignition, connect the ignition wire to a power source that can be turned on and off with the ignition key.
- If the fuse blows, first make sure that the wires have not caused a short circuit, then replace the old fuse with one with the same rating.
- Insulate unconnected wires with vinyl tape or other similar material. To prevent short circuits, also do not remove the caps on the ends of the unconnected wires or the terminals.
- Connect the speaker wires correctly to the terminals to which they correspond. The unit may receive damage or fail to work if you share the ⊖ wires and/or ground them to any metal part in the car.
- After the unit is installed, check whether the brake lamps, indicators, wipers, etc. on the car are working properly.
- If the console has a lid, make sure to install the unit so that the faceplate does not hit the lid when closing and opening.
- Mount the unit so that the mounting angle is 30° or less.

Connecting Wires to Terminals

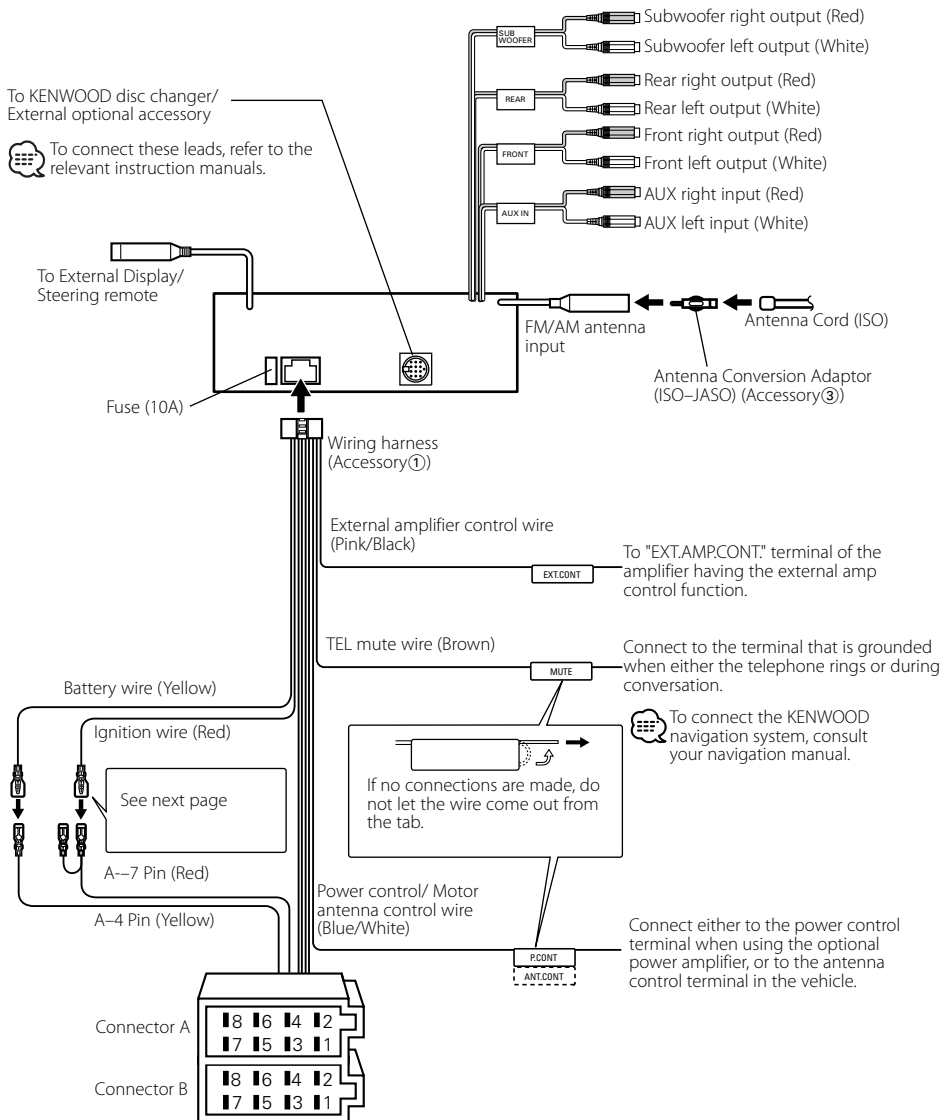

Connector Function Guide

Pin Numbers for ISO Connectors	Cable Colour	Functions
External Power Connector		
A-4	Yellow	Battery
A-5	Blue/White	Power Control
A-6	Orange/White	Dimmer
A-7	Red	Ignition (ACC)
A-8	Black	Earth (Ground) Connection
Speaker Connector		
B-1	Purple	Rear Right (+)
B-2	Purple/Black	Rear Right (-)
B-3	Gray	Front Right (+)
B-4	Gray/Black	Front Right (-)
B-5	White	Front Left (+)
B-6	White/Black	Front Left (-)
B-7	Green	Rear Left (+)
B-8	Green/Black	Rear Left (-)

⚠WARNING

Connecting the ISO Connector

The pin arrangement for the ISO connectors depends on the type of vehicle you drive. Make sure to make the proper connections to prevent damage to the unit. The default connection for the wiring harness is described in [1] below. If the ISO connector pins are set as described in [2] or [3], make the connection as illustrated. Please be sure to reconnect the cable as shown [2] below to install this unit to the **Volkswagen** vehicles etc.

- [1] (Default setting) The A-7 pin (red) of the vehicle's ISO connector is linked with the ignition, and the A-4 pin (yellow) is connected to the constant power supply.

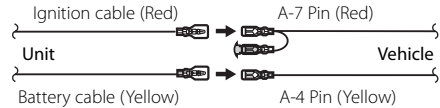

- [2] The A-7 pin (red) of the vehicle's ISO connector is connected to the constant power supply, and the A-4 pin (yellow) is linked to the ignition.

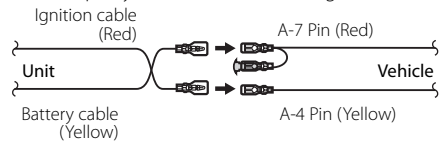

- [3] The A-4 pin (yellow) of the vehicle's ISO connector is not connected to anything, while the A-7 pin (red) is connected to the constant power supply (or both the A-7 (red) and A-4 (yellow) pins are connected to the constant power supply).

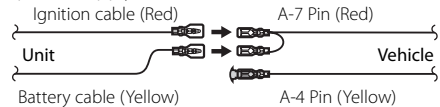

- When the connection is made as in [3] above, the unit's power will not be linked to the ignition key. For that reason, always make sure to turn off the unit's power when the ignition is turned off. To link the unit's power to the ignition, connect the ignition cable (ACC...red) to a power source that can be turned on and off with the ignition key.

Installation

Installation

Metal mounting strap
(commercially available)

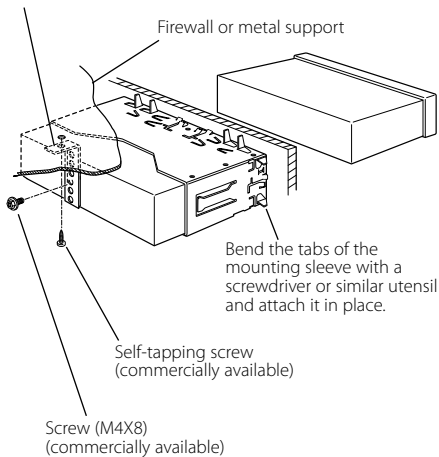

- Make sure that the unit is installed securely in place. If the unit is unstable, it may malfunction (for example, the sound may skip).

Screwing the Faceplate on the Unit

If you want to fasten the faceplate to the main unit so that it does not fall off, screw in the provided screws in the holes shown below.

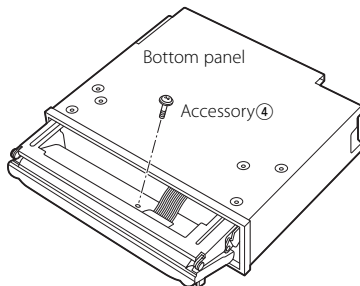

- Never insert the screw in any other screw hole than the one specified. If you screw them in another hole, it will contact and may cause damage to the mechanical parts inside the unit.

Removing the Unit

Removing the hard rubber frame

- 1 Engage the catch pins on the removal tool and remove the two locks on the upper level. Upper the frame and pull it forward as shown in the figure.

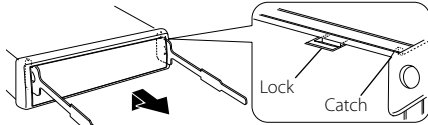

Accessory②
Removal tool

- 2 When the upper level is removed, remove the lower two locations.

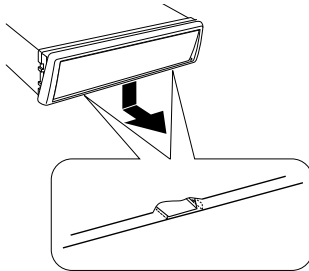

- The frame can be removed from the bottom side in the same manner.

Removing the Unit

- 1 Refer to the section <Removing the hard rubber frame> (page 57) and then remove the hard rubber frame.
- 2 Remove the screw (M4 × 8) on the back panel.
- 3 Insert the two removal tools deeply into the slots on each side, as shown.

Screw (M4X8)
(commercially available)

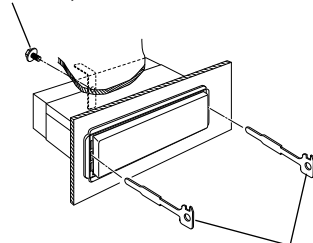

Accessory②
Removal tool

- 4 Lower the removal tool toward the bottom, and pull out the unit halfway while pressing towards the inside.

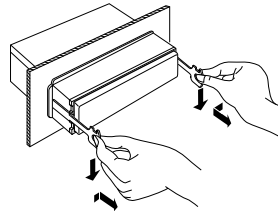

- Be careful to avoid injury from the catch pins on the removal tool.

- 5 Pull the unit all the way out with your hands, being careful not to drop it.

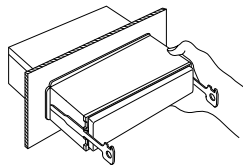

Troubleshooting Guide

What may seem to be a malfunction in your unit may just be the result of slight misoperation or miswiring. Before calling service, first check the following table for possible problems.

General

? The power does not turn ON.

- ✓ The fuse has blown.
 - ☞ After checking for short circuits in the wires, replace the fuse with a new one with the same rating.
- ✓ The speaker wire has a short-circuit or touches the chassis of the vehicle, and the protection function is activated.
 - ☞ Wire or insulate the speaker cable properly and press the reset button.

? There is a source you cannot change.

- ✓ There is no media inserted.
 - ☞ Set the media you want to hear. If there is no media in this unit, you cannot change to each source.
- ✓ The Disc changer is not connected.
 - ☞ Connect the Disc changer. If the Disc changer is not connected to its input terminal, You cannot change to an external disc source.

? The memory is erased when the ignition is turned OFF.

- ✓ The ignition and battery wire are incorrectly connected.
 - ☞ Connect the wire correctly, referring to the section on <Connecting Wires to Terminals>.

? The TEL mute function does not work.

- ✓ The TEL mute wire is not connected properly.
 - ☞ Connect the wire correctly, referring to the section on <Connecting Wires to Terminals>.

? The TEL mute function turns ON even though the TEL mute wire is not connected.

- ✓ The TEL mute wire is touching a metal part of the car.
 - ☞ Pull the TEL mute wire away from the metal part of the car.

? No sound can be heard, or the volume is low.

- ✓ The fader or balance settings are set all the way to one side.
 - ☞ Center the fader and balance settings.
- ✓ The input/output wires or wiring harness are connected incorrectly.
 - ☞ Reconnect the input/output wires or the wiring harness correctly. See the section on <Connecting Wires to Terminals>.
- ✓ The values of Volume offset are low.
 - ☞ Turn up the Volume offset, referring to the section on <Audio Control> (page 11).
- ✓ The <Built-in Amp Setting> (page 45) is OFF.
 - ☞ Turn it ON.

? The sound quality is poor or distorted.

- ✓ One of the speaker wires is being pinched by a screw in the car.
 - ☞ Check the speaker wiring.
- ✓ The speakers are not wired correctly.
 - ☞ Reconnect the speaker wires so that each output terminal is connected to a different speaker.

? The Touch Sensor Tone does not sound.

- ✓ The preout jack is being used.
 - ☞ The Touch Sensor Tone cannot be output from the preout jack.

? Even though Synchronize Clock is ON, the clock cannot be adjusted.

- ✓ The received RDS station is not sending time data.
 - ☞ Receive another RDS station.

? The Dimmer function does not work.

- ✓ The Dimmer wire is not connected correctly.
 - ☞ Check the Dimmer wire connection.
- ✓ The <Dimmer> (page 44) is OFF.
 - ☞ Turn it ON.

? The sound is not output from Subwoofer or it outputs a different sound.

- ✓ When "2ZONE" of <Audio Setup> (page 11) is set to ON.
 - ☞ Turn OFF "2ZONE" of <Audio Setup>.

? There are no audio control effects.

- ✓ FOCUS/ SRS 3D item on <WOW Control> (page 15) have no effect in rear output.
 - ☞ ---

? Switching between negative and positive display modes takes place automatically.

- ✓ Switching between negative and positive display modes takes place automatically to maintain the initial brightness of the display for a long period of time.
 - ☞ You can select "Display N/P: POSI" as mentioned in <Display-reversing Setting> (page 45).

Tuner source

? Radio reception is poor.

- ✓ The car antenna is not extended.
 - ⓘ Pull the antenna out all the way.
- ✓ The antenna control wire is not connected.
 - ⓘ Connect the wire correctly, referring to the section on <Connecting Wires to Terminals>.

? The desired frequency cannot be entered with the Direct Access Tuning.

- ✓ A station that cannot be received is being entered.
 - ⓘ Enter a station that can be received.
- ✓ You are trying to enter a frequency with a 0.01 MHz unit.
 - ⓘ The FM band is designated to 0.1 MHz.

? The volume is not the set Traffic information sound volume.

- ✓ The set sound volume is less than the tuner sound volume.
 - ⓘ If the tuner sound volume is louder than the set sound volume, the tuner sound volume is used.

Disc source

? "AUX EXT" is displayed without achieving External disc control mode.

- ✓ Unsupported disc changer is connected.
 - ⓘ Use the disc changer mentioned in the <About CD players/disc changers connected to this unit> (page 4) of the section on <Safety precautions>.

? The specified disc does not play, but another one plays instead.

- ✓ The specified CD is quite dirty.
 - ⓘ Clean the CD.
- ✓ The disc is loaded in a different slot from that specified.
 - ⓘ Eject the disc magazine and check the number for the specified disc.
- ✓ The disc is severely scratched.
 - ⓘ Try another disc instead.

? A CD ejects as soon as it is loaded.

- ✓ The CD is quite dirty.
 - ⓘ Clean the CD, referring to the CD cleaning of the section on <About CDs> (page 7).

? Can't remove disc.

- ✓ The cause is that more than 10 minutes has elapsed since the vehicle ACC switch was turned OFF.
 - ⓘ The disc can only be removed within 10 minutes of the ACC switch being turned OFF. If more than 10 minutes has elapsed, turn the ACC switch ON again and press the Eject button.

? The disc will not insert.

- ✓ There is already another disc inserted.
 - ⓘ Press the [▲] button and remove the disc.

? Direct Search cannot be done.

- ✓ Another function is ON.
 - ⓘ Turn Random Play or other functions OFF.

? Track Search cannot be done.

- ✓ For the discs first or last song.
 - ⓘ For each disc, Track Search cannot be done in the backward direction for the first song or in the forward direction for the last song.

Audio file source

? Cannot play an Audio file.

- ✓ The media is scratched or dirty.
 - ⓘ Clean the media, referring to the CD cleaning of the section on <About CDs> (page 7).

? The sound skips when an Audio file is being played.

- ✓ The media is scratched or dirty.
 - ⓘ Clean the media, referring to the CD cleaning of the section on <About CDs> (page 7).
- ✓ The recording condition is bad.
 - ⓘ Record the media again or use another media.

? The Audio file track time is not displayed correctly.

- ✓ ---
 - ⓘ There are times when the track time is not displayed correctly according to the Audio file recording conditions.

Troubleshooting Guide

The messages shown below display your systems condition.

Eject:	No disc magazine has been loaded in the changer. The disc magazine is not completely loaded. ⇨ Load the disc magazine properly. ⇨ No CD in the unit. ⇨ Insert the CD.	Waiting:	<ul style="list-style-type: none">• Receiving radio text data.• Text for the DAB tuner source is being received.
No Disc:	No disc has been loaded in the disc magazine. ⇨ Load a disc into the disc magazine.	Load:	Exchanging discs in the Disc changer.
TOC Error:	No disc has been loaded in the disc magazine. ⇨ Load a disc into the disc magazine. The CD is quite dirty. The CD is upside-down. The CD is very scratched. ⇨ Clean the CD and load it correctly.	Reading:	Reading the data on the disc.
Error 05:	The CD is upside-down. ⇨ Load the CD correctly.	IN (Blink):	The CD player section is not operating properly. ⇨ Reinsert the CD. If the CD cannot be ejected or the display continues to flash even when the CD has been properly reinserted, please switch off the power and consult your nearest service center.
Blank Disc:	Nothing has been recorded on the MD.	Unsupported File:	An Audio file with a format that this unit cannot support is playing. ⇨ ----
No Track Disc:	No tracks are recorded on the MD, although it has a title.	Copy Protection:	A copy-protected file is playing. ⇨ ----
Error 15:	Media was played that does not have data recorded that the unit can play. ⇨ Use media that has data recorded that the unit can play.	Can't Download:	
No Panel:	The faceplate of the slave unit being connected to this unit has been removed. ⇨ Replace it.	Download Error:	This unit does not work properly for some reason. ⇨ Press the reset button to download it again. If this error is still displayed, consult a local Kenwood dealer.
Error 77:	The unit is malfunctioning for some reason. ⇨ Press the reset button on the unit. If the "Error 77" code does not disappear, consult your nearest service center.	No Display File:	No file that can be downloaded is contained in the CD-ROM. ⇨ Make sure that a files created with referring to < http://www.kenwood.net-disp.com > is contained in the CD-ROM. Do not delete the extension (.kbn) created when the file was created.
Mecha Error:	Something is wrong with the disc magazine. Or the unit is malfunctioning for some reason. ⇨ Check the disc magazine. And then press the reset button on the unit. If the "Mecha Error" code does not disappear, consult your nearest service center.	Incorrect File:	The file selected to be downloaded has a format that this unit cannot read. ⇨ Recreate the file.
Hold Error:	The protective circuit in the unit activates when the temperature inside the automatic disc changer exceeds 60°C (140°F), stopping all operation. ⇨ Cool down the unit by opening the windows or turning on the air conditioner. As the temperature falls below 60°C (140°F), the disc will start playing again.	Writing Error:	Writing failed while the file was downloaded. ⇨ Try the downloading again.
		DEMO MODE:	The Demonstration mode has been selected. ⇨ The <Demonstration mode Setting> (page 49) is ON. Turn it OFF.

Specifications

Specifications subject to change without notice.

FM tuner section

- Frequency range (50 kHz space)
 - : 87.5 MHz – 108.0 MHz
- Usable sensitivity (S/N = 26dB)
 - : 0.7 μ V/75 Ω
- Quieting Sensitivity (S/N = 46dB)
 - : 1.6 μ V/75 Ω
- Frequency response (\pm 3.0 dB)
 - : 30 Hz – 15 kHz
- Signal to Noise ratio (MONO)
 - : 65 dB
- Selectivity (DIN) (\pm 400 kHz)
 - : \geq 80 dB
- Stereo separation (1 kHz)
 - : 35 dB

MW tuner section

- Frequency range (9 kHz space)
 - : 531 kHz – 1611 kHz
- Usable sensitivity (S/N = 20dB)
 - : 25 μ V

LW tuner section

- Frequency range
 - : 153 kHz – 281 kHz
- Usable sensitivity (S/N = 20dB)
 - : 45 μ V

CD player section

- Laser diode
 - : GaAlAs
- Digital filter (D/A)
 - : 8 Times Over Sampling
- D/A Converter
 - : 1 Bit
- Spindle speed (Audio file)
 - : 1000 – 400 rpm (CLV 2times)
- Wow & Flutter
 - : Below Measurable Limit
- Frequency response (\pm 1 dB)
 - : 10 Hz – 20 kHz
- Total harmonic distortion (1 kHz)
 - : 0.008 %
- Signal to Noise ratio (1 kHz)
 - : 110 dB
- Dynamic range
 - : 93 dB
- Channel separation
 - : 96 dB

- MP3 decode
 - : Compliant with MPEG-1/2 Audio Layer-3
- WMA decode
 - : Compliant with Windows Media Audio
- AAC decode
 - : AAC-LC ".m4a" files

Audio section

- Maximum output power
 - : 50 W x 4
- Output power (DIN 45324, +B=14.4V)
 - : 30 W x 4
- Tone action
 - Band1: 60 – 200 Hz \pm 9 dB
 - Band2: 250 – 1k Hz \pm 9 dB
 - Band3: 1.25k – 4k Hz \pm 9 dB
 - Band4: 5k – 16k Hz \pm 9 dB
- Preout level / Load (during disc play)
 - : 5000 mV/10 k Ω
- Preout impedance
 - : \leq 80 Ω

Auxiliary input

- Frequency response (\pm 1 dB)
 - : 20 Hz – 20 kHz
- Input Maximum Voltage
 - : 1200 mV
- Input Impedance
 - : 100 k Ω

General

- Operating voltage (11 – 16V allowable)
 - : 14.4 V
- Current consumption
 - : 10 A
- Installation Size (W x H x D)
 - : 182 x 53 x 155 mm
- Weight
 - : 1.65 kg

KENWOOD

Free Manuals Download Website

<http://myh66.com>

<http://usermanuals.us>

<http://www.somanuals.com>

<http://www.4manuals.cc>

<http://www.manual-lib.com>

<http://www.404manual.com>

<http://www.luxmanual.com>

<http://aubethermostatmanual.com>

Golf course search by state

<http://golfingnear.com>

Email search by domain

<http://emailbydomain.com>

Auto manuals search

<http://auto.somanuals.com>

TV manuals search

<http://tv.somanuals.com>