

KENWOOD

DDX7015BT
DDX5015DAB

DDX5015BT
DDX5015BTR

MONITOR WITH DVD RECEIVER
INSTRUCTION MANUAL

JVCKENWOOD Corporation



PERSONAL RADIO

CONTENTS

BEFORE USE	2	BLUETOOTH	35
How to reset your unit.....	3	SETTINGS	43
INITIAL SETTINGS	4	Settings for using applications of iPod/iPhone/ Android.....	43
BASICS	6	Sound adjustment	44
Component names and functions	6	Adjustment for video playback.....	46
Common operations.....	7	Changing the display design.....	48
Common screen operations.....	8	Customizing the <TOP MENU> screen	49
Selecting the playback source.....	10	Customizing the system settings.....	49
DISCS	11	Setting menu items.....	51
USB	16	REMOTE CONTROLLER	54
iPod/iPhone	17	CONNECTION/INSTALLATION	56
APPS	21	REFERENCES	62
AUPEO!	22	Maintenance	62
TUNER	24	More information	62
DIGITAL RADIO (DAB) (Only for DDX5015DAB)	27	Error message list	66
OTHER EXTERNAL COMPONENTS	31	Troubleshooting.....	66
Using external audio/video players—AV-IN	31	Specifications.....	69
Using a rear view camera	31		
Using a smartphone—HDMI/MHL.....	33		
Watching a TV.....	33		
Using the external navigation unit (Only for DDX7015BT/DDX5015DAB/DDX5015BT).....	34		

How to read this manual:

- Illustrations of DDX7015BT are mainly used for explanation. The displays and panels shown in this manual are examples used to provide clear explanations of the operations. For this reason, they may be different from the actual displays or panels.
- This manual mainly explains operations using the buttons on the monitor panel and touch panel. For operations using the remote controller (KNA-RCDV331: separately purchased), see page 54.
- < > indicates the various screens/menus/operations/settings that appear on the touch panel.
- [] indicates the buttons on the touch panel.
- **Indication language:** English indications are used for the purpose of explanation. You can select the indication language from the <Setup> menu. (Page 53)
- Updated information (the latest Instruction Manual, system updates, new functions, etc.) is available from <<http://www.kenwood.com/cs/ce/>>.

BEFORE USE

IMPORTANT

To ensure proper use, please read through this manual before using this product. It is especially important that you read and observe WARNINGS and CAUTIONS in this manual. Please keep the manual in a safe and accessible place for future reference.

⚠ **WARNINGS: (To prevent accidents and damage)**

- DO NOT install any unit or wire any cable in a location where;
 - it may obstruct the steering wheel and gearshift lever operations.
 - it may obstruct the operation of safety devices such as air bags.
 - it may obstruct visibility.
- DO NOT operate the unit while driving. If you need to operate the unit while driving, be sure to look around carefully.
- The driver must not watch the monitor while driving.

The marking of products using lasers

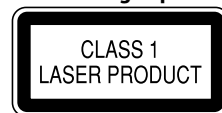

The label is attached to the chassis/case and says that the component uses laser beams that have been classified as Class 1. It means that the unit is utilizing laser beams that are of a weaker class. There is no danger of hazardous radiation outside the unit.

BEFORE USE

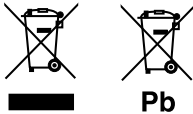

Information on Disposal of Old Electrical and Electronic Equipment and Batteries (applicable for countries that have adopted separate waste collection systems)

Products and batteries with the symbol (crossed-out wheeled bin) cannot be disposed as household waste.

Old electrical and electronic equipment and batteries should be recycled at a facility capable of handling these items and their waste byproducts. Contact your local authority for details in locating a recycle facility nearest to you.

Proper recycling and waste disposal will help conserve resources whilst preventing detrimental effects on our health and the environment.

Notice: The sign "Pb" below the symbol for batteries indicates that this battery contains lead.

For Israel

מידע בדבר השלכה לאשפה של ציוד חשמלי ואלקטרוני ישן וכן סוללות (רלוונטי למדינות שמשמשות במערכת איסוף אשפה מופרדת).

לא ניתן להשליך מוצרים וסוללות עם הסימון (פח אשפה עם X עליו) כאשפה ביתית רגילה. יש למחזר ציוד חשמלי ואלקטרוני ישן וכן סוללות במתקן המסוגל לטפל בפריטים כאלה ובתוצרי הלוואי שלהם.

צרו קשר עם הרשות המקומית לקבלת פרטים אודות מתקן המיחזור הקרוב אליכם. מיחזור והשלכה לאשפה נאותים יעזרו לשמר משאבים ולמנוע השפעות שליליות על בריאותנו ועל הסביבה.

שימו לב: הסימון Pb שמתחת לסימון עבור סוללות מצייין שהסוללה מכילה עופרת.

⚠ Cautions on the monitor:

- The monitor built into this unit has been produced with high precision, but it may have some ineffective dots. This is inevitable and is not considered defective.
- Do not expose the monitor to direct sunlight.
- Do not operate the touch panel using a ball-point pen or similar tool with a sharp tip. Touch the buttons on the touch panel with your finger directly (if you are wearing a glove, take it off).
- When the temperature is very cold or very hot...
 - Chemical changes occur inside, causing malfunction.
 - Pictures may not appear clearly or may move slowly. Pictures may not be synchronized with the sound or picture quality may decline in such environments.

For safety...

- Do not raise the volume level too much, as this will make driving dangerous by blocking outside sounds, and may cause hearing loss.
- Stop the car before performing any complicated operations.

Temperature inside the car...

If you have parked the car for a long time in hot or cold weather, wait until the temperature in the car becomes normal before operating the unit.

🔧 How to reset your unit

If the unit fails to operate properly, press the reset button.

DDX7015BT



DDX5015DAB/DDX5015BT/DDX5015BTR



INITIAL SETTINGS

Initial setup

When you power on the unit for the first time or reset the unit, the initial setting screen appears.

- You can also change the settings on the **<Setup>** screen. (Page 51)

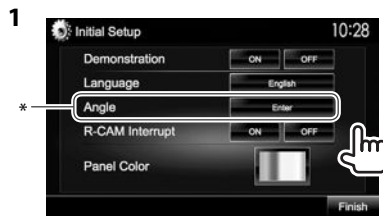

<Demonstration> Activate or deactivate the display demonstration. (Page 52)

<Language> Select the text language used for on-screen information.

- Set **<GUI Language>** to display the operation buttons and menu items in the selected language (**[Local]**) or English (**[English]**).

<Angle>* Adjust the panel angle. (Page 7)

<R-CAM Interrupt> Select **[ON]** when connecting the rear view camera. (Page 52)

<Panel Color> Select the color of the buttons on the monitor panel. (Page 48)

- Finish the procedure.



The **<TOP MENU>** screen is displayed.

- * Only for DDX7015BT.

Setting the security function

❑ Registering the security code

You can set a security code to protect your receiver system against theft.

- Display the **<TOP MENU>** screen. On the source control screen:



- Display the **<System>** setting screen.

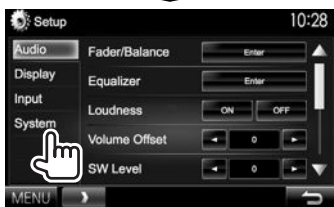

- Display the **<Security Code Set>** screen.
 - Press **[▼]** repeatedly to change the page on the **<System>** menu screen.



- To clear the registered security code, perform steps **1** and **2**, then press **[CLR]** in **<Security Code>**.

- Enter a four-digit number (①), then confirm the entry (②).



- Press **[Clear]** to delete the last entry.
- Press **[Cancel]** to cancel the setting.

- Repeat step **4** to confirm your security code. Now, your security code is registered.

- When the unit is being reset or disconnected from the battery, you are required to enter the security code. Enter the correct security code, then press **[Enter]**.

INITIAL SETTINGS

❑ Activating the security function

You can activate the security function to protect your receiver system against theft.

- 1 Display the <System> setting screen.
On the <TOP MENU> screen:



- Press [▼] repeatedly to change the page on the <System> menu screen.



The security indicator on the monitor panel flashes when the vehicle ignition is off.

To deactivate the security function: Select [OFF] for <SI>.

Clock settings

- 1 Display the <TOP MENU> screen.
On the source control screen:



- 2 Display the <Setup> screen.



- 3 Display the <Clock> screen.

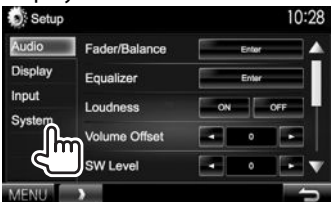

- 4 Set the clock time.



<NAV>*1 Synchronizes the clock time with the connected navigation unit.

<Radio Data System>*2 Synchronizes the clock time with FM Radio Data System.

<DAB>*3 Synchronizes the clock time with the digital radio (DAB).

<OFF> Sets the clock manually. (See below.)

When selecting <OFF>:

Adjust the hour (①), then adjust the minute (②).

- Press [Reset] to set the minute to "00".



- 5 Finish the procedure.



*1 Appears only when the navigation unit is connected.

*2 Only for DDX7015BT/DDX5015BT/DDX5015BTR.

*3 Only for DDX5015DAB.

BASICS

Component names and functions

⚠ Caution on the volume setting:

Digital devices produce very little noise compared with other sources. Lower the volume before playing these digital sources to avoid damaging the speakers by sudden increase of the output level.

DDX7015BT

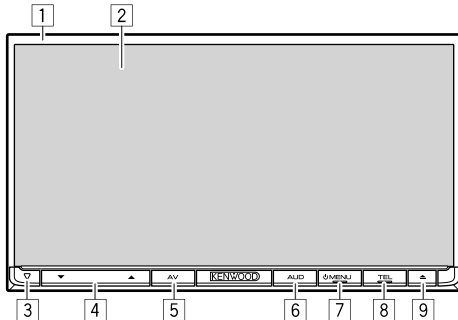

- 1 Monitor panel*
- 2 Screen (touch panel)
- 3 Reset button/Power indicator/Security indicator
 - Resets the unit. (Page 3)
 - Lights up while the unit is turned on.
 - Flashes when the security function is activated. (Page 5)
- 4 Volume ▼/▲ button
 - Adjusts the audio volume. (Page 7)
- 5 AV/AV OUT button
 - Displays the current source screen. (Press)
 - The function of the button when held varies depending on the <AV Key Long Press> setting. (Page 53)

- 6 AUD/V.OFF button
 - Displays the <Equalizer> screen. (Press) (Page 44)
 - The function of the button when held varies depending on the <AUD Key Long Press> setting. (Page 53)
- 7 ⏻ MENU button
 - Displays the <TOP MENU> screen. (Press) (Page 9)
 - Turns on the power. (Press) (Page 7)
 - Turns off the power. (Hold) (Page 7)
- 8 TEL/VOICE button
 - Displays the phone control screen. (Press) (Page 39)
 - Activates voice dialing. (Hold) (Page 40)
- 9 ▲ (Eject) button
 - Ejects the disc. (Tilts the monitor panel fully.)
 - Opens/closes the monitor panel.

* You can change the color of the buttons on the monitor panel. (Page 48)

DDX5015DAB/DDX5015BT/DDX5015BTR

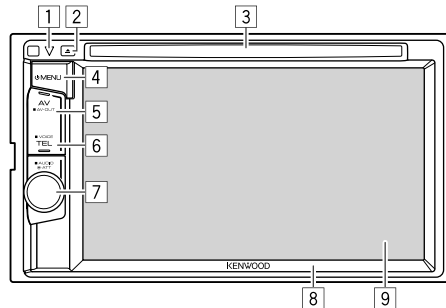

- 1 Reset button/Power indicator/Security indicator
 - Resets the unit. (Page 3)
 - Lights up while the unit is turned on.
 - Flashes when the security function is activated. (Page 5)
- 2 ▲ (Eject) button
 - Ejects the disc.
- 3 Loading slot
- 4 ⏻ MENU button
 - Displays the <TOP MENU> screen. (Press) (Page 9)
 - Turns on the power. (Press) (Page 7)
 - Turns off the power. (Hold) (Page 7)
- 5 AV/AV OUT button
 - Displays the current source screen. (Press)
 - The function of the button when held varies depending on the <AV Key Long Press> setting. (Page 53)
- 6 TEL/VOICE button
 - Displays the phone control screen. (Press) (Page 39)
 - The function of the button when held varies depending on the <TEL Key Long Press> setting. (Page 53)
- 7 Volume/ATT/AUDIO knob
 - Attenuates the sound. (Press) (Page 7)
 - Adjusts the audio volume. (Turn) (Page 7)
 - Displays the <Equalizer> screen. (Press) (Page 44)
- 8 Monitor panel*
- 9 Screen (touch panel)

* You can change the color of the buttons on the monitor panel. (Page 48)

BASICS

Common operations

Turning on the power DDX7015BT



DDX5015DAB/DDX5015BT/ DDX5015BTR

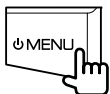

Turning off the power

DDX7015BT



DDX5015DAB/DDX5015BT/ DDX5015BTR

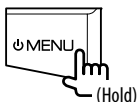

Adjusting the volume

To adjust the volume (00 to 35)
DDX7015BT

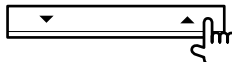

Press ▲ to increase, and press ▼ to decrease.
• Holding the button increases/decreases the volume continuously.

DDX5015DAB/DDX5015BT/ DDX5015BTR



Turn to the right to increase, and turn to the left to decrease.

To attenuate the sound (only for DDX5015DAB/ DDX5015BT/DDX5015BTR)

The ATT indicator lights up.



To cancel the attenuation: Press the same button again.

Adjusting the panel angle (only for DDX7015BT)

1 Display the <Angle Adjust> screen.

On the <TOP MENU> screen:

- Press [▼] repeatedly to change the page on the <Display> menu screen.

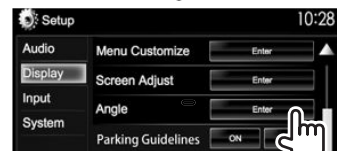
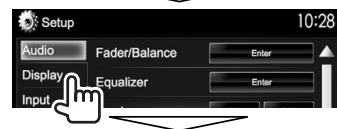
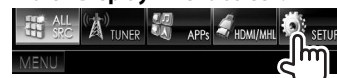

2 Select an angle (0 – 6).

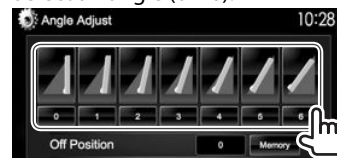

- To set the current position as the power off position, select **[Memory]**.

BASICS

❑ Putting the unit in standby

1 Display all <TOP MENU> items.

On the <TOP MENU> screen:



2

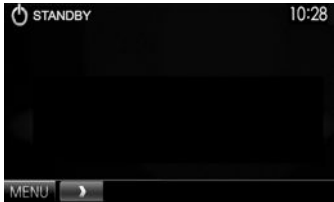

❑ Turning off the screen

DDX7015BT*1

DDX5015DAB/DDX5015BT/
DDX5015BTR*2

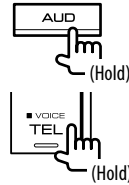

To turn on the screen: Press AV/AV OUT on the monitor panel, or touch the display.

*1 This operation works only when <AUD Key Long Press> is set to [V-OFF]. (Page 53)

*2 This operation works only when <TEL Key Long Press> is set to [V-OFF]. (Page 53)

Common screen operations

❑ Common screen descriptions

You can display other screens any time to change the source, show the information, or change the settings, etc.

Source control screen

Performs source playback operations.

- The operation buttons vary depending on the selected source.

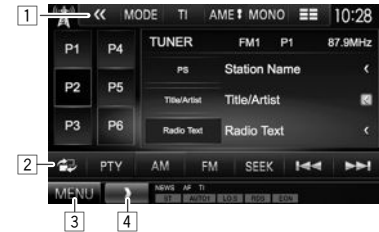

Common operation buttons:

- 1 Displays other operation buttons.
 - Disabled when there are no other buttons.
- 2 Switches between the normal source control screen and easy control screen. (Page 9)
- 3 Displays the <TOP MENU> screen. (Page 9)
 - Pressing MENU on the monitor panel also displays the <TOP MENU> screen.
- 4 Displays/hides short-cut buttons. (Page 10)

BASICS

Easy control screen

Pressing [MENU] switches between the normal source control screen and easy control screen.

The easy control screen allows you to control the source easily with simple buttons.

- The displayed buttons vary depending on the selected source.



<TOP MENU> screen

Displays the source control screen and settings screen.

- You can arrange the items to display on the <TOP MENU> screen. (Page 49)



Common operating buttons:

- 1 Changes the playback source. (Page 10)
- 2 Displays all playback sources and items. (Page 10)
- 3 Displays the <Setup> screen. (See the right column.)

<Setup> screen

Changes the detailed settings. (Page 51)



Common operating buttons:

- 1 Selects the menu category.
- 2 Displays the <TOP MENU> screen.
- 3 Changes the page.
- 4 Returns to the previous screen.

Touch screen operations

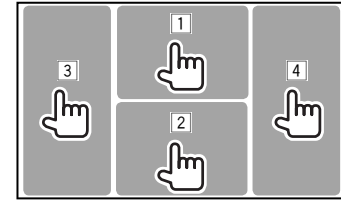

- 1 Displays the video control menu while playing a video.



- 2 Displays the source control screen while playing a video.



- The operation buttons disappear when the screen is touched or when no operation is done for about 5 seconds.
- 3 Goes to the previous chapter/track.*
 - 4 Goes to the next chapter/track.*

* Not available for video from an external component.

BASICS

Selecting the playback source

On the <TOP MENU> screen:

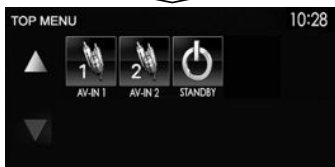
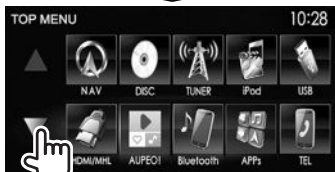

- You can change the page to display more items by pressing [▲]/[▼].

[NAV]^{*1} Displays the navigation screen when a navigation unit is connected. (Page 34)

[DISC] Plays a disc. (Page 11)

[TUNER] Switches to the radio broadcast. (Page 24)

[DAB]^{*2} Switches to the digital audio broadcast (DAB). (Page 27)

[iPod] Plays an iPod/iPhone. (Page 17)

[USB] Plays files on a USB device. (Page 16)

[HDMI/MHL] Plays a device connected to the HDMI/MHL input terminal. (Page 33)

[AUPEO!] Switches to the AUPEO! application. (Page 22)

[Bluetooth] Plays a Bluetooth audio player. (Page 41)

[APPs] Switches to the App screen from the connected iPod touch/iPhone/Android device. (Page 21)

[TEL] Displays the phone control screen. (Page 39)

[AV-IN1][AV-IN2] Switches to an external component connected to the AV-IN1 or iPod/AV-IN2 input terminal. (Page 31)

*1 When no navigation unit is connected, "No Navigation" appears.

*2 Only for DDX5015DAB.

Selecting the playback source on the <TOP MENU> screen



- You can change the items (other than [SETUP]) to display on the <TOP MENU> screen. (Page 49)

Using short-cut buttons

While displaying the source control screen or the <Setup> screen, you can use the short-cut buttons to go to the items on the <TOP MENU> screen indicated below.

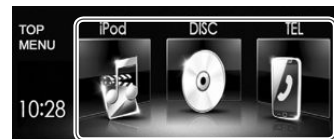

To display the short-cut buttons



On the source control screen:



On the <Setup> screen:



- When the navigation screen is displayed, pressing [] displays the source control screen.

To hide the short-cut buttons: Press [].

DISCS

Playing a disc

- If a disc does not have a disc menu, all tracks on it will be played repeatedly until you change the source or eject the disc.
- For playable disc types/file types, see page 63.

❑ Inserting a disc

Insert a disc with the label side facing up.

DDX7015BT

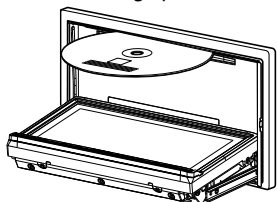
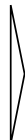

**DDX5015DAB/
DDX5015BT/
DDX5015BTR**

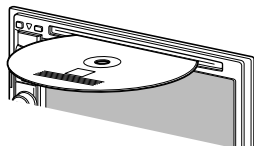

The source changes to **"DISC"** and playback starts.

- The IN indicator lights up while a disc is inserted.

- If "⊘" appears on the screen, the unit cannot accept the operation you have tried to do.
 - In some cases, without showing "⊘," operations will not be accepted.
- When playing back a multi-channel encoded disc, the multi-channel signals are downmixed to stereo.

❑ Ejecting a disc

DDX7015BT



**DDX5015DAB/DDX5015BT/
DDX5015BTR**

- When removing a disc, pull it horizontally.
- You can eject a disc when playing another AV source.
- If the ejected disc is not removed within 60 seconds, the disc is automatically inserted again into the loading slot to protect it from dust.

Closing the monitor panel (only for DDX7015BT)

After removing the disc, press on the monitor panel. The monitor panel closes.

Playback operations

When the operation buttons are not displayed on the screen, touch the area shown on the illustration.

- To change settings for video playback, see page 46.

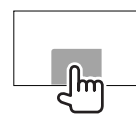

❑ Indications and buttons on the source control screen

For video playback



Playback information

- The information displayed on the screen differs depending on the type of disc/file being played back.

- 1 Media type
- 2 Current playback item information (title no./chapter no./folder no./file no./track no.)
- 3 Playing time
- 4 Playback mode (Page 14)
- 5 File type
- 6 IN indicator

DISCS

Operation buttons

- Available buttons on the screen and operations differ depending on the type of disc/file being played back.

- [**Q**] Displays the folder/track list. (Page 13)
- [**<<**] [**>>**] Reverse/forward search during playback.
- [**<<<**] [**>>>**] • Selects a chapter/track. (Press)
• Reverse/forward search. (Hold)
- [**▶||**] Starts/pauses playback.
- [**■**] Stops playback.
- [**<<<**] Displays other operation buttons.
• Disabled when there are no other buttons.
- [**MODE**] Changes the settings for disc playback on the **<DISC Mode>** screen. (Page 15)
- [**○**] [**✕**] Selects playback mode. (Page 14)
- [**Playlist**] Displays the Original Program/Playlist screen.
- [**<<**] [**|**] [**>>**] Plays in frame-by-frame.
- [**+**] [**-**] Selects a folder.
- [**PBC**] Activates or deactivates the VCD PBC (Playback Control) function.
- [**MENU**] Displays the **<TOP MENU>** screen.

For audio playback



Playback information

- The information displayed on the screen differs depending on the type of disc/file being played back.
- 1 Media type
 - 2 Track/file information
 - Pressing [**<**] scrolls the text if not all of the text is shown.
 - 3 Current playback item information (folder no./file no./track no.)
 - 4 Playback status
 - 5 Playing time
 - 6 Playback mode (Page 14)
 - 7 File type
 - 8 IN indicator

Operation buttons

- Available buttons on the screen and operations differ depending on the type of disc/file being played back.
- [**○**] [**■**] Displays the easy control screen. (Page 9)
- [**Q**] Displays the folder/track list. (Page 13)
- [**<<<**] [**>>>**] Selects a track.
- [**<<**] [**>>**] Reverse/forward search.
- [**▶||**] Starts/pauses playback.
- [**<<<**] Displays other operation buttons.
• Disabled when there are no other buttons.
- [**MODE**] Changes the settings for disc playback on the **<DISC Mode>** screen. (Page 15)
- [**+**] [**-**] Selects a folder.
- [**○**] [**✕**] Selects playback mode. (Page 14)
- [**■**] Stops playback.
- [**MENU**] Displays the **<TOP MENU>** screen.

DISCS

❑ Selecting a folder/track on the list

1



2 Select the folder (①), then the item in the selected folder (②).

- Repeat the procedure until you select the desired track.



- You can change the page to display more items by pressing [▲]/[▼].
- Press [Enter] to open the folder containing the current track.
- Press [Back] to return to the root folder.
- Press [Up] to return to the upper layer.

❑ Video menu operations

You can display the video menu screen during video playback.

- The operation buttons disappear when the screen is touched or when no operation is done for about 5 seconds.

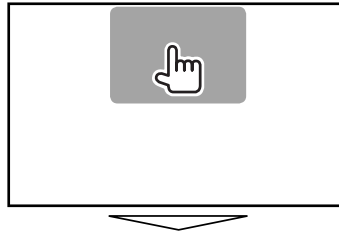

For video playback except VCD



- Available buttons on the screen and operations differ depending on the type of disc/file being played back.

[ZOOM]

Displays the picture size selection screen. (Page 47)

[Aspect]

Selects the aspect ratio. (Page 47)

[PictureAdjust]

Displays the picture adjustment screen. (Page 46)

[Audio]

Selects the audio type (or channel for DVD-VR).

[Subtitle]

Selects the subtitle type.

[Angle]

Selects the view angle.

[MENU]

Displays the disc menu.

[T MENU]

Displays the disc menu (DVD).

[Highlight]

Switches to the direct disc menu mode. Touch the target item to select.

- To restore the screen, press AV on the monitor panel.

[CUR]

Displays the menu/scene selection screen.

- [▲] [▼] [◀] [▶]: Selects an item.
- [Enter]: Confirms the selection.
- [Return]: Returns to the previous screen.

DISCS

For VCD



- [ZOOM]** Displays the picture size selection screen. (Page 47)
- [Aspect]** Selects the aspect ratio. (Page 47)
- [PictureAdjust]** Displays the picture adjustment screen. (Page 46)
- [Audio]** Selects the audio channel (ST: stereo, LL: left, RR: right).
- [Return]** Displays the previous screen or menu.
- [Direct]** Displays/hides the direct selection buttons. (See the right column.)

To select a track directly on a VCD



- When you enter a wrong number, press **[CLR]** to delete the last entry.

Selecting playback mode



- [REPEAT]** Selects Repeat playback mode.
- [RANDOM]** Selects Random playback mode.
- Available playback modes differ depending on the type of disc/file being played back.
- You cannot activate the repeat mode and the random mode at the same time.
- Each time you press the button, the playback mode changes. (The corresponding indicator lights up.)
 - Available items differ depending on the type of disc/file being played back.
- C-REP** Repeats current chapter.
- T-REP** Repeats current title/program.
- REP** Repeats current track.
- FO-REP** Repeats all tracks of the current folder.
- FO-RDM** Randomly plays all tracks of the current folder, then tracks of the next folders.
- RDM** Randomly plays all tracks.

To cancel Repeat/Random playback: Press the button repeatedly until the indicator disappears.

DISCS

Settings for disc playback



- Available items shown on the <DISC Mode> screen differ depending on the type of disc/file being played back.

Setting items

<Menu Language>*	Select the initial disc menu language. (Initial: English) (Page 65)
<Subtitle Language>*	Select the initial subtitle language or turn subtitles off (Off). (Initial: English) (Page 65)
<Audio Language>*	Select the initial audio language. (Initial: Original) (Page 65)
<Dynamic Range Control>*	You can change the dynamic range while playing using Dolby Digital software. <ul style="list-style-type: none"> • Wide: Select this to enjoy a powerful sound at a low volume level with its full dynamic range. • Normal: Select this to reduce the dynamic range a little. • Dialog (Initial): Select this to reproduce movie dialog more clearly.

<Angle Mark>	Select whether to display the angle mark. <ul style="list-style-type: none"> • ON (Initial): Select this to display the angle mark. • OFF: Select this to hide the angle mark.
<Screen Ratio>*	Select the monitor type to watch a wide screen picture on the external monitor. 16:9 (Initial) 4:3 LB 4:3 PS 
<Parental Level>*	Set the parental level. (See the right column.)
<CD Read>	Select the files to play on a disc containing music files. You cannot change the setting when a disc is inserted. <ul style="list-style-type: none"> • 1 (Initial): Automatically distinguishes between audio file discs and music CDs. • 2: Forces to play as a music CD. No sound can be heard if an audio file disc is played.

* You can change these settings only while playback is stopped.

Setting the parental lock

The parental lock cannot be set during DVD playback.

- 1 Display the <Parental Pass> screen. On the <DISC Mode> screen:
 - Press [▼] repeatedly to change the page on the <DISC Mode> screen.



- 2 Enter the 4-digit parental pass code (①), and press [Enter] (②).



- To clear the entry, press [Clear].
- To cancel setting the code, press [Cancel].

- 3 Adjust the parental level (<OFF>, <Level 1> to <Level 8>).

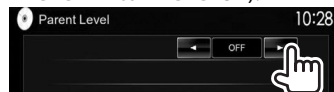

To deactivate the parental lock: Select [OFF] for <Parental Level>.

USB

Connecting a USB device

You can connect a USB mass storage class device such as a USB memory, Digital Audio Player etc. to the unit.

- For details about connecting USB devices, see page 59.
- You cannot connect a computer or portable HDD to the USB input terminal.
- For playable file types and notes on using USB devices, see page 64.

When a USB device is connected...

The source changes to "USB" and playback starts.

- All tracks in the USB device will be played repeatedly until you change the source.

To disconnect the USB device safely:

Press [▲], then disconnect the USB device after "No Device" appears.

Playback operations

When the operation buttons are not displayed on the screen, touch the area shown on the illustration.

- To change settings for video playback, see page 46.

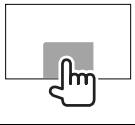

Indications and buttons on the source control screen



Playback information

- The information displayed on the screen differs depending on the type of file being played back.

- 1 Track/file information
 - Pressing [◀] scrolls the text if not all of the text is shown.
- 2 Current playback item information (folder no./file no.)
- 3 Playback status
- 4 Playing time
- 5 Jacket picture (Shown while playing if the file has tag data that includes the jacket picture)
- 6 Playback mode (See the right column.)
- 7 File type

Operation buttons

- Available buttons on the screen and operations differ depending on the type of file being played back.

- [🏠] Displays the easy control screen. (Page 9)
- [Q] Displays the list selection screen. (Page 17)
- [◀▶] Selects a track.

- [◀▶] Reverse/forward search.
- [⏮] Starts/pauses playback.
- [◀] Displays other operation buttons.
 - Disabled when there are no other buttons.
- [MODE] Changes the picture display time setting on the <USB Mode> screen. (Page 17)
- [+/-] Selects a folder.
- [🔄] Selects repeat playback mode.*1 *2
 - **REP**: Repeats the current track/file.
 - **FO-REP**: Repeats all tracks/files in the current folder or specified category.
- [🎲] Activates random playback mode.*1 *2
 - **RDM**:
 - When selecting the track/file from the folder, randomly plays all tracks/files of the current folder, then the tracks/files of the next folder.
 - When selecting the track/file from the category, randomly plays all tracks/files of the specified category.
- [▲] Disconnects the USB device safely.
- [MENU] Displays the <TOP MENU> screen.

*1 To cancel random or repeat mode, press the button repeatedly until the indicator disappears.

*2 You cannot activate the repeat mode and the random mode at the same time.

USB

❑ Setting <Picture Display Time>

Set the interval between slides during slide-shows of the picture files.

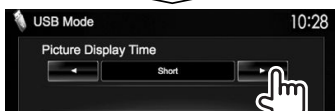

❑ Selecting a track in a list



2 Select the list.



3 Select the track.

- You can change the page to display more items by pressing [▲]/[▼].
- Press [⏪] to return to the root folder.
- Press [⏩] to return to the upper layer.
- Press [📁] to open the folder containing the current track.
- If you want to play all tracks in the folder, press [▶] on the right of the desired folder.

- On the <Category List>/<Folder List>: You can switch the file type to list: Press [🎵] to list audio files, [📺] to list video files, or [🖼️] to list still picture files.
- On the <Category List>/<Link Search>: To list the items in alphabetical order, press [A-Z], then select the first character.

From <Category List>:

Select the category (①), then the item in the selected category (②).

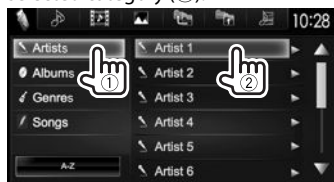

From <Link Search>:

Select the tag type (①) to display a list of content that contains the same tag as the track/file currently being played, then the item (②).

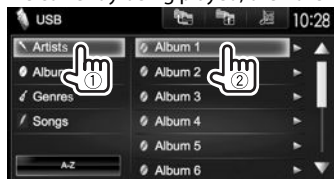

From <Folder List>:

Select the folder (①), then the item in the selected folder (②).

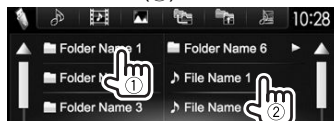

iPod/iPhone

Preparation

❑ Connecting iPod/iPhone

- For details about connecting iPod/iPhone, see page 59.
- For playable iPod/iPhone types, see page 65.

Connect your iPod/iPhone according to your purpose or the type of iPod/iPhone.

Wired connection

- **To listen to music:** USB Audio cable for iPod/iPhone
 - For iPod/iPhone except for iPod nano (7th Generation)/iPod touch (5th Generation)/iPhone 5S/iPhone 5C/iPhone 5: KCA-iP102 (optional accessory)
 - For iPod nano (7th Generation)/iPod touch (5th Generation)/iPhone 5S/iPhone 5C/iPhone 5: KCA-iP103 (optional accessory)
- **To watch video and listen to music:** USB Audio and Video cable for iPod/iPhone
 - For iPod/iPhone except for iPod nano (7th Generation)/iPod touch (5th Generation)/iPhone 5S/iPhone 5C/iPhone 5: KCA-iP202 (optional accessory)
 - For iPod nano (7th Generation)/iPod touch (5th Generation)/iPhone 5S/iPhone 5C/iPhone 5, use the HDMI cable KCA-HD100 (optional accessory) and KCA-iP103 (optional accessory) through a Lightning-Digital AV adapter (accessory of the iPod/iPhone)

iPod/iPhone

Bluetooth connection

Pair the iPod/iPhone through Bluetooth. (Page 35)

- For iPod nano (7th Generation)/iPod touch (5th Generation)/iPhone 5S/iPhone 5C/iPhone 5: To watch video, connect your iPod/iPhone to the HDMI/MHL input terminal using KCA-HD100 (optional accessory). (Page 59)
- For iPod/iPhone except for iPod nano (7th Generation)/iPod touch (5th Generation)/iPhone 5S/iPhone 5C/iPhone 5: You cannot watch video with a Bluetooth connection.

❑ Selecting the iPod/iPhone device to play and connection method

When connecting the iPod/iPhone device for first time, the setup screen (for connection, etc.) appears. Follow the procedure on the setup screen to configure the settings.

1 Display the <iPod Settings> screen.

On the <TOP MENU> screen:

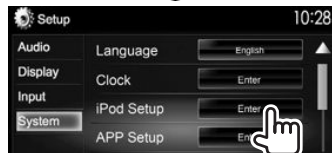

- If [Enter] for <iPod Setup> cannot be selected, put the unit in standby. (Page 8)

2



- If you do not need to change the settings, press [OK] to exit from the setup screen.

3 Select the connection method (①), then press [Next] (②).

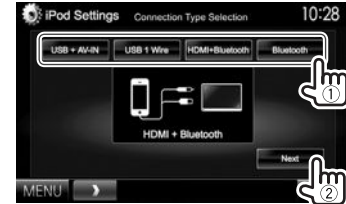

<USB + AV-IN>

Select this when the iPod/iPhone is connected using KCA-iP202 (optional accessory).

<USB 1 Wire>

Select this when the iPod/iPhone is connected using KCA-iP102 (optional accessory) or KCA-iP103 (optional accessory).

<HDMI + Bluetooth>

Select this when the iPod/iPhone is connected using HDMI cable KCA-HD100 (optional accessory) and KCA-iP103 (optional accessory) through a Lightning-Digital AV adapter (accessory of the iPod/iPhone).

<Bluetooth>

Select this when the iPod/iPhone is connected via Bluetooth.

- When selecting <USB + AV-IN> or <USB 1 Wire>, go to step 5.

iPod/iPhone

- 4 When selecting **<HDMI + Bluetooth>** or **<Bluetooth>** as the connection method, the device selection screen appears. Search for the available iPod/iPhone devices (①), select the target device from the list (②), then press **[Next]**.



- You can change the page to display more items by pressing [▲]/[▼].
- If the device is already listed, skip step ①.
- To stop searching, press **[Cancel]**.

- 5 Confirm the settings.



❑ Selecting preference settings for iPod/iPhone playback

When the source is "iPod"...



<Audiobooks> Select the speed of audio books.

<Wide Screen>*

- **[ON]**: Select this to display video compatible with wide-screen display in wide-screen.
- **[OFF]**: Select this to deactivate.

* You cannot change the setting when iPod/iPhone is connected.

Playback operations

When the operation buttons are not displayed on the screen, touch the area shown on the illustration.

- To change settings for video playback, see page 46.

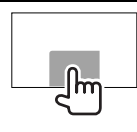

❑ Indications and buttons on the source control screen



Playback information

- 1 Song/video information
 - Pressing [**<**] scrolls the text if not all of the text is shown.
- 2 Track no./Total track number
- 3 Playback status
- 4 Playing time
- 5 Artwork (Shown if the song contains artwork)
- 6 Playback mode (Page 20)

iPod/iPhone

Operation buttons

- [] Displays the easy control screen. (Page 9)
- [] Displays the audio/video file list. (See the right column.)
- [] [] Selects an audio/video file.
- [] [] Reverse/forward search.
- [] Starts/pauses playback.
- [] Displays other operation buttons.
- Disabled when there are no other buttons.
- [**MODE**] Changes the settings for iPod/iPhone playback on the <iPod Mode> screen. (Page 19)
- [] Selects repeat playback mode.
- ①: Functions the same as Repeat One.
 - All: Functions the same as Repeat All.
 - : Cancels the repeat mode.
- [] Selects random playback mode.*
- : Functions the same as Shuffle Songs.
 - Album: Functions the same as Shuffle Albums.
- [**MENU**] Displays the <TOP MENU> screen.

* To cancel random mode, press the button repeatedly until the indicator disappears.

□ Selecting an audio/video file from the menu

-  1
 - Select the menu (): audio or (): video (①), a category (②), then a desired item (③).
- Select an item in each layer until you reach and select the desired file.
 - You can change the page to display more items by pressing []/[].
 - Press [**All >**] to play all songs/videos.
 - Press [**A-Z**] to sort the list in alphabetical order.
 - Press [] to return to the top layer.
 - Press [] to return to the upper layer.

Audio menu:



Video menu:



- Available categories differ depending on the type of your iPod/iPhone.

APPs

You can use an App of the connected iPod touch/iPhone/Android on this unit.

- For Apps you can use on this unit, visit http://www.kenwood.com/cs/ce.

Preparation

- 1 Connect the iPod touch/iPhone/Android.
 - For wired connection, see page 59 for iPod touch/iPhone or page 60 for Android.
 - To view video, connect the device using KCA-iP202 or KCA-HD100 (optional accessory).
 - For Bluetooth connection, see page 37.
- 2 Select the iPod touch/iPhone/Android device to use and connection method on the <APP Settings> screen. (Page 43)

When connecting the device for the first time, the setup screen (for connection, etc.) appears. Follow the procedure on the setup screen to configure the settings.

Using an App

When the operation buttons are not displayed on the screen, touch the screen to show them.

- To change settings for video playback, see page 46.

❑ Playback operations

- 1 Start the App on your iPod touch/iPhone/Android.
- 2 Select “**APPs**” as the source. (Page 10)

❑ Operation buttons on the source control screen



- [▶] Starts playback.
- [||] Pauses playback.
- [◀◀] [▶▶] Selects an audio/video file.
- [◀◀] [▶▶] Reverse/forward search.
- [▶||] Starts/pauses playback.
- [MENU] Displays the <TOP MENU> screen.

- You can operate some functions of the App on the touch panel.
- For some applications such as navigation applications, the operation buttons and information are not shown. You can perform the operations on the touch panel, such as scrolling the map.
 - If “⊘” appears on the screen, the unit cannot accept the touch operation you have tried to do.
- You can also play back the audio/video using iPod/iPhone/Android itself instead of the unit.

❑ Switching to the App screen while listening to another source

DDX7015BT

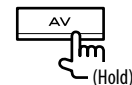

DDX5015DAB/DDX5015BT/
DDX5015BTR



- This operation works only when <AV Key Long Press> is set to [APPs]. (Page 53)

To return to the source control screen: Press the same button again.

AUPEO!

AUPEO! Personal Radio plays free music you really like. You can develop your own personalized Internet radio by rating or skipping tracks.

You can stream AUPEO! from connected iPod touch/iPhone or Android devices.

- Install the latest version of the AUPEO! application on your iPod touch/iPhone/Android and create an account.

Preparation

Connect the device, then start the AUPEO! application.

- 1 Connect the device.
 - **For Android:** Pair the Android device through Bluetooth. (Page 35)
 - **For iPod touch/iPhone:** Connect iPod touch/iPhone. (Page 17)
- 2 Select the device to use and connection method on the **<APP Settings>** screen. (Page 43)
- 3 Select **"AUPEO!"** as the source. On the **<TOP MENU>** screen:



The AUPEO! application is started.

Playback operations

You can operate AUPEO! using the remote controller. Only playing, pausing, and skipping are available.

Indications and buttons on the source control screen



Playback information

- 1 Picture data
- 2 Track information
 - Pressing [**<**] scrolls the text if not all of the text is shown.
- 3 Playback status

Operation buttons

- [**📶**] Displays the easy control screen. (Page 9)
- [**🔍**] Displays the **<Station Search>** screen. (Page 23)
- [**❤️**] "Loves" and registers the current track as a favorite.
- [**▶️⏸️**] Starts/pauses playback.
- [**▶️▶️**] Skips the current track.
- [**⏮️**] "Bans" the current track and skips to the next track.
- [**[MENU]**] Displays the **<TOP MENU>** screen.

AUPEO!

☐ Selecting a station

1 Display the <Station Search> screen.



2 Select the category, then the station.



- To return to the previous layer, press [↑].

Requirements for AUPEO!

iPhone or iPod touch

- Install the latest version of the AUPEO! application on your iPhone or iPod touch. (Search for “AUPEO!” in the Apple iTunes App Store to find and install the most recent version.)
- Connect iPod touch/iPhone to this unit with a cable or via Bluetooth.
 - When connecting with a cable: Use KCA-iP202, KCA-HD100, KCA-iP102 (optional accessory) or KCA-iP103 (optional accessory).
 - When connecting via Bluetooth, the following profiles must be supported.
 - SPP (Serial Port Profile)
 - A2DP (Advanced Audio Distribution Profile)

Android™

- Visit Google play and search for “AUPEO!” to install.
- Bluetooth must be built in and the following profiles must be supported.
 - SPP (Serial Port Profile)
 - A2DP (Advanced Audio Distribution Profile)

NOTE

- Ensure you are logged in to your smartphone application. If you do not have an AUPEO! account, you can create one for free from your smartphone or at www.aupeo.com.
- Because AUPEO! is a third-party service, the specifications are subject to change without prior notice. Accordingly, compatibility may be impaired or some or all of the services may become unavailable.
- Some functions of AUPEO! cannot be operated from this unit.
- For issues using the application, contact AUPEO! at www.aupeo.com.
- Establish an Internet connection using LTE, 3G, EDGE, or WiFi.

TUNER

Listening to the radio

Indications and buttons on the source control screen



Tuner reception information

- 1 Band
- 2 Preset no.
- 3 The station frequency currently tuned in
- 4 ST/MONO indicator
 - The ST indicator lights up when receiving an FM stereo broadcast with sufficient signal strength.
- 5 AF indicator
- 6 Seek mode
- 7 LO.S indicator (See the far right column.)
- 8 RDS indicator: Lights up when receiving a Radio Data System station.
- 9 EON indicator: Lights up when a Radio Data System station is sending EON signals.
- 10 Text information
 - Pressing [**<**] scrolls the text if not all of the text is shown.
 - Pressing [**Radio Text**] switches the information between Radio Text, Radio Text Plus, and PTY code.
- 11 Standby reception indicators

Operation buttons

- [P1] – [P6] • Selects a stored station. (Press)
• Stores the current station. (Hold)
- [MODE] Changes the settings for tuner reception on the **<Tuner Mode>** screen. (Pages 24 and 26)
- [TI]* Activates/deactivates TI standby reception mode. (Page 25)
- [AME] Presets stations automatically. (Hold) (Page 25)
- [MONO]* Activates/deactivates monaural mode for better FM reception. (Stereo effect will be lost.)
• The MONO indicator lights up while monaural mode is activated.
- [≡] Changes the display information. (See the right column.)
- [👉] Displays the easy control screen. (Page 9)
- [PTY]* Enters PTY search mode. (Page 25)
- [AM] Selects the AM band.
- [FM] Selects the FM band.
→ FM1 → FM2 → FM3
- [SEEK] Changes the seek mode.
 - **AUTO1**: Auto Search
 - **AUTO2**: Tunes in the stations in memory one after another.
 - **MANU**: Manual Search
- [◀▶] Searches for a station.
 - The search method differs according to the selected seek mode. (See above.)
- [MENU] Displays the **<TOP MENU>** screen.

* Appears only when FM is selected as the source.

Changing the display information



The preset list and the station name for FM Radio Data System (when PS signal is coming in) are displayed.

- Pressing [≡] again displays the text information for the station currently being received.

Tuning in FM stations only with strong signals—Local Seek



[ON] Select this to tune in only to stations with sufficient signal strength. The LO.S indicator lights up.

[OFF] Deactivate the function.

TUNER

Presetting stations

❑ Storing stations in the memory

You can preset 6 stations for each band.

Automatic presetting—AME (Auto Memory)



Local stations with the strongest signals are found and stored automatically.

Manual presetting

- 1 Tune in to a station you want to preset. (Page 24)
- 2 Select a preset number.



The station selected in step 1 is stored.

❑ Selecting a preset station



FM Radio Data System features

❑ Searching for FM Radio Data System programs—PTY Search

You can search for your favorite programs being broadcast by selecting the PTY code.

1



2 Select a PTY code.



- You can change the page to display more items by pressing [▲]/[▼].

PTY Search starts.

If there is a station broadcasting a program of the same PTY code as you have selected, that station is tuned in.

- Only English/Spanish/French/German/Dutch/Portuguese are available for the text language here. If another language has been selected in <Language> (Page 53), the text language is set to English.

❑ Activating/deactivating TI/News Standby Reception

TI Standby Reception



The unit is in standby to switch to Traffic Information (TI) if available. (The TI indicator lights up in white.)

- If the TI indicator is lit in orange, tune into another station providing Radio Data System signals.

To deactivate TI Standby Reception: Press [TI]. (The TI indicator turns off.)

- The volume adjustment for Traffic Information is automatically memorized. The next time the unit switches to Traffic Information, the volume is set to the previous level.
- For DDX5015DAB: The TI Standby Reception can also be activated or deactivated from “DAB” source control screen. (Page 29)

TUNER

News Standby Reception



- [00min]** - Activate News Standby Reception (the NEWS indicator lights up).
Select the period of time to disable interruption.
[OFF] Deactivate the function.

- The volume adjustment while receiving News is automatically memorized. The next time the unit switches to News, the volume is set to the previous level.

❑ Tracing the same program—Network-Tracking Reception

When driving in an area where FM reception is not sufficient enough, this unit automatically tunes in to another FM Radio Data System station of the same network, possibly broadcasting the same program with stronger signals.

- When shipped from the factory, Network-Tracking Reception is activated.

To change the Network-Tracking Reception setting



- [AF]** Switch to another station. The program may differ from the one currently received (the AF indicator lights up).
[AF Reg] Switch to another station broadcasting the same program (the AF indicator lights up).
[OFF] Deactivate the function.
- The RDS indicator lights up when the Network-Tracking Reception is activated and an FM Radio Data System station is found.

❑ Automatic TI station seek—Auto TP Seek

When traffic information station reception is poor, the unit automatically searches for another station that can be received better.

To activate Auto TP Seek



To deactivate Auto TP Seek: Press **[OFF]**.

DIGITAL RADIO (DAB) (Only for DDX5015DAB)

About DAB (Digital Audio Broadcasting)

What is DAB system?

DAB (Digital Audio Broadcasting) is one of the digital radio broadcasting systems available today. It can deliver digital quality sound without any annoying interference or signal distortion. Furthermore, it can carry text and data.

In contrast to FM broadcast, where each program is transmitted on its own frequency, DAB combines several programs (called "services") to form one "ensemble."

The "Primary component" (main radio station) is sometimes accompanied by a "secondary component" which can contain extra programs or other information.

Listening to Digital Radio

Indications and buttons on the source control screen



Tuner reception information

- 1 Preset no.
- 2 Channel no.
- 3 Signal strength
- 4 TI indicator
- 5 Seek mode
- 6 DAB reception indicator
 - The DAB indicator lights up when receiving an DAB broadcast.
 - The MC indicator lights up when receiving an DAB multi component.
- 7 RDS indicator: Lights up when receiving a Radio Data System station.
- 8 Text information
 - Pressing [**<**] scrolls the text if not all of the text is shown.
 - Pressing [**Now Playing**] switches the information. Each time you press the button, the information and the button switch between [**Audio Quality**], [**PTY**], [**Artists**], [**Title**], [**Now Playing**], and [**Next Program**].

Operation buttons

- [**P>**] Displays other preset numbers.
- [**P1**] – [**P15**]
 - Selects a stored service. (Press)
 - Stores the current service. (Hold)
- [**MODE**] Changes the settings for DAB reception on the **<DAB Mode>** screen. (Page 30)
- [**TI**] Activates/deactivates TI standby reception mode. (Page 29)
- [**PTY**] Enters PTY search mode. (Page 29)
- [**SEEK**] Changes the seek mode.
 - **AUTO1**: Auto Search
 - **AUTO2**: Tunes in the services in the memory one after another.
 - **MANU**: Manual Search
- [**≡**] Changes the display information. (Page 28)
- [**⏮**] Displays the easy control screen. (Page 9)
- [**Q**] Displays the **<List Type Select>** screen. (Page 28)
- [**◀▶**] Searches for an ensemble, service, and component.
 - The search method differs according to the selected seek mode. (See above.)
- [**DLS**] Displays Dynamic Label Segment Screen (text messages the station sends)
- [**REPLAY**] Displays the **<Replay>** screen. (Page 29)
- [**MENU**] Displays the **<TOP MENU>** screen.

DIGITAL RADIO (DAB)

❑ Changing the display information

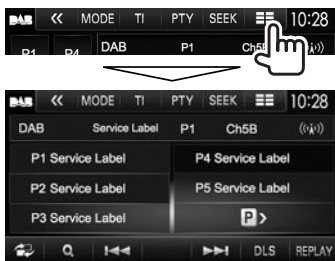

The preset list of service labels is displayed.

- Pressing [SEEK] again displays the text information for the service or component currently being received.

❑ Selecting a service from the list

1 Display the <List Type Select> screen.



2 Select the list type.

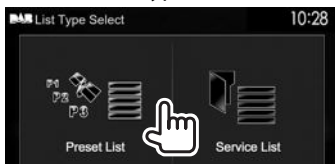

<Preset List> Selects from the preset list.

- To preset the services, see the far right column.

<Service List> Selects from the service names (Service List).

3 Select a service from the list.

On the <Preset List>

- You can change the page to display more items by pressing [▲]/[▼].

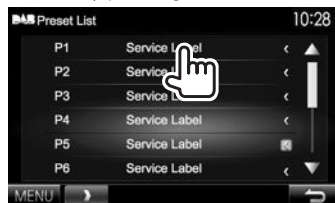

On the <Service List>

- You can change the page to display more items by pressing [▲]/[▼].

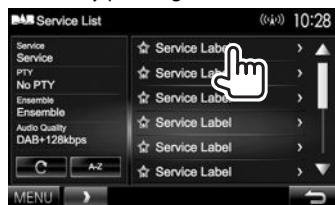

- Press [A-Z] to search for the initial letter. Pressing [A-Z] displays the <A-Z Search> screen. Select the initial to start the search.
 - If you want to search with non-alphabetical characters, press [#].
- Press and hold [C] to update the <Service List>.

Presetting services

❑ Storing services in the memory

You can preset 15 services.

- 1 Select a service you want to preset. (Page 27)
- 2 Select a preset number.
 - If you want to select a preset number between P6 – P15, press [P>] to display those numbers.



The service selected in step 1 is stored.

DIGITAL RADIO (DAB)

Radio Data System features

❑ Searching for Radio Data System programs—PTY Search

You can search for your favorite programs being broadcast by selecting the PTY code.



2 Select a PTY code.



- You can change the page to display more items by pressing [▲]/[▼].

PTY Search starts.

If there is a service broadcasting a program of the same PTY code as you have selected, that service is tuned in.

- Only English/Spanish/French/German/Dutch/Portuguese are available for the text language here. If another language has been selected in <Language> (Page 53), the text language is set to English.

❑ Activating/deactivating TI Standby Reception



The unit is in standby to switch to Traffic Information (TI) if available. (The TI indicator lights up in white.)

- If the TI indicator is lit in orange, tune into another station providing Radio Data System signals.

To deactivate TI Standby Reception: Press [TI].
(The TI indicator goes off.)

- The volume adjustment for Traffic Information is automatically memorized. The next time the unit switches to Traffic Information, the volume is set to the previous level.
- The TI Standby Reception can also be activated or deactivated from "TUNER" source control screen. (Page 25)

Using the Replay function

You can temporarily record the broadcast from the current time, and replay the recorded data.

- You can not use the Replay function ([REPLAY] button is not available) in the following cases:
 - When the data is not recorded.
 - When receiving a service of the program type selected for <PTY Watch>. (Page 30)
- When the recording capacity is full, the older recorded data is deleted and recording continues.
- If you change to another channel during playback, the recorded content will be lost.

❑ Entering the Replay mode



1 Progress bar

Shows the remaining capacity (gray) and the amount of recorded data (blue). If you have already recorded fully, the entire bar is indicated in blue.

- Updated every second.

2 Time code

Shows you the point of Replay you are listening to.

- Example: -5:00

- You are listening to data that is 5 minutes behind the current broadcast.

- Updated every second.

3 Playback status (▶: play / ||: pause / ◀◀: rewind / ▶▶: fast forward)

Continued on the next page...

DIGITAL RADIO (DAB)

Operation buttons

- [◀◀][▶▶]
- Skips back or forward by about 15 seconds. (Press)
 - Jumps to the end or the beginning of the recorded data. (Hold)
- [◀◀][▶▶] Rewind/Fast forward
- ▶|| Starts/Pauses playback.

To exit the Replay mode (Returning to the channel reception screen)



Settings for Digital Audio Radio

You can set the Digital Radio related items.



☐ Setting items

<p><Priority></p>	<ul style="list-style-type: none"> • ON (Initial): If the same service is provided by Digital Radio during Radio Data System reception, the unit automatically switches to Digital Radio. If the same service is provided by Radio Data System when reception of the service being provided by Digital Radio becomes poor, the unit automatically switches to Radio Data System. • OFF: Deactivates.
-------------------------	--

<p><PTY Watch></p>	<p>If the service of the set program type begins with the ensemble being received, the unit switches from any source to Digital Radio for service reception. Select the type of program using [◀] and [▶].</p>
<p><Announcement Select></p>	<p>If the service of the announcement item you activated begins with the ensemble being received, this unit switches from any source to the announcement received.*1</p> <p>Set [ON] for the announcement items you need.</p> <ul style="list-style-type: none"> • News flash/Transport flash/Warning/Service/ Area weather flash/ Event announcement/ Special event/Programme information/Sport report/ Financial report <ul style="list-style-type: none"> – To deactivate all announcements, select [All OFF]. – Only English/Spanish/ French/German/Dutch/ Portuguese/Italian/ Turkish are available for the text language here. If another language has been selected in <Language> (Page 53), the text language is set to English.

<p><Seamless Blend></p>	<ul style="list-style-type: none"> • ON (Initial): Prevents audio break when switching from Digital Radio to Analog Radio. • OFF: Cancels.
<p><Antenna Power></p>	<ul style="list-style-type: none"> • ON (Initial): Supplies the power to the DAB aerial. • OFF: Cancels
<p><Related Service></p>	<ul style="list-style-type: none"> • ON: When the current selected DAB service network is not available and found the related service, the unit offers to switch to the related service. • OFF (Initial): Cancels.
<p><L-Band Tuning>*2</p>	<ul style="list-style-type: none"> • ON: Receives the L-Band width during Digital Audio reception. • OFF (Initial): Cancels

*1 The volume adjustment while receiving Announcement is automatically memorized. The next time the unit switches to Announcement, the volume is set to the previous level.

*2 When the setting is changed, the preset services are initialized.

OTHER EXTERNAL COMPONENTS

Using external audio/video players—AV-IN

When the operation buttons are not displayed on the screen, touch the area shown on the illustration.

- To change settings for video playback, see page 46.

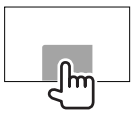

You can connect an external component to the AV-IN1 and iPod/AV-IN2 input terminals. (Page 60)

Indications and buttons on the source control screen



Operation buttons

- [MODE]** Changes the AV-IN name.
- Press [◀] or [▶] to select an AV-IN name.
 - This setting does not affect the source name “AV-IN 1”/ “AV-IN 2” displayed on the <TOP MENU>.
- [MENU]** Displays the <TOP MENU> screen.

Starting playback

- 1 Connect an external component to the AV-IN1 or iPod/AV-IN2 input terminal. (Page 60)
- 2 Select “AV-IN1” or “AV-IN2” as the source.
 - Press [▼] to change the page on the <TOP MENU> screen.

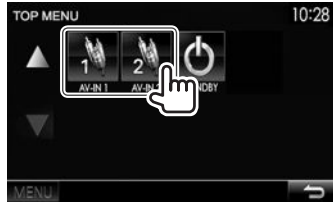

- 3 Turn on the connected component and start playing the source.

Using a rear view camera

- To connect a rear view camera, see page 60.
- To use a rear view camera, a REVERSE lead connection is required. (Page 58)

Activating the rear view camera

- 1 Display the <Input> setting screen. On the <TOP MENU> screen:



- 2



To deactivate: Select [OFF] for <R-CAM Interrupt>.

OTHER EXTERNAL COMPONENTS

❑ Displaying the picture from the rear view camera

The rear view screen is displayed when you shift the gear to the reverse (R) position.

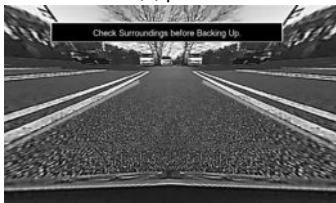

- To erase the caution message, touch the screen.

To display the picture from the rear view camera manually

DDX7015BT*1

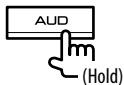

DDX5015DAB/DDX5015BT/
DDX5015BTR*2



- When displaying the picture from the rear view camera manually, you can change the picture settings using [Aspect]/[PictureAdjust]. (Page 46)

To exit the rear view screen: Press and hold the same button again.

*1 This operation works only when <AUD Key Long Press> is set to [R-CAM]. (Page 53)

*2 This operation works only when <TEL Key Long Press> is set to [R-CAM]. (Page 53)

❑ Using the parking guidelines

You can display parking guidelines to enable easier parking when you shift the gear to the reverse (R) position.

Displaying the parking guidelines

- 1 Display the <Display> setting screen. On the <TOP MENU> screen:

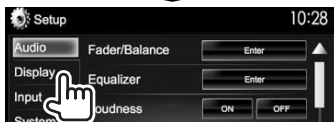

- Press [▼] repeatedly to change the page on the <Display> menu screen.

2



To deactivate: Select [OFF] for <Parking Guidelines>.

Adjusting the parking guidelines

Adjust the parking guidelines according to the size of the car, parking space and so on.

- Install the rear view camera in the appropriate position according to the instructions supplied with the rear view camera.
- When adjusting the parking guidelines, make sure to use the parking brake to prevent the car from moving.



- 1 Display the <Display> setting screen. (See the left column).

- Press [▼] repeatedly to change the page on the <Display> menu screen.

2



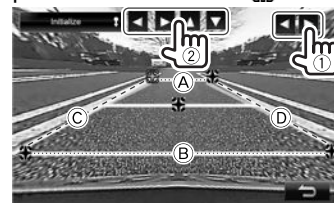

3

- Adjust the parking guidelines by selecting the  mark (1), then adjusting the position of the selected  mark (2).



Make sure that (A) and (B) are horizontally parallel, and that (C) and (D) are the same length.

- Press and hold [Initialize ] for 2 seconds to set all the  marks to the initial default position.

OTHER EXTERNAL COMPONENTS

Using a smartphone—HDMI/MHL

❑ What is HDMI/MHL?

HDMI stands for High Definition Multi-media Interface. HDMI connections can transfer digital video source signals (such as from a DVD player) without converting them to analog.

A new feature that has been added to HDMI that extends its capabilities further is MHL, or Mobile High-definition Link.

Both interfaces allow your smartphone to connect to the device. When it is connected, you can see your smartphone's screen on the monitor.

About Miracast Dongles

This unit is compatible with Miracast Dongles.

Connecting a Miracast Dongle (KCA-WL100: optional accessory) to the HDMI/MHL input terminal (Page 60) enables you to enjoy listening to music, watching videos, or viewing pictures over a wireless connection.

- For details about Miracast Dongle settings, etc., refer to the instructions supplied with the Miracast Dongle.

❑ Displaying the screen of the smartphone

You can display the screen of smartphones connected via the HDMI/MHL input terminal.

- 1 Connect your smartphone to the HDMI/MHL input terminal. (Page 60)
 - Use HDMI cable KCA-HD100 (optional accessory) or MHL cable KCA-MH100 (optional accessory).
- 2 Select **"HDMI/MHL"** as the source. On the **<TOP MENU>** screen:



- 3 Start an application or playback on your smartphone.

Watching a TV

Preparation

- Connect the TV tuner box to AV-IN1 input terminal and TV tuner remote control output terminal. (Page 60)
- Select **[ON]** for **<TV Tuner Control>**. (Page 52)

❑ Displaying the TV screen

- 1 Select **"AV-IN1"** as the source. (Page 10)
- 2 Turn on the TV.

❑ Operation buttons on the source control screen



- [TV Ctrl]** Displays the TV control screen.
- **[▲]/[▼]**: Displays the TV List screen.
 - **[◀]/[▶]**: Displays the Radio List screen.
 - **[Menu/OK]**: Displays the menu or confirms the selection.
 - **[Back]**: Restores the TV screen.
- [MENU]** Displays the **<TOP MENU>** screen.

OTHER EXTERNAL COMPONENTS

Using the external navigation unit

unit (Only for DDX7015BT/DDX5015DAB/DDX5015BT)

You can connect a navigation unit (KNA-G620T: optional accessory) to the navigation input terminal so that you can view the navigation screen. (Page 60)

- The navigation guidance comes out of the front speakers even when you listen to an audio source.

Viewing the navigation screen

On the <TOP MENU> screen:



- While the navigation screen is displayed, the touch panel operations are available only for navigation.
- The aspect ratio of the navigation screen is fixed to <Full> regardless of the <Aspect> setting (Page 47).

To exit the navigation screen
DDX7015BT



DDX5015DAB/DDX5015BT

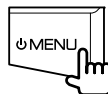

Settings for the navigation unit

1 Display the <Input> setting screen.

On the <TOP MENU> screen:



2 Display the <Navigation> screen.



3



- <Guidance>* Select which front speakers are used for the navigation guidance.
- <Volume>* Adjust the volume of the navigation guidance. (0 to 35)
- <NAV Mute>* Select [ON] to attenuate the sound coming out of speakers other than the front speakers during navigation guidance.
 - To cancel the attenuation, select [OFF].
- <NAV Setup> Press [Enter] to display the setup screen for the navigation unit. See the instruction manual supplied for the navigation unit.

* When an item is grayed out, you cannot change the setting. To change the settings, select [Unlock] on the <SETUP Memory> screen. (Page 50)

BLUETOOTH

Information for using Bluetooth® devices



Bluetooth is a short-range wireless radio communication technology for mobile devices such as mobile phones, portable PCs, and other devices. Bluetooth devices can be connected without cables and communicate with each other.

Notes

- While driving, do not perform complicated operations such as dialing numbers, using the phone book, etc. When you perform these operations, stop your car in a safe place.
- Some Bluetooth devices may not connect to this unit depending on the Bluetooth version of the device.
- This unit may not work for some Bluetooth devices.
- Connecting conditions may vary depending on your environment.
- For some Bluetooth devices, the device is disconnected when the unit is turned off.

About mobile phones compatible with Phone book Access Profile (PBAP)

If your mobile phone supports PBAP, you can display the phone book and call lists on the touch panel screen when the mobile phone is connected.

- Phone book: up to 600 entries
- Dialed calls, received calls, and missed calls: up to 10 entries each

Connecting Bluetooth devices

❑ Registering a new Bluetooth device

When you connect a Bluetooth device to the unit for the first time, pair the unit and the device. Pairing allows Bluetooth devices to communicate with each other.

- The pairing method differs depending on the Bluetooth version of the device.
 - For devices with Bluetooth 2.1: You can pair the device and the unit using SSP (Secure Simple Pairing) which only requires confirmation.
 - For devices with Bluetooth 2.0: You need to enter a PIN code both on the device and unit for pairing.
- Once the connection is established, it is registered in the unit even if you reset the unit. Up to 5 devices can be registered in total.
- Two devices for Bluetooth phone and one for Bluetooth audio can be connected at a time.
- To use the Bluetooth function, you need to turn on the Bluetooth function of the device.
- To use the registered device, you need to connect the device to the unit. (Page 37)

Auto pairing

When <Auto Pairing> is set to [ON], iOS devices (such as iPhone) are automatically paired when connected via USB. (Page 42)

Pairing a Bluetooth device using SSP (for Bluetooth 2.1)

When the Bluetooth device is compatible with Bluetooth 2.1, a pairing request is sent from an available device.

- 1 Search the unit (“DDX****”) from your Bluetooth device.
- 2 Confirm the request both on the device and the unit.

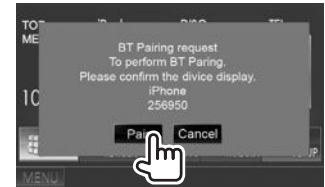

- Press [Cancel] to reject the request.

Continued on the next page...

BLUETOOTH

Pairing a Bluetooth device from the target device using a PIN code (for Bluetooth 2.0)

1 Display the <Bluetooth Setup> screen.

On the <TOP MENU> screen:

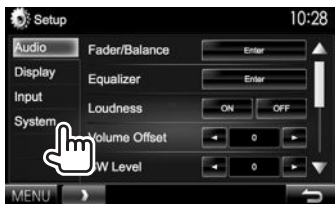

- You can also display the <Bluetooth Setup> screen by pressing [] on the phone control screen. (Page 39)



2 Change the PIN code.

- If you wish to skip changing the PIN code, go to step 3.
- The PIN code is initially set to "0000".
- The maximum number of digits in the PIN code is 15.

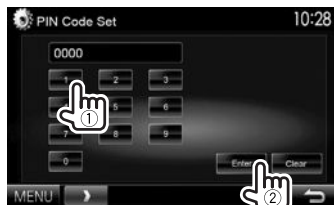

- Press [**Clear**] to delete the last entry.
- #### 3 Search for the unit ("DDX****") from your Bluetooth device.

- #### 4 Select the unit ("DDX****") on your Bluetooth device.
- If a PIN code is required, enter "0000" (initial).

When pairing is complete, the device is listed on the <Paired Device List>.



- To use the paired device, connect the device on the <Paired Device List>. (Page 37)

BLUETOOTH

Pairing a Bluetooth device from this unit using a PIN code (for Bluetooth 2.0)

1 Display the <Bluetooth Setup> screen. (Page 36)



3 Search for the available devices.



- To cancel searching devices, press **[Cancel]**.

4 Select the device you want to pair.



- If a PIN code is required, enter "0000" (initial).

Connecting/disconnecting a registered Bluetooth device

Two devices can be connected simultaneously.

1 Display the <Bluetooth Setup> screen. (Page 36)



3 Select the device you want to connect (①), then press **[Connection]** (②).



4 Select **[ON]** or **[OFF]** for the target.

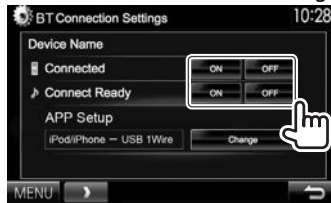

📱: Mobile phone

🎵: Audio device

- The status is shown as follows:
 - "Connected": A connection has been established.
 - "Connect Ready": A connection can be established.
 - "Disconnected": No connection is established.
- Press **[Change]** for **<APP Setup>** to display the **<APP Settings>** screen to configure settings for applications of iPod/iPhone/Android. (Page 43)

- When a Bluetooth mobile phone is connected, the signal strength and battery level are displayed when the information is acquired from the device.

Deleting a registered Bluetooth device

1 Display the <Bluetooth Setup> screen. (Page 36)



3 Select a device to delete (①), then press **[Remove]** (②).



A confirmation message appears. Press **[Yes]**.

BLUETOOTH

Using a Bluetooth mobile phone

❑ Receiving a call

When a call comes in...

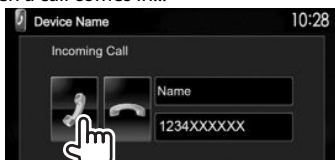

- Call information is displayed if acquired.
- Phone operation is not available while the picture from the rear view camera is displayed. (Page 31)

To reject a call

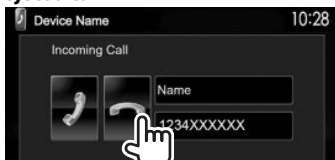

When **<Auto Response>** is set to **[ON]** (Page 42)
The unit answers incoming calls automatically.

❑ Ending a call

While talking...



❑ Adjusting the volume of calls/earpiece/microphone

While talking...





- You can adjust the volume level between 0 to 15 (initial: 3).
- Use the monitor panel to adjust the call/earpiece volume. (Page 7)

❑ Switching between handsfree mode and phone mode

While talking...



Each time you press the button, the talking method is switched ( : handsfree mode /  : phone mode).

❑ Adjusting the echo cancel level/reducing noise

While talking...



- **To adjust the echo volume (between -1 to +1, initial: 0):** Adjust **<EC LEVEL>**.
- **To adjust the noise reduction volume (between 0 to -20, initial: -10):** Adjust **<NR LEVEL>**.

BLUETOOTH

❑ Sending text during a call

You can send text during a call using the DTMF (Dual Tone Multi Frequency) function.

While talking...



❑ Switching between two connected devices

When 2 devices are connected, you can change the device to use.

On the phone control screen:



- The name of the active device appears. The devices are switched each time the button is pressed.

❑ Making a call

- 1 Display the phone control screen. On the <TOP MENU> screen:

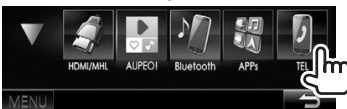

- You can also display the phone control screen by pressing TEL on the monitor panel.

- 2 Select a method to make a call.

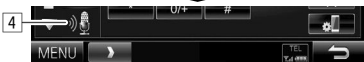

- You can show more items by pressing [▲]/[▼].

- 1 From the phone book*/call lists
- 2 Direct number entry
- 3 From the preset list
 - To preset, see page 41.
- 4 Voice dialing

- You can display the <Bluetooth Setup> screen by pressing [▲]/[▼].

* When the mobile phone is not compatible with Phone Book Access Profile (PBAP), the phone book is not displayed.

From the preset list/phone book/call lists

1



- [★] From the preset list
- [📖] From the phone book
- [📞] From the missed call list
- [📞] From the received call list
- [📞] From the dialed call list

- 2 Select the target (①), then make a call (②).



- You can change the page to display more items by pressing [▲]/[▼].

Continued on the next page...

BLUETOOTH

- To use the A to Z search in the phone book:
When the phone book list is displayed, you can search by initial.



- 2 Select the initial.
- If the initial character is a number, press [1,2,3...] and then select the number.



- 3 Select a phone number from the list.



- To display other phone numbers:
When the phone book list is displayed, you can switch between phone numbers if several phone numbers are registered for the same person.

- 1 Switch the phone number.



- The phone number switches each time [>] is pressed.

- 2 Select a phone number to call.



Direct number entry

You can enter up to 31 numbers.

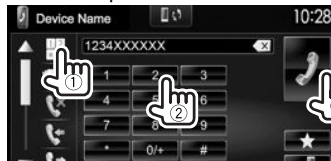

- Press [X] to delete the last entry.
- Press and hold [0/+] to add "+" to the phone number.

Voice dialing

- Available only when the connected mobile phone has a voice recognition system.

- 1 Activate voice dialing.

On the phone control screen:

- Press [▼] repeatedly to change the page on the phone control screen.



- You can also activate voice dialing by holding TEL on the monitor panel.*

- 2 Say the name of the person you want to call.

- If the unit cannot find the target, the following screen appears. Press [Start], then say the name again.



To cancel voice dialing: Press [Cancel].

- * For DDX5015DAB/DDX5015BT/DDX5015BTR: This operation works only when <TEL Key Long Press> is set to [Voice]. (Page 53)

BLUETOOTH

❑ Presetting phone numbers

You can preset up to 5 phone numbers.

- 1 Display the phone control screen.
(Page 39)
- 2 Enter the numbers on the direct number entry screen, then display the preset list.



- 3 Select a preset number to store into.



- To display the preset list, press [★] on the phone control screen.

Using the Bluetooth audio player

- To register a new device, see page 35.
- To connect/disconnect a device, see page 37.

❑ Indications and buttons on the source control screen



- The operation buttons, indications and information displayed on the screen differ depending on the connected device.

Playback information

- 1 Playback status*
- 2 Playing time*
- 3 Tag data (current track title/artist name/album title)*
 - Pressing [<] scrolls the text if not all of the text is shown.
- 4 The signal strength and battery level (only when the information is acquired from the device)

Operation buttons

- [🔊] Displays the easy control screen. (Page 9)
- [⏮] [⏭] • Selects a track. (Press)
• Reverse/forward search.* (Hold)
- [▶] Starts playback.
- [⏸] Pauses playback.
- [MENU] Displays the <TOP MENU> screen.

* Available only for devices compatible with AVRCP 1.3.

BLUETOOTH

Settings for Bluetooth devices

You can change various settings for using Bluetooth devices on the **<Bluetooth Setup>** screen.

- 1 Display the **<Bluetooth Setup>** screen. On the **<TOP MENU>** screen:

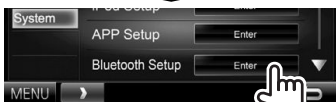

- You can also display the **<Bluetooth Setup>** screen by pressing [] on the phone control screen. (Page 39)



- 2 Configure the Bluetooth settings.



Setting items

<Paired Device List>	Press [Enter] to show the list of registered devices. You can connect a device or delete registered devices. (Page 37)
<PIN Code>	Changes the PIN code of the unit. (Page 36)
<Device Name>	Shows the device name to be shown on the Bluetooth device — DDX**** .
<Device Address>	Shows the device address of the unit.
<Auto Connect>	<ul style="list-style-type: none"> • ON (Initial): A connection is automatically established with the last connected Bluetooth device when the unit is turned on. • OFF: Cancels.
<Bluetooth HF/Audio>	Select the speakers used for Bluetooth (both phone and audio player). <ul style="list-style-type: none"> • Front Only: Front speakers only. • All (Initial): All speakers.
<Auto Response>	<ul style="list-style-type: none"> • ON: The unit answers the incoming calls automatically after 5 seconds. • OFF (Initial): The unit does not answer the calls automatically. Answer the calls manually.

<Auto Pairing>	<ul style="list-style-type: none"> • ON (Initial): Establishes pairing automatically with the connected iOS device (such as iPhone) even if the Bluetooth function is deactivated on the device. (Auto pairing may not work for some devices depending on the iOS version.) • OFF: Cancels.
<Ring Mode>	<ul style="list-style-type: none"> • System (Initial): The ring tone set on the unit is used. • Phone: The ring tone set on the mobile phone is used. (This function may not work depending on the mobile phone.)
<Ring Tone Change>	When <Ring Mode> is set to <System> , select the ring tone for received calls and SMS from [Tone1] (Initial) , [Tone2] , [Tone3] .
<Initialize>	Hold [Enter] to reset all settings you have made for using Bluetooth mobile phones and Bluetooth audio players.

SETTINGS

Settings for using applications of iPod/iPhone/Android

Before using applications of iPod/iPhone/Android such as AUPEO!, select the device to use and connection method.

When connecting the device for first time, the setup screen (for connection, etc.) appears. Follow the procedure on the setup screen to configure the settings.

- 1 Pair the iPod/iPhone/Android device through Bluetooth. (Page 35)
- 2 Display the **<APP Setup>** screen. On the **<TOP MENU>** screen:



- If **[Enter]** for **<APP Setup>** cannot be selected, put the unit in standby. (Page 8)

- 3 Display the **<APP Settings>** screen.



- If you do not need to change the setting, press **[OK]** to exit from the setup screen.

- 5 Select the device type (①), then press **[Next]** (②).



- 6 Select the connection method (①), then press **[Next]** (②).

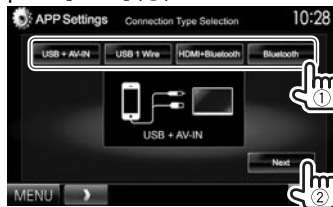

For Android:

<HDMI/MHL + Bluetooth> Select this when the Android is connected both by cable to the HDMI/MHL input terminal and via Bluetooth.

<Bluetooth> Select this when the device is connected via Bluetooth.

For iPod/iPhone:

<USB + AV-IN> Select this when the iPod/iPhone is connected using KCA-iP202 (optional accessory).

<USB 1 Wire> Select this when the iPod/iPhone is connected using KCA-iP102 (optional accessory) or KCA-iP103 (optional accessory).

<HDMI + Bluetooth> Select this when the iPod/iPhone is connected using HDMI cable KCA-HD100 (optional accessory) and KCA-iP103 (optional accessory) through a Lightning-Digital AV adapter (accessory of the iPod/iPhone).

<Bluetooth> Select this when the iPod/iPhone is connected via Bluetooth.

- When selecting **<USB + AV-IN>** or **<USB 1 Wire>**, go to step 8.

- 7 When selecting **<HDMI + Bluetooth>** or **<Bluetooth>** as the connection method, the device selection screen appears. Search for the available iPod/iPhone/Android devices (①), select the target device from the list (②), then press **[Next]**.



- You can change the page to display more items by pressing **[▲]/[▼]**.
- If the device is already listed, skip step ①.
- To stop searching, press **[Cancel]**.

- 8 Confirm the settings.



SETTINGS

Sound adjustment

❑ Using the sound equalization

- The adjustment is memorized for each source until you adjust the sound again. If the source is a disc, the adjustment is stored for each of the following categories.
 - DVD/DVD-VR/VCD
 - CD
 - DivX/MPEG1/MPEG2/MP3/WMA/AAC
- You cannot adjust the sound when the unit is in standby.

Selecting a preset sound mode

- 1 Display the **<Equalizer>** screen.
On the **<TOP MENU>** screen:

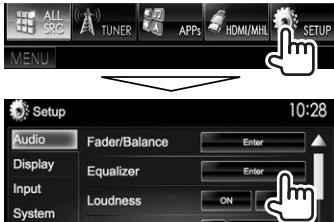

- 2 Select a sound mode.

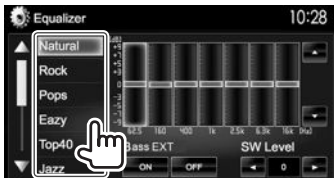

- You can change the page to display more items by pressing [▲]/[▼].

- You can also display the **<Equalizer>** screen by pressing AUD (for DDX7015BT) or by pressing and holding the Volume/ATT/AUDIO knob (for DDX5015DAB/DDX5015BT/DDX5015BTR) on the monitor panel.

Storing your own adjustment—Adjusting the sound precisely

- 1 Select a sound mode. (See the left column.)
- 2 Select a band and adjust the level of the selected band.
 - The number of bands depends on the model.
 - You can adjust the level by dragging the slider or using [▲]/[▼].
 - Repeat this step to adjust the level of other bands.

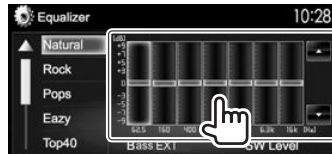

The adjustments are stored and **<User>** is activated.

- 3 Activate (**[ON]**) or deactivate (**[OFF]**) the bass (**<Bass EXT>**) (①), and then adjust the subwoofer level (②).

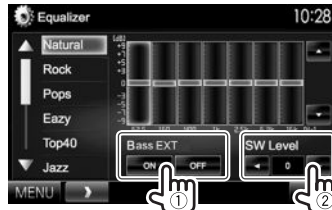

❑ Setting the car type and speakers

- 1 Display the **<Car Setting>** screen.
On the **<TOP MENU>** screen:
 - Press [▼] repeatedly to change the page on the **<Audio>** menu screen.

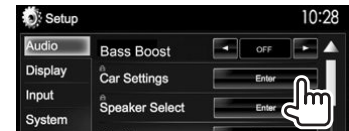
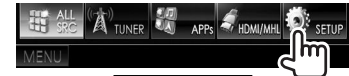

- 2 Select a car type (①), and then select the location of the speakers (②).



SETTINGS

❑ Setting the speakers—speaker size and crossover frequency

1 Display the <Speaker Select> screen.

On the <TOP MENU> screen:

- Press [▼] repeatedly to change the page on the <Audio> menu screen.

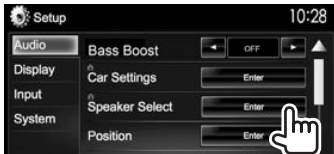

2 Select the speaker type (front speakers, rear speakers, or subwoofer).



3 Select the size of the selected speaker.



4 Adjust the crossover frequency of the selected speaker.

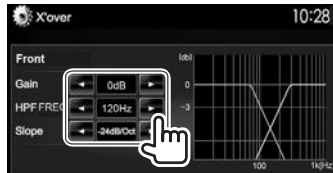

<Gain> Adjusts the output volume of the selected speaker.

<HPF FREQ> Adjusts the crossover frequency for the front or rear speakers (high pass filter).*1

<LPF FREQ> Adjusts the crossover for the subwoofer (low pass filter).*2

<Slope> Adjusts the crossover slope.

<Phase> Selects the phase for the subwoofer.*2

*1 Appears only when the front or rear speakers are selected.

*2 Appears only when the subwoofer is selected.

❑ Setting the listening position

You can adjust the sound effects according to your listening position.

1 Display the <Position> screen.

On the <TOP MENU> screen:

- Press [▼] repeatedly to change the page on the <Audio> menu screen.

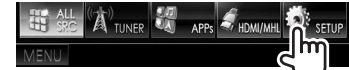

2 Select the listening position ([All], [Front L], [Front R] or [Front All]).



SETTINGS

Adjusting the Digital Time Alignment (DTA)

Make fine adjustments to the delay time of the speaker output to create a more suitable environment for your vehicle.

- 1 Display the **<Position>** screen. (Page 45)
- 2 Display the **<Position DTA>** screen.



- 3 Select the speaker you want to adjust (①), and then adjust each item (②).

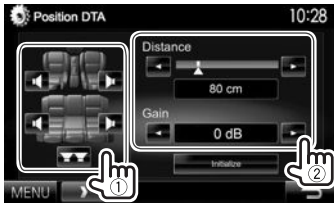

<Distance> Adjusts the Digital Time Alignment (DTA) value.

<Gain> Adjusts the output volume of the selected speaker.

- To determine the adjustment value, see the right column.
- To initialize the setting value, press **[Initialize]**.

Determining the value for <Position DTA> adjustment

If you specify the distance from the center of the currently set listening position to every speaker, the delay time will be automatically computed and set.

- ① Determine the center of the currently set listening position as the reference point.
- ② Measure the distances from the reference point to the speakers.
- ③ Calculate the differences between the distance of the furthest speaker and other speakers.
- ④ Set the DTA value calculated in step ③ for individual speakers.
- ⑤ Adjust gain for individual speakers.

Example: When **[Front All]** is selected as the listening position

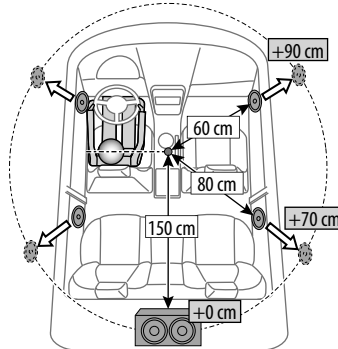

Adjustment for video playback

Adjusting the picture

You can adjust the picture quality.

- 1 Display the adjustment menu.

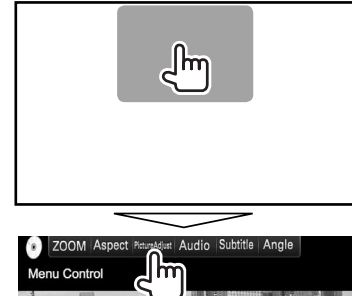

- 2 Select **[DIM ON]** (dimmer on) or **[DIM OFF]** (dimmer off).



SETTINGS

3 Adjust the picture.



- <Bright>** Adjusts the brightness. (-15 to +15)
- <Contrast>** Adjusts the contrast. (-10 to +10)
- <Black>** Adjusts the blackness. (-10 to +10)
- <Color>** Adjusts the color. (-10 to +10)
- <Tint>** Adjusts the tint. (-10 to +10)
- <Sharpness>** Adjusts the sharpness. (-2 to +2)

❑ Changing the aspect ratio





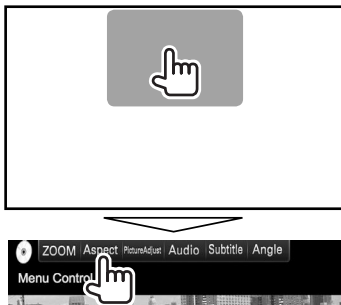

You can change the aspect ratio for video playback.

1 Display the adjustment menu.



2 Select the aspect ratio.



- <Full>*** For 16:9 original pictures
 - 4:3 signal 
 - 16:9 signal 
- <Normal>*** For 4:3 original pictures
 - 4:3 signal 
 - 16:9 signal 
- <Just>** For viewing 4:3 pictures naturally on the wide screen
 - 4:3 signal 
 - 16:9 signal 
- <Zoom1>** –
- <Zoom3>** –
 - The aspect ratio is automatically selected to match the video source.

* While DivX is played back with **<Screen Ratio>** set to [16:9] (Page 15), the aspect ratio may not set correctly.

❑ Zooming the picture

You can zoom the picture. Zooming is available only when discs are played back.

1 Display the adjustment menu.

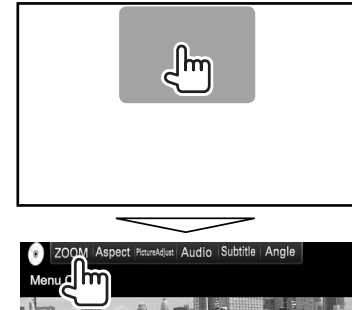

2 Change the magnification (①), then move the zooming frame (②).



- The zoom function cannot be used for some video sources.

SETTINGS

Changing the display design

You can change the background and panel color.

1 Display the **<User Customize>** screen.

On the **<TOP MENU>** screen:

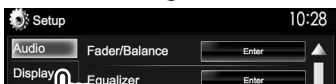

2 Select an item to change (background design: **[Background]**/panel color: **[Panel Color]**).

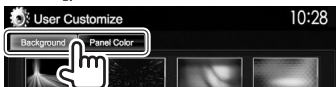

3 Select a background/panel color.
To select a background

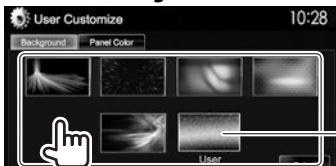

To select a panel color

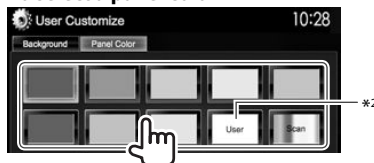

- Selecting **[Scan]** changes the illumination color gradually.

*1 Store your own scene beforehand. (See the right column.)

*2 Store your own color adjustment beforehand. (See below.)

❑ Making your own color adjustment

1 Select **[Panel Color]** on the **<User Customize>** screen. (See the left column.)



3 Select the dimmer setting for the color (①), then adjust the color (②).



❑ Storing your favorite image for the background

You can set your favorite image stored on the connected USB device.

- Use a JPEG/PNG/BMP file with a resolution of 800 x 480 pixels.
- The color of the captured image may look different from that of the actual scene.

1 Connect the USB device on which the image is stored. (Page 59)

2 Display the **<User Customize>** screen. (See the far left column.)

3 Display the file selection screen.

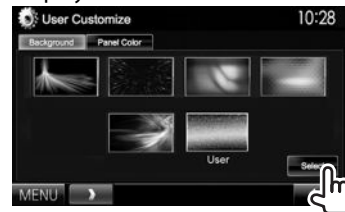

4 Select the folder (①), then the file for the background image in the selected folder (②).

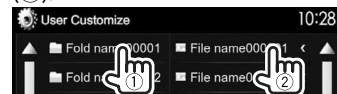

- You can change the page to display more items by pressing **[▲]**/**[▼]**.

A confirmation message appears. Press **[OK]** to store the new image. (The existing image is replaced with the new one.)

SETTINGS

Customizing the <TOP MENU> screen

You can arrange the items to display on the <TOP MENU> screen.

- 1 Display the <Menu Customize> screen. On the <TOP MENU> screen:
 - Press [▼] repeatedly to change the page on the <Display> menu screen.

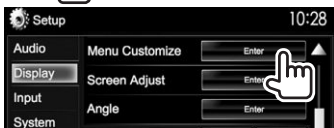
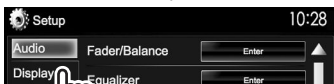

- 2 Select the position to place the icon (①), then select the item you want to display in the selected position (②).



Repeat this step to place icons for other items.

Customizing the system settings

Memorizing/recalling the settings

- You can memorize the settings changed in the <Setup> menu and recall the memorized settings any time.
- The memorized settings are kept even when the unit is reset.

- 1 Display the <SETUP Memory> screen. On the <TOP MENU> screen:
 - Press [▼] repeatedly to change the page on the <System> menu screen.

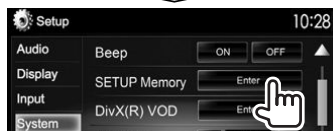

2



- To cancel, press [No].

- 3 Select an operation.



[Recall] Recalls the memorized settings.

[Memory] Memorizes the current settings.

[Clear] Clears the currently memorized settings.

- To cancel, press [Cancel].

A confirmation message appears. Press [Yes].

SETTINGS

❑ Locking the settings

You can lock the settings to prevent them from being changed.

-  is shown beside the settings that can be locked.

1 Display the **<SETUP Memory>** screen.
(Page 49)



To unlock the setting: Press [**Unlock**].

❑ Updating the system

You can update the system by connecting a USB device containing an update file.

- To update the system, visit <http://www2.jvckenwood.com/cs/ce/>.

1 Create an update file, copy it to a USB device, and connect it to the unit.

- To connect a USB device, see page 59.

2 Display the **<System Information>** screen.

On the **<TOP MENU>** screen:

- Press [**▼**] repeatedly to change the page on the **<System>** menu screen.

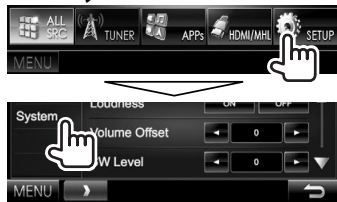

3



<Application Version>

Updates the system application.

<System Version>

Updates the system.

<Bluetooth Version>

Updates the Bluetooth application.

<DAB module Version>*1

Updates the Digital Radio (DAB) module application.

<Vehicle Information>*2

Updates the system of the equipment connected to the External I/F terminal
(Page 60).

It may take a while.

If the update has been completed successfully, "Update Completed" appears. Reset the unit.

- Do not disconnect the USB device while updating.
- If the update has failed, turn the power off and then on, and retry the update.
- Even if you have turned off the power during the update, you can restart the update after the power is turned on. The update will be performed from the beginning.

*1 Only for DDX5015DAB.

*2 Only for DDX7015BT/DDX5015DAB/DDX5015BT.

❑ Adjusting the touch position

You can adjust the touch position on the touch panel if the position touched and the operation performed do not match.

1 Display the **<Touch Panel Adjust>** screen.

On the **<TOP MENU>** screen:

- Press [**▼**] repeatedly to change the page on the **<System>** menu screen.

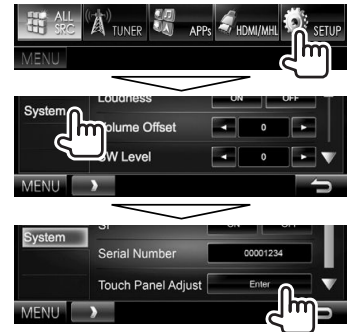

2 Touch the center of the marks at the lower left and at the upper right as instructed.

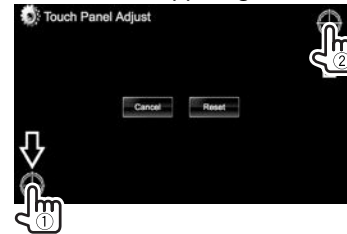

- To reset the touch position, press [**Reset**].
- To cancel the current operation, press [**Cancel**].

SETTINGS

Setting menu items

□ Displaying the <Setup> menu screen

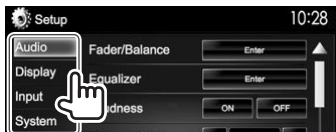

- You can change the page to display more items by pressing [▲]/[▼].
- You cannot change the <Audio> settings screen when [STANDBY] is selected on the <TOP MENU>. (Page 8)

□ <Audio> setting screen

<Fader/Balance>



Fader: Adjust the front and rear speaker output balance.

- **F6 to R6** (Initial: **0**)
 - When using a two-speaker system, set the fader to the center (**0**).

Balance: Adjust the left and right speaker output balance.

- **L6 to R6** (Initial: **0**)
 - Press [▲]/[▼]/[◀]/[▶] or drag [Speaker Icon] to adjust.
 - To clear the adjustment, press [Center].

<Equalizer>

Change the sound mode or adjust and store the equalization for each source. (Page 44)

- **Natural** (Initial)/**Rock/Pops/Easy/Top40/Jazz/Powerful/iPod***1/**User**

<Loudness>

You can activate/deactivate loudness.

- **ON** (Initial): Boost low and high frequencies to produce a well-balanced sound at a low volume level.
- **OFF:** Cancels.

<Volume Offset>

Adjust and store the auto-adjustment volume level for each source. (For discs, the adjustment is stored for each of the following categories: DVD/DVD-VR/VCD, CD, and DivX/MPEG1/MPEG2/WMV/MP3/WMA/AAC.) The volume level will automatically increase or decrease when you change the source.

- **-15 to +6** (Initial: **0**)

<SW Level>

Adjust the subwoofer level.

- **-50 to +10** (Initial: **0**)

<Bass Boost>

Select your preferred bass boost level.

- **OFF** (Initial)/**Level 1/Level 2/Level 3**

<Car Setting>*2

Select a car type and speaker location. (Page 44)

- Car type: **Off** (Initial)/**Compact/Full Size Car/Wagon/Minivan/SUV/Passenger Van**
- **Speaker Location:** Select the location of the speakers in your car.
 - **Front: Door** (Initial)/**On Dash/Under Dash**
 - **Rear***3: **Door/ Rear Deck/2nd Row/3rd Row**

<Speaker Select>*2

Select the speaker size and adjust the crossover frequency. (Page 45)

<Position>

Adjust the sound effects according to your listening position. (Page 45)

<DSP Select>

Select whether to use the Digital Signal Processor (DSP) system.

- **Bypass:** Invalidates all the settings for the DSP.
- **Through** (Initial): Uses the DSP.

<Drive Equalizer>

You can reduce the driving noise by raising the bandwidth.

- **ON** (Initial): Activates the Drive Equalizer.
- **OFF:** Cancels.

*1 Appears only when iPod is selected as the source.

*2 When an item is grayed out, you cannot change the setting. Select [Unlock] on the <SETUP Memory> screen to change the setting. (Page 50)

*3 The initial setting varies depending on the car type setting.

SETTINGS

<Display> setting screen

<Dimmer>

- **Auto** (Initial): Dims the screen and button illumination when you turn on the headlights.
 - The ILLUMI lead connection is required. (Page 58)
- **ON**: Activates dimmer.
- **OFF**: Cancels.
- **NAV**: Activates or deactivates dimmer according to the day/night display setting of the connected navigation unit.

<User Customize>

Change the display design (background and panel color). (Page 48)

<OSD Clock>

- **ON**: Displays the clock while a video source is playing.
- **OFF** (Initial): Cancels.

<Demonstration>

- **ON** (Initial): Activates the demonstration on the screen.
- **OFF**: Cancels.

<Scroll>

- **ON** (Initial): Scrolls the displayed information repeatedly.
- **Once**: Scrolls the displayed information once.
- **OFF**: Cancels.

Pressing [<] scrolls the text regardless of this setting.

<Menu Customize>

Change the items to display on the <TOP MENU> screen. (Page 49)

<Screen Adjust>

Adjust the brightness and blackness of the screen. Press [Enter] to display the setting screen, select [DIM ON] (dimmer on)/[DIM OFF] (dimmer off), then change the following settings:

- **Bright**: Adjusts brightness.
 - **-15 to +15** (Initial: **0** for dimmer on/+**15** for dimmer off)
- **Black**: Adjusts blackness.
 - **-10 to +10** (Initial: **0**)

<Angle>*

Adjust the panel angle. (Page 7)

<Parking Guidelines>

- **ON** (Initial): Displays the parking guidelines. (Page 32)
- **OFF**: Cancels.

<Guidelines Setup>

Adjusts the parking guidelines. (Page 32)

* Only for DDX7015BT.

<Input> setting screen

<R-CAM Interrupt>

- **ON**: Displays the picture from the rear view camera when you shift the gear to the reverse (R) position.
- **OFF** (Initial): Select this when no camera is connected.

<TV Tuner Control>

- **ON**: Enables to control TV operation on the “**AV-IN 1**”.
- **OFF** (Initial): Select this to use “**AV-IN 1**” with the other component than TV Tuner.

<Navigation>*1

Change the navigation settings. (Page 34)

<Vehicle Information>*1 *2

- **ON** (Initial): Activates the vehicle information display function.
- **OFF**: Cancels.

<Beep for parking distance control>*1 *2

- **ON**: Activates a warning tone when the onboard proximity sensor detects a human or object in the vehicle's path while parking.
- **OFF** (Initial): Cancels.

*1 Only for DDX7015BT/DDX5015DAB/DDX5015BT.

*2 The setting is available when a commercial adapter is connected to the External I/F terminal (Page 60). Consult your Kenwood dealer for details.

SETTINGS

☐ <System> setting screen

<Language>

Select the text language used for on-screen information.

- **English** (Initial for DDX7015BT/DDX5015DAB/DDX5015BT)/**Español/Français/Deutsch/Italiano/Nederlands/Ελληνικά/Português/Türkçe/Čeština/Polski/Magyar/Русский** (Initial for DDX5015BTR)/**עברית/العربية/فارسی/தமிழ்/ไทย/ភាសាខ្មែរ/ភាសាខ្មែរ/ភាសាខ្មែរ/ភាសាខ្មែរ**
- **GUI Language**: Select the language used for displaying operation buttons and menu items.
 - **English** (Initial)/**Local** (the language selected above)

<Clock>

Adjust the clock time. (Page 5)

<iPod Setup>

Configure the settings of iPod. (Page 18)

<APP Setup>

- **APP Connection Setup**: Configure the Apps settings. (Page 43)
- **APP Interrupt Volume**: Adjust the App volume.
 - **0** to **35** (Initial: **17**)

<Bluetooth Setup>

Configure settings for using a Bluetooth device, such as connection and other general operations. (Page 42)

<Beep>

- **ON** (Initial): Activates the key-touch tone.
- **OFF**: Cancels.

<SETUP Memory>

You can memorize, recall, or clear the settings you have made. (Page 49)

<DivX(R) VOD>

This unit has its own Registration Code. Once you have played back a file with the Registration Code recorded, this unit's Registration Code is overwritten for copyright protection.

- Press [**Enter**] to display the information.
- To return to the previous screen, press [**OK**].

<TEL Key Long Press>*1

Assigns the function of the TEL button when held.

- **R-CAM**: Displays the picture from the rear view camera. (Page 32)
- **V-OFF**: Turns off the screen. (Page 8)
- **Voice** (Initial): Activates voice dialing. (Page 40)

<AV-OUT>

You can determine the use of the external component connected to the AV-OUT terminal.

- **OFF** (Initial)/**AV-IN1/AV-IN2/DVD**

<AV Key Long Press>

Assigns the function of the AV button when held.

- **AV-OUT** (Initial): Selects the AV source for extra monitors or amplifiers.
- **APPs**: Displays the Apps screen. (Page 21)

<AUD Key Long Press>*2

Assigns the function of the AUD button when held.

- **V-OFF** (Initial): Turns off the screen. (Page 8)
- **R-CAM**: Displays the picture from the rear view camera. (Page 32)

<Security Code>

Register the security code for the unit. (Page 4)

<SI>

Activate or deactivate the security function. (Page 5)

<Serial Number>

Displays the serial number.

<Touch Panel Adjust>

Adjust the touch position of the buttons on the screen. (Page 50)

<Steering Remote Controller>*3

Assign functions to the keys on the remote controller of the steering wheel. (Contact your Kenwood dealer for details.)

<System Information>

Displays the version information of the software. You can update the software. (Page 50)

*1 Only for DDX5015DAB/DDX5015BT/DDX5015BTR.

*2 Only for DDX7015BT.

*3 Only for DDX7015BT/DDX5015DAB/DDX5015BT.

REMOTE CONTROLLER

Overview

Optional Remote Controller KNA-RCDV331 is designed for controlling this unit. Refer to the instruction manual that comes with the remote controller.

⚠ Caution:

- Put the Remote Controller in a place where it will not move during braking or other operations. A dangerous situation could result if the Remote Controller falls down and gets wedged under the pedals while driving.
- Do not leave the battery near fire or under direct sunlight. A fire, explosion or excessive heat generation may result.
- Do not recharge, short, break up or heat the battery, or place it in an open fire. Such actions may cause the battery to leak fluid. If spilled fluid comes in contact with your eyes or clothing, immediately rinse with water and consult a physician.
- Place the battery out of reach of children. In the unlikely event that a child swallows the battery, immediately consult a physician.

❑ Battery installation

Use two "AAA"/"R03"-size batteries. Insert the batteries with the + and - poles aligned properly, following the illustration inside the case.

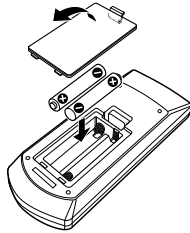

- If the Remote Controller operates only over shorter distances or does not operate at all, it is possible that the batteries are depleted. In such instances, replace both batteries with new ones.

❑ Remote Controller mode switch

The functions operated from the remote controller differ depending on the position of the mode switch.

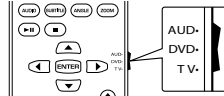

AUD mode: Switch to this mode when controlling a selected source or tuner source, etc.

DVD mode: Switch to this mode when playing DVDs or CDs etc. with the player integrated in this unit.

TV mode: Not used.

- The position of the remote control mode switch is indicated in the title of each mode, e.g., "AUD mode".
- When controlling a player that is not integrated in the unit, select "AUD" mode.

Operations from the remote controller

❑ Common operations (AUD mode)

SRC	<ul style="list-style-type: none">• Selects the source.• Hangs up the incoming/current call.
▲/▼ VOL	Adjusts the volume level.
ATT	Attenuates/restores the sound.
DISP/V.SEL	Switches to the navigation screen.*1
ENTER	Enters options.
☎	Answers incoming calls.
FNC/PBC/MENU	Switches the control screen.
MODE/TOP MENU	Changes the aspect ratio. <ul style="list-style-type: none">• The aspect ratio changes each time you press this key.
OPEN	Adjusts the panel angle.*2 <ul style="list-style-type: none">• The panel angle changes each time you press this key.

*1 Available for DDX7015BT/DDX5015DAB/DDX5015BT only.

*2 Available for DDX7015BT only.

REMOTE CONTROLLER

❑ DVD/VCD (DVD mode)

	Moves the cursor when displaying a menu.
	Selects a track.
	Starts/pauses playback.
	Stops and memorizes the point where the disc stops.
0 – 9	<ul style="list-style-type: none"> Specifies the number to search for in direct search. : Fast forwards/backwards. <ul style="list-style-type: none"> – Fast forward/backward speed changes each time you press this key. : Slow forwards/backwards during pause.
MODE/TOP MENU	Shows the disc top menu.
FNC/PBC/MENU	Shows the disc menu.
SUBTITLE	Changes the subtitle language.
ZOOM	Changes the zoom ratio. <ul style="list-style-type: none"> Zoom ratio changes each time you press this key.
ANGLE	Changes the picture angle. <ul style="list-style-type: none"> Picture angle changes each time you press this key.
AUDIO	Changes the voice language. <ul style="list-style-type: none"> Voice language changes each time you press this key.
DIRECT	Enters direct search mode. (See the far right column.)
CLEAR	Deletes a character while in direct search mode.

❑ Music Disc/Audio file/Video file/Picture file (AUD mode)

AM –/FM +	Selects a folder.
	Selects a track/file.
	Starts/pauses playback.
0 – 9	Specifies the number to search for in direct search.
DIRECT	Enters direct search mode. (See the right column.)
❑ Radio (AUD mode)	
AM –/FM +	Selects the band.
	Searches for stations.
	Changes the seek mode (AUTO1, AUTO2, MANU).
0 – 9	<ul style="list-style-type: none"> Specifies preset number. (–) Specifies the frequency of the station to receive to search for in direct search.
DIRECT	Enters direct search mode. (See the right column.)

❑ Digital Radio (DAB) (AUD mode)*

	Searches for services.
	Changes the seek mode (AUTO1, AUTO2, MANU).
1 – 9	Specifies preset number.

* Only for DD5015DAB.

❑ iPod (AUD mode)

	Selects music/videos.
	Starts/pauses playback.

❑ USB (AUD mode)

AM –/FM +	Selects a folder.
	Selects a file.
	Starts/pauses playback.

Searching for an item (chapter/title/folder/file/track) directly

- Press DIRECT to enter the search mode. Each time you press DIRECT, the item to search for changes.
- Press a number button to select a desired item.
- Press ENTER to confirm the selection.

Searching for a tuner frequency directly

- Press DIRECT to enter the search mode.
- Press number buttons to enter a frequency.
- Press to confirm the entry.

CONNECTION/INSTALLATION

Before installing the unit

⚠ WARNING

- If you connect the ignition wire (red) and the battery wire (yellow) to the car chassis (ground), you may cause a short circuit, that in turn may start a fire. Always connect those wires to the power source running through the fuse box.
- Do not cut out the fuse from the ignition wire (red) and the battery wire (yellow). The power supply must be connected to the wires via the fuse.

⚠ Precautions on installation and connection

- Mounting and wiring this product requires skills and experience. For best safety, leave the mounting and wiring work to professionals.
- Make sure to ground the unit to a negative 12 V DC power supply.
- Do not install the unit in a spot exposed to direct sunlight or excessive heat or humidity. Also avoid places with too much dust or the possibility of water splashing.
- Do not use your own screws. Use only the screws provided. If you use the wrong screws, you could damage the unit.
- If the power is not turned on ("Miswiring DC Offset Error", "Warning DC Offset Error" is displayed), the speaker wire may have a short circuit or have touched the chassis of the vehicle and the protection function may have been activated. Therefore, the speaker wire should be checked.

- If your car's ignition does not have an ACC position, connect the ignition wires to a power source that can be turned on and off with the ignition key. If you connect the ignition wire to a power source with a constant voltage supply, such as with battery wires, the battery may be drained.
- Only for DDX7015BT:
If the console has a lid, make sure to install the unit so that the monitor panel will not hit the lid when closing and opening.
- If the fuse blows, first make sure the wires are not touching to cause a short circuit, then replace the old fuse with one with the same rating.
- Insulate unconnected wires with vinyl tape or other similar material. To prevent a short circuit, do not remove the caps on the ends of the unconnected wires or the terminals.
- Connect the speaker wires correctly to the terminals to which they correspond. The unit may be damaged or fail to work if you share the ⊖ wires or ground them to any metal part in the car.
- When only two speakers are being connected to the system, connect both connectors either to the front output terminals or to the rear output terminals (do not mix front and rear). For example, if you connect the ⊕ connector of the left speaker to a front output terminal, do not connect the ⊖ connector to a rear output terminal.
- After the unit is installed, check whether the brake lamps, blinkers, wipers, etc. on the car are working properly.
- Mount the unit so that the mounting angle is 30° or less.
- Do not press hard on the panel surface when installing the unit to the vehicle. Otherwise scratches, damage, or failure may result.

- This unit has a cooling fan to decrease the internal temperature. Do not mount the unit in a place where the cooling fan of the unit is blocked. Blocking these openings will prevent the cooling of the internal temperature and result in malfunction.

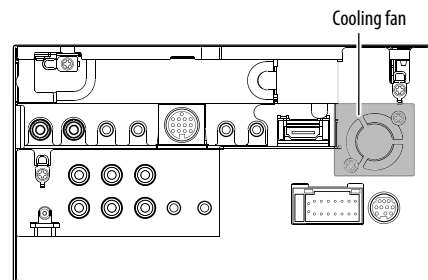

⚠ CAUTION

Install this unit in the console of your vehicle. Do not touch the metal part of this unit during and shortly after the use of the unit. Metal parts such as the heat sink and enclosure become hot.

CONNECTION/INSTALLATION

❑ Supplied accessories for installation

- ① Wiring harness x 1
- ② Trim plate x 1
- ③ Extension wire (2 m) x 1
- ④ Extraction keys x 2
- ⑤ Microphone (3 m) x 1
- ⑥ Fixture for HDMI/MHL connector x 1
- ⑦ Screws for fixture (M2.6 x 6 mm) x 1

❑ Installation procedure

- 1 To prevent a short circuit, remove the key from the ignition and disconnect the \ominus battery.
- 2 Make the proper input and output wire connections for each unit.
- 3 Connect the speaker wires of the wiring harness.
- 4 Take Connector B on the wiring harness and connect it to the speaker connector in your vehicle.
- 5 Take Connector A on the wiring harness and connect it to the external power connector in your vehicle.
- 6 Connect the wiring harness connector to the unit.
- 7 Install the unit in your car.
 - Make sure that the unit is installed securely in place. If the unit is unstable, it may malfunction (eg, the sound may skip).
- 8 Reconnect the \ominus battery.
- 9 Press the reset button.
- 10 Configure **<Initial Setup>**. (Page 4)

Installing the unit

❑ Installing the unit

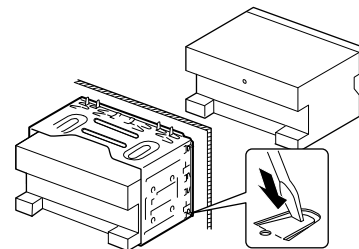

- Bend the tabs of the mounting sleeve with a screwdriver or similar utensil and attach it in place.

❑ Installing the trim plate

Attach the trim plate (②).

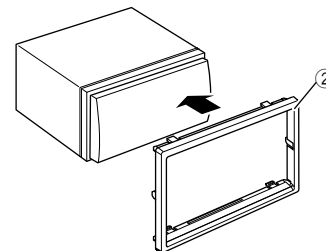

CONNECTION/INSTALLATION

Connection

Connecting wires to terminals

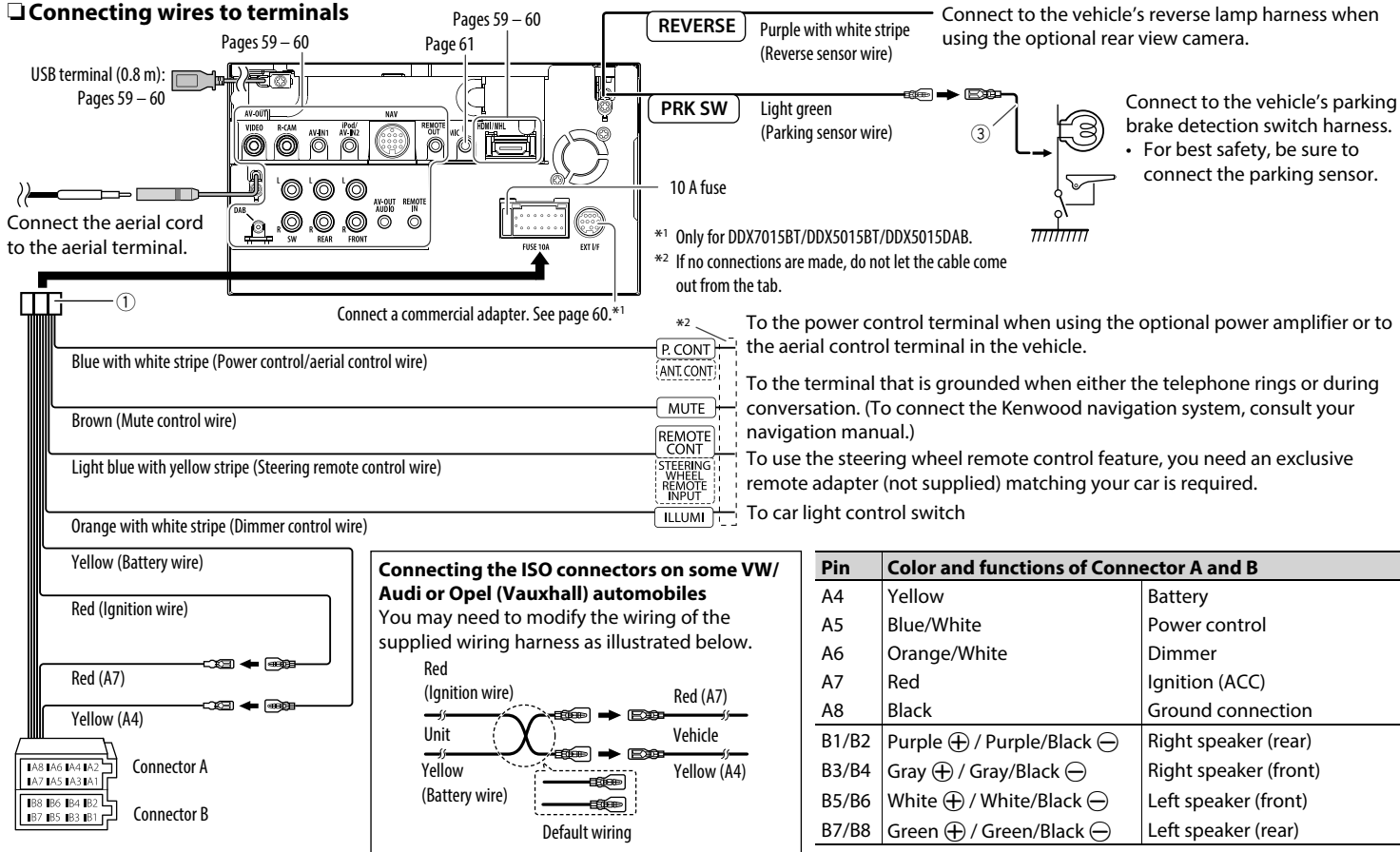

CONNECTION/INSTALLATION

❑ Connecting a USB device

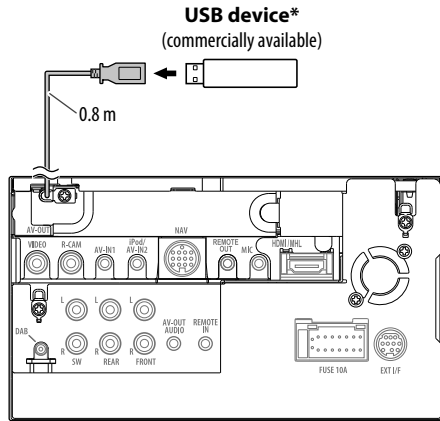

* Use CA-U1EX for extending the cable if necessary. (Max 500 mA, 5V)

❑ Connecting an iPod/iPhone

iPod/iPhone except for iPod nano (7th Generation)/iPod touch (5th Generation)/iPhone 5S/iPhone 5C/iPhone 5
(commercially available)

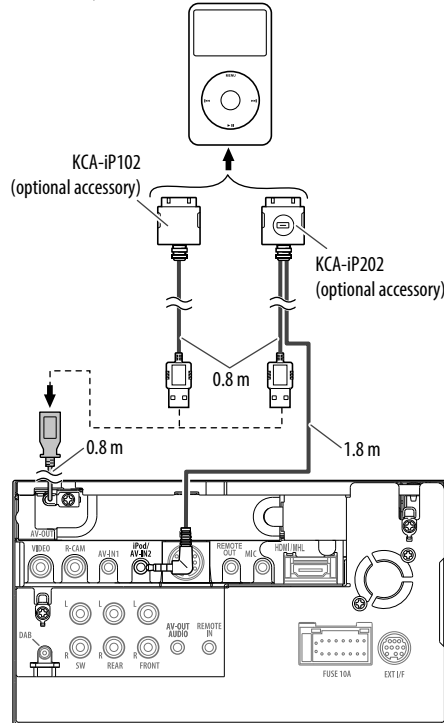

iPod nano (7th Generation)/iPod touch (5th Generation)/iPhone 5S/iPhone 5C/iPhone 5
(commercially available)

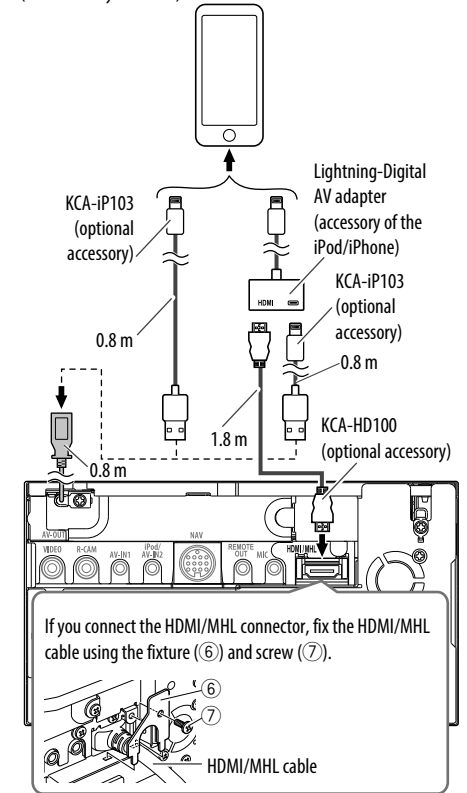

CONNECTION/INSTALLATION

Connecting a Smartphone

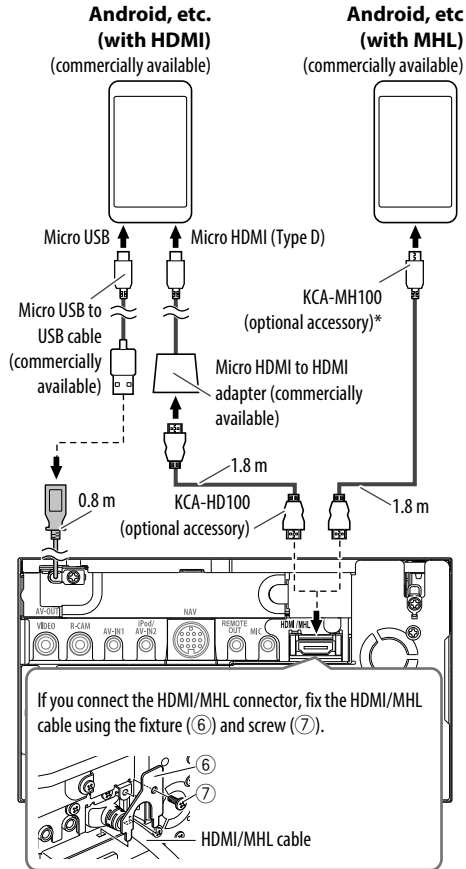

* Use conversion adapter to connect to smartphones if necessary.

Connecting the Miracast Dongle to use smartphone/iPod/iPhone over a wireless connection

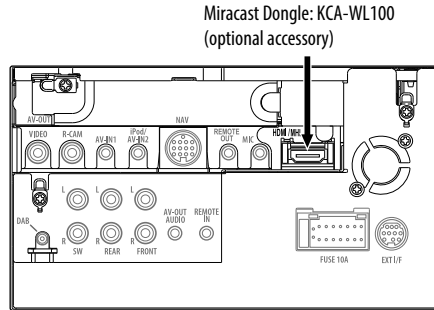

Connecting external components

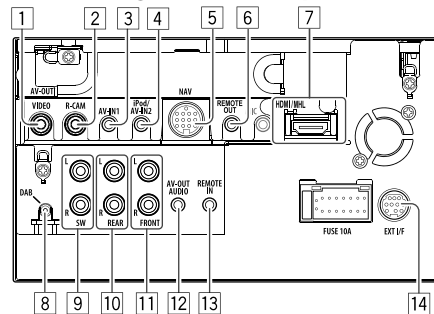

- 1 AV-OUT/Video output (Yellow)
- 2 Rear view camera input (Yellow)
- 3 Audio Video input (AV-IN1)*1
- 4 iPod/Audio Visual input (iPod/AV-IN2)*1
- 5 NAVI I/F input*2
- 6 TV tuner remote control output
- 7 HDMI/MHL input
- 8 DAB aerial input*3
- 9 Subwoofer preout (monaural output)*4
 - Subwoofer left output (White)
 - Subwoofer right output (Red)
- 10 Rear preout*4
 - Audio left output (White)
 - Audio right output (Red)
- 11 Front preout*4
 - Audio left output (White)
 - Audio right output (Red)
- 12 Audio output (ø3.5 mini jack)
- 13 Resistance-free stereo type mini plug
- 14 External I/F for connecting a commercial adapter (DC 12 V = 500 mA max)*2

*1 When connecting the component to play on "AV-IN1" or "AV-IN2", use the Audio and Video cable CA-C3AV (optional accessory).

*2 Only for DDX7015BT/DDX5015BT/DDX5015DAB.

*3 Only for DDX5015DAB. To use the digital radio, connect CX-DAB1 (optional accessory).

*4 When connecting an external amplifier, connect its ground wire to the chassis of the car; otherwise the unit may be damaged.

CONNECTION/INSTALLATION

❑ Connecting microphone for Bluetooth

Connect the microphone (5) to MIC terminal.

- To install the microphone, peel off the adhesive tape, fix on the installation position, then adjust the direction of the microphone to face the driver. After installing, fix the microphone cable to the car with clamps (commercially available).

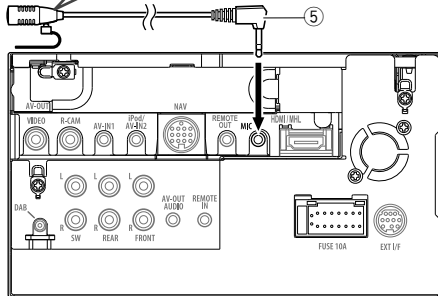
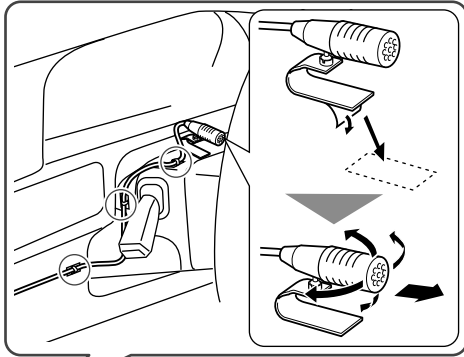

Removing the unit

❑ Removing the trim plate

- 1 Engage the catch pins on the extraction key (4) and remove the two locks on the lower part. Lower the frame and pull it forward.

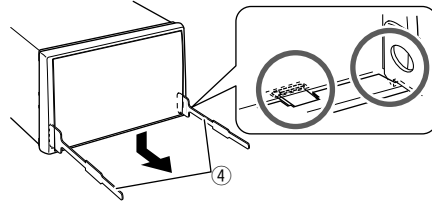

- 2 Remove the upper two locations.

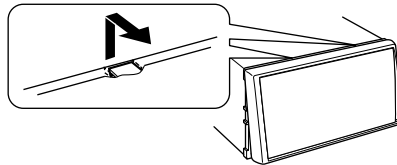

- The frame can be removed from the top side in the same manner.

❑ Removing the unit

- 1 Remove the trim plate. (See the left column.)
- 2 Insert the two extraction keys (4), then pull them as illustrated so that the unit can be removed.

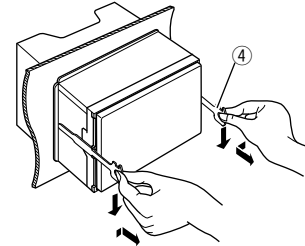

- Be careful to avoid injury from the catch pins on the extraction key.

REFERENCES

Maintenance

❑ Caution on cleaning the unit

Do not use any solvent (for example, thinner, benzine, etc.), detergent, or insecticide. This may damage the monitor or the unit.

Recommended cleaning method:

Gently wipe the panel with a soft, dry cloth.

❑ Moisture condensation

Moisture may condense on the lens inside the unit in the following cases:

- After starting the heater in the car.
- If it becomes very humid inside the car.

Should this occur, the unit may malfunction. In this case, eject the disc and leave the unit turned on for a few hours until the moisture evaporates.

❑ How to handle discs

- When removing a disc from its case, press down the center holder of the case and lift the disc out, holding it by the edges.



- Always hold the disc by the edges. Do not touch its recording surface.
- When storing a disc in its case, gently insert the disc around the center holder (with the printed surface facing up).
 - Make sure to store discs in their cases after use.

❑ To keep discs clean

Dirty discs may not play correctly.

If a disc does become dirty, wipe it with a soft cloth in a straight line from the center to the edge.



- Do not use any solvents (for example, conventional record cleaner, spray, thinner, benzine, etc.) to clean discs.

❑ To play new discs

New discs may have some rough spots around the inner and outer edges. If such a disc is used, this unit may reject the disc.



- To remove these rough spots, rub the edges with a pencil or ball-point pen, etc.

More information

❑ File playback

Playing DivX files (for discs only)

- This unit can play back DivX files with the extension code <.divx>, <.div>, or <.avi> (regardless of the letter case—upper/lower).
- Audio streams should conform to MP3 or Dolby Digital.
- Files encoded in the interlaced scanning mode may not be played back correctly.
- The maximum bit rate for video signals (average) is 8 Mbps.

Playing MPEG1/MPEG2 files

- This unit can play back MPEG1/MPEG2 files with the extension code <.mpg> or <.mpeg>.
- The stream format should conform to MPEG system/program stream.
The file format should be MP@ML (Main Profile at Main Level)/SP@ML (Simple Profile at Main Level)/MP@LL (Main Profile at Low Level).
- Audio streams should conform to MPEG1 Audio Layer-2 or Dolby Digital.

Playing JPEG/BMP/PNG files (for USB only)

- This unit can play back picture files with the extension code <.jpg>, <.jpeg>, <.bmp> or <.png>.
- This unit can play back files that are at 32 x 32 to 8 192 x 7 680 resolution.
It may take time to display the file depending on its resolution.
- This unit can play back baseline JPEG files. Progressive JPEG files or lossless JPEG files cannot be played.

REFERENCES

Playing audio files (for discs: MP3/WMA/AAC, for USB: MP3/WMA/WAV/AAC/FLAC)

- This unit can play back files with the extension code <.mp3>, <.wma>, <.wav>, <.m4a> or <.flac> (regardless of the letter case—upper/lower).
- This unit can play back files that meet the conditions below:
 - Bit rate:
 - MP3: 8 kbps – 320 kbps
 - WMA: 48 kbps – 192 kbps
 - AAC: For discs: 16 kbps – 320 kbps
For USB: 32 kbps – 320 kbps
 - Sampling frequency:
 - MP3: 8 kHz – 48 kHz
 - WMA: For discs: 32 kHz – 48 kHz
For USB: 8 kHz – 48 kHz
 - WAV: 44.1 kHz
 - AAC: 16 kHz – 48 kHz
 - FLAC : 8 kHz – 48 kHz
- This unit can show ID3 Tag Version 1.0/1.1/2.2/2.3/2.4 (for MP3).
- This unit can also show WMA/AAC/FLAC Tag.
- This unit can play back files recorded in VBR (variable bit rate).
- Files recorded in VBR have a discrepancy in elapsed time indication.

- This unit cannot play back the following files:
 - MP3 files encoded with MP3i and MP3 PRO format.
 - MP3 files encoded with Layer 1/2.
 - WMA files encoded with lossless, professional, and voice format.
 - WMA files which are not based upon Windows Media® Audio.
 - WMA/AAC files copy-protected with DRM.
 - AAC files encoded using any other application than iTunes.
 - AAC files copy-protected with FairPlay (except those stored on an iPod).
 - Files which have data such as AIFF, ATRAC3, etc.
- This unit can display jacket pictures that meet the conditions below:
 - Picture size: 32 x 32 to 1 232 x 672 (PNG: 800 x 480) resolution
 - Data size: less than 650 KB.
 - File type: JPEG/PNG/BMP

Playing H.264/WMV files (for USB only)

- This unit can play back files with the extension code <.mp4>, <.wmv>, <.avi> or <.mkv>.
- This unit can only play back files which are less than 2 GB.
- The stream format should conform to MPEG system/program stream.

Disc playback

Playable disc types

Disc type	Recording format, file type, etc.
DVD	DVD Video*1
<ul style="list-style-type: none"> DTS sound cannot be reproduced or emitted from this unit. 	
DVD Recordable/Rewritable (DVD-R/-RW*2, +R/+RW*3)	<ul style="list-style-type: none"> DVD Video DVD-VR*4 DivX/MPEG1/MPEG2 MP3/WMA/AAC
<ul style="list-style-type: none"> DVD Video: UDF bridge DVD-VR DivX/MPEG1/MPEG2/MP3/WMA/AAC: ISO 9660 level 1, level 2, Romeo, Joliet 	
Dual Disc	DVD side
CD/VCD	<ul style="list-style-type: none"> VCD (Video CD) Audio CD/CD Text (CD-DA)
CD Recordable/Rewritable (CD-R/-RW)	<ul style="list-style-type: none"> VCD (Video CD) CD-DA MPEG1/MPEG2 MP3/WMA/AAC

*1 DVD Region code:

For DDX7015BT/DDX5015DAB/DDX5015BT: 2

For DDX5015BTR: 5

If you insert a DVD Video disc of an incorrect Region Code, "Region Code Error" appears on the screen.

*2 DVD-R recorded in multi-border format are also playable (except for dual layer discs). DVD-RW dual layer discs are not playable.

*3 It is possible to play back finalized +R/+RW (Video format only) discs. "DVD" is selected as the disc type when a +R/+RW disc is loaded. +RW double layer discs are not playable.

*4 This unit cannot play back content protected with CPRM.

Continued on the next page...

REFERENCES

Unplayable discs

- Unplayable disc types and formats are as follows:
 - DVD-Audio/DVD-ROM discs
 - MPEG4/JPEG/FLAC/MKV/DVD+VR/DVD-RAM recorded on DVD-R/RW or +R/+RW
 - SVCD (Super Video CD), CD-ROM, CD-I (CD-I Ready), DTS-CD
 - MPEG4/JPEG/FLAC/MKV recorded on CD-R/RW
- Discs that are not round.
- Discs with coloring on the recording surface or discs that are dirty.
- Recordable/Rewritable discs that have not been finalized.
- 8 cm discs. Attempting to insert these discs using an adapter may cause a malfunction.

DualDisc playback

The Non-DVD side of a “DualDisc” does not comply with the “Compact Disc Digital Audio” standard. Therefore, the use of the Non-DVD side of a DualDisc on this product cannot be recommended.

Playing Recordable/Rewritable discs

- This unit can recognize a total of 64 770 files and 254 folders (a maximum of 255 files per folder).
- Use only “finalized” discs.
- This unit can play back multi-session discs; however, unclosed sessions will be skipped while playing.
- Some discs or files may not be played back due to their characteristics or recording conditions.

□ About data stored in the connected USB device/iPod/iPhone

- We bear no responsibility for any loss of data in iPod/iPhone and USB mass storage class devices while using this unit.

□ USB playback

Playable files on a USB device

- This unit can play the following types of files stored in a USB mass storage class device.
 - JPEG/BMP/PNG/MPEG1/MPEG2/MP3/WMA/WAV/AAC/FLAC/H.264/WMV (VC-1)
- This unit can recognize a total of 5 000 files and 250 folders (a maximum of 999 files per folder).
- Make sure all important data has been backed up to avoid losing the data.

Notes on using a USB device:

- This unit may not play back files in a USB device properly when using a USB extension cable.
- USB devices equipped with special functions such as data security functions cannot be used with the unit.
- Do not use a USB device with 2 or more partitions.
- Depending on the shape of the USB devices and connection ports, some USB devices may not be attached properly or the connection might be loose.
- This unit may not recognize a memory card inserted into the USB card reader.
- When connecting with a USB cable, use the USB 2.0 cable.

- The maximum number of characters (when the characters are 1 byte):
 - Folder names: 128 characters
 - File names: 128 characters
- Avoid using the USB device if it might affect driving safety.
- Do not pull out and connect the USB device repeatedly while “Reading” is shown on the screen.
- Electrostatic shock at connecting a USB device may cause abnormal playback of the device. In this case, disconnect the USB device then reset this unit and the USB device.
- Operation and power supply may not work as intended for some USB devices.
- Do not leave a USB device in the car, or expose to direct sunlight or high temperatures to prevent deformation or damage to the device.

REFERENCES

❑ Notes on playing iPod/iPhone

- iPod/iPhone that can be connected to this unit:
Made for
 - iPod with video
 - iPod classic
 - iPod nano (7th Generation)
 - iPod nano (6th Generation)
 - iPod nano (5th Generation)
 - iPod nano (4th Generation)
 - iPod nano (3rd Generation)
 - iPod touch (5th Generation)
 - iPod touch (4th Generation)
 - iPod touch (3rd Generation)
 - iPod touch (2nd Generation)
 - iPod touch (1st Generation)
 - iPhone 5S
 - iPhone 5C
 - iPhone 5
 - iPhone 4S
 - iPhone 4
 - iPhone 3GS
 - iPhone 3G
 - iPhone
- When operating an iPod/iPhone, some operations may not be performed correctly or as intended. In this case, visit the following KENWOOD web site: <www.kenwood.com/cs/ce/ipod>
- For some iPod/iPhone models, the performance may be abnormal or unstable during operation. In this case, disconnect the iPod/iPhone device, then check its condition.
If the performance is not improved or slow, reset your iPod/iPhone.
- When you turn on this unit, the iPod/iPhone is charged through the unit.
- The text information may not be displayed correctly.

❑ Language codes (for DVD/DVD-VR language selection)

AA	Afar	GL	Galician	MI	Maori	SO	Somali
AB	Abkhazian	GN	Guarani	MK	Macedonian	SQ	Albanian
AF	Afrikaans	GU	Gujarati	ML	Malayalam	SR	Serbian
AM	Ameharic	HA	Hausa	MN	Mongolian	SS	Siswati
AR	Arabic	HI	Hindi	MO	Moldavian	ST	Sesotho
AS	Assamese	HR	Croatian	MR	Marathi	SU	Sundanese
AY	Aymara	HU	Hungarian	MS	Malay (MAY)	SW	Swahili
AZ	Azerbaijani	HY	Armenian	MT	Maltese	TA	Tamil
BA	Bashkir	IA	Interlingua	MY	Burmese	TE	Telugu
BE	Byelorussian	IE	Interlingue	NA	Nauru	TG	Tajik
BG	Bulgarian	IK	Inupiak	NE	Nepali	TH	Thai
BH	Bihari	IN	Indonesian	NO	Norwegian	TI	Tigrinya
BI	Bislama	IS	Icelandic	OC	Occitan	TK	Turkmen
BN	Bengali, Bangla	IW	Hebrew	OM	(Afan) Oromo	TL	Tagalog
BO	Tibetan	JA	Japanese	OR	Oriya	TN	Setswana
BR	Breton	JL	Yiddish	PA	Panjabi	TO	Tonga
CA	Catalan	JW	Javanese	PL	Polish	TR	Turkish
CO	Corsican	KA	Georgian	PS	Pashto, Pushto	TS	Tsonga
CS	Czech	KK	Kazakh	QU	Quechua	TT	Tatar
CY	Welsh	KL	Greenlandic	RM	Rhaeto-Romance	TW	Twi
DZ	Bhutani	KM	Cambodian	RN	Kirundi	UK	Ukrainian
EL	Greek	KN	Kannada	RO	Rumanian	UR	Urdu
EO	Esperanto	KO	Korean (KOR)	RW	Kinyarwanda	UZ	Uzbek
ET	Estonian	KS	Kashmiri	SA	Sanskrit	VI	Vietnamese
EU	Basque	KU	Kurdish	SD	Sindhi	VO	Volapuk
FA	Persian	KY	Kirghiz	SG	Sangho	WO	Wolof
FI	Finnish	LA	Latin	SH	Serbo-Croatian	XH	Xhosa
FJ	Fiji	LN	Lingala	SI	Singhalese	YO	Yoruba
FO	Faroese	LO	Laothian	SK	Slovak	ZU	Zulu
FY	Frisian	LT	Lithuanian	SL	Slovenian		
GA	Irish	LV	Latvian, Lettish	SM	Samoan		
GD	Scots Gaelic	MG	Malagasy	SN	Shona		

REFERENCES

Error message list

If an error occurs while using the unit, a message appears. Take appropriate action according to the following message/remedy/cause list.

“No Signal”/“No Video Signal”:

- Start playback on the external component connected to the AV-IN1 or iPod/AV-IN2 input terminal.
- Start playback on the smartphone connected to HDMI/MHL input terminal.
- Check the cords and connections.
- Signal input is too weak.

“Miswiring DC Offset Error”/“Warning DC Offset Error”:

- A speaker cord has shorted or it has come into contact with the car chassis. Wire or insulate the speaker cord as appropriate, then reset the unit. (Pages 3 and 58)

“Parking off”:

- No playback picture is shown when the parking brake is not engaged.

“Authorization Error”:

- Check whether the connected iPod/iPhone is compatible with this unit. (Page 65)

“USB Device Error”:

- The USB power voltage is abnormal.
- Turn off and turn on the unit.
- Connect another USB device.

“Panel Mecha Error”:

- The panel does not work properly. Reset the unit.

“No Navigation”:

- No navigation unit is connected.

“Connection Error”:

- The device is registered but the connection has failed. Connect the registered device. (Page 37)

“Please Wait...”:

- The unit is preparing to use the Bluetooth function. If the message does not disappear, turn off and turn on the unit, then connect the device again (or reset the unit).

“No Voice Device”:

- The connected mobile phone does not have a voice recognition system.

“No Data”:

- No phone book data is contained in the connected Bluetooth phone.

“Initialize Error”:

- The unit has failed to initialize the Bluetooth module. Try the operation again.

“Dial Error”:

- Dialing has failed. Try the operation again.

“Hung Up Error”:

- The call has not ended yet. Park your car, and use the connected mobile phone to end the call.

“Pick Up Error”:

- The unit has failed to receive a call.

“Antenna Error”:

- The aerial has a short-circuit and the protective circuit has activated.
- Check the Digital Radio aerial. If a passive aerial without a booster is used, set aerial power to “OFF”.

Troubleshooting

What appears to be trouble is not always serious. Check the following points before calling a service center.

- For operations with the external components, refer also to the instructions supplied with the adapters used for the connections (as well as the instructions supplied with the external components).

□ General

No sound comes out of the speakers.

- Adjust the volume to the optimum level.
- Check the cords and connections.

No picture is displayed on the screen.

- Turn on the screen. (Page 8)

The unit does not work at all.

- Reset the unit. (Page 3)

The remote controller* does not work.

- Replace the battery.

* Purchase KNA-RCDV331 separately.

REFERENCES

❑ Discs

Recordable/Rewritable discs cannot be played back.

- Insert a finalized disc.
- Finalize the discs with the component which you used for recording.

Tracks on the Recordable/Rewritable discs cannot be skipped.

- Insert a finalized disc.
- Finalize the discs with the component which you used for recording.

Playback does not start.

- The format of files is not supported by the unit.

No picture appears on the external monitor.

- Connect the video cord correctly.
- Select the correct input on the external monitor.

DivX/MPEG1/MPEG2/MP3/WMA/AAC discs cannot be played back.

- Record the tracks using a compatible application on the appropriate discs. (Page 63)
- Add appropriate extension codes to the file names.

Tracks on the Recordable/Rewritable discs are not played back as you have intended them to play.

- Playback order may differ from the one played back using other players.

❑ USB

“Reading” does not disappear from the screen.

- Turn the power off and on again.

While playing a track, sound is sometimes interrupted.

- The tracks are not properly copied into the USB device. Copy the tracks again, and try again.

Tracks are not played back as you have intended them to play.

- Playback order may differ from the one played back using other players.

❑ iPod/iPhone

No sound comes out of the speakers.

- Disconnect the iPod/iPhone, then connect it again.
- Select another source, then reselect “iPod”.

The iPod/iPhone does not turn on or does not work.

- Check the connecting cable and its connection.
- Update the firmware version.
- Charge the battery.
- Reset the iPod/iPhone.

Sound is distorted.

- Deactivate the equalizer either on this unit or the iPod/iPhone.

A lot of noise is generated.

- Turn off (uncheck) “VoiceOver” on the iPod/iPhone. For details, visit <<http://www.apple.com>>.

No operations are available when playing back a track containing artwork.

- Operate the unit after the artwork has loaded.

Videos cannot be played.

- Connect with USB Audio and Video cable KCA-iP202 for iPod/iPhone except for iPod nano (7th Generation)/iPod touch (5th Generation)/iPhone 5S/iPhone 5C/iPhone 5 or KCA-HD100 and KCA-iP103 through a Lightning-Digital AV adapter for iPod nano (7th Generation)/iPod touch (5th Generation)/iPhone 5S/iPhone 5C/iPhone 5. Other cables cannot be used.

No sound of videos comes out.

- Connect with USB Audio and Video cable KCA-iP202 for iPod/iPhone except for iPod nano (7th Generation)/iPod touch (5th Generation)/iPhone 5S/iPhone 5C/iPhone 5 or KCA-HD100 and KCA-iP103 through a Lightning-Digital AV adapter for iPod nano (7th Generation)/iPod touch (5th Generation)/iPhone 5S/iPhone 5C/iPhone 5. Other cables cannot be used.

❑ Tuner

AME automatic presetting does not work.

- Store stations manually. (Page 25)

Static noise while listening to the radio.

- Connect the aerial firmly.

REFERENCES

❑ **Digital Radio (DAB) (only for DDX5015DAB)**

Cannot receive an ensemble.

- Your area is not covered by the ensemble.

The DAB aerial is not properly extended or positioned.

- Adjust the aerial and try the ensemble scanning again.
- Connect an active aerial (not supplied).

❑ **AV-IN1/AV-IN2**

No picture appears on the screen.

- Turn on the video component if it is not on.
- Connect the video component correctly.

❑ **AUPEO!**

The application does not work.

- The application on your iPod touch/iPhone/Android is not the latest version. Update the application.

❑ **Bluetooth**

Phone sound quality is poor.

- Reduce the distance between the unit and the Bluetooth mobile phone.
- Move the car to a place where you can get a better signal reception.

The sound is interrupted or skipped while using a Bluetooth audio player.

- Reduce the distance between the unit and the Bluetooth audio player.
- Disconnect the device connected for Bluetooth phone.
- Turn off, then turn on the unit.
(When the sound is not yet restored) connect the player again.

The connected audio player cannot be controlled.

- Check whether the connected audio player supports AVRCP (Audio Video Remote Control Profile).

The Bluetooth device does not detect the unit.

- Search from the Bluetooth device again.

The unit does not pair with the Bluetooth device.

- For devices compatible with Bluetooth 2.1: Register the device using a PIN code. (Page 36)
- For devices compatible with Bluetooth 2.0: Enter the same PIN code for both the unit and target device. If the PIN code of the device is not indicated in its instructions, try "0000" or "1234."
- Turn off, then turn on the Bluetooth device.

Echo or noise occurs.

- Adjust the microphone unit position.
- Adjust the echo volume or noise reduction volume. (Page 38)

The unit does not respond when you try to copy the phone book to the unit.

- You may have tried to copy the same entries (as stored) to the unit.

REFERENCES

Specifications

❑ Monitor section

Picture Size (W x H)

DDX7015BT: 6.95 inches (diagonal) wide
156.6 mm × 81.6 mm

DDX5015DAB/DDX5015BT/DDX5015BTR:
6.2 inches (diagonal) wide
137.5 mm × 77.2 mm

Display System Transparent TN LCD panel

Drive System TFT active matrix system

Number of Pixels 1 152 000 (800H × 480V × RGB)

Effective Pixels 99.99%

Pixel Arrangement

RGB striped arrangement

Back Lighting LED

❑ DVD player section

D/A Converter 24 bit

Audio Decoder Linear PCM/Dolby Digital/MP3/
WMA/AAC

Video Decoder MPEG1/MPEG2/DivX

Wow & Flutter Below Measurable Limit

Frequency Response

96 kHz Sampling: 20 Hz to 20 000 Hz

48 kHz Sampling: 20 Hz to 20 000 Hz

44.1 kHz Sampling: 20 Hz to 20 000 Hz

Total Harmonic Distortion

0.010% (1 kHz)

Signal to Noise Ratio

94 dB (DVD-Video 96 kHz)

Dynamic Range 91 dB (DVD-Video 96 kHz)

Disc Format DVD-Video/DVD-VR/VIDEO-CD/
CD-DA

Sampling Frequency

44.1 kHz/48 kHz/96 kHz

Quantifying Bit Number

16/20/24 bit

❑ USB interface section

USB Standard USB 2.0 High Speed

File System FAT 16/32

Maximum Power Supply Current
DC 5 V ≐ 1 A

D/A Converter 24 bit

Audio Decoder MP3/WMA/AAC/WAV/FLAC

Video Decoder MPEG1/MPEG2/H.264/WMV/
JPEG/BMP/PNG

❑ HDMI interface section

Connector Type TYPE-A

❑ MHL interface section

Supported Version

MHL 2

Maximum Power Supply Current

DC 5 V ≐ 900 mA

❑ Bluetooth section

Technology Bluetooth 3.0 + EDR

Frequency 2.402 GHz to 2.480 GHz

Output Power +4 dBm (MAX), 0 dBm (AVE),
Power Class 2

Maximum Communication Range

Line of sight approx. 10 m

Audio Codec SBC/AAC/MP3

Profile

HFP (Hands Free Profile)

A2DP (Advanced Audio
Distribution Profile)

AVRCP (Audio/Video Remote
Control Profile)

GAP (Generic Access Profile)

PBAP (Phonebook Access Profile)

SDP (Service Discovery Profile)

SPP (Serial Port Profile)

REFERENCES

❑ DSP section

Graphics equalizer

BAND	7 Band
Frequency (Hz) (BAND1-7)	62.5/160/400/1k/2.5k/6.3k/16k
Gain	-9/-8/-7/-6/-5/-4/-3/-2/ -1/0/1/2/3/4/5/6/7/8/9 dB

2 Way X'Over

HIGH PASS FILTER frequency	Through/50/60/80/100/120/150/ 180/220
SLOPE	-6/-12/-18/-24 dB/Oct.
LOW PASS FILTER frequency	50/60/80/100/120/Through
SLOPE	-6/-12/-18/-24 dB/Oct.

Position

Front/Rear/Subwoofer Delay	0 cm to 610 cm (2.0 cm Step)
Gain	-8 dB to 0 dB

Subwoofer Level -50 dB to +10 dB

❑ FM tuner section

Frequency Range (50 kHz)
87.5 MHz to 108.0 MHz

Usable Sensitivity (S/N: 26 dB)
6.2 dBf (0.56 μ V/75 Ω)

Quieting Sensitivity (S/N: 46 dB)
15.2 dBf (1.58 μ V/75 Ω)

Frequency Response (\pm 3.0 dB)
30 Hz to 15 kHz

Signal to Noise Ratio
68 dB (MONO)

Selectivity (\pm 400 kHz)
 \geq 80 dB

Stereo Separation 40 dB (1 kHz)

❑ LW tuner section

Frequency Range (9 kHz)
153 kHz to 279 kHz

Usable Sensitivity 45 μ V

❑ MW tuner section

Frequency Range (9 kHz)
531 kHz to 1 611 kHz

Usable Sensitivity 28.5 μ V

❑ Digital tuner (DAB) section (DDX5015DAB)

Frequency Range
L-BAND: 1 452.960 MHz to 1 490.624 MHz
BAND III: 174.928 MHz to 239.200 MHz

Sensitivity -100 dBm

Signal to Noise Ratio
90 dB

DAB Aerial Connector

Connector type: SMB
Output Voltage: 14.4 V (11 V to 16 V allowable)
Maximum Current: < 100 mA

REFERENCES

Video section

Color System of External Video Input
NTSC/PAL

External Video Input Level (mini jack)
1 Vp-p/75 Ω

External Audio Max Input Level (mini jack)
2 V/25 kΩ

Video Output Level (RCA jacks)
1 Vp-p/75 Ω

Audio Output Level (mini jacks)
1.2 V/10 kΩ

Analog RGB Input 0.7 Vp-p/75 Ω*

* Only for DDX7015BT/DDX5015DAB/DDX5015BT.

Audio section

Maximum Power (Front & Rear)
50 W × 4

Typical Power Output
Full Bandwidth Power
(at less than 1%THD)
22 W × 4

Preout Level 4 V/10 kΩ

Preout Impedance
≤ 600 Ω

Speaker Impedance
4 Ω to 8 Ω

General

Operating Voltage
14.4 V (10.5 V to 16 V allowable)

Maximum Current Consumption
10 A

Installation Dimensions (W × H × D)
DDX7015BT: 182 mm × 112 mm × 162 mm
DDX5015DAB/DDX5015BT/DDX5015BTR:
182 mm × 112 mm × 157 mm

Operational Temperature Range
−10°C to +60°C

Weight
DDX7015BT: 2.5 kg
DDX5015DAB/DDX5015BT/DDX5015BTR:
2.0 kg

Design and specifications are subject to change
without notice.

Trademarks and licenses

- Manufactured under license from Dolby Laboratories. Dolby and the double-D symbol are trademarks of Dolby Laboratories.
- “DVD Logo” is a trademark of DVD Format/Logo Licensing Corporation registered in the US, Japan and other countries.
- The “AAC” logo is a trademark of Dolby Laboratories.
- Microsoft and Windows Media are either registered trademarks or trademarks of Microsoft Corporation in the United States and/or other countries.
- “Made for iPod,” and “Made for iPhone” mean that an electronic accessory has been designed to connect specifically to iPod, or iPhone, respectively, and has been certified by the developer to meet Apple performance standards. Apple is not responsible for the operation of this device or its compliance with safety and regulatory standards. Please note that the use of this accessory with iPod, or iPhone may affect wireless performance. iPhone, iPod, iPod classic, iPod nano, and iPod touch are trademarks of Apple Inc., registered in the U.S. and other countries.
- Lightning is a trademark of Apple Inc.
- This item incorporates copy protection technology that is protected by U.S. patents and other intellectual property rights of Rovi Corporation. Reverse engineering and disassembly are prohibited.
- Font for this product is designed by Ricoh.

REFERENCES

- THIS PRODUCT IS LICENSED UNDER THE MPEG-4 VISUAL PATENT PORTFOLIO LICENSE FOR THE PERSONAL AND NON-COMMERCIAL USE OF A CONSUMER FOR (i) ENCODING VIDEO IN COMPLIANCE WITH THE MPEG-4 VISUAL STANDARD ("MPEG-4 VIDEO") AND/OR (ii) DECODING MPEG-4 VIDEO THAT WAS ENCODED BY A CONSUMER ENGAGED IN A PERSONAL AND NON-COMMERCIAL ACTIVITY AND/OR WAS OBTAINED FROM A VIDEO PROVIDER LICENSED BY MPEG LA TO PROVIDE MPEG-4 VIDEO. NO LICENSE IS GRANTED OR SHALL BE IMPLIED FOR ANY OTHER USE. ADDITIONAL INFORMATION INCLUDING THAT RELATING TO PROMOTIONAL, INTERNAL AND COMMERCIAL USES AND LICENSING MAY BE OBTAINED FROM MPEG LA, LLC. SEE [HTTP://WWW.MPEGLA.COM](http://www.mpegla.com).
 - THIS PRODUCT IS LICENSED UNDER THE AVC PATENT PORTFOLIO LICENSE FOR THE PERSONAL USE OF A CONSUMER OR OTHER USES IN WHICH IT DOES NOT RECEIVE REMUNERATION TO (i) ENCODE VIDEO IN COMPLIANCE WITH THE AVC STANDARD ("AVC VIDEO") AND/OR (ii) DECODE AVC VIDEO THAT WAS ENCODED BY A CONSUMER ENGAGED IN A PERSONAL ACTIVITY AND/OR WAS OBTAINED FROM A VIDEO PROVIDER LICENSED TO PROVIDE AVC VIDEO. NO LICENSE IS GRANTED OR SHALL BE IMPLIED FOR ANY OTHER USE. ADDITIONAL INFORMATION MAY BE OBTAINED FROM MPEG LA, L.L.C. SEE [HTTP://WWW.MPEGLA.COM](http://www.mpegla.com)
 - Android is a trademark of Google Inc.
 - The Bluetooth® word mark and logos are registered trademarks owned by Bluetooth SIG, Inc. and any use of such marks by JVC KENWOOD Corporation is under license. Other trademarks and trade names are those of their respective owners.
 - The terms HDMI and HDMI High-Definition Multimedia Interface, and the HDMI logo are trademarks or registered trademarks of HDMI Licensing LLC in the United States and other countries.
 - MHL and the MHL logo are a trademark or registered trademark of MHL, LLC.
 - Incorporates MHL 2
 - libFLAC
 - Copyright (C) 2000,2001,2002,2003,2004,2005,2006,2007,2008,2009 Josh Coalson
 - Redistribution and use in source and binary forms, with or without modification, are permitted provided that the following conditions are met:
 - Redistributions of source code must retain the above copyright notice, this list of conditions and the following disclaimer.
 - Redistributions in binary form must reproduce the above copyright notice, this list of conditions and the following disclaimer in the documentation and/or other materials provided with the distribution.
 - Neither the name of the Xiph.org Foundation nor the names of its contributors may be used to endorse or promote products derived from this software without specific prior written permission.
- THIS SOFTWARE IS PROVIDED BY THE COPYRIGHT HOLDERS AND CONTRIBUTORS "AS IS" AND ANY EXPRESS OR IMPLIED WARRANTIES, INCLUDING, BUT NOT LIMITED TO, THE IMPLIED WARRANTIES OF MERCHANTABILITY AND FITNESS FOR A PARTICULAR PURPOSE ARE DISCLAIMED. IN NO EVENT SHALL THE FOUNDATION OR CONTRIBUTORS BE LIABLE FOR ANY DIRECT, INDIRECT, INCIDENTAL, SPECIAL, EXEMPLARY, OR CONSEQUENTIAL DAMAGES (INCLUDING, BUT NOT LIMITED TO, PROCUREMENT OF SUBSTITUTE GOODS OR SERVICES; LOSS OF USE, DATA, OR PROFITS; OR BUSINESS INTERRUPTION) HOWEVER CAUSED AND ON ANY THEORY OF LIABILITY, WHETHER IN CONTRACT, STRICT LIABILITY, OR TORT (INCLUDING NEGLIGENCE OR OTHERWISE) ARISING IN ANY WAY OUT OF THE USE OF THIS SOFTWARE, EVEN IF ADVISED OF THE POSSIBILITY OF SUCH DAMAGE.
- "aupeo" is a trade mark of Aupeo Ltd.

DIVX

- This DivX Certified® device has passed rigorous testing to ensure it plays DivX® video. To play purchased DivX movies, first register your device at vod.divx.com. Find your registration code in the DivX VOD section of your device setup menu. (Page 53)
- DivX Certified® to play DivX® video, including premium content.
- DivX®, DivX Certified® and associated logos are trademarks of DivX, LLC and are used under license.



Declaration of Conformity with regard to the EMC Directive 2004/108/EC
Declaration of Conformity with regard to the R&TTE Directive 1999/5/EC
Declaration of Conformity with regard to the RoHS Directive 2011/65/EU

Manufacturer:

JVC KENWOOD Corporation

3-12 Moriya-cho, Kanagawa-ku, Yokohama-shi, Kanagawa, 221-0022, Japan

EU Representative:

JVCKENWOOD NEDERLAND B.V.

Amsterdamseweg 37, 1422 AC UITHOORN, The Netherlands

English

Hereby, JVC KENWOOD declares that this unit "DDX7015BT/DDX5015DAB/DDX5015BT/DDX5015BTR" is in compliance with the essential requirements and other relevant provisions of Directive 1999/5/EC.

Français

Par la présente JVC KENWOOD déclare que l'appareil "DDX7015BT/DDX5015DAB/DDX5015BT/DDX5015BTR" est conforme aux exigences essentielles et aux autres dispositions pertinentes de la directive 1999/5/EC. Par la présente, JVC KENWOOD déclare que ce "DDX7015BT/DDX5015DAB/DDX5015BT/DDX5015BTR" est conforme aux exigences essentielles et aux autres dispositions de la directive 1999/5/EC qui lui sont applicables.

Deutsch

Hiermit erklärt JVC KENWOOD, dass sich dieser "DDX7015BT/DDX5015DAB/DDX5015BT/DDX5015BTR" in Übereinstimmung mit den grundlegenden Anforderungen und den anderen relevanten Vorschriften der Richtlinie 1999/5/EC befindet. (BMW) Hiermit erklärt JVC KENWOOD die Übereinstimmung des Gerätes "DDX7015BT/DDX5015DAB/DDX5015BT/DDX5015BTR" mit den grundlegenden Anforderungen und den anderen relevanten Festlegungen der Richtlinie 1999/5/EC. (Wien)

Nederlands

Hierbij verklaart JVC KENWOOD dat het toestel "DDX7015BT/DDX5015DAB/DDX5015BT/DDX5015BTR" in overeenstemming is met de essentiële eisen en de andere relevante bepalingen van richtlijn 1999/5/EC. Bij deze verklaart JVC KENWOOD dat deze "DDX7015BT/DDX5015DAB/DDX5015BT/DDX5015BTR" voldoet aan de essentiële eisen en aan de overige relevante bepalingen van Richtlijn 1999/5/EC.

Italiano

Con la presente JVC KENWOOD dichiara che questo "DDX7015BT/DDX5015DAB/DDX5015BT/DDX5015BTR" è conforme ai requisiti essenziali ed alle altre disposizioni pertinenti stabilite dalla direttiva 1999/5/EC.

Español

Por medio de la presente JVC KENWOOD declara que el "DDX7015BT/DDX5015DAB/DDX5015BT/DDX5015BTR" cumple con los requisitos esenciales y cualesquiera otras disposiciones aplicables o exigibles de la Directiva 1999/5/EC.

Português

JVC KENWOOD declara que este "DDX7015BT/DDX5015DAB/DDX5015BT/DDX5015BTR" está conforme com os requisitos essenciais e outras disposições da Directiva 1999/5/EC.

Polska

JVC KENWOOD niniejszym oświadcza, że "DDX7015BT/DDX5015DAB/DDX5015BT/DDX5015BTR" spełnia zasadnicze wymogi oraz inne istotne postanowienia dyrektywy 1999/5/EC.

Česky

JVC KENWOOD tímto prohlašuje, že tento "DDX7015BT/DDX5015DAB/DDX5015BT/DDX5015BTR" je ve shodě se základními požadavky a dalšími příslušnými ustanoveními směrnice 1999/5/EC.

Magyar

Alulírott, JVC KENWOOD, kijelenti, hogy a jelen "DDX7015BT/DDX5015DAB/DDX5015BT/DDX5015BTR" megfelel az 1999/5/EC irányelvben meghatározott alapvető követelményeknek és egyéb vonatkozó előírásoknak.

Svenska

Härmed intygar JVC KENWOOD att denna "DDX7015BT/DDX5015DAB/DDX5015BT/DDX5015BTR" står i överensstämmelse med de väsentliga egenskapskrav och övriga relevanta bestämmelser som framgår av direktiv 1999/5/EC.

Suomi

JVC KENWOOD vakuuttaa täten että "DDX7015BT/DDX5015DAB/DDX5015BT/DDX5015BTR" tyypin laite on direktiivin 1999/5/EC oleellisten vaatimusten ja sitä koskevien direktiivin muiden ehtojen mukainen.

Slovensko

S tem JVC KENWOOD izjavlja, da je ta "DDX7015BT/DDX5015DAB/DDX5015BT/DDX5015BTR" v skladu z osnovnimi zahtevami in ostalimi ustreznimi predpisi Direktive 1999/5/EC.

Slovensky

Spoločnosť JVC KENWOOD týmto vyhlasuje, že "DDX7015BT/DDX5015DAB/DDX5015BT/DDX5015BTR" spĺňa základné požiadavky a ďalšie príslušné ustanovenia Direktívy 1999/5/EC.

Dansk

Undertegnede JVC KENWOOD erklærer herved, at følgende udstyr "DDX7015BT/DDX5015DAB/DDX5015BT/DDX5015BTR" overholder de væsentlige krav og øvrige relevante krav i direktiv 1999/5/EC.

Ελληνικά

ΜΕ ΤΗΝ ΠΑΡΟΥΣΑ JVC KENWOOD ΔΗΛΩΝΕΙ ΟΤΙ "DDX7015BT/DDX5015DAB/DDX5015BT/DDX5015BTR" ΣΥΜΜΟΡΦΩΝΕΤΑΙ ΠΡΟΣ ΤΙΣ ΟΥΣΙΩΔΕΙΣ ΑΠΑΙΤΗΣΕΙΣ ΚΑΙ ΤΙΣ ΛΟΙΠΕΣ ΣΧΗΤΙΚΕΣ ΔΙΑΤΑΞΕΙΣ ΤΗΣ ΟΔΗΓΙΑΣ 1999/5/EC.

Eesti

Sellega kinnitab JVC KENWOOD, et see "DDX7015BT/DDX5015DAB/DDX5015BT/DDX5015BTR" vastab direktiivi 1999/5/EC põhilistele nõudmistele ja muudele asjakohastele määrustele.

Latviešu

Ar šo, JVC KENWOOD, apstiprina, ka "DDX7015BT/DDX5015DAB/DDX5015BT/DDX5015BTR" atbilst Direktīvas 1999/5/EC galvenajām prasībām un citiem tās nosacījumiem.

Lietuviškai

Šiuo, JVC KENWOOD, pareiškia, kad šis "DDX7015BT/DDX5015DAB/DDX5015BT/DDX5015BTR" atitinka pagrindinius Direktyvos 1999/5/EC reikalavimus ir kitas svarbias nuostatas.

Malti

Hawnhekk, JVC KENWOOD, jiddikjara li dan "DDX7015BT/DDX5015DAB/DDX5015BT/DDX5015BTR" jikkonforma mal-htigijiet essenzjali u ma provvedimenti oħrajn relevanti li hemm fid-Direttiva 1999/5/EC.

Українська

Компанія JVC KENWOOD заявляє, що цей виріб "DDX7015BT/DDX5015DAB/DDX5015BT/DDX5015BTR" відповідає ключовим вимогам та іншим пов'язаним положенням Директиви 1999/5/EC.

Türkçe

Bu vesileyle JVC KENWOOD, "DDX7015BT/DDX5015DAB/DDX5015BT/DDX5015BTR" ünitesinin, 1999/5/EC Direktifinin başlıca gereksinimleri ve diğer ilgili hükümleri ile uyumlu olduğunu beyan eder.

Hrvatski

Ovime JVC KENWOOD izjavlja je da je ova jedinica "DDX7015BT/DDX5015DAB/DDX5015BT/DDX5015BTR" je u skladu s osnovnim zahtjevima i drugim relevantnim odredbama Direktive 1999/5/EC.

KENWOOD

Download from www.Somanuals.com. All Manuals Search And Download.

Free Manuals Download Website

<http://myh66.com>

<http://usermanuals.us>

<http://www.somanuals.com>

<http://www.4manuals.cc>

<http://www.manual-lib.com>

<http://www.404manual.com>

<http://www.luxmanual.com>

<http://aubethermostatmanual.com>

Golf course search by state

<http://golfingnear.com>

Email search by domain

<http://emailbydomain.com>

Auto manuals search

<http://auto.somanuals.com>

TV manuals search

<http://tv.somanuals.com>