

# KENWOOD

## KDV-U4349 KDV-U4349M KDV-U4449

---

### DVD-RECEIVER **INSTRUCTION MANUAL**

Kenwood Corporation



# Contents

## **Before use** **3**

## **For first use** **7**

Before using this unit for the first time  
Language Setup  
DSP Setup

## **Basic Operation of control panel** **8**

General functions  
Tuner functions  
DVD/ USB/ iPod play functions

## **Function Control/ Setup Menu** **10**

## **Clock/ Display Settings** **14**

Manual Clock Adjustment  
Text Display Selection  
Auxiliary Input Display Setting  
Theft Deterrent Faceplate

## **Tuner Operation** **15**

Frequency Step Setting

## **Disc/ USB Operations of Remote Control** **16**

Before Use  
Playing a Disc  
Playing a USB device  
Basic Operation  
Displaying Status and Control on-screen  
DVD-VIDEO Disc Menu  
DVD-VR Menu  
Video CD PBC Menu  
Zoom  
Time Search  
Direct Search  
File Select

## **iPod Operations of Remote Control** **20**

Before Use  
Playing the iPod  
Search Mode

## **Music disc/Audio file/iPod Operation of Control Panel** **21**

Music/Video Search  
Music Search for iPod  
iPod Control by Hand Mode  
Basic Operation of Disc Changer (Optional)

## **Other Functions** **24**

Activating Security Code  
Deactivating Security Code

## **Audio Adjustments** **25**

Audio Control  
Audio Setup  
Preset Equalizer Select  
Manual Equalizer Control  
Position Control  
Cabin Selection  
Speaker Setting  
X'Over Setting  
DTA (Digital Time Alignment) Setting  
Audio Preset Memory  
Audio Preset Recall

## **Basic Operations of Remote Control** **30**

## **Appendix** **31**

## **Accessories/ Installation Procedure** **34**

## **Connecting Wires to Terminals** **35**









## **Installation/Removing the Unit** **36**

## **Troubleshooting Guide** **37**

## **Specifications** **39**

### **About the functions by playback source**

In this manual, functions that can be used with various playback sources are indicated as follows:

-  DVD-VIDEO Function of DVD-VIDEO playback.
-  DVD-VR Function of DVD-VR playback.
-  Video CD Function of Video CD playback.
-  CD Function of CD (CD-DA) playback.
-  Audio File Function of Audio file playback.
-  MPEG/DivX® Function of Video file playback.
-  JPEG Function of JPEG file playback.
-  iPod Function of iPod playback.

## Before use

### ▲WARNING

#### To prevent injury or fire, take the following precautions:

- To prevent a short circuit, never put or leave any metallic objects (such as coins or metal tools) inside the unit.

#### How to reset your unit

- If this unit or the connected unit (disc auto changer, etc.) fails to operate properly, press the Reset button. The unit returns to factory settings when the Reset button is pressed.

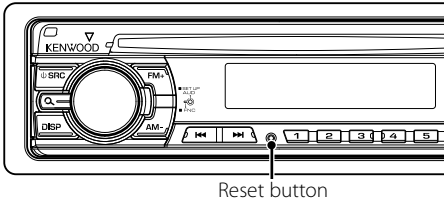

#### Cleaning the Unit

If the faceplate of this unit is stained, wipe it with a dry soft cloth such as a silicon cloth.  
If the faceplate is stained badly, wipe the stain off with a cloth moistened with neutral cleaner, then wipe it again with a clean soft dry cloth.



- Applying spray cleaner directly to the unit may affect its mechanical parts. Wiping the faceplate with a hard cloth or using a volatile liquid such as thinner or alcohol may scratch the surface or erase characters.

#### Cleaning the Faceplate Terminals

If the terminals on the unit or faceplate get dirty, wipe them with a clean soft dry cloth.

#### Lens Fogging

When you turn on the car heater in cold weather, dew or condensation may form on the lens in the DVD player of the unit. Called lens fogging, this condensation on the lens may not allow discs to play. In such a situation, remove the disc and wait for the condensation to evaporate. If the unit still does not operate normally after a while, consult your Kenwood dealer.

- If you experience problems during installation, consult your Kenwood dealer.
- When you purchase optional accessories, check with your Kenwood dealer to make sure that they work with your model and in your area.
- The characters which can be displayed by this unit are A-Z 0-9 @ ' ' % & \* + - = , . / \ < > [ ] ( ) ; : ^ - { } ~ .
- The illustrations of the display and the panel appearing in this manual are examples used to explain more clearly how the controls are used. Therefore, what appears on the display in the illustrations may differ from what appears on the display on the actual equipment, and some of the illustrations on the display may be inapplicable.

#### Handling discs

- Do not touch the recording surface of the disc.
- Do not stick tape etc. on the disc, or use a disc with tape stuck on it.
- Do not use disc type accessories.
- Clean from the center of the disc and move outward.
- When removing discs from this unit, pull them out horizontally.
- If the disc center hole or outside rim has burrs, use the disc only after removing the burrs with a ballpoint pen etc.

#### Discs that cannot be used

- Discs that are not round cannot be used.

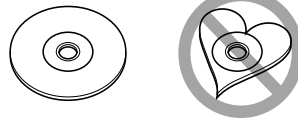

- Discs with coloring on the recording surface or discs that are dirty cannot be used.
- This unit can only play the CDs with This unit may not correctly play discs which do not have the mark.
- You cannot play a disc that has not been finalized. (For the finalization process refer to your writing software, and your recorder instruction manual.)

# Before use

## List of playable discs

Disc types	Standard	Support	Remark
DVD	DVD Video	○	DTS not supported.
	DVD Audio	×	
	DVD-R	○	MP3/WMA/WAV/JPEG/MPEG/DivX Playback
	DVD-RW	○	Multi-border/Multisession/ (Playback depends on authoring conditions)
	DVD+R	○	Video mode supported
	DVD+RW	○	VR mode supported (Only DVD-R/RW)
	DVD-R DL (Dual layer) DVD+R DL (Double layer)	○	Only video format
CD	DVD-RAM	×	
	Music CD	○	CD-TEXT
	CD-ROM	○	MP3/WMA/WAV/JPEG/DivX playback
	CD-R	○	Multisession supported
	CD-RW	○	Packet write not supported.
	DTS-CD	×	
	Video CD (VCD)	○	
	Super video CD	×	
	Photo CD	×	
	CD-EXTRA	△	Only music CD session can be played.
	HDCD	△	Sound quality of normal CD music
Others	CCCD	×	
	DualDisc	×	
	Super audio CD	△	Only CD layer can be played.

○ : Playback is possible.

△ : Playback is partly possible.

× : Playback is impossible.



- When buying DRM enabled contents, check the Registration Code in the <DivX registration> (page 13). Registration Code changes each time a file with the displayed Registration Code is played to protect against copying.

## Use of "DualDisc"

When playing a "DualDisc" on this unit, the surface of the disc that is not played may be scratched while the disc is inserted or ejected. Since the music CD surface does not conform to the CD standard, playback may be impossible.

(A "DualDisc" is a disc with one surface containing DVD standard signals and the other surface containing music CD signals.)

## About Audio files

### • Playable Audio file

MP3 (.mp3), WMA (.wma), Linear PCM (WAV) (.wav)



- If music of normal CD and other playback systems are recorded in the same disc, only the playback system recorded at the first setout is played.
- Acceptable media**  
CD-R/RW/ROM, DVD±R/RW, mass-storage-class USB device, iPod with KCA-iP102
- Playable disc file format**  
ISO 9660 Level 1/2, Joliet, Romeo.
- Playable USB device file system**  
FAT32, FAT16

Although the audio files are complied with the standards listed above, the play maybe impossible depending on the types or conditions of media or device.

### • Playing order of the Audio file

In the example of folder/file tree shown below, the files are played in the order from ① to ⑩.

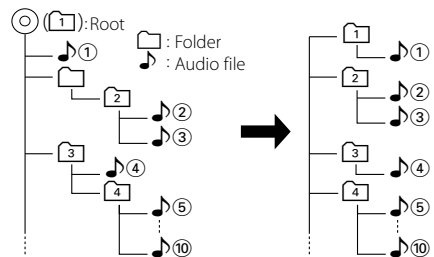

An online manual about audio files is put on the site, [www.kenwood.com/audiofile/](http://www.kenwood.com/audiofile/). On this online manual, detailed information and notes which are not written in this manual are provided. Make sure to read through the online manual as well.

## About Video files

### • Acceptable video files

MPEG1, MPEG2, DivX

### • Extensions

mpg, mpeg, divx, div, avi

### • Acceptable media

CD-R/RW/ROM, DVD±R/RW, mass-storage-class USB device, iPod with KCA-iP102

Acceptable discs, disc formats, USB device file system, file and folder names and playing order are the same as those for audio files. See <About Audio files>.

## About Picture files

### • Acceptable picture files

JPEG

### • Extensions

jpg, jpeg

### • Acceptable media

CD-R/RW/ROM, DVD±R/RW, mass-storage-class USB device

Acceptable discs, disc formats, USB device file system, file and folder names and playing order are the same as those for audio files. See <About Audio files>.

## iPod/iPhone that can be connected to this unit

Made for

- iPod nano (6th generation)
  - iPod nano (5th generation)
  - iPod nano (4th generation)
  - iPod nano (3rd generation)
  - iPod nano (2nd generation)
  - iPod nano (1st generation)
  - iPod with video
  - iPod classic
  - iPod touch (4th generation)
  - iPod touch (3rd generation)
  - iPod touch (2nd generation)
  - iPod touch (1st generation)
  - iPhone 4
  - iPhone 3GS
  - iPhone 3G
  - iPhone
- For the latest compatible list and software version of iPod/iPhone, see: [www.kenwood.com/cs/ce/ipod](http://www.kenwood.com/cs/ce/ipod)
- You can control an iPod/iPhone from this unit by connecting an iPod/iPhone (commercial product) with Dock connector using an optional accessory iPod connection cable (KCA-iP102). The word "iPod" appearing in this manual indicates the iPod/iPhone connected with the KCA-iP102 (optional accessory).
- By connecting your iPod/iPhone to this unit with an optional accessory iPod connection cable (KCA-iP102), you can supply power to your iPod/iPhone as well as charge it while playing music. However, the power of this unit must be on.



- If you start playback after connecting the iPod, the music that has been played by the iPod is played first.
- You cannot operate iPod if "KENWOOD" or "✓" is displayed on the iPod.
- A video file stops playing if you switch to another source while playing it. You cannot play from the last playback position if you switch back to iPod.

## About USB device

- In this manual, the word "USB device" is used for flash memories and digital audio players which have USB terminals.
- When the USB device is connected to this unit, it can be charged up provided that this unit is powered.
- Install the USB device in the place where it will not prevent you from driving your vehicle properly.
- You cannot connect a USB device via a USB hub and Multi Card Reader.
- Take backups of the audio files used with this unit. The files can be erased depending on the operating conditions of the USB device.  
We shall have no compensation for any damage arising out of erasure of the stored data.
- No USB device comes with this unit. You need to purchase a commercially available USB device.
- When connecting the USB device, usage of the CA-U1EX (option) is recommended.  
Normal playback is not guaranteed when a cable other than the USB compatible cable is used. Connecting a cable whose total length is longer than 5 m can result in abnormal playback.

## Before use

### Region codes in the world

The DVD players are given a region code according to the country or area it is marketed, as shown in the following map.

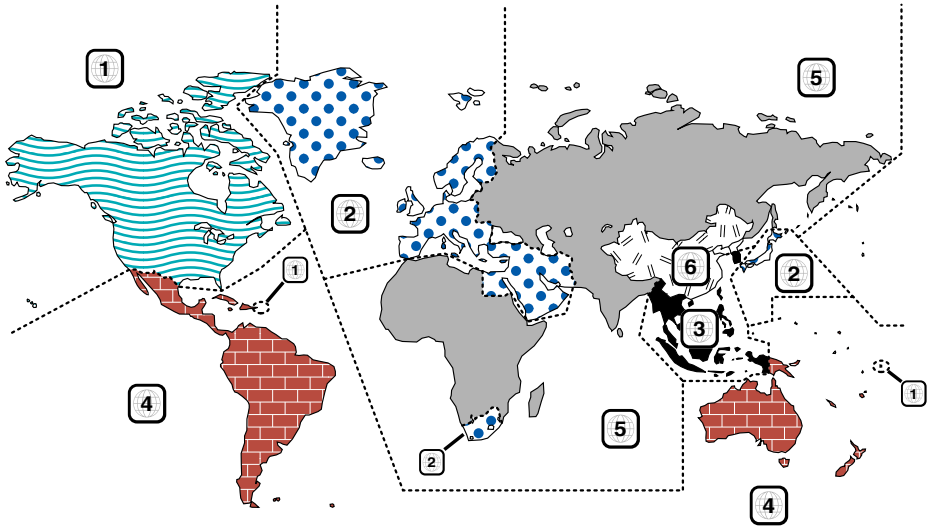

### DVD disc marks

Symbol	Description
	Indicates a region number. The discs with this mark can be played with any DVD player.
	Indicates the number of audio languages recorded. Up to 8 languages can be recorded in a movie. You can select a favorite language.
	Indicates the number of subtitled languages recorded. Up to 32 languages can be recorded.
	If a DVD disc has scenes shot from multiple angles, you can select a favorite angle.
	Indicates the type of screen for the image. The left mark indicates that a wide image picture (16:9) is displayed on a standard TV set screen (4:3) with a black band at both the top and bottom of the screen (letter box).

### Operation regulatory marks

With this DVD, some functions of this unit such as the play function may be restricted depending on the location where the DVD is playing. In this case, the following marks will appear on the screen. For more information, refer to the disc manual.



### Discs with limited period of use

Do not leave discs with a limited period of use in this unit. If you load an already expired disc, you may not be able to remove it from this unit.

## For first use

### Before using this unit for the first time

#### Demonstration mode setting

This unit is initially set on the Demonstration mode. When using this unit for the first time, cancel the Demonstration mode setting.

Display	Setting
"DEMO ON"	The Demonstration mode function is ON.
"DEMO OFF"	Cancel Demonstration mode (Normal mode).

#### TV system selection

You must select the appropriate system mode for your TV system. When the selected system does not coincide with the system of your TV, normal color picture may not be displayed.

Display	Setting
"P/N PAL"	Select when the unit is connected with PAL-TV.
"P/N NTSC"	Select when the unit is connected with NTSC-TV.

#### 1 Select Standby

Press the [SRC] button.

Select the "STANDBY" display.

#### 2 Enter Function Control mode

Press the [Q] button for at least 1 second.

"FUNCTION" is displayed.

#### 3 Enter Menu mode

Turn the [AUD] knob to select "MENU".

Press the [AUD] knob.

#### 4 Set the Demonstration mode

Turn the [AUD] knob to select "DEMO".

Press the [AUD] knob for at least 2 seconds.

Select the "DEMO OFF" display.

#### 5 Set the TV system

Turn the [AUD] knob to select "P/N".

Press the [◀◀] or [▶▶] button.

#### 6 Exit Function Control mode

Press the [Q] button for at least 1 second.

#### 7 Turning OFF the Power

Press the [SRC] button for at least 1 second.



• These settings can be changed later.

### Language Setup

Set a language used for screen display, DVD subtitles, etc.

• "LANGUAGE" item of the Setup menu (page 13)

### DSP Setup

To get clear sound, set the sound environment according to the location and size of physically installed speakers with reference to the followings:

- "MENU" > "SWPRE" of <Function Control> (page 10)
- Cabin selection (page 27)
- Speaker Setting (page 27)
- DTA (Digital Time Alignment) setting (page 28)
- X'Over setting (page 28)



• Setting "DSP SET" to "BYPASS" disables the settings related to the DSP function. Refer to "DSP" > "DSP SET" of <Function Control> (page 11).

# Basic Operation of control panel

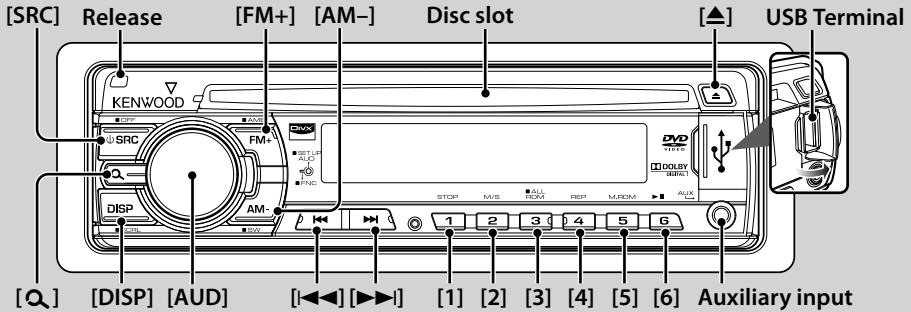

## General functions

### **Power/Source Select button: [SRC]**

Turns on the power.

When the power is on, the source switches between Tuner ("TUNER"), USB or iPod ("USB" or "iPod"), DVD ("DVD"), Auxiliary input ("AUX"), and Standby ("STANDBY") each time this button is pressed. Press at least 1 second to turn off the power.



- When an optional accessory is connected, the source name for each device appears.

### **Volume control: [AUD] knob**

Turn the knob to adjust the volume.

### **Subwoofer output: [AM-]**

Switches between ON ("SW ON") and OFF ("SW OFF") each time this button is pressed for at least 2 seconds.



- You can do this function when "SWPRE" in <Function Control> (page 10) is set to "SW".

### **Auxiliary input**

Connect a portable audio device with mini-plug cable (3.5 Ø).



- Use the mini-plug cable which is stereo type and does not have any resistance.
- The AUX input requires the setting made in "MENU" > "AUX" of <Function Control> (page 11).

### **Switching display: [DISP]**

Changes the information displayed. Refer to page 14 for the details of the display setting.

### **Text/Title scroll: [DISP]**

Scrolls the text display of a CD or audio files when pressed for at least 1 second.

## Tuner functions

### **FM band: [FM+]**

Switches between FM1, FM2, and FM3 each time the [FM+] button is pressed.

### **AM band: [AM-]**

Switches to AM.

### **Tuning: [◀◀]/[▶▶]**

Changes the frequency.



- Use the "MENU" > "AUTO1"/"AUTO2"/"MANUAL" in <Function Control> (page 11) to change the frequency switching.
- During reception of stereo stations the "ST" indicator is ON.

### **Preset memory: [1] - [6]**

Memorizes the station selected when pressing for at least 2 seconds.

### **Auto memory entry: [FM+]**

Memorizes 6 stations with good reception automatically when pressed for at least 2 seconds.

### **Preset tuning: [1] - [6]**

Recalls the memorized station.



## DVD/USB/iPod play functions

### Disc play: Disc slot

Starts playing when a disc is inserted.

When a disc is inserted, the "IN" indicator is ON.



- Do not attempt to insert a disc into the slot if another one is already there.
- The unit can only play 12 cm (5 inch) discs. If you insert an 8 cm (3 inch) disc, it will get stuck inside and can cause the unit to malfunction.

### Disc ejection: [▲]



- You can eject the disc for 10 minutes after switching off the engine.

### USB device/iPod play: USB Terminal

Connecting a USB device starts playback.



- For the playable audio file, video file, media, and devices, refer to <About Audio file> (page 4), <About Video file> (page 4).

### USB device/ iPod removing

To disconnect the USB device/ iPod, stop the playback by pressing the [1] button, and then disconnect the USB device/ iPod.

### Pause and play: [6]

Switches between pause and play each time this button is pressed.

### Stops playing: [1]

### Track/File search: [◀◀]/ [▶▶]

Changes the chapter/ track/ file when this button is pressed.

Fast reverses or forwards the music while pressing. Pressing these buttons for 5 seconds or longer accelerates the speed of fast-forward or fast-reverse.



- For the iPod, the fast-forward or reverse speed does not change.

### Title/ Folder search DVD-VIDEO DVD-VR Audio File MPEG/DivX®

JPEG : [FM+]/ [AM-]

Changes the title/ folder.

### Search mode Audio File CD MPEG/DivX® JPEG iPod

: [Q]

After pressing this button, you can quickly search songs with the [AUD] knob. See <Music/Video Search> (page 21) for details.

### Changing the audio channel Video CD : [2]

Changes the audio channel when this button is pressed.

### Repeat play: [4]

Each time you press the button, the Repeat Play alternates between the modes.

**DVD-VIDEO** Chapter Repeat ("CHAP REP"), Title Repeat ("TITL REP") and OFF ("REP OFF")

**DVD-VR** Chapter Repeat ("CHAP REP"), Program Repeat ("PRG REP") and OFF ("REP OFF")

**Video CD** Track Repeat ("TRAC REP") and OFF ("REP OFF") (Video CD: PBC Off)

**Audio File** File Repeat ("FILE REP"), Folder Repeat ("FOLD REP"), and OFF ("REP OFF")

**MPEG/DivX** Folder Repeat ("FOLD REP") and OFF ("REP OFF")

**JPEG** Folder Repeat ("FOLD REP") and OFF ("REP OFF")

**iPod** File Repeat ("REP ONE"), All Repeat ("REP ALL"), and OFF ("REP OFF")



- Set to "MENU" > "FILETYPE" > "USB" > "PIC" of the <Function Control> (page 11) when you select USB and iPod source.

### Random play Video CD Audio File CD MPEG/DivX® iPod : [3]

Randomly plays the track/ file in the disc or folder. When Random Play is turned on, "DISC RDM"/ "FOLD RDM" is displayed.



- **iPod** : Disabled when VIDEO is being played.

### All Random play Audio File MPEG/DivX® iPod : [3]

If you press this button for at least 3 seconds while playing a file, all files in the media play at random ("ALL RDM").

Pressing the button again turns the random play off ("RDM OFF").



- The time required to turn on the all random function may become longer depending on the number of songs in iPod or the folder structure.
- **iPod** : Turning on the all random function changes the iPod browse item to "songs". This browse item will not change even if the all random function is turned off.
- **iPod** : If the brows item is changed to search for music while the all random function is on, the all random function is turned off and the songs in the browse item are played at random.

# Function Control/ Setup Menu

## Function Control

Functions in the table below can be set up by using Function Control.

### 1 Enter Function Control mode

Press the [Q] button for at least 1 second.

"FUNCTION" is displayed.

### 2 Select your desired setup item

Operation type	Operation
Movement between items	Turn the [AUD] knob.
Selection of item	Press the [AUD] knob.
Return to previous item	Press the [Q] button.

Repeat selection and determination until your desired setup item is selected.

In this manual, the above selection is indicated as

Press [Q] 1sec, and select "MENU" > "ICON".

Category	Function of setup item	Condition
"iPodCTRL"	Allows you to set up iPod Control by Hand Mode.	iPod
"DSP"	Allows you to set up the sound environment.	SB
"MENU"	Allows you to set up the environment.	—
"RETURN"	Exit Function Control mode.	—

### 3 Make a setting

Press the [AUD] knob or turn the [AUD] knob to select a setting value, and then press the [AUD] knob.

- The value of items with [AUD] mark can be set by pressing the [AUD] knob.
- The value of items with [◀◀/▶▶] mark can be set by pressing the [◀◀] or [▶▶] button.
- Some items require you to keep pressing the [AUD] knob for 1 or 2 seconds to set. For these items, the time during which you need to keep pressing the [AUD] knob is displayed in the Entry column in seconds.

### 4 Exit Function Control mode

Press the [Q] button for at least 1 second.

## "MENU"

Item	Setting	Entry	Setting overview	Condition	Page
"CODE SET"/ "CODE CLR"		1 sec.	Sets/Resets security code.	SB	24
"DIM"	"OFF"/"ON"	◀◀▶▶	Adjusts the brightness of the display according to the surrounding illumination.	—	—
"ICON"	"OFF"/"ON1"/ "ON2"*	◀◀▶▶	Sets the Graphics mode of the display.	SB	32
"SWPRE"	"R"/"SW"/"AV"	◀◀▶▶	Sets the preout output.	SB	32

Displayed item is depending on currently selected source or mode. The mark in Condition column shows the condition to which the item is displayed.

**SB** : Can be set in other than standby state.

**SB** : Can be set in standby state.

**iPod** : Can be set only during playback of the iPod source. (USB source used when the iPod is connected)

**USB** : Can be set during USB source.

**DVD** : Can be set during DVD source.

**Tuner** : Can be set during Tuner source.

**FM** : Can be set during FM reception.

**AUX** : Can be set while accessing AUX source.

**ZZONE** : Can be set for sources other than the standby source by setting "ZON" of <Audio Setup> (page 25) to "ON".

— : Can be set during all sources.



- Refer to the respective page for information on how to set the items with reference page number.
- Only the items available to the current source are displayed.
- Strong electrical fields (such as from power lines) may cause unstable sound quality when CRSC is turned ON. In such a situation, turn it OFF.



\*Factory setting

Item	Setting	Entry	Setting overview	Condition	Page
"ZONE2"	"F"/"R"*	◀◀▶▶	Specifies the destination of sub source sound when the Dual Zone function is turned on.	<b>ZONE</b>	32
"AUTO1"/"AUTO2"/ "MANUAL"	"AUTO1"/"AUTO2"/ "MANUAL"	◀◀▶▶	Selects the tuning mode of the radio.	<b>Tuner</b>	31
"CRSC"	"OFF"/"ON"*	◀◀▶▶	Switches to Monaural to decrease noise when reception is poor.	<b>FM</b>	—
"NAME SET"		1 sec.	Sets the display when switched to AUX source.	<b>AUX</b>	14
"P/N"	"PAL"/"NTSC"	◀◀▶▶	Sets the color system for the monitor. You have to turn the power off after the setting is changed.	—	—
"M/V"			Displays the firmware version of Microvision.	<b>DVD</b>	—
"ABOOK"	"SL"/"NM"/"FA"	◀◀▶▶	Sets the audio book playback speed.	<b>iPod</b>	—
"SKIP"	"0.5%"/"1%"/ "5%"/"10%"	◀◀▶▶	Sets the ratio of skip performed with <Music/Video Search for iPod>.	<b>iPod</b>	21
"IART"	"OFF"/"ON"*	◀◀▶▶	Specifies whether or not the artworks of the music files are displayed.	<b>iPod</b>	—
"FILETYPE" > >"DISC" >"USB"	"A/V"/"PIC"	◀◀▶▶	Selects playback file type when a disc or USB contains different types of files. You can make advanced settings in the "FILE TYPE" of the Setup menu. "A" or "V" may appear on the display after setting.	<b>SB</b>	13
"SCL"	"AUTO"/"MANU"	◀◀▶▶	Specifies whether the text is scrolled automatically.	—	—
"AUX"	"OFF"/"ON1"/ "ON2"	◀◀▶▶	Sets whether to display AUX during source selection.	<b>SB</b>	31
"DEMO"	"OFF"/"ON"	2 sec.	Specifies whether to enable demonstration.	—	7
"DIVX"			Display the format version of DivX.	<b>DVD</b> <b>USB</b>	—

## "iPodCTRL"

Item	Setting	Entry	Setting overview	Condition	Page
"iPodCTRL"	"HANDS ON"/ "MODE OFF"*		When set to "HANDS ON", allows you to operate iPod with the control on the iPod.	<b>iPod</b>	22

## "DSP"

Item	Setting	Entry	Setting overview	Condition	Page
"CONTROL"	"EQ"	[AUD]	Sets the sound quality.	<b>SB</b>	25
	"B.BOOST"	"OFF"/ "STEP1"/"2"	◀◀▶▶ 	◀◀▶▶ <b>SB</b>	—
	"HIGHWAY"	"OFF"/ "STEP1"/"2"/ "3"/"4"	◀◀▶▶ 	◀◀▶▶ <b>SB</b>	32
	"POSITION"	[AUD]	Compensates the low volume or bass sound being lost by road noises to make vocal sound clearer.	<b>SB</b>	26
"SETUP"	"CABIN"	[AUD]	Compensates the sound environment in accordance with the listening position.	<b>SB</b>	27
	"SPEAKER"	[AUD]	Selects the car type to compensate the distance difference between each speaker.	<b>SB</b>	27
	"DTA"	[AUD]	Sets the connected speaker, speaker size, and installation position.	<b>SB</b>	28
	"X'OVER"	[AUD]	Makes fine adjustment of the compensation value specified at Cabin.	<b>SB</b>	28
"PRESET"	"RECALL"	[AUD]	Makes fine adjustment of the X'Over value specified at Speaker.	<b>SB</b>	29
	"MEMORY"	[AUD]	Registering the value setup by Sound Control. Recalling the sound setup registered by <Audio Preset Memory>.	<b>SB</b>	29
"DSP SET"	"BYPASS"/ "THROUGH"*		Setting "BYPASS" passes the DSP function. Setting "THROUGH" activates the DSP function.	<b>SB</b>	—

# Function Control/ Setup Menu

## Setup menu of remote control

By using the Setup menu, you can make various adjustments to items such as picture and sound. You can also set a language for the subtitles and the Setup menu, among other things.

### 1 Select DVD or USB source

Press the [SRC] button.

Select the "DVD" or "USB" display.

### 2 Press the [■] button.

### 3 Enter Setup menu mode

Press the [SETUP] button.

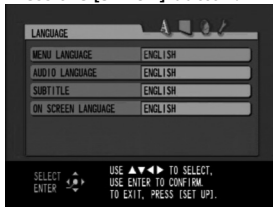

### 4 Press the [◀]/[▶] button to select the menu.

LANGUAGE/ PICTURE/ AUDIO/ OTHER

### 5 Press the [▲]/[▼] button to select the desired item, and then press the [ENTER] button.

To cancel pop-up menu, press the [RETURN] button.

### 6 Press the [▲]/[▼] button to select the desired setting, and then press the [ENTER] button to confirm your selection.

### 7 Exit Setup menu mode

Press the [SETUP] button.

The Setup menu ends.



- The memory cannot be erased by the Reset button.

## LANGUAGE

Item	Setting
MENU LANGUAGE/ AUDIO LANGUAGE	Selects the initial disc menu language and audio language. Refer to the language code list (page 33).
SUBTITLE	Selects the initial subtitle language or remove the subtitle (OFF). Refer to the language code list (page 33).
ON SCREEN LANGUAGE	Selects a language for the setup menu and on screen display.

## PICTURE

Item	Setting
MONITOR TYPE	<ul style="list-style-type: none"><li>• <b>16:9</b>: Select when a 16:9 wide TV is connected.</li><li>• <b>4:3 LETTERBOX</b>: Select when a standard 4:3 TV is connected. Displays a wide picture with bands on the upper and lower portions of the screen.</li><li>• <b>4:3 PAN SCAN</b>: Select when a standard 4:3 TV is connected. Automatically displays the wide picture on the entire screen and cuts off the portions that do not fit.</li></ul>
OSD POSITION	Selects the on-screen bar position on the monitor. <ul style="list-style-type: none"><li>• <b>1</b>: Higher position.</li><li>• <b>2</b>: Lower position (Guidance below the disc setup menu will disappear.)</li></ul>
iPod ARTWORK	<ul style="list-style-type: none"><li>• <b>ON</b>: Displays the artwork of your iPod.</li><li>• <b>OFF</b>: Does not display the artwork of your iPod.</li></ul>

## AUDIO

Item	Setting
DOWN MIX	<ul style="list-style-type: none"><li>• <b>SURROUND COMPATIBLE</b>: Uses multi-channel surround audio by connecting an amplifier compatible with Dolby Surround.</li><li>• <b>STEREO</b>: Normally select this.</li></ul>
D.RANGE COMPRESSION	You can enjoy a powerful sound at low or middle volume levels while playing a Dolby Digital software. <ul style="list-style-type: none"><li>• <b>NORMAL</b>: Reduce the dynamic range a little.</li><li>• <b>WIDE</b>: Enjoy a powerful sound at a low volume level with its full dynamic range.</li><li>• <b>DIALOG</b>: Reproduce the movie dialog more clearly.</li></ul>

## OTHER

Item	Setting
DivX REGISTRATION	This unit has its own Registration Code. Once you have played back a disc in which the Registration Code recorded, this unit's Registration Code is overwritten for copyright protection. <ol style="list-style-type: none"><li>1. Press the [ENTER] button to show Code.</li><li>2. Press the [ENTER] button to exit.</li></ol>  <ul style="list-style-type: none"><li>• When downloading a DivX VOD file controlled by DRM, register the code appeared on the screen such as the one above. Otherwise the file may not be able to play with this unit. Remaining number of viewing is displayed when playing a DivX VOD file with the viewing restriction. When the remaining number of viewing reached 0, a warning message appears and the file cannot be played.</li></ul>
FILE TYPE (DISC)/ FILE TYPE (USB)	Selects playback file type when a disc or USB contains different types of files. <ul style="list-style-type: none"><li>• <b>AUDIO</b>: Play Audio file (MP3, WMA, WAV).</li><li>• <b>STILL PICTURE</b>: Play JPEG file.</li><li>• <b>VIDEO</b>: Play Video file (MPEG, DivX).</li><li>• <b>AUDIO+VIDEO</b>: Play Audio or Video file.</li></ul>

# Clock/ Display Settings

## Manual Clock Adjustment

### 1 Select the Clock display

Press the [DISP] button.

### 2 Enter Clock adjustment mode

Press the [DISP] button for at least 1 second.

The clock display blinks.

### 3 Adjusting Clock

Operation type	Operation
Adjust the hours	Press the [FM+] or [AM-] button.
Adjust the minutes	Press the [◀] or [▶] button.

### 4 Exit Clock adjustment mode

Press the [DISP] button.

## Text Display Selection

Changing displayed information on each source following;

### In Tuner source

Information	Display
Frequency	"FREQ"
Clock	"CLOCK"

### In DVD/ Video CD source

Information	Display
Title number & Chapter number/ Program number & Chapter number	"TNO : CNO"*1 "PNO : CNO"*1
Track number & Play time*2	"P-TIME"
Clock	"CLOCK"

\*1 DVD-VIDEO or DVD-VR only

\*2 Track number and play time are not displayed with Video CD PBC On.

### In CD & External disc source

Information	Display
Disc title	"D-TITLE"
Track title	"T-TITLE"
Play time & Track number	"P-TIME"
Clock	"CLOCK"

### In Audio file/ Video file/ JPEG file source

Information	Display
Title & Artist name	"TITLE"*1
Album name & Artist name	"ALBUM"*1
Folder name	"FOLDER"
File name	"FILE"
Play time & File number*1	"P-TIME"
Clock	"CLOCK"

\*1 "JPEG" is displayed when a file is JPEG.

### In iPod source

Information	Display
Music title & Artist name	"TITLE"
Album name & Artist name	"ALBUM"
Play time & Music number	"P-TIME"
Clock	"CLOCK"

### In Standby/ Auxiliary input source

Information	Display
Source name	"SRC NAME"
Clock	"CLOCK"

### Select the text

Press the [DISP] button.



- When you select the clock display, the display setting of each source will be changed to the clock display.
- If the selected display item does not have any information, alternative information is displayed.
- If the iPod Control by Hand Mode is set to on while playing the iPod, "iPodMODE" is displayed.

## Auxiliary Input Display Setting

Selects the display when changing to Auxiliary input source.

### 1 Select Auxiliary input source

Press the [SRC] button.

Select the "AUX" display.

### 2 Enter Auxiliary input display setting mode

Press [Q] 1sec, and select "MENU" > "NAME SET".

Press the [AUD] knob for at least 1 second.

The presently selected Auxiliary input display is displayed.

- For how to select Function Control items, refer to <Function Control> (page 10).

### 3 Select the Auxiliary input display

Turn the [AUD] knob.

"AUX"/"DVD"/"PORTABLE"/"GAME"/"VIDEO"/"TV"

### 4 Exit Auxiliary input display setting mode

Press the [Q] button.



- When operation stops for 10 seconds, the name at that time is registered, and the Auxiliary input display setting mode closes.
- The Auxiliary input display can be set only when the built-in auxiliary input or the auxiliary input of optional KCA-S220A is used. On the KCA-S220A, "AUX EXT" is displayed by default.

### Theft Deterrent Faceplate

The faceplate of the unit can be detached and taken with you, helping to deter theft.

#### Removing the Faceplate

**Press the Release button.**

The faceplate unlocks, allowing you to detach it.



- The faceplate is a precision piece of equipment and can be damaged by shocks or jolts.
- Keep the faceplate in its faceplate case while detached.
- Do not expose the faceplate (and the faceplate case) to direct sunlight or excessive heat or humidity. Also avoid places with too much dust or the possibility of water splashing.
- To prevent deterioration, do not touch the terminals of the unit or faceplate with your fingers.

#### Reattaching the Faceplate

**Refer to the following diagram when reattaching the faceplate.**

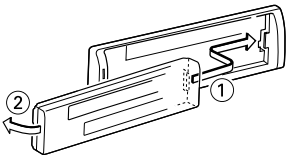

### Frequency Step Setting

Changing the tuning frequency step.

The original setting is FM band 50 kHz, and AM band 9 kHz.

#### 1 Turn the power OFF

**Press the [SRC] button for at least 1 second.**

#### 2 Switch the frequency step

**While pressing the [1] and [5] buttons, press the [SRC] button.**

Release your fingers from the button after the display appears.

The frequency step changes to FM band 200 kHz, and AM band 10 kHz.



- When the same operation is repeated, the frequency step returns to the original setting.
- When the frequency step is changed, the frequencies in the memory are deleted.

# Disc/ USB Operations of Remote Control

## Before Use

- Turn on the monitor to watch the playback picture. If you turn on the monitor, you can also control playback of other discs by referring to the monitor screen.
- Set the remote controller mode switch to "DVD" mode before starting operation, refer to <Remote Controller mode switch> (page 30).

## Playing a Disc

### Inserting a disc in the unit

"READING" appears on the display, and playback starts automatically.

- If playback does not start, press [▶II].
- In some cases, the disc menu might appear instead.



- The menu screen may be displayed first after loading a DVD or Video CD 2.0 which offers a menu.
- DVDs may have a region code. Your player does not play discs that have a region code different from your player. About the region code, refer to Region code (page 6).
- The playback file may be different depending on the file type set for Audio, Video and JPEG files. (page 13)

## Playing a USB device

### Connecting the USB device

For a USB device that includes audio files, video files, or photo files, "READING" appears in the display, and playback starts automatically.



- The playback file may be different depending on the file type set for Audio, Video and JPEG files. (page 13)

## Basic Operation

### Playing or pausing

Press the [▶II] button.

### Stopping the play

Press the [■] button.

### Searching for a chapter/ scene/ track/ file

Press the [◀◀] or [▶▶] button.

### Selecting a title/ folder

JPEG Audio File

Press the [FM+] or [AM-] button.

### Fast Forwarding or Fast Backwarding

Press the [◀◀] or [▶▶] button repeatedly to select the required speed.

x2, x5, x10, x20, x60 DVD-VIDEO DVD-VR VideoCD CD  
Audio File

1, 2, 3 MPEG/DivX®

### Slow Forwarding or Backwarding

Video CD

- 1 Press the [▶II] button to pause.
- 2 Press the [◀◀] or [▶▶] button repeatedly to select the required speed.

1/32, 1/16, 1/8, 1/4, 1/2



- Slow motion playback in reverse is not possible with DVD-VR or Video CDs.

### Forward frame-by-frame playback

Video CD

- 1 Press the [▶II] button to pause.
- 2 Press the [▶▶I] button.

### 5 minutes skip

MPEG/DivX®

Press the [◀] or [▶] button.

Skips from the head of a file at five-minute intervals.

Example: 1:23 → 5:00 → 10:00



- The operation is enabled when the Status and Control bars are not displayed.

### Camera angle

If the disc contains scenes recorded at different camera angles, you can change to a different camera angle during playback.

Press the [ANGLE] button repeatedly during playback to select a desired angle.

The number of the current angle appears on the display.

### Subtitles

DVD-VIDEO DVD-VR MPEG/DivX®

Press the [SUBTITLE] button repeatedly during playback to see the different subtitle languages.

### Changing the audio stream

MPEG/DivX®

Press the [AUDIO] button repeatedly during playback to hear a different audio stream.

### Changing the audio channel

Video CD  
Press the [AUDIO] button repeatedly during playback to hear a different audio channel (STEREO, Left or Right).



## Displaying Status and Control

### on-screen DVD-VIDEO DVD-VR Video CD MPEG/DivX\* JPEG

You can display various information about the disc loaded on-screen.

#### Example: DVD-VIDEO

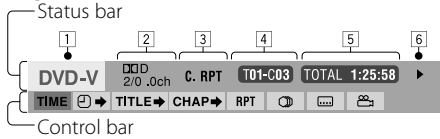

#### Status bar

- 1 Disc type
- 2 DVD: Audio signal format type and channel  
Video CD: PBC
- 3 Playback mode  
"T.RPT" (Title/ Track repeat), "C.RPT" (Chapter repeat), "PG.RPT" (Program repeat), "F.RPT" (Folder repeat)  
"F.RND" (Folder random), "A.RND" (All random)
- 4 Playback information  
"T" (Title/ Track), "C" (Chapter), "PG" (Program), "PL" (Play list), "F" (Folder/ File)
- 5 Time indication
- 6 Playback status  
"▶" (Play), "⏸" (Pause), "■" (Stop), "▶▶"/"◀◀"  
(Forward/reverse search), "▶"/"◀" (Forward/  
reverse slow-motion)

#### Control bar

Format	Icon	Operation
DVD-VIDEO	TIME	Switches the Chapter time ("TIME"), remaining chapter ("REM"), Title time ("TOTAL"), and remaining title ("T.REM").
	☞	Refer to <Time search> (page 18).
	TITLE	Direct Title Search.
	CHAP	Direct Chapter Search.
	RPT	Switches the Chapter repeat ("CHAPTER"), Title repeat ("TITLE"), and repeat off ("OFF").
	🔊	Changes the audio stream.
	🗣️	Changes the subtitle language.
DVD-VR	📷	Changes the camera angle.
	TIME	Switches the Program/ Play list time ("TOTAL"), remaining program/ play list ("T.REM").
	☞	Refer to <Time search> (page 18).
	CHAP	Direct Chapter Search.
	RPT	Switches the Chapter repeat ("CHAPTER"), Program repeat ("PROGRAM"), and repeat off ("OFF").

Video CD	🔊	Changes the audio stream.
	🗣️	Changes the subtitle language.
	TIME	Switches the Track time ("TIME"), remaining track ("REM"), Disc time ("TOTAL"), and remaining disc ("T.REM").
	☞	Refer to <Time search> (page 18). <sup>*1</sup>
	TRACK	Direct Track Search. <sup>*1</sup>
	RPT	Switches the Track repeat ("TRACK"), and repeat off ("OFF"). <sup>*1</sup>
MPEG/DivX*	RND	Switches the Disc random ("ALL"), and random off ("OFF"). <sup>*1</sup>
	🔊	Changes the audio channel.
	RPT	Switches the File repeat ("TRACK"), Folder repeat ("FOLDER"), and repeat off ("OFF").
	RND	Switches the Folder random ("FOLDER"), All random ("ALL"), and random off ("OFF").
	🔊	Changes the audio stream.
	🗣️	Changes the subtitle language.
JPEG	RPT	Switches the Folder repeat ("FOLDER"), and repeat off ("OFF").

<sup>\*1</sup>While PBC is not in use.

#### 1 Press the [OSD] button during playback.

Pressing the button repeatedly selects Status bar, Status & Control bar, and Status bar off sequentially.

#### 2 Press the [◀] or [▶] button during control bar on-screen to select an item. Press the [ENTER] button.

➡ To cancel pop-up menu, press the [RETURN] button.

#### 3 Press the [▲] or [▼] button to change or select the setting. Press the [ENTER] button.

# Disc/ USB Operations of Remote Control

## DVD-VIDEO Disc Menu

DVDs may offer menus that allow you to access special features.

- 1 Press the [MENU] button**  
The disc menu is displayed.
- 2 Use the [▲]/[▼]/[◀]/[▶] button to highlight your selection, then press the [ENTER] button.**
- 3 To return to the first menu feature, press the [TOP MENU] button again.**
- 4 To remove the disc menu, press the [MENU] button again.**

## DVD-VR Menu

Selects an option from the DVD-VR Disc menu.

- 1 Press the necessary operation button**  
In case of Program list : [TOP MENU]  
In case of Play list : [MENU]

ORIGINAL PROGRAM				
No	Date	Ch	Time	Title
1	25/04/07	4ch	19:00	Kenwood
2	17/05/07	8ch	10:30	
3	22/05/07	8ch	17:00	Musical Festival

PLAY LIST				
No	Date	Chap	Length	Title
1	25/05/07	001	1:03:16	Kenwood
2	17/06/07	005	1:35:25	
3	20/06/07	003	0:10:23	Favorite music

- 2 Use the [▲] or [▼] button to highlight your selection, then press the [ENTER] button**  
To remove the disc menu, press the [MENU] button or the [TOP MENU] button again

## Video CD PBC Menu

Press [RETURN] to return to the menu screen. Menu settings and operating procedures may differ. Follow the instructions on the each menu screen.

### Canceling the PBC playback

- 1 Press the [■] button to stop**
- 2 Press the [DIRECT] button**
- 3 Press the number buttons**
- 4 Press the [ENTER] button**  
To resume PBC, press [TOP MENU] or [MENU].

## Zoom

The zoom function allows you to enlarge the video image.

DVD-VIDEO DVD-VR VideoCD MPEG

Press the [ZOOM] button repeatedly during playback or in the pause mode to enlarge the image.

OFF, 1 – 6

You can move through the zoomed picture using [▲]/[▼]/[◀]/[▶].

JPEG

- 1 Press the [▶II] button to pause**
- 2 Press the [ZOOM] button repeatedly to enlarge the image**  
OFF, 1, 2  
You can move through the zoomed picture using [▲]/[▼]/[◀]/[▶].

## Time Search DVD-VIDEO DVD-VR VideoCD



The Time Search function allows you to start playing at any chosen time on the disc.

- 1 Press the [OSD] button twice briefly during playback**
- 2 Press the [◀] or [▶] button to select the Time Search icon in the on-screen display. Press the [ENTER] button.**  
The “\_ : \_ : \_ ” appears in the Time Search box.
- 3 Press the [▲] or [▼] button to change the number, then press the [◀] or [▶] button to move to the next entry**
- 4 Press the [ENTER] button to confirm the start time**  
Playback starts from the selected time on the disc.  
If you enter an invalid time, playback will continue from the current point.

## Direct Search

Searching the chapter by entering the number.

- 1 Select the search mode**  
Press the [DIRECT] button.  
Each time you press the button, the search mode alternates between the modes.

- DVD-VIDEO** Chapter search ("CHAP"), Title search ("TITL"), and Search mode off.
- DVD-VR** Chapter search ("CHAP"), Program/Play list search ("PRGM"/ "PLST"), and Search mode off.
- VideoCD** Track search ("TRAC"/"NMBR"\*), and Search mode off. \*PBC ON only for VCD
- MPEG/DivX®** Track search ("TRAC" or "Track Search"), Folder search ("FOLD" or "Folder Search"), and Search mode off.
- Audio File** Folder search ("FOLD" or "Folder Search"), and Search mode off.
- JPEG** File search ("FILE", "TRAC" or "Track Search"), Folder search ("FOLD" or "Folder Search"), and Search mode off when pressed while playing a JPEG.

- 2 Press the number buttons
- 3 Press the [ENTER] button



- Direct Search cannot be performed during Random play.
- The Search mode is cleared automatically after approximately 5 seconds.
- "0" is not displayed in the first digit by pressing the [0] button.  
Example: "- -" → Press [0], [2] → "- 2".

## File Select **MPEG/DivX®** **JPEG** **Audio File** **CD**

You can select a file from the list display.

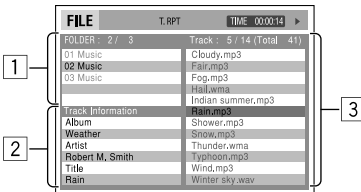

- 1 Folder list
- 2 Track information
- 3 Track list

### 1 Show the control screen

- MPEG/DivX®** **JPEG** Press the [■] button to stop.
- Audio File** **CD** Automatically appear during play.

### 2 Press [◀] or [▶] to select "Folder" column or "Track" column **MPEG/DivX®** **JPEG** **Audio File**

### 3 Press the [▲] or [▼] button to select a folder or track

### 4 Start playback

- MPEG/DivX®** **JPEG** Press the [ENTER] button.
- Audio File** **CD** Playback starts automatically.



- An image is displayed at the folder list position when an album art is attached to the tag of a playing audio file.

## To select a playback mode

### 1 Show the Playback mode selection screen

Press the [OSD] button.

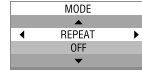

### 2 Press the [◀] or [▶] button to select a playback mode **Audio File** **CD**

"REPEAT"/"RANDOM"

### 3 Press the [▲] or [▼] button to select an item

"REPEAT": Track/File repeat\*<sup>1</sup> ("TRACK"), Folder repeat\*<sup>2</sup> ("FOLDER"), and repeat off ("OFF").

"RANDOM"\*<sup>1</sup>: Folder random ("FOLDER"), All random ("ALL"), and random off ("OFF").

\*<sup>1</sup> Not selectable for JPEG

\*<sup>2</sup> Not selectable for CD

### 4 Press the [ENTER] button

## List screen

Folder	153/240	Track	154/198	Page	4 / 6
fol130	fol140	fol150	fol160		
fol131	fol141	fol151	fol161		
fol132	fol142	fol152	fol162		
fol133	fol143	fol153	fol163		
fol134	fol144	fol154	fol164		
fol135	fol145	fol155	fol165		
fol136	fol146	fol156	fol166		
fol137	fol147	fol157	fol167		
fol138	fol148	fol158	fol168		
fol139	fol149	fol159	fol169		

### 1 Press the [■] button to stop

### 2 Show the list screen

Press the [MENU] or [TOP MENU] button.

### 3 Select an item from the folder list

Use [▲]/[▼]/[◀]/[▶] to highlight your selection, and then press the [ENTER] button.

### 4 Select a track to start playing

Use [▲]/[▼]/[◀]/[▶] to highlight your selection, and then press the [ENTER] or [▶] button.

↳ To go back to the folder list, press the [RETURN] button.

### 5 To remove the List screen, press the [MENU] button again.

# iPod Operations of Remote Control

## Before Use

- Video output setting of iPod needs to be set on your iPod.
- Turn on the monitor to watch the playback picture. If you turn on the monitor, you can also control playback of other discs by referring to the monitor screen.
- Set the remote controller mode switch to "DVD" mode before starting operation, refer to <Remote Controller mode switch> (page 30).

## Playing the iPod

### Connecting the iPod

"READING" appears in the display, and playback starts automatically.

### Playing or pausing

Press the [▶||] button.

### Stopping the play

Press the [■] button.

### Searching for a file

Press the [◀◀] or [▶▶] button.

### Fast Forwarding or Fast Backwarding

Press the [◀◀] or [▶▶] button.

## Search Mode

You can select a file from the list display.

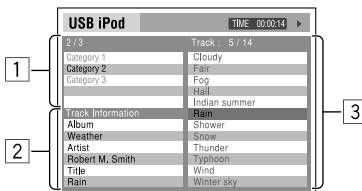

- 1 Category list
- 2 Track information
- 3 Track list

### 1 Enter Search mode

Press the [TOP MENU] or [MENU] button.

### 2 Select an menu item

Press the [▲] or [▼] button to select a menu Music/ Shuffle Songs

## 3 Search for music

Operation type	Operation
Movement between items	Press the [▲] or [▼] button.
Selection of item	Press the [ENTER] or [▶] button.
Return to previous item	Press the [◀] or [MENU] button.
Return to Top menu	Press the [TOP MENU] button.
Canceling the Search mode	Press the [RETURN] button.



- An image is displayed in the category list when a playing song has artwork with "MENU" > "ART" (page 11) of the <Function Control> set to ON.
- It takes some seconds to read artwork. You cannot operate during the read operation.

## To select a playback mode

### 1 Show the Playback mode selection screen

Press the [OSD] button.

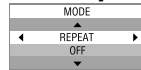

### 2 Select a playback mode

Press the [◀] or [▶] button.

"REPEAT"/ "RANDOM"/ "AUDIO BOOK"

### 3 Select an item

Press the [▲] or [▼] button.

"REPEAT": File repeat ("ONE"), All repeat ("ALL"), and repeat off ("OFF").

"RANDOM": Song random ("SONGS"), Album random ("ALBUMS"), and random off ("OFF").

"AUDIO BOOK": Normal speed ("NORMAL"), Faster speed ("FASTER"), and Slower speed ("SLOWER").

### 4 Press the [ENTER] button

# Music disc/Audio file/iPod Operation of Control Panel

## Music/Video Search Audio File CD MPEG/DivX® JPEG

Selecting the track/ file you want to listen to from the device or media being played now.

### 1 Enter Music/Video Search mode

Press the [Q] button.

"SEARCH" is displayed.

Displays the current Audio file name.

### 2 Search for track/ file

Audio File MPEG/DivX® JPEG

Operation type	Operation
Movement between folders/files	Turn the [AUD] knob, or press the [FM+]/[AM-] button.
Selection of folder/file	Press the [AUD] knob or [▶▶] button.
Return to previous folder	Press the [◀◀] button.
Return to root folder	Press the [◀◀] button for at least 1 second.

 : Indicates that your selection is a folder.

 : Indicates that your selection is a file.

 The folder tree is not displayed and only folders with files are displayed in order. Refer to <Playing order of the Audio file> (page 4).

CD

Operation type	Operation
Movement between track	Turn the [AUD] knob, or press the [FM+]/[AM-] button.
Selection of track	Press the [AUD] knob.
Return to first track	Press the [◀◀] button for at least 1 second.

### Cancelling the Music/Video Search mode

Press the [Q] button.



- Music/Video Search cannot be performed during Random play.

## Music Search for iPod

Search for the song (in iPod) you want to play.

### 1 Enter Music Search mode

Press the [Q] button.

"SEARCH" is displayed.

### 2 Search for song

Operation type	Operation
Movement between items	Turn the [AUD] knob.
Skip Search *1	Press the [◀◀] or [▶▶] button.
Selection of item	Press the [AUD] knob.
Return to previous item	Press the [FM+] button.
Return to Top menu	Press the [FM+] button for at least 1 second.
Search by initial	Press the [Q] button for at least 1 second.

The position of the currently displayed item is indicated by the icon bar in eight steps.

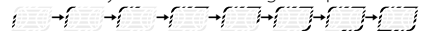

### Cancelling the Music Search mode

Press the [Q] button.

### Searching for Music by Initial

You can select an alphabetic character from the list in the browse item (artist, album, etc.) selected now.

### 1 Enter alphabet search mode

Press the [Q] button for at least 1 second.

"A B C ..." is displayed.

- If you can not search for a song by an alphabetic character in the browse item selected now, the data on the screen does not change.

### 2 Select the initial to be searched for

Operation type	Operation
Move to the next character.	Turn the [AUD] knob, or press the [◀◀]/[▶▶] button.
Move to the next row.	Press the [FM+] or [AM-] button.
Cancelling the alphabet search mode	Press the [Q] button.

### 3 Determine the selected initial

Press the [AUD] knob.

Start search. When search is completed, the Music Search mode is selected again at the selected character position.

# Music disc/Audio file/iPod Operation of Control Panel



- \*1 Skip Search: The number of songs to be skipped is determined by the ratio of the total number of songs in the list which is selected now. Set the ratio with "SKIP" in <Function Control> (page 11). Keep pressing this button for 3 seconds or longer skips songs at 10% irrespective of the setting.
- The time of search by alphabet may become long depending on the number of songs in iPod or the folder structure.
- When selecting an initial in the alphabet search mode, entering "\*" searches symbols and entering "1" searches digits.
- If the first character string begins with an article "a", "an", or "the" in the alphabet search mode, it is searched for in defiance of the article.

## iPod Control by Hand Mode

Allows you to operate iPod with the control on the iPod.

Display	Setting
"HANDS ON"	iPod control by hand mode is ON.
"MODE OFF"	iPod control by hand mode is OFF.

### 1 Enter iPod Control by Hand Mode

Press [Q] 1sec., and select "iPodCTRL".

Press the [AUD] knob.

- For how to select Function Control items, refer to <Function Control> (page 10).

### 2 Set the iPod Control by Hand Mode

Turn the [AUD] knob.

### 3 Exit iPod Control by Hand Mode

Press the [Q] button.



- In the iPod Control by hand mode, iPod cannot be operated using this unit.
- This mode is not compatible with music information display. The display will show "iPodMODE".
- The following iPods cannot be controlled using this unit. iPod nano (1st generation), and iPod with video. (KCA-iP102 (optional accessory) connected only.)
- When you cancel the hand mode while playing a video file, the video file stops and a music file starts.

## Basic Operation of Disc Changer (Optional)

---

### **Selecting CD changer source**

Press the [SRC] button.

Select the "CD CH" display.

### **Playing or pausing**

Press the [6] button.

### **Music search**

Press the [◀◀] or [▶▶] button.

Changes the music when this button is pressed.

Fast reverses or forwards the music while pressing.

### **Disc Search**

Press the [FM+] or [AM-] button.

### **Playing the Current Song or Disc Repeatedly (Repeat play)**

Press the [4] button.

Pressing the button repeatedly selects Track Repeat play on ("TRAC REP"), Disc Repeat play on ("DISC REP"), and Repeat play off ("REP OFF") sequentially.

### **Playing the first part of each music on the disc (Scan play)**

Press the [2] button.

Successively plays the intro of the music in the disc. When Scan Play is turned on, "TRAK SCN" is displayed.



- To use the functions written as the [SCN] button in the option manual, press the [2] button.

### **Playing all the music on the disc in random order (Random play)**

Press the [3] button.

Randomly plays the music in the disc.

When Random Play is turned on, "DISC RDM" is displayed.

### **Playing the music in the disc changer randomly (Magazine random play)**

Press the [5] button.

Pressing the button toggles the setting between Magazine random play on ("MGZN RDM") and off ("RDM OFF").

### **Searching the music by entering the track number (Direct Music Search)**

- 1 Set the remote controller mode switch to "AUD" mode
2. Press the number buttons on the remote control.

### 3. Press the [◀◀] or [▶▶] button.

- Press the [▶▶] button to cancelling Direct Music Search.



- Direct Music Search cannot be performed during playing of Random play, or scan play.

### **Searching the disc by entering the disc number (Direct Disc Search)**

- 1 Set the remote controller mode switch to "AUD" mode
2. Press the number buttons on the remote control.
3. Press the [FM+] or [AM-] button.
  - Press the [▶▶] button to cancelling Direct Disc Search.



- Direct Disc Search cannot be performed during playing of Random play, or scan play.
- Input "0" to select disc 10.



- Set the remote controller mode switch to "AUD" mode before starting operation, refer to <Remote Controller mode switch> (page 30).

# Other Functions

## Activating Security Code

When Security Code is set, possibility of theft is reduced because input of Security Code is prompted to turn on the unit once it is turned off.



- You can set the Security Code with a 4 digit number of your choice.
- The Security Code cannot be displayed or referenced. Make a note of the Security Code and treasure it up.

### 1 Select Standby

Press the [SRC] button.

Select the "STANDBY" display.

### 2 Enter Security Code mode

Press [Q] 1 sec, and select "MENU" > "CODE SET".

Press the [AUD] knob for at least 1 second.

When "ENTER" is displayed, "CODE" is also displayed.

- For how to select Function Control items, refer to <Function Control> (page 10).

### 3 Enter Security Code

Operation type	Operation
Select the digits to enter	Press the [◀◀] or [▶▶] button.
Select the Security Code numbers	Turn the [AUD] knob, or press the [FM+]/ [AM-] button.

### 4 Confirm the Security Code

Press the [AUD] knob for at least 3 seconds.

When "RE-ENTER" is displayed, "CODE" is also displayed.

### 5 Do the step 3 through 4 operation, and reenter the Security Code.

"APPROVED" is displayed.

The Security Code function activates.



- If you enter the wrong Code in steps 3 through 4, repeat from step 3.
- When the Security Code function is activated, "CODE SET" changes to "CODE CLR".
- To deactivate the Security Code function, see the next section <Deactivating Security Code>.

### 6 Exit Security Code mode

Press the [Q] button.

## Entering Security Code

The Security Code is required to use the audio unit when the unit is first used after removed from the battery power source or the Reset button is pressed.

### 1 Turn the power ON.

### 2 Do the step 3 through 4 operation, and enter the Security Code.

"APPROVED" is displayed.

Now, you can use the unit.

## Deactivating Security Code

Deactivating the Security Code function.

### 1 Select Standby

Press the [SRC] button.

Select the "STANDBY" display.

### 2 Enter Security Code mode

Press [Q] 1 sec, and select "MENU" > "CODE CLR".

Press the [AUD] knob for at least 1 second.

When "ENTER" is displayed, "CODE CLR" is also displayed.

- For how to select Function Control items, refer to <Function Control> (page 10).

### 3 Enter Security Code

Operation type	Operation
Select the digits to enter	Press the [◀◀] or [▶▶] button.
Select the Security Code numbers	Turn the [AUD] knob, or press the [FM+]/ [AM-] button.

### 4 Press the [AUD] knob for at least 3 seconds.

"CLEAR" is displayed.

The Security Code function deactivates.

### 5 Exit Security Code mode

Press the [Q] button.



# Audio Adjustments

## Audio Control

You can adjust following Audio Control items ;

Adjustment Item	Display	Range
Rear volume	"R-VOL"	0 — 35
AV output volume	"AVVOL"	0 — 35
Subwoofer level	"SW L"	-15 — +15
Balance	"BAL"	Left 15 — Right 15
Fader	"FAD"	Rear 15 — Front 15

*Exit Audio Control mode (Volume control mode)*

**1 Select the source to adjust**  
Press the [SRC] button.

**2 Enter Audio Control mode**  
Press the [AUD] knob.

**3 Select the Audio item to adjust**  
Press the [AUD] knob.

**4 Adjust the Audio item**  
Turn the [AUD] knob.

**5 Exit Audio Control mode**  
Press any button.

Press a button other than the [AUD] knob or [▲] button.

## Audio Setup

You can set Sound system, such as follows;

Adjustment Item	Display	Range
Volume offset	"V-OFF"	-8 — ±0 (AUX: -8 — +8)
Dual Zone System	"2ZON"	OFF/ DVD/ USB/ AUX
AV output source	"AV/O"	OFF/ DVD/ USB



- Volume offset: Sets each source's volume as a difference from the basic volume.
- Dual Zone System  
Main source and sub source (DVD, USB, AUX) output Front channel and Rear channel separately.
  - Set the preout to "R" or "SW" in "MENU" > "SWPRE" (page 10) of <Function Control>.
  - Set up the channel of sub source by "ZONE2" of <Function Control> (page 11).
  - Select Main source by [SRC] button.
  - Adjust the volume of Front channel by [AUD] knob.
  - Adjust the volume of Rear channel by <Audio Control> (page 25) or [▲]/[▼] button on the remote control (page 30).
  - The Audio Control has no effect on sub source.
  - "USB" and "DVD" cannot be set at the same time for the main and sub sources.

- AV output source  
The sub source (DVD, USB) can be output to the AV output separately from the main source.
  - Set the preout to "AV" in "MENU" > "SWPRE" (page 10) of <Function Control>.
  - Adjust the volume of AV output source by <Audio Control> (page 25).
  - "USB" and "DVD" cannot be set at the same time for the main and AV output sources.
- Dual Zone System and the AV output source cannot be used at the same time. Turn off the setting currently used and then set the next function.

**1 Select the source to adjust**  
Press the [SRC] button.

**2 Enter Audio Setup mode**  
Press the [AUD] knob for at least 1 second.

**3 Select the Audio Setup item to adjust**  
Press the [AUD] knob.

**4 Adjust the Audio setup item**  
Turn the [AUD] knob.

**5 Exit Audio Setup mode**  
Press the [AUD] knob for at least 1 second.

## Preset Equalizer Select

You can select following Equalizer curve;

Preset Equalizer	Display	Preset Equalizer	Display
User*	"USER"	Jazz	"JAZZ"
Rock	"ROCK"	Game	"GAME"
Pops	"POPS"	iPod (During iPod source only)	"iPod"
Easy	"EASY"	Natural	"NATURAL"
Top 40	"TOP40"		

\* The Equalizer curve set in the section <Manual Equalizer Control> is recalled.

**1 Enter Preset Equalizer mode**  
Press [Q.] 1sec. and select "DSP" > "CONTROL" > "EQ" > "PRESET".

Press the [AUD] knob.

- For how to select Function Control items, refer to <Function Control> (page 11).

**2 Select the Equalizer curve**  
Turn the [AUD] knob and push the center when the desired item is displayed.

You can select from 22 Equalizer curve types for iPod when "iPod" is selected.

Next page ►

# Audio Adjustments

## Select the iPod Equalizer curve

### 1. Enter iPod Equalizer mode

Press the [AUD] knob.

### 2. Select the iPod Equalizer curve

Turn the [AUD] knob and push the center when the desired item is displayed.

### 3 Exit Preset Equalizer mode.

Press the [Q] button.



- You can select for each source.

## Manual Equalizer Control

You can adjust following Equalizer Control items;

Adjustment Item	Range
Band level "BAND#" > "GAIN"	-9 - 0 - +9
Bass Effect* "BAND1" > "EFFECT"	"OFF"/"ON"

- \*Can be only set for "BAND1".

### 1 Enter Manual Equalizer Control mode

Press [Q] **1 sec.**, and select "DSP" > "CONTROL" > "EQ" > "MANUAL".

Press the [AUD] knob.

- For how to select Function Control items, refer to <Function Control> (page 10).

### 2 Select the band you want to set

Turn the [AUD] knob and push the center.  
"BAND1" - "BAND5"

### 3 Select the item you want to set

Turn the [AUD] knob and push the center.

### 4 Set the value

Turn the [AUD] knob and push the center when the desired item is displayed.

### 5 Exit Manual Equalizer Control mode

Press the [Q] button twice.



- When "iPod" is selected in the section <Preset Equalizer select> (page 25), Manual Equalizer Control is disabled.
- You can select for each source.

## Position Control

According to the listening position, select the position from the following settings so that the normal position of the sound environment can be compensated in accordance with the selected position;

## Preset position "PRESET"

Adjustment Item	Display	Adjustment Item	Display
Not compensating.	"ALL"	Front-Right seat	"F-RIGHT"
Front-Left seat	"F-LEFT"	Front seat	"F-ALL"

## Manual position "MANUAL"

Adjustment Item	Display	Adjustment Item	Display
Front Left speaker	"F-LEFT"	Subwoofer Left	"SW-LEFT"
Front Right speaker	"F-RIGHT"	Subwoofer Right	"SW-RIGHT"
Rear Left speaker	"R-LEFT"	Initialize the setting	"INITIAL"
Rear Right speaker	"R-RIGHT"	values.	

### 1 Enter Preset position setting mode

Press [Q] **1 sec.**, and select "DSP" > "CONTROL" > "POSITION" > "PRESET".

Press the [AUD] knob.

- For how to select Function Control items, refer to <Function Control> (page 10).

### 2 Select the seat you want to compensate

Turn the [AUD] knob and push the center when the desired item is displayed.

### 3 Exit Preset position setting mode

Press the [Q] button.

*You can fine-adjust your listening position.*

### 1 Enter Manual position adjust mode

Press [Q] **1 sec.**, and select "DSP" > "CONTROL" > "POSITION" > "MANUAL".

Press the [AUD] knob.

### 2 Select the speaker you want to set

Turn the [AUD] knob and push the center.

- Selecting "INITIAL" initializes the Manual position adjustment.

### 3 Set the value

Turn the [AUD] knob and push the center when the desired value is displayed.  
Adjust between 0 and 170 cm.

### 4 Exit Manual position adjust mode

Press the [Q] button twice.



- About the position setting  
First, set the using environment with <DTA (Digital Time Alignment) Setting> (page 28).
- When using the Subwoofer Left and Subwoofer Right as a single sub woofer, set the left side and right side to the same value.

## Cabin Selection

You can compensate the delay of the sound arrival time by selecting your environment from the following car types;

Car type	Display	Car type	Display
Not compensating.	"OFF"	Minivan	"MINIVAN"
Compact car	"COMPACT"	Sport-utility vehicle	"SUV"
Full size car	"FULLSIZE"	Minivan long	"MV LONG"
Station wagon	"WAGON"		

### 1 Enter Cabin select mode

Press [Q] 1sec, and select "DSP" > "SETUP" > "CABIN".

Press the [AUD] knob.

- For how to select Function Control items, refer to <Function Control> (page 10).

### 2 Select the car type

Turn the [AUD] knob and push the center when the desired item is displayed.

### 3 Exit Cabin select mode

Press the [Q] button.



- You can compensate the distances in more details by using <DTA setting> (page 28) function.

## Speaker Setting

Setting the speaker to be connected, speaker size, and installation position;

Setting item	Range
Front Speaker Location "FRONT" > "LOCATION"	"DOOR"/"ON DASH"/"UND DASH" (Under dash)
Front Speaker Size "FRONT" > "SIZE"	O.E.M./ 10 cm/ 13 cm/ 16 cm/ 17 cm/ 18 cm/ 4×6/ 5×7/ 6×8/ 6×9/ 7×10
Front Tweeter "FRONT" > "TWEETER"	"NONE"/"USE"
Rear Speaker Location "REAR" > "LOCATION"	• "DOOR"/"R-DECK" • "2ND ROW"/"3RD ROW" (Minivan/Minivan long)
Rear Speaker Size "REAR" > "SIZE"	None/ O.E.M./ 10 cm/ 13 cm/ 16 cm/ 17 cm/ 18 cm/ 4×6/ 5×7/ 6×8/ 6×9/ 7×10
Subwoofer Size "SUB-W" > "SIZE"	None/ 16 cm/ 20 cm/ 25 cm/ 30 cm/ 38 cm over

### 1 Enter Speaker Setting mode

Press [Q] 1sec, and select "DSP" > "SETUP" > "SPEAKER".

Press the [AUD] knob.

- For how to select Function Control items, refer to <Function Control> (page 10).

### 2 Select the speaker you want to set

Turn the [AUD] knob and push the center.  
"FRONT"/"REAR"/"SUB-W"

### 3 Select the item you want to set

Turn the [AUD] knob and push the center.

### 4 Set the value

Turn the [AUD] knob and push the center when the desired item is displayed.

### 5 Exit Speaker Setting mode

Press the [Q] button twice.

# Audio Adjustments

## X'Over Setting

You can set a X'Over value for the speakers;

Setting item	Range
Front High Pass Filter "FRONT" > "FC"	"THRU" (Through)/ 30/ 40 / 50/ 60/ 70/ 80/ 90/ 100/ 120/ 150/
Rear High Pass Filter "REAR" > "FC"	180/ 220/ 250 Hz
Front High Pass Slope "FRONT" > "SLOPE"	-6/ -12/ -18/ -24 dB/Oct.
Rear High Pass Slope "REAR" > "SLOPE"	
Subwoofer Low Pass Filter "SUB-W" > "FC"	30/ 40/ 50/ 60/ 70/ 80/ 90/ 100/ 120/ 150/ 180/ 220/ 250 Hz/ "THRU" (Through)
Subwoofer Low Pass Slope "SUB-W" > "SLOPE"	-6/ -12/ -18/ -24 dB/Oct.
Subwoofer Phase "SUB-W" > "PHASE"	REVERSE (180°)/ NORMAL (0°)

### 1 Enter X'Over setting mode

Press [Q] 1 sec, and select "DSP" > "SETUP" > "X'OVER".

Press the [AUD] knob.

- For how to select Function Control items, refer to <Function Control> (page 10).

### 2 Select the speaker you want to set

Turn the [AUD] knob and push the center.

"FRONT"/ "REAR"/ "SUB-W"

### 3 Select the item you want to set

Turn the [AUD] knob and push the center.

### 4 Set the X'Over value

Turn the [AUD] knob and push the center when the desired value is displayed.

### 5 Exit X'Over setting mode

Press the [Q] button twice.

## DTA (Digital Time Alignment) Setting

Adjusting fine tuning of the speaker position compensation value specified at <Cabin selection> (page 27).

### 1 Enter DTA setting mode

Press [Q] 1 sec, and select "DSP" > "SETUP" > "DTA".

Press the [AUD] knob.

- For how to select Function Control items, refer to <Function Control> (page 10).

### 2 Select the speaker you want to set

Turn the [AUD] knob and push the center.

"FRONT" (Front speaker)/ "REAR" (Rear speaker)/ "SUB-W" (Subwoofer )

### 3 Set the compensation value of the speaker position

Turn the [AUD] knob and push the center when the desired value is displayed.

Adjust between 0 and 440 cm.

- ➦ Refer to <Appendix> (page 31) on how to set the compensation value.

### 4 Exit DTA setting mode

Press the [Q] button.

## Audio Preset Memory

---

Registering the value setup by Sound Control.

### 1 Setup Sound Control

Refer to the following operations to setup the Sound Control.

- Cabin selection (page 27)
- Speaker Setting (page 27)
- DTA (Digital Time Alignment) setting (page 28)
- X'Over setting (page 28)
- Preset Equalizer Select (page 25)
- Manual Equalizer Control (page 26)
- Position Control (page 26)

### 2 Enter Audio Preset Memory mode (Other than Standby mode)

Press [**Q**] **1 sec.**, and select "DSP" > "PRESET" > "MEMORY".

Press the [AUD] knob for at least 1 second.

- For how to select Function Control items, refer to <Function Control> (page 10).

### 3 Select the number to put in the memory

Turn the [AUD] knob to select number, and then press the [AUD] knob.

"USER1" – "USER6"

### 4 Put the Audio Preset in the memory

Turn the [AUD] knob to select "YES", and then press the [AUD] knob.

"COMPLETE" is displayed.

### 5 Exit Function Control mode

Press the [**Q**] button for at least 1 second.



- Register 6 pairs of Audio Preset Memory.
- "USER1": When you press the Reset, all the sources will be the setting value which is registered.
- "USER1", "USER2":  
The memory cannot be erased by the Reset button.
- This function cannot be registered when the iPod Equalizer set in <Equalizer Control> (page 25).

## Audio Preset Recall

---

Recalling the sound setup registered by <Audio Preset Memory> (page 29).

### 1 Select the source

Press the [SRC] button.

### 2 Enter Audio Preset Recall mode

Press [**Q**] **1 sec.**, and select "DSP" > "PRESET" > "RECALL".

Press the [AUD] knob for at least 1 second.

- For how to select Function Control items, refer to <Function Control> (page 10).

### 3 Select the number to recall in the memory

Turn the [AUD] knob to select number, and then press the [AUD] knob.

"USER1" – "USER6"

### 4 Recall the Audio Preset

Turn the [AUD] knob to select "YES", and then press the [AUD] knob.

"COMPLETE" is displayed.

### 5 Exit Function Control mode

Press the [**Q**] button for at least 1 second.



- The User memory of <Preset Equalizer Select> (page 25) is changed to the value which was recalled.
- The source tone memory item of <Preset Equalizer Select> (page 25) is changed to the value which was recalled by the selected source.

# Basic Operations of Remote Control

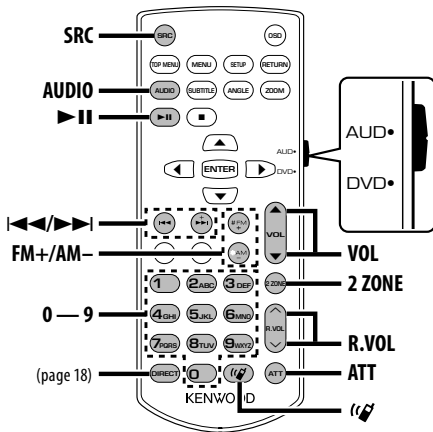

## Dual Zone Control

Select sub source of Dual zone system: **[2 ZONE]**

Rear channel volume control: **[R.VOL]**

## In Tuner Source (AUD mode)

Band select: **[FM+]/[AM-]**

Station select: **[◀◀]/[▶▶]**

Recall preset stations: **[1] — [6]**

## In DVD/USB/iPod Source (DVD mode)

Refer to <Disc/ USB Operations of remote control> (page 16).

Refer to <iPod Operations of remote control> (page 20).

## Remote Controller Mode Switch

The functions operated from the remote controller differ depending on the position of the mode switch.

### AUD mode: [AUD]

Switch to this mode when controlling a selected source or tuner source, etc.

### DVD mode: [DVD]

Switch to this mode when playing DVDs or USB etc. with the player integrated in this unit.



- Switch the mode switch to AUD or DVD position. With the mode switch in the middle, the remote controller cannot operate.

## General Control

Volume control: **[VOL]**

Source select: **[SRC]**

Volume reduce: **[ATT]**

When the button is pressed again, the volume returns to the previous level.

## In Audio Control (AUD mode)

Audio item select: **[AUDIO]**

Adjust the Audio item: **[VOL]**



- Refer to <Audio Control> (page 25) for the operation method, such as the procedures for Audio control and others operations.



### About [📞]

This button is used when Bluetooth HANDS FREE BOX is connected. For more information, refer to the instruction manual of Bluetooth HANDS FREE BOX.

## Loading and Replacing battery

Use two "AAA"/"R03"-size batteries.

Insert the batteries with the + and - poles aligned properly, following the illustration inside the case.

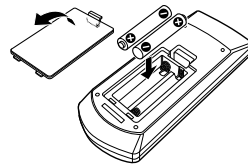

### ⚠ CAUTION

- Do not leave the battery near fire or under direct sunlight. A fire, explosion or excessive heat generation may result.
- Do not set the remote control in hot places such as on the dashboard.

# Appendix

## For operating KCA-BT300 (Optional)

For operation refer to Model-A in the Instruction Manual of KCA-BT300, and the table below. The [AUTO]/[TI] button should be replaced with [SRC] button for <Answering the Waiting Call after Terminating>.

Set the Type Switch on KCA-BT300 as follows.

1: OFF, 2: OFF, 3: OFF

Set the remote controller mode switch to "AUD" mode before starting operation.

Notation used in the KCA-BT300 Instruction Manual	Operation
<b> ▶ II </b> button	[AUD] knob*1
Control knob	[AUD] knob
[AUTO]/[TI] button	[DISP] button
Control knob towards up or down	[FM+] or [AM-] button
Control knob towards left or right	[◀◀] or [▶▶] button

\*1 Use the **|▶ II|** button for the operation of <Switching to the Private Mode>.

## For operating KCA-BT200 (Optional)

For operation refer to Model-A-1 in the Instruction Manual of KCA-BT200, and the table below. The [AUTO]/[TI] button should be replaced with [SRC] button for <Answering the Waiting Call after Terminating>.

Set the remote controller mode switch to "AUD" mode before starting operation.

Notation used in the KCA-BT200 Instruction Manual	Operation
<b> ▶ II </b> button	[AUD] knob*1
Control knob	[AUD] knob
[AUTO]/[TI] button	[DISP] button
Control knob towards up or down	[FM+] or [AM-] button
Control knob towards left or right	[◀◀] or [▶▶] button

\*1 Use the **|▶ II|** button for the operation of <Switching to the Private Mode>.

## Function Glossary

### • "AUTO1", "AUTO2", "MANUAL" (Tuning mode select)

Select a tuning mode of the radio.

Tuning mode	Display	Operation
Auto seek	"AUTO1"	Automatic search for a station.
Preset station seek	"AUTO2"	Search in order of the stations in the Preset memory.
Manual	"MANUAL"	Normal manual tuning control.

### • AUX

When this is set to ON, AUX source can be selected.

ON1: Allows AUX source to be selected. Use this setting when the built-in AUX terminal is connected to the external equipment all the time.

ON2: Activates the attenuator function when turning on the power with AUX source selected. Cancel the attenuator function by turning the volume knob clockwise when listening to the audio of the external equipment.

OFF: Disable AUX source selection. Use this setting when the built-in AUX terminal is not used.

### • DTA (Digital Time Alignment)

Make fine adjustment of the delay time of the speaker output specified at <Cabin selection> (page 27) to have a more suitable environment for your vehicle.

The settings of the delay time are automatically identified and compensated by specifying the distances of each speaker from the center of the vehicle interior.

1 Set the front and rear positions and the height of the reference point to the position of the ears of the person sitting in the front seat, and set the right and left positions to the center of the vehicle interior.

2 Measure the distances from the reference point to the speakers.

3 Calculate the distance difference in accordance with the farthest speaker.

## Appendix

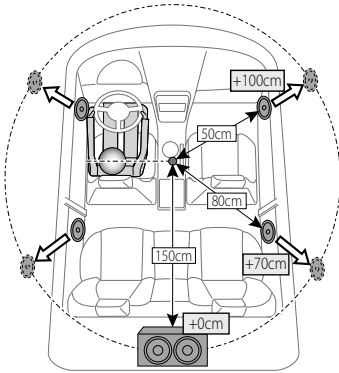

- **“HIGHWAY” (Highway sound)**  
Increases the volume of faintest sound being lost by road noises to make the sound more audible. Additionally, it accentuates bass sound being lost by road noises to make the bass sound more dynamic.
- **“ICON”**  
Sets the Graphics mode of the display during normal playback condition.  
ON1: Turns on.  
ON2: Displays an animation.  
OFF: Turns off.
- **“SWPRE” (Switching Preout)**  
Switches the preout between rear output (“R”), subwoofer output (“SW”), and DVD/USB source output (“AV”).
- **“ZONE2” (Dual Zone)**  
Set the destination (front speaker “F” or rear speaker “R”) of the sub source (DVD/USB/AUX) when the Dual Zone function is turned on.



## Language code list

Code	Language
ENGLISH	English
SPANISH	Spanish
FRENCH	French
GERMAN	German
ITALIAN	Italian
DUTCH	Dutch
SWEDISH	Swedish
DANISH	Danish
RUSSIAN	Russian
CHINESE	Chinese
PORTUGUESE	Portuguese
JAPANESE	Japanese
AA	Afar
AB	Abkhazian
AF	Afrikaans
AM	Amharic
AR	Arabic
AS	Assamese
AY	Aymara
AZ	Azerbaijani
BA	Bashkir
BE	Byelorussian
BG	Bulgarian
BH	Bihari
BI	Bislama
BN	Bengali, Bangla
BO	Tibetan
BR	Breton
CA	Catalan
CO	Corsican
CS	Czech
CY	Welsh
DZ	Bhutani
EL	Greek
EO	Esperanto
ET	Estonian
EU	Basque
FA	Persian
FI	Finnish
FJ	Fiji
FO	Faroese
FY	Frisian
GA	Irish
GD	Scots Gaelic
GL	Galician
GN	Guarani
GU	Gujarati
HA	Hausa

Code	Language
HI	Hindi
HR	Croatian
HU	Hungarian
HY	Armenian
IA	Interlingua
IE	Interlingue
IK	Inupiak
IN	Indonesian
IS	Icelandic
IW	Hebrew
JI	Yiddish
JW	Javanese
KA	Georgian
KK	Kazakh
KL	Greenlandic
KM	Cambodian
KN	Kannada
KO	Korean
KS	Kashmiri
KU	Kurdish
KY	Kirghiz
LA	Latin
LN	Lingala
LO	Laotian
LT	Lithuanian
LV	Latvian, Lettish
MG	Malagasy
MI	Maori
MK	Macedonian
ML	Malayalam
MN	Mongolian
MO	Moldavian
MR	Marathi
MS	Malay
MT	Maltese
MY	Burmese
NA	Nauru
NE	Nepali
NO	Norwegian
OC	Occitan
OM	(Afan) Oromo
OR	Oriya
PA	Punjabi
PL	Polish
PS	Pashto, Pushto
QU	Quechua
RM	Rhaeto-Romance
RN	Kirundi

Code	Language
RO	Romanian
RW	Kinyarwanda
SA	Sanskrit
SD	Sindhi
SG	Sangho
SH	Serbo-Croatian
SI	Singhalese
SK	Slovak
SL	Slovenian
SM	Samoaan
SN	Shona
SO	Somali
SQ	Albanian
SR	Serbian
SS	Siswati
ST	Sesotho
SU	Sundanese
SW	Swahili
TA	Tamil
TE	Telugu
TG	Tajik
TH	Thai
TI	Tigrinya
TK	Turkmen
TL	Tagalog
TN	Setswana
TO	Tongan
TR	Turkish
TS	Tsonga
TT	Tatar
TW	Twi
UK	Ukrainian
UR	Urdu
UZ	Uzbek
VI	Vietnamese
VO	Volapuk
WO	Wolof
XH	Xhosa
YO	Yoruba
ZU	Zulu

# Accessories/ Installation Procedure

## Accessories

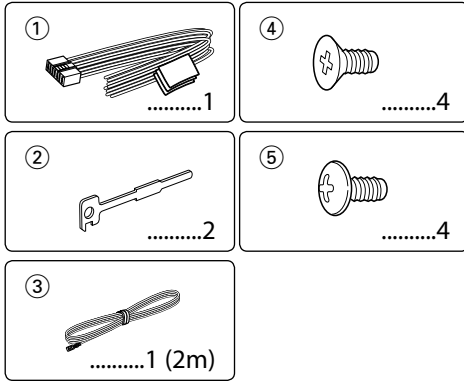

## Installation Procedure

1. To prevent a short circuit, remove the key from the ignition and disconnect the ⊖ battery.
2. Make the proper input and output wire connections for each unit.
3. Connect the speaker wires of the wiring harness.
4. Connect the wiring harness wires in the following order: ground, battery, ignition.
5. Connect the wiring harness connector to the unit.
6. Install the unit in your car.
7. Reconnect the ⊖ battery.
8. Press the reset button.

### ▲WARNING

If you connect the ignition wire (red) and the battery wire (yellow) to the car chassis (ground), you may cause a short circuit, that in turn may start a fire. Always connect those wires to the power source running through the fuse box.



- Mounting and wiring this product requires skills and experience. For safety's sake, leave the mounting and wiring work to professionals.
- Install this unit in the console of your vehicle. Do not touch the metal part of this unit during and shortly after the use of the unit. Metal part such as the heat sink and enclosure become hot.
- Make sure to ground the unit to a negative 12V DC power supply.
- Do not install the unit in a spot exposed to direct sunlight or excessive heat or humidity. Also avoid places with too much dust or the possibility of water splashing.
- Do not use your own screws. Use only the screws provided. If you use the wrong screws, you could damage the unit.

- If the power is not turned ON ("PROTECT" is displayed), the speaker wire may have a short-circuit or touched the chassis of the vehicle and the protection function may have been activated. Therefore, the speaker wire should be checked.
- If your car's ignition does not have an ACC position, connect the ignition wires to a power source that can be turned on and off with the ignition key. If you connect the ignition wire to a power source with a constant voltage supply, as with battery wires, the battery may die.
- If the console has a lid, make sure to install the unit so that the faceplate will not hit the lid when closing and opening.
- If the fuse blows, first make sure the wires aren't touching to cause a short circuit, then replace the old fuse with one with the same rating.
- Insulate unconnected wires with vinyl tape or other similar material. To prevent a short circuit, do not remove the caps on the ends of the unconnected wires or the terminals.
- Connect the speaker wires correctly to the terminals to which they correspond. The unit may be damaged or fail to work if you share the ⊖ wires or ground them to any metal part in the car.
- When only two speakers are being connected to the system, connect the connectors either to both the front output terminals or to both the rear output terminals (do not mix front and rear). For example, if you connect the ⊕ connector of the left speaker to a front output terminal, do not connect the ⊖ connector to a rear output terminal.
- After the unit is installed, check whether the brake lamps, blinkers, wipers, etc. on the car are working properly.
- Mount the unit so that the mounting angle is 30° or less.

### About CD players/disc changers connected to this unit

If the CD player/ disc changer has the "O-N" switch, set it to the "N" position.

The functions you can use and the information that can be displayed may differ depending on the models being connected.

# Connecting Wires to Terminals

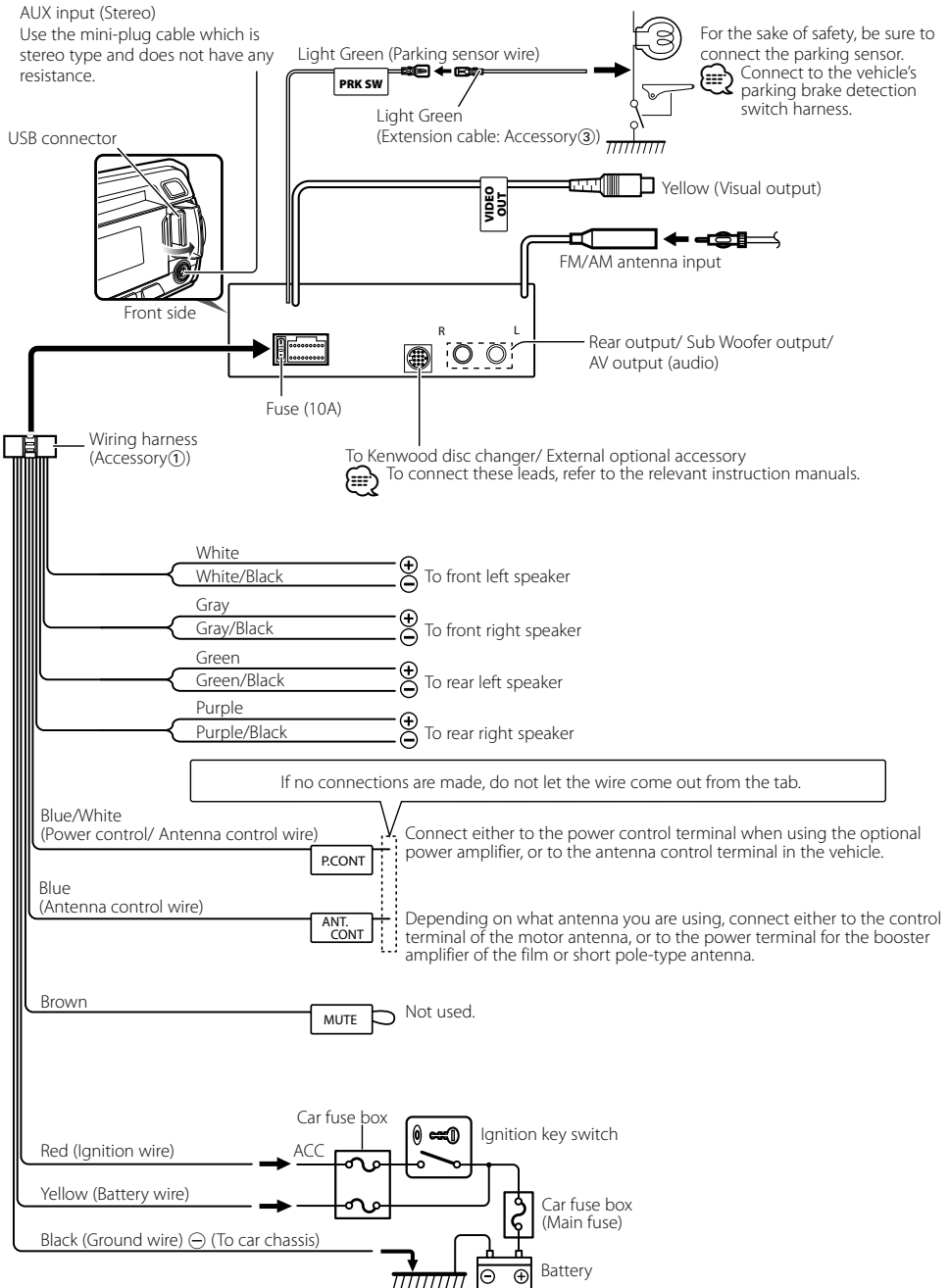

# Installation/Removing the Unit

## Non-Japanese cars

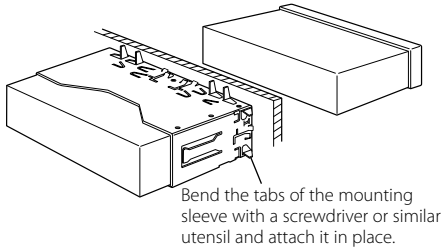

- Make sure that the unit is installed securely in place. If the unit is unstable, it may malfunction (for example, the sound may skip).

## Japanese cars

- 1 Refer to the section <Removing the hard rubber frame> and then remove the hard rubber frame.
- 2 Align the holes in the unit (two locations on each side) with the vehicle mounting bracket and secure the unit with the accessory screws.

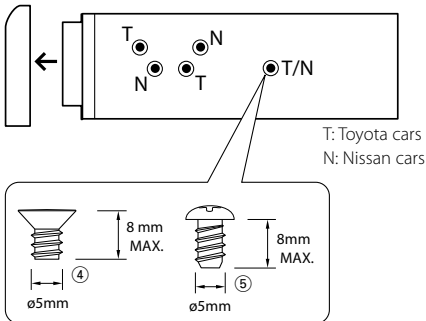

### CAUTION

Install this unit in the console of your vehicle. Do not touch the metal part of this unit during and shortly after the use of the unit. Metal part such as the heat sink and enclosure become hot.

## Removing the hard rubber frame

- 1 Engage the catch pins on the removal tool and remove the two locks on the upper level. Upper the frame and pull it forward as shown in the figure.

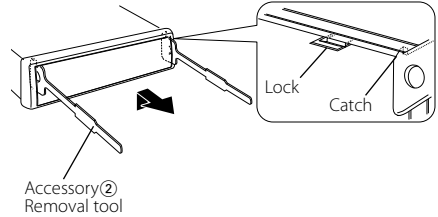

- 2 When the upper level is removed, remove the lower two locations.



- The frame can be removed from the bottom side in the same manner.

## Removing the Unit

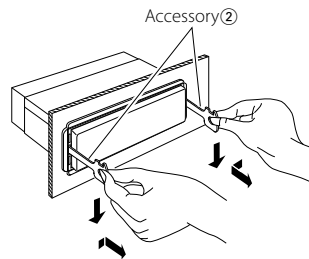

- 1 Refer to the section <Removing the hard rubber frame> and then remove the hard rubber frame.
- 2 Insert the two removal tools deeply into the slots on each side, as shown.
- 3 Lower the removal tool toward the bottom, and pull out the unit halfway while pressing towards the inside.





- Be careful to avoid injury from the catch pins on the removal tool.
- 4 Pull the unit all the way out with your hands, being careful not to drop it.

# Troubleshooting Guide

Some functions of this unit may be disabled by some settings made on this unit.



- !** • **Cannot set up the subwoofer.**
- **Cannot set up the low pass filter.**
- **Cannot set up subwoofer phase.**
- **No output from the subwoofer.**
  - ▶ • <Subwoofer output> of <Basic Operation> (page 8) is not set to On.
  - Preout is not set to subwoofer.  "MENU" > "SWPRE" of <Function Control> (page 10)
  - The Dual zone function is enabled.  <Audio Setup> (page 25)

- !** • **Cannot set up the equalizer.**
- **Cannot set up the crossover network.**
- **Cannot set up Digital Time Alignment.**
- **Cannot select the "CONTROL" in "DSP".**
- **Cannot select the "SETUP" in "DSP".**
  - ▶ • The Dual zone function is enabled.  <Audio Setup> (page 25)
  - The DSP function is disabled.  "DSP" > "DSP SET" of <Function Control> (page 11)
  - In the speaker select option, None is selected for the rear speakers.  <Speaker Setting> (page 27)

- !** • **Cannot set up the Dual zone.**
  - ▶ The AV output function is enabled.  <Audio Setup> (page 25)

- !** • **Cannot set up the AV output.**
- **Cannot select the "SWPRE" in "MENU".**
  - ▶ The Dual zone function is enabled.  <Audio Setup> (page 25)

- !** • **Cannot register a security code.**
- **Cannot set up Display.**
  - ▶ <Demonstration mode Setting> (page 7) is not turned off.



- !** • **Cannot switch to DVD or USB source.**
  - ▶ • The Dual zone function is set to DVD or USB.  <Audio Setup> (page 25)
  - AV output source is set to USB or DVD.  <Audio Setup> (page 25)

What might seem to be a malfunction in your unit may just be the result of slight misoperation or miswiring. Before calling service, first check the following table for possible problems.



## Tuner source

- ?** **Radio reception is poor.**
  - ✓ The car antenna is not extended.
  -  Pull the antenna out all the way.

## Disc source

- ?** **The specified disc does not play, but another one plays instead.**
  - ✓ The specified disc is quite dirty.
    -  Clean the disc, referring to the disc cleaning of the section on <Handling discs> (page 3).
  - ✓ The disc is loaded in a different slot from that specified.
    -  Eject the disc magazine and check the number for the specified disc.
  - ✓ The disc is severely scratched.
    -  Try another disc instead.

## Audio file source

- ?** **The sound skips when an Audio file is being played.**
  - ✓ The media is scratched or dirty.
    -  Clean the media, referring to the disc cleaning of the section on <Handling discs> (page 3).
  - ✓ The recording condition is bad.
    -  Record the media again or use another media.

# Troubleshooting Guide

## The messages shown below display your systems condition.

TOC ERR:	<ul style="list-style-type: none"><li>• The disc is quite dirty. The disc is upside-down. The disc is scratched a lot.</li><li>• No disc has been loaded in the disc magazine.</li></ul>
E-05:	The disc is unreadable.
E-77:	The unit is malfunctioning for some reason. ⇨ Press the reset button on the unit. If the "E-77" code does not disappear, consult your nearest service center.
E-99:	Something is wrong with the disc magazine. Or the unit is malfunctioning for some reason. ⇨ Check the disc magazine. And then press the reset button on the unit. If the "E-99" code does not disappear, consult your nearest service center.
MEC ERR:	The unit is malfunctioning for some reason. ⇨ Press the [▲] button on the unit. If the error message does not disappear when you eject the disc and insert it again, consult your nearest service center.
IN (Blink):	The DVD player section is not operating properly. ⇨ Reinsert the disc. If the disc cannot be ejected or the display continues to flash even when the disc has been properly reinserted, please switch off the power and consult your nearest service center.
PROTECT (Blink):	The speaker wire has a short-circuit or touches the chassis of the vehicle, and then the protection function is activated. ⇨ Wire or insulate the speaker cable properly and press the reset button. If the "PROTECT" code does not disappear, consult your nearest service center.
NA FILE:	An Audio file is played with a format that this unit can't support.
COPY PRO:	A copy-protected file is played.
READ ERR:	The file system of the connected USB device is broken. ⇨ Copy the files and folders for the USB device again. If the error message is still displayed, initialize the USB device or use other USB devices.
NO DEVICE:	The USB device is selected as a source although no USB device is connected. ⇨ Change the source to any source other than USB. Connect an USB device, and change the source to USB again.

NA DEVICE:	<ul style="list-style-type: none"><li>• An unsupported USB device is connected.</li><li>• Connection to the iPod has failed.</li><li>⇨ Check that the connected iPod is an iPod that is supported. See &lt;About Audio file&gt; (page 4) for information on supported iPods.</li></ul>
NO MUSIC/E-15:	<ul style="list-style-type: none"><li>• The connected USB device contains no playable audio file.</li><li>• Media was played that does not have data recorded that the unit can play.</li></ul>
USB ERR:	Some trouble may have occurred to the connected USB device. ⇨ Check the USB device, turn off the unit, wait for about 10 seconds, and then turn on the unit again. If the same display is repeated, use another USB device.
iPod ERR:	Connection to the iPod has failed. ⇨ Remove the USB device and then reconnect it. ⇨ Confirm that the software for the iPod is the latest version.
REG ERR:	The disc you wanted to play has a region code that cannot be played with this unit.
PARK OFF:	Source for displaying video is selected while car is traveling. ⇨ Video will be displayed when the car is stopped and the parking brake has been engaged. ⇨ Press the [DISP] button for at least 1 second. The display of this unit can be temporarily hidden.
READING:	The unit is reading the data on the media.

# Specifications

## FM tuner section

---

Frequency Range  
200 kHz space : 87.9 MHz – 107.9 MHz  
50 kHz space : 87.5 MHz – 108.0 MHz  
Usable Sensitivity (S/N = 30dB)  
: 9.3dBf (0.8  $\mu$ V/75  $\Omega$ )  
Quieting Sensitivity (S/N = 50dB)  
: 15.2dBf (1.6  $\mu$ V/75  $\Omega$ )  
Frequency Response ( $\pm 3$  dB)  
: 30 Hz – 15 kHz  
Signal to Noise Ratio (MONO)  
: 70 dB  
Selectivity ( $\pm 400$  kHz)  
:  $\geq 80$  dB  
Stereo Separation (1 kHz)  
: 40 dB

## AM tuner section

---

Frequency Range  
10 kHz space : 530 kHz – 1700 kHz  
9 kHz space : 531 kHz – 1611 kHz  
Usable Sensitivity (S/N = 20dB)  
: 28 dB $\mu$  (25  $\mu$ V)

## DVD player section

---

D/A Converter  
: 24 Bit  
Audio Decoder  
: Linear PCM/ Dolby digital/ MP3/ WMA/ WAV  
Video Decoder  
: MPEG1/ MPEG2/ DivX  
Wow & Flutter  
: Below Measurable Limit  
Frequency Response  
Sampling frequency; 96 kHz : 16 – 22,000 Hz  
Sampling frequency; 48 kHz : 16 – 22,000 Hz  
Sampling frequency; 44.1 kHz : 16 – 20,000 Hz  
Signal to Noise Ratio (1 kHz)  
: 95 dB  
Dynamic Range  
Sampling frequency; 96 kHz : 100 dB  
Sampling frequency; 48/ 44.1 kHz : 90 dB  
Disc Format  
: DVD-Video/ VIDEO-CD/ CD-DA  
Sampling Frequency  
: 44.1/ 48/ 96 kHz  
Quantifying Bit Number  
: 16/ 20/ 24 bit

## USB Interface

---

USB Standard  
: USB1.1/ 2.0  
Data Transfer Rate  
Full Speed : Maximum 12 Mbps  
Low Speed : Maximum 1.5 Mbps  
Compatible Device  
: Mass storage class  
Maximum Supply Current  
: 500 mA  
File System  
: FAT 32/ 16/ 12  
Playable Video/ Audio Format  
: MPEG1/ MPEG2/ DivX/ MP3/ WMA/ WAV

## Video Section

---

Video Output Level  
: 1 Vp-p (75  $\Omega$ )  
Color System  
: NTSC/ PAL

## Audio Section

---

Maximum Output Power  
: 50 W x 4  
Full Bandwidth Power (at less than 1% THD)  
: 22 W x 4  
Speaker Impedance  
: 4 – 8  $\Omega$   
Tone Action  
Frequency (BAND1 – 5): 60/ 250/ 1k/ 4k/ 16k Hz  
Gain :  $\pm 9$  dB  
Preout Level / Load (DVD/CD)  
: 2500 mV/10 k $\Omega$   
Preout Impedance  
:  $\leq 600 \Omega$

## Auxiliary Input

---

Frequency Response  
: 20 Hz – 20 KHz ( $\pm 3$ dB)  
Input Maximum Voltage  
: 1200 mV  
Input Impedance  
: 10 k $\Omega$

## General

---

Operating Voltage (10.5 – 16V allowable)  
: 14.4 V  
Maximum Current consumption  
: 10 A  
Installation Size (W x H x D)  
: 182 x 53 x 156 mm  
Weight  
: 1.3 kg

Specifications subject to change without notice.

### For Turkey

Bu ürün 26891 sayılı Resmî Gazete'de yayımlanan Elektrikli ve Elektronik Eşyalarda Bazı Zararlı Maddelerin Kullanımının Sınırlandırılmasına Dair Yönetmeliğe uygun olarak üretilmiştir.

This product complies with Directive, Number 26891 regarding "REGULATION ON THE RESTRICTION OF THE USE OF CERTAIN HAZARDOUS SUBSTANCES IN ELECTRICAL AND ELECTRONIC EQUIPMENT".

### The marking of products using lasers

**CLASS 1  
LASER PRODUCT**

The label is attached to the chassis/case and says that the component uses laser beams that have been classified as Class 1. It means that the unit is utilizing laser beams that are of a weaker class. There is no danger of hazardous radiation outside the unit.

### KDV-U4349M:

#### Declaration of Conformity with regard to the EMC Directive 2004/108/EC

#### Manufacturer:

Kenwood Corporation  
2967-3 Ishikawa-machi, Hachioji-shi, Tokyo, 192-8525 Japan

#### EU Representative's:

Kenwood Electronics Europe BV  
Amsterdamseweg 37, 1422 AC UITHOORN, The Netherlands



 is a trademark of DVD Format/Logo Licensing Corporation registered in the U.S., Japan and other countries.

- "Made for iPod," and "Made for iPhone" mean that an electronic accessory has been designed to connect specifically to iPod, or iPhone, respectively, and has been certified by the developer to meet Apple performance standards. Apple is not responsible for the operation of this device or its compliance with safety and regulatory standards. Please note that the use of this accessory with iPod, or iPhone may affect wireless performance.
- iPhone, iPod, iPod classic, iPod nano, and iPod touch are trademarks of Apple Inc., registered in the U.S. and other countries.

#### ABOUT DIVX VIDEO:

DivX® is a digital video format created by DivX, Inc. This is an official DivX Certified® device that plays DivX video. Visit [divx.com](http://divx.com) for more information and software tools to convert your files into DivX video.

#### ABOUT DIVX VIDEO-ON-DEMAND:

This DivX Certified® device must be registered in order to play purchased DivX Video-on-Demand (VOD) movies. To obtain your registration code, locate the DivX VOD section in your device setup menu. Go to [vod.divx.com](http://vod.divx.com) for more information on how to complete your registration.

DivX®, DivX Certified® and associated logos are trademarks of DivX, Inc. and are used under license.

Manufactured under license from Dolby Laboratories.  
Dolby and the double-D symbol are trademarks of Dolby Laboratories.

This product incorporates copyright protection technology that is protected by U.S. patents and other intellectual property rights of Rovi Corporation. Reverse engineering or disassembly is prohibited.



## Free Manuals Download Website

<http://myh66.com>

<http://usermanuals.us>

<http://www.somanuals.com>

<http://www.4manuals.cc>

<http://www.manual-lib.com>

<http://www.404manual.com>

<http://www.luxmanual.com>

<http://aubethermostatmanual.com>

Golf course search by state

<http://golfingnear.com>

Email search by domain

<http://emailbydomain.com>

Auto manuals search

<http://auto.somanuals.com>

TV manuals search

<http://tv.somanuals.com>