

# KENWOOD

**KDC-219**

**KDC-2019V**

**KDC-2019**

**KDC-29MR**

**KDC-119**

**KDC-119S**

**KDC-217**

**KDC-217S**

CD-RECEIVER

## **INSTRUCTION MANUAL**

AMPLI-TUNER-LECTEUR DE CD

## **MODE D'EMPLOI**

REPRODUCTOR DE DISCOS COMPACTOS RECEPTOR DE FM/AM

## **MANUAL DE INSTRUCCIONES**

RECEPTOR DE CD

## **MANUAL DE INSTRUÇÕES**

KENWOOD CORPORATION

**Take the time to read through this instruction manual. Familiarity with installation and operation procedures will help you obtain the best performance from your new CD-receiver.**

### **For your records**

Record the serial number, found on the back of the unit, in the spaces designated on the warranty card, and in the space provided below. Refer to the model and serial numbers whenever you call upon your KENWOOD dealer for information or service on the product.

Model KDC-219, KDC-2019V, KDC-2019, KDC-29MR, KDC-119,  
KDC-119S, KDC-217, KDC-217S Serial number \_\_\_\_\_

© B64-2114-00 (KWN)



## Contents

<b>Warning .....</b>	<b>3</b>	<b>CD/External disc control</b>	
<b>Safety precautions.....</b>	<b>4</b>	<b>features .....</b>	<b>12</b>
<b>About CDs.....</b>	<b>6</b>	Playing CD	
<b>General features .....</b>	<b>7</b>	Playing External Disc	
Power		Fast Forwarding and Reversing	
Selecting the Source		Track Search	
Volume		Album Search	
Attenuator		Track/Album Repeat	
Loudness		Track Scan	
System Q		Random Play	
Audio Control		Magazine Random Play	
Speaker Setting		<b>Basic Operations of remote.....</b>	<b>15</b>
Clock Display		Loading and Replacing the battery	
Adjusting Clock		Basic operations	
DSI (Disabled System Indicator)		In Tuner source	
Theft Deterrent Faceplate		In Disc source	
<b>Tuner features .....</b>	<b>10</b>	<b>Accessories .....</b>	<b>17</b>
Tuning Mode		<b>Installation Procedure .....</b>	<b>17</b>
Tuning		<b>Connecting Wires to Terminals</b>	<b>18</b>
Station Preset Memory		<b>Installation .....</b>	<b>19</b>
Auto Memory Entry		<b>Troubleshooting Guide .....</b>	<b>21</b>
Preset Tuning		<b>Specifications .....</b>	<b>24</b>
CRSC (Clean Reception System Circuit)			

## **▲ Warning**

---

### **▲ CAUTION**

Use of controls or adjustments or performance of procedures other than those specified herein may result in hazardous radiation exposure.

In compliance with Federal Regulations, following are reproductions of labels on, or inside the product relating to laser product safety.

KENWOOD CORPORATION  
2967-3, ISHIKAWA-CHO,  
HACHIOJI-SHI  
TOKYO, JAPAN

KENWOOD CORP. CERTIFIES THIS EQUIPMENT  
CONFORMS TO DHHS REGULATIONS NO.21 CFR  
1040.10, CHAPTER 1, SUBCHAPTER J.

Location : Bottom Panel

### **FCC WARNING**

This equipment may generate or use radio frequency energy. Changes or modifications to this equipment may cause harmful interference unless the modifications are expressly approved in the instruction manual. The user could lose the authority to operate this equipment if an unauthorized change or modification is made.

### **NOTE**

This equipment has been tested and found to comply with the limits for a Class B digital device, pursuant to Part 15 of the FCC Rules. These limits are designed to provide reasonable protection against harmful interference in a residential installation. This equipment may cause harmful interference to radio communications, if it is not installed and used in accordance with the instructions. However, there is no guarantee that interference will not occur in a particular installation. If this equipment does cause harmful interference to radio or television reception, which can be determined by turning the equipment off and on, the user is encouraged to try to correct the interference by one or more of the following measures:

- Reorient or relocate the receiving antenna.
- Increase the separation between the equipment and receiver.
- Connect the equipment into an outlet on a circuit different from that to which the receiver is connected.
- Consult the dealer or an experienced radio/TV technician for help.

### **NOTE**

This Class B digital apparatus complies with Canadian ICES-003.

## Safety precautions

### **▲WARNING**

**To prevent injury or fire, take the following precautions:**

- Insert the unit all the way in until it is fully locked in place. Otherwise it may fall out of place when jolted.
- When extending the ignition, battery, or ground wires, make sure to use automotive-grade wires or other wires with a 0.75mm<sup>2</sup> (AWG18) or more to prevent wire deterioration and damage to the wire coating.
- To prevent a short circuit, never put or leave any metallic objects (such as coins or metal tools) inside the unit.
- If the unit starts to emit smoke or strange smells, turn off the power immediately and consult your Kenwood dealer.
- Make sure not to get your fingers caught between the faceplate and the unit.
- Be careful not to drop the unit or subject it to strong shock.  
The unit may break or crack because it contains glass parts.
- Do not touch the liquid crystal fluid if the LCD is damaged or broken due to shock. The liquid crystal fluid may be dangerous to your health or even fatal.  
If the liquid crystal fluid from the LCD contacts your body or clothing, wash it off with soap immediately.

### **▲CAUTION**

**To prevent damage to the machine, take the following precautions:**

- Make sure to ground the unit to a negative 12V DC power supply.
- Do not open the top or bottom covers of the unit.
- Do not install the unit in a spot exposed to direct sunlight or excessive heat or humidity. Also avoid places with too much dust or the possibility of water splashing.
- Do not set the removed faceplate or the faceplate case in areas exposed to direct sunlight, excessive heat or humidity. Also avoid places with too much dust or the possibility of water splashing.
- To prevent deterioration, do not touch the terminals of the unit or faceplate with your fingers.
- Do not subject the faceplate to excessive shock, as it is a piece of precision equipment.
- When replacing a fuse, only use a new one with the prescribed rating. Using a fuse with the wrong rating may cause your unit to malfunction.
- To prevent a short circuit when replacing a fuse, first disconnect the wiring harness.
- Do not place any object between the faceplate and the unit.
- Do not use your own screws. Use only the screws provided. If you use the wrong screws, you could damage the unit.

### **IMPORTANT INFORMATION** **About the disc changer to be connected:**

To connect a disc changer having the "O-N" switch to this unit, set the "O-N" switch to "N". To connect a disc changer having no "O-N" switch to this unit, the converter cord CA-DS100 and/or switching adapter KCA-S210A are required as options.

A disc changer doesn't work when it is connected without using these options. If a model with no "O-N" switch is connected, some unavailable functions and information that cannot be displayed are generated. Note that none of the KDC-C100, KDC-C302, C205, C705, and non-Kenwood CD changers can be connected.



You can damage both your unit and the CD changer if you connect them incorrectly.

### **Do Not Load 3-in. CDs in the CD slot**

If you try to load a 3 in. CD with its adapter into the unit, the adapter might separate from the CD and damage the unit.

## NOTE

- If you experience problems during installation, consult your Kenwood dealer.
- If the unit does not seem to be working right, try pressing the reset button first. If that does not solve the problem, consult your Kenwood dealer.
- Press the reset button if the Disc auto changer fails to operate correctly. Normal operation should be restored.

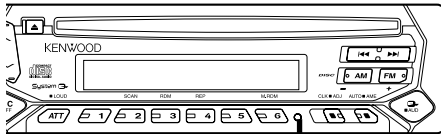

Reset button

- Characters in the LCD may become difficult to read in temperatures below 41 °F (5 °C).
- The illustrations of the display and the panel appearing in this manual are examples used to explain more clearly how the controls are used. Therefore, what appears on the display in the illustrations may differ from what appears on the display on the actual equipment, and some of the illustrations on the display may represent something impossible in actual operation.

## ***Cleaning the Faceplate Terminals***

If the terminals on the unit or faceplate get dirty, wipe them with a dry, soft cloth.

## ***Cleaning the Unit***

If the faceplate of this unit is stained, wipe it with a dry soft cloth such as a silicon cloth. If the faceplate is stained badly, wipe the stain off with a cloth moistened with neutral cleaner, then wipe neutral detergent off.



Applying spray cleaner directly to the unit may affect its mechanical parts. Wiping the faceplate with a hard cloth or using a volatile liquid such as thinner or alcohol may scratch the surface or erase characters.

## ***Cleaning the CD Slot***

As dust tends to accumulate in the CD slot, clean it every once in a while. Your CDs can get scratched if you put them in a dusty CD slot.

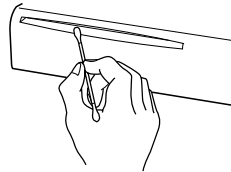

## ***Lens Fogging***

Right after you turn on the car heater in cold weather, dew or condensation may form on the lens in the CD player of the unit. Called lens fogging, CDs may be impossible to play. In such a situation, remove the disc and wait for the condensation to evaporate. If the unit still does not operate normally after a while, consult your Kenwood dealer.

## About CDs

### Handling CDs

- Don't touch the recording surface of the CD.

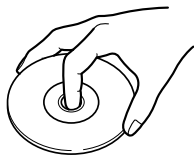

- CD-R and CD-RW are easier to damage than a normal music CD. Use a CD-R or a CD-RW after reading the caution items on the package etc.
- Don't stick tape etc. on the CD. Also, don't use a CD with tape stuck on it.

### When using a new CD

If the CD center hole or outside rim has burrs, use it after removing them with a ball pen etc.

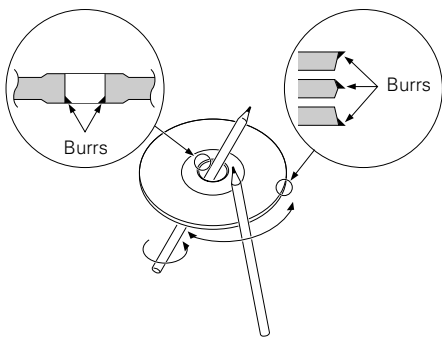

### CD accessories

Don't use disc type accessories.

### CD cleaning

Clean from the center of the disc and move outward.

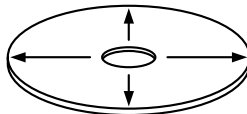



### Removing CDs

When removing CDs from this unit pull them out horizontally.

### CDs that can't be used

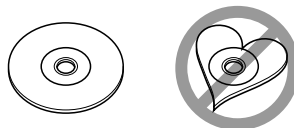
- CDs that aren't round can't be used.



- CDs with coloring on the recording surface or that are dirty can't be used.
  - Don't use CDs without disc mark
- 
- A CD-R or CD-RW that hasn't been finalized can't be played. (For the finalization process refer to your CD-R/CD-RW writing software, and your CD-R/CD-RW recorder instruction manual.)

### CD storage

- Don't place them in direct sunlight (On the seat or dashboard etc.) and where the temperature is high.
- Store CDs in their cases.

## General features

### Release button

(KDC-219/KDC-2019V/KDC-2019/  
KDC-29MR/KDC-217/KDC-217S only)

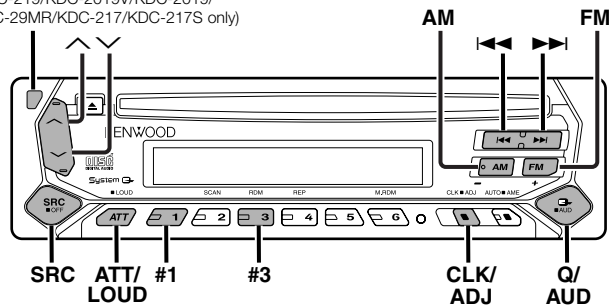

## Power

### Turning ON the Power

Press the [SRC] button.

### Turning OFF the Power

Press the [SRC] button for at least 1 second.

## Selecting the Source

Press the [SRC] button.

Source required	Display
Tuner	"TUnE"
CD	"CD"
External disc (Function of the KDC-219/KDC-2019V/KDC-2019/KDC-29MR)	"DISC"
Standby (Illumination only mode)	"OFF"

KDC-219/KDC-2019V/KDC-2019/KDC-29MR/KDC-217/KDC-217S

ATT indicator LOUD indicator

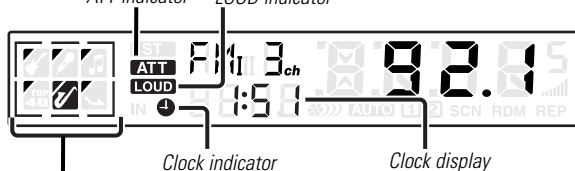

SYSTEM Q indicator

KDC-119/KDC-119S

LOUD indicator Clock display

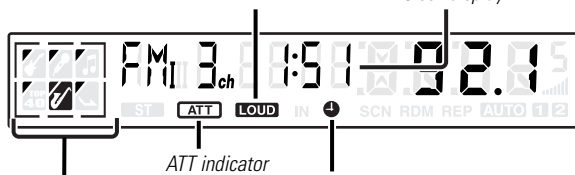

SYSTEM Q indicator

Clock indicator

## Volume

### Increasing Volume

Press the [^] button.

### Decreasing Volume

Press the [v] button.

## Attenuator

Turning the volume down quickly.

Press the [ATT] button.

Each time the button is pressed the Attenuator turns ON or OFF. When it's ON, the "ATT" indicator blinks.

## General features

### Loudness

Compensating for low and high tones during low volume.

Press the [LOUD] button for at least 1 second.

Each time the button is pressed for at least 1 second the Loudness turns ON or OFF.

When it's ON, "LOUD" indicator is ON.

### System Q

You can recall the best sound setting preset for different types of the music.

#### 1 Select the source to set

Press the [SRC] button.

#### 2 Select the Sound type

Press the [Q] button.

Each time the button is pressed the sound setting switches.

Sound setting	Display
Flat	"SQ-1"
Rock	"SQ-2"
Top 40	"SQ-3"
Pops	"SQ-4"
Jazz	"SQ-5"
Easy	"SQ-6"
Scan of Flat — Easy	"SCAn"



- Each setting value is changed with the <Speaker setting> (page 8).  
First, select the speaker type with the Speaker setting.
- When the System Q setting is changed, the Bass, Middle, and Treble set in audio control replace the System Q values.

### Audio Control

#### 1 Select the source for adjustment

Press the [SRC] button.

#### 2 Enter Audio Control mode

Press the [AUD] button for at least 1 second.

#### 3 Select the Audio item for adjustment

Press the [FM] or [AM] button.

Each time the button is pressed the items that can be adjusted switch as shown below.

#### 4 Adjust the Audio item

Press the [◀◀] or [▶▶] button.

Adjustment Item	Display	Range
Bass level	"BAS"	-8 — +8
Middle level	"MID"	-8 — +8
Treble level	"TRE"	-8 — +8
Balance	"BL"	Left 15 — Right 15
Fader	"FD"	Rear 15 — Front 15

#### 5 Exit Audio Control mode

Press the [AUD] button.

### Speaker Setting

Fine-tuning so that the System Q value is optimal when setting the speaker type.

#### 1 Enter Standby

Press the [SRC] button.

Select the "OFF" display.

#### 2 Enter Speaker Setting mode

Press the [Q] button.



### 3 Select the Speaker type

Press the [◀◀] or [▶▶] button.

Each time the button is pressed the setting switches as shown below.

<b>Speaker type</b>	<b>Display</b>
OFF	"SP-F"
For the OEM speaker	"SP-O"
For 6 & 6x9 in. speaker	"SP-6"
For 5 & 4 in. speaker	"SP-5"

### 4 Exit Speaker Setting mode

Press the [Q] button.

## Clock Display

Press the [CLK] button.

Each time the button is pressed the clock display turns ON or OFF.

When it's ON, the clock indicator is ON.

## Adjusting Clock

### 1 Select the clock display

Press the [CLK] button.

### 2 Enter clock adjustment mode

Press the [CLK] button for at least 2 seconds.

The clock display blinks.

### 3 Adjust the hours

Press the [FM] or [AM] button.

#### Adjust the minutes

Press the [◀◀] or [▶▶] button.

### 4 Exit clock adjustment mode

Press the [CLK] button.

*Function of the KDC-219/KDC-2019V/KDC-2019/KDC-29MR/KDC-217/KDC-217S*

## DSI (Disabled System Indicator)

A red indicator will blink on the unit after the faceplate is removed, warning potential thieves.

### 1 Turn the power OFF

Press the [SRC] button for at least 1 second.

### 2 Set the DSI

While pressing the [#1] and [#3] button, press the [SRC] button.

Each time the step 1 and 2 operation is done the DSI turns ON or OFF.

## General features

Function of the KDC-219/KDC-2019V/KDC-2019/KDC-29MR/KDC-217/KDC-217S

### Theft Deterrent Faceplate

The faceplate of the unit can be detached and taken with you, helping to deter theft.

#### Removing the Faceplate

Press the Release button.

The faceplate is unlocked, allowing you to detach it.

- ⚠ • The faceplate is a precision piece of equipment and can be damaged by shocks or jolts. For that reason, keep the faceplate in its special storage case while detached.
- Do not expose the faceplate or its storage case to direct sunlight or excessive heat or humidity. Also avoid places with too much dust or the possibility of water splashing.

#### Reattaching the Faceplate

- 1 Align the projections on the unit with the grooves on the faceplate.

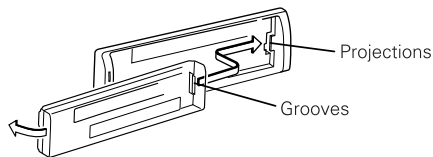

- 2 Push the faceplate in until it clicks.  
The faceplate is locked in place, allowing you to use the unit.

## Tuner features

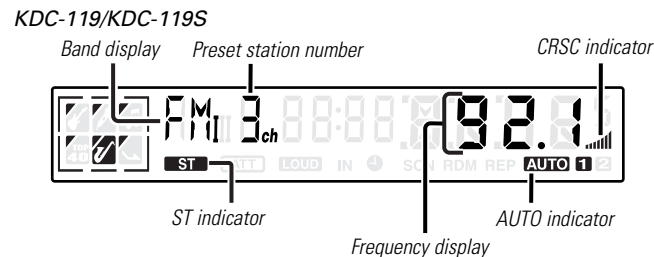
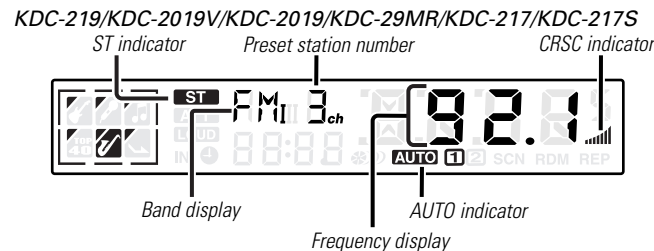
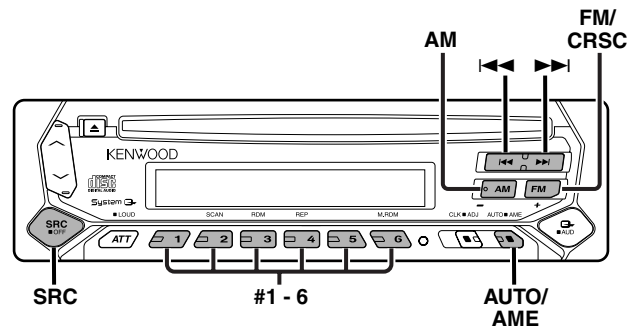

## Tuning Mode

Choose the tuning mode.

Press the [AUTO] button.

Each time the button is pressed the Tuning mode switches as shown below.

Tuning mode	Display	Operation
Auto seek	"AUTO 1" indicator	Automatic search for a station.
Preset station seek	"AUTO 2" indicator	Search in order of the stations in the Preset memory.
Manual	—	Normal manual tuning control.

## Tuning

Selecting the station.

### 1 Select tuner source

Press the [SRC] button.

Select the "TUnE" display.

### 2 Select the band

Press the [FM] or [AM] button.

Each time the [FM] button is pressed it switches between the FM1, FM2, and FM3 bands.

### 3 Tune up or down band

Press the [◀◀] or [▶▶] button.



During reception of stereo stations the "ST" indicator is ON.

## Station Preset Memory

Putting the station in the memory.

### 1 Select the band

Press the [FM] or [AM] button.

### 2 Select the frequency to put in the memory

Press the [◀◀] or [▶▶] button.

### 3 Put the frequency in the memory

Press the [#1] — [#6] button for at least 2 seconds.

The preset number display blinks 1 time.

On each band, 1 station can be put in the memory on each [#1] — [#6] button.

## Auto Memory Entry

Putting stations with good reception in the memory automatically.

### 1 Select the band for Auto Memory Entry

Press the [FM] or [AM] button.

### 2 Open Auto Memory Entry

Press the [AME] button for at least 2 seconds.

When 6 stations that can be received are put in the memory Auto Memory Entry closes.

## Preset Tuning

Calling up the stations in the memory.

### 1 Select the band

Press the [FM] or [AM] button.

### 2 Call up the station

Press the [#1] — [#6] button.

## Tuner features

### CRSC (Clean Reception System Circuit)

Temporarily have reception switched from stereo to mono to reduce multi-path noise when listening to the FM station.

Press the [CRSC] button for at least 1 second.

Each time the button is pressed CRSC turns ON or OFF. When it's ON, the CRSC indicator is ON.

## CD/External disc control features

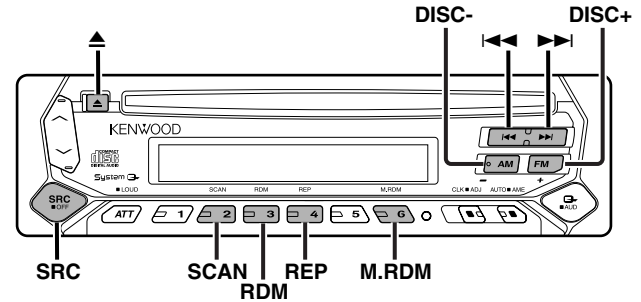

KDC-219/KDC-2019V/KDC-2019/KDC-29MR/KDC-217/KDC-217S

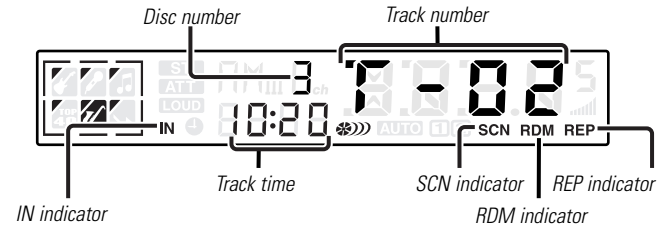

KDC-119/KDC-119S

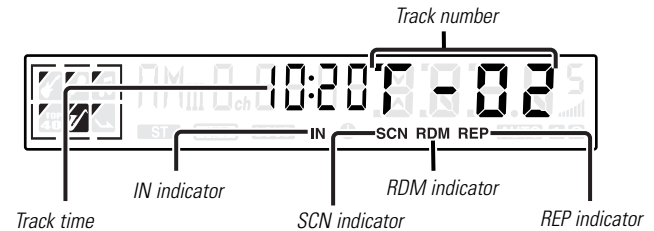

## Playing CD

### When a CD is inserted

Press the [SRC] button.  
Select the "CD" display.

 When a CD is inserted, the "IN" indicator is ON.

### Eject the CD

Press the [▲] button.

 3 in. (8cm) CD cannot be played. Using an adapter and inserting them into this unit can cause damage.

*Function of the KDC-219/KDC-2019V/KDC-2019/KDC-29MR*

## Playing External Disc

Playing discs set in the optional accessory disc player connected to this unit.

Press the [SRC] button.  
Select the display for the disc player you want.  
Display examples:

Display	Disc player
"CD-2"	CD player
"DISC"	CD changer
"DISC"	MD changer

-  • Disc #10 is displayed as "0".  
• The functions that can be used and the information that can be displayed will differ depending on the external disc players being connected.

## Fast Forwarding and Reversing

### Fast Forwarding

Hold down on the [▶▶] button.  
Release your finger to play the disc at that point.

### Reversing

Hold down on the [◀◀] button.  
Release your finger to play the disc at that point.

## Track Search

Selecting the song you want to hear.

Press the [◀◀] or [▶▶] button.

*Function of the KDC-219/KDC-2019V/KDC-2019/KDC-29MR*

## Album Search (Function of disc changer)

Selecting the disc you want to hear.

Press the [DISC-] or [DISC+] button.

## Track/Album Repeat

Replaying the song/disc you're listening to.

Press the [REP] button.  
Each time the button is pressed the Repeat Play switches as shown below.

Repeat play	Display
Track Repeat	"REP" indicator & Track No. blink.
Album Repeat (Function of disc changer)	"REP" indicator & Disc No. blink.
OFF	—

## CD/External disc control features

### Track Scan

Playing the first part of each song on the disc you are listening to and searching for the song you want to listen to.

#### 1 Start Track Scan

Press the [SCAN] button.  
"SCN" indicator is ON.

#### 2 Release it when the song you want to listen to is played

Press the [SCAN] button.

When it's ON, the "RDM" indicator is ON and the track and disc number blink.



When the [▶▶] button is pressed, the next song select starts.

### Random Play

Playing all the songs on the disc in random order.

Press the [RDM] button.

Each time the button is pressed Random Play turns ON or OFF. When it's ON, the "RDM" indicator is ON and the track number blinks.



When the [▶▶] button is pressed, the next song select starts.

*Function of the KDC-219/KDC-2019V/KDC-2019/KDC-29MR*

### Magazine Random Play

**(Function of disc changer)**

Play the songs on all the discs in the disc changer in random order.

Press the [M.RDM] button.

Each time the button is pressed the Magazine Random Play turns ON or OFF.

## Basic Operations of remote

Accessory of the KDC-219/KDC-2019V/KDC-2019

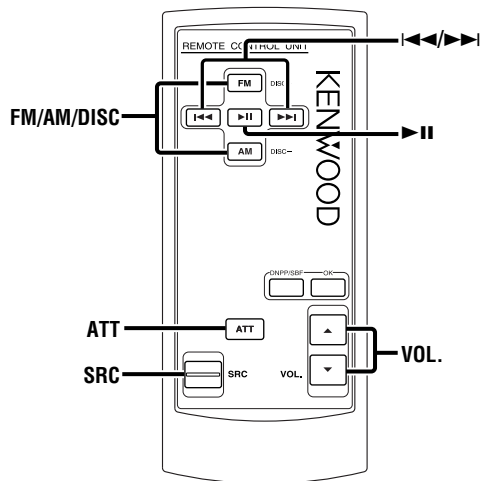

## Loading and Replacing the battery

Use one lithium battery (CR2025). Insert the batteries with the + and - poles aligned properly, following the illustration inside the case.

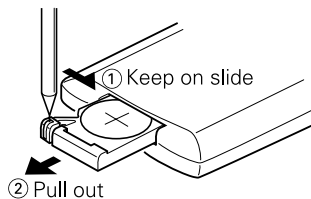

### ⚠ WARNING

Store unused batteries out of the reach of children. Contact a doctor immediately if the battery is accidentally swallowed.

⚠ Do not set the remote on hot places such as above the dashboard.

## Basic operations

### [VOL.] buttons

Adjusting the volume.

### [SRC] button

Each time the button is pressed the source switches. For the source switching order refer to <Selecting the Source> (page 7).

### [ATT] button

Turning the volume down quickly. When it is pressed again it returns to the previous level.

## Basic Operations of remote

Accessory of the KDC-219/KDC-2019V/KDC-2019

### In Tuner source

#### [FM]/ [AM] buttons

Select the band.

Each time the [FM] button is pressed it switches between the FM1, FM2, and FM3 bands.

#### [◀◀]/ [▶▶] buttons

Tune up or down band.

### In Disc source

#### [◀◀]/ [▶▶] buttons

Doing track forward and backward.

#### [DISC+]/ [DISC-] buttons

Doing album forward and backward.

#### [▶||] button

Each time the button is pressed the song pauses and plays.



## Accessories

### External view

..... Number of items

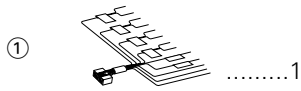

### External view

..... Number of items

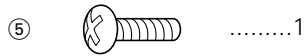
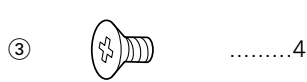

(KDC-219/KDC-2019V/KDC-2019/  
KDC-217/KDC-217S only)



The use of any accessories except for those provided might result in damage to the unit. Make sure only to use the accessories shipped with the unit, as shown above.

## Installation Procedure

1. To prevent a short circuit, remove the key from the ignition and disconnect the ⊖ battery.
2. Make the proper input and output wire connections for each unit.
3. Connect the speaker wires of the wiring harness.
4. Connect the wiring harness wires in the following order: ground, battery, ignition.
5. Connect the wiring harness connector to the unit.
6. Install the unit in your car.
7. Reconnect the ⊖ battery.
8. Press the reset button.

### ▲WARNING

If you connect the ignition wire (red) and the battery wire (yellow) to the car chassis (ground), you may cause a short circuit, that in turn may start a fire. Always connect those wires to the power source running through the fuse box.

### ▲CAUTION

- If your car's ignition does not have an ACC position, connect the ignition wires to a power source that can be turned on and off with the ignition key. If you connect the ignition wire to a power source with a constant voltage supply, as with battery wires, the battery may die.
- If the console has a lid, make sure to install the unit so that the faceplate will not hit the lid when closing and opening.
- If the fuse blows, first make sure the wires aren't touching to cause a short circuit, then replace the old fuse with one with the same rating.
- Insulate unconnected wires with vinyl tape or other similar material. To prevent a short circuit, do not remove the caps on the ends of the unconnected wires or the terminals.
- Connect the speaker wires correctly to the terminals to which they correspond. The unit may be damaged or fail to work if you share the ⊖ wires or ground them to any metal part in the car.
- When only two speakers are being connected to the system, connect the connectors either to both the front output terminals or to both the rear output terminals (do not mix front and rear). For example, if you connect the ⊕ connector of the left speaker to a front output terminal, do not connect the ⊖ connector to a rear output terminal
- After the unit is installed, check whether the brake lamps, blinkers, wipers, etc. on the car are working properly.
- Mount the unit so that the mounting angle is 30° or less.

# Connecting Wires to Terminals

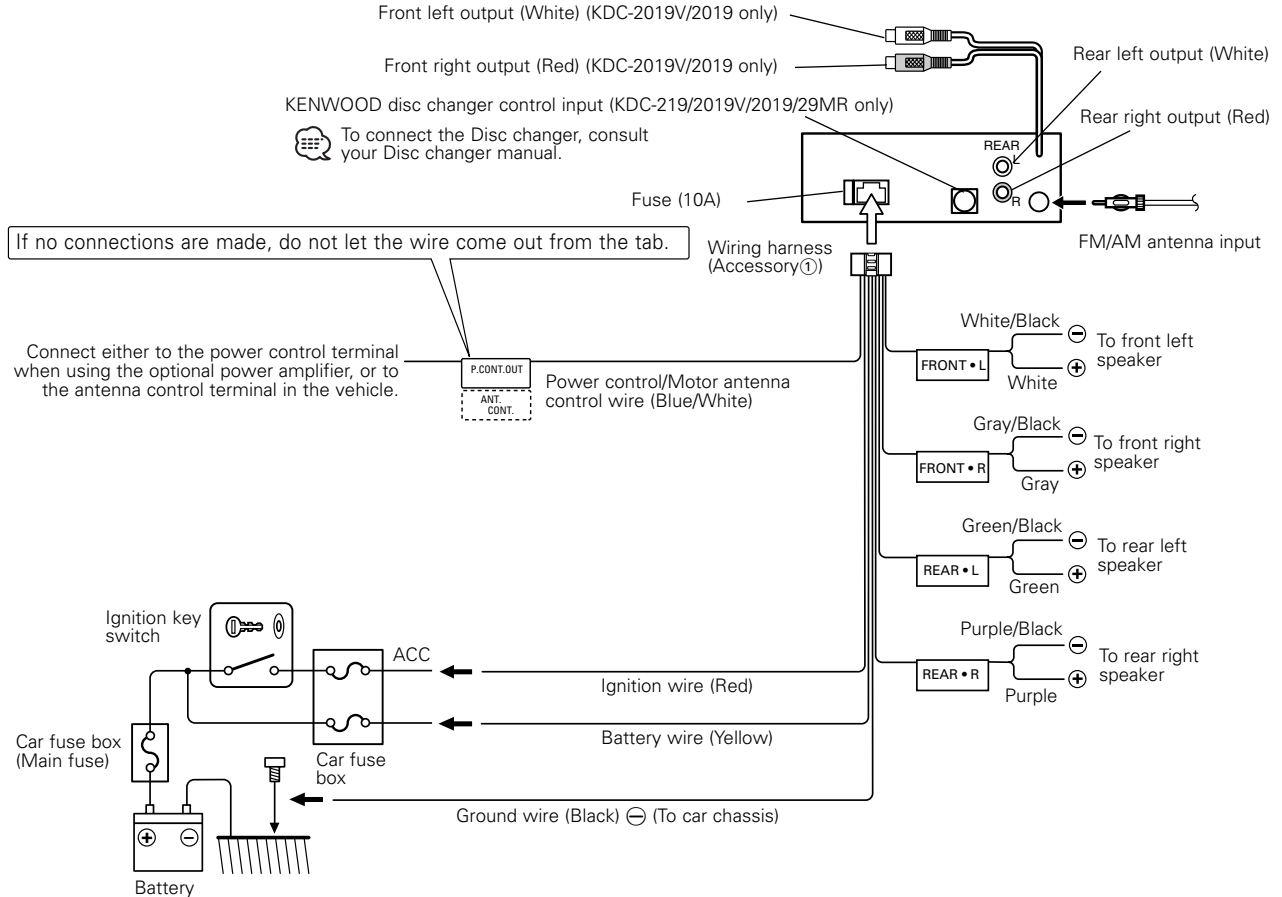

# Installation

## ■ Installation

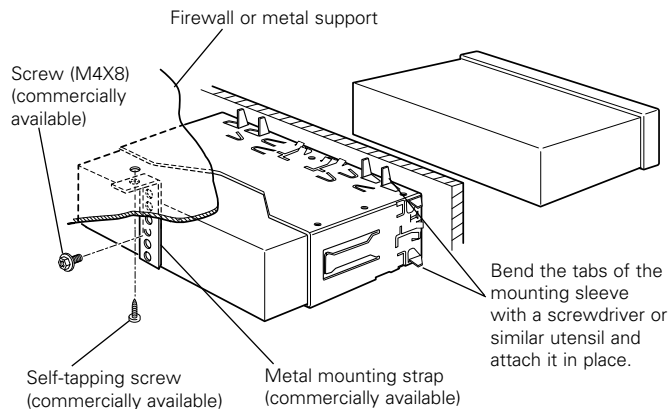

Make sure that the unit is installed securely in place. If the unit is unstable, it may malfunction (for example, the sound may skip).

## ■ Installing in Japanese-Made Cars

- 1 Refer to the section "Removing the hard rubber frame" (page 20) and then remove the hard rubber frame.
- 2 Align the holes in the unit (two locations on each side) with the vehicle mounting bracket and secure the unit with the accessory screws.

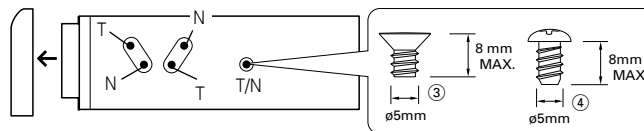

T: Toyota cars  
N: Nissan cars

Accessory③...for Nissan car  
Accessory④...for Toyota car

- ⚠ During installation, do not use any screws except for those provided. The use of different screws might result in damage to the main unit.
- Damage may occur if a screwdriver or similar tool is used with excessive force during the installations.

## ■ Screwing the Faceplate on the Unit

If you want to fasten the faceplate to the main unit so that it does not fall off, screw in the provided screw (ø4 X 16 mm) in the hole shown below.

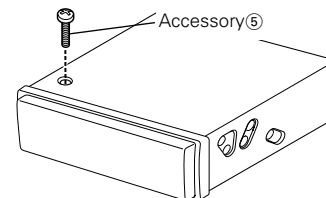

- ⚠ Never insert the tapite screw (ø4 x 16 mm) in any other screw hole than the one specified. If you screw it in another hole, it will contact and may cause damage to the mechanical parts inside the unit.

## Installation

### ■ Removing the hard rubber frame

- Engage the catch pins on the removal tool and remove the two locks on the lower level.  
Lower the frame and pull it forward as shown in the figure.

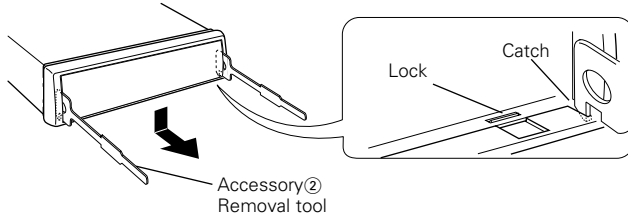

- When the lower level is removed, remove the upper two locations.

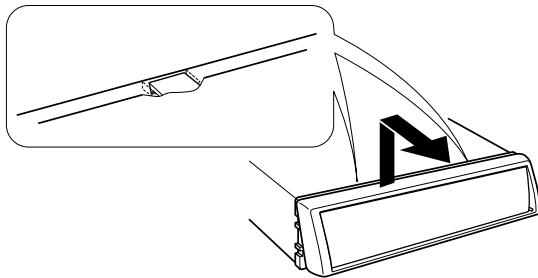

 The frame can be removed from the top side in the same manner.

### ■ Removing the Unit

- Refer to the section "Removing the hard rubber frame" and then remove the hard rubber frame.
- Remove the screw (M4 × 8) on the back panel.
- Insert the two removal tools deeply into the slots on each side, as shown.

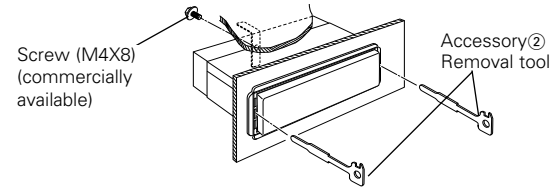

- Lower the removal tool toward the bottom, and pull out the unit halfway while pressing towards the inside.

 Be careful to avoid injury from the catch pins on the removal tool.

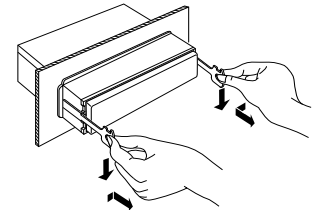

- Pull the unit all the way out with your hands, being careful not to drop it.

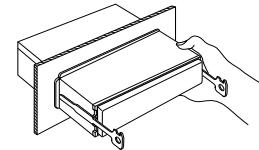

## Troubleshooting Guide

**What might seem to be a malfunction in your unit may just be the result of slight misoperation or miswiring. Before calling service, first check the following table for possible problems.**

### General

#### ? The power does not turn ON.

- ✓ The fuse has blown.
  - ☞ After checking for short circuits in the wires, replace the fuse with one with the same rating.
- ✓ No ACC position on vehicle ignition.
  - ☞ Connect the same wire to the ignition as the battery wire.

#### ? Nothing happens when the buttons are pressed.

- ✓ The computer chip in the unit is not functioning normally.
  - ☞ Press the reset button on the unit (page 5).

#### ? There's a source you can't switch.

- ✓ There's no CD inserted.
  - ☞ Set the media you want to listen to. If there's no media in this unit, you can't switch to each source.

#### ? The memory is erased when the ignition is turned OFF.

- ✓ The battery wire has not been connected to the proper terminal.
  - ☞ Connect the wire correctly, referring to the section on <Connecting Wires to Terminals>.
- ✓ The ignition and battery wire are incorrectly connected.
  - ☞ Connect the wire correctly, referring to the section on <Connecting Wires to Terminals>.

#### ? Even if Loudness is turned ON, high-pitched tone isn't compensated for.

- ✓ Tuner source is selected.
  - ☞ High-pitched tone isn't compensated for when in Tuner source.

#### ? No sound can be heard, or the volume is low.

- ✓ The fader or balance settings are set all the way to one side.
  - ☞ Center the fader and balance settings.
- ✓ The input/output wires or wiring harness are connected incorrectly.
  - ☞ Reconnect the input/output wires or the wiring harness correctly. See the section on <Connecting Wires to Terminals>.

#### ? The sound quality is poor or distorted.

- ✓ One of the speaker wires is being pinched by a screw in the car.
  - ☞ Check the speaker wiring.
- ✓ The speakers are not wired correctly.
  - ☞ Reconnect the speaker wires so that each output terminal is connected to a different speaker.

#### ? The Touch Sensor Tone doesn't sound.

- ✓ The preout jack is being used.
  - ☞ The Touch Sensor Tone can't be output from the preout jack.

### Tuner source

#### ? Radio reception is poor.

- ✓ The car antenna is not extended.
  - ☞ Pull the antenna out all the way.
- ✓ The antenna control wire is not connected.
  - ☞ Connect the wire correctly, referring to the section on <Connecting Wires to Terminals>.

## Troubleshooting Guide

### Disc source

#### ? "AVin" is displayed without achieving External disc control mode.

- ✓ O-N switch is set to "O" side.  
☞ Set the switch to "N" side.

---

- ✓ Unsupported disc changer is connected.  
☞ Connect the supported disc changer. (page 4)

#### ? The specified disc does not play, but another one plays instead.

- ✓ The specified CD is quite dirty.  
☞ Clean the CD.

---

- ✓ The CD is upside-down.  
☞ Load the CD with the labeled side up.

---

- ✓ The disc is loaded in a different slot from that specified.  
☞ Eject the disc magazine and check the number for the specified disc.

---

- ✓ The disc is severely scratched.  
☞ Try another disc instead.

#### ? The specified track will not play.

- ✓ Random play or magazine random play has been selected.  
☞ Turn off random play or magazine random play.

#### ? Track repeat, disc repeat, track scan, random play, and magazine random play start by themselves.

- ✓ The setting is not canceled.  
☞ The settings for these functions remain on until the setting to off or the disc ejected, even if the power is turned off or the source changed.

#### ? Cannot play CD-R or CD-RW.

- ✓ Finalization processing is not being conducted for CD-R/CD-RW.  
☞ Conduct finalization processing with CD recorder.

---

- ✓ A non-compatible CD changer is being used to play the CD-R/CD-RW.  
☞ Use a CD changer compatible with CD-R/CD-RW to play.

#### ? A CD ejects as soon as it is loaded.

- ✓ The CD is upside-down.  
☞ Load the CD with the labeled side up.

---

- ✓ The CD is quite dirty.  
☞ Clean the CD, referring to the section on <CD cleaning> (page 6).

#### ? Can't remove disc.

- ✓ The cause is that more than 10 minutes has elapsed since the vehicle ACC switch was turned OFF.  
☞ The disc can only be removed within 10 minutes of the ACC switch being turned OFF. If more than 10 minutes has elapsed, turn the ACC switch ON again and press the Eject button.

#### ? The disc won't insert.

- ✓ There's already another disc inserted.  
☞ Press the [▲] button and remove the disc.

#### ? Track Search can't be done.

- ✓ For the albums first or last song.  
☞ For each album, Track Search can't be done in the backward direction for the first song or in the forward direction for the last song.

### If the following situations, consult your nearest service center:

- Even though the disc changer is connected, the Disc Changer source is not ON, with "AVin" showing in the display during the Changer Mode.
- Even though no device (KCA-S210A, CA-C1AX, KDC-CPS87, KDC-CX87, KDC-CPS85, KDC-CX85, KDC-CPS82 or KDC-CX82) is connected, the Auxiliary input is entered when switching modes.

**The messages shown below display your systems condition.**

- E-01: No disc magazine has been loaded in the changer. The disc magazine is not completely loaded.  
⇨ Load the disc magazine properly.  
No CD in the unit.  
⇨ Insert the CD.
- E-02: No disc has been loaded in the disc magazine.  
⇨ Load a disc into the disc magazine.
- E-04: No disc has been loaded in the disc magazine.  
⇨ Load a disc into the disc magazine.  
The CD is quite dirty. The CD is upside-down. The CD is scratched a lot.  
⇨ Clean the CD and load it correctly.
- E-10: Nothing has been recorded on the MD.
- E-11: No tracks are recorded on the MD, although it has a title.
- E-12: The faceplate of the slave unit being connected to this unit has been removed.  
⇨ Replace it.
- E-77: The unit is malfunctioning for some reason.  
⇨ Press the reset button on the unit. If the "E-77" code does not disappear, consult your nearest service center.
- E-99: The unit is malfunctioning for some reason.  
⇨ Press the reset button on the unit. If the "E-99" code does not disappear, consult your nearest service center.

E-0d: The protective circuit in the unit activates when the temperature inside the automatic disc changer exceeds 60°C (140°F), stopping all operation.  
⇨ Cool down the unit by opening the windows or turning on the air conditioner. As the temperature falls below 60°C (140°F), the disc will start playing again.

LOAD: Discs are being exchanged in the Disc changer.

IN (Blink): The CD player section is not operating properly.  
⇨ Reinsert the CD. If the CD cannot be ejected or the display continues to flash even when the CD has been properly reinserted, please switch off the power and consult your nearest service center.

## Specifications

Specifications subject to change without notice.

### FM tuner section

Frequency range (200 kHz space) .....	87.9 MHz – 107.9 MHz
Usable sensitivity (S/N = 30dB) .....	9.3dBf (0.8 $\mu$ V/75 $\Omega$ )
Quieting Sensitivity (S/N = 50dB) .....	15.2dBf (1.6 $\mu$ V/75 $\Omega$ )
Frequency response ( $\pm$ 3 dB) .....	30 Hz – 15 kHz
Signal to Noise ratio (MONO) .....	70 dB
Selectivity ( $\pm$ 400 kHz) .....	$\geq$ 80 dB
Stereo separation (1 kHz) .....	40 dB

### AM tuner section

Frequency range (10 kHz space) .....	530 kHz – 1700 kHz
Usable sensitivity (S/N = 20dB) .....	28 dB $\mu$ (25 $\mu$ V)

### CD player section

Laser diode .....	GaAlAs ( $\lambda$ =780 nm)
Digital filter (D/A) .....	8 Times Over Sampling
D/A Converter .....	1 Bit
Spindle speed .....	500 – 200 rpm (CLV)
Wow & Flutter .....	Below Measurable Limit
Frequency response ( $\pm$ 1 dB) .....	10 Hz – 20 kHz
Total harmonic distortion (1 kHz) .....	0.01 %
Signal to Noise ratio (1 kHz) .....	96 dB
Dynamic range .....	93 dB
Channel separation .....	85 dB

### Audio section

Maximum output power	
KDC-219/2019V/2019 .....	50 W x 4
KDC-29MR/217/217S/119/119S .....	45 W x 4
Full Bandwidth Power (at less than 1% THD) .....	22 W x 4
Tone action	
Bass : .....	100 Hz $\pm$ 10 dB
Middle : .....	1 kHz $\pm$ 10 dB
Treble : .....	10 kHz $\pm$ 10 dB
Preout level / Load (during disc play) .....	1800 mV/10 k $\Omega$
Preout impedance .....	$\leq$ 600 $\Omega$

### General

Operating voltage (11 – 16V allowable) .....	14.4 V
Current consumption .....	10 A
Installation Size (W x H x D) .....	182 x 53 x 157 mm
	7-3/16 x 2-1/16 x 6-3/16 inch
Weight .....	3.1 lbs (1.4 kg)



KENWOOD

## Free Manuals Download Website

<http://myh66.com>

<http://usermanuals.us>

<http://www.somanuals.com>

<http://www.4manuals.cc>

<http://www.manual-lib.com>

<http://www.404manual.com>

<http://www.luxmanual.com>

<http://aubethermostatmanual.com>

Golf course search by state

<http://golfingnear.com>

Email search by domain

<http://emailbydomain.com>

Auto manuals search

<http://auto.somanuals.com>

TV manuals search

<http://tv.somanuals.com>