

KENWOOD

CD-RECEIVER

KDC-XBT8013U
KDC-XBT8013UL
KDC-X7013U
KDC-X7013UL

INSTRUCTION MANUAL

Kenwood Corporation



© B64-4418-00/00 (MW/M3W)

Contents

Before use	3	Sound Setup	25
Basic Operation	4	Cabin selection	
Hands-free phoning		Speaker setting	
Function Control	6	DTA (Digital Time Alignment) setting	
Display Settings	10	X'Over setting	
Display Type Selection		Preset Equalizer curve select	
Text Display Selection		Manual Equalizer Control	
Illumination Color Selection		Preset position selection	
Auxiliary Input Display Setting		Manual position setting	
Music disc/Audio file Operation	12	Audio Preset Memory	
Music Search		Audio Preset Recall	
Music Search for iPod		Favorite Control	30
Searching for Music by Initial		Favorite Preset Memory	
All Random		Favorite Preset Recall	
iPod Control by Hand Mode		Favorite Preset Memory Delete	
Direct Music Search		Favorite Name Setting	
Direct Disc Search		Bluetooth Setup	32
Basic Operation of Disc Changer (Optional)		Registering Bluetooth device	
Tuner Operation	15	Registering Special Bluetooth device	
Auto Memory Entry		Registering PIN Code	
Station Preset Memory		Downloading the Phone Book	
Preset Tuning		Selecting the Bluetooth device You Wish to Connect	
Direct Access Tuning		Deleting a Registered Bluetooth device	
Frequency Step Setting		Displaying the Firmware Version	
Operation of hands-free phoning	16	Adding a voice dialing command	
Before Use		Setting a Voice Command for Category	
Receiving a call		SMS (Short Message Service)	
During a call		Downloading the SMS	
Call waiting		TV control (Optional)	37
Other functions		Basic Operation	
Making a call		Preset Memory	
Dial a number		Preset Tuning	
Speed dialing (Preset dial)		Direct TV Tuning	
Calling a number in the Phone Book		Basic Operations of remote control	38
Calling a number in the call log		Appendix	40
Make a voice dialing call		Accessories/ Installation Procedure	44
Registering to the Preset Dial Number List		Connecting Wires to Terminals	45
Display of phone number type (category)		Installation/Removing the Unit	46
Bluetooth Audio Operation	20	Troubleshooting Guide	48
Before Use		Specifications	51
Basic Operation			
Other Functions	21		
Activating Security Code			
Deactivating Security Code			
Manual Clock Adjustment			
Date Adjustment			
Date Format Selection			
AMP Control			
Demonstration mode setting			
Theft Deterrent Faceplate			
Audio Adjustments	24		
Audio Control			
Audio Setup			

Before use

▲WARNING

To prevent injury or fire, take the following precautions:

- To prevent a short circuit, never put or leave any metallic objects (such as coins or metal tools) inside the unit.

Do not use this unit before canceling Demonstration mode!

This unit is initially set on the Demonstration mode. When using this unit for the first time, cancel the <Demonstration mode setting> (page 23).

How to reset your unit

- If this unit or the connected unit (disc auto changer, etc.) fails to operate properly, press the Reset button. The unit returns to factory settings when the Reset button is pressed.

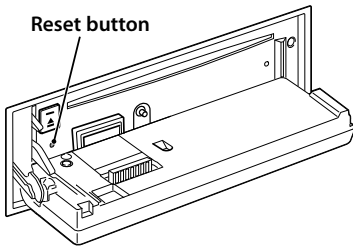

Cleaning the Unit

If the faceplate of this unit is stained, wipe it with a dry soft cloth such as a silicon cloth. If the faceplate is stained badly, wipe the stain off with a cloth moistened with neutral cleaner, then wipe it again with a clean soft dry cloth.



- Applying spray cleaner directly to the unit may affect its mechanical parts. Wiping the faceplate with a hard cloth or using a volatile liquid such as thinner or alcohol may scratch the surface or erase characters.

Cleaning the Faceplate Terminals

If the terminals on the unit or faceplate get dirty, wipe them with a clean soft dry cloth.

Lens Fogging

When you turn on the car heater in cold weather, dew or condensation may form on the lens in the CD player of the unit. Called lens fogging, this condensation on the lens may not allow CDs to play. In such a situation, remove the disc and wait for the condensation to evaporate. If the unit still does not operate normally after a while, consult your Kenwood dealer.

- If you experience problems during installation, consult your Kenwood dealer.
- When you purchase optional accessories, check with your Kenwood dealer to make sure that they work with your model and in your area.
- Characters that conform to GB2312 or ISO 8859-1 can be displayed. Refer to "MENU" > "Chinese" of <Function Control> (page 6).
- Characters that conform to ISO 8859-1 ("English"), Windows CP 1256 ("Arabic"/ "Persian") and Windows CP 874 ("Thai") can be displayed. Refer to "MENU" > "Language" of <Function Control> (page 6).
- In this document, the description indicator will light means a status is displayed. Refer to <Display Type Selection> (page 10) for the details of the status display.
- The illustrations of the display and the panel appearing in this manual are examples used to explain more clearly how the controls are used. Therefore, what appears on the display in the illustrations may differ from what appears on the display on the actual equipment, and some of the illustrations on the display may be inapplicable.

Handling CDs

- Do not touch the recording surface of the CD.
- Do not stick tape etc. on the CD, or use a CD with tape stuck on it.
- Do not use disc type accessories.
- Clean from the center of the disc and move outward.
- When removing CDs from this unit, pull them out horizontally.
- If the CD center hole or outside rim has burrs, use the CD only after removing the burrs with a ballpoint pen etc.

CDs that cannot be used

- CDs that are not round cannot be used.

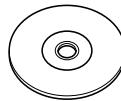

- CDs with coloring on the recording surface or CDs that are dirty cannot be used.

This unit can only play the CDs with This unit may not correctly play discs which do not have the mark.

- You cannot play a CD-R or CD-RW that has not been finalized. (For the finalization process refer to your CD-R/CD-RW writing software, and your CD-R/CD-RW recorder instruction manual.)

Basic Operation

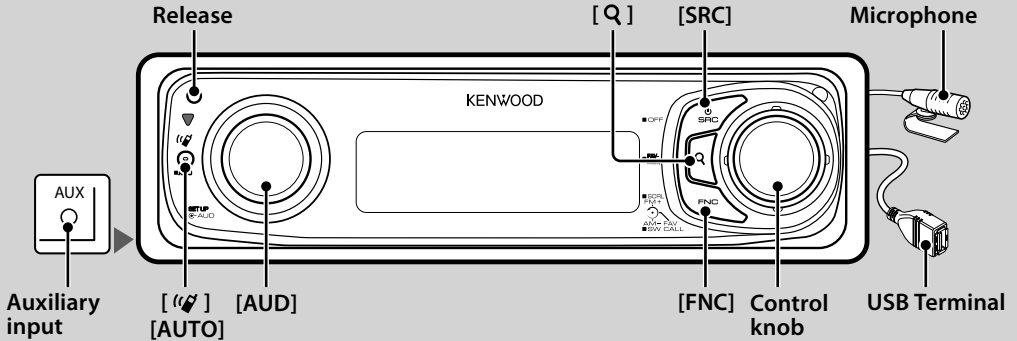

General functions

Power/Source Select button: [SRC]

Turns on the power.

When the power is ON, select a source.

SRC Select mode 1: Press the [SRC] button and then turn the Control knob or push it toward up or down. To determine the selected source, press the Control knob.

SRC Select mode 2: Pressing this button each time switches between sources.

Tuner ("TUNER"), USB or iPod ("USB" or "iPod"), CD ("CD"), Auxiliary input ("AUX"), and Standby ("STANDBY")

Press at least 1 second to turn off the power.



- The SRC Select mode can be set in "MENU" > "SRC Select" of <Function Control> (page 6).
- Auxiliary input source is initially set to "OFF". Set "Built in AUX" described in <Function Control> (page 6) to "ON". : Select "MENU" > "Built in AUX"
- When an optional accessory is connected, the source name for each device appears.
- When connection of the iPod is recognized, the source display changes from "USB" to "iPod".
- USB (iPod) source is recognized as CD source on the connected unit.

Volume control: [AUD] knob

Turn the knob to adjust the volume.

Subwoofer output: Control knob

Switches between ON ("SUBWOOFER ON") and OFF ("SUBWOOFER OFF") each time pushing toward down for at least 2 seconds.

Auxiliary input

Connect a portable audio device with mini-plug cable (3.5 ø).



- Use the mini-plug cable which is stereo type and does not have any resistance.
- The auxiliary input requires the setting made in "MENU" > "AUX" of <Function Control> (page 6).

Text/Title scroll: Control knob

Scrolls the CD and audio file text display when pushing toward up for at least 2 seconds.

Muting volume upon reception of phone call

When there is a call, "CALL" is displayed and the audio system is paused.

When the call ends, "CALL" disappears and the audio system comes back on.

The audio system comes back on when [SRC] is pressed during a call.



- To use the TEL Mute feature, you need to hook up the MUTE wire to your telephone using a commercial telephone accessory. Refer to <Connecting Wires to Terminals> (page 45).

Function Control: [FNC]

Pressing this button allows you to set various functions using the Control knob. Refer to <Function Control> (page 6).

Category	Function of setup item
MENU	Allows you to set up the environment.
SETUP	Allows you to set up the display and color.
SOUND	Allows you to set up the sound environment.
BT	Allows you to set up the Bluetooth function.
—	Allows you to set up the each source function.

Favorite Control: Control knob

You can recall the various registered functions by turning the Control knob.
 For example, you can recall and playback the playlist in iPod while listening to Tuner.
 Refer to <Favorite Control> (page 30).

Tuner functions

FM band: Control knob

Switches between FM1, FM2, and FM3 each time pushing toward up.

AM band: Control knob

Switches to AM when pushing toward down.

Tuning: Control knob

Changes the frequency when pushing toward left or right.



- During reception of stereo stations the "ST" indicator is ON.

Tuning mode select: [AUTO]

- For KDC-X7013U/ KDC-X7013UL:
Switches as follows each time this button is pressed.
- For KDC-XBT8013U/ KDC-XBT8013UL: Switches as follows each time this button is pressed for at least 1 second.

Tuning mode	Display	Operation
Auto seek	"Seek Mode : Auto1"	Automatic search for a station.
Preset station seek	"Seek Mode : Auto2"	Search in order of the stations in the Preset memory.
Manual	"Seek Mode : Manual"	Normal manual tuning control.

Disc & Audio file play functions

Drop open the faceplate: Release



- Push the faceplate on the left side, and return it to its former position.

Disc play: Disc slot

Starts playing when a disc is inserted.
 When a CD is inserted, the "CD-IN" indicator is ON.

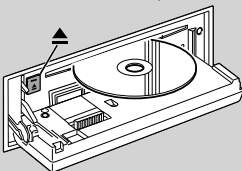

- 3 inch (8 cm) CD cannot be used. Attempt to insert using an adapter can cause malfunction.

Disc ejection: [▲]



- You can eject the disc for 10 minutes after switching off the engine.

USB device/iPod play: USB Terminal

Connecting a USB device starts playback.



- For the playable audio file, media, and devices, refer to <About Audio file> (page 40).

Pause and play: Control knob

Switches between pause and play each time this button is pressed.

USB device removing: [▲]

Press this button for 2 seconds or longer to select the remove mode, and the remove the USB device.
 During the remove mode, "USB REMOVE" is displayed.

Music search: Control knob

Changes the music when pushing toward left or right.
 Fast reverses or forwards the music while keeping pushing toward left or right. (No sound is output while playing audio file.)

Folder search: Control knob

Changes the folder containing the audio file when pushing toward up or down.

- For the operation on iPod, enter <Music Search for iPod> (page 12) is first to enter the search mode.

Search mode: [Q]

After pressing [SEARCH] button, you can quickly search songs with the Control knob. See <Music Search> (page 12) for details.

Hands-free phoning

Microphone:

(Accessory of KDC-XBT8013U/ KDC-XBT8013UL)
 The microphone for the hands free phone is supplied.
 When your voice cannot be recognized due to the low microphone volume or noises in the vehicle, adjust the microphone settings by selecting "MENU" > "Mic Gain" of <Function Control> and "MENU" > "NR Level" of <Function Control> (page 6).

Function Control

Functions in the table below can be set up by using Function Control.

1 Enter Function Control mode

Press the [FNC] button.

2 Select a Function group.

Push the Control knob towards right or left.

Pushing the Control knob towards left allows you to set the preference items ("MENU", "SETUP", or "SOUND").

Pushing the Control knob towards right allows you to set the currently selected source function item ON/OFF.

3 Select your desired setup item

Operation type	Operation
Movement between items	Turn the Control knob.
Selection of item	Press the Control knob.
Return to previous item	Press the [FNC] button. Select "Return" at the bottom of the item list.

Repeat selection and determination until your desired setup item is selected.

Example:

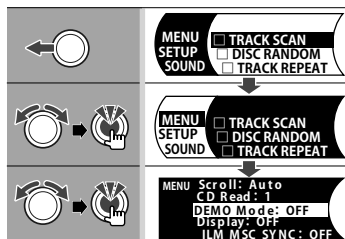

In this manual, the above selection is indicated as

Select "MENU" > "DEMO Mode".

Each item's "□" will be "✓" when the source function is set to ON.

4 Make a setting

Push the Control knob towards up or down.

Press the Control knob to set the source function item ON/OFF.

- Some items require you to keep pressing the Control knob for 1 or 2 seconds so that you can make a setting. For these items, the time during which you need to keep pressing the Control knob is displayed in the Entry column in seconds.
- For the functions accompanied by the description of the setting procedure and so forth, the reference page numbers are displayed.

5 Exit Function Control mode

Press the [FNC] button for at least 1 second.

Displayed item is depending on currently selected source or mode. The mark in Condition column shows the condition to which the item is displayed.

- SB** : Can be set in other than standby state.
- SB** : Can be set in standby state.
- AF1** : Can be set while Audio file source of CD/USB/iPod.
- AF2** : Can be set while Audio file source of CD/USB (excluding iPod).
- DISC** : Can be set while CD/ Disc changer source.
- CD** : Can be set while CD source.
- CH** : Can be set while Disc changer source.
- Tuner** : Can be set during Tuner source.
- FM** : Can be set during FM reception.
- AUX** : Can be set while accessing AUX source.
- iPod** : Can be set only during playback of the iPod source.
- 2ZONE** : Can be set for sources other than the standby source by setting "2 ZONE" of <Audio Setup> (page 24) to "ON".
- Phone** : Can be set while a cell-phone is connected.
- ILLumi** : Sets "ILM MSC SYNC" in the menu to "OFF".
- : Refer to the reference page.
- : Can be set during all sources.

The Control knob is used for entry, but how to use the knob varies depending on the setting items.

- : Press the Control knob to switch the settings.
- : Push the Control knob towards left or right to switch the settings.
- : Turn the Control knob to switch the settings.
- 1 sec.** : Press the Control knob for 1 second to enter into the setting mode.
- 2 sec.** : Press the Control knob for 2 seconds to enter into the setting mode.



- Refer to the respective page for information on how to set the items with reference page number.
- Only the items available to the current source are displayed.
- The "SOUND" setting cannot be performed while the Dual Zone function is used.

*Factory setting

*1 Function of KDC-XBT8013U.

*2 Function of KDC-XBT8013UL.

*3 Function of KDC-X7013U.













*4 Function of KDC-X7013UL.

*5 Refer to <Menu Glossary> (page 42).

Source function item

Function	Setting	Entry	Setting overview	Condition	Page
"iPod BY HAND"	"ON"/"OFF"*		When set to "ON", allows you to operate iPod with the control on the iPod.	iPod	13
"FILE SCAN"	"ON"/"OFF"*		When set to "ON", plays the intro of the music in the folder successively.	AF₂	—
"FOLDER RDM"	"ON"/"OFF"*		When set to "ON", plays the music in the folder randomly.	AF₁	—
"ALL RANDOM"	"ON"/"OFF"*		When set to "ON", all songs in iPod are played at random.	iPod	13
"FILE REPEAT"	"ON"/"OFF"*		When set to "ON", plays the music repeatedly.	AF₁	—
"FOLDER REP"	"ON"/"OFF"*		When set to "ON", plays the music in the folder repeatedly.	AF₂	—
"TRACK SCAN"	"ON"/"OFF"*		When set to "ON", plays the intro of the music on the disc successively.	DISC	—
"DISC RANDOM"	"ON"/"OFF"*		When set to "ON", plays the music on the disc randomly.	DISC	—
"MAGAZINE RDM"	"ON"/"OFF"*		When set to "ON", plays the music in the disc changer randomly.	CH	—
"TRACK REPEAT"	"ON"/"OFF"*		When set to "ON", plays the music repeatedly.	DISC	—
"DISC REPEAT"	"ON"/"OFF"*		When set to "ON", plays the music on the disc repeatedly.	CH	—
"AUTO MEMORY"			Memorizes 6 stations with good reception automatically.	Tuner	15

Preference item

Category	Item	Setting	Entry	Setting overview	Condition	Page
"MENU"	"Security Set"/ "Security Clear"	—		Sets/Resets security code.	SB	21
	"SRC Select"	"1"/"2"		Sets the source selection method.	SB	*5
	"Skip Search"	"0.5%"/" "1%"/"5%"/ "10%"		Sets the ratio of skip performed with <Music Search for iPod>.	iPod	12
	"Device Regist" ^{*1*2}	—		Register a Bluetooth device (pairing).	SB	32
	"SPCL DVC Select" ^{*1*2}	—		Allow registration of a special device that cannot be registered normally.	SB	32
	"Phone Selection" ^{*1*2}	—		Select a cell-phone subject to hands-free connection.	SB	33
	"Audio Selection" ^{*1*2}	—		Select the Bluetooth audio player to be connected.	—	33
	"Device Delete" ^{*1*2}	—		Cancel registration of the Bluetooth device.	SB	34
	"BT DVC Status" ^{*1*2}	—		Display the status of the Bluetooth device.	—	*5
	"PIN Code Edit" ^{*1*2}	—		Specify the PIN code required when registering this unit using the Bluetooth device.	SB	32
	"Auto Answer" ^{*1*2}	"OFF"/"05" "85" "99S"		Answer a call automatically after lapse of the preset time interval for automatic answer.	SB	*5
	"Mic Gain" ^{*1*2}	"-2"/"0"/" "+2"		Adjusts the sensitivity of the built-in microphone for a telephone call.	—	*5
	"NR Level" ^{*1*2}	"-2"/"0"/" "+2"		Reduces the noises generated by the surrounding environment without changing the microphone volume.	—	*5

Next page ►

Function Control

Category	Item	Setting	Entry	Setting overview	Condition	Page	
	"SP Select"*1*2	"Front"/ "F-R"/"F-L"		Specify the voice output speaker.	SB	*5	
	"Call Beep"*1*2	"ON"/"OFF"		Output a beep from the speaker when a call comes in.	SB	*5	
	"BT F/W Update"*1*2	—	1 sec.	Display the firmware version and update the firmware.	SB	34	
	"Beep"	"OFF"/"ON"		Setting the operation check sound (beep sound) ON/OFF.	SB	—	
	"Clock Adjust"	—	1 sec.	Sets the clock.	—	22	
	"Date Adjust"	—	1 sec.	Sets the date.	SB	22	
	"Date Mode"	7 types	1 sec.	Sets the date display mode.	SB	22	
	"DSI"	"OFF"/"ON"		DSI (Disabled System Indicator) of the unit blinks when the faceplate is removed.	SB	—	
	"Illumi DIM"	"OFF"/"Auto"/ /"MNAL1"/ /"MNAL2"		Sets whether the illumination is dimmed in conjunction with the light switch of the vehicle or it is dimmed constantly.	SB	*5	
	"ILM Effect"	"OFF"/"ON"		Sets whether the key illumination brightness is changed in conjunction with the key operation.	SB	—	
	"ILM MSC SYNC"	"OFF"/"ON"		Sets whether the key illumination color is changed in conjunction with the sound volume.	—	—	
	"Display"	"OFF"/"ON"		Turns off the display when no operation is performed.	—	*5	
	"DISP DIM"	"OFF"/"Auto"/ /"MNAL1"/ /"MNAL2"		Dims the display part in conjunction with the light switch of the vehicle.	SB	*5	
	Contrast	"1"- "10"		Adjusting the display contrast.	SB	—	
	DISP N/P	"POS1 1"/"2" /"NEGA 1"/"2"		Switches the panel display between positive or negative.	SB	*5	
	"AMP"	"OFF"/"ON"		Turns on/off the built-in amplifier.	SB	*5	
	"Zone2"	"Rear"/"Front"		Specifies the destination of AUX input sound when the Dual Zone function is turned on.	2ZONE	*5	
	"AMP Control"	—		Controls the connected LX amplifier.	—	22	
	"CRSC"	"OFF"/"ON"		Switches to Monaural to decrease noise when reception is poor.	FM	—	
	"Name Set"	—	1 sec.	Sets the display when switched to AUX source.	AUX	11	
	"Language"*2*4	"English"/ "Arabic"/ "Persian"/ "Thai"		Selects the language for using on the display.	SB	*5	
	"Chinese"*1*3	"OFF"/"ON"		Selects Chinese as the display language.	SB	*5	
	"Scroll"	"Auto"/ "Manual"		Specifies whether the text is scrolled automatically.	—	—	
	"Favorite Delete"	—	1 sec.	Deletes Favorite Preset Memory.	SB	30	
	"Built in AUX"	"OFF"/"ON"		Sets whether to display AUX during source selection.	SB	—	
	"CD Read"	"1"/"2"		Sets the CD read mode.	SB	*5	
	"DEMO Mode"	"OFF"/"ON"	2 sec.	Specifies whether to enable demonstration.	—	23	
"SETUP"	"Display Select"	"Type Select"	"DISP TYPE [A] - [D]"		Sets the display pattern.	—	10
		"Graphic Select"	"Graphic 1 - 2"		Sets the Type C spectrum analyzer display.	—	—
		"Side Select"	3 types		Sets the Type A side display.	—	—

Category	Item	Setting	Entry	Setting overview	Condition	Page
	"Text Select"	—		Sets the Type A/B/C text display.	—	10
	"Status"	Appear/ Disappear		Sets the Type A Status display.	—	—
	"Color Select"	"All"		Sets the panel and display illumination color.	Illumi	11
	"Display"	"Variable Scan"*/ "Color 1" – "Color 10" / "User"		Sets the display illumination color.	Illumi	
	"Right"			Sets the right side of panel illumination color.	Illumi	
	"Left"			Sets the left side of panel illumination color.	Illumi	
"SOUND"	"Control"	"EQ"		Sets the sound quality.	SB	27
	"Bass Boost"	"OFF"*/ "STEP1"/"2"		Sets the Bass Boost level in two steps.	SB	—
	"HIGHWAY-SOUND"	"OFF"/"STEP1" / "2"/"3"*		Compensates the low volume or bass sound being lost by road noises to make vocal sound clearer.	SB	*5
	"Supreme+"	"ON"*/"OFF"		Turns ON/OFF the Supreme plus function.	AF+ CD	*5
	"Position"	—		Compensates the sound environment in accordance with the listening position.	SB	28
"Setup"	"Cabin"	"Compact" etc.		Selects the car type to compensate the distance difference between each speaker.	SB	25
	"Speaker"	—		Sets the connected speaker, speaker size, and installation position.	SB	25
	"DTA"	—		Makes fine adjustment of the compensation value specified at Cabin.	SB	26
	"X'Over"	—		Makes fine adjustment of the X'Over value specified at Speaker.	SB	26
"Preset"	"Recall"	—		Registering the value setup by Sound Control. Recalling the sound setup registered by <Audio Preset Memory>.	SB	29
	"Memory"	—		Registering the value setup by Sound Control.	SB	29
	"DSP Set"	"Bypass" / "Through"*		Setting "BYPASS" passes the DSP function. Setting "THROUGH" activates the DSP function.	SB	—
"BT"	"Voice Recognize"	—		Calls by recognizing the registered voice.	Phone	18
	"Voice Tag"	"PB Name Edit"		Registers voice for voice recognition.		34
		"PN Type Edit"		Registers voice to select the Phone number category in Phonebook.		35
	"SMS"	"SMS Download"		Download a short message.	Phone	36
		"SMS Inbox"		Display the received short message.	Phone	36



- Strong electrical fields (such as from power lines) may cause unstable sound quality when CRSC is turned ON. In such a situation, turn it OFF.
- The connected cell-phone must have the SMS function to use the "SMS" function.

- Location played with "FILE SCAN"
 - Audio file: First 10 seconds
 - Music Editor media: First 10 seconds or the part picked by Intro Skip.
- During Intro Skip, turn the control knob left or right to change the song.
- The scan method depends on the Music Editor setting. See the Music Editor help for details.

Display Settings

Display Type Selection

Shown below are examples of display types.

Display	Display Type
"TYPE [A]"	Displays 4 to 5 lines of text.
"TYPE [B]"	Displays a line of text and video.
"TYPE [C]"	Displays a line of text and the spectrum analyzer.
"TYPE [D]"	Displays the clock.

1 Enter Display type selection mode

Select "SETUP" > "Display Select" > "Type Select".

For how to select Function Control item, refer to <Function Control> (page 6).

2 Select the Display type

Turn the Control knob.

3 Exit Display type selection mode

Press the [FNC] button.



- For how to switch the text display information, refer to <Text Display Selection> (Page 10).
- When "TYPE [A]" is selected, the status (ON/OFF indicator of each function) can be displayed on the first line, and the icon of the currently selected source and the text information title can be displayed on the left side by the following <Function Control> (page 6) operation.
Status display: Select "SETUP" > "Display Select" > "Status"
Side display: Select "SETUP" > "Display Select" > "Side Select"
- When "TYPE [C]" is selected, the spectrum analyzer can be switched by the following <Function Control> (page 6) operation.
: Select "SETUP" > "Display Select" > "Graphic Select"

Text Display Selection

Changes displayed information on each source following;

In Tuner source

Information	Display
Frequency	"Frequency"
Spectrum analyzer & Clock ("TYPE [A]/[B]") or Clock ("TYPE [C]")	"Speana/Clock" or "Clock"
Date	"Date"
Blank	"Blank"

In CD & External disc source

Information	Display
Disc title	"Disc title"
Track title	"Track title"
Play time	"P-Time"
Spectrum analyzer & Clock ("TYPE [A]/[B]") or Clock ("TYPE [C]")	"Speana/Clock" or "Clock"
Date	"Date"
Blank	"Blank"

In Audio file/ iPod source

Information	Display
Title & Artist name	"Title/Artist"
Album & Artist name	"Album/Artist"
Folder name	"Folder name"
File name	"File name"
Play time	"P-Time"
Play time bar (iPod only)*	"Time Bar"
Spectrum analyzer & Clock ("TYPE [A]/[B]") or Clock ("TYPE [C]")	"Speana/Clock" or "Clock"
Date	"Date"
Blank	"Blank"

* Can be displayed only on the bottom line of "TYPE [A]" text.

In Standby/ Auxiliary input source

Information	Display
Source name	"Source Name"
Clock	"Clock"
Date	"Date"
Blank	"Blank"

1 Enter Text display selection mode

Select "SETUP" > "Display Select" > "Text Select".

For how to select Function Control item, refer to <Function Control> (page 6).

2 Select the text display part

Push the Control knob towards up or down.

The selected text display part blinks.

3 Select the text

Turn the Control knob.

4 Exit Text display selection mode

Press the [FNC] button.



- If the selected display item does not have any information, alternative information is displayed.
- When LX-AMP is connected, the item setup by the Display mode of LX-AMP is displayed.
- Some items cannot be selected depending on the display type and row.
- When selecting "Folder name" while playing with iPod, names will be displayed depending on currently selected browsing items.
- If the iPod Control by Hand Mode is set to on while playing the iPod, "iPod by Hand Mode" is displayed.
- If all characters cannot be displayed while playing with iPod, the file number in the list is displayed.

Information	Display
Music title	"TITLE****"
Folder name	"FLD****"
File name	"FILE****"

Illumination Color Selection

Selecting the Illumination Color of the panel.

1 Enter Illumination color selection mode

Select "SETUP" > "Color Select".

For how to select Function Control item, refer to <Function Control> (page 6).

2 Select the place where you want to set the Illumination Color

Place	Display
All	"All"
Display	"Display"
Right	"Right"
Left	"Left"

Turn the Control knob and push the center when the desired item is displayed.

3 Select the Illumination Color

Turn the Control knob and push the center when the desired item is displayed.

Select the color from "Variable Scan"/"Color1" — "Color 10"/"User".

Creating "User" color

You can create your original color during the selection from "Color1" — "Color10".

The color you created can be called when you select "User".

1. Press the Control knob for at least 1 second.

Enter the detail color adjustment mode.

2. Set the color.

Operation type	Operation
To select the color to adjust. (red, green, or blue)	Push the Control knob towards right or left.
To adjust color. (Range: 0 – 9)	Turn the Control knob or push it towards up or down.

3. Press the Control knob.

Exit the detail color adjustment mode.

4 Exit Illumination color selection mode

Press the [FNC] button.

Auxiliary Input Display Setting

Selects the display when changing to Auxiliary input source.

1 Select the AUX source

Press the [SRC] button.

2 Enter Auxiliary input display setting mode

Select "MENU" > "Name Set".

For how to select Function Control item, refer to <Function Control> (page 6).

3 Enter Auxiliary input display setting mode

Press the Control knob for at least 1 second.

The presently selected Auxiliary input display is displayed.

4 Select the Auxiliary input display

Turn the Control knob.

"AUX"/"DVD"/"PORTABLE"/"GAME"/"VIDEO"/"TV"

5 Exit Auxiliary input display setting mode

Press the [FNC] button.



- When operation stops for 10 seconds, the name at that time is registered, and the Auxiliary input display setting mode closes.
- The Auxiliary input display can be set only when the built-in auxiliary input or the auxiliary input of optional KCA-S220A is used. On the KCA-S220A, "AUX EXT" is displayed by default.
- AUX source is initially set to "OFF". Before display setting, set "Built in AUX" described in <Function Control> (page 6) to "ON".
: Select "MENU" > "Built in AUX"

Music disc/Audio file Operation

Function of Audio file/ Internal CD source

Music Search

Selecting the music you want to listen to from the device or media being played now.

1 Enter Music Search mode

Press the [Q] button.

"SEARCH" is displayed.

Displays the current Audio file name.

2 Search for music

Audio file

Operation type	Operation
Movement between folders/files	Turn the Control knob or push it towards up or down.
Selection of folder/file	Press the Control knob or push it towards right.
Return to previous folder	Push the Control knob towards left.
Return to root folder	Push the Control knob towards left for at least 1 second.

"◀" or "▶" beside the displayed folder name indicates that this folder is preceded or followed by another folder.

File name is displayed with "♪" indicator.

Internal CD source

Operation type	Operation
Movement between track	Turn the Control knob or push it towards up or down.
Selection of track	Press the Control knob.
Return to first track	Push the Control knob towards left for at least 1 second.

Canceling the Music Search mode

Press the [Q] button.



- Music Search cannot be performed during Random play.

Function of iPod

Music Search for iPod

Search for the song (in iPod) you want to play.

1 Enter Music Search mode

Press the [Q] button.

2 Search for music

Operation type	Operation
Movement between items	Turn the Control knob.
Skip Search *1	Push the Control knob towards right or left.
Selection of item	Press the Control knob.
Return to previous item	Push the Control knob towards up.
Return to Top menu	Push the Control knob towards up for at least 1 second.
Search by initial	Push the Control knob towards down. Refer to the next section <Searching for Music by Initial>.

Scroll bar is displayed on the right side of the screen.

Canceling the Music Search mode

Press the [Q] button.



- *1 Skip Search: The number of songs to be skipped is determined by the ratio of the total number of songs in the list which is selected now. Set the ratio with "Skip Search" in <Function Control> (page 6). Keep pushing Control knob for 3 seconds or longer skips songs at 10% irrespective of the setting.
- Characters that are included in a song name but cannot be displayed are left blank. If no character included in a song name cannot be displayed, the browse item name and digits are displayed.

Items	Display	Items	Display
Playlists	"PLIST****"	Podcasts	"PDCT****"
Artists	"ART****"	Genres	"GEN****"
Albums	"ALB****"	Composers	"COM****"
Songs	"PRGM****"		

Function of iPod

Searching for Music by Initial

You can select an alphabetic character from the list in the browse item (artist, album, etc.) selected now.

1 Enter Music Search mode

Press the [Q] button.

2 Start the alphabet search

Press the Control knob towards down.

"A B C ..." is displayed.

- If you can not search for a song by an alphabetic character in the browse item selected now, the data on the screen does not change.

3 Select the initial to be searched for

Operation type	Operation
Move to the next character.	Turn the Control knob or push it towards right or left.
Move to the next row.	Push the Control knob towards up or down.

4 Determine the selected initial

Press the Control knob.

Start search. When search is completed, the music search mode is selected again at the selected character position.

Canceling the alphabet search

Press the [Q] button.



- The time of search by alphabet may become long depending on the number of songs in iPod or the folder structure.
- When selecting an initial in the alphabet search, entering "*" searches symbols and entering "1" searches digits.
- If the first character string begins with an article "a", "an", or "the" in the alphabet search mode, it is searched for in defiance of the article.

Function of iPod

All Random

All songs in iPod are played at random.

Enter All random mode

Select "ALL RANDOM".

For how to select Function Control items, refer to <Function Control> (page 6).



- The time required to turn on the all random function may become longer depending on the number of songs in iPod or the folder structure.
- Turning on the all random function changes the iPod browse item to "Songs". This browse item will not change even if the all random function is turned off.

Function of iPod

iPod Control by Hand Mode

Allows you to operate iPod with the control on the iPod.

Enter iPod Control by Hand Mode

Select "iPod BY HAND".

For how to select Function Control items, refer to <Function Control> (page 6).



- iPod will be paused when Hand mode is turned ON during playback.
- In the iPod Control by hand mode, iPod cannot be operated using this unit.
- This mode is not compatible with music information display. The display will show "iPod by Hand Mode".
- iPod can be operated when it conforms to the iPod control function.

Function of remote control

Direct Music Search

Searches the music by entering the track number.

1 Enter the music number

Press the number buttons on the remote control.

2 Search the music

Press the [◀◀] or [▶▶] button.

Canceling Direct Music Search

Press the [▶II] button.



- Direct Music Search cannot be performed during playing of iPod, "Music Editor" media, Random play, or scan play.

Music disc/Audio file Operation

Function of disc changers with remote control

Direct Disc Search

Searchs the disc by entering the disc number.

1 Enter the disc number

Press the number buttons on the remote control.

2 Search the disc

Press the [FM+] or [AM-] button.

Canceling Direct Disc Search

Press the [▶ II] button.



- Direct Disc Search cannot be performed during playing of Random play or scan play.
- Input "0" to select disc 10.

Basic Operation of Disc Changer (Optional)

Selecting CD changer source

Press the [SRC] button.

Select the "CD CHANGER" display.

Music search

Push the Control knob towards right or left.

Disc Search

Push the Control knob towards up or down.

Tuner Operation

Auto Memory Entry

Putting stations with good reception in the memory automatically.

1 Enter Auto Memory Entry mode

Select "AUTO MEMORY".

For how to select Function Control items, refer to <Function Control> (page 6).

2 Open Auto Memory Entry

Turn the Control knob to select "YES", and then press the Control knob.

When 6 stations that can be received are put in the memory, auto memory entry closes.

Station Preset Memory

Putting a station in the memory.

1 Select the frequency to put in the memory

Push the Control knob towards right or left.

2 Enter Preset Memory mode

Press the [Q] button.

3 Select the number to put in the memory

Turn the Control knob.

4 Determine the number to put in the memory

Press the Control knob for at least 2 seconds.

Canceling the Preset Memory mode

Press the [Q] button.

Preset Tuning

Recalling the stations in the memory.

1 Enter Preset Tuning Select mode

Press the [Q] button.

2 Select a desired station in the memory

Turn the Control knob.

3 Recall the station

Press the Control knob.

Canceling Preset Tuning

Press the [Q] button.

Function of remote control

Direct Access Tuning

Entering the frequency and tuning.

1 Enter Direct Access Tuning mode

Press the [DIRECT] button on the remote control.

"- - - -" is displayed.

2 Enter the frequency

Press the number buttons on the remote control.

Example:

Desired frequency	Press button
92.1 MHz (FM)	[0], [9], [2], [1]
810 kHz (AM)	[0], [8], [1], [0]

Canceling Direct Access Tuning

Press the [DIRECT] button on the remote control.



- You can enter the FM band frequency in steps of a minimum of 0.1 MHz.

Frequency Step Setting

Changing the tuning frequency step.

The original setting is FM band 50 kHz, and AM band 9 kHz.

1 Turn the power OFF

Press the [SRC] button for at least 1 second.

2 Switch the frequency step

While pressing the [AUD] knob and Control knob, press the [SRC] button.

Release your fingers from the button after the display appears.

The frequency step changes to FM band 200 kHz, and AM band 10 kHz.



- When the same operation is repeated, the frequency step returns to the original setting.
- When the frequency step is changed, the frequencies in the memory are deleted.

Operation of hands-free phoning

Before Use

- For details on the Bluetooth cell-phone with the hands-free function, see <About the Cell-Phone> (Page 41).
- You need to register your cell-phone before using it with this unit. For more details, see <Registering Bluetooth device> (Page 32).
- If you have registered two or more cell-phones, you need to select one of them. For more details, see <Selecting the Bluetooth device You Wish to Connect> (Page 33).
- To use the Phone Book, it must be downloaded to this unit in advance. For more details, see <Downloading the Phone Book> (Page 33).
- "BT" indicator is lit when a cell-phone is connected to this unit.

Receiving a call

Answering a Phone Call

Press the [AUD] button.



- The following operations disconnect the line:
 - Insert a CD.
 - Connect a USB device.
- The name of the calling party is displayed if it has already been registered in the Phone Book.

Rejecting an Incoming Call

Press the [SRC] button or press the [REJECT] button for at least 1 second.

During a call

Disconnecting a Call

Press the [SRC] button or press the [REJECT] button for at least 1 second.

Switching to the Private Mode

Press the Control knob.

Switches between Private talk ("PRIVATE") and Hands-free talk each time this button is pressed.



- Depending on the type of your cell-phone, switching to the private talk mode may select the source that was used before commencing the hands-free connection. If this happens, the source cannot be switched back to the hands-free talk mode by operating this unit. Operate

your cell-phone to return to the hands-free talk mode.

Adjusting the Voice Volume during a Call

Turn the [AUD] knob.

Call waiting

Answering Another Incoming Call with the Current Call Suspended

- 1 Press the [AUD] button.
- 2 Turn the Control knob or push it towards up or down. Select the "ANSWER" display.
- 3 Press the [AUD] button.

Answering another Incoming Call after Terminating the Current Call

Press the [SRC] button or press the [REJECT] button for at least 1 second.

Continuing the Current Call

- 1 Press the [AUD] button.
- 2 Turn the Control knob or push it towards up or down. Select the "REJECT" display.
- 3 Press the [AUD] button.

Answering the Waiting Call after Terminating the Current Call

Press the [SRC] button or press the [REJECT] button for at least 1 second.

Switching between the Current Call and Waiting Call

Press the [AUD] button.

Each pressing of this knob switches the calling party.

Other functions

Clearing the Disconnection Message

KDC-XBT8013U/ KDC-XBT8013UL:

Press the [REJECT] button.

KDC-X7013U/ KDC-X7013UL:

Press the [REJECT] button for at least 1 second.

"HF Disconnect" disappears.

Making a call

1 Enter dialing method mode

KDC-XBT8013U/ KDC-XBT8013UL:

Press the  button.

KDC-X7013U/ KDC-X7013UL:

Press the  button for at least 1 second.

2 Select a dialing method

Press the Control knob.

"DIAL" » "INITIAL" » "PHONE BOOK" » "OUT-CALL" »
"IN-CALL" » "MISSED CALLS"

Methods of operations in the above modes are described below.

3 Exit the dialing method mode

Press the  button.

Dial a number

1 Enter dialing method mode

KDC-XBT8013U/ KDC-XBT8013UL:

Press the  button.

KDC-X7013U/ KDC-X7013UL:

Press the  button for at least 1 second.

2 Select the number dial mode

Press the Control knob.

Select the "DIAL" display.

3 Enter a phone number

Press the number ([1] – [0]), #[FM], *([AM]), or
+([▶▶]) button on the remote controller.

4 Make a call

Press the [DIRECT] button on the remote controller.

To erase the entered phone number digit by digit:

Press the [<] button on the remote controller.



- You can input max 32 digits.

Speed dialing (Preset dial)

1 Enter dialing method mode

KDC-XBT8013U/ KDC-XBT8013UL:

Press the  button.

KDC-X7013U/ KDC-X7013UL:

Press the  button for at least 1 second.

2 Press the Control knob.

Select the "DIAL," "PHONE BOOK," "OUT-CALL,"
"IN-CALL," or "MISSED CALLS" display.

3 Enter preset dial mode

Press the [Q] button.

4 Select the number you want to recall from the memory

Turn the Control knob or push it towards up or down.

5 Press the Control knob.

Phone number is displayed.

6 Exit preset dial mode

Press the [Q] button.

7 Make a call

Press the Control knob for at least 1 second.



- You need to register the preset dial number. (Page 19)

Operation of hands-free phoning

Calling a number in the Phone Book

1 Enter dialing method mode

KDC-XBT8013U/ KDC-XBT8013UL:

Press the  button.

KDC-X7013U/ KDC-X7013UL:

Press the  button for at least 1 second.

2 Select the Phone Book mode

Press the Control knob.

Select the "INITIAL" display, proceed to step 3.

Select the "PHONE BOOK" display, proceed to step 4.

3 Select the initial to be searched for

Operation type	Operation
Move to the next character.	Turn the Control knob or push it towards right or left.
Move to the next row.	Push the Control knob towards up or down.
Determine the selected initial.	Press the Control knob.

4 Select the name

Operation type	Operation
Move to the next phone number.	Turn the Control knob or push it towards up or down.
Move to the next name.	Push the Control knob towards right or left.

Switching between Display Modes

Press the [FNC] button.

Pressing this button each time switches between name and telephone number.

5 Make a call

Press the Control knob for at least 1 second.



- During search, a non-accent character such as "u" is searched for instead of an accent character such as "ü".

Calling a number in the call log

1 Enter dialing method mode

Press the  button.

2 Select the call log mode

Press the Control knob.

Select the "OUT-CALL" (outgoing call), "IN-CALL" (incoming call), or "MISSED CALLS" (missed call) display.

3 Select a name or phone number

Turn the Control knob or push it towards up or down.

Switching between Display Modes

Press the [FNC] button.

Pressing this button each time switches between name and telephone number.

4 Make a call

Press the Control knob for at least 1 second.



- The outgoing call list and the incoming call list, and the missed call list are the lists of calls originated from and received at this unit. They are not the ones stored in the cell-phone memory.

Make a voice dialing call

1 Enter voice recognize mode

Select "BT" > "Voice Recognize".

For how to select Function Control item, refer to <Function Control> (page 6).

"Ready" is displayed.

2 Press the Control knob.

"PB Name?" is displayed.

When a beep is heard, utter the name within 2 second.

3 "PN Type" is displayed.

When a beep is heard, utter the category within 2 second.

4 Make a call

Press the Control knob for at least 1 second.

- This step is the same as step 3 of the procedure in <Calling a number in the Phone Book>. You can make a call or select a category.



- If your voice cannot be recognized, a message is displayed. Pressing the Control knob allows you to retry voice input. (Page 48)
- Both the name and category requires registration of a voice tag. (Page 34)
- Audio sound is not output during voice recognize.

Registering to the Preset Dial Number List

1 Enter the phone number you wish to register

Enter the phone number with reference to the following:

Dial a number/ Calling a number in the call log/
Calling a number in the Phone Book

2 Enter Preset Memory mode

Press the [Q] button.

3 Select the number to put in the memory

Turn the Control knob or push it towards up or down.

4 Determine the number to put in the memory





Press the Control knob for at least 1 second.

Exit the Preset Memory mode

Press the [Q] button.

Display of phone number type (category)

The category items in the Phone Book are displayed as follows:

Display	Information
"GENERAL" / 	General
"HOME" / 	Home
"OFFICE" / 	Office
"MOBILE" / 	Mobile
"OTHER" / 	Other

Bluetooth Audio Operation

Before Use

- For details on the Bluetooth Audio player which can be connected, see <About the Bluetooth Audio player> (Page 41).
- You need to register your Bluetooth Audio player before using it with this unit. For more details, see <Registering Bluetooth device> (Page 32).
- You to select the Bluetooth audio player you wish to connect. Refer to <Selecting the Bluetooth device You Wish to Connect> (Page 33).

Basic Operation

Selecting Bluetooth Audio source

Press the [SRC] button.

Select the "BT Audio" display.

For how to select source item, refer to <Power/Source Select button> of <Basic Operation> (page 4).

Pause and play

Press the Control knob.

Music Search

Push the Control knob towards right or left.



- All or some of the operations above cannot be performed if the Bluetooth audio player is not ready for remote control.
- Switching between Bluetooth audio sources does not start or stop playback automatically. Perform the operation for starting or stopping playback.
- Some audio players cannot be controlled remotely or reconnected after Bluetooth disconnection. Operate the main unit of the audio player to connect Bluetooth.

Other Functions

Activating Security Code



- You can set the Security Code with a 4 digit number of your choice.
- The Security Code cannot be displayed or referenced. Make a note of the Security Code and treasure it up.

1 Select Security code mode Select "MENU" > "Security Set".

For how to select Function Control item, refer to <Function Control> (page 6).

2 Enter Security Code mode Press the Control knob for at least 1 second. When "Enter" is displayed, "[-][-][-]" is also displayed.

3 Enter Security Code

Operation type	Operation
Select the digits to enter	Push the Control knob towards right or left.
Select the Security Code numbers	Turn the Control knob or push it towards up or down.

4 Confirm the Security Code Press the Control knob for at least 3 seconds. When "Re-Enter" is displayed, "[-][-][-]" is also displayed.

5 Do the step 3 through 4 operation, and reenter the Security Code. "Approved" is displayed. The Security Code function activates.



- If you enter the wrong Code in steps 3 through 4, repeat from step 3.

6 Exit Security Code mode Press the [FNC] button.

Entering Security Code

The Security Code is required to use the audio unit when the unit is first used after removed from the battery power source or the Reset button is pressed.

- 1 Turn the power ON.
- 2 Do the step 3 through 4 operation, and enter the Security Code.
"Approved" is displayed.
Now, you can use the unit.

Deactivating Security Code

To deactivate the Security Code function.

- 1 **Select Security code mode**
Select "MENU" > "Security Clear".
For how to select Function Control items, refer to <Function Control> (page 6).
- 2 **Enter Security Code mode**
Press the Control knob for at least 1 second.
When "Enter" is displayed, "[-][-][-]" is also displayed.

3 Enter Security Code

Operation type	Operation
Select the digits to enter	Push the Control knob towards right or left.
Select the Security Code numbers	Turn the Control knob or push it towards up or down.

4 Press the Control knob for at least 3 seconds. "Clear" is displayed. The Security Code function deactivates.

5 Exit Security Code mode Press the [FNC] button.

Other Functions

Manual Clock Adjustment

1 Select Clock adjustment mode

Select "MENU" > "Clock Adjust".

For how to select Function Control items, refer to <Function Control> (page 6).

2 Enter Clock adjustment mode

Press the Control knob for at least 1 second.

The clock display blinks.

3 Adjusting Clock

Operation type	Operation
Selecting the item (hours or minutes)	Push the Control knob towards right or left.
Adjust each item	Turn the Control knob or push it towards up or down.

4 Exit Clock adjustment mode

Press the [FNC] button.

Date Adjustment

1 Select Date adjustment mode

Select "MENU" > "Date Adjust".

For how to select Function Control items, refer to <Function Control> (page 6).

2 Enter Date adjustment mode

Press the Control knob for at least 1 second.

The date display blinks.

3 Adjusting Date

Operation type	Operation
Selecting the item (month, day, or year)	Push the Control knob towards right or left.
Adjust each item	Turn the Control knob or push it towards up or down.

4 Exit Date adjustment mode

Press the [FNC] button.

Date Format Selection

1 Select Date format mode

Select "MENU" > "Date Mode".

For how to select Function Control items, refer to <Function Control> (page 6).

2 Enter Date format mode

Press the Control knob for at least 1 second.

The date is displayed.

3 Adjusting Date

Turn the Control knob.

Select from 7 types.

4 Exit Date format mode

Press the [FNC] button.

When LX AMP unit connecting

AMP Control

You can control the LX AMP connected to the unit.

1 Select AMP Control mode

Select "MENU" > "AMP Control".

For how to select Function Control items, refer to <Function Control> (page 6).

2 Enter AMP Control mode

Press the Control knob for at least 1 second.

3 Select the AMP Control item for adjustment

Turn the Control knob or push it towards up or down.



- For the details on the AMP Control item, see the Instruction manual attached to the LX AMP.

4 Adjust the AMP Control item

Push the Control knob towards right or left.

5 Exit AMP Control mode

Press the [FNC] button.

Demonstration mode setting

Turning the demonstration mode ON/OFF.

1 Select Demonstration mode

Select "MENU" > "DEMO Mode".

For how to select Function Control items, refer to <Function Control> (page 6).

2 Set the Demonstration mode

Press the Control knob for at least 2 seconds.

Pressing this button for 2 seconds or longer toggles the setting between "ON" and "OFF".

3 Exit Demonstration mode

Press the [FNC] button.

Theft Deterrent Faceplate

The faceplate of the unit can be detached and taken with you, helping to deter theft.

Removing the Faceplate

1 Press the Release button.

Drop open the faceplate.

2 Drawing the faceplate to left side pull it forward and remove it.

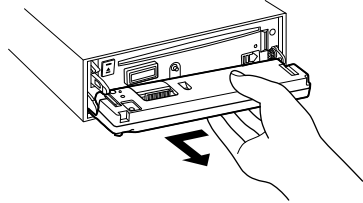

- The faceplate is a precision piece of equipment and can be damaged by shocks or jolts.
- Keep the faceplate in its faceplate case while detached.
- Do not expose the faceplate (and the faceplate case) to direct sunlight or excessive heat or humidity. Also avoid places with too much dust or the possibility of water splashing.

Reattaching the Faceplate

1 Align the shaft on the unit with the depression on the faceplate.

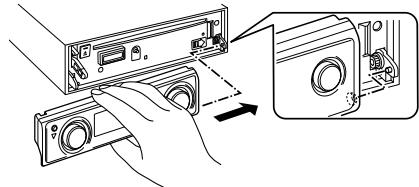

2 Push the faceplate in until it clicks.

The faceplate is locked in place, allowing you to use the unit.

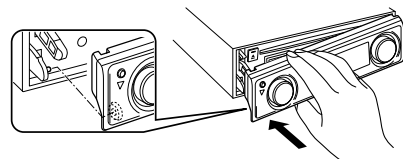

Audio Adjustments

Audio Control

You can adjust following Audio Control items;

Adjustment Item	Display	Range
Rear volume	"REAR VOLUME"	0 — 35
Subwoofer level	"SUBWOOFER LEVEL"	-15 — +15
Balance	"BALANCE"	Left 15 — Right 15
Fader	"FADER"	Rear 15 — Front 15

Exit Audio Control mode (Volume control mode)

1 Enter Audio Control mode

Press the [AUD] knob.

2 Select the Audio item to adjust

Press the [AUD] knob.

3 Adjust the Audio item

Turn the [AUD] knob.

4 Exit Audio Control mode

Press any button.



Press a button other than the [AUD] knob or  button.

Audio Setup

You can set Sound system , such as follows;

Adjustment Item	Display	Range
Volume offset	"VOL-OFFSET"	-8 — ±0 (AUX: -8 — +8)
Dual Zone System	"2 ZONE"	OFF/ON



- Volume offset: Sets each source's volume as a difference from the basic volume.
- Dual Zone System
Main source and sub source (Auxiliary input) output Front channel and Rear channel separately.
 - Set up the channel of sub source by "Zone2" of <Function Control> (page 6).
 - Select Main source by [SRC] button.
 - Adjust the volume of Front channel by [AUD] knob.
 - Adjust the volume of Rear channel by <Audio Control> (Page 24) or / button on the remote control (Page 38).
 - The Audio Control has no effect on sub source.

1 Select the source to adjust

Press the [SRC] button.

2 Enter Audio Setup mode

Press the [AUD] knob for at least 1 second.

3 Select the Audio Setup item to adjust

Press the [AUD] knob.

4 Adjust the Audio setup item

Turn the [AUD] knob.

5 Exit Audio Setup mode

Press the [AUD] knob for at least 1 second.

Sound Setup

Cabin selection

You can compensate the delay of the sound arrival time by selecting your environment from the following car types;

Car type	Display
Not compensating.	"OFF"
Compact car	"Compact"
Full size car	"Full Size Car"
Station wagon	"Wagon"
Minivan	"Minivan"
Sport-utility vehicle	"SUV"
Long Minivan	"Minivan (Long)"

1 Enter Cabin select mode

Select **"SOUND" > "Setup" > "Cabin"**.

For how to select Function Control item, refer to <Function Control> (page 6).

2 Select the car type

Turn the Control knob and push the center when the desired item is displayed.

Exit Cabin select mode.



- You can compensate the distances in more details by using <DTA> (page 26) function.

Speaker setting

The speaker X'Over is automatically set when the position and size of each speaker are selected from the following items;

Item	Range
Speaker Size Front	"0.E.M.", "10cm", "13cm", "16cm", "17cm", "18cm", "4x8", "5x7", "6x8", "6x9", "7x10"
Speaker Location Front	"Door", "On Dash", "Under Dash"
Speaker Size Tweeter	"None", "Use"
Speaker Size Rear	"None", "0.E.M.", "10cm", "13cm", "16cm", "17cm", "18cm", "4x6", "5x7", "6x8", "6x9", "7x10"
Speaker Location Rear	"Door", "Rear Deck" "Minivan", "Minivan (Long)": "2nd Row", "3rd Row"
Speaker Size Subwoofer	"None", "16cm", "20cm", "25cm", "30cm", "38cm Over"

1 Enter Speaker setting mode

Select **"SOUND" > "Setup" > "Speaker"**.

For how to select Function Control item, refer to <Function Control> (page 6).

2 Select the speaker you want to set

Setting speaker	Display
Front speaker	"FRONT"
Rear speaker	"REAR"
Subwoofer	"SUB W"

Turn the Control knob.

3 Select the item you want to set

Item	Setting overview
"FRONT"	>"SIZE" Speaker Size Front
	>"LOCATION" Speaker Location Front
	>"TWEETER" Speaker Select Tweeter
"REAR"	>"SIZE" Speaker Size Rear
	>"LOCATION" Speaker Location Rear
"SUB W"	>"SIZE" Speaker Size Subwoofer

Push the Control knob towards up or down.

4 Set the value

Turn the Control knob.

5 Repeat steps 2 to 4 to complete the speaker settings.

6 Exit Speaker setting mode

Press the [FNC] button.

Sound Setup

DTA (Digital Time Alignment) setting

Adjusting fine tuning of the speaker position compensation value specified at <Cabin selection> (Page 25).

1 Enter DTA setting mode

Select "SOUND" > "Setup" > "DTA".

For how to select Function Control item, refer to <Function Control> (page 6).

2 Select the speaker you want to set

Setting speaker	Display
Front speaker	"Front"
Rear speaker	"Rear"
Subwoofer	"SW"

Turn the Control knob.

3 Set the compensation value of the speaker position

Turn the Control knob and push the center when the desired value is displayed.

Adjust between 0 and 440 cm.

Refer to "DTA" of <Menu Glossary> (Page 42) on how to set the compensation value.

Exit DTA setting mode.

X'Over setting

Fine adjusting the following setting values corresponding to the X'Over values set in the section <Speaker Setting> (Page 25);

Adjustment Item	Display	Range
Front High Pass Filter, Rear High Pass Filter	"FC"	Through, 30, 40, 50, 60, 70, 80, 90, 100, 120, 150, 180, 220, 250 (Hz)
Front High Pass Slope, Rear High Pass Slope, Subwoofer Slope	"SLOPE"	-6, -12, -18, -24 dB/Oct
Subwoofer Low Pass Filter	"FC"	30, 40, 50, 60, 70, 80, 90, 100, 120, 150, 180, 220, 250, Through (Hz)
Subwoofer Phase	"PHASE"	Reverse (180°)/ Normal (0°)

1 Enter X'Over setting mode

Select "SOUND" > "Setup" > "X'Over".

For how to select Function Control item, refer to <Function Control> (page 6).

2 Select the speaker you want to set

Setting speaker	Display
Front speaker	"Front"
Rear speaker	"Rear"
Subwoofer	"Subwoofer"

Turn the Control knob and push the center when the desired item is displayed.

3 Select the item you want to set

Item	Setting overview
"Front"	>"FC" Front High Pass Filter >"SLOPE" Front High Pass Slope
"Rear"	>"FC" Rear High Pass Filter >"SLOPE" Rear High Pass Slope
"Subwoofer"	>"FC" Subwoofer Low Pass Filter >"SLOPE" Subwoofer Slope >"PHASE" Subwoofer Phase

Push the Control knob towards up or down.

4 Set the X'Over value

Turn the Control knob.

5 Repeat steps 2 to 4 to complete the X'Over setting.

6 Exit X'Over setting mode

Press the [FNC] button.

Preset Equalizer curve select

You can select following Equalizer curve;

Equalizer curve	Display
Natural	"Natural"
User*	"User"
Rock	"Rock"
Pops	"Pops"
Easy	"Easy"
Top 40	"Top 40"
Jazz	"Jazz"
Game	"Game"
iPod (During iPod source only)	"iPod"

* The Equalizer curve set in the section <Manual Equalizer Control> is recalled.

1 Enter Preset Equalizer mode

Select **"SOUND" > "Control" > "EQ" > "Preset Equalizer"**.

For how to select Function Control item, refer to <Function Control> (page 6).

2 Select the Equalizer curve

Turn the Control knob and push the center when the desired item is displayed.

You can select from 22 Equalizer curve types for iPod when "iPod" is selected.

Exit Preset Equalizer mode.

Select the iPod Equalizer curve

1. Enter iPod Equalizer mode

Press the Control button.

2. Select the iPod Equalizer curve

Turn the Control knob and push the center when the desired item is displayed.

Exit Preset Equalizer mode.



- You can select for each source.

Manual Equalizer Control

You can adjust following Equalizer Control items;

Adjustment Item	Display	Range
Band 1	"BAND1"	62.5 Hz
Band 2	"BAND2"	250 Hz
Band 3	"BAND3"	1 kHz
Band 4	"BAND4"	4 kHz
Band 5	"BAND5"	16 kHz
Band level	"GAIN"	-9 —+9 dB
Bass Effect*	"EFFECT"	"ON"/"OFF"

*Can be only set for "BAND1".

1 Enter Manual Equalizer Control mode

Select **"SOUND" > "Control" > "EQ" > "Manual Equalizer"**.

For how to select Function Control item, refer to <Function Control> (page 6).

2 Select the band you want to set

Turn the Control knob.

3 Select the item you want to set

Push the Control knob towards up or down.

Move the cursor ">" to the desired item.

4 Set the value

Turn the Control knob.

5 Repeat steps 2 to 4 to complete the Equalizer curve.

To change the band, move the cursor ">" to "band#".

6 Exit Manual Equalizer Control mode

Press the [FNC] button.



- When "iPod" is selected in the section <Preset Equalizer curve select> (Page 27), Manual Equalizer Control is disabled.
- You can select for each source.

Sound Setup

Preset position selection

According to the listening position, select the position from the following settings so that the normal position of the sound environment can be compensated in accordance with the selected position;

Compensation seat	Range
Not compensating.	"ALL"
Front-Left seat	"Front-Left"
Front-Right seat	"Front-Right"
Front seat	"Front"

1 Enter Preset position setting mode

Select "SOUND" > "Control" > "Position" > "Preset Position".

For how to select Function Control item, refer to <Function Control> (page 6).

2 Select the seat you want to compensate

Turn the Control knob.

3 Exit Preset position setting mode

Press the [FNC] button.

Manual position setting

Making fine adjustment of the value specified at Preset position selection per speaker.

1 Enter Manual position setting mode

Select "SOUND" > "Control" > "Position" > "Manual Position".

For how to select Function Control item, refer to <Function Control> (page 6).

2 Select the speaker you want to set

Item	Setting overview
"FRONT" / "L"	Front Left speaker
"FRONT" / "R"	Front Right speaker
"REAR" / "L"	Rear Left speaker
"REAR" / "R"	Rear Right speaker
"SUBWOOFER" / "L"	Subwoofer Left
"SUBWOOFER" / "R"	Subwoofer Right
"INITIAL"	Initialize the setting values.

Push the Control knob towards up or down.

3 Set the value

Turn the Control knob.

Adjust between 0 and 170 cm.

Press the Control knob for at least 1 second if you want to execute the "INITIAL".

4 Exit Manual position setting mode

Press the [FNC] button.

Audio Preset Memory

Registering the value setup by Sound Control.

1 Setup Sound Control

Refer to the following operations to setup the Sound Control.

- Cabin selection (Page 25)
- Speaker Setting (Page 25)
- DTA (Digital Time Alignment) setting (Page 26)
- X'Over setting (Page 26)
- Manual Equalizer Control (Page 27)
- Preset position selection (Page 28)
- Manual position setting (Page 28)

2 Enter Audio preset memory mode

Select "SOUND" > "Preset" > "Memory".

For how to select Function Control items, refer to <Function Control> (page 6).

3 Select the number to put in the memory

Turn the Control knob and push the center when the desired number is displayed.

4 Turn the Control knob to select "YES", and then press the Control knob.

"Memory Completed" is displayed.

5 Exit Audio preset memory mode

Press the [FNC] button.



- Register 6 pairs of Audio Preset Memory.
- Number "1": When you press the Reset, all the sources will be the setting value which is registered.
- Number "1" and "2":
The memory cannot be erased by the Reset button.
- This function cannot be registered when the iPod Equalizer set in <Preset Equalizer curve select> (Page 27).

Audio Preset Recall

Recalling the sound setup registered by <Audio Preset Memory> (Page 29).

1 Select the source

Press the [SRC] button.

2 Enter Audio preset recall mode

Select "SOUND" > "Preset" > "Recall".

For how to select Function Control items, refer to <Function Control> (page 6).

3 Select the number to recall in the memory

Turn the Control knob and push the center when the desired number is displayed.

4 Turn the Control knob to select "YES", and then press the Control knob.

"Recall Completed" is displayed.

5 Exit Audio preset recall mode

Press the [FNC] button.



- The "User" of <Preset Equalizer curve select> (Page 27) is changed to the value which was recalled.
- The Equalizer curve is changed to the value which was recalled by the selected source.

Favorite Control

Favorite Preset Memory

Registering the operation procedure to select your favorite broadcast station or iPod Playlists/ Artists, etc.

1 Display a favorite item

Source	Registerable items
TUNER	Preset Memory
iPod	List selection screen for Playlists/ Artists/ Albums, etc.
Hands-free phone	Telephone number retrieval.

"FAV" is displayed when the operation procedure can be registered.

iPod setting

The desired list in the first hierarchy can be registered.

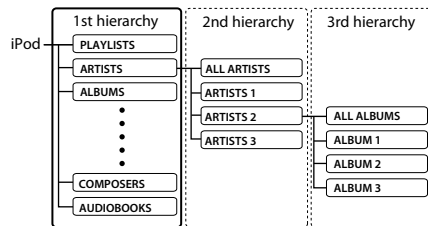

2 Enter Favorite Preset Memory mode

Press the [Q] button for at least 1 second.

3 Select the number to put in the memory

Turn the Control knob.

4 Put the Favorite Preset in the memory

Press the Control knob.

Canceling the Favorite Preset Memory mode

Press the [Q] button.



- Registering the operation procedure to an existing preset number overwrites the existing procedure.
- Register 6 pairs of Favorite Preset Memory. The memory cannot be erased by the Reset button.
- The same memory storage operation can be used for "MENU", "SETUP", and "SOUND" in the section <Function Control> (page 6). However, some currently selected sources cannot be recalled. For information on available sources, refer to Condition column in the section <Function Control>.
- If the items in the second or lower hierarchy are changed, the list in iPod will be changed by adding or deleting songs after the FAVORITE registration. Due to this, the list registered in this unit will be different from the list in iPod. The FAVORITE registration should be performed again after editing the items in iPod.

Favorite Preset Recall

Retrieving an item registered to Favorite.

1 Enter Favorite Preset Recall mode

Turn the Control knob.

2 Select the number to recall in the Favorite memory

Turn the Control knob.

3 Recall the Favorite Preset

Press the Control knob.

Canceling the Favorite Preset Recall mode

Turn the Control knob to select "Return", and then press the Control knob.



- When iPod is selected for the source, the list selection screen for Playlists/ Artists/ Albums, etc. is displayed. Songs will not be automatically played.

Favorite Preset Memory Delete

Deleting an item registered to Favorite.

1 Enter Favorite Preset Memory Delete mode

Select "MENU" > "Favorite Delete".

For how to select Function Control item, refer to <Function Control> (page 6).

2 Enter Favorite Preset Memory Delete mode

Press the Control knob for at least 1 second.

3 Select the number you want to delete

Turn the Control knob and push the center when the desired number is displayed.

"Delete?" is displayed.

Select "ALL" if you want to delete all.

4 Turn the Control knob to select "YES", and then press the Control knob.

"Completed" is displayed.

Exit Favorite Preset Memory Delete mode.

Favorite Name Setting

Giving a name to Preset Memory registered to Favorite.

1 Enter Preset Recall mode

Turn the Control knob.

2 Retrieve the Preset Memory to change

Turn the Control knob.

3 Enter Favorite Name set mode

Press the Control knob for at least 1 second.

Select the "FAVORITE NAME SET" display.

4 Enter the name

Operation type	Operation
Move the cursor to the enter character position	Push the Control knob towards right or left.
Select the character type*	Press the Control knob.
Select the characters	Turn the Control knob or push it towards up or down.

* Each time you press the knob, the character type alternates between the types shown in the table below.

Character type	
	Alphabet upper case
	Alphabet lower case
	Numbers and symbols

5 Exit Favorite Name Set mode

Push the Control knob towards right or left to select "ENTER", and then press the Control knob.

Canceling the Favorite Name set

Press the [FNC] button.

Bluetooth Setup

Registering Bluetooth device

To make your Bluetooth device (cell-phone) usable with this unit, you need to register it (pairing). You can register up to five Bluetooth devices to this unit.

When registering from Bluetooth devices

1 Turn on the control unit.

2 Start registering a unit by operating the Bluetooth device

By operating the Bluetooth device, register the hands-free unit (pairing). Select "KENWOOD BT CD/R-2P2"/"KENWOOD BT200" from the list of connected units.

3 Enter a PIN code

Input the PIN code registered as mentioned in <Registering PIN Code> (Page 32).

Check that registration is complete on the Bluetooth device.

4 By operating the Bluetooth device, start hands-free connection.

When registering from this unit

1 Select Bluetooth device registration mode Select "MENU" > "Device Regist".

For how to select Function Control item, refer to <Function Control> (page 6).

2 Enter Bluetooth device registration mode Press the Control knob for at least 1 second.

Search for the Bluetooth device.

When search is completed, "Finished" is displayed.

3 Select the Bluetooth device

Turn the Control knob and push the center when the desired Bluetooth device is displayed.

4 Input the PIN code

Operation type	Operation
Select the numbers.	Turn the Control knob or push it towards up or down.
Move to the next digit.	Push the Control knob towards right.
Delete the last digit.	Push the Control knob towards left.

5 Transmit the PIN code

Press the Control knob for at least 1 second.

If "Pairing Success" is displayed, registration is completed.

6 Return to the device list

Press the Control knob.

7 Exit Bluetooth device registration mode

Press the [FNC] button.



- This unit allows up to eight digits to be input for a PIN code. If a PIN code cannot be input from this unit, it can be input from the Bluetooth device.
- If there are 5 or more Bluetooth devices registered, you cannot register a new Bluetooth device.
- If the error message appears even though the PIN code is correct, try <Registering Special Bluetooth device> (Page 32).

Registering Special Bluetooth device

Allow registration of a special device that cannot be registered normally (pairing).

1 Select Special device registration mode

Select "MENU" > "SPCL DVC Select".

For how to select Function Control item, refer to <Function Control> (page 6).

2 Enter Special device registration mode

Press the Control knob for at least 1 second.

A list is displayed.

3 Select a device name

Turn the Control knob and push the center when the desired device name is displayed.

If "Completed" is displayed, registration is completed.

4 Go through the procedure of <Registering Bluetooth device> (Page 32) and complete the registration (pairing).

Canceling Special device registration mode

Press the [FNC] button for at least 1 second.



- If the device name is not in the list, select "Other Phones".

Registering PIN Code

By operating the Bluetooth device, specify the PIN code necessary for registering this unit.

1 Select PIN code edit mode

Select "MENU" > "PIN Code Edit".

For how to select Function Control item, refer to <Function Control> (page 6).

2 Enter PIN code edit mode

Press the Control knob for at least 1 second.

The current setting of PIN code is displayed.

3 Input the PIN code

Operation type	Operation
Select the numbers.	Turn the Control knob or push it towards up or down.
Move to the next digit.	Push the Control knob towards right.
Delete the last digit.	Push the Control knob towards left.

4 Register a PIN code

Press the Control knob for at least 1 second.

If "Completed" is displayed, registration is completed.

5 Exit PIN code edit mode

Press the [FNC] button.



- By default, "0000" is specified.
- A PIN code can be specified with up to eight digits.

Downloading the Phone Book

Download the phone book data from the cell-phone to this unit so that you can use the Phone Book of this unit.

To download automatically

If the cell-phone supports a phone book synchronization function, the phone book is downloaded automatically after Bluetooth connection.



- Setting on the cell-phone may be required.
- If no phone book data is found in the unit even after the complete display, your cell-phone may not support automatic download of phone book data. In this case, try downloading manually.

To download from the cell-phone manually

1 By operating the cell-phone, end the hands-free connection.

2 By operating the cell-phone, send the phone book data to this unit

By operating the cell-phone, download the phone book data to this unit.

- During downloading:
"Downloading" is displayed.
- After completion of downloading:
"Completed" is displayed.

3 By operating the cell-phone, start the hands-free connection.

To clear the downloading completion message

Press any button.



- Up to 1000 phone numbers can be registered for each registered cell-phone.
- Up to 32 digits can be registered for each phone number along with up to 50* characters representing a name. (* 50: Number of alphabetic alphabetical characters. Fewer characters can be input depending on the type of characters.)
- To cancel downloading of the phone book data, operate the cell-phone.

Selecting the Bluetooth device You Wish to Connect

When two or more Bluetooth devices have already been registered, you need to select the Bluetooth device you wish to use.

1 Select Bluetooth device selection mode

Cell-phone

Select "MENU" > "Phone Selection".

Audio player

Select "MENU" > "Audio Selection".

For how to select Function Control item, refer to <Function Control> (page 6).

2 Enter Bluetooth device selection mode

Press the Control knob for at least 1 second.

"(name)" is displayed.

3 Select the Bluetooth device

Turn the Control knob.

4 Set up the Bluetooth device

Push the Control knob towards right or left.

"*(name)" or "-(name)" is displayed.

"*": The selected Bluetooth device is busy.

"-": The selected Bluetooth device is on standby.

" " (blank): The Bluetooth device is deselected.

5 Exit Bluetooth device selection mode

Press the [FNC] button.



- If a cell-phone is already selected, deselect it, and then select a different one.
- If you cannot select a device using the audio player, connect the device with the audio player.

Bluetooth Setup

Deleting a Registered Bluetooth device

You can delete a registered Bluetooth device.

1 Select Bluetooth device deletion mode

Select "MENU" > "Device Delete".

For how to select Function Control item, refer to <Function Control> (page 6).

2 Enter Bluetooth device deletion mode

Press the Control knob for at least 1 second.

"(name)" is displayed.

3 Select the Bluetooth device

Turn the Control knob.

4 Delete the selected Bluetooth device

Press the Control knob.

5 Turn the Control knob to select "YES", and then press the Control knob.

"Delete" is displayed.

6 Exit Bluetooth device deletion mode

Press the [FNC] button.



- When a registered cell-phone is deleted, its Phone Book, log, SMS, and voice tag are also deleted.

Displaying the Firmware Version

Display the version of the firmware of this unit.

1 Enter Bluetooth Firmware update mode

Select "MENU" > "BT F/W Update".

For how to select Function Control item, refer to <Function Control> (page 6).

2 Enter Bluetooth Firmware update mode

Press the Control knob for at least 1 second.

The firmware version appears.

3 Exit Bluetooth Firmware update mode

Press the [FNC] button.



- For how to update the firmware, access our web site.
<http://www.kenwood.com/bt/information/>

Adding a voice dialing command

Add a voice tag to the phonebook for voice dialing. You can register up to 35 voice tags.

1 Select Phonebook name edit mode

Select "BT" > "Voice Tag" > "PB Name Edit".

For how to select Function Control item, refer to <Function Control> (page 6).

2 Enter Phonebook name edit mode

Press the Control knob.

3 Search for the name to register

Select the name to register with reference to 4 in <Calling a number in the Phone Book> (Page 18).

If a voice tag has already been registered for a name, "*" is displayed before the name.

4 Select a mode

Turn the Control knob.

Display	Operation
"PB Name Regist"	Register a voice tag.
"PB Name Check"*	Play a voice tag.
"PB Name Delete"*	Delete a voice tag.
"Return"	Return to step 2.

- * Displayed only when a name for which a voice tag has been registered is selected.

Select "PB Name Regist" (Regist)

5 Register a voice tag (first)

Press the Control knob.

"Enter Voice 1" is displayed.

When a beep is heard, utter a voice tag within 2 seconds.

6 Confirm the voice tag (second)

Press the Control knob.

"Enter Voice 2" is displayed.

When a beep is heard, utter the same voice tag as that you uttered in step 4 within 2 seconds.

"Completed" is displayed.

7 End registration

Press the Control knob.

Return to step 2. You can register another voice tag continuously.



- If your voice cannot be recognized, a message is displayed. Pressing the [AUD] knob allows you to retry voice input. (Page 48)

Select "PB Name Check" (Play)

5 Press the Control knob.

Play the registered voice and return to step 2.

Select "PB Name Delete" (Delete)

5 Delete a voice tag

Press the Control knob.

6 Turn the Control knob to select "YES", and then press the Control knob.

Exit Phonebook name edit mode

Press the [FNC] button.



- Audio sound is not output during voice tag registration.

Setting a Voice Command for Category

Add a voice tag to the phone number category (type) for voice calling.

1 Select Phone Number type edit mode

Select "BT" > "Voice Tag" > "PN Type Edit".

For how to select Function Control item, refer to <Function Control> (page 6).

2 Enter Phone Number type edit mode

Press the Control knob.

3 Select the category (type) you wish to set

Turn the Control knob and push the center when the desired category name is displayed.

"General"/"Home"/"Office"/"Mobile"/"Other"

4 Select a mode

Turn the Control knob.

Display	Operation
"PN Type Regist"	Register a voice tag.
"PN Type Check"*	Play a voice tag.
"PN Type Delete"*	Delete a voice tag.
"Return"	Return to step 2.

* Displayed only when a name for which a voice tag has been registered is selected.

5 Register the category (type) by performing steps 5 to 7 in <Adding a voice dialing command> (Page34).

6 Exit Phone Number type edit mode

Press the [FNC] button.



- Set the voice tag for all the 5 categories. If the voice tag is not registered for all the categories, the Phonebook may not be recalled by voice command.

Bluetooth Setup

SMS (Short Message Service)

The SMS arrived at the cell-phone is displayed on the receiver.

A newly arrived message is displayed.



- To prevent car accidents, the driver should not read the SMS while driving.

When a new message arrives

"SMS Received" is displayed.

The display disappears with any operations.

Displaying the SMS

1 Select SMS Inbox mode

Select "BT" > "SMS" > "SMS Inbox".

For how to select Function Control item, refer to <Function Control> (page 6).

2 Enter SMS Inbox mode

Press the Control knob.

A message list appears.

3 Select a message

Turn the Control knob.

Each pushing of the Control knob towards right or left switches between telephone number or name and message reception date.

4 Display the text

Press the Control knob.

Turning the Control knob scrolls the message. Pressing the Control knob again returns to the message list screen.

5 Exit SMS Inbox mode

Press the [FNC] button.



- The unopened message is displayed at the beginning of the list. Other messages are displayed in the order of reception.
- The SMS that has arrived when the cell-phone is not linked with Bluetooth cannot be displayed. Download the SMS.
- The short message cannot be displayed during downloading the SMS.

Downloading the SMS

Download the short message (SMS) arrived at the cell-phone so that it can be read on this unit.

1 Select SMS download mode

Select "BT" > "SMS" > "SMS Download".

For how to select Function Control item, refer to <Function Control> (page 6).

2 Enter SMS download mode

Press the Control knob.

A message list appears.

3 Start downloading

Press the Control knob.

"SMS Downloading" is displayed.

When the downloading finishes, "Completed" is displayed.

4 Exit SMS download mode

Press the [FNC] button.



- The cell-phone must be able to transmit the SMS using Bluetooth. Setting on the cell-phone may be required. If the cell-phone does not support SMS function, the SMS download item in Function Control mode is not displayed.
- When the SMS is downloaded from the cell-phone, the unopened messages in the cell-phone are opened.
- The already-read and unread short messages can be respectively downloaded up to 75.

TV control (Optional)

Basic Operation

Selecting TV source

Press the [SRC] button.

Select the "TV" display.

For how to select source item, refer to <Power/Source Select button> of <Basic Operation> (page 4).

Select the TV band and Video input

Push the Control knob toward up.

Each time you push the knob, TV bands and Video input alternate.

Select the TV channel

Push the Control knob towards right or left.

Preset Memory

Putting the TV channels in the memory.

1 Select the TV channel to put in the memory

Push the Control knob towards right or left.

2 Enter Preset Memory mode

Press the [Q] button.

3 Select the number to put in the memory

Turn the Control knob.

4 Determine the number to put in the memory

Press the Control knob for at least 2 second.

Cancelling the Preset Memory mode

Press the [Q] button.

Preset Tuning

Recalling the TV channels in the memory.

1 Enter Preset Tuning Select mode

Press the [Q] button.

A list is displayed.

2 Select a desired station in the memory

Turn the Control knob.

3 Recall the station

Press the Control knob.

Cancelling Preset Tuning

Press the [Q] button.

Function of remote control

Direct TV Tuning

Entering the TV channel and tuning.

1 Enter Direct TV Tuning mode

Press the [DIRECT] button on the remote control.

"--" is displayed.

2 Enter the TV channel

Press the number buttons on the remote control.

Example:

Desired channel	Press button
8 ch	[0], [8]

Cancelling Direct TV Tuning

Press the [DIRECT] button on the remote control.

Basic Operations of remote control

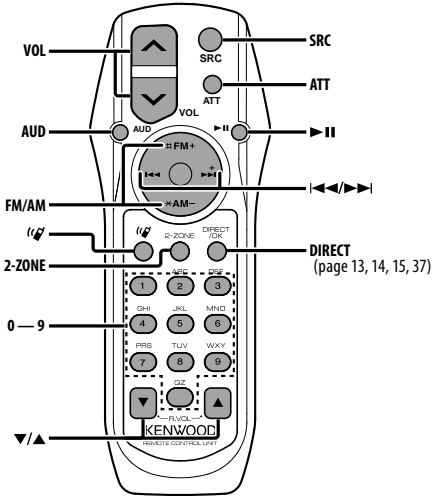

In Tuner source

- Band select [FM]/[AM]
- Station select [◀◀]/[▶▶]
- Recall preset stations [1] — [6]

In CD/USB source

- Music select [◀◀]/[▶▶]
- Folder/Disc select [FM]/[AM]
- Pause/Play [▶▶]

In TV source

- Band/Video input select [FM]
- Channel select [◀◀]/[▶▶]
- Recall preset channels [1] — [6]

General control

- Volume control [VOL]
- Source select [SRC]
- Volume reduce [ATT]

When the button is pressed again, the volume returns to the previous level.

In Audio control

- Audio item select [AUD]
- Adjust the Audio item [VOL]



- Refer to <Audio Control> (page 24) for the operation method, such as the procedures for Audio control and others operations.

Dual Zone control

- Dual zone system on and off [2-ZONE]
- Rear channel volume control [▲]/[▼]

Hands-free phone control

Making a call

Enter the dialing method selection mode [(☎)]

Select a dialing method [▶||]

Number dial input

Operation type	Operation
Input a digit.	[0] – [9] buttons
Input “+”.	[▶▶] button
Input “#”.	[FM] button
Input “*”.	[AM] button
Clear the entered phone number.	[◀◀] button

Make a call [DIRECT]

Receiving a call

Answer the call [(☎)]

Switch between the private talk mode and the hands-free talk mode [▶||]

Call waiting

Answer Another Incoming Call with the Current Call Suspended [(☎)]

Answer another Incoming Call after Terminating the Current Call [SRC]

Continue the Current Call [1]

During a call

End the call [SRC]

Adjust the voice volume [VOL]

Loading and Replacing battery

Use two “AA”/“R6”-size batteries.

Slide the cover while pressing downwards to remove it as illustrated.

Insert the batteries with the + and – poles aligned properly, following the illustration inside the case.

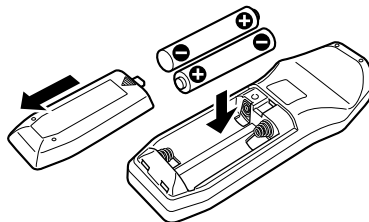

⚠ CAUTION

- Do not leave the battery near fire or under direct sunlight. A fire, explosion or excessive heat generation may result.
- Do not set the remote control in hot places such as on the dashboard.

Appendix

About Audio file

- **Playable Audio file**
AAC-LC (.m4a), MP3 (.mp3), WMA (.wma)
- **Playable disc media**
CD-R/RW/ROM
- **Playable disc file format**
ISO 9660 Level 1/2, Joliet, Romeo, Long file name.
- **Playable USB device**
USB mass storage class
- **Playable USB device file system**
FAT16, FAT32

Although the audio files are complied with the standards listed above, the play maybe impossible depending on the types or conditions of media or device.

Playing order of the Audio file

In the example of folder/file tree shown below, the files are played in the order from ① to ⑩.

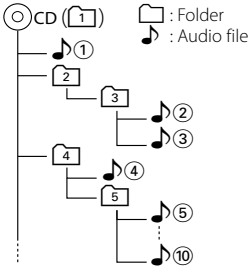

An online manual about audio files is put on the site, www.kenwood.com/audiofile/. On this online manual, detailed information and notes which are not written in this manual are provided. Make sure to read through the online manual as well.



- In this manual, the word "USB device" is used for flash memories and digital audio players which have USB terminals.

iPod/iPhone that can be connected to this unit

Made for

- iPod nano (1st generation)
- iPod nano (2nd generation)
- iPod nano (3rd generation)
- iPod nano (4th generation)
- iPod with video
- iPod classic
- iPod touch (1st generation)
- iPod touch (2nd generation)

Works with

- iPhone
- iPhone 3G



iPhone
4GB 8GB 16GB



iPhone 3G
8GB 16GB

- Update iPod/iPhone software to the latest version.
- The word "iPod" appearing in this manual indicates the iPod or the iPhone connected with the iPod connection cable* (optional accessory).
- * Not supported model KCA-iP500.

Refer to the web site for connectable iPod and iPod connection cable.

www.kenwood.com/ipod/kca_ip/



- If you start playback after connecting the iPod, the music that has been played by the iPod is played first.
In this case, "RESUMING" is displayed without displaying a folder name, etc. Changing the browse item will display a correct title, etc.
- You cannot operate iPod if "KENWOOD" or "✓" displayed on iPod.

About USB device

- When the USB device is connected to this unit, it can be charged up provided that this unit is powered.
- Install the USB device in the place where it will not prevent you from driving your vehicle properly.
- You cannot connect a USB device via a USB hub and Multi Card Reader.
- Take backups of the audio files used with this unit. The files can be erased depending on the operating conditions of the USB device.
We shall have no compensation for any damage arising out of erasure of the stored data.
- No USB device comes with this unit. You need to purchase a commercially available USB device.
- When connecting the USB device, usage of the CA-U1EX (option) is recommended.
Normal playback is not guaranteed when a cable other than the USB compatible cable is used.
Connecting a cable whose total length is longer than 5 m can result in abnormal playback.

For operating KCA-BT200 (Optional)

For operation refer to Model-B-2 in the Instruction Manual of KCA-BT200, and the table below.

Notation used in the KCA-BT200 Instruction Manual	Operation
 button	Control knob
Press the [AUTO]/[T1] button.	Press the Control knob for at least 1 second.

For operating KCA-BT100 (Optional)

The following control methods of the function for this unit may be different from the Instruction manual; therefore, refer to the following supplemental instruction.

<Dialing by Using the Quick Dialing Function>

1. Press the Control knob. Select the display other than "INITIAL".
2. Press the [**Q**] button.
3. Select the number to recall by turning the Control knob.
4. Press the Control knob.

<Registering to the Preset Dial Number List>

1. Operation is the same. Refer to the instruction manual of KCA-BT100.
2. Press the [**Q**] button.
3. Select the number to memory by turning the Control knob.
4. Press the Control knob for at least 1 second.

<Deleting a Registered Cell-Phone>

Refer to <Deleting a Registered Bluetooth device> in this instruction manual.

<Menu System>

For how to operate Menu, refer to <Function Control> in this instruction manual.

About display

Cell-Phone Status is displayed in the status display of this unit.

Moreover, some displays are different from the description of KCA-BT100 Instruction Manual.

Displays of KCA-BT100 Instruction Manual	Actual displays on this unit
"DISCONNECT"	"HF Disconnect"
"CONNECT"	"HF Connect"
"PHN-DEL"	"Device Delete"
"P-STATUS"	"Phone Status"

About the Cell-Phone

This unit conforms to the following Bluetooth specifications:

Version	Bluetooth Standard Ver. 1.2
Profile	HFP (Hands Free Profile) OPP (Object Push Profile) PBAP (Phonebook Access Profile) SYNC (Synchronization Profile)

For the cell-phones verified for compatibility, access the following URL:

<http://www.kenwood.com/bt/information/>



- The units supporting the Bluetooth function have been certified for conformity with the Bluetooth Standard following the procedure prescribed by Bluetooth SIG. However, it may be impossible for such units to communicate with your cell-phone depending on its type.
- HFP is a profile used to make a hands-free call.
- OPP is a profile used to transfer data such as a phone book between units.

About the Bluetooth Audio player

This unit conforms to the following Bluetooth specifications:

Version	Bluetooth Standard Ver. 1.2
Profile	A2DP (Advanced Audio Distribution Profile) AVRCP (Audio/Video Remote Control Profile)



- A2DP is a profile designed to transfer the music from an audio player.
- AVRCP is a profile designed to control playback and selection of music by an audio player.

About KENWOOD "Music Editor" of PC application

- "Music Editor" is recorded in the CD-ROM attached to this unit.
- Refer to the user's manual recorded in the installation CD-ROM and Help of "Music Editor" for the operation method of "Music Editor".
- The unit can play USB device created by "Music Editor".
- Information about "Music Editor" upgrade is put on the site, www.kenwood.com.

Appendix

Menu Glossary

• AMP

Selecting "OFF" turns off the built-in amplifier. Turning off the built-in amplifier improves the quality of the sound from Preout.

• Auto Answer (Setting the Time Interval for Automatic Answer)

This function automatically answers (responds to) a call after lapse of the preset time interval for automatic answer.

"OFF": Does not answer the phone call automatically.

"0": Automatically answers the phone call at once.

"1s" – "99s": Automatically answers the phone call after lapse of 1 – 99 seconds.



- If the time set in the cell-phone is shorter than that set in the unit, the former will be used.
- This function does not work for call waiting.

• Call Beep (Setting the Beep of the Incoming Call)

You can output a beep from the speaker when a call comes in.

"ON": Beep is heard.

"OFF": Beep is canceled.

• CD Read

Sets the method for reading CD.

When unable to play special format CD, set this function to "2" to force playing. Note that some music CD may be unplayable even when set to "2". In addition, audio files cannot be played when set to "2". Normally, keep this set to "1".

1 : Automatically distinguishes between audio file disc and music CD when playing disc.

2 : Forces playing as music CD.

• Chinese (Chinese language setting)

When this is set to ON, the following character strings are displayed in Chinese:

Folder name/ File name/ Song title/ Artist name/ Album name/ KCA-BT200/BT100 (optional accessory)

• Display

If this unit is not operated at least 5 seconds with "OFF" selected, the display turns off. During a setup mode, the display will not turn off even if 5 seconds lapse.

• DISP DIM (Display illumination dimmer)

Reduces the display illumination brightness.

AUTO: Dims the illumination in conjunction with the Light switch of the vehicle.

MNAL1: Dims the illumination constantly.

MNAL2: Dims the illumination darker than MNAL1.

OFF: Does not dim the illumination.

• DISP N/P

Switches the panel display between positive or negative. In addition, you can reverse it in conjunction with the interior light.

POS11 : Displays the text in the positive.

POS12 : When the interior light is off, the text is displayed in the positive; when the interior light is on, the text is displayed in the negative.

NEGA1 : Displays the text in the negative.

NEGA2 : When the interior light is off, the text is displayed in the negative; when the interior light is on, the text is displayed in the positive.

• DTA (Digital Time Alignment)

Make fine adjustment of the delay time of the speaker output specified at <Cabin selection> (page 25) to have a more suitable environment for your vehicle.

The settings of the delay time are automatically identified and compensated by specifying the distances of each speaker from the center of the vehicle interior.

1 Set the front and rear positions and the height of the reference point to the position of the ears of the person sitting in the front seat, and set the right and left positions to the center of the vehicle interior.

2 Measure the distances from the reference point to the speakers.

3 Calculate the distance difference in accordance with the farthest speaker.

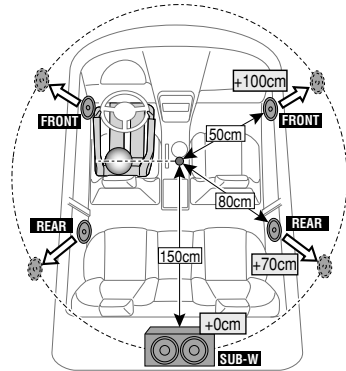

• BT DVC Status (Displaying the Bluetooth device Status)

You can display the connection status, signal strength, and battery level.

: Battery level of cell-phone.

Full Nearly dead

 : Signal strength of cell-phone.
Maximum     Minimum



- Icons are not displayed if information cannot be obtained from the cell-phone.
- Since the number of steps of the control unit is different from that of the cell-phone, the statuses displayed on the control unit may discord from those displayed on the cell-phone.

• **HIGHWAY-SOUND**

Increases the volume of faintest sound being lost by road noises to make the sound more audible. Additionally, it accentuates bass sound being lost by road noises to make the bass sound more dynamic.

• **Illumi DIM (Key illumination dimmer)**

Reduces the key illumination brightness.
AUTO: Dims the illumination in conjunction with the Light switch of the vehicle.
MNAL1: Dims the illumination constantly.
MNAL2: Dims the illumination darker than MNA1.
OFF: Does not dim the illumination.

• **Language (Language setting)**

When the language is selected, the following character strings are displayed in the selected language:
Folder name/ File name/ Song title/ Artist name/ Album name/ KCA-BT200/BT100 (optional accessory)

• **Mic Gain**

Adjusts the sensitivity of the built-in microphone for a telephone call. Adjust the voice of caller. Setting to "+" increases the voice volume.

• **NR Level**

Reduces the noises generated by surrounding environment without changing the built-in microphone volume. Adjust the voice of caller when it is not clear. Setting to "+" increases the noise reduction.

• **SP Select (Setting up the Voice Output Speakers)**

You can specify the voice output speakers.
"FRONT": Outputs voice from the front-left and front-right speakers.
"F-R": Outputs voice from the front-right speaker.
"F-L": Outputs voice from the front-left speaker.



- Select the speaker which is further from the microphone in order to prevent howling or echoes.
- **SRC Select**
Setting up the Source Select mode.
1 : Displays source icons for your choice.
2 : Allows you to select sources one after another.

• **Supreme+ (Supreme Plus)**

Technology to extrapolate and supplement with proprietary algorithm, the high-frequency range that is cut off when encoding.
The bass and vocal sound that are cut off by encoding are supplemented for the reproduction of natural sound quality.
Supplementing is optimized by compression format (AAC, MP3 or WMA) and processed according to bit rate.
The effect is negligible with music that is encoded at high bit rate, variable bit rate or has minimal high frequency range.
The bass and vocal sound of Music CD and iPod is also supplemented.

• **Zone2 (Dual Zone)**

Set the destination (front speaker "Front" or rear speaker "Rear") of the sub source (AUX IN) when the Dual Zone function is turned on.

The marking of products using lasers (Except for some areas)

**CLASS 1
LASER PRODUCT**

The label is attached to the chassis/case and says that the component uses laser beams that have been classified as Class 1. It means that the unit is utilizing laser beams that are of a weaker class. There is no danger of hazardous radiation outside the unit.

- The "AAC" logo is trademark of Dolby Laboratories.
- The Bluetooth word mark and logos are owned by the Bluetooth SIG, Inc. and any use of such marks by Kenwood Corporation is under license. Other trademarks and trade names are those of their respective owners.
- iTunes is a trademark of Apple Inc.
- iPod is a trademark of Apple Inc., registered in the U.S. and other countries.
- iPhone is a trademark of Apple Inc.
- "Made for iPod" means that an electronic accessory has been designed to connect specifically to iPod and has been certified by the developer to meet Apple performance standards.
- "Works with iPhone" means that an electronic accessory has been designed to connect specifically to iPhone and has been certified by the developer to meet Apple performance standards.
- Apple is not responsible for the operation of this device or its compliance with safety and regulatory standards.

Accessories/ Installation Procedure

Accessories

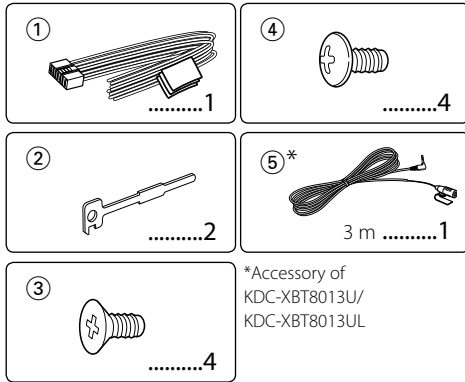

Installation Procedure

1. To prevent a short circuit, remove the key from the ignition and disconnect the \ominus battery.
2. Make the proper input and output wire connections for each unit.
3. Connect the speaker wires of the wiring harness.
4. Connect the wiring harness wires in the following order: ground, battery, ignition.
5. Connect the wiring harness connector to the unit.
6. Install the unit in your car.
7. Reconnect the \ominus battery.
8. Press the reset button.

▲WARNING

If you connect the ignition wire (red) and the battery wire (yellow) to the car chassis (ground), you may cause a short circuit, that in turn may start a fire. Always connect those wires to the power source running through the fuse box.



- Mounting and wiring this product requires skills and experience. For safety's sake, leave the mounting and wiring work to professionals.
- Make sure to ground the unit to a negative 12V DC power supply.
- Do not install the unit in a spot exposed to direct sunlight or excessive heat or humidity. Also avoid places with too much dust or the possibility of water splashing.
- Do not use your own screws. Use only the screws provided. If you use the wrong screws, you could damage the unit.
- If the power is not turned ON ("Protect" is displayed), the speaker wire may have a short-circuit or touched the chassis of the vehicle and the protection function may have been activated. Therefore, the speaker wire should be checked.

- If your car's ignition does not have an ACC position, connect the ignition wires to a power source that can be turned on and off with the ignition key. If you connect the ignition wire to a power source with a constant voltage supply, as with battery wires, the battery may die.
- If the console has a lid, make sure to install the unit so that the faceplate will not hit the lid when closing and opening.
- If the fuse blows, first make sure the wires aren't touching to cause a short circuit, then replace the old fuse with one with the same rating.
- Insulate unconnected wires with vinyl tape or other similar material. To prevent a short circuit, do not remove the caps on the ends of the unconnected wires or the terminals.
- Connect the speaker wires correctly to the terminals to which they correspond. The unit may be damaged or fail to work if you share the \ominus wires or ground them to any metal part in the car.
- When only two speakers are being connected to the system, connect the connectors either to both the front output terminals or to both the rear output terminals (do not mix front and rear). For example, if you connect the \oplus connector of the left speaker to a front output terminal, do not connect the \ominus connector to a rear output terminal.
- After the unit is installed, check whether the brake lamps, blinkers, wipers, etc. on the car are working properly.
- Mount the unit so that the mounting angle is 30° or less.
- Reception may drop if there are metal objects near the Bluetooth antenna.

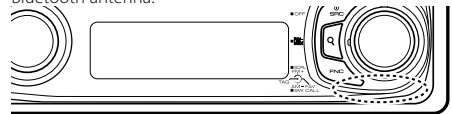

Bluetooth antenna unit

About CD players/disc changers connected to this unit

If the CD player/ disc changer has the "O-N" switch, set it to the "N" position.

The functions you can use and the information that can be displayed may differ depending on the models being connected.

For Good Reception

To assure good reception, note the following:

- Communicate with the cell-phone within the line-of-sight distance of 10 m (30 ft). The communication range becomes shorter depending on the surrounding environment. The communication range also becomes shorter when there is an obstacle between this unit and the cell-phone. The above maximum communication range (10 m) is not always assured.
- A broadcast station or walkie-talkie located nearby can interfere with communication due to too strong signal.

Connecting Wires to Terminals

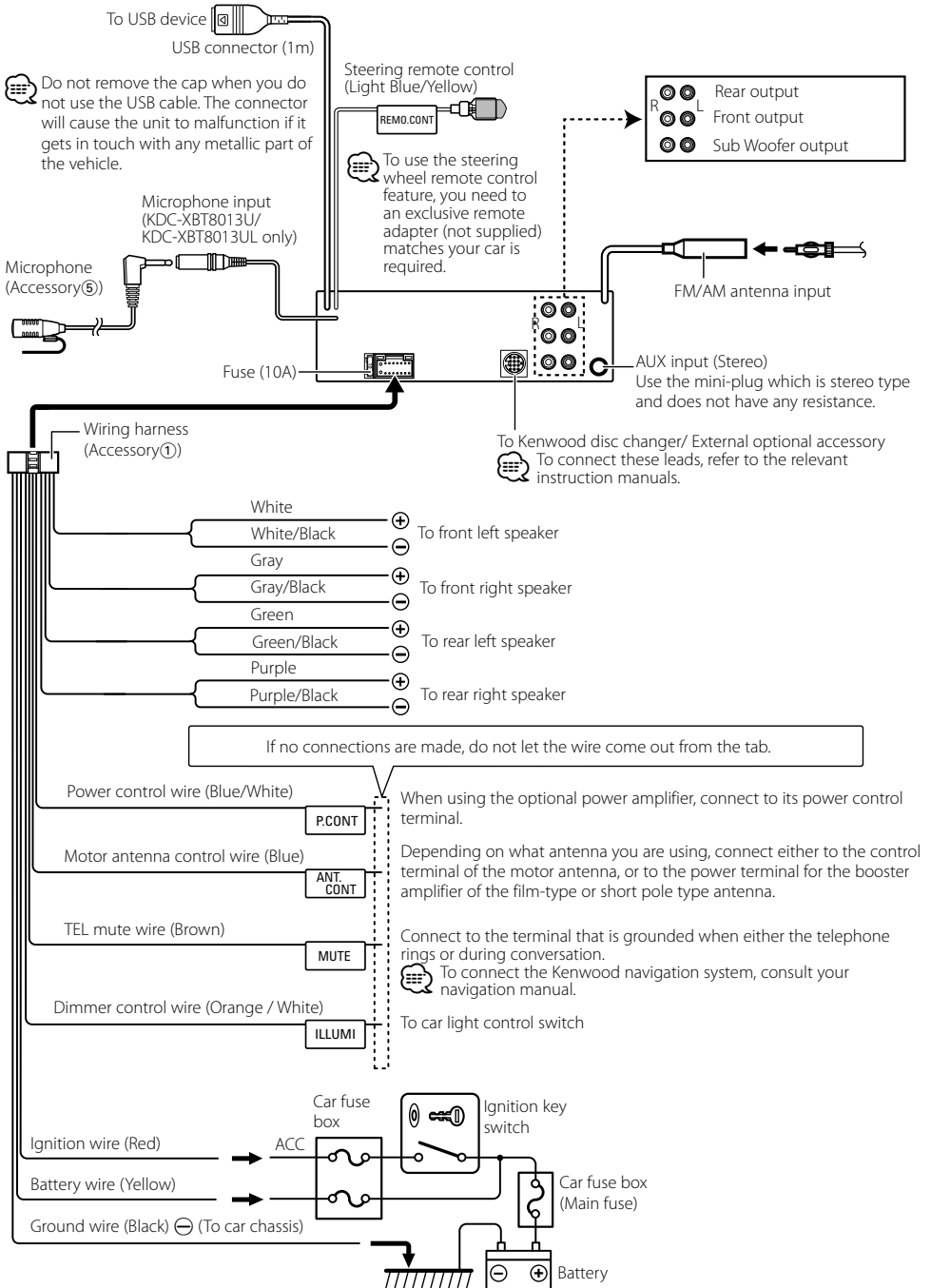

Installation/Removing the Unit

non-Japanese cars

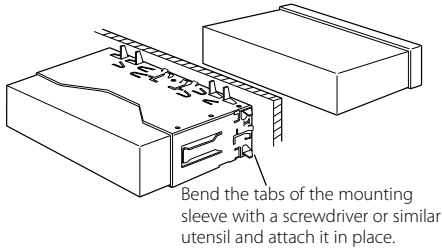

- Make sure that the unit is installed securely in place. If the unit is unstable, it may malfunction (for example, the sound may skip).

Japanese cars

- 1 Refer to the section <Removing the hard rubber frame> and then remove the hard rubber frame.
- 2 Align the holes in the unit (two locations on each side) with the vehicle mounting bracket and secure the unit with the accessory screws.

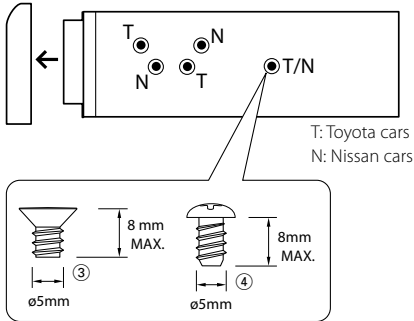

CAUTION

Install this unit in the console of your vehicle.
Do not touch the metal part of this unit during and shortly after the use of the unit. Metal part such as the heat sink and enclosure become hot.

Removing the hard rubber frame

- 1 Engage the catch pins on the removal tool and remove the two locks on the upper level. Upper the frame and pull it forward as shown in the figure.

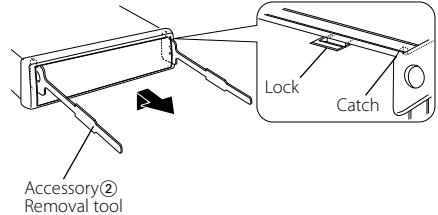

- 2 When the upper level is removed, remove the lower two locations.



- The frame can be removed from the bottom side in the same manner.

Removing the Unit

- 1 Refer to the section <Removing the hard rubber frame> and then remove the hard rubber frame.
- 2 Insert the two removal tools deeply into the slots on each side, as shown.
- 3 Lower the removal tool toward the bottom, and pull out the unit halfway while pressing towards the inside.

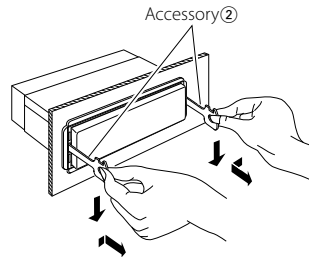

- Be careful to avoid injury from the catch pins on the removal tool.
- 4 Pull the unit all the way out with your hands, being careful not to drop it.

Installation the Microphone Unit

- 1 Check the installation position of the microphone (accessory ⑤).
- 2 Remove oil and other dirt from the installation surface.
- 3 Install the microphone.
- 4 Wire the microphone cable up to the hands-free box with it secured at several positions using tape or the like.

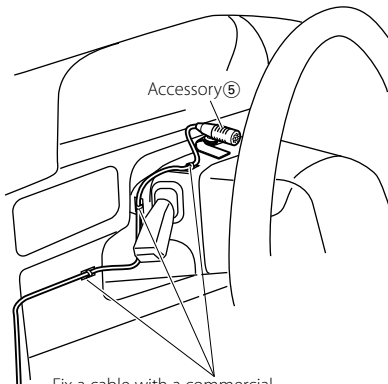

Fix a cable with a commercial item of tape.

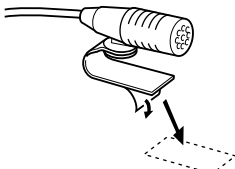

Peel the release coated paper of double-face adhesive tape to fix on the place shown above.



Adjust the direction of the microphone to the driver.





- Install the microphone as far as possible from the cell-phone.

Troubleshooting Guide

Some functions of this unit may be disabled by some settings made on this unit.

- !** • **Cannot set up the subwoofer.**
- **No output from the subwoofer.**
- **Cannot set up the subwoofer position of Manual position setting.**
 - ▶ • <Subwoofer output> of <Basic Operation> (page 4) is not set to On.
 - The Dual zone function is enabled.  <Audio Setup> (page 27)

- !** • **Cannot set up the subwoofer phase.**
 - ▶ The Low Pass Filter is set to Through.  <X'Over setting> (page 29)

- !** • **Cannot select the output destination of the subsource in the Dual zone.**
- **Cannot adjust the volume of the rear speakers.**
 - ▶ The Dual zone function is disabled.  <Audio Setup> (page 27)

- !** • **Cannot register a security code.**
- **Cannot set up Display.**
 - ▶ <Demonstration mode Setting> (page 26) is not turned off.

What might seem to be a malfunction in your unit may just be the result of slight misoperation or miswiring. Before calling service, first check the following table for possible problems.

General

? The Touch Sensor Tone does not sound.

- ✓ The preout jack is being used.
 -  The Touch Sensor Tone cannot be output from the preout jack.

? The illumination flashes when the knob or button is operated.

- ✓ This is the key illumination effect.
 -  You set this effect in "MENU" > "ILM Effect" of <Function Control> (page 6).

? The key illumination effect brought about in conjunction with the sound volume is small.

- ✓ The key illumination effect may be insufficient depending on the sound volume and sound quality.



Tuner source

? Radio reception is poor.

- ✓ The car antenna is not extended.
 -  Pull the antenna out all the way.



Disc source

? The specified disc does not play, but another one plays instead.

- ✓ The specified CD is quite dirty.
 -  Clean the CD, referring to the CD cleaning of the section on <Handling CDs> (page 3).
- ✓ The disc is loaded in a different slot from that specified.
 -  Eject the disc magazine and check the number for the specified disc.
- ✓ The disc is severely scratched.
 -  Try another disc instead.

Audio file source

? The sound skips when an Audio file is being played.

- ✓ The media is scratched or dirty.
 -  Clean the media, referring to the CD cleaning of the section on <Handling CDs> (page 3).
- ✓ The recording condition is bad.
 -  Record the media again or use another media.

Hands-free

? The hands-free talk volume is low.

- ✓ The hands-free talk volume is set at a low level.
 - ☞ The hands-free talk volume can be adjusted independently. Adjust it during hands-free talk. "MENU" > "Mic Gain" and "NR Level" <Function Control> (page 6).

? No sound is heard from the rear speakers.

- ✓ You are talking in the hand-free talk mode.
 - ☞ No sound is heard from the rear speakers in the hands-free talk mode.

? No beep is heard at reception of an incoming call.

- ✓ No beep is heard depending on the type of your cell-phone.
 - ☞ The "MENU" > "Call Beep" of <Function Control> (page 6) is set ON.

? Voice is not recognized.

- ✓ The vehicle window is open.
 - ☞ If the surrounding noise is large, voice cannot be recognized properly. Close the vehicle windows to reduce noise.
- ✓ Small voice.
 - ☞ If voice is too small, it cannot be recognized properly. Speak into the microphone a little more loudly and naturally.
- ✓ The person uttering the voice tag is not the one who registered the it.
 - ☞ Only the voice of the person who registered the voice tag can be recognized.

Bluetooth audio source

? The Bluetooth audio player cannot be registered (pairing).

- ✓ The PIN code is fixed.
 - ☞ When a PIN code is specified in the Instruction Manual for Bluetooth Audio Player, register it with reference to <Registering PIN Code> (Page 32) to register the Bluetooth audio player. If no PIN code is specified in the Instruction Manual, try "0000".

? The sound from the Bluetooth audio player is discontinuous.

- ✓ The distance between this unit and audio player is too far.
 - ☞ Move the audio player nearer to this unit.
- ✓ Another Bluetooth device is affecting the Bluetooth communication.
 - ☞ Turn off another Bluetooth device.
 - ☞ Move another Bluetooth device away from this unit.
- ✓ Another Bluetooth device or profile is used for communication.
 - ☞ The downloading of the Phone book or the SMS disconnects the sound.

The messages shown below display your systems condition.

- TOC Error:
 - No disc has been loaded in the disc magazine.
 - The CD is quite dirty. The CD is upside-down. The CD is scratched a lot.
- ERROR 05: The disc is unreadable.
- ERROR 77: The unit is malfunctioning for some reason.
 - ☞ Press the reset button on the unit. If the "ERROR 77" code does not disappear, consult your nearest service center.
- ERROR 99: Something is wrong with the disc magazine. Or the unit is malfunctioning for some reason.
 - ☞ Check the disc magazine. And then press the reset button on the unit. If the "ERROR 99" code does not disappear, consult your nearest service center.
- CD-IN (Blink): The CD player section is not operating properly.
 - ☞ Reinsert the CD. If the CD cannot be ejected or the display continues to flash even when the CD has been properly reinserted, please switch off the power and consult your nearest service center.
- Protect (Blink): The speaker wire has a short-circuit or touches the chassis of the vehicle, and then the protection function is activated.
 - ☞ Wire or insulate the speaker cable properly and press the reset button. If the "Protect" code does not disappear, consult your nearest service center.
- Unsupported File: An Audio file is played with a format that this unit can't support.
- Copy Protection: A copy-protected file is played.
- Read Error: The file system of the connected USB device is broken.
 - ☞ Copy the files and folders for the USB device again. If the error message is still displayed, initialize the USB device or use other USB devices.
- No Device: The USB device is selected as a source although no USB device is connected.
 - ☞ Change the source to any source other than USB. Connect an USB device, and change the source to USB again.
- N/A Device:
 - An unsupported USB device is connected.
 - Connection to the iPod has failed.
 - ☞ Check that the connected iPod is an iPod that is supported. See <About Audio file> (Page 40) for information on supported iPods.

Troubleshooting Guide

No Music Data/Error 15:	<ul style="list-style-type: none">• The connected USB device contains no playable audio file.• Media was played that does not have data recorded that the unit can play.	Too Long:	The word or utterance is too long to be recognized.
USB ERROR:	Some trouble may have occurred to the connected USB device. <ul style="list-style-type: none">➡ Remove the USB device, then cycle the power switch to ON. If the same display is repeated, use another USB device.	No Phonebook:	Data is not contained in the phone book.
iPod Error:	Connection to the iPod has failed. <ul style="list-style-type: none">➡ Remove the USB device and then reconnect it.➡ Confirm that the software for the iPod is the latest version.	No Message:	No short message in In Box.
USB REMOVE (Blink):	The Remove mode has been selected for the USB device/iPod. You can remove the USB device/iPod safely.	No Record:	The voice tag is not registered in the phonebook.
NO Number:	<ul style="list-style-type: none">• The calling party does not notify a caller ID.• There is no phone number data.	Memory Full:	The number of voice tags reaches the maximum number to be registered in the phonebook.
No Data:	<ul style="list-style-type: none">• There is no outgoing call list.• There is no incoming call list.• There is no missed call list.• There is no phone book list.	Favorite: No Memory:	The procedure is not registered to Favorite Preset Memory
No Entry:	The cell-phone has not been registered (pairing).	No Access:	The procedure preset with Favorite Control cannot be available. The preset content may not be recalled depending on the selected source or mode.
HF Disconnect:	The unit cannot communicate with the cell-phone.	No Voice:	No call.
HF Error 07:	The memory cannot be accessed. <ul style="list-style-type: none">➡ Turn off the power and on again. If this message still appears, press the reset button on the control unit.		
HF Error 68:	The unit cannot communicate with the cell-phone. <ul style="list-style-type: none">➡ Turn off the power and on again. If this message still appears, press the reset button on the control unit.		
Un Known:	The Bluetooth device cannot be detected.		
Device Full:	5 Bluetooth device have already been registered. No more Bluetooth device cannot be registered.		
PIN Code NG:	The PIN code is wrong.		
Connect NG:	The unit cannot be connected to the device.		
Pairing Failed:	Pairing error.		
Err No Matching:	The voice tag is wrong. Voice cannot be recognized because of an unregistered voice tag, etc.		
Too Soft:	Voice is too small and cannot be recognized.		
Too Loud:	Voice is too large to be recognized.		

Specifications

FM tuner section

- Frequency range
 - 200 kHz space : 87.9 MHz – 107.9 MHz
 - 50 kHz space : 87.5 MHz – 108.0 MHz
- Usable sensitivity (S/N = 30dB)
 - : 9.3dBf (0.8 μ V/75 Ω)
- Quieting Sensitivity (S/N = 50dB)
 - : 15.2dBf (1.6 μ V/75 Ω)
- Frequency response (\pm 3 dB)
 - : 30 Hz – 15 kHz
- Signal to Noise ratio (MONO)
 - : 70 dB
- Selectivity (\pm 400 kHz)
 - : \geq 80 dB
- Stereo separation (1 kHz)
 - : 40 dB

AM tuner section

- Frequency range
 - 10 kHz space : 530 kHz – 1700 kHz
 - 9 kHz space : 531 kHz – 1611 kHz
- Usable sensitivity (S/N = 20dB)
 - : 28 dB μ (25 μ V)

Bluetooth section

(KDC-XBT8013U/ KDC-XBT8013UL)

- Version
 - : Bluetooth Ver. 1.2 Certified
- Frequency range
 - : 2.402 – 2.480 GHz
- Output Power
 - : +4dBm (MAX), 0dBm (AVE) Power Class 2
- Maximum Communication range
 - : Line of sight approx.10m (32.8 ft)
- Profiles
 - : HFP (Hands Free Profile)
 - : HSP (Headset Profile)
 - : SPP (Serial Port Profile)
 - : PBAP (Phonebook Access Profile)
 - : OPP (Object Push Profile)
 - : SYNC (Synchronization Profile)
 - : A2DP (Advanced Audio Distribution Profile)
 - : AVRCP (Audio/Video Remote Control Profile)

CD player section

- Laser diode
 - : GaAlAs
- Digital filter (D/A)
 - : 8 Times Over Sampling
- D/A Converter
 - : 24 Bit
- Spindle speed
 - : 500 – 200 rpm (CLV)
- Wow & Flutter
 - : Below Measurable Limit
- Frequency response (\pm 1 dB)
 - : 10 Hz – 20 kHz
- Total harmonic distortion (1 kHz)
 - : 0.008 %
- Signal to Noise ratio (1 kHz)
 - : 110 dB
- Dynamic range
 - : 93 dB
- MP3 decode
 - : Compliant with MPEG-1/2 Audio Layer-3
- WMA decode
 - : Compliant with Windows Media Audio
- AAC decode
 - : AAC-LC “.m4a” files

USB Interface

- USB Standard
 - : USB1.1/ 2.0 (Full speed)
- Maximum Supply current
 - : 500 mA
- File System
 - : FAT16/ 32
- MP3 decode
 - : Compliant with MPEG-1/2 Audio Layer-3
- WMA decode
 - : Compliant with Windows Media Audio
- AAC decode
 - : AAC-LC “.m4a” files

Specifications

Audio section

Maximum output power
: 50 W x 4

Full Bandwidth Power (at less than 1% THD)
: 22 W x 4

Speaker Impedance
: 4 – 8 Ω

Tone action

- BAND1 (60 Hz): ± 9 dB
- BAND2 (250 Hz): ± 9 dB
- BAND3 (1 kHz): ± 9 dB
- BAND4 (4 kHz): ± 9 dB
- BAND5 (16 kHz): ± 9 dB

Preout level / Load (CD)
: 4000 mV/10 k Ω

Preout impedance
: $\leq 600 \Omega$

Auxiliary input

Frequency response (± 1 dB)
: 20 Hz – 20 kHz

Input Maximum Voltage
: 1200 mV

Input Impedance
: 10 k Ω

General

Operating voltage
KDC-XBT8013U/KDC-XBT8013UL
(10.5 – 16V allowable) : 14.4 V
KDC-X7013U/KDC-X7013UL
(11 – 16V allowable) : 14.4 V

Maximum Current consumption
: 10 A

Installation Size (W x H x D)
: 182 x 53 x 155 mm

Weight
: 1.4 kg

Specifications subject to change without notice.

Free Manuals Download Website

<http://myh66.com>

<http://usermanuals.us>

<http://www.somanuals.com>

<http://www.4manuals.cc>

<http://www.manual-lib.com>

<http://www.404manual.com>

<http://www.luxmanual.com>

<http://aubethermostatmanual.com>

Golf course search by state

<http://golfingnear.com>

Email search by domain

<http://emailbydomain.com>

Auto manuals search

<http://auto.somanuals.com>

TV manuals search

<http://tv.somanuals.com>