

KENWOOD

DVD RECEIVER

DVR-605

DVR-6100

DVR-6100K

INSTRUCTION MANUAL

KENWOOD CORPORATION

This instruction manual is for some models. Model availability and features (functions) may differ depending on the country and sales area.



B60-5262-08 00 (K/P/E/T/M/M2/X/Y) WS 02/05

Before applying power

⚠ Caution : Read this page carefully to ensure safe operation.

Units are designed for operation as follows.

U.S.A. and Canada AC 120V only
Australia AC 240 V only

Europe and U.K. AC 230V only
***Other countries AC 110-120 / 220-240 V switchable**

For the United Kingdom

Factory fitted moulded mains plug

1. The mains plug contains a fuse. For replacement, use only a 13-Amp ASTA-approved (BS 1362) fuse.
2. The fuse cover must be refitted when replacing the fuse in the moulded plug.
3. Do not cut off the mains plug from this equipment. If the plug fitted is not suitable for the power points in your home or the cable is too short to reach, a power point, then obtain an appropriate safety approved extension lead or adapter, or consult your dealer. If nonetheless the mains plug is cut off, remove the fuse and dispose of the plug immediately, to avoid a possible shock hazard by inadvertent connection to the mains supply.

IMPORTANT :

The wires in the mains lead are coloured in accordance with the following code:

Blue : Neutral

Brown : Live

Do not connect those leads to the earth terminal of a three-pin plug.

*For other countries

AC voltage selection

The AC voltage selector switch on the rear panel is set to the voltage that prevails in the area to which the unit is shipped. Before connecting the power cord to your AC outlet, make sure that the setting position of this switch matches your line voltage. If not, it must be set to your voltage in accordance with the following direction.

AC voltage selector switch

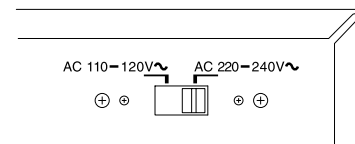

Move switch lever to match your line voltage with a small screwdriver or other pointed tool.





Note:

Our warranty does not cover damage caused by excessive line voltage due to improper setting of the AC voltage selector switch.

Safety precautions

⚠ Caution : Read this page carefully to ensure safe operation.

WARNING : TO PREVENT FIRE OR ELECTRIC SHOCK, DO NOT EXPOSE THIS APPLIANCE TO RAIN OR MOISTURE.

 <div style="border: 1px solid black; padding: 2px; text-align: center;"> CAUTION <small>RISK OF ELECTRIC SHOCK DO NOT OPEN</small> </div> 	CAUTION: TO REDUCE THE RISK OF ELECTRIC SHOCK, DO NOT REMOVE COVER (OR BACK). NO USER-SERVICEABLE PARTS INSIDE, REFER SERVICING TO QUALIFIED SERVICE PERSONNEL.
	THE LIGHTNING FLASH WITH ARROWHEAD SYMBOL, WITHIN AN EQUILATERAL TRIANGLE, IS INTENDED TO ALERT THE USER TO THE PRESENCE OF UNINSULATED "DANGEROUS VOLTAGE" WITHIN THE PRODUCT'S ENCLOSURE THAT MAY BE OF SUFFICIENT MAGNITUDE TO CONSTITUTE A RISK OF ELECTRIC SHOCK TO PERSONS.
	THE EXCLAMATION POINT WITHIN AN EQUILATERAL TRIANGLE IS INTENDED TO ALERT THE USER TO THE PRESENCE OF IMPORTANT OPERATING AND MAINTENANCE (SERVICING) INSTRUCTIONS IN THE LITERATURE ACCOMPANYING THE APPLIANCE.





The marking of products using lasers (Except for some areas)

**CLASS 1
LASER PRODUCT**

The marking this product has been classified as Class 1. It means that there is no danger of hazardous radiation outside the product.
 Location: Back panel

Caution : Read the pages marked  carefully to ensure safe operation.

Preparations

Introduction	2
 Before applying power	2
 Safety precautions	2
Accessories	4
CHANNEL SPACE setting (Except for the U.S.A., Canada, U.K., Europe and Australia)	4
 IMPORTANT SAFEGUARDS	5
Special features	7
Reference	7
Maintenance	8
Discs information	9
Types of playable discs	9
Unplayable discs	9
Icons on the DVD discs	9
Region codes	10
Region codes in the world	10
Examples of TV screen display of each video format	10
Video formats	11
Video formats of DVD discs that can be played on this unit	11
 System Connections	12
Loudspeakers	12
AM loop antenna	13
FM antenna	13
Connecting to a TV	14
Connecting to a Satellite Tuner	14
Connecting to Audio video equipments	15
Connecting a Camcorder or Video game machine	15
Controls and indicators	16
Operation of remote control unit	17

Operations

Let's put out some sound	18
Basic use method	18
Changing the Tone	19
Dimmer	20
Receiving broadcast station	21
Storing the broadcast stations (one-by-one presetting)	22
Using RDS function (for Europe and U.K. only)	23
PTY function (for Europe and U.K. only)	24
Progressive Scan (for US and Canada only)	25
Playback of disc	26
Basic play	26
Disc playback features	27
Using the On-screen banner display	28
Selecting a Title	29
Selecting a Chapter or Track	29
Changing the Audio Language	30
Changing the Subtitle Language	30
Changing the Camera angle	31
Using IntroScan function	31
Using Bookmarks	32
Repeat play	33
A-B Repeat play	33
Random play	34

Program play	35
Menu playback	37
Hierarchical structure of VCD menus	37
Examples of operation keys and indications used during VCD playback	37
Playback without using the menu playback function (In case of a P.B.C.-compatible VCD) (To P.B.C. On or Off)	38
Enjoying karaoke singing (DVR-6100K only)	39
Selecting the Audio channel	39
Controlling the key of the music (KEY CONTROL)	39
Adjust the ECHO level	40
HIT MASTER function	40
MP3 function	41
Guidance of MP3	41
Playing back MP3	42
Selecting MP3 files	43
MP3 Repeat play	44
MP3 Random play	44
MP3 Program play	45
Set Up functions	46
Set up menu	46
Select Audio Language	47
Select Subtitle Language	47
Select Menu Language	48
Select Rating	48
Password	49
TV aspect	51
Setting up Listen mode	52
What are Listen modes?	52
To set the LISTEN mode manually	53
Speaker setting	54
Level setting using a music source	56
Changing the INPUT MODE	56
Control of a different device with the accessory remote controller	57
Register the setup codes for your audio and video	57
Operating other devices	57
Setup code table (except for U.S.A. and Canada)	58
Setup code table (for U.S.A. and Canada only)	59
Keys which can be used to operate connected devices	63

Knowledge

Knowledge	64
DVD menu language code list	64
In case of difficulty	65
Specifications	68

Unpacking

Unpack the unit carefully and make sure that all the accessories are present.

If any accessories are missing, or if the unit is damaged or fails to operate, notify your dealer immediately. If your unit was shipped to you directly, notify the shipper immediately.

KENWOOD recommends that you retain the original carton and packing materials in case you need to move or ship the unit in the future.

Keep this manual handy for future reference.

Accessories

Please confirm that the following accessories are present.

Accessories packed with the main unit

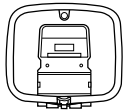
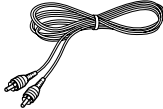
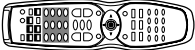
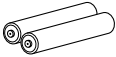
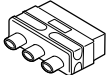
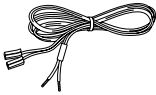
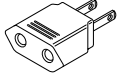
FM indoor antenna (1) 	Loop antenna (1) 	Video cord (1) 
Remote control unit (1) 	Batteries (R6/AA) (2) 	SCART plug adaptor (1) (Europe and U.K. only) 
Speaker cords (6) 	*AC plug adaptor (1) * Use to adapt the plug on the power cord to the shape of the wall outlet. (Accessory only for regions where use is necessary.) 	

Speaker model names

System	Front, center and surround speakers	Subwoofer
DVR-605	KS-306DV (Left speaker, right speaker, center speaker and surround speakers)	SW-06DV
DVR-6100 DVR-6100K	KSW-6100 (Left speaker, right speaker, center speaker, surround speakers and subwoofer)	

CHANNEL SPACE setting (Except for the U.S.A., Canada, U.K., Europe and Australia)

The space between radio channels has been set to the one that prevails in the area to which the system is shipped. However, if the current channel space setting does not match the setting in the area where the system is to be used, for instance when you move from area 1 or area 2 shown in the following table or vice versa, proper reception of AM/FM broadcasts cannot be expected. In this case, change the channel space setting in accordance with your area by referring to the following table.

Area	CHANNEL SPACE frequency
1 USA, Canada and South American countries	FM : 100 kHz AM : 10 kHz
2 Other countries	FM : 50 kHz AM : 9 kHz

Setting the CHANNEL SPACE

- ① Set the **POWER** key to standby (power off) mode.
- ② press the **STOP** key, the **▶▶** key and the **◀◀** key on main unit in this order.

Each operate step ②, switches the modes as follows.

- ▶ ① "FM100/AM10 kHz" STEP
- ◀ ② "FM 50 /AM 9 kHz" STEP

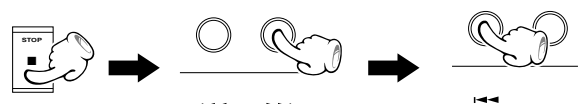

Please read all of the safety and operating instructions before operating this appliance. Adhere to all warnings on the appliance and in the instruction manual. Follow all the safety and operating instructions. These safety and operating instructions should be retained for future reference.

- 1. Power sources** – The appliance should be connected to a power supply only of the type described in the instruction manual or as marked on the appliance. If you are not sure of the type of power supply to your home, consult your appliance dealer or local power company. For appliances intended to operate from battery power, or other sources, refer to the instruction manual.
- 2. Power-cord protection** – Power-supply cords should be routed so that they are not likely to be walked on or pinched by items placed upon or against them, pay particular attention to cords at plugs, convenience receptacles, and the point where they exit from the appliance.

Never pull or stretch the cord.

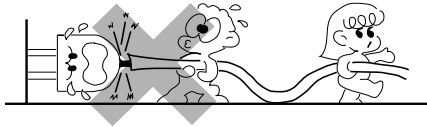

- 3. CAUTION – Polarization** – This appliance may be equipped with a polarized alternating-current line plug (a plug having one blade wider than the other). This plug will fit into the power outlet only one way. This is a safety feature. If you are unable to insert the plug fully into the outlet, try reversing the plug. If the plug should still fail to fit, contact your electrician to replace your obsolete outlet. Do not defeat the safety purpose of the polarized plug.

- 4. Ventilation** – Slots and openings in the cabinet are provided for ventilation and to ensure reliable operation of the appliance and to protect it from overheating, and these openings must not be blocked or covered. The appliance should be situated so that its location or position does not interfere with its proper ventilation.

To maintain good ventilation, do not put records or a table-cloth on the appliance. Place the appliance at least 10 cm away from the walls.

Do not use the appliance on a bed, sofa, rug or similar surface that may block the ventilation openings. This appliance should not be placed in a built-in installation such as a bookcase or rack unless proper ventilation is provided or the manufacturer's instructions have been adhered to.

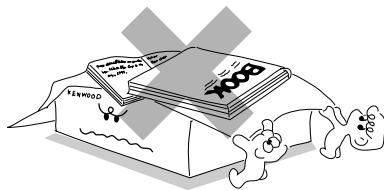

- 5. Water and moisture** – The appliance shall not be exposed to dripping and splashing- for example, near a bathtub, washbowl, kitchen sink, laundry tub, in a wet basement, or near a swimming pool, etc. Do not place an object containing liquid, such as a flower vase, on the appliance.

- 6. Temperature** – The appliance may not function properly if used at extremely low, or freezing temperatures. The ideal ambient temperature is above +5°C (41°F).
- 7. Heat** – The appliance should be situated away from heat sources such as radiators, heat registers, stoves, or other appliances (including amplifiers) that produce heat. Do not place a flaming object, such as a candle or lantern, on or near the appliance.
- 8. Electric shock** – Care should be taken so that objects do not fall and liquid is not spilled into the enclosure through openings. If a metal objects, such as a hair pin or a needle, comes into contact with the inside of this appliance, a dangerous electric shock may result. For families with children, never permit children to put anything, especially metal, inside this appliance.

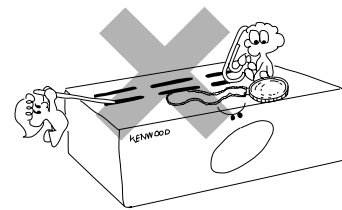

- 9. Enclosure removal** – Never remove the enclosure. If the internal parts are touched accidentally, a serious electric shock might occur.

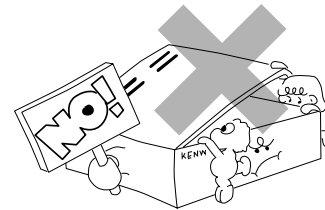

- 10. Magnetic fields** – Keep the appliance away from sources of magnetic fields such as TV sets, speaker systems, radios, motorized toys or magnetized objects.

- 11. Cleaning** – Unplug this appliance from the wall outlet before cleaning. Do not use volatile solvents such as alcohol, paint thinner, gasoline, or benzine, etc. to clean the cabinet. Use a clean dry cloth.

- 12. Accessories** – Do not place this appliance on an unstable cart, stand, tripod, bracket, or table. The appliance may fall, causing serious injury to a child or adult, and serious damage to the appliance. Use only with a cart, stand, tripod, bracket, or table recommended by the manufacturer, or sold with the appliance. Any mounting of the appliance should follow the manufacturer's instructions, and should use a mounting accessory recommended by the manufacturer. An appliance and cart combination should be moved with care. Quick stops, excessive force, and uneven surfaces may cause the appliance and cart combination to overturn.



13. Lightning – For added protection for this appliance during a lightning storm, or when it is left unattended and unused for long periods of time, unplug it from the wall outlet and disconnect the antenna or cable system. This will prevent damage to the appliance due to lightning and power-line surges.

14. Abnormal smell – If an abnormal smell or smoke is detected, immediately turn the power OFF and unplug the appliance from the wall outlet. Contact your dealer or nearest service center.

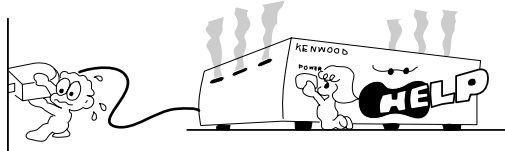

15. Damage requiring service – The appliance should be serviced by qualified service personnel when:

- A. The power-supply cord or the plug has been damaged.
- B. Objects have fallen, or liquid has been spilled into the appliance.
- C. The appliance has been exposed to rain or water.
- D. The appliance does not appear to operate normally by following the instruction manual. Adjust only those controls that are covered by the instruction manual as an improper adjustment of other controls may result in damage and will often require extensive work by a qualified technician to restore the appliance to its normal operation.
- E. The appliance has been dropped, or the enclosure damaged.
- F. The appliance exhibits a marked change in performance.

16. Servicing – The user should not attempt to service the appliance beyond that described in the instruction manual. All other servicing should be referred to qualified service personnel.

17. Outdoor antenna grounding – If an outside antenna is connected to the appliance, be sure the antenna system is grounded so as to provide some protection against voltage surges and built up static charges. Article 810 of the National Electrical Code ANSI/NFPA 70, provides information with respect to proper grounding of the mast and supporting structure, grounding of the lead-in wire to an antenna discharge unit, size of grounding conductors, location of antenna discharge unit, connection to grounding electrodes, and requirements for the grounding electrode. See Figure.

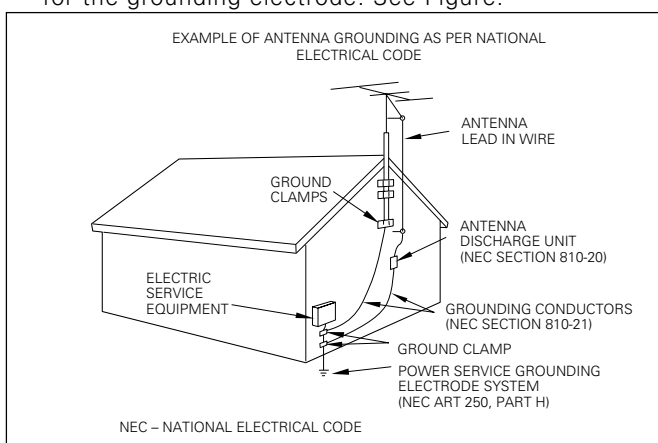

18. Power lines – An outside antenna system should not be located in the vicinity of overhead power lines or other electric light or power circuits, or where it can fall into such power lines or circuits. When installing an outside antenna system, extreme care should be taken to keep from touching such power lines or circuits as contact with them might be fatal.

19. AC outlets – Do not connect other audio equipment with a power consumption larger than that specified to the AC outlet on the rear panel. Never connect other electrical appliances, such as an iron or toaster, to it to prevent fire or electric shock.

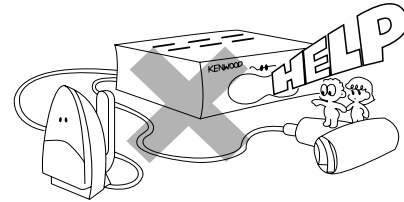

20. Overloading – Do not overload wall outlets, extension cords, or integral convenience receptacles as this can result in a risk of fire or electric shock.

21. Attachment – Do not use attachments not recommended by the appliance manufacturer as they may cause hazards.

22. Replacement parts – When replacement parts are required, be sure the service technician has used replacement parts specified by the manufacturer or have the same characteristics as the original parts. Unauthorized substitutions may result in fire, electric shock, or other hazards.

23. Safety check – Upon completion of any service or repairs to this appliance, ask the service technician to perform safety checks to determine that the appliance is in proper operating condition.

Notes:

1. Item 3 is not required except for grounded or polarized equipment.
2. Item 17 and 18 are not required except for units provided with antenna terminals.
3. Item 17 complies with UL in the U.S.A.

Special features

This document classifies the applications of each feature using the following marks

- DVD** : Description of a feature that can be used with DVD.
- CD** : Description of a feature that can be used with CD.
- VCD** : Description of a feature that can be used with VCD.

DVD *Higher video quality than S-VHS video and LaserDisc*

DVD *Higher audio quality than music CD*

DVD **CD** **VCD** *Graphical user interface (GUI) compatibility*

DVD *Versatile DVD playback features*

DVD **CD** *The DVR-605/DVR-6100/6100K offers DTS decoder.*

DVD **CD** **VCD** *Dolby Pro Logic II decoder.*

Reference

Caution on condensation

Condensation (of dew) may occur inside the unit when there is a great difference in temperature between this unit and the outside.

This unit may not function properly if condensation occurs. In this case, leave the unit for a few hours, and restart the operation after the condensation has dried up.

Be specially cautious against condensation in a following circumstances:

When this unit is carried from one place to another across a large difference in temperature, when the humidity in the room where this unit is installed increases, etc.

Note related to transportation and movement

Before transporting or moving this unit, carry out the following operations.

- ❶ Remove the disc from the unit.
- ❷ Press the ►/II key.

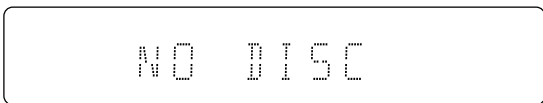

- ❸ Wait a few seconds and turn the unit OFF.

Memory backup function

Stored contents which are cleared in at least a week after power plug is unplugged from power outlet.

Amplifier section

- Last input selection
- Volume control value
- Surround setting
- ACTIVE EQ

Tuner section

- Receiving band
- Frequency
- Preset stations
- Tuning mode setting

DVD section

- Menu setup

Power status

WARNING NOTICE:

IN MOST CASES IT IS AN INFRINGEMENT OF COPYRIGHT TO MAKE COPIES OF TAPES OR DISCS WITHOUT THE PERMISSION OF THE COPYRIGHT OWNERS. ANYONE WISHING TO COPY COMMERCIALY AVAILABLE TAPES OR DISC SHOULD CONTACT THE MECHANICAL COPYRIGHT PROTECTION SOCIETY LIMITED OR THE PERFORMING RIGHTS SOCIETY LIMITED.

Maintenance of the Set

When the front panel, the case, etc. becomes dirty, wipe with a soft, dry cloth. Do not use thinner, alcohol, etc., as these can cause discoloration.

In regard to contact cleaners

Do not use contact cleaners because it could cause a malfunction. Be specially careful not to use contact cleaners containing oil, for they may deform the plastic component.

Disc handling precautions

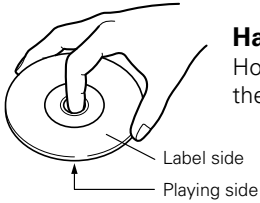

Handling

Hold the discs so that you do not touch the playing surface.

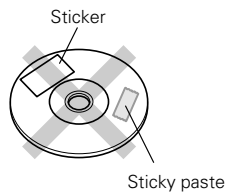

Do not attach paper or tape to either the playing side or the label side of the discs.

Cleaning

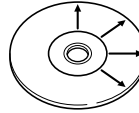

If there are fingerprint marks or foreign matter found on the disc, lightly wipe the disc with a soft cotton cloth (or similar) from the center of the disc outwards in a radial manner.

Storage

When a disc is not to be played for a long period of time, remove it from the player and store it in its case.

Never play a cracked or warped disc

During playback, the disc rotates at high speed in the player. Therefore, to avoid danger, never use a cracked or deformed disc or a disc repaired with tape or adhesive agent. Please do not use discs which are not round because they may cause a malfunction.

Disc accessories

The disc accessories (stabilizer, protection sheet, protection ring, etc.) which are marketed for improving the sound quality or protecting discs as well as the disc cleaner should not be used with this system because they may cause malfunction.

For the U.S.A.

CAUTION:

Use of controls or adjustments or performance of procedures other than those specified herein may result in hazardous radiation exposure.

In compliance with Federal Regulations, following are reproductions of labels on, or inside the product relating to laser product safety.

KENWOOD CORPORATION
2967-3, ISHIKAWA-CHO,
HACHIOJI-SHI,
TOKYO, JAPAN

KENWOOD CORP. CERTIFIES THIS EQUIPMENT CONFORMS TO
DHHS REGULATIONS NO. 21 CFR
1040.10, CHAPTER 1, SUBCHAPTER J.

Location: Back Panel

Note to CATV system installer

This reminder is provided to call the CATV system installer's attention to Article 820-40 of the NEC that provides guidelines for proper grounding and, in particular, specifies that the cable ground shall be connected to the grounding system of the building, as close to the point of cable entry as practical.

For the U.S.A.

FCC WARNING

This equipment may generate or use radio frequency energy. Changes or modifications to this equipment may cause harmful interference unless the modifications are expressly approved in the instruction manual. The user could lose the authority to operate this equipment if an unauthorized change or modification is made.

NOTE:

This equipment has been tested and found to comply with the limits for a Class B digital device, pursuant to Part 15 of the FCC Rules. These limits are designed to provide reasonable protection against harmful interference in a residential installation. This equipment may cause harmful interference to radio communications, if it is not installed and used in accordance with the instructions. However, there is no guarantee that interference will not occur in a particular installation. If this equipment does cause harmful interference to radio or television reception, which can be determined by turning the equipment off and on, the user is encouraged to try to correct the interference by one or more of the following measures:

- Reorient or relocate the receiving antenna.
- Increase the separation between the equipment and receiver.
- Connect the equipment into an outlet on a circuit different from that to which the receiver is connected.
- Consult the dealer or an experienced radio / TV technician for help.

Types of playable discs

The system using this unit does not only play music from CD but can also play the discs listed below to offer you high-quality entertainment of video of movies and live concerts.

Playable Disc		DVD		CD (CD-DA)		VCD
Logo mark on disc						
Disc size						
Played sides		One or both	One or both	One side only	One side only	One side only
Contents	Video + Audio	Approx. 41 min. (1 side, 1 layer) Approx. 75 min. (1 side, 2 layers) Approx. 82 min. (2 sides, 1 layer) Approx. 150 min. (2 sides, 2 layers)	Approx. 133 min. (1 side, 1 layer) Approx. 242 min. (1 side, 2 layers) Approx. 266 min. (2 sides, 1 layer) Approx. 484 min. (2 sides, 2 layers)	/		Max. 74 min.
	Audio	/		Max. 20 min., digital	Max. 74 min., digital	

Preparations

Unplayable discs

This player cannot play back any of the following discs.

<ul style="list-style-type: none"> ● DVD-ROM discs ● DVD-R/DVD-RAM/DVD-RW discs ● VSD discs ● CDV discs (only the audio part can be reproduced.) ● CD-ROM discs (except MP3 (ISO 9660 level 1 format) disc.) 	<ul style="list-style-type: none"> ● CD-G/CD-EG/CD-EXTRA discs (only the audio can be reproduced.) ● Photo CD discs (never attempt to play them.) ● S-VCD discs ● CD discs without the CD-DA logo mark may be unplayable
---	--

Icons on the DVD discs

Icon	Description
	Indicates the region code where the disc can be played.
	Number of voice languages recorded with the audio function. The number in the icon indicates the number of voice languages. (Max. 8 languages)
	Number of subtitle languages recorded with the subtitle function. The number in the icon indicates the number of subtitle languages. (Max. 32 languages)
	Number of angles provided by the angle function. The number in the icon indicates the number of angles. (Max. 9 angles)
	Aspect ratios that can be selected. "LB" stands for Letter Box and "PS" for Pan/Scan. In the example on the left, the 16:9 video can be converted into letter box video.

Every player of this model has a certain region code assigned to it based on the country where the player is used. When the player is used to play back DVD discs, it can only play the DVD discs carrying the region codes matching the region code of the player.

The region code for this player is described on the rear panel of the player.

Region codes in the world

The DVD players are given a region code according to the country or area it is marketed, as shown in the following map.

Preparations

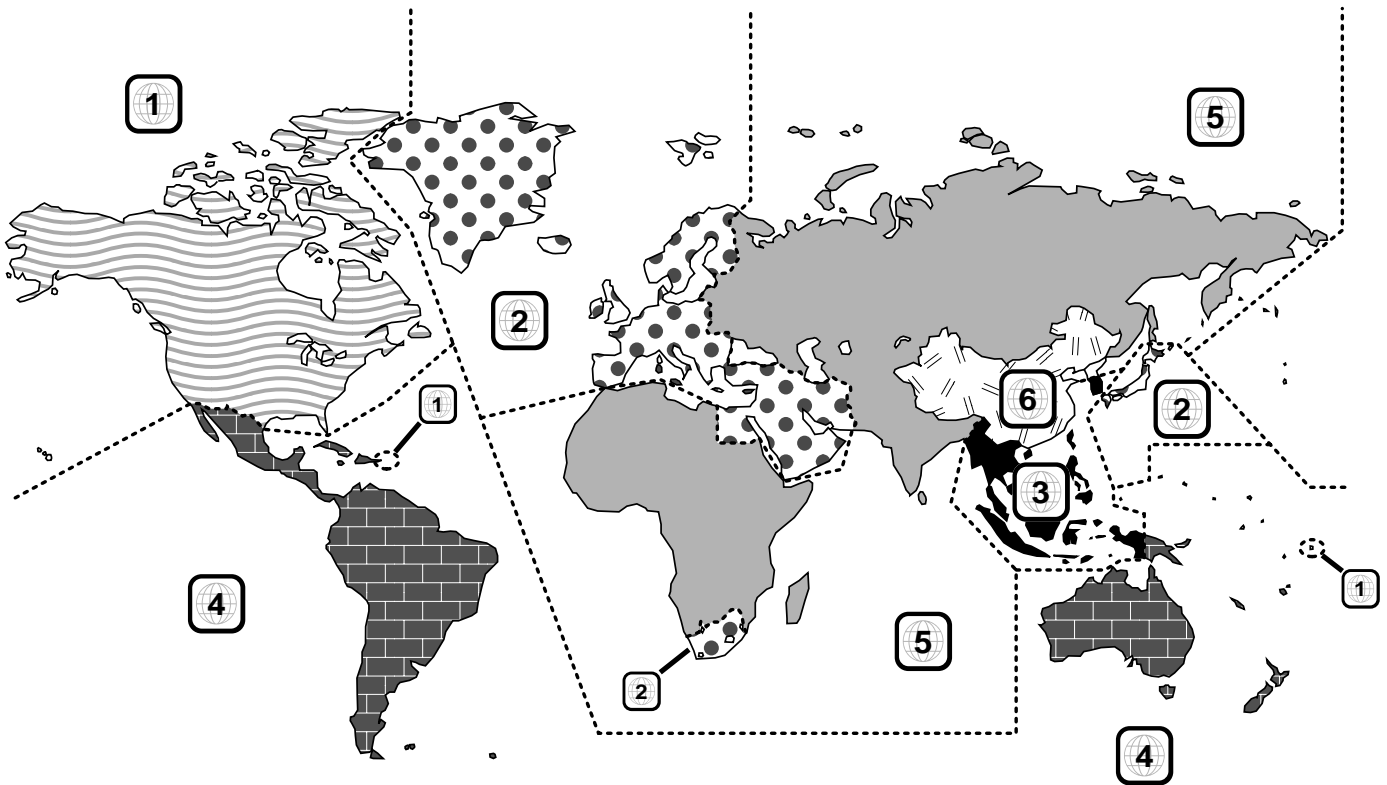

Examples of TV screen display of each video format

When your TV is switchable between PAL/NTSC

Try play a disc. If the picture is black and white or as shown on the right, stop playback and switch the screen display formats of this unit and the TV to another format. This will improve the played picture quality.

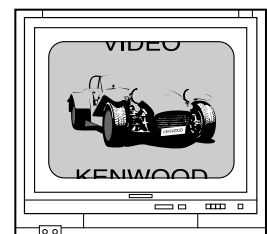
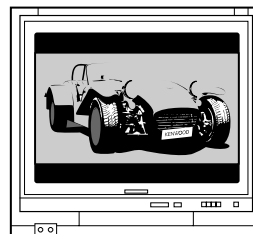

When your TV is compatible only with the PAL format

With certain discs, the playback picture may have black spaces above and below it (as shown on the right). This is because the disc has been recorded in the NTSC format. The screen may be somewhat hard to see but this is not malfunction.

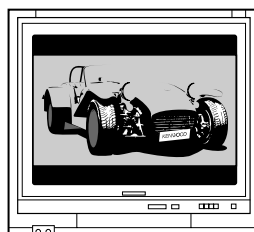

When your TV is compatible only with the NTSC format

With certain discs, the playback picture may be cut above and below it (as shown on the right). This is because the disc has been recorded in the PAL format. The screen may be somewhat hard to see but this is not malfunction.

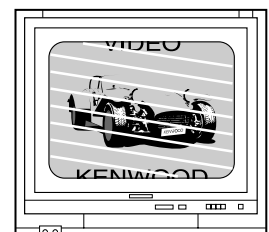









The video signals used to display TV pictures and video disc pictures are mainly based on two types of signal formats (PAL and NTSC), which are assigned to each country or area as shown on the right. As a result, it is required to select discs according to the video format used with your TV monitor (in your country or area).

TV formats of major countries

TV Format	Major Countries & Areas
NTSC	Japan, Taiwan, Korea, U.S.A., Canada, Mexico, Philippines, Chile, etc.
PAL	China, U.K., Germany, Australia, New Zealand, Kuwait, Singapore, etc.

Video formats of DVD discs that can be played on this unit

Region code table

	District ①	District ②-1	District ②-2	District ②-3	District ③	District ④-1	District ④-2	District ⑤	District ⑥
Area or Country Name, Region Code	North America 	Europe 	Japan 	Middle East 	Southeast Asia 	Oceania 	South America 	Russia 	China 

Set the video formats of the DVD discs to be played on this unit as described below.

1 Check the video format(s) used by your TV monitor.

- Refer to the operating instructions of your TV monitor for details.

2 Select DVD discs recorded with the playable video format by referring to the following table.

- See the region code table on this page for details on districts ① to ⑥.

Your TV format	Playable Disc Formats								
	District ①	District ②-1	District ②-2	District ②-3	District ③	District ④-1	District ④-2	District ⑤	District ⑥
NTSC only	NTSC	NTSC PAL*	NTSC	NTSC PAL*	NTSC PAL*	NTSC PAL*	NTSC	NTSC PAL*	NTSC PAL*
PAL only	NTSC*	NTSC* PAL	NTSC*	NTSC* PAL	NTSC* PAL	NTSC* PAL	NTSC*	NTSC* PAL	NTSC* PAL
NTSC/PAL switchable	NTSC	NTSC PAL	NTSC	NTSC PAL	NTSC PAL	NTSC PAL	NTSC	NTSC PAL	NTSC PAL



Normal video may not be reproduced when a disc recorded with the video format marked * in the above table is played. See "Examples of TV screen display of each video format" for details.

3 When your TV is switchable between NTSC and PAL,

- Districts ①, ②-2 and ④-2: Set the TV to NTSC.
- Districts ②-1, ④-1 and ⑤: Set the TV to PAL.
- Districts ②-3, ③ and ⑥: Set the TV according to each disc to be played.

Restrictions due to difference between discs

Some DVD discs can be played only in certain playback modes according to the intentions of the software producers. As this player plays discs according to their intentions, some functions may not work as intended by you. Please be sure to read the instructions provided with each disc. When an inhibition icon is displayed on the TV screen connected to the player, it indicates that the disc being played is under the restriction as described above.

Inhibition icon



Make connections as shown below.
When connecting the related system components, refer also to the instruction manuals of the related components.

Caution:
Do not plug in the power lead until all connections are completed.

Caution

Be sure to adhere followings. Or proper ventilation will be blocked causing damage or fire hazard.

- Do not place any objects impairing heat radiation onto the top of unit.
- Leave a space around the unit (from the largest outside dimension including projection) equal or greater than, shown below.

Top panel : 50 cm Side panel : 10 cm Back panel : 10 cm

Malfunction of microcomputer

If operation is not possible or erroneous display appears even though all connections have been made properly, reset the microcomputer referring to "In case of difficulty".

- 65

Loudspeakers

Speaker terminal

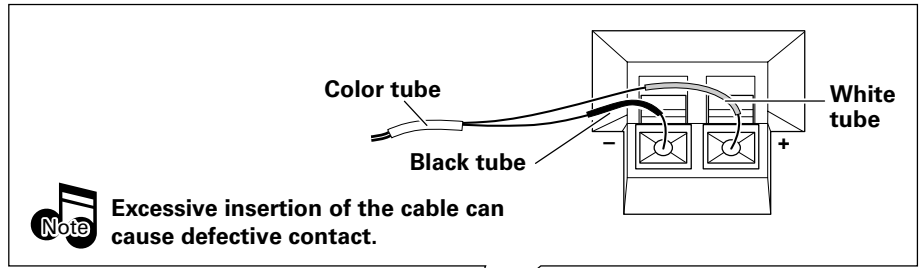
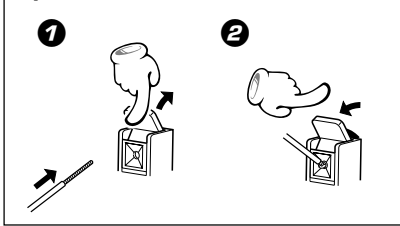

The figure shows an example for the speakers for DVR-605.

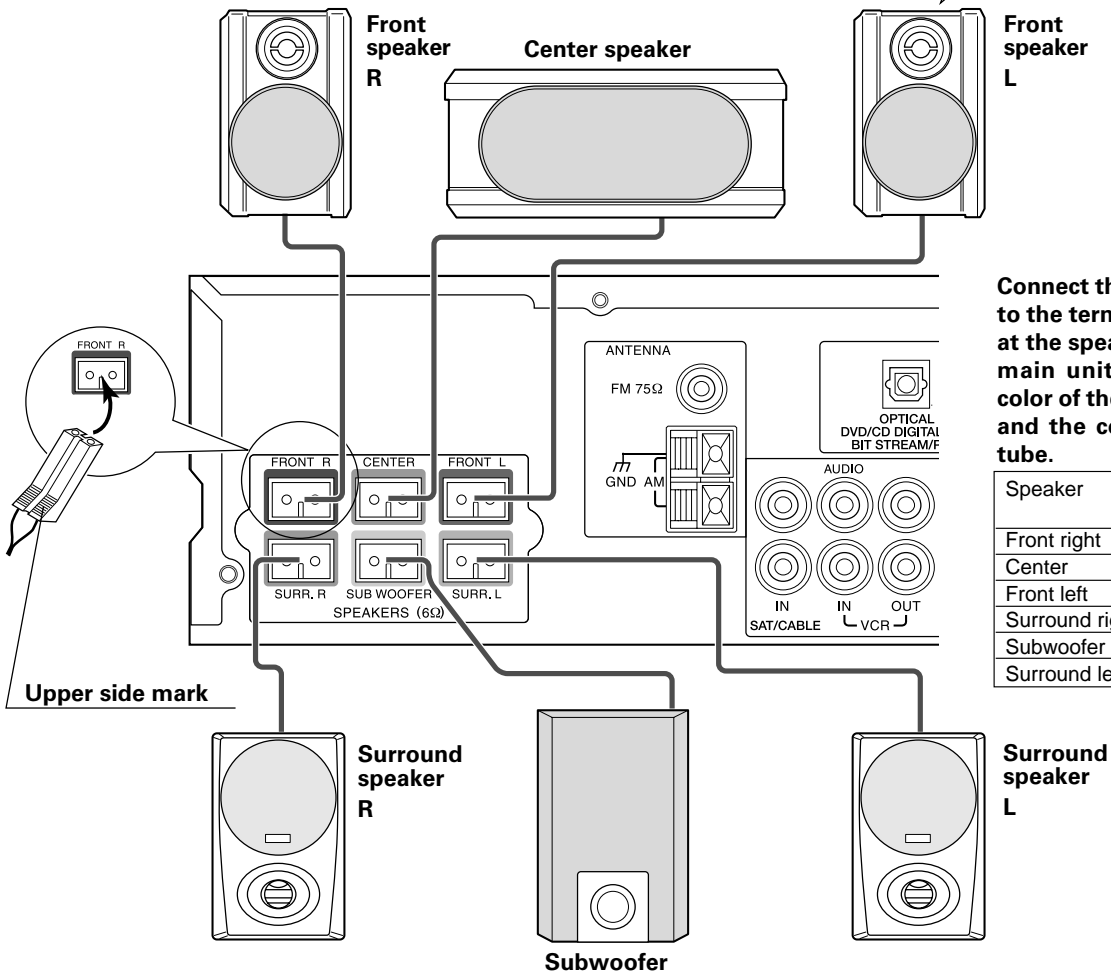

Connect the speaker cable terminals to the terminals with the same color at the speaker terminal panel on the main unit. Connect matching the color of the speaker terminal (+ side) and the color of the speaker cable tube.

Speaker	Color of the speaker terminal panel on the main unit
Front right	Red
Center	Green
Front left	White
Surround right	Gray
Subwoofer	Purple
Surround left	Blue

Speakers for DVR-6100/6100K

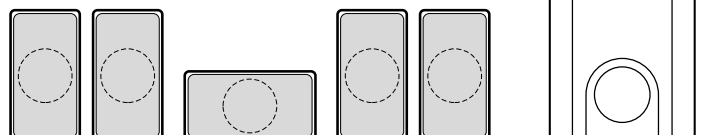

The power in this equipment will not be completely cut off from the AC wall outlet when the main switch is turned OFF.

⚠ Caution : Read this page carefully to ensure safe operation.

AM loop antenna

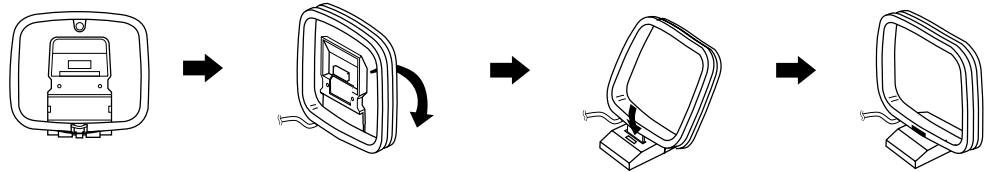

AM loop antenna connection

The supplied antenna is for indoor use. Place it as far as possible from the main system, TV set, speaker cords and power cord, and set it to a direction which provides the best reception.

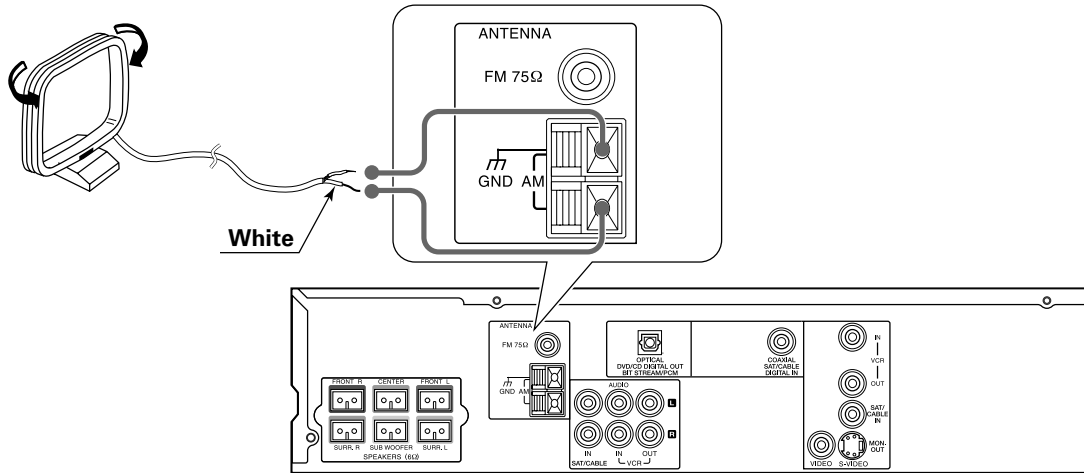

FM antenna

FM indoor antenna connection

The accessory antenna is for temporary indoor use only. For stable signal reception we recommend using an outdoor antenna. Remove the indoor antenna if you connect one outdoors.

- ❶ Connect to the antenna terminal.
- ❷ Locate the position providing good reception condition.
- ❸ Fix the antenna.

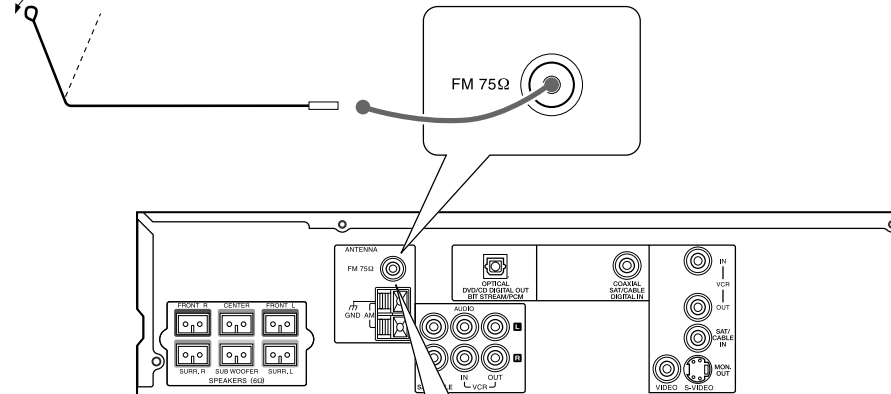

FM outdoor antenna (commercially available)

Lead the 75 Ω coaxial cable connected to the FM outdoor antenna into the room and connect it to the FM 75 Ω terminal.

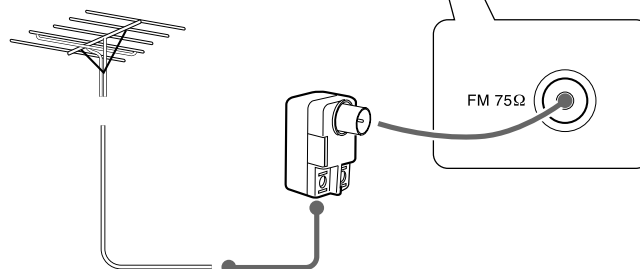

Connecting to a TV

Depending on the input switching, the output from the MONITOR OUT terminal will be one of the following signals. Please note that a different signal type will not be put out.

S-VIDEO terminal : S-video signals from the internal DVD player.

VIDEO terminal : Composite video signal connected to the (VIDEO) VCR IN, the (VIDEO) SAT/CABLE IN, or the FRONT AUX VIDEO terminal.

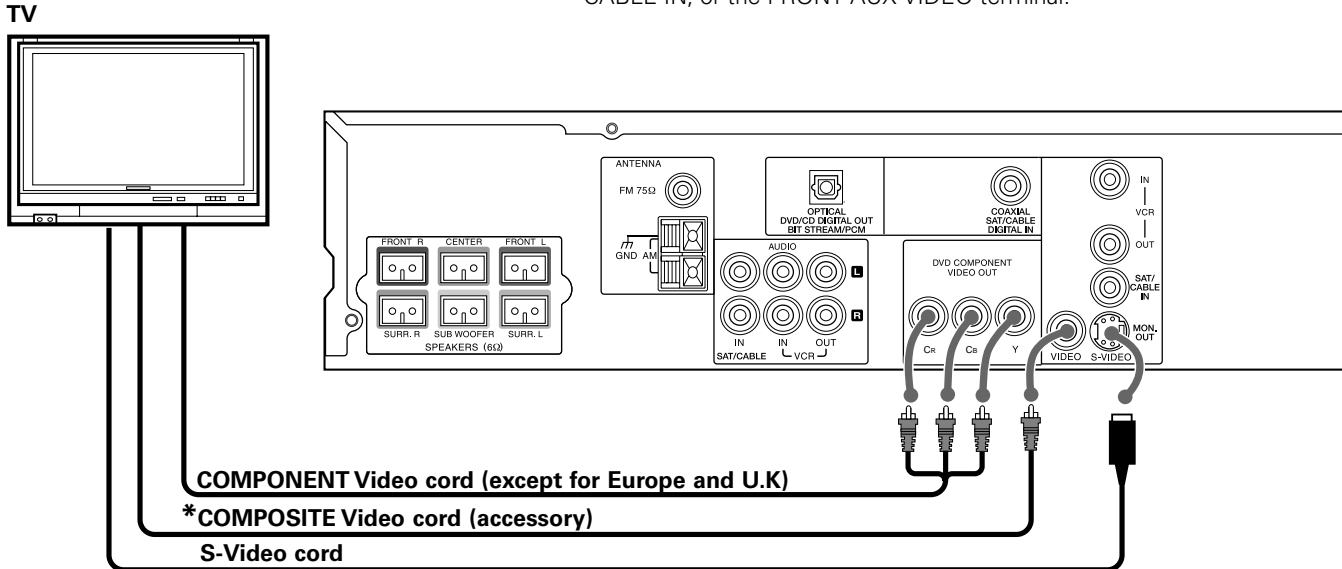

COMPONENT connection corresponds only to some areas.

When the TV has a COMPONENT terminal, the DVD image will be played back with higher picture quality in case of COMPONENT connection. Connect the S-video or the COMPOSITE video cable also in this case.

If your TV has a progressive scan feature - 25

*** For Europe and U.K. only**

If your TV set has a SCART terminal, connect the accessory SCART plug to the SCART terminal of the TV and connect the COMPOSITE video cord.

Connecting to a Satellite Tuner

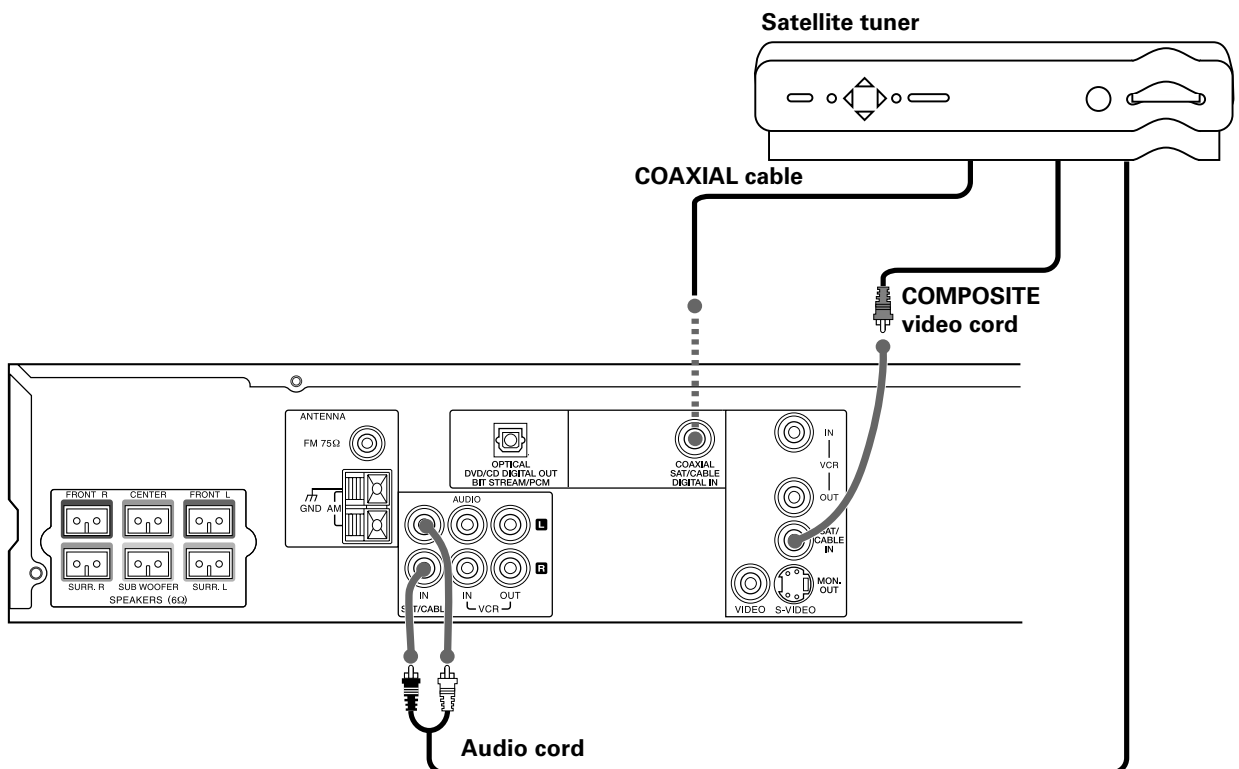

Connecting to Audio video equipments

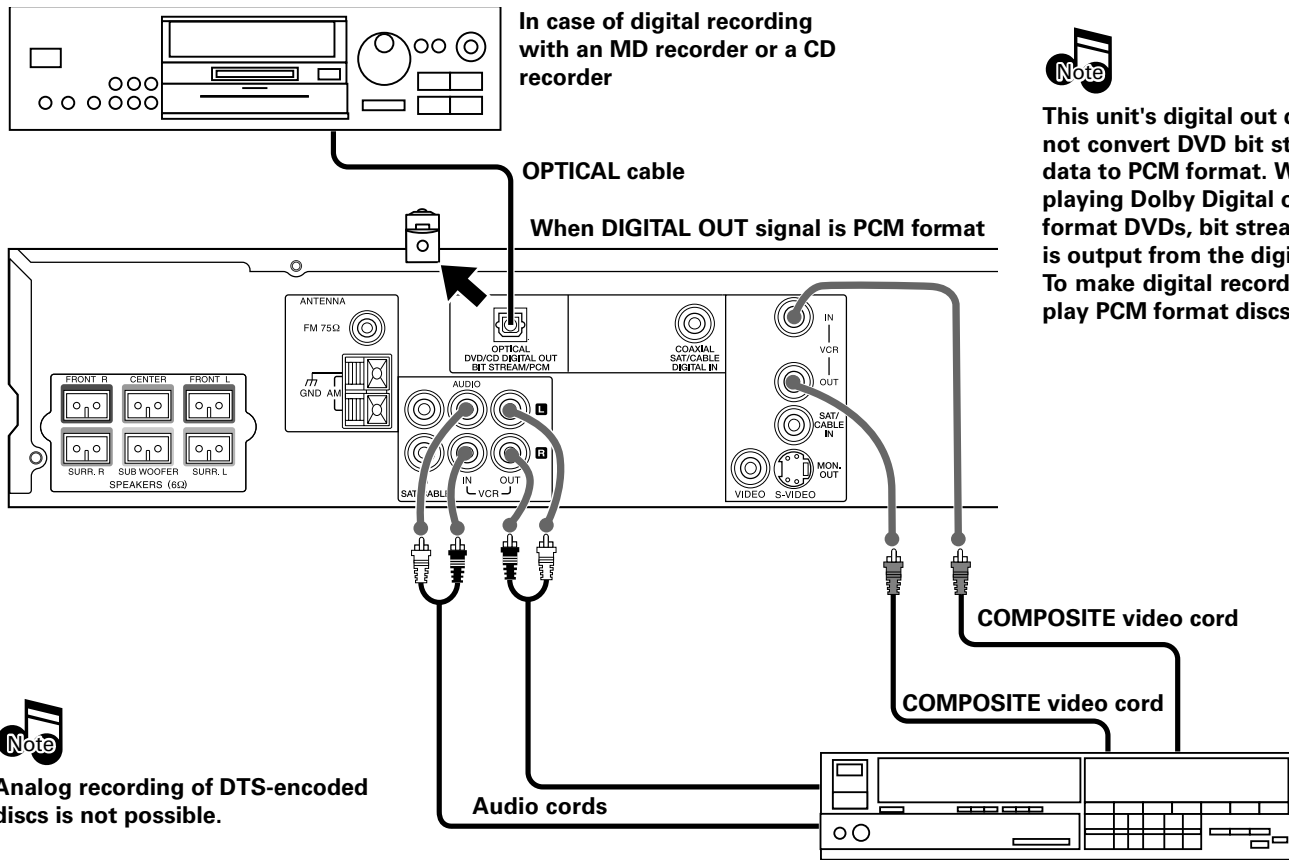

This unit's digital out does not convert DVD bit stream data to PCM format. When playing Dolby Digital or DTS format DVDs, bit stream data is output from the digital out. To make digital recordings, play PCM format discs.

Note

Analog recording of DTS-encoded discs is not possible.

Connecting a Camcorder or Video game machine

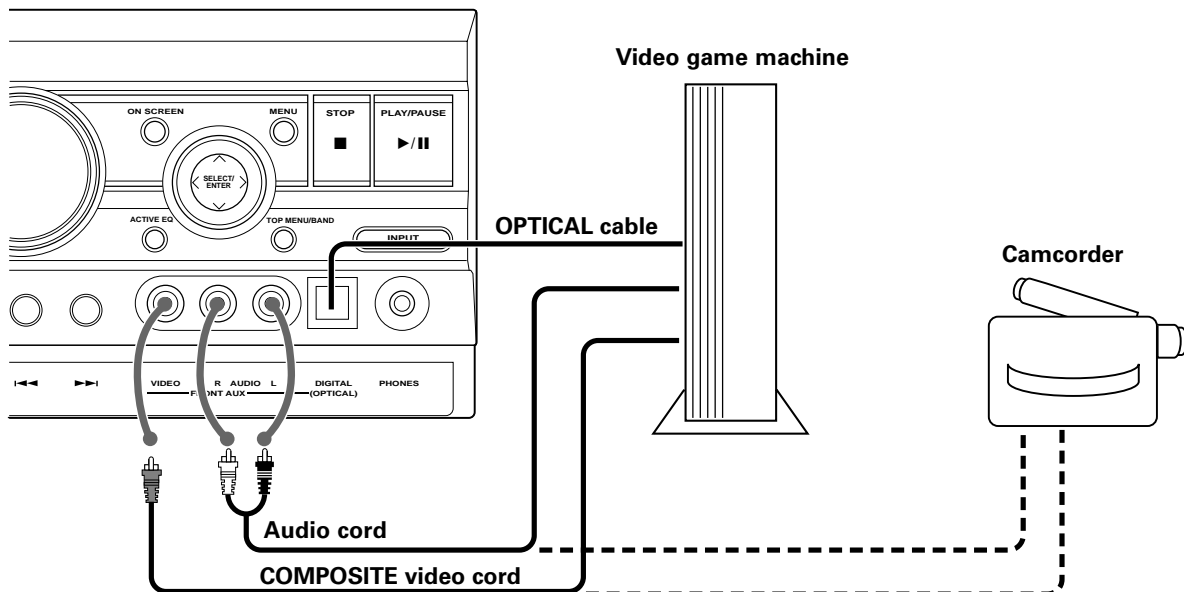

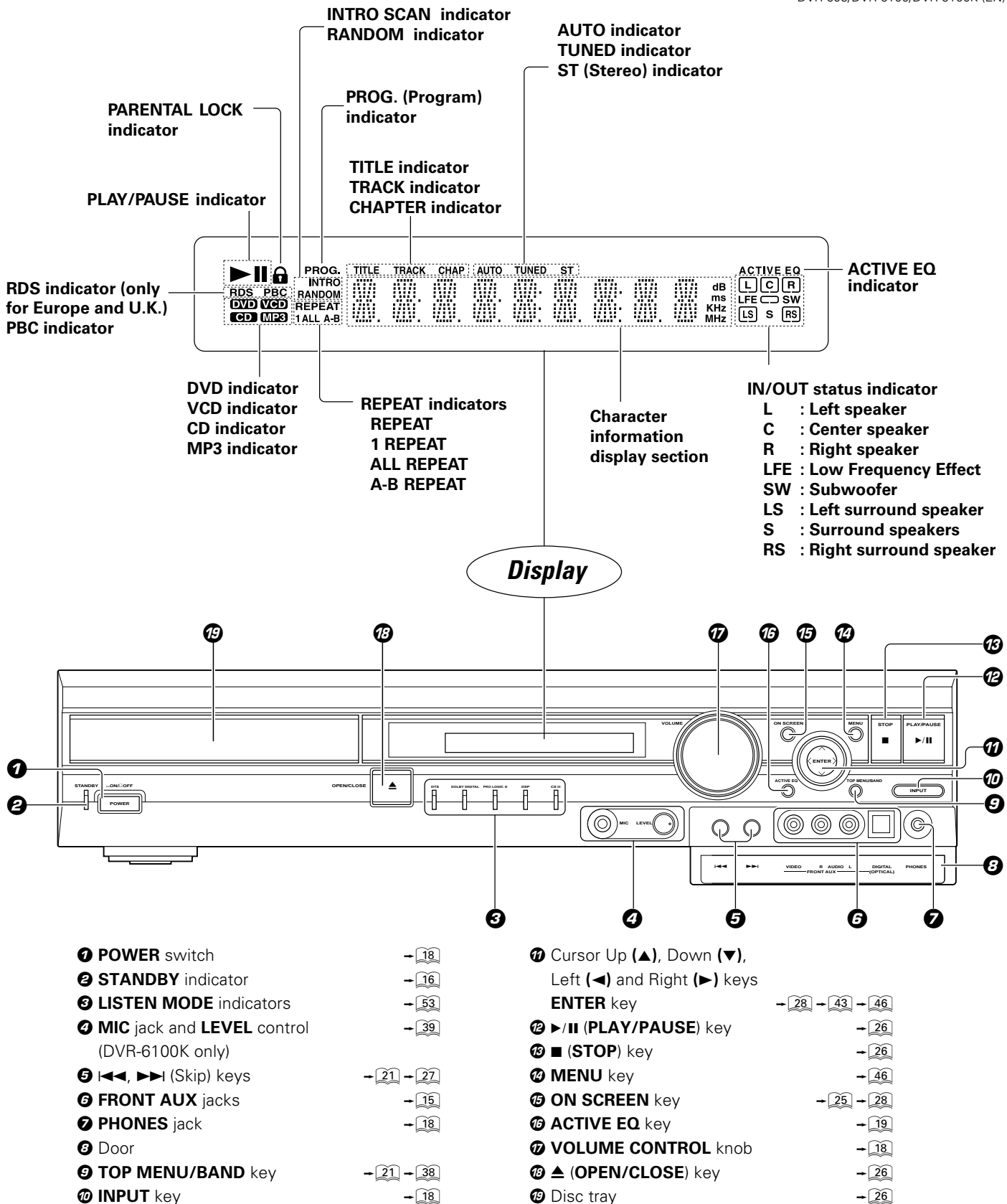

STANDBY

The **STANDBY** indicator lights when the power cable is plugged into an outlet and the **POWER** switch is set to **ON**. While the standby indicator is lit, a small amount of power is supplied to the system to back up the memory. When the **POWER** key on the remote control unit is pressed in **STANDBY** status, the **STANDBY** indicator goes out and the main unit reaches operation status. When the **POWER** switch is set to **OFF** in operation status, the unit will return to operation status when the **POWER** switch is set to **ON** again. When the **POWER** switch is set to **OFF** in **STANDBY** status, the unit will return to **STANDBY** status when the **POWER** switch is set to **ON** again.

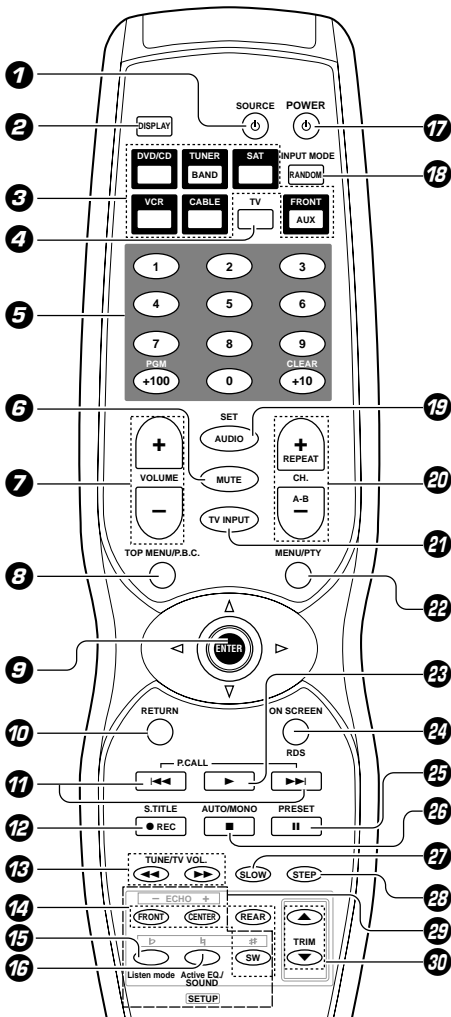

The keys on the remote control unit with the same names as on the main unit have the same function as the keys on the main unit.

- ① SOURCE ϕ key - 57 - 63
- ② DISPLAY key - 20
- ③ INPUT SELECTOR keys - 18
- ④ TV key - 63
- ⑤ Numeric keys (0 - 9, +10, +100) - 22 - 27 - 63
- PGM key - 35
- CLEAR key - 45
- ⑥ MUTE key - 18
- ⑦ VOLUME keys - 18
- ⑧ TOP MENU key / P.B.C. key - 26
- ⑨ Cursor Up (\blacktriangle), Down (\blacktriangledown), Left (\blacktriangleleft) and Right (\blacktriangleright) keys
- ENTER key - 28 - 43 - 46
- ⑩ RETURN key - 46
- ⑪ \blacktriangleleft / \blacktriangleright (Skip) keys
- P.CALL keys - 21 - 27
- ⑫ \bullet REC (record) key - 63
- S.TITLE key - 30
- ⑬ \blacktriangleleft / \blacktriangleright (Search) keys / TUNE keys - 27
- / TV. VOL. keys - 21
- ⑭ Speaker select keys - 63
- ⑮ Listen mode key - 56
- ⑯ Active EQ./SOUND key - 19
- SETUP key - 54
- ⑰ POWER ϕ key - 17
- ⑱ INPUT MODE / RANDOM key - 56 - 34
- ⑲ SET / AUDIO key - 63 - 39
- ⑳ CH. UP / DOWN keys / REPEAT A-B keys - 63
- ㉑ TV INPUT key - 63
- ㉒ MENU key - 46
- PTY key (Europe and U.K. only) - 24
- ㉓ \blacktriangleright (play) key - 26
- ㉔ ON SCREEN key - 28
- RDS key (Europe and U.K. only) - 23
- ㉕ \parallel (pause) key - 26
- PRESET key - 22
- ㉖ \blacksquare (stop) key - 26
- AUTO/MONO key - 21
- ㉗ SLOW key (DVR-605/6100) - 27
- SLOW / STEP key (DVR-6100K) - 27
- ㉘ STEP key (DVR-605/6100) - 27
- SHIFT key (DVR-6100K) - 27 - 39
- ㉙ Karaoke keys (DVR-6100K only) - 40
- ECHO keys - 39
- Key Control keys - 39
- ⑳ TRIM / Up (\blacktriangle), Down (\blacktriangledown) keys - 19 - 20 - 54

Model : RC-R0624 (for USA and Canada), RC-R0624E (for Europe and U.K.), RC-R0624K (for other countries)
Infrared ray system

Loading batteries

① Remove the cover.

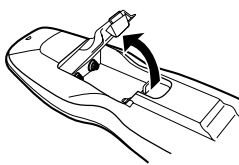

② Insert batteries.

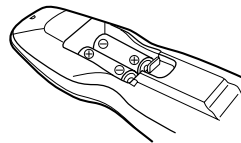

③ Close the cover.

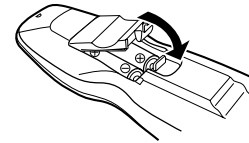

- Insert two R6 ("AA") batteries following the polarity indications.

Operation

Insert the power plug into a power outlet, press the POWER switch of the main unit to ON, then press the POWER key on the remote control.

- When pressing more than one remote control keys successively, press the keys securely by leaving an interval of 1 second or more between pressing of keys.

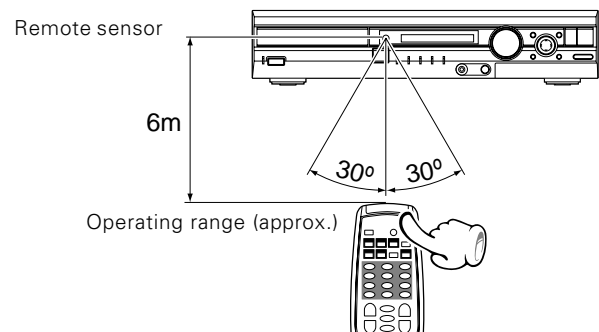

1. The provided batteries are intended for use in operation checking, and their service life may be short.
2. When the remote controllable distance becomes short, replace both of the batteries with new ones.
3. If direct sunlight or the light of a high-frequency fluorescent lamp (inverter type, etc.) is incident to the remote sensor, malfunction may occur. In such a case, change the installation position to avoid malfunction.

Preparation

MAIN UNIT

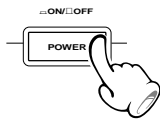

- set the **POWER** switch to the ON (■) position.

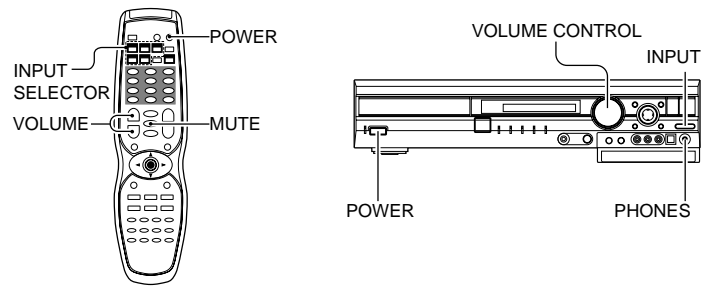

Basic use method

1 Selecting the desired input

MAIN UNIT

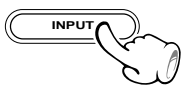

REMOTE

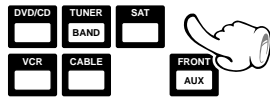

Switching is done as follows when the **INPUT** key of the main unit is pressed. (The parenthesized part shows an operating example.)

- ① Tuner (frequency display)
- ② VCR (VCR → ANALOG → VCR)
- ③ SAT/CABLE (SAT/CABLE → AUTO → SAT/CABLE)
- ④ FRONT AUX (FRONT → OPTICAL → FRONT)
- ⑤ DVD/CD

2 Volume adjustment

MAIN UNIT

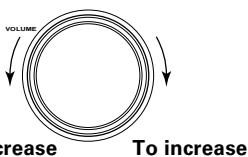

REMOTE

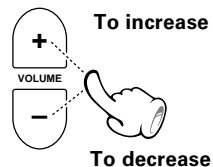

- When one of the keys on the left is pressed while **STANDBY** mode, the power will be switched on automatically and the input will be selected.
- The power will be switched on and the respective operation will be performed also when the **OPEN/CLOSE** key, the **PLAY/PAUSE** key or the **BAND** key on the main unit is pressed during **STANDBY** mode.
- When a disc is set in the disc tray and the **DVD CD** key is pressed, disc playback will start automatically.

In case of operation with the remote control unit, first select the input or device to be operated with the **INPUT SELECTOR keys then perform the desired operation. The present mode of the remote control unit may not coincide with the equipment to be operated.**

- When using the remote to select SAT or CABLE;
SAT (SAT → AUTO → SAT)
CABLE (CABLE → AUTO → CABLE)

Note The input mode can be switched with **SAT/CABLE** and **FRONT AUX**. Refer to "Changing the **INPUT MODE**" → 56

Normally "MAX" is displayed when the volume settings set to the maximum value. If you have adjusted the speaker level above 0 db with the **TRIM** key (→ 54), "MAX" will not be displayed.

Muting the sound temporarily

Remote control unit only



- Press the **MUTE** key.
- Press again to resume the original volume.
- The sound muting is also cancelled when the volume is controlled.

Listening through headphone

Insert the headphone plug into the **PHONES** jack.

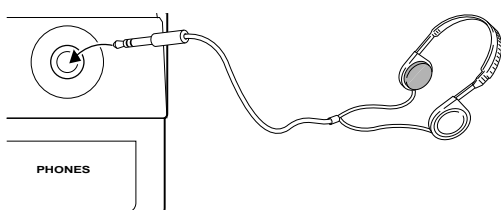

This unit offers various surround modes, but it switches automatically to stereo mode when headphones are connected.

To open the door, pull the lower part on the right side of the main unit.

- **The sounds from all speakers are cut off.**

Changing the Tone

This unit is equipped with various preset equalizers, so that various sounds can be enjoyed. In addition, it has an ACTIVE EQ. function for one-touch equalization.

Selecting the DSP mode

Five different sounds are preset in DSP mode. Please select the type you like.
 DSP mode can be selected only at the time of a PCM source (normal music CD, MP3 file, etc.).

REMOTE

Press the Listen mode key repeatedly

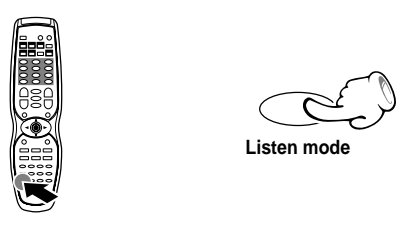

Listen mode

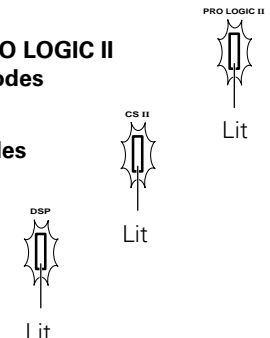
- Each press switches the mode
 (At the time of music CD)
- ① DOLBY PL II MOVIE
 - ② DOLBY PL II MUSIC
 - ③ DOLBY PRO LOGIC
 - ④ CS II MUSIC
 - ⑤ CS II CINEMA
 - ⑥ CS II MONO
 - ⑦ ARENA
 - ⑧ JAZZ CLUB
 - ⑨ THEATER
 - ⑩ STADIUM
 - ⑪ DISCO
 - ⑫ STEREO
- PRO LOGIC II modes (①-③)
 CS II modes (④-⑥)
 DSP modes (⑦-⑫)
- 

ACTIVE EQ.

Press the ACTIVE EQ key repeatedly

MAIN UNIT

REMOTE

ACTIVE EQ

Active EQ./SOUND

TRIM

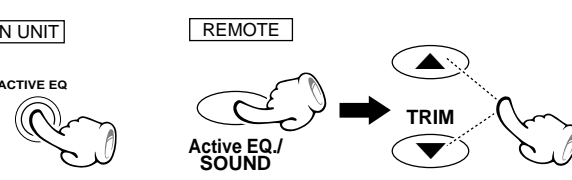

Each press switches the ACTIVE EQ.

- ① CINEMA (ACTIVE EQ. lit)
- ② MUSIC (ACTIVE EQ. lit)
- ③ OFF

- In some cases, the unit may not enter the ACTIVE EQ mode by pressing the ACTIVE EQ key once. In this case, press the key one more time.

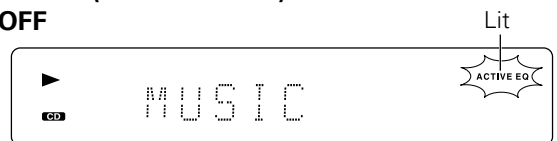

Selecting the NIGHT (MID NIGHT) mode. (Dolby Digital only)

Any time you don't want to experience the loud and soft volume extremes of recorded sound (for example, late at night), use NIGHT function to reduce volume extremes.

REMOTE

1 Press the SOUND key.



Active EQ./SOUND

2 Press the TRIM (▲/▼) key.



Displayed NIGHT OFF (or NIGHT ON).

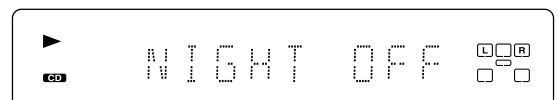

Each press switches the mode

- ① NIGHT ON
- ② NIGHT OFF

TREBLE CONTROL (Normal music CD, VCD and tuner only)

REMOTE

1 Press the Listen mode key



Listen mode

2 Press the SOUND key



Active EQ./
SOUND

3 Select treble level

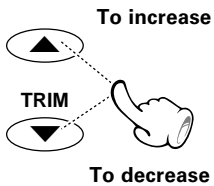

Set to STEREO mode. (The TREBLE CONTROL can be adjusted only STEREO mode)

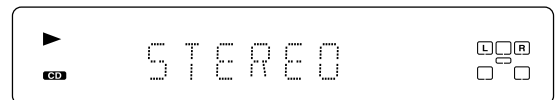

TRBL is displayed.

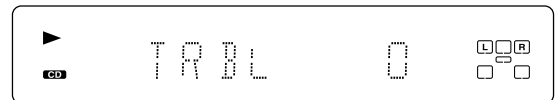

Operation is not possible with DOLBY DIGITAL and DTS source.

Each press switch the TRBL level

- The treble level can be adjusted between +10 and -10.

Dimmer

The brightness of the display can be changed in 3 levels. Adjust the brightness as you like by pressing the DISPLAY key.

Press the DISPLAY key for more than 2 seconds

REMOTE



It is also possible to receive them by one-touch operations by storing up to 30 stations in the preset memory. (- 22)

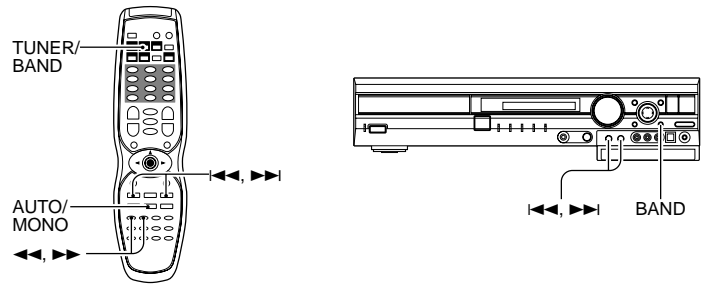

1 Select the TUNER input

MAIN UNIT

REMOTE

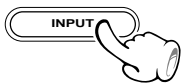

When using the main unit, press INPUT repeatedly to select the tuner. When the BAND key on the remote is pressed, this unit will be switched on automatically.

2 Select the broadcast band

MAIN UNIT

REMOTE

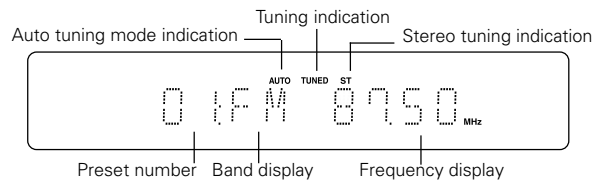

Each press changes the band.

- ① FM
- ② AM

3 Select a tuning mode

REMOTE

AUTO/MONO

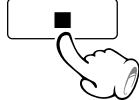

Each press switches the mode

- ① auto tuning mode
- ② manual tuning mode



When the TUNE keys are pressed in AUTO mode, a station will be tuned in automatically and tuning will stop. Stereo reception will be made automatically when a stereo broadcast with sufficient signal strength is received.

4 Select a station

P.CALL (preset call)

MAIN UNIT

REMOTE

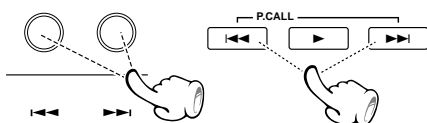

Press the <<<<, >>>> keys to select a preset station.

AUTO (auto tuning)

REMOTE

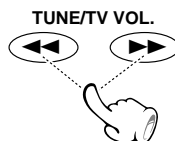

Press the TUNE key to receive the next tuned station automatically

MANUAL (manual tuning)

REMOTE

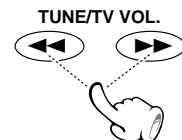

Each time a key is pressed, the frequency is changed by one step. When a key is pressed continuously, the frequency changes continuously. Use the manual tuning mode when reception is noisy due to weak reception. (In the manual mode, stereo broadcasts are received in monaural.)

You can store up to 30 stations in the memory and recall with a single touch of the key.

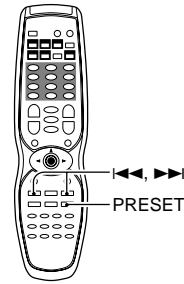

Storing the broadcast stations (one-by-one presetting)

1 Select a station (auto tuning or manual tuning) 

2 Press the PRESET key

REMOTE



3 Select the desired preset number

REMOTE

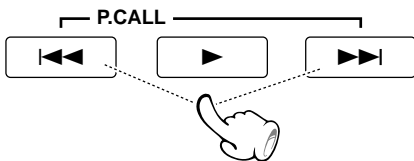

4 Press the PRESET key

REMOTE



Repeat steps **1** to **4** to preset other stations.

Presetting can be done with mixing of FM and AM stations.
(Example)

- 01: FM 90.00
- 02: AM 810
- 03: FM 88.00

Blinks

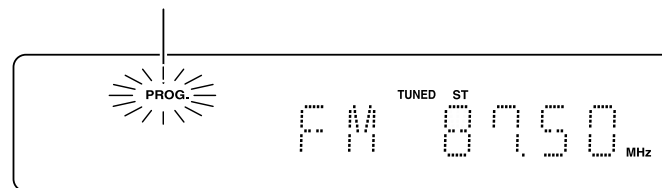

Please perform the next operation while the indicator is blinking.

In case of input with the number keys, a preset number will be decided simply by input of a 2-digit number without pressing the ENTER key.

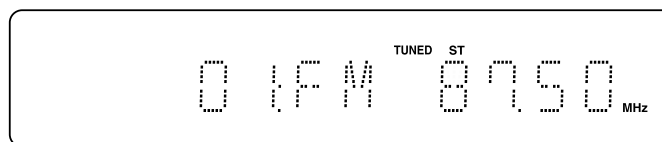
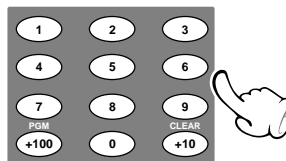

RDS is a system which transmits useful information (digital data) for FM broadcasts together with the broadcast signal. Tuners and receivers designed for RDS reception can extract the information from the broadcast signal for use with various functions such as automatic display of the station name.

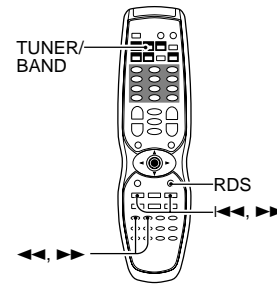

Using RDS function (for Europe and U.K. only)

Functions made possible with RDS

PS (Program Service Name) Display :

When an RDS broadcast is received, the station name is automatically displayed.

PTY (Program Type Identification) Search :

The tuner automatically searches for a station which is currently broadcasting a specified program type (genre).

CT (Clock Time) :

Decodes the real time clock from the FM frequency.

RT (Radio text) :

Displays the radio text data transmitted by some RDS stations when you select the **RT** mode.

Using the RDS Display function

1 Select the FM broadcast station

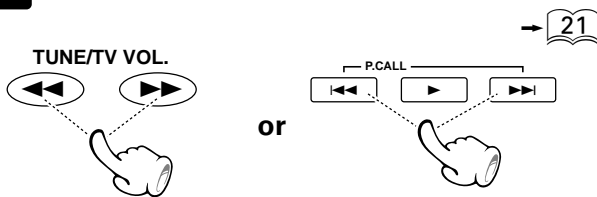

2 Press the RDS key

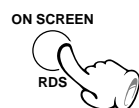

Each press switches the display mode as follows.

- ① PS NAME display
- ② PTY display
- ③ CT display
- ④ RT display
- ⑤ Current FM frequency display

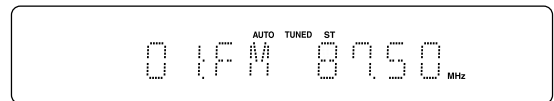

PS NAME

- If the PS information is being received, the PS name (**BBC**, **AFO**, **NDR**, etc.) is shown on the display.
- If the PS information is not received, the original FM frequency is shown.
- Even though no **RDS** key is pressed, the reception of PS information ensures the PS name is displayed.

CT display

- If the CT information will take up to 2 minutes to be decoded therefore the clock is not displayed immediately.
- If the CT information is not received, the **"NO CT"** is shown on the display.
- The CT clock does not update the system clock.

RT display

- Text data accompanying the RDS broadcast scrolls across the display (64 characters can be displayed).

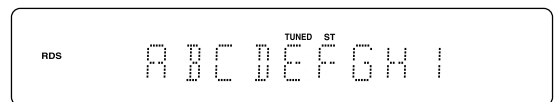

← Scrolled display

- If the RT information is not received, the **"NO RT"** is shown on the display.

PTY function (for Europe and U.K. only)

The PTY information is composed of an identification symbol, which helps the FM radio to recognize the program type of each FM station.

The 29 PTY modes are shown in the display by pressing the PTY key.

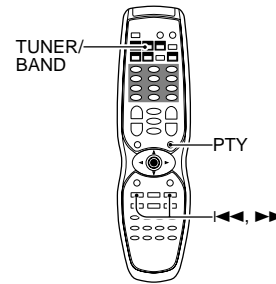

Using the PTY search function

1 Select the FM band



2 Press the PTY key



- The PTY MODE (POP M, ROCK M etc.) appears on the display.

3 Press the P.CALL (|<<</>>>|) keys to select the desired program type.

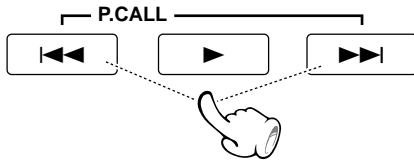

4 When the program type is selected, press the PTY key.



- Auto-search the station sequentially
- Press again during search to cancel.

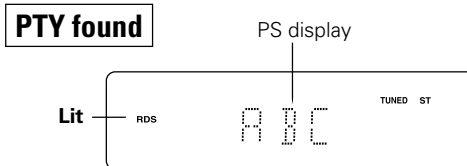

PTY not found

After display of NO PTY, return is made to the normal display.

RDS Program types

Program Type Name	Receiver Display
News	NEWS
Current Affairs	AFFAIRS
Information	INFO
Sport	SPORT
Education	EDUCATE
Drama	DRAMA
Culture	CULTURE
Science	SCIENCE
Varied	VARIED
Pop Music	POP M
Rock Music	ROCK M
Easy Listening Music	EASY M
Light Classical Music	LIGHT M
Serious Classical Music	CLASSICS
Other Music	OTHER M
Weather	WEATHER
Finance	FINANCE
Children's programs	CHILDREN
Social affairs	SOCIAL
Religion	RELIGION
Phone in	PHONE IN
Travel	TRAVEL
Leisure	LEISURE
Jazz Music	JAZZ
Country Music	COUNTRY
National Music	NATION M
Oldies Music	OLDIES
Folk Music	FOLK M
Documentary	DOCUMENT

If your TV has a progressive scan feature, the progressive scan function allows you to enjoy higher quality video signals when you play back DVD (etc.) software from this unit.

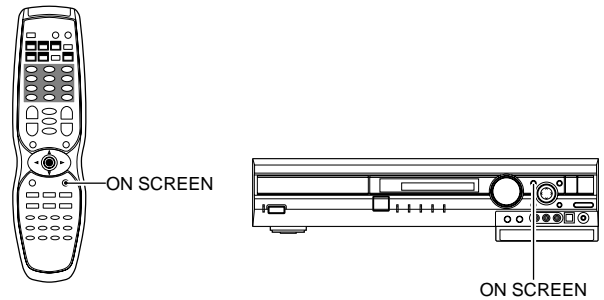

Press and hold the ON SCREEN key for more than 5 seconds

MAIN UNIT

REMOTE

ON SCREEN



ON SCREEN



PROGRESSIVE ON scrolls in the display.

PROGRESSI

Each time you switch to the DVD/CD input "PROGRESSIVE ON" scrolls in the display.

**To turn off the progressive scan
Repeat this operation.**

- PROGRESSIVE OFF scrolls in the display.
- There is no display when you switch to the DVD/CD input.

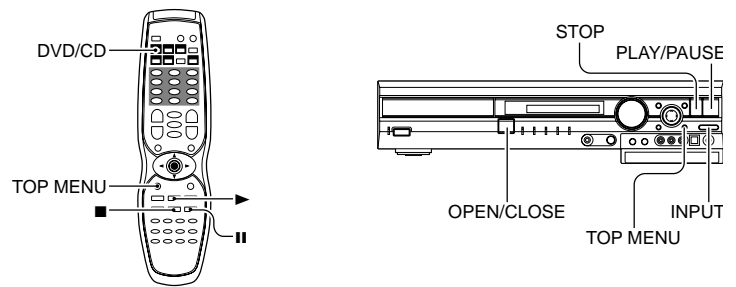

Basic play

1 Load a disc

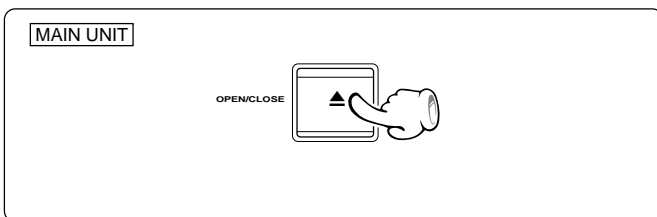

- 1 Open the tray.
- 2 Place a disc.
- 3 Close the tray.

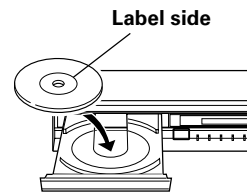

- When the **PLAY/PAUSE** key on the main unit is pressed instead of the **OPEN/CLOSE** key in step 3, the tray will close and playback will start automatically.

2 Select the DVD CD

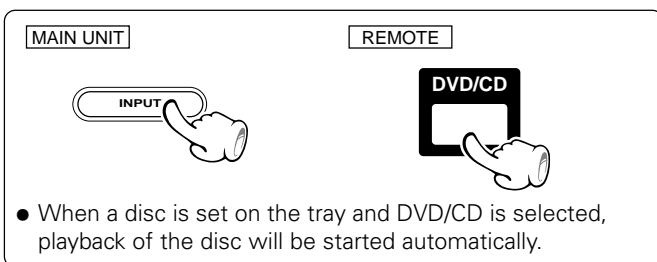

- When a disc is set on the tray and DVD/CD is selected, playback of the disc will be started automatically.

When a Disc Menu appears on the screen

In case of interactive DVDs, a Disc Menu appears on the screen. Then press **ENTER** to select specific menu you want to play by using Cursor keys.

When a menu screen is recorded on the disc, the menu screen will be displayed when the TOP MENU key is pressed. At the menu screen, the menu can be selected by pressing the Cursor keys.

3 Start playback

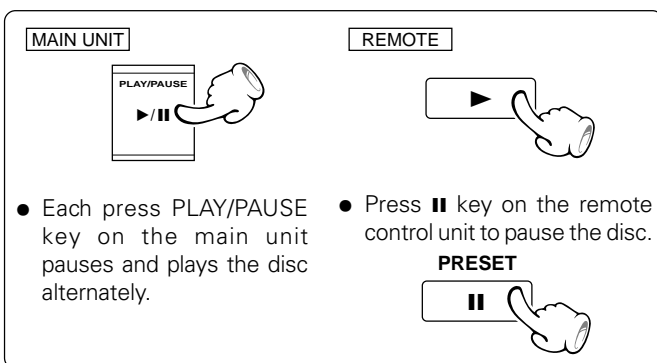

- Each press **PLAY/PAUSE** key on the main unit pauses and plays the disc alternately.
- Press **||** key on the remote control unit to pause the disc.

- When the **PLAY/PAUSE** key on the main unit is pressed while an input other than disc is selected, the unit will be switched to DVD/CD and playback will start.

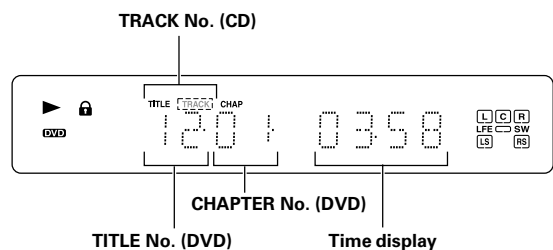

To stop playback

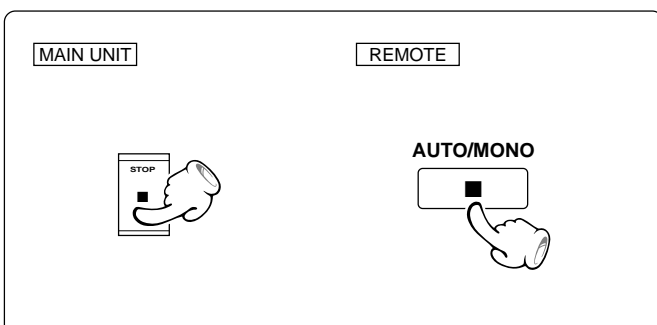

RESUME playback

When the **STOP** key has been pressed once during playback to stop the playback, and then playback is started again, play will start from the point where the playback had been stopped. This is called the **RESUME** function. When the **STOP** key is pressed again during stop, the **RESUME** function is cancelled.

RESUME is cancelled when 5 minutes have passed in **RESUME** status.

Disc playback features



- You won't hear the sound (audio) on the DVD when you're using the Skip, Search, Step or Slow motion features.
- Playback features are not available during the opening credits of a movie.

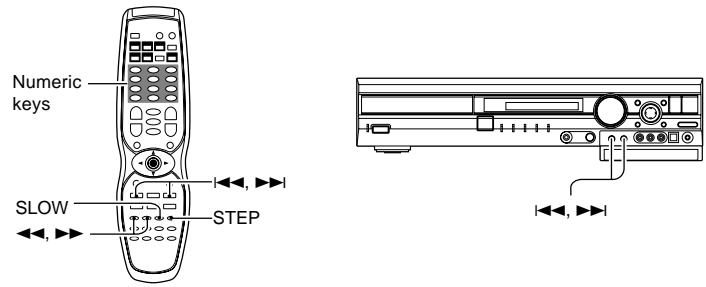

DVD CD VCD **Skipping chapters or tracks**

MAIN UNIT

To skip backward:

To skip forward:

REMOTE

To skip backward:

To skip forward:

- The chapter (or track) in the direction of the key pressed is skipped, and the selected chapter (or track) will be played from the beginning.
- When the **◀◀** key is pressed once during playback, the chapter (or track) being played will be played from the beginning.

DVD CD VCD **Searching**

REMOTE

To search backward:

To search forward:

- During playback, press the **◀◀** or **▶▶** key
- Each press switches the searching speed.
 - ① × 2 (F.SEARCH 1)/(R.SEARCH 1)
 - ② × 4 (F.SEARCH 2)/(R.SEARCH 2)
 - ③ × 8 (F.SEARCH 3)/(R.SEARCH 3)
 - ④ × 16 (F.SEARCH 4)/(R.SEARCH 4)
 (At the time of DVD playback only)
- Press the **PLAY** key at any time to resume normal playback.
- **Audio is not output during F.SEARCH or R.SEARCH playback.**

CD **Playback from desired track**

REMOTE

- Select the desired track No.
- Press the numeric keys as shown below (Example)
To select track No. 23 : **2 3**
- When a number exceeding the largest track No. on the CD being played is specified, a question mark "Tr ?" will be displayed.

DVD VCD **STEP (freeze frame and frame advance)**

REMOTE

DVR-605/6100:

DVR-6100K: **SHIFT** →

TUNE/TV VOL.

- Each time you press the **◀◀**, **▶▶** keys, the picture advances one frame.
- At the time of VCD playback, backward STEP is not possible.
- Press the **PLAY** key to resume normal playback.
- **DVR-6100K only**
Press the SHIFT key before pressing the STEP key.

DVD VCD **Slow motion playback**

REMOTE

TUNE/TV VOL.

- During playback, press the **SLOW** keys, then press the **◀◀**, **▶▶** keys.
- Each press **◀◀**, **▶▶** keys switches the motion speed.
 - (At the time of DVD playback)**
 - ① F.SLOW 1/16 (R.SLOW 1/16)
 - ② F.SLOW 1/8 (R.SLOW 1/8)
 - ③ F.SLOW 1/4 (R.SLOW 1/4)
 - ④ F.SLOW 1/2 (R.SLOW 1/2)
 - (At the time of VCD playback)**
 - ① F.SLOW 1/8 (R.SLOW is not possible)
 - ② F.SLOW 1/4 (R.SLOW is not possible)
 - ③ F.SLOW 1/2 (R.SLOW is not possible)
- Press the **PLAY** key to resume normal playback.

The on-screen Banner Display contains many playback features. To see the Banner Display, press **ON SCREEN (OSD)** while a disc is playing. Use the Cursor (Up/Down/Left/Right) keys to move through the different features in the Banner Display. Each feature is illustrated with an icon.

➊ During playback, press the **ON SCREEN** key.



➋ Press the Cursor left/right (◀/▶) keys to highlight a banner display icon.

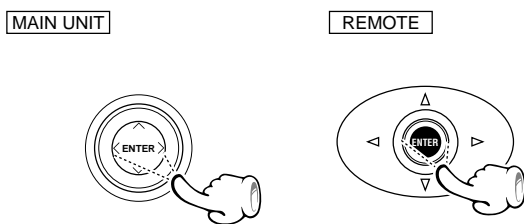

➌ Press the **ENTER** key.

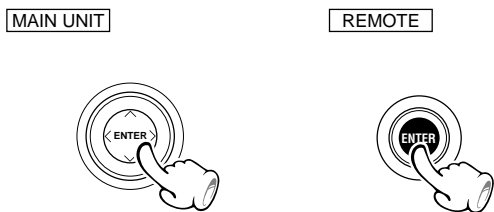

When playing a DVD

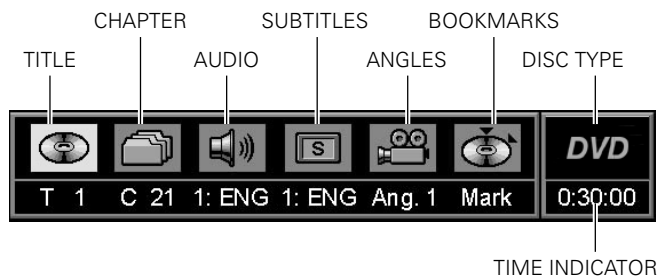

When playing a CD/VCD

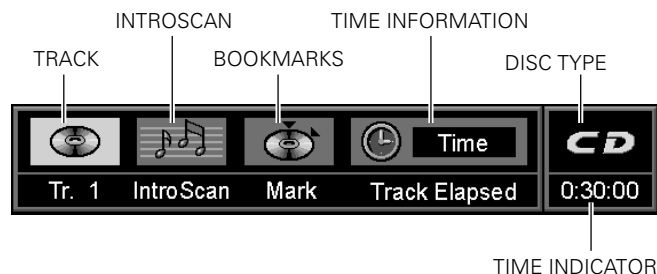

Switch the CD time indicator as follows.

- ➊ Select the time information with the cursor key.
- ➋ Each time the **ENTER** key is pressed, the time indicator changes as follows.
 - ➀ **Track Elapsed** (elapsed time of the track being played)
 - ➁ **Track Remain** (remaining time of the track being played)
 - ➂ **Disc Elapsed** (elapsed time of the disc being played)
 - ➃ **Disc Remain** (remaining time of the disc being played)

To display disappear from the screen

Press the **ON SCREEN (OSD)**.

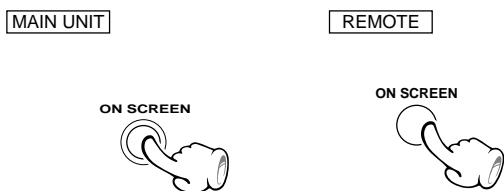

- You can only access the banner display when you're playing a disc.
- The banner display feature are only available if the disc was created with that particular feature (i.e., if you select the Subtitle icon, you won't be able to change the subtitle language unless the author of the disc created the disc with subtitles).
- The invalid symbol ⓪ appears on the screen when you press a key that doesn't have any function. If one of the icons is "grayed out," the banner display feature isn't available for the disc you're playing.

DVD Selecting a Title

Some discs contain more than one title. For example, there might be four movies on one disc (each movie might be considered a title).

① During playback, press the ON SCREEN key.

MAIN UNIT



REMOTE



② Press the Cursor left/right (◀/▶) keys until the TITLE icon is highlighted.

MAIN UNIT



REMOTE

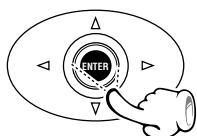

③ Press the ENTER key.
("T_" appears)

MAIN UNIT



REMOTE



④ Use the numeric keys on the remote or the cursor keys on the main unit to enter the title number.

MAIN UNIT



REMOTE

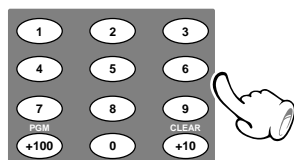

When you enter a one-digit Title number, you may have to press ENTER on the remote after pressing the numeric key (1~9) on the remote. Otherwise press 0 first and the other value. Then play starts. This varies depending on number of Title within the disc you're playing.



Some discs only have one title.

DVD CD VCD Selecting a Chapter or Track

Because DVD discs use digital technology, a title can be divided into individual chapters (similar to tracks on a CD). You can skip a specific chapter by using the Chapter section in the Banner Display.

① During playback, press the ON SCREEN key.

MAIN UNIT



REMOTE

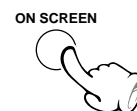

② Press the Cursor left/right (◀/▶) keys until the CHAPTER or TRACK icon is highlighted.

MAIN UNIT

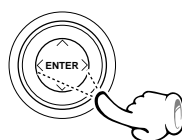

REMOTE

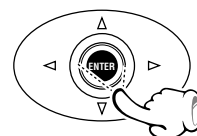

③ Press the ENTER key.
("C_" or "Tr_" appears)

MAIN UNIT



REMOTE



④ Use the numeric keys on the remote, or the skip keys on the main unit to enter the chapter or track.

MAIN UNIT

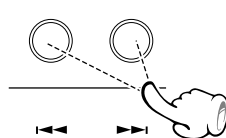

REMOTE

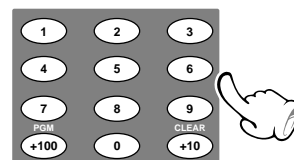

When you enter a one-digit chapter or track number, you may have to press ENTER on the remote after pressing the numeric key (1~9) on the remote. Otherwise press 0 first and the other value. Then play starts. This varies depending on number of chapter or track within the disc you're playing.



- The Chapter feature won't work if the disc isn't formatted with separate chapters.
- P.B.C. on mode of VCD, the Selecting a Track function may not work.

DVD Changing the Audio Language

If the disc was created with different language tracks, you can use the Banner Display to temporarily change the DVD player's Audio setting.

Using the on-screen banner display

- ① During playback, press the ON SCREEN key.

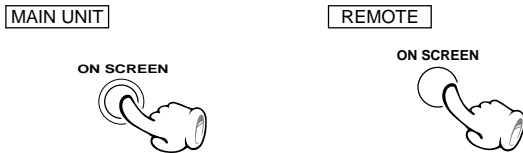

- ② Press the Cursor left/right (◀/▶) keys until the AUDIO icon is highlighted.

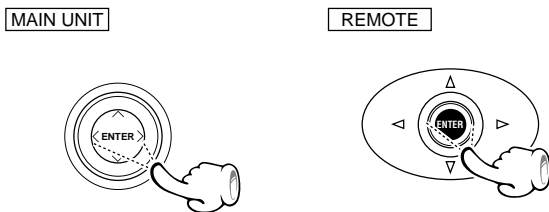

- ③ Press the ENTER key.

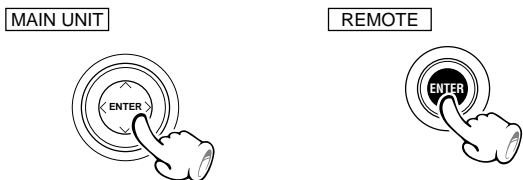

The audio menu appears

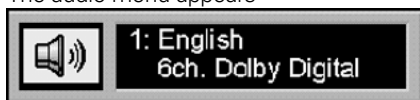

- ④ Press the ENTER key repeatedly to select the audio language.

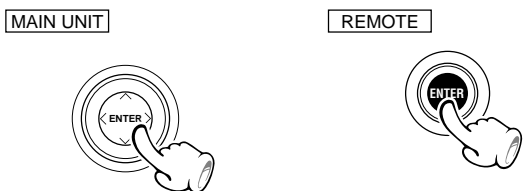

- The menu is switched off when no operation is performed for about 5 seconds.

DVD Changing the Subtitle Language

You can change the Subtitle language while you're watching a disc (but only if the disc was created with subtitles).

Using the on-screen banner display

- ① During playback, press the ON SCREEN key.

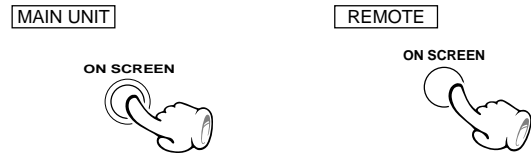

- ② Press the Cursor left/right (◀/▶) keys until the SUBTITLE icon is highlighted.

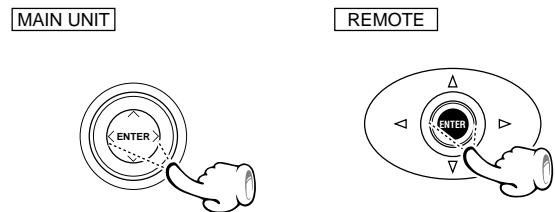

- ③ Press the ENTER key.

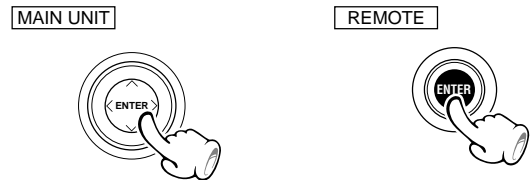

Displayed when
SUBTITLE is ON

The subtitle menu appears



- ④ Select the subtitle language with press the ENTER key.



- ⑤ Press the S.TITLE key to turn subtitles ON or OFF.

Remote control unit only

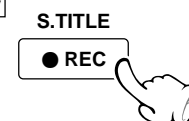

- The menu is switched off when no operation is performed for about 5 seconds.



1. The language feature only works if the disc was created with multiple audio tracks.
2. When you chose an audio language from the Banner Display, you only override the audio language setting in the DVD Player's main menu (in the Language Preferences menu within Setup menu) temporarily.



1. The subtitle feature only works if the disc was created with multiple subtitle tracks.
2. The subtitle menu of the disc appears in some discs.

DVD Changing the Camera angle

Some disc contains multiple angles in particular scene or sequence. If the disc only has one angle, this feature won't work.

Using the on-screen banner display

① During playback, press the ON SCREEN key.

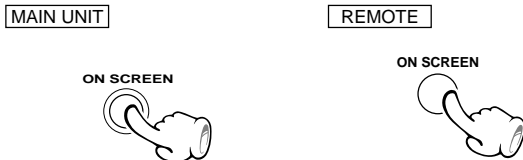

② Press the Cursor left/right (◀/▶) keys until the ANGLE icon is highlighted.

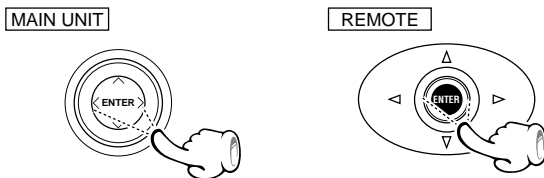

③ Press the ENTER key.

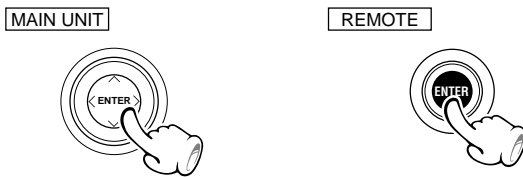

The ANGLE menu appears



④ Press the ENTER key repeatedly to select the angle.

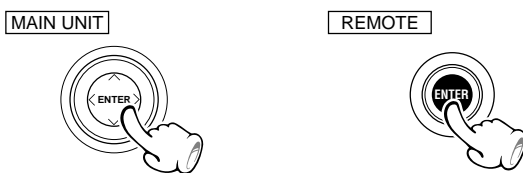

- The menu is switched off when no operation is performed for about 5 seconds.

CD VCD Using IntroScan function

IntroScan plays the first few seconds of each track on only one disc similar to the scan feature that's on many car radios.

Using the on-screen banner display

① During playback, press the ON SCREEN key.

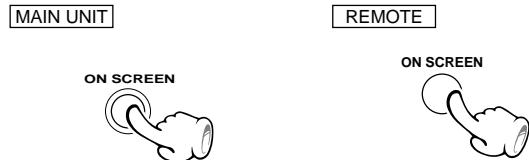

② Press the Cursor left/right (◀/▶) keys until the IntroScan icon is highlighted.

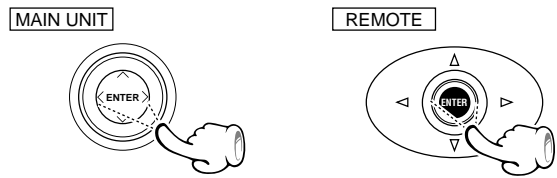

③ Press the ENTER key.

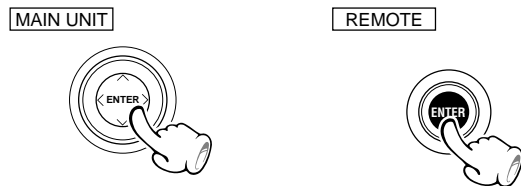

- The first 10 seconds of each track play.
- After Intro Scan goes through all of the tracks, it stops.
- If you want to stop IntroScan while it's in progress, just press ENTER key on the remote (the current track starts playing in its entirety).

(When the On-screen display has gone out, press the ON SCREEN key, select Intro Scan, and press the ENTER key.)



Note
P.B.C. on mode of VCD, the IntroScan function may not work.

DVD CD VCD Using Bookmarks

The bookmark feature lets you mark a point on the disc that you can go to quickly. You can store up to 9 bookmarks.

Create the bookmark

① During playback, press the ON SCREEN key.

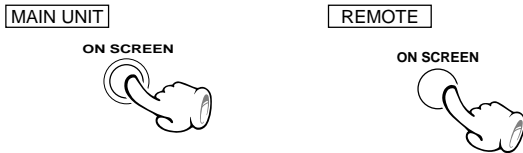

② Press the Cursor left/right (◀/▶) keys until the BOOKMARK icon is highlighted.

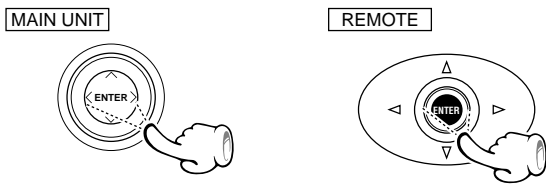

③ Press the ENTER key.

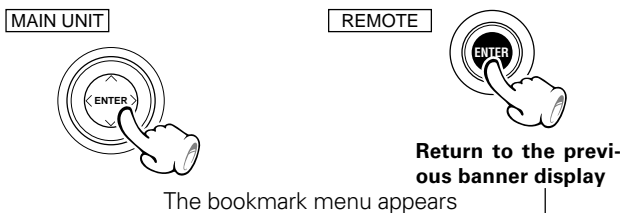

The bookmark menu appears



④ Move cursor to the MARK row, and press ENTER when you reach the point you want to mark.

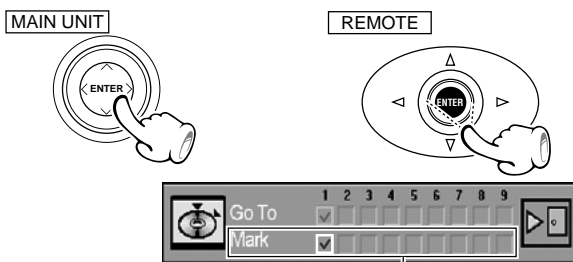

MARK row

- You can also make a bookmark by pressing a numeric key (1~9) when the cursor is in the MARK row.
- Press the ON SCREEN key to switch the menu off.

Clearing a bookmark

- The bookmark is cleared each time the disc changes or when the power is turned off.



- If all 9 bookmarks are in use, you can still mark new scenes, but the previous bookmarks will be erased.
- Depending on the disc, the Bookmark function may not work
- P.B.C. on mode of VCD, the Bookmark function may not work.

Recalling a bookmarked scene

① During playback, press the ON SCREEN key.

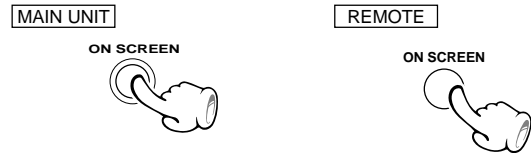

② Press the Cursor left/right (◀/▶) keys until the BOOKMARK icon is highlighted.

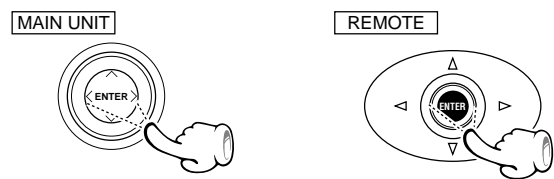

③ Press the ENTER key.



The bookmark appears



④ Move the cursor to the GO TO row and select the bookmark scene you want to activate.

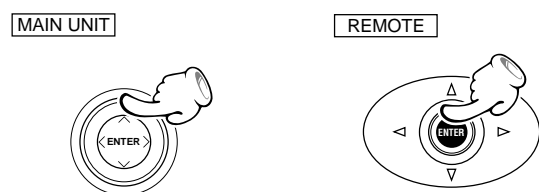

GO TO row



- You can also go to a bookmark by pressing a numeric key (1~9) when the cursor is in the GO TO row.

⑤ Press the ENTER key to active the bookmark.



- Press the ON SCREEN key to switch the menu off.

DVD CD VCD Repeat play

Desired titles or discs can be played back repeatedly.

- Repeat Disc – Repeat the disc that is playing.
- Repeat Title – Repeat the title that is playing.
- Repeat Chapter – Repeat the chapter that is playing.
- Repeat Track – Repeat the track that is playing.

During playback, press REPEAT on the remote.



The Repeat display appears

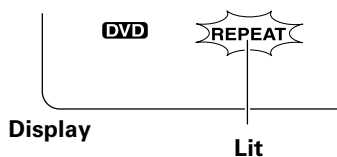
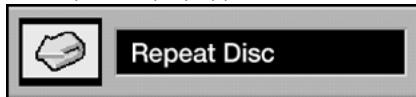

Each press switches the REPEAT mode.



At the time of DVD playback

- ① Repeat Disc
- ② Repeat Title
- ③ Repeat Chapter
- ④ Repeat Off

At the time of CD/VCD playback

- ① Repeat Disc
- ② Repeat Track
- ③ Repeat Off

- To cancel repeat playback, press the REPEAT key and select "Repeat off".
- The menu is switched off when no operation is performed for about 5 seconds.

DVD CD VCD A-B Repeat play

The A-B repeat function lets you mark a segment to repeat between the beginning "A" and the end "B" of the segment you want to replay.

- ① Press the A-B key on the remote when you want to choose a scene (sound) as the beginning point.

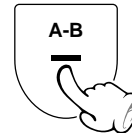

The Repeat A- display appears

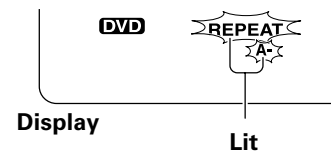

- ② Press the A-B key again to choose a scene (sound) as the end point.

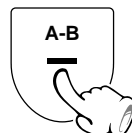

The Repeat A-B display appears



- To cancel A-B Repeat playback, press the A-B key and select "Repeat off".
- The menu is switched off when no operation is performed for about 5 seconds.



P.B.C. on mode of VCD, the Repeat play function may not work.



P.B.C. on mode of VCD, the A-B Repeat play function may not work.

CD VCD *Random play*

The tracks of disc are played in random order.

During playback or stop mode, press RANDOM key on the remote.

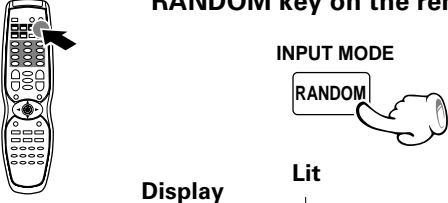

INPUT MODE
RANDOM

Display **Lit**

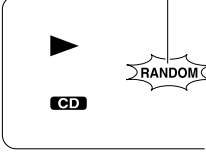

The Random Play display appears



Each time you press RANDOM key on the remote, random play would be on and off.

① "Random Play"
② "Standard Play"

The Standard Play display appears when random is off.



- The menu is switched off when no operation is performed for about 5 seconds.

- When the **RANDOM** key is pressed during playback, the tracks of the disc being played will be selected in random order for playback.
- After all tracks of a disc have been played in random order, playback will stop. (Random mode will be cancelled.)



- When playing a DVD, the Random function may not work.
- P.B.C. on mode of VCD, the Random play function may not work.

Insert chapter or track

During stop mode, press the PGM key on the remote

- 1 Select a specific title/chapter or track to insert by pressing Cursor up/down (▲/▼) keys or numeric keys (0-9).

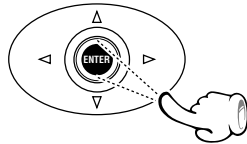

- 2 Move the cursor with the Cursor right (▶) key to the "Playlist" and select the column to be added with the Cursor up/down (▲/▼) keys.

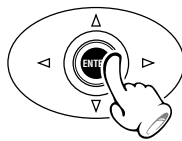

(The color of the column where the Cursor is located will change.)

- 3 Move the cursor with the Cursor left (◀) key to the Insert icon and press the ENTER key.

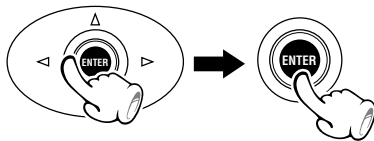

The new chapter or track will be inserted before (above) the selected column.

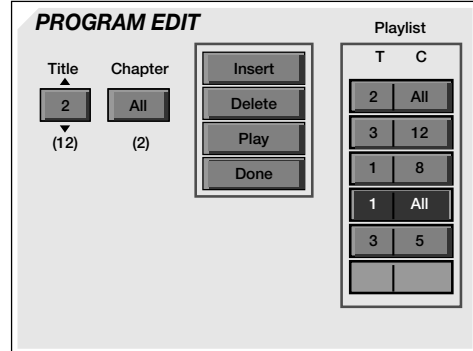

(An example of DVD program edit menu)

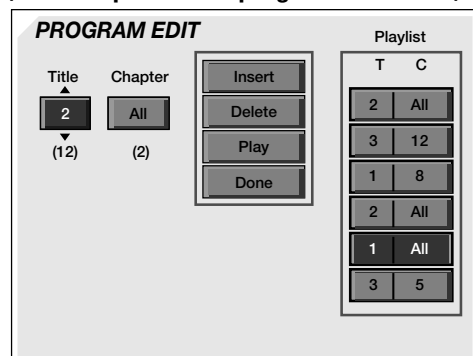

Delete Program

During stop mode, press the PGM key on the remote

- 1 Use the Cursor up/down (▲/▼) keys to select the column to be deleted from the "Playlist". (The color of the column where the Cursor is located will change.)

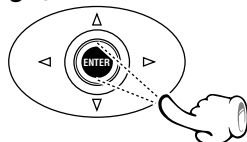

- 2 Press the Cursor left (◀) key, use the Cursor up/down keys to move the Cursor to the Delete icon, and press the ENTER key. Or press the clear key.

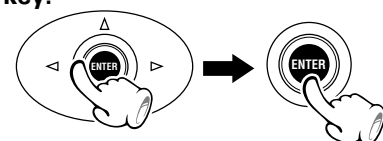

Selected value deletes

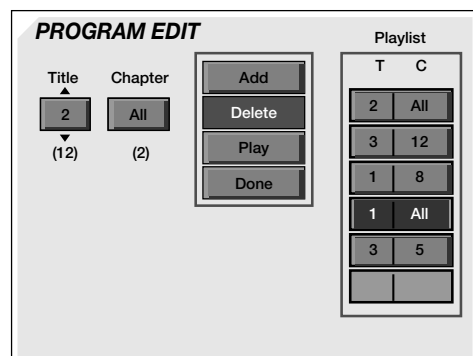

Release Program play

In following case, Program play would be released.

1. When you open and close tray.
2. When you turn power off and on.



P.B.C. on mode of VCD, the Program play function may not work.

VCD Hierarchical structure of VCD menus

When an item is selected on the menu screen during playback of a P.B.C.-compatible VCD, another menu with more details items may be displayed. When a number of menus are connected in multiple layers in this way, it is said that the menus have a hierarchical structure. In this structure, the desired scene can be reached by repeating item selections on the menu screens.

Example for a hierarchical structure

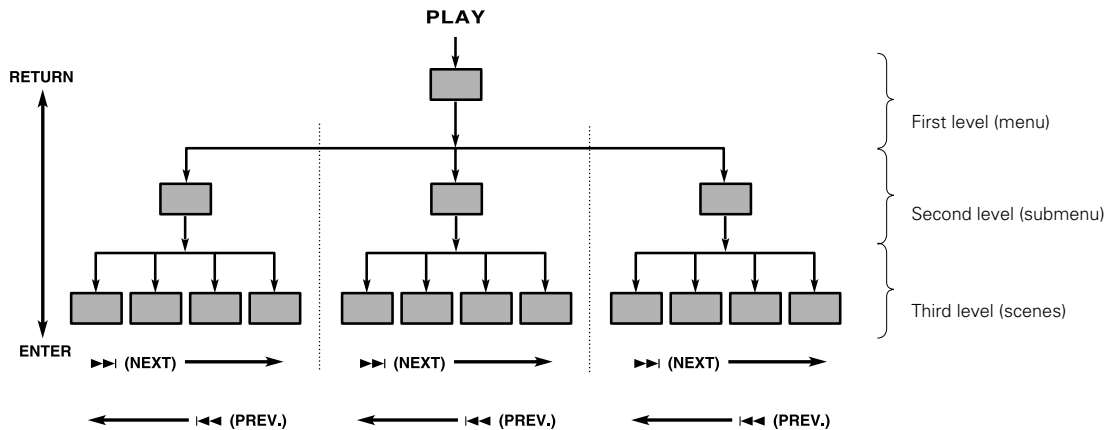

Advancing

When an item is selected on the menu screen with the ▶ key or the numeric keys, advance is made to the next lower menu level. When the advance destination is the "scene" to be played, the contents will be played.

- When several menus (scenes) can be selected in each level, screen switching is possible with the keys ▶▶ (NEXT) and ◀◀ (PREV.).

Returning

Each time the RETURN key is pressed, return is made to the next higher menu.

Examples of operation keys and indications used during VCD playback

Soft jacket indication	▶	↻	◀◀	▶▶	ENTER or SELECT
KENWOOD operation key	▷	RETURN	◀◀	▶▶	ENTER

- Depending on the software, the jacket indication may differ from the above.

VCD Playback without using the menu playback function (In case of a P.B.C.-compatible VCD) (To P.B.C. On or Off)

Press the TOP MENU key on the remote control unit.



- For the track numbers, refer to the disc jacket or other material.
- P.B.C. off mode : Without using menu playback function.

P.B.C. off mode

Goes off

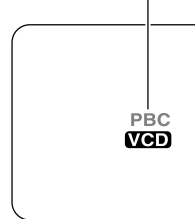

To return to menu playback

Press the TOP MENU key again.

P.B.C. on mode

Lit

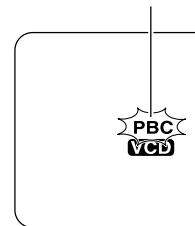

To return to the previous screen

Press RETURN on the remote control unit.



- The VCD returns to the previous scene.

Preparation

1 Load a disc and Connect a microphone.

① Open the tray.



② Place a disc.

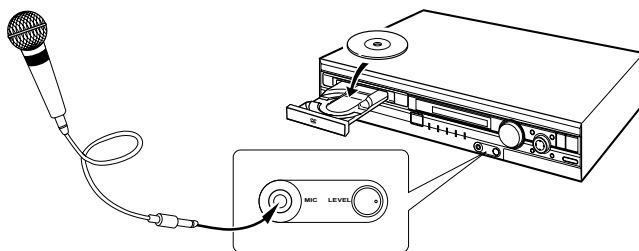

2 Start playback.

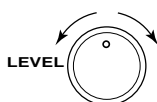
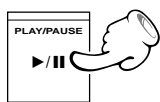

- When the ►/|| key is pressed while a tray is open, the tray closes automatically, and then playback begins.

- Adjust volume level of the microphone.
 1. Karaoke mode operation is possible only when a microphone is connected.
 2. When this unit is connected with an amplifier or receiver with only the digital connection, the microphone audio cannot be output. Use the **AUDIO OUTPUT** jacks to output the microphone audio from this unit.
 3. Karaoke operation is not available for DTS and MP3 format disc. In case of DTS CD, you may hear a loud noise.

VCD Selecting the Audio channel

You can choose to play back only the right or the left channel of audio recorded on the disc, or you can select stereo playback. This function is used for purposes such as selecting the vocal track on a Karaoke disc.

During VCD playback, press AUDIO key on the remote.



Each press switches the mode.

- ① Stereo
- ② Left
- ③ Right

- When playing a Karaoke DVD, please refer to the instructions included with the disc.

DVD CD VCD Controlling the key of the music (KEY CONTROL)

This feature allows to transpose the key of the music according to the key of the singer's voice.

① During playback, press the Key Control keys, the OSD appear on the TV display.

Press within 5 seconds after pressing the SHIFT key.

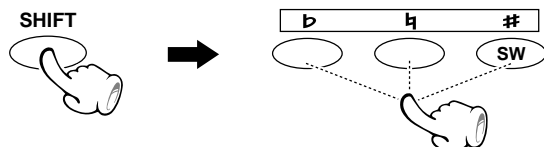

② Press the Cursor up/down (▲/▼) keys or Key Control keys to adjust the KEY level.

Press within 5 seconds after pressing the SHIFT key.

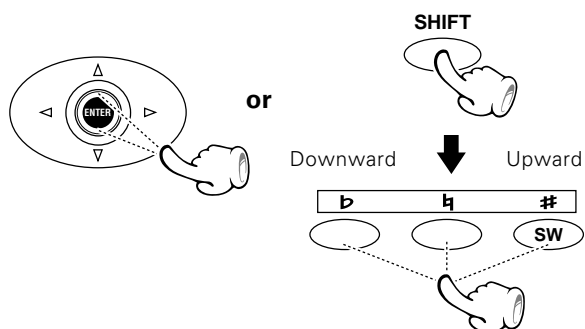

KEY CONTROL icon

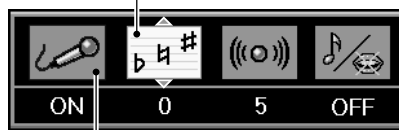

KARAOKE mode icon

- Press the next key within 5 seconds of pressing the **SHIFT** key.

- KEY CONTROL can be varied from -3 to +3.
- Press the Cursor left or right (◀/▶) key while the OSD is displayed to select another icon.
- To turn off the OSD, press the **ON SCREEN** key.
- To exit from the KARAOKE mode, select the KARAOKE mode icon while the OSD is displayed and press the **ENTER** key.

DVD CD VCD Adjust the ECHO level

① During playback, press the ECHO keys, the OSD appear on the TV display.

Press within 5 seconds after pressing the SHIFT key.

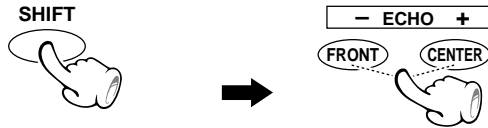

② Press the Cursor up/down (▲/▼) keys or ECHO keys to adjust the ECHO level.

Press within 5 seconds after pressing the SHIFT key.

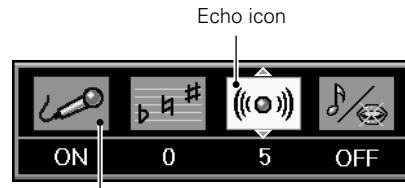
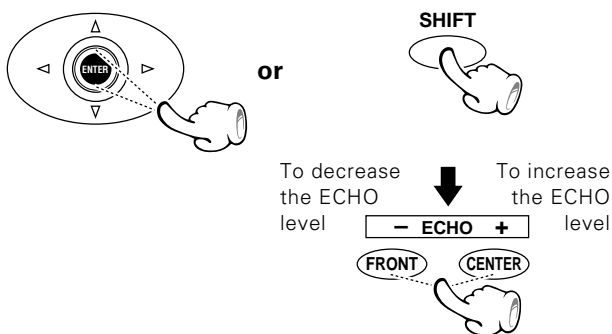

KARAOKE mode icon

- Press the next key within 5 seconds of pressing the **SHIFT** key.

- The echo effect can be varied from 0 to 9.
- Press the Cursor left or right (◀/▶) key while the OSD is displayed to select another icon.
- To turn off the OSD, press the **ON SCREEN** key.
- To exit from the KARAOKE mode, select the KARAOKE mode icon while the OSD is displayed and press the **ENTER** key.



An echo effect can be applied to the microphone voice to make karaoke singing sound better.

DVD CD VCD HIT MASTER function

The sound level of the vocal part of the disc is suppressed, so that it can be used in the same way as a KARAOKE disc.

① During playback, press the ECHO keys, the OSD appear on the TV display.

Press within 5 seconds after pressing the SHIFT key.

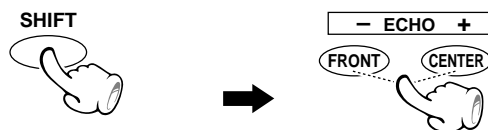

② Press the cursor left/right (◀/▶) keys to select HIT MASTER.

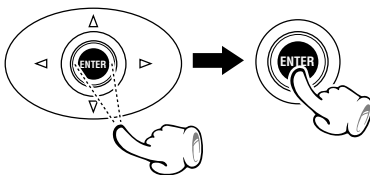

③ Press the ENTER key to switch HIT MASTER on/off.



This operation displays the KARAOKE display.

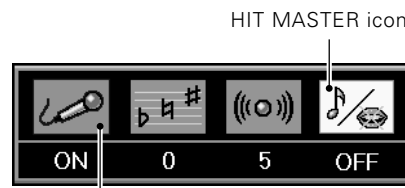

KARAOKE mode icon

Each press switches the mode.

- ① HIT MASTER ON
- ② HIT MASTER OFF

- Press the Cursor left or right (◀/▶) key while the OSD is displayed to select another icon.
- To turn off the OSD, press the **ON SCREEN** key.
- To exit from the KARAOKE mode, select the KARAOKE mode icon while the OSD is displayed and press the **ENTER** key.



Depending on the disc, the suppression amount may be smaller.

MP3 function

DVR-605/DVR-6100/DVR-6100K (EN)

Guidance of MP3

Media that can be played back with this equipment

Usable media : CD-ROM, CD-R, CD-RW

Usable format : ISO9660 level 1.

Files that can be played back : MP3 files

Creating media for playing back on this equipment

Compressing MP3

Please set up the transfer bit rate setting for the compression software when compressing MP3 files as follow.

MP3 Files : 128kbps recommended (32kbps-320kbps)

- This unit is compatible with 32 kHz, 44.1 kHz (recommended) and 48 kHz sampling frequencies.

Naming folders and files

Single-byte characters between A and Z, single-byte numerals between 0 and 9, and the single-byte underscore(_) can be displayed. Ensure that the ".MP3"(MP3 files) extension log is attached to all file names.

- **Never add the MP3 extension log to any files other than MP3 files. If the MP3 extension log is added to any files other than MP3 files, the equipment will assume that they can be played back, and this will produce loud noises in the speakers, resulting in damage of adverse effects.**

Confirming media and files

Check to ascertain that MP3 files can be played back correctly on the personal computer in use prior to saving them onto the media. Check to ensure that the saved file can be played back normally.

- It is not possible to confirm that files can be played back correctly while they are being saved onto the media.

When saving files onto media

Ensure that the session is closed or finalized when data has been written on media. There are cases where media on which the session has not be closed or finalized will not be played back correctly with this equipment.

- There are cases were the folder names and file names will not be displayed correctly depending on the software used to save them.
- Do not store files or folders other than MP3 on media to be played back with this equipment.
- It is recommended that ten or less sessions are stored when recording MP3 files onto a media.
- Some time may be required until the playback of multi-session discs starts.
- There are cases where playback is not possible when MP3 files (CD-ROM) and music CD information (CD-DA) are saved on the same media.

Example for a hierarchical structure

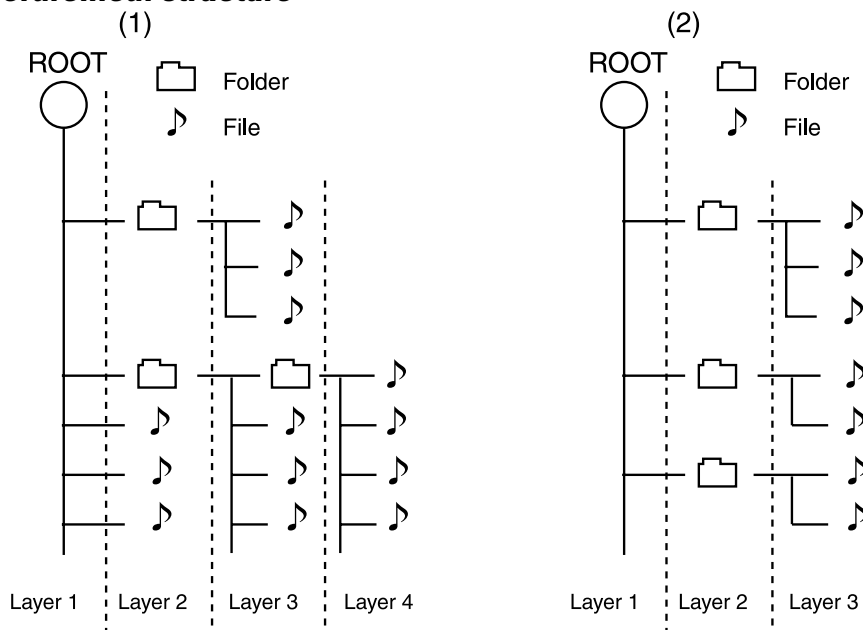

Playing back MP3

- It is not possible to play back folders and files (up to 223) that exceed the maximum limitations of the media.
- A certain amount of time is required for the player to confirm the media on which MP3 files have been recorded before playback will commence.
- The files will be played back in the sequence in which they were recorded (written).

Playback

Each press pauses and plays the disc alternately. (When you insert the MP3 media, playback will start automatically.)

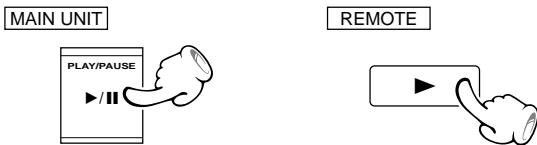

(When you insert MP3 media, MP3 On-screen display appears.)



To stop playback

Press ■ (STOP) key.

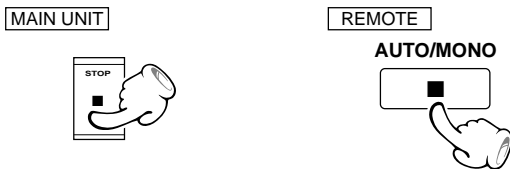

Skipping files

During playback, press ◀◀ or ▶▶ key.

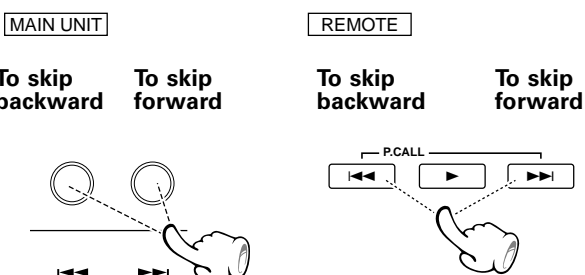

MP3 On-screen display

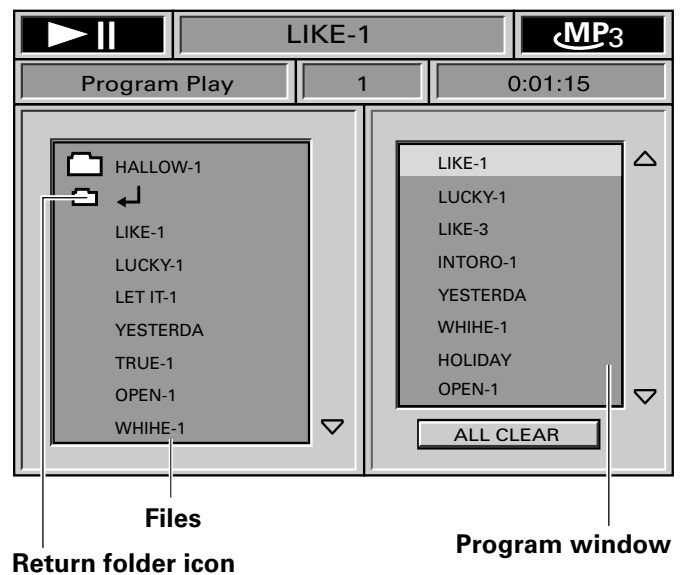
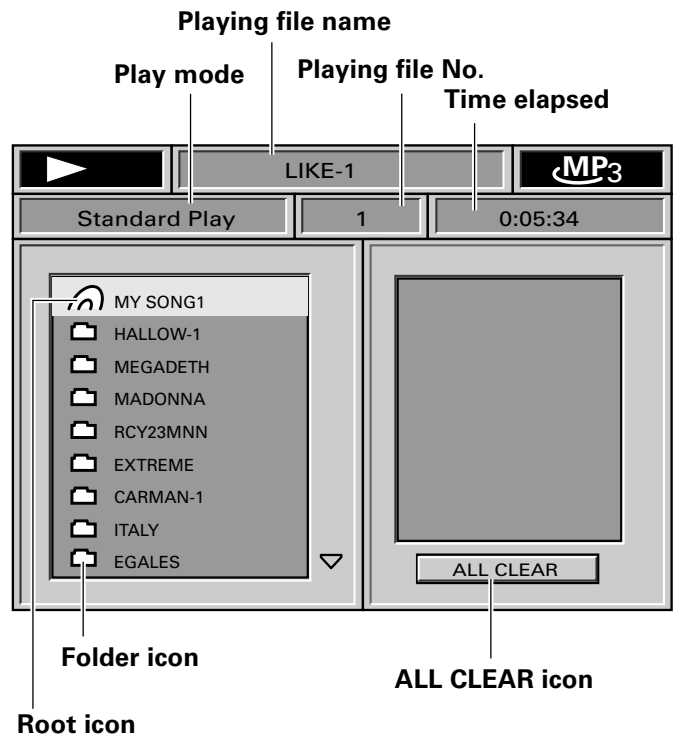

Folder names and file names are displayed up to 8 characters. When folder names and file names are recorded with more than 8 characters, the names will be displayed in abbreviated form.

Selecting MP3 files

- 1 Press Cursor up/down (▲/▼) keys to select the folder, then press the ENTER key.

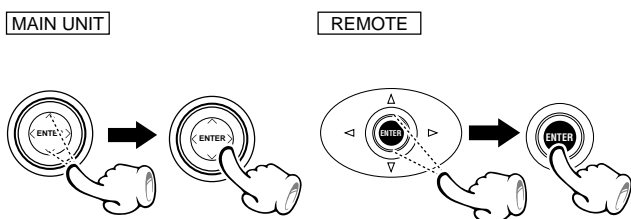

- 2 Press Cursor up/down (▲/▼) keys to select the file, then press the ENTER key.

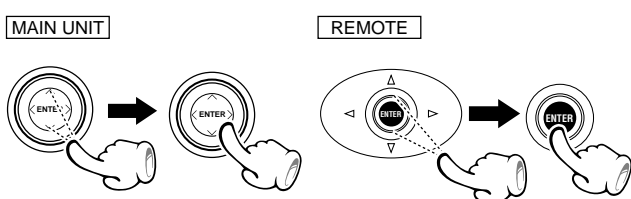

- Playback will start from selected file.

- The files and folders in the selected folder appear.



Press ENTER key on RETURN folder icon to move to the upper layer.

Selects the files to be played back directly

- 1 Press the Cursor right (▶) key to invert the file numbers.

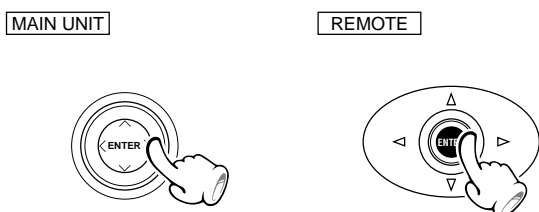

- 2 Press the numeric keys on the remote to enter the desired file number.

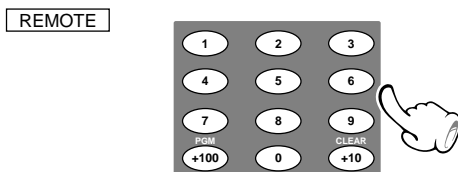

- If "-- --" is displayed after completion of the file number entry, press the ENTER key before "----" disappears.
- Playback will start from selected file.

File No.



MP3 Repeat play

Desired folders or discs can be played back repeatedly.

- "Repeat 1 Disc": Repeat the disc that is playing.
- "Repeat 1 Folder": Repeat the folder that is playing.
- "Repeat Track": Repeat the file that is playing.

During playback, press the REPEAT key on the remote.

REMOTE



- To cancel repeat playback, press the REPEAT key and select "Standard Play".



When the folder played by repeat play contains subfolders, the files in the subfolders cannot be played back.

Each press the key switches the REPEAT mode.

- ① "Repeat 1 Disc" : Display lit "REPEAT ALL"
- ② "Repeat 1 Folder" : Display lit "REPEAT ALL"
- ③ "Repeat Track" : Display lit "REPEAT 1"
- ④ "Standard Play"

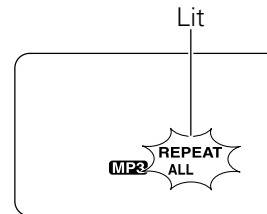

Display

MP3 Random play

The files of the disc are played in random order.

During playback or stop mode, press RANDOM key on the remote.

REMOTE

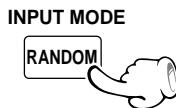

- When the RANDOM key is pressed during playback, the tracks of the disc being played will be selected in random order for playback.
- After all tracks of a disc have been played in random order, playback will stop. (Random mode will be cancelled.)

To repeat random play

During random playback, press the REPEAT key on the remote.

REMOTE



Each press the key switches the mode.

- ① Display lit "REPEAT ALL"
- ② Repeat canceled

Each time you press RANDOM key on the remote, random play would be on and off.

- ① "Random Play"
- ② "Standard Play"

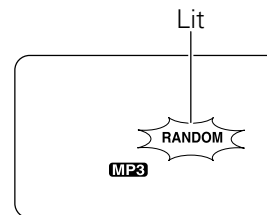

Display



It is not possible to perform random play by specifying a folder name.

MP3 Program play

You can listen to the desired files of the current MP3 disc in any desired order.

Program Edit

- 1 During stop mode, press the PGM key on the remote



- 2 Press Cursor up/down (▲/▼) keys on the remote to select the file, then press the ENTER key.

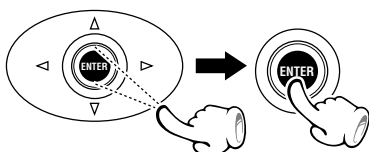

- The selected file go to program window.
- You can select maximum of about 100 files by repeating step 2. However, note that the maximum number of programmable files depending on the number of files and folders in the MP3 disc and on the total number of characters used in the file and folder names.
- 3 Press ►/|| key to start program playback.
- To return to standard play, press the PGM key again.
- If a file number is entered during editing or playing a MP3 program, the program mode will be canceled.

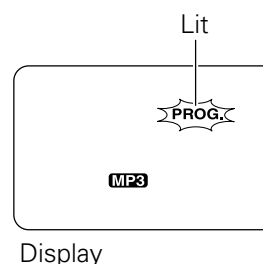

Display

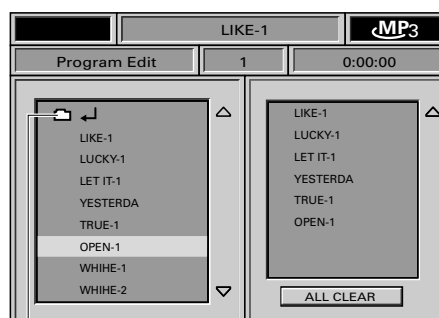

Press ENTER key on RETURN folder icon to move to the upper layer.

Delete Program

During stop mode, press Cursor left/right (◀/▶) keys on the remote to select the "ALL CLEAR" icon, then press the ENTER key.

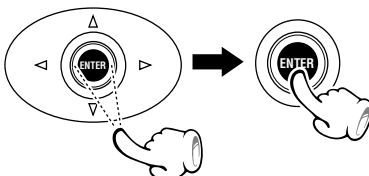

- The program deletes.
- You can delete file one by one by selecting in Program window and pressing CLEAR key on the remote.



Set up menu

The initial setup of the player, which has been made at the factory, can be changed to the desired setup.

❶ During stop mode or resume mode, press the MENU key.

MAIN UNIT

REMOTE

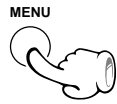
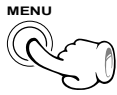

Current setup menu display appears on the screen.

❷ Press Cursor up/down (▲/▼) keys to select the item, then press the ENTER key to access the sub features

MAIN UNIT

REMOTE

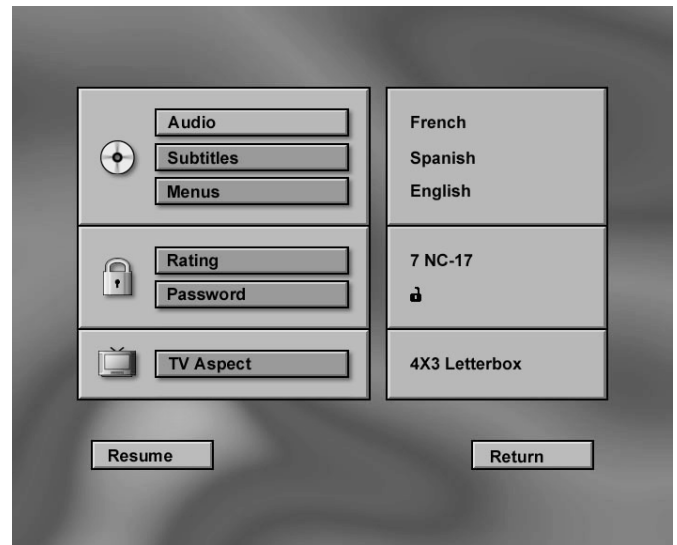
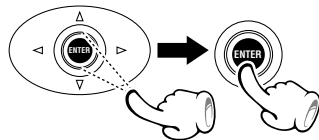
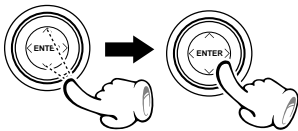

(Menu display example)

Audio / Subtitle(disc languages) : This sets the language to be used when playing a disc. (If a disc does not contain the recording the selected language, it is played in the priority language set for each disc.)

Menus : This sets the initial setup of language as well as the language used in on-screen messages such as "PLAY".

Rating : This can restrict playback of adult-oriented DVD discs that you do not want to be seen by children. However, even when a DVD disc is marked "Adult-oriented" or so on the label, its viewing cannot be restricted unless the restriction level is recorded in the disc itself.

Password : The password for rating setting, change, cancellation, etc. is set.

TV Aspect : This sets the screen size (4:3 or 16:9 aspect ratio) according to the connected TV.

- **4 x 3 letterbox** : Choose this setting if you would prefer to see movies in their original aspect ratio. You will see the entire frame of the movie, but it will occupy a smaller portion of the screen. This setting may result in the movie appearing with black bars at the top and bottom of the screen.
- **4 x 3 Pan Scan** : Choose this setting if you want the movie to fill the entire screen of your TV. You won't see part of the picture (particularly the right and left edge). Some disc produced in a wide screen format can't be cropped in this fashion, which means the black bars would appear at the top and the bottom of the screen.
- **16 x 9 Widescreen** : Choose this setting if your DVD player is connected to a widescreen TV.

How to use the RETURN key

When the RETURN key is pressed, the display returns to the previous screen (STOP mode).

RETURN



DVD Select Audio Language

- Press Cursor up/down (▲/▼) keys to select Audio on the set up menu display, then press the ENTER key.

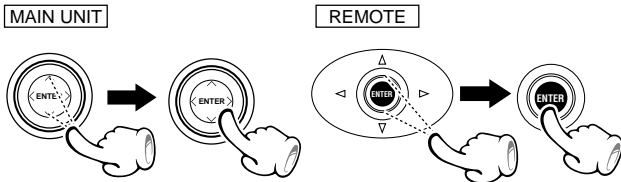

(Audio menu appears.)

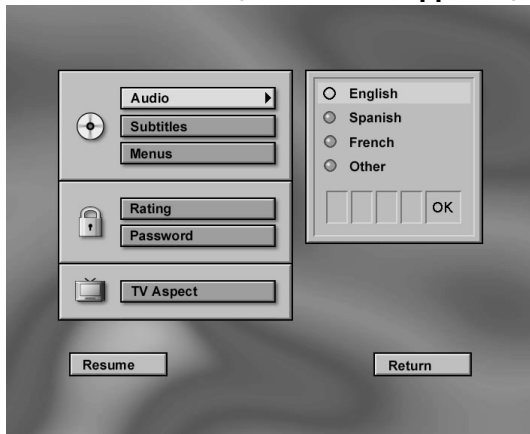

(The display shows an example for some areas)

- Press Cursor up/down (▲/▼) keys to select specific Audio language, then press the ENTER key.

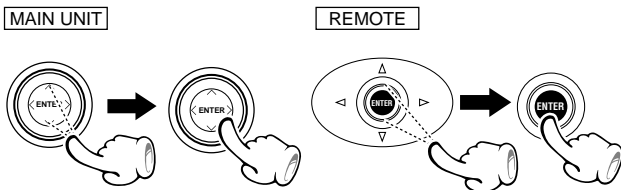

To select other language

- Select "Other" and press ENTER key



- Input code in the first digit by pressing Cursor up/down (▲/▼) keys or numeric keys on the remote and repeat other 3 code with same way.
- Press the ENTER key on "OK" icon. (DVD menu language code list - 64)

- Press PLAY key to resume normal playback.

DVD Select Subtitle Language

- Press Cursor up/down (▲/▼) keys to select Subtitle on the set up menu display, then press the ENTER key.

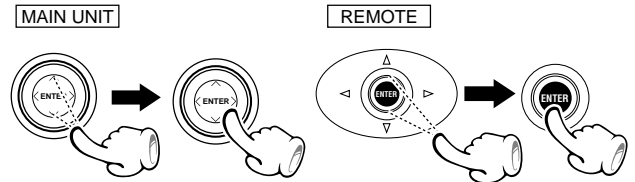

(Subtitle menu appears.)

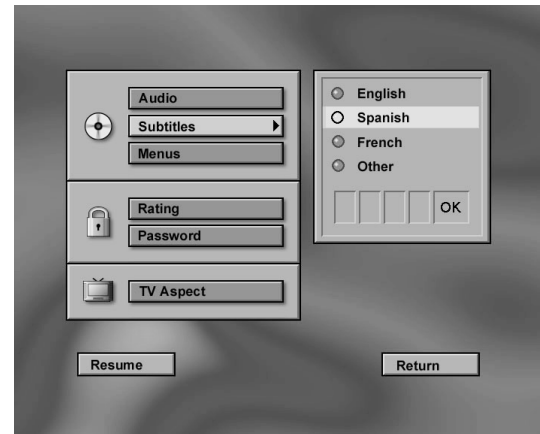

(The display shows an example for some areas)

- Press Cursor up/down (▲/▼) keys to select specific Subtitle language, then press the ENTER key.

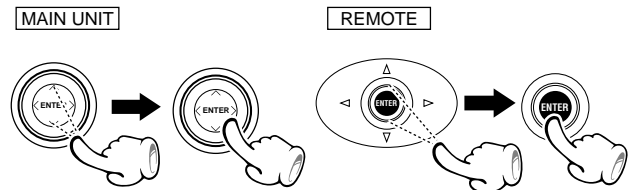

To select other language

- Select "Other" and press ENTER key



- Input code in the first digit by pressing Cursor up/down (▲/▼) keys or numeric keys on the remote and repeat other 3 code with same way.
- Press the ENTER key on "OK" icon. (DVD menu language code list - 64)

- Press PLAY key to resume normal playback.

DVD Select Menu Language

- Press Cursor up/down (▲/▼) keys to select Menus on the set up menu display, then press the ENTER key.

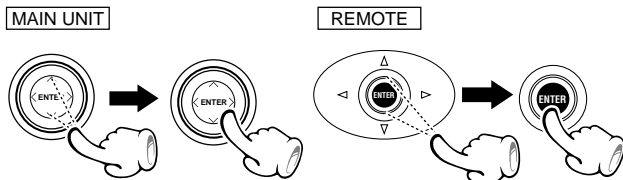

(Menus appears.)

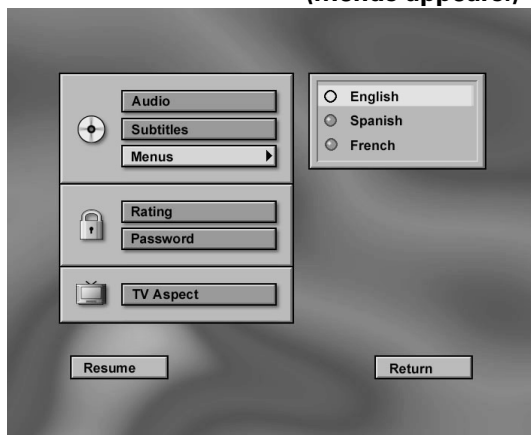

(The display shows an example for some areas)

- Press Cursor up/down (▲/▼) keys to select specific Menu language, then press the ENTER key.

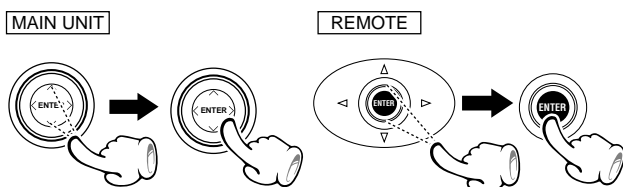

- Press PLAY key to resume normal playback.

DVD Select Rating

This part of DVD rating lets you determine how your player will react discs that contain movies that are rated (in the U.S.A. the Motion Pictures Association of America rates movies as G, PG, PG-13, etc.).

- Press Cursor up/down (▲/▼) keys to select Rating on the set up menu display, then press the ENTER key.

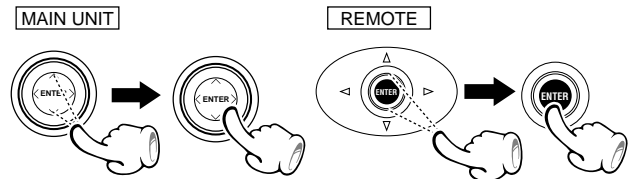

When a password already has been set, the screen for change of the entered password will be displayed. In that case, enter the password. (- [49])

(Rating aspect menu appears.)

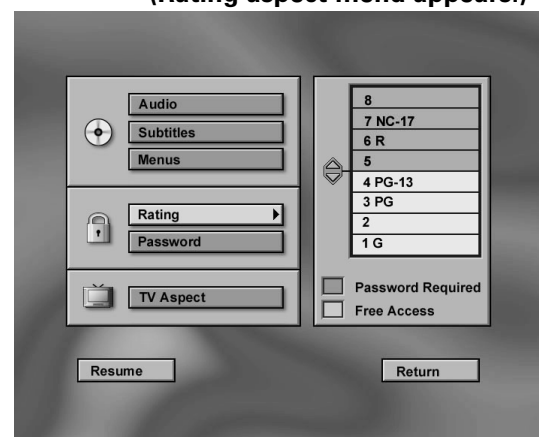

(The display shows an example for some areas)

- Press Cursor up/down (▲/▼) keys to highlight rated titles, then press the ENTER key.

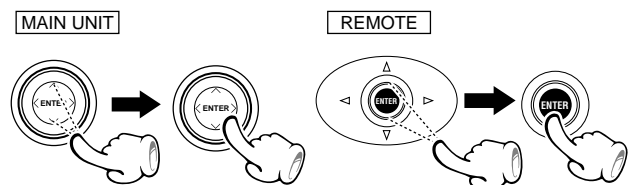

- Press PLAY key to resume normal playback.

Playback of a disc

When the settings for Rating (Parental Lock) and Password (- [49]) have been made, the input screen for the password will be displayed when playback of a disc corresponding to parental lock is started. Playback of that disc will be possible when the correct password has been entered.

Parental lock level

Level 8: All DVDs can be played back. (Factory preset)
 Level 7 to 2: DVDs for general audiences/children can be played back. (DVDs for adults are prohibited.)
 Level 1: DVDs for children can be played back. (DVDs for adults/general audiences are prohibited.)

DVD Password

Input password

➊ Press Cursor up/down (▲/▼) keys to select Password on the set up menu display, then press the ENTER key.

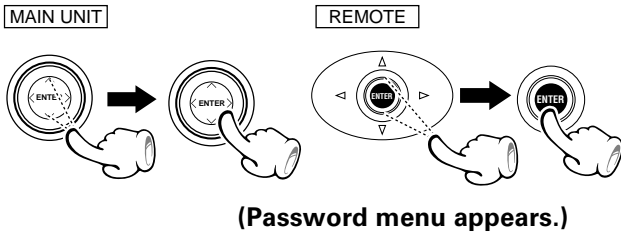

(Password menu appears.)

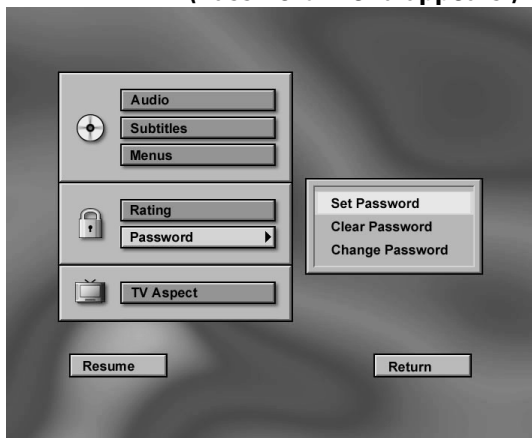

➋ After select "Set Password", press the ENTER key.

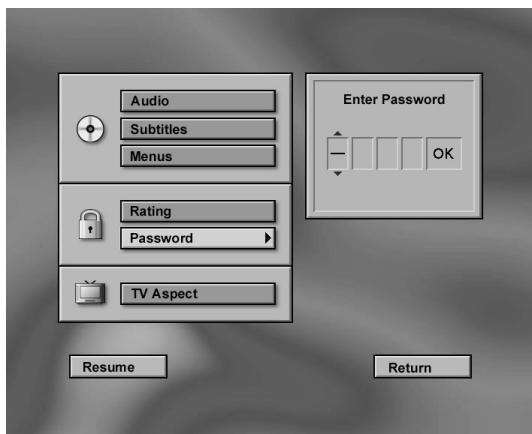
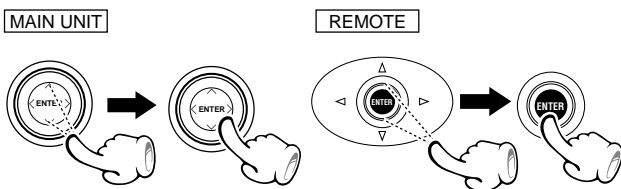

➌ Press Cursor up/down (▲/▼) keys (or numeric keys on the remote) to enter password.

➍ Press ENTER key to finish password input (Confirm Password display appears below Enter Password display).

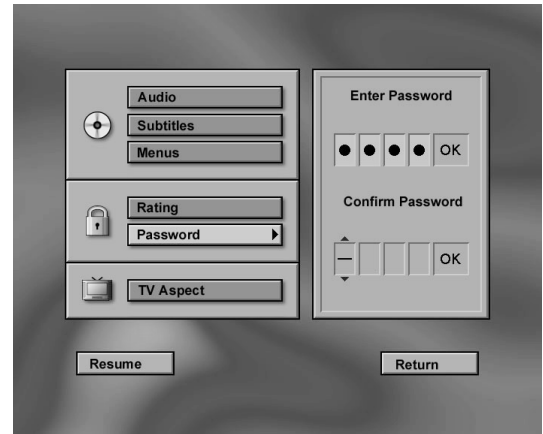

➎ Press Cursor up/down (▲/▼) keys (or numeric keys on the remote) to enter again password that you entered.

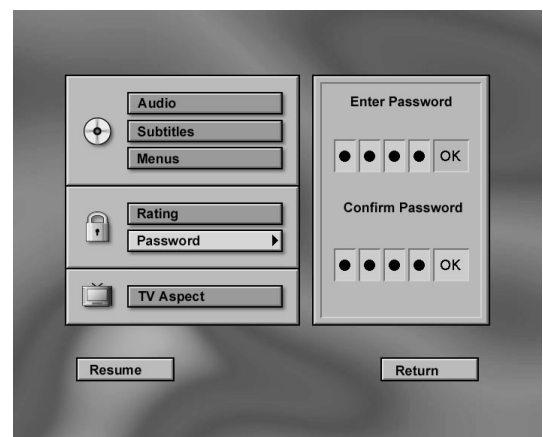
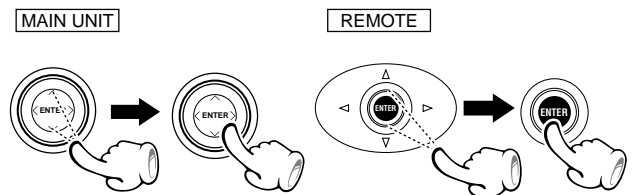

➏ Press the ENTER key on "OK" icon.

● Press PLAY key to resume normal playback.

DVD Password (continued)

Change password

- Press Cursor up/down (▲/▼) keys to select Password on the set up menu display, then press the ENTER key.

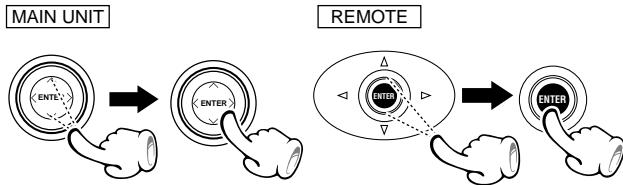

(Enter Password menu appears.)

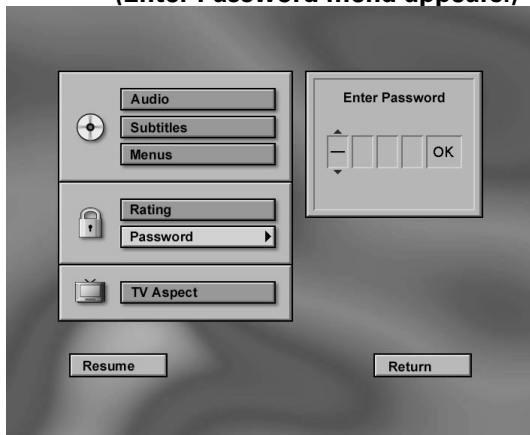

- Press Cursor up/down (▲/▼) keys (or numeric keys on the remote) to enter password. Press the ENTER key on "OK" icon.

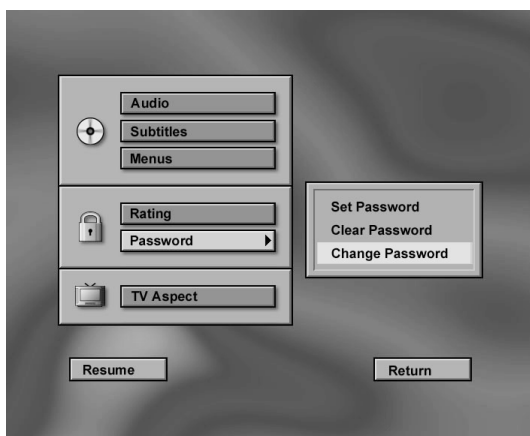
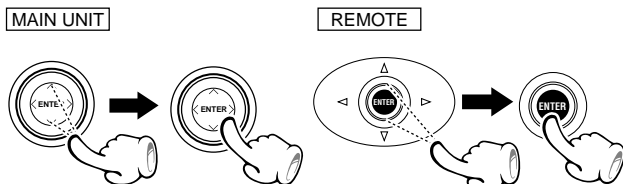

- Press Cursor up/down (▲/▼) keys to select Change Password, then press ENTER key.

- Press Cursor up/down (▲/▼) keys (or numeric keys on the remote) to enter password.

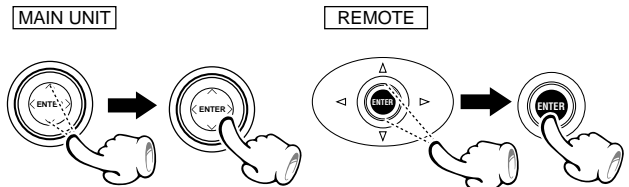

- Press ENTER key to finish password input (Confirm Password display appears below Enter Password display).

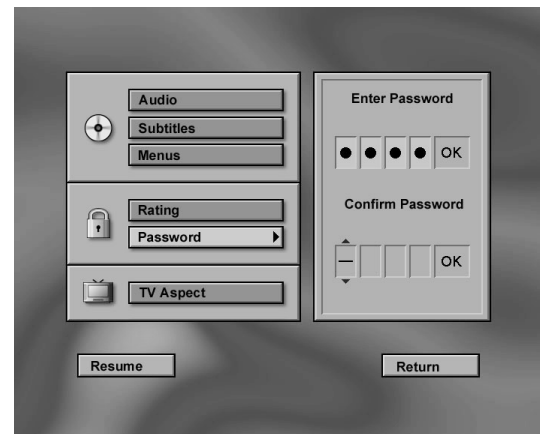

- Press Cursor up/down (▲/▼) keys (or numeric keys on the remote) to enter again password that you entered.

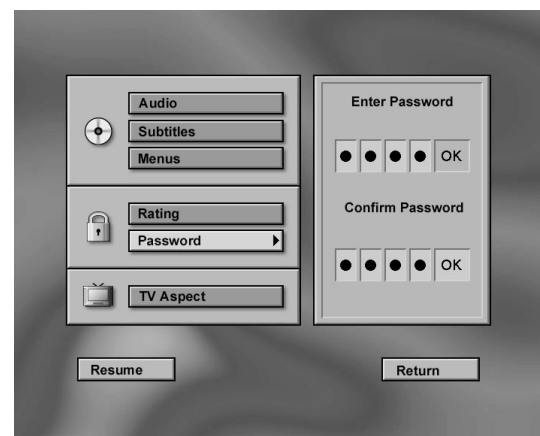
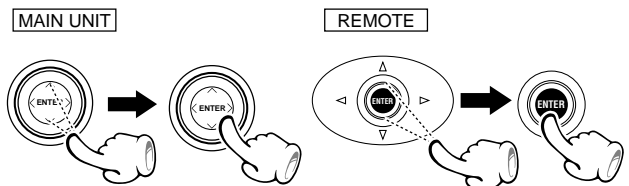

- Press the ENTER key on "OK" icon.

- Press PLAY key to resume normal playback.

DVD Password (continued)

Clear password

- Press Cursor up/down (▲/▼) keys to select Password on the set up menu display, then press the ENTER key.

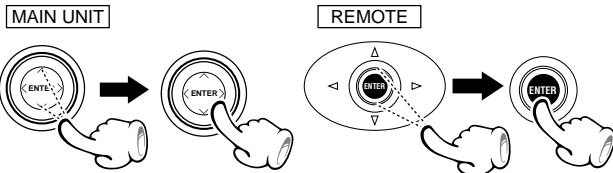

(Enter Password menu appears.)

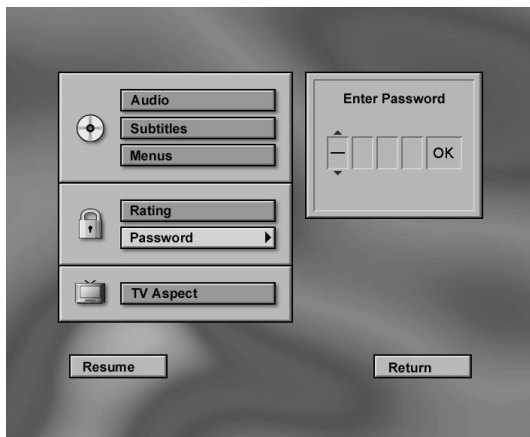

- Press Cursor up/down (▲/▼) keys (or numeric keys on the remote) to enter password. Press the ENTER key on "OK" icon.

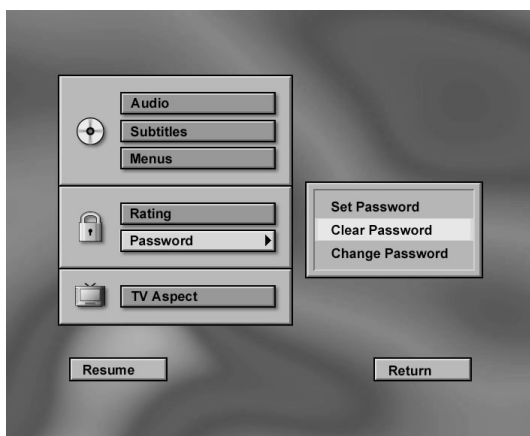
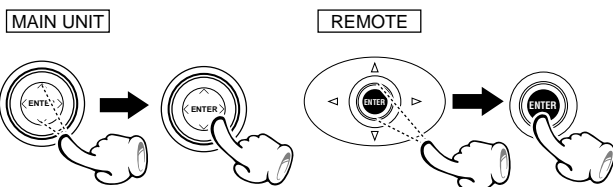

- Press Cursor up/down (▲/▼) keys to select Clear Password, then press ENTER key.

- Press PLAY key to resume normal playback.

DVD TV aspect

- Press Cursor up/down (▲/▼) keys to select TV Aspect on the set up menu display, then press the ENTER key.

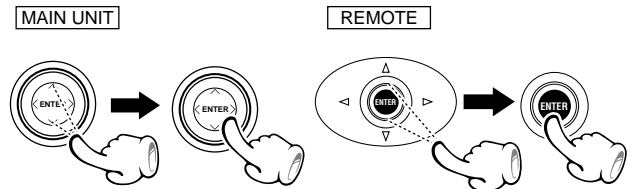

(TV Aspect menu appears.)

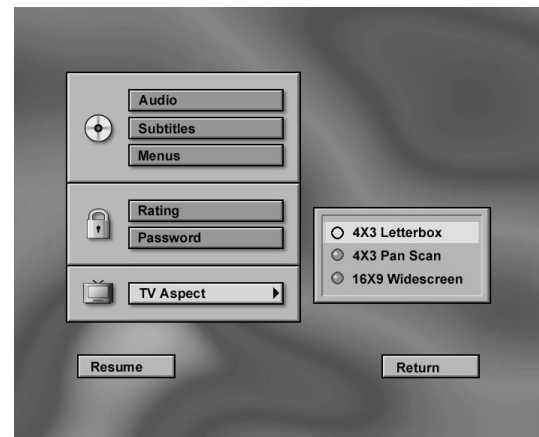

- Press Cursor up/down (▲/▼) keys to select TV Aspect menu, then press the ENTER key.

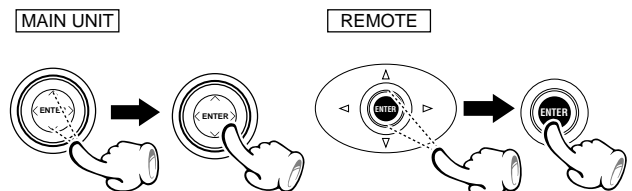

- Press PLAY key to resume normal playback.

What are LISTEN modes?

You can experience true home-theater sound with your new system. This system incorporates several listen modes to let you enjoy surround sound with a wide variety of program sources. Each produces multiple channels of surround-sound, but each does it differently.

- **Dolby Digital:** Dolby Digital uses an encode/decode process based on its theatrical digital surround sound technology. The five main channels are full-frequency and independent, so sound can completely envelop you or soar anywhere in the room, just like at the movies. Compared with Dolby Pro Logic, Dolby Digital has more clarity, greater surround envelopment, and more realistic sound movement between channels.
- **Dolby Pro Logic/Dolby Pro Logic II:** Dolby Pro Logic reproduces a surround sound like in a movie theater from Dolby Surround-encoded program source (videotape or LaserDisc software carrying the Dolby Surround logo), and features excellent sound movement on the front and a surrounding atmosphere of movie theaters. Meanwhile, Dolby Pro Logic II decodes a signal encoded in 2 channels into 5-channel signals composed of the left/right front signals, center signal and surround left/right signals. Dolby Pro Logic II is an advanced version of the decoding technology used with Dolby Pro Logic. It inputs 2-channel signals from a Dolby Surround-encoded source and reproduces 5-channel signals in which the surround channel is divided into independent channels for the left and right. Dolby Pro Logic II has the MOVIE mode and MUSIC mode, and the MUSIC mode enables independent adjustment of three parameters including Panorama mode, Dimension and Center Width.
- **DTS:** DTS has five full-frequency channels that create effects nearly identical to those in a theater. Sounds seem to zoom from one place to another or entirely surround you. Like Dolby Digital, DTS has much-improved clarity, surround and sound movement capability compared with Dolby Pro Logic. This listen mode is available on CD, LD, and DVD media. DTS is a strictly digital format that can be supplied only by a CD, LD, or DVD player that supports DTS sound.
- **DSP (Digital Signal Processing):** DSP allows you to create your own custom surround sound environments and use them with any source (except Dolby Digital and DTS). You can select the ambience of an ARENA, JAZZ CLUB, THEATER, STADIUM or DISCO to your taste.
- **SRS CS II (Circle Sound II):** Circle Surround II™ improves on its predecessor Circle Surround (CS-5.1) by enabling you to experience powerful multi-channel surround sound playback from mono, stereo or Dolby Surround encoded audio and video sources. You already enjoy listening to Dolby Digital and DTS multi-channel sound through your multiple speakers. Now, with CS II you can also listen to audio CDs, MDs, television and radio broadcasts in full surround sound. You will discover a new type of sound experience through SRS Circle Surround II.

The CS system dramatically reduces storage space requirements for multi-channel content. It creates a listening environment that places the listener "inside" music performances, and dramatically improves both hi-fi audio and conventional surround encoded video material. In addition, the CS II decoder includes patented SRS Dialog Clarity Enhancement™ and TruBass™ technologies. When translated over home theater, dialog mixed for the cinema may become difficult to understand and SRS Dialog Clarity solves this problem by improving dialog clarity, even when playing back Dolby Digital or DTS sources. TruBass creates rich, deep bass in small speaker systems without the need for a subwoofer.

- **Stereo:** Stereo listen mode provides standard stereo sound to the front left and right speakers.

Description of Dolby Pro Logic II: Music mode

Panorama mode : Expands the image of front-channel stereo to the surround speakers to create a sound environment that fills your surroundings. (To change the Panorama mode, press **SOUND** key at the time of Dolby Pro Logic II Music mode. Display the **PANO R OFF** or **ON**, then press the **TRIM (▲/▼)** keys to select **ON** or **OFF**.)

Dimension : This controls the balance between the Front and Rear in 2 steps on the front and 2 steps on the rear. Set this parameter to one of the Front steps if the surround effect is too strong, or to one of the Back steps if it is too weak. (To change the Dimension, press **SOUND** key twice at the time of Dolby Pro Logic II Music mode. Display the **DIMEN 0** (or other value), then press the **TRIM (▲/▼)** keys to select **F-2, F-3, R-2** or **R-3**.)

Center Width : The center channel signal can be divided and distributed to the Front L/R channels. The adjustment for distributing the center channel signal to the front channels can be applied in eight steps from 0 to 7. Use this adjustment when the center image seems to be too strong. (To change the Center Width, press **SOUND** key 3 times at the time of Dolby Pro Logic II Music mode. Display the **C WIDTH 3** (or other value), then press the **TRIM (▲/▼)** keys to select **0 ~7**.)

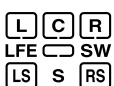

The **INPUT/OUTPUT** status indicator becomes an input indicator at the time of **DOLBY DIGITAL** and **DTS** source and an output indicator at all other times.

To set the LISTEN mode manually

According to the contents of the disc played in this unit, the LISTEN MODE (selected by the Listen mode key) can be found in the following table

SOURCE LISTEN MODE	DISC				Input	
	DOLBY DIGITAL (5.1ch)	DOLBY DIGITAL (2ch)	DTS	VCD/CD (PCM, MP3)	*SAT/CABLE /FRONT DIGITAL COAX/OPTI	SAT/CABLE /VCR/FRONT ANALOG
DOLBY DIGITAL	<input type="radio"/>	<input type="radio"/>			<input type="radio"/>	
DTS			<input type="radio"/>		<input type="radio"/>	
DOLBY PRO LOGIC II		<input type="radio"/>		<input type="radio"/>	<input type="radio"/>	<input type="radio"/>
DOLBY PRO LOGIC		<input type="radio"/>		<input type="radio"/>	<input type="radio"/>	<input type="radio"/>
CS II MUSIC CS II CINEMA CS II MONO				<input type="radio"/>	<input type="radio"/>	<input type="radio"/>
DSP ARENA JAZZ CLUB THEATER STADIUM DISCO				<input type="radio"/>	<input type="radio"/>	<input type="radio"/>
STEREO	<input type="radio"/>	<input type="radio"/>	<input type="radio"/>	<input type="radio"/>	<input type="radio"/>	<input type="radio"/>

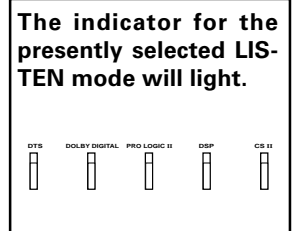

*Selectable Listen modes by SAT / CABLE / FRONT Digital input differs according to the input source.

Press the Listen mode key.

REMOTE

Listen mode

Each press switches the modes as shown below.

- | | |
|--|---|
| <p>(At the time of PCM source)</p> <ol style="list-style-type: none"> ① DOLBY PL II MOVIE ② DOLBY PL II MUSIC ③ DOLBY PRO LOGIC ④ CS II MUSIC ⑤ CS II CINEMA ⑥ CS II MONO ⑦ ARENA ⑧ JAZZ CLUB ⑨ THEATER ⑩ STADIUM ⑪ DISCO ⑫ STEREO | <p>(At the time of DTS source)</p> <ol style="list-style-type: none"> ① DTS ② DTS STEREO <p>(At the time of DOLBY DIGITAL source)</p> <ol style="list-style-type: none"> ① DOLBY DIGITAL ② STEREO |
|--|---|

Operations

Manufactured under license from Dolby Laboratories. "Dolby", "Pro Logic" and the double-D symbol are trademarks of Dolby Laboratories.

"DTS" and "DTS Digital Surround" are trademarks of Digital Theater Systems, Inc.

"Circle Surround II" and (●) symbol are trademarks of SRS Labs, Inc. "Circle Surround II" technology is incorporated under license from SRS Labs, Inc.

Positioning the speakers

To achieve the optimum effects obtainable with this SURROUND SOUND system, it is important to position the speakers properly. Refer to the following illustration to find the best location in your room.

Preparation

- 1 Play a disc marked "Dolby Digital". → 26

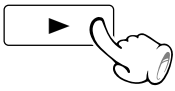

- 2 Stop the playback.

AUTO/MONO

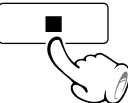
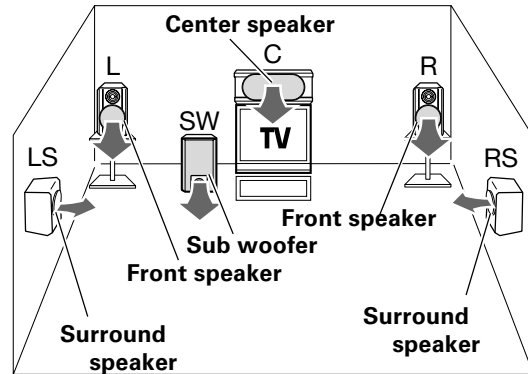
For this unit, the speaker levels have been set in advance so that the best volume balance is obtained with standard use.



Initial set values for the speaker level

Left Front channel (Lch)(L)	: 0dB
Center channel (Cch)(C)	: 0dB
Right Front channel (Rch)(R)	: 0dB
Right Surround channel (RSch)(RS)	: 0dB
Left Surround channel (LSch)(LS)	: 0dB
Subwoofer(SW)	: 0dB

Reset as follows to match your listening environment.

Speaker level setting

- 1 Press **SETUP** key for more than 2 seconds

SETUP
Active EQ./
SOUND

- 2 Press the **TRIM** (▲/▼) keys to control the speaker level.

TRIM

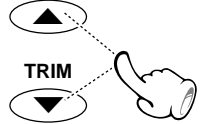
- After all speakers have been adjusted, operate the Delay time setting (→ 55).
- If you want to quit at this time, press the **ENTER** key.

The test tone is played back from the Left Front speaker. Adjust the **VOLUME CONTROL** so that it is slightly loud and fix it there.

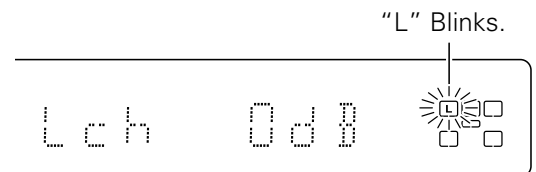

The speakers will be switched as follows in intervals of about 2 seconds.

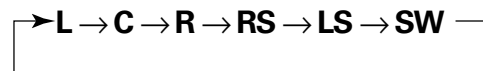

Adjust the volume with the TRIM (▲/▼) keys while the indicator is flashing so that the volume from all speakers except the subwoofer (SW) appears the same. Level adjustment is possible in the range from -10 dB to +10 dB.



As the subwoofer (SW) has a special playback band, normal adjustment is not possible with the test tone. Please adjust the subwoofer while listening to actual music. (→ 56)

The ideal listening position for 6-channel surround playback is the point at equal distance from all speakers. By setting the delay time for the center and surround speakers, this item realizes the ideal listening position virtually. (The center and surround speakers can be set as if they are laid out on the dotted line circle shown below.)

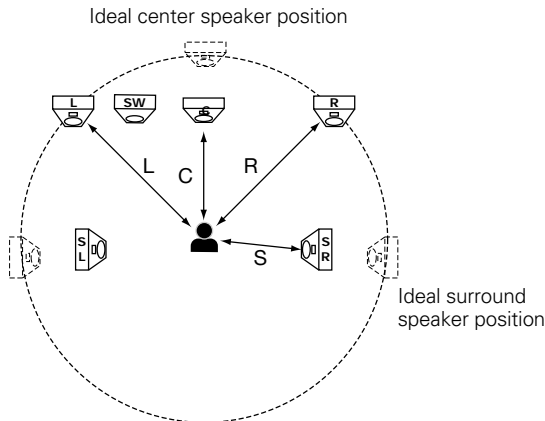

How to set the delay time

Delay time setting sets the delay time converted to the distance from the speaker to the listening position.

The front speakers (L/R) can be adjusted between 40 feet (12 m) and 3 feet (0.9 m).

The range which can be set for the center speaker (C) and the surround speakers (LS/RS) differs according to the setting for the front speakers. A longer distance than for the front speakers can not be set.

Delay time setting

This operation must be performed following the adjustment of the speaker level setting on page 54.

① Press SETUP key.



② Press the TRIM (▲/▼) keys to select the speaker distance.

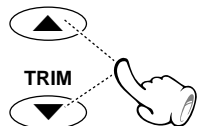

③ Press SETUP key.



④ Press the TRIM (▲/▼) keys to select the speaker distance.

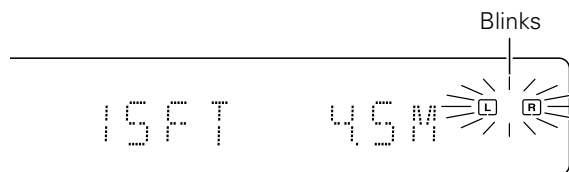
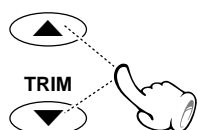

Return to the original display is made when no operation is performed for about 5 seconds.

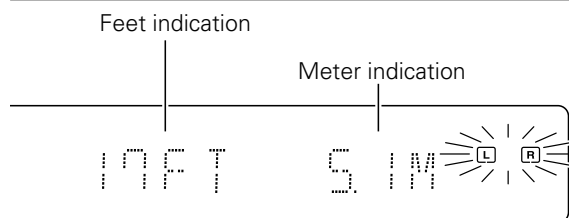

The process advances to center speaker adjustment when the SETUP key is pressed.

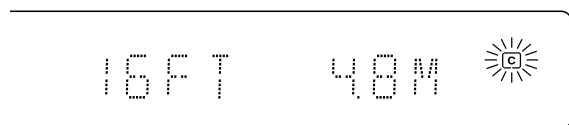
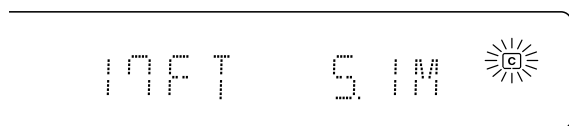

Repeat ③ and ④ in the same way to adjust the surround speakers.

Level setting using a music source

A music source can be used for speaker level setting and subwoofer level setting.

1 Play a disc marked "Dolby Digital".

2 Select the speaker.

3 Press the TRIM (▲/▼) key to setting the speaker level.

Speaker level adjustment can be performed by pressing the keys FRONT, CENTER, REAR, and SW.

F: Front speakers

Switching is done as follows each time the switch is pressed.

- ▶ ① L ch : Left speaker
- ▶ ② R ch : Right speaker

C: Center speaker

R: Rear (Surround) speakers

Switching is done as follows each time the switch is pressed.

- ▶ ① LS ch : Left surround speaker
- ▶ ② RS ch : Right surround speaker

SW: Subwoofer

The speaker level can be changed in the range from -10 dB to +10 dB.

Changing the INPUT MODE

The input mode can be switched with SAT/CABLE and FRONT. For better sound quality, connect the digital output of your component with a coaxial or optical cable and change the input mode as follows.

1 Select the SAT, CABLE or FRONT key.

2 Press the INPUT MODE key.

Note When the video is displayed, but no sound is put out, the source may not contain digital audio. In such a case, please switch to ANALOG.

- AUTO input mode only checks the input signal when the INPUT is changed. The input does not automatically switch from digital (optical/coaxial) to ANALOG when the digital signal from the source component stops. In this case, use the remote to select ANALOG input mode.

Each press switches the mode.

SAT/CABLE input

- ▶ ① AUTO
- ▶ ② COAXIAL
- ▶ ③ ANALOG

FRONT input

- ▶ ① AUTO
- ▶ ② OPTICAL
- ▶ ③ ANALOG

Register the setup codes for your audio and video

The devices which can be set up are TV, VCR, SAT (satellite tuner), and CABLE.



1 Press and hold the SOURCE (⏻) key. You must hold down the SOURCE (⏻) key until you reach step 4.

SOURCE



2 Use the numeric keys to enter the setup code.



1	2	3
4	5	6
7	8	9
PGM +100	0	CLEAR +10

3 Press the device key to assign the setup code.



DVD/CD	TUNER	SAT
BAND	BAND	
VCR	CABLE	TV
		FRONT AUX

4 Release the SOURCE (⏻) key.

5 Press the SOURCE (⏻) key, CH +/- keys, etc. to test the code.

- You can assign VCR, CABLE, or SAT preset codes to the FRONT device key.
- If you input a setup code that cannot be assigned to the selected device key, the key's original setting is retained.

Operating other devices

1 Press one of device keys for operation.



DVD/CD	TUNER	SAT
BAND	BAND	
VCR	CABLE	TV
		FRONT AUX

2 Press SOURCE ⏻ key to turn the device on.



SOURCE



3 Press device operate key.
(Keys which can be used to operate connected devices → 63)

Setup code table (except for U.S.A. and Canada)

TV

BRAND	Setup codes			
AIWA	100	101		
AKAI	102	103		
AUDIO SONIC	104			
BLAUPUNKT	105			
BRIONVEGA	106	107		
COLTINA	108	109	110	
CROWN	111	112		
DAEWOO	113	114		
DUAL	115			
FENNER	116	117		
FERGUSON	118	119		
FUNAI	120	121	122	
FUJITSU GENERAL	123	124	125	
GOODMANS	127			
GRUNDIG	128	129		
HITACHI	130	131		
HYPER	132			
INNO-HIT	133			
IRRADIO	102			
JVC	134	135	136	137
KENDO	138			
LOEWE	139	140		
LUXOR	141			
MARK	142			
MATSUI	143	144	145	146
mitsubishi	147	148	149	150
MIVAR	151	152		
NEC	153	154		
NOKIA	155	156	157	158
NOKIA OCEANIC	158			
NORDMENDE	159	160		
OKANO	133			
ORION	161	162	163	
PANASONIC	126	164	165	166
	167			
PHILIPS	168	133		
PIONEER	169	170		
SABA	159	160	171	
SAMSUNG	172	173	174	175
	176			
SANYO	177	178	179	180
SCHNEIDER	102			
SELECO	181	182		
SHARP	183	184		
SONY	185	186	187	188
	189	190		
TELEFUNKEN	171	191	192	
THOMSON	193			
TOSHIBA	194	195		
UNIVERSUM	196			

VCR

BRAND	Setup codes			
AIWA	400	401	402	
AKAI	403	404		
BAIRD	405			
BLAUPUNKT	406			
CGM	407	408	409	
COLTINA	410			
DAEWOO	411			
DIGTAL	412			
FENER	413			
FUJITSU GENERAL	414			
FUNAI	415			
GOLDSTAR	416			
GOODMANS	417			
GRUNDIG	418			
HITACHI	419	420	421	
JVC	422	423	424	425
	426	427	428	
LOEWE	429	430		
MITSUBISHI	433	434	435	436
	437	438		
NEC	439	440	441	
NOKIA	409			
NORDMENDE	442	443		
OKANO	444	445		
ORION	446			
PANASONIC	431	432	447	448
	449	450	451	
PHILIPS	452	453		
PHONOLA	407			
PIONEER	454			
SABA	455			
SAMSUNG	456	457	458	459
SANYO	460	461	462	488
SCOTT	463			
SELECO	464			
SHARP	465	466	467	
SIEMENS	468			
SONY	469	470	471	472
	473	474	475	476
	477	478	479	480
	481	482		
TELEFUNKEN	483	484		
TOSHIBA	485	486		
W.W.HOUSE	416			
WATSON	487			

CABLE or SAT

BRAND	Setup codes			
AMSTRAD	600	601	602	603
	632			
GRUNDIG	604	605		
PHILIPS	606	624		
PACE	607	626		
ITT	608			
SKYMASTER	609	637		
KATHREIN	610	611	635	
JVC/BT	612			
JVC	613			
PANASONIC	614			
JERROLD	615			
VIDEOWAY	616	617		
EHOSTAR	618	619	620	622
CANAL+	621			
TPS/SAGEM	623			
D-BOX	625			
NOKIA	627	634		
GALAXIS	628			
FORCE	629			
SELECTOR	630			
TRIAx	631			
MASCOM	633			
THOMSON	636			
HIRSCHMANN	638			



1. Setup codes are not available for some brands.
2. Setup codes for the listed brands may not be able to control certain components or functions.

Setup code table (for U.S.A. and Canada only)

TV

BRAND	Setup codes			
AKAI	100			
ABEX	101			
ADMIRAL	102	103		
ALARON	106			
A-MARK	108			
AMBASSADOR	109			
AMERICA ACTION	110			
AMPRO	111			
ANAM	110	112	113	
ANAM NATIONAL	114			
AOC	108	115	116	117
	118	119		
ARCHER	108			
AUDIOVOX	108	110	120	121
BAYSONIC	110			
BELCOR	115			
BELL&HOWELL	123	124		
BRADFORD	110			
BROCKWOOD	115			
BROOKSONIC	102	108	125	
CANDLE	116	126	127	
CARNIVAL	116			
CARVER	128			
CELEBRITY	131			
CENTURION	132			
CINERAL	120			
CITIZEN	116	126	127	133
	134	135		
CLAIRTONE	117			
CONCERTO	126			
CONTEC	110	117	136	137
GRAIG	110			
CROSLEY	128			
CROWN	110	135		
CURTIS MATHES	103	116	120	123
	124	126	128	133
	135	139	140	141
	142	143		
CROWN	110	135		
CXC	110			
DAEWOO	145	146	147	148
	149			
DAYTRON	115			
DENON	142			
DUMONT	115			
DWIN	144	151		
ELECTROBAND	117	131		
ELECTROHOME	152	153	154	
EMERSON	102	106	109	110
	115	117	121	123
	125	134	135	136
	148	155	156	157
	158	159	160	161
	162	163		
ENVISION	116			
FISHER	164	165		
FUNAI	106	110	166	
FUJITSU	106	167		
FUTURETECH	110			

BRAND	Setup codes			
GE	103	114	120	139
	143	144	161	162
	168	169	170	171
	172	173	174	175
	176			
GIBRALTER	115	116	150	
GOLD STAR	101	115	116	126
	152	161	177	178
	179	180	181	
GRADIENTE	126	182	183	
GRUNPY	106	110		
HALLMARK	161			
HARLEY DAVIDSON	106			
HARMAN/KARDON	128	184		
HARVARD	110	112		
HITACHI	101	124	126	142
	152	160	173	185
	186	187	188	
INFINITY	128			
JBL	128			
JCB	131			
JVC	163	182	189	190
KAWASHO	136			
KAYPANI	118			
KEC	110			
KENWOOD	115	116		
KLOSS	191			
KMC	179			
KTV	110	116	117	134
	135			
KONKA	192	193	194	195
	196			
LG	126			
LXI	123	128	139	144
	161	197		
LOGIK	124			
LUXMAN	126			
MAGNAVOX	106	116	128	191
	198	199	200	201
	202	203	204	
MAJESTIC	124	205		
MARANTZ	116	128	206	
MATSUSHITA	207			
MGA	115	116	151	208
MEGATRON	108	142	161	
MEI	117			
MEMOREX	102	106	123	124
	126	161	179	207
	208			
MIDLAND	101	135	139	143
	144	175		
MINUTZ	171			
MITSUBISHI	103	115	161	206
	208			
MOTOROLA	103	114		
MTC	115	116	117	126
	133	149		
MULTITECH	110			
NAD	141	161	197	

BRAND	Setup codes			
NEC	115	116	126	209
NIKKO	116	161		
NOBLEX	210			
NOSHI	211			
ONWA	110			
OPTIMUS	123	141	207	
OPTONICA	103	212		
ORION	102	106	125	
PANASONIC	114	143	207	213
	214	215		
PENNY	101	108	115	116
	126	133	135	139
	143	144	161	171
	172	175	181	197
	211			
PHILCO	102	115	116	128
	142	200	201	203
PHILIPS	128	198	216	217
PILOT	115	116	135	
PIONEER	141	160	218	219
PORTLAND	115	135		
PRINCETON	220			
PRISM	143			
PROSCAN	139	144	221	
PROTON	108	118	140	161
PULSAR	115			
QUASAR	114	143	207	212
	213	222		
RADIO SHARK	101	110	115	116
	123	126	135	139
	144	152	161	212
	223			
RCA	103	115	139	143
	144	160	174	175
	176	211	219	224
	225	226	227	
REALISTIC	101	110	115	116
	123	126	135	161
	212			
RHAPSODY	117			
RUNCO	116	209	228	
SAMPO	101	116	118	135
SAMSUNG	101	115	116	126
	133	161	229	230
	231			
SAMSUX	135			
SANSEI	120			
SANSUI	102			
SANYO	123	165	232	233
SCIMITSU	115			
SCOTCH	161			
SCOTT	106	110	115	161
	125			
SEARS	106	123	126	128
	139	144	161	165
	166	197	205	232
	234			
SEMIVOX	110			
SEMP	197			



1. Setup codes are not available for some brands.
2. Setup codes for the listed brands may not be able to control certain components or functions.

Setup code table (for U.S.A. and Canada only) (continued)

TV

BRAND	Setup codes			
SHARP	103	135	137	202
	212	235	236	
SHOGUN	115			
SIGNATURE	124			
SIMPSON	127	204		
SONY	131	237	238	239
	240			
SOUNDESIGN	106	110	127	161
SPECTRICON	108	119		
SQUAREVIEW	166			
SSS	110	115		
STARLITE	110			
SUPREME	131			
SYLVANIA	116	128	153	200
	201	203		
SYMPHONIC	166	241	242	
TANDY	103			
TATUNG	108	114		
TECHNICS	143	207		
TECHNOL ACE	106			
TECHWOOD	108	126	143	
	106	110	115	124
	126	127	128	133
	135	208	243	
TELEFUNKEN	126			
TMK	109	126	161	
TNCI	150			
TOSHIBA	123	133	197	234
	244			
TOSONIC	117			
TOTEVISION	135			
TRICAL	137			
UNIVERSAL	172			
VECTOR RESEARCH	116			
VIDIKRON	245			
VICTOR	182			
VIDIKRON	128	245		
VIDTECH	115	161		
VIKING	243			
WARDS	106	115	116	124
	126	128	161	171
	172	176	200	201
	203	212	238	240
WHITE	102	121	148	
WESTINGHOUSE				
YAMAHA	115	116		
ZENITH	102	124	148	150
	246	247		
ZONDA	108			

VCR

BRAND	Setup codes			
AIWA	403	404	405	
AKAI	406	407	408	409
	410			
AMERICANHIGH	411			
ASHA	412			
AUDIOVOX	405			
BEAUMARK	412			
BELL&HOWELL	413			
BROCKSONIC	414	415	416	417
CALIX	405			
CANON	411			
CARVER	418			
CCE	419			
CITIZEN	405			
COLT	419			
CRAIG	405	412	419	420
CURTIS-MAHES	409	411	421	422
CYBERNEX	412	423		
DAEWOO	424			
DENON	425			
DYNATECH	404			
ELECTROHOME	405			
ELECTROPHONIC	405			
EMEREX	426			
EMERSON	404	405	414	415
	416	417	427	428
	429	430	431	432
	433			
FISHER	413	420	434	435
	436	437		
FUJI	411	438		
FUNAI	404			
GARRARD	404			
G.E.	411	412	421	439
GO VIDEO	440	441	442	
GOLDSTAR	405			
GRADIENTE	404	443		
HARLEY DAVIDSON	404			
HARMANKARDON	418	444		
HARWOOD	419	432		
HEADQUARTER	434			
HI Q	420			
HITACHI	404	409	425	439
	445	446		
HUGHES	425			
NETWORK SYSTEMS				
JENSEN	409			
JVC	409	443	447	448
	449	450	451	
KEC	405			
KENWOOD	409	444	451	
KLH	419			
KODAK	405	411		
LG	405	444		
LLYOD'S	404			
LOGIK	419			
LXI	405			
MAGGIN	412			

BRAND	Setup codes			
MAGNAVOX	404	411	418	452
	453			
MARANTZ	411	418		
MARTA	405			
MATSUSHITA	411	422		
MEI	411			
MEMOREX	404	405	411	412
	413	420	422	434
	453	454		
MGA	412	431		
MGN TECHNOLOGY	412			
MINOLTA	425			
MITSUBISHI	431	451	455	456
	457	458	459	
MOTOROLA	411			
MTC	404	412		
MULTITECH	404	419		
NAD	460			
NEC	412	413	421	446
	451	461	462	
NIKKO	405			
NIKON	463			
NOBLEX	412			
OLYMPUS	411			
OPTIMUS	405	413	422	460
ORION	414	416		
PANASONIC	411	422	464	465
PENNEY	405	411	412	421
	425	437	444	
PENTAX	425			
PHILCO	411			
PHILIPS	411	418	466	
PILOT	405			
PIONEER	451	460		
PROFITRONIC	412			
PROSCAN	421			
PROTEC	419			
PULSAR	423	453		
QUARTER	434			
QUARTZ	434			
QUASAR	422	464	465	
RADIO SHACK	404	454		
RADIX	405			
RANDEX	405			
RCA	411	412	421	425
PEALISTIC	404	405	411	413
	420	434		
REPLAYTV	465	467		
RICOH	463			
RUNCO	453			
SAMSUNG	410	412	423	424
	468			
SANKY	453			
SANSUI	404	409	451	446
SANYO	412	413	420	434
	469			
SCOTT	415	416	424	431



1. Setup codes are not available for some brands.
2. Setup codes for the listed brands may not be able to control certain components or functions.

Setup code table (for U.S.A. and Canada only) (continued)

VCR				
BRAND	Setup codes			
SEARS	404	405	411	413
	420	425	434	437
SEMP	424			
SHARP	401	470		
SHINTOM	419	471		
SHOGUN	412	423		
SINGER	419			
SONY	404	411	426	438
	463	472	473	474
STS	425			
SYLVANIA	404	411	418	431
SYMPHONIC	404			
TATUNG	409			
TEAC	404	409		
TECHNICS	411	422		
TEKNIKA	404	405	411	475
THOMAS	404			
TIVO	466			
TMK	412	430		
TOSHIBA	424	431	476	
TOTEVISION	405	412		
UNITECH	412			
VECTOR	424			
VECTOR RESEARCH	421	444		
VIDEO CONCEPTS	421	424		
VIDEOSONIC	412			
WARDS	404	411	412	418
	419	420	421	425
XR-1000	404	411	419	
YAMAHA	444			
ZENITH	404	438	453	463
	477			

CABLE				
BRAND	Setup codes			
ABC	600	601	602	603
	604	605	606	607
	689			
ALLEGRO	608	609		
AMERICAST	610			
ANTRONIX	611	612		
ARCHER	609	611	612	613
	614			
BELCOR	616			
BELL&HOWELL	601			
BELL SOUTH	610			
CABLE STAR	616			
CABLETENNA	612			
CABLEVIEW	612			
CENTURY	609			
CITIZEN	608	609		
COLOUR VOICE	617	618		
COMTRONICS	621			
CONTEC	622			
DIGI	623			
EASTERN	624			
EMERSON	613			
EVERQUEST	620	625		
FOCUS	626			
GARRARD	609			
GC ELECTRONICS	611	616	627	
GEMINI	613	625	628	629
	630			
GENERAL INSTRUMENT	602	631	632	
GOLD STAR	633			
GOODMIND	613	634		
HAMLIN	635	636	637	638
	639	640		
HITACHI	602			
HYTEX	604			
JASCO	608	609	625	
JERROLD	601	602	603	625
	631	642	643	644
	645	646	647	648
	695			
LINSAY	649			
MACOM	600	650	651	652
MAGNAVOX	653	654		
MEMOREX	655			
MOTOROLA	656			
MOVIE TIME	657	658		
NEXUS	634			
NOVAPLEX	659			
NSC	629	657	658	
OAK	604	622	660	661
	662			
OPTIMUS	663			
PANASONIC	655	663	664	665
PANTHER	623			
PARAGON	655			
PHILIPS	609	617	618	621
	628	654	666	667
	668	669	670	671
	672	673		

BRAND	Setup codes			
PIONEER	633	674	675	676
	677	678	679	
POPULAR MECHANICS	626			
PRELUDE	634			
PULSAR	655			
QUASAR	655			
RCA	663			
RADIO SHACK	608	613	625	680
REALISTIC	611			
RECOTON	626			
REGAL	636	640		
REGENCY	624			
REMBRANDT	602	629		
RUNCO	655			
SCIENTIFIC	681	682		
SCIENTIFIC	606	607	678	681
ATLANTA	682	683	684	685
SAMSUNG	633			
SEAM	686			
SIGNAL	620	625		
SIGNATURE	602			
SPRUCER	663			
STAR SIGHT	687	688		
STARCOM	602	625		
STARGATE	613	620	625	634
STARQUEST	625			
SYLVANIA	689			
TFC	692			
TV86	657			
TANDY	690			
TELECAPTION	691			
TELEVIEW	620			
TEXSCAN	689			
TIMELESS	693			
TOCOM	605	694	695	
TOSHIBA	655			
TUSA	625			
UNIKA	609	611	612	
UNIVERSAL	609	611	612	614
	616	696	697	
UNITED ARTISTS	604			
VIEWSTAR	621	654	657	690
ZENITH	610	655	698	699
	700			
ZENTEK	626			



1. Setup codes are not available for some brands.
2. Setup codes for the listed brands may not be able to control certain components or functions.

Setup code table (for U.S.A. and Canada only) (continued)

SATELLITE

BRAND	Setup codes			
ATPHASTAR	800			
CHAPARRAL	804	805		
ECHOSTAR	806	807	808	809
	810			
EXPRESSVU	806			
GENERAL INSTRUMENT	801	802	803	811
HTS	806			
HITACHI	812	813		
HOMECABLE	814			
HUGHES NETWORK SYSTEMS	815			
JANEIL	817			
JERROLD	801	802		
JVC	806			
LEGEND	808			
MAGNAVOX	818	819		
MEMOREX	808	819		
NEXT LEVEL	803			
PANASONIC	817	820	821	
PHILIPS	818	819	822	
PRIMESTAR	801	802	823	
PROSCAN	824			
RADIO SHACK	803			
RCA	824	825	826	827
	828			
REALISTIC	829			
SAMSUNG	830			
SONY	831			
STAR CHOICE	803			
TOSHIBA	815	833	834	
UNIDEN	814	818	819	829
	835	836		
ZENITH	837			



1. Setup codes are not available for some brands.
2. Setup codes for the listed brands may not be able to control certain components or functions.

Keys which can be used to operate connected devices

Operation of the dark-colored keys in the figure is possible.

VCR

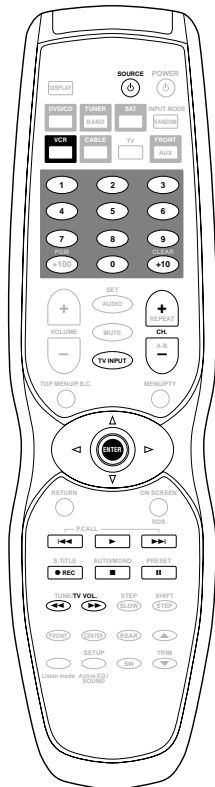

(Operation keys differing from the indication)

- ◀◀▶▶ : VCR REW/FF
- ▶ : VCR PLAY
- : VCR REC
- : VCR STOP
- ◀◀▶▶ : TV VOL. DOWN/UP

TV

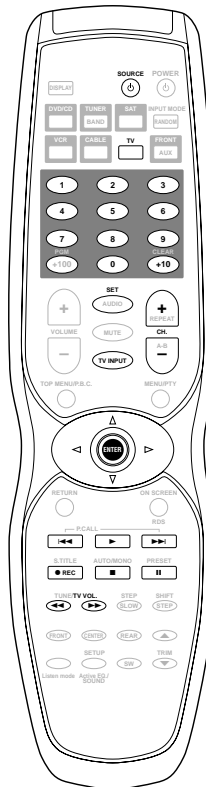

(Operation keys differing from the indication)

- SET : ENTER
- ◀◀▶▶ : VCR REW/FF
- ▶ : VCR PLAY
- : VCR REC
- : VCR STOP
- ◀◀▶▶ : TV VOL. DOWN/UP

CABLE

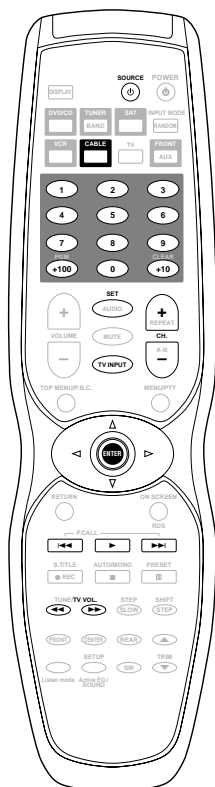

(Operation keys differing from the indication)

SET : ENTER

SAT

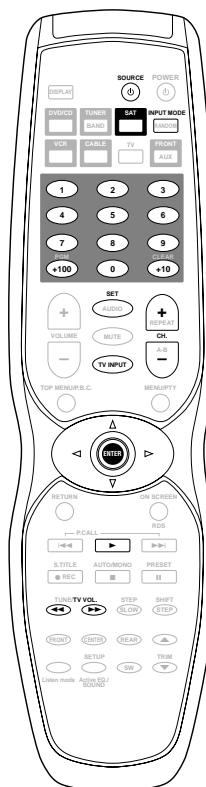

(Operation keys differing from the indication)

SET : ENTER



You can assign VCR, CABLE, or SAT preset codes to the FRONT AUX device key.

DVD menu language code list

Cord No.	Language
6565	Afar
6566	Abkhazian
6570	Afrikaans
6577	Amharic
6582	Arabic
6583	Assamese
6588	Aymara
6590	Azerbaijani
6665	Bashkir
6669	Byelorussian
6671	Bulgarian
6672	Bihari
6678	Bengali; Bangla
6679	Tibetan
6682	Breton
6765	Catalan
6779	Corsican
6783	Czech
6789	Welsh
6865	Danish
6869	German
6890	Bhutani
6976	Greek
6978	English
6979	Esperanto
6983	Spanish
6984	Estonian
6985	Basque
7065	Persian
7073	Finnish
7074	Fiji
7079	Faroese
7082	French
7089	Frisian
7165	Irish
7168	Scots Gaelic
7176	Galician
7178	Guarani
7185	Gujarati
7265	Hausa
7273	Hindi

Cord No.	Language
7282	Croatian
7285	Hungarian
7289	Armenian
7365	Interlingua
7378	Indonesian
7383	Icelandic
7384	Italian
7387	Hebrew
7465	Japanese
7473	Yiddish
7487	Javanese
7565	Geogian
7575	Kazakh
7576	Greenlandic
7577	Cambodian
7578	Kannada
7579	Korean
7583	Kashmiri
7585	Kurdish
7589	Kirghiz
7665	Latin
7678	Lingala
7679	Laothian
7684	Lithuanian
7686	Latvian; Lettish
7771	Malagasy
7773	Maori
7775	Macedonian
7776	Malayalam
7778	Mongolian
7779	Moldavian
7782	Marathi
7783	Malay
7784	Maltese
7789	Burmese
7865	Nauru
7869	Nepali
7876	Dutch
7879	Nowegian
7982	Oriya
8065	Punjabi

Cord No.	Language
8076	Polish
8083	Pashto; Pushto
8084	Portuguese
8185	Quechua
8277	Rhaeto-Romance
8279	Romanian
8285	Russian
8365	Sanskrit
8368	Sindhi
8372	Serbo-Croatian
8373	Singhalese
8375	Slovak
8376	Slovenian
8377	Samoan
8378	Shona
8379	Somali
8381	Albanian
8382	Serbian
8385	Sundanese
8386	Swedish
8387	Swahili
8465	Tamil
8469	Telugu
8471	Tajik
8472	Thai
8473	Tigrinya
8475	Turkmen
8476	Tagalog
8479	Tonga
8482	Turkish
8484	Tatar
8487	Twi
8575	Ukrainian
8582	Urdu
8590	Uzbek
8673	Vietnamese
8679	Volapük
8779	Wolof
8872	Xhosa
8979	Yoruda
9072	Chinese
9085	Zulu

What seems to be a malfunction is not always so. Before calling for service, check the following table according to the symptom of your trouble.

Operation to reset

The microcomputer may fall into malfunction (impossibility to operate, erroneous display, etc.) when the power cord is unplugged while power is ON or due to an external factor. In this case, execute the following procedure to reset the microcomputer and return it to normal condition.

Set the POWER switch to ON (set to Standby mode). Then press the ►► key, ◀◀ key and STOP key in this order.

- Please note that resetting the microcomputer clears the contents stored in and returns and to condition when it left the factory.

Receiver, speakers

Symptom	Cause	Remedy
Sound is not produced.	<ul style="list-style-type: none"> ● The speaker cords are disconnected. ● The MUTE switch of remote control unit is switched ON. ● The headphone plug is inserted into the jack. 	<ul style="list-style-type: none"> ● Connect properly referring to "System connection". → 12 ● Switch MUTE OFF. → 18 ● Unplug the headphone plug. → 18
Sound is not produced from the left or right speakers.	<ul style="list-style-type: none"> ● The speaker cords are disconnected. 	<ul style="list-style-type: none"> ● Connect properly referring to "System connection". → 12
Radio stations cannot be received.	<ul style="list-style-type: none"> ● The antennas have not been connected. ● A proper broadcasting band has not been selected. ● The frequency of the station to be received is not tuned. 	<ul style="list-style-type: none"> ● Connect antennas. → 13 ● Select a band. → 21 ● Tune to the frequency of the desired station. → 21
Noise interferes.	<ul style="list-style-type: none"> ● Car ignition noise. ● Influence of an electric appliance. ● A TV set is installed near the system. 	<ul style="list-style-type: none"> ● Install the outdoor antenna in an apart position from the road. → 13 ● Switch the suspected electric appliance OFF. ● Install the TV or the system at an increased distance between them.
A station has been preset but it cannot be received by pressing the PCALL key.	<ul style="list-style-type: none"> ● The frequency of the preset station is not tunable. ● The preset memory has been cleared because the power cord has been unplugged for a long period. 	<ul style="list-style-type: none"> ● Preset stations with tunable frequencies. ● Preset stations again. → 22
The STANDBY indicator flashes red rapidly.	<ul style="list-style-type: none"> ● The temperature protection inside the unit has operated because of an excessive volume. 	<ul style="list-style-type: none"> ● Leave the unit with the power off for about 15 minutes, and then turn the power on. If this does not help, contact your dealer for service.
No sound from the surround speakers	<ul style="list-style-type: none"> ● The Listen mode is STEREO. 	<ul style="list-style-type: none"> ● Select Surround with the Listen mode key. → 53





Remote control unit

Symptom	Cause	Remedy
Remote control operation is not possible.	<ul style="list-style-type: none"> ● Batteries are exhausted. ● The remote control is too far away from the system, the controlling angle is deviated or there is an obstacle in between. ● There is no disc set in the component to be played. 	<ul style="list-style-type: none"> ● Replace with new batteries. → 17 ● Operate the unit inside the remote controllable range. → 17 ● Set a disc in the component to be played. → 26
	<ul style="list-style-type: none"> ● Operation has been performed with the keys of the main unit. ● A nonfunctional key has been pressed. 	<ul style="list-style-type: none"> ● Perform operation after once pressing the key for the input or device to be operated. → 18



DVD / CD player unit

Symptom	Cause	Remedy
Playback does not start when the play (▶/) key is pressed.	<ul style="list-style-type: none"> ● There is no disc in the player. ● There are no signals recorded on the side of the disc being played. 	<ul style="list-style-type: none"> ● Load a disc and press the play (▶/) key. → 26 ● Turn the disc over and properly place it on the disc tray. → 26
Playback starts but no image/sound is seen/heard.	<ul style="list-style-type: none"> ● The TV is not turned on. ● The connection cords are not properly connected. 	<ul style="list-style-type: none"> ● Turn on the TV. ● Properly reconnect the connection cords. → 14
The picture is disrupted when the image is fast forwarded or fast reversed.	<ul style="list-style-type: none"> ● The picture is slightly disrupted during fast forward and fast reverse operations. 	<ul style="list-style-type: none"> ● This is not a malfunction.
No sound is heard.	<ul style="list-style-type: none"> ● The volume control of this set is not adjusted properly. ● The player is in a special playback mode. 	<ul style="list-style-type: none"> ● Set the sound volume to an appropriate level. → 18 ● Press the play (▶/) key to resume normal playback mode. → 26
The picture does not look good or the picture/sound quality is poor.	<ul style="list-style-type: none"> ● A nearby device is generating noise. ● The disc is dirty. ● The disc is damaged. ● There is condensation on the optical lens. 	<ul style="list-style-type: none"> ● Separate this unit as far as possible from the device you think is generating the noise. ● Refer to the "Disc handling precautions" section and wipe dirt from the disc. → 8 ● Use a new disc. ● Refer to the "Caution on condensation" section and evaporate the condensation. → 7
It takes a while for the disc to start playing.	<ul style="list-style-type: none"> ● Time is required for the unit to detect the disc type and size and for the rotation of the motor to stabilize. This is not a malfunction. 	<ul style="list-style-type: none"> ● Approximately 10 to 20 seconds are required for a disc to start playing, although the time differs depending on the disc.
The top and bottom of the screen cannot be seen.	<ul style="list-style-type: none"> ● The video format of the disc being played does not match that of the connected TV monitor. 	<ul style="list-style-type: none"> ● Refer to the "Video format" section, and use a disc with the appropriate video format for your TV or a TV with the appropriate video format for the disc. → 11
A VCD cannot be played using menus.	<ul style="list-style-type: none"> ● The VCD disc being played is not compatible with P.B.C. 	<ul style="list-style-type: none"> ● Menu playback is available only with VCD discs recorded with P.B.C. → 37
The subtitle is not displayed.	<ul style="list-style-type: none"> ● The DVD disc being played does not contain the recording of subtitles. ● The subtitle mode is set to off. 	<ul style="list-style-type: none"> ● The subtitle cannot be displayed when the DVD disc being played does not contain the recording of subtitles. ● Press the S.TITLE key to switch on the subtitle mode. → 30
The voice (or subtitle) language cannot be changed.	<ul style="list-style-type: none"> ● The DVD disc being played does not contain the recording of more than one audio (or subtitle) language. 	<ul style="list-style-type: none"> ● The voice (or subtitle) language cannot be changed when the DVD disc being played does not contain the recording of more than one voice (or subtitle) language.

DVD / CD player unit

Symptom	Cause	Remedy
The viewing angle cannot be changed.	<ul style="list-style-type: none"> ● The DVD disc being played does not contain the recording of more than one angle. ● You are attempting to switch the angle in a DVD section where more than one angle is not recorded. 	<ul style="list-style-type: none"> ● The viewing angle cannot be changed when the DVD disc being played does not contain the recording of more than one angle. →  31 ● More than one viewing angle may be recorded only in limited sections in a disc.
A disc can not be played although the region code is displayed as [ALL].	<ul style="list-style-type: none"> ● Some discs can not be played in all regions even when [ALL] is displayed. 	<ul style="list-style-type: none"> ● Play a different disc.
Playback will not start even after a title is selected.	<ul style="list-style-type: none"> ● A viewing restriction (Parental level) has been set for the disc. 	<ul style="list-style-type: none"> ● Check the viewing restriction level (Parental level) setting. →  48
The viewing restriction level (RATING) cannot be changed.	<ul style="list-style-type: none"> ● You have forgotten the viewing restriction (Parental) password. 	<ul style="list-style-type: none"> ● Set the initial setup to the factory setup with the following procedure. With no disc in the unit, press the PLAY/PAUSE (▶/) key. After "NO DISC" is displayed, press the DVD CD key, cursor ▶ key, ◀ key, ▼ key, ▲ key on the remote and ◀◀ key on the main unit in this order. Press the POWER switch to OFF and press the POWER switch again to ON.
The voice or subtitle language selected in the initial setting is not played.	<ul style="list-style-type: none"> ● The DVD disc being played does not contain the recording of the selected voice or subtitle language. 	<ul style="list-style-type: none"> ● Use a DVD disc containing the recording of the selected voice or subtitle language. →  47
No message appears on the TV screen after a key is pressed.	<ul style="list-style-type: none"> ● The function for displaying message on the TV screen is set to off. 	<ul style="list-style-type: none"> ● Set On-screen function to on. →  28
Menu screen messages are not shown in the desired language.	<ul style="list-style-type: none"> ● The menu language function (MENU) is not set. 	<ul style="list-style-type: none"> ● Set the disc menu language function (MENU) as required. →  48

Inhibition icon

Symptom	Cause	Remedy
 The inhibition icon is displayed and remote control is not possible.	<ul style="list-style-type: none"> ● Playback is restricted intentionally by the software producer. 	<ul style="list-style-type: none"> ● The operation is inhibited. Please try another operation. →  11

Apparatus Claims of U.S. Patent Nos. 4,631,603, 4,577,216, 4,819,098 and 4,907,093 licensed for limited viewing uses only.

This product incorporates copyright protection technology that is protected by method claims of certain U.S. patents and other intellectual property rights owned by Macrovision Corporation and other rights owners. Use of this copyright protection technology must be authorized by Macrovision Corporation, and is intended for home and other limited viewing uses only unless otherwise authorized by Macrovision Corporation. Reverse engineering or disassembly is prohibited.

Consumers should note that not all high definition television sets are fully compatible with this product and may cause artifacts to be displayed in the picture. In case of 525 progressive scan picture problems, it is recommended that the user switch the connection to the "STANDARD DEFINITION" output. If there are questions regarding our TV set compatibility with this model 525p DVD player, please contact our customer service center.

Main unit

[Amplifier section]

Effective output power during STEREO operation
 1 kHz, 10 % T.H.D. at 6 Ω 40 W + 40 W

Effective output power during SURROUND operation
 Front (1 kHz, 10 % T.H.D. at 6 Ω) 40 W + 40 W
 Center (1 kHz, 10 % T.H.D. at 6 Ω) 40 W
 Subwoofer (100 Hz, 10 % T.H.D. at 6 Ω) 80 W
 Surround (1 kHz, 10 % T.H.D. at 6 Ω) 40 W + 40 W

Input sensitivity / impedance
 VCR / SAT / CABLE / FRONT 600 mV / 68 kΩ

Output level / impedance
 VCR 600 mV / 470 Ω

[Tuner section]

FM tuner section
 Tuning frequency range 87.5 MHz ~ 108 MHz

AM Tuner section
 Tuning frequency range (for U.K., Europe and Australia)
 531 kHz ~ 1,602 kHz
 Tuning frequency range (for U.S.A. and Canada)
 530 kHz ~ 1,700 kHz
 Tuning frequency range (for other countries)
 531 kHz ~ 1,602 kHz / 530 kHz ~ 1,610 kHz

[DVD/CD/VIDEO CD player section]

Laser Semiconductor laser

Wow & Flutter Less than unmeasurable Limit

Video output format (for U.S.A. and Canada) NTSC

Video output format (for other countries) NTSC/PAL

VIDEO OUTPUT

Composite video output level/impedance 1 Vp-p (75 Ω)

S-video output
 Y output level/impedance 1 Vp-p (75 Ω)
 C output level/impedance
 NTSC 0.286 Vp-p (75 Ω)
 PAL 0.3 Vp-p (75 Ω)

Component video output (only for some areas)
 Y output level/impedance 1 Vp-p (75 Ω)
 C/b output level/impedance 0.7 Vp-p (75 Ω)
 C/r output level/impedance 0.7 Vp-p (75 Ω)

Compression format MPEG1/MPEG2

[DIGITAL AUDIO section]

Sampling frequency 32 kHz, 44.1 kHz, 48 kHz

Input level/impedance/wave length
 Optical -15 dBm ~ 21 dBm (660 nm ±30 nm)
 Coaxial 0.6 Vp-p (75 Ω)

Digital output -15 dBm ~ 21 dBm
 (Wave length 660 nm)

[General]

Power consumption 130 W (for U.S.A. and Canada)
 130 W (for U.K.)
 130 W (for other countries)

Dimensions W: 440 mm (17-5/16")
 H: 93 mm (3-11/16")
 D: 410 mm (16-1/8")

Weight (net) 8.5 kg

KS-306DV Speakers (Front/Surround) (for U.S.A and Canada)

Enclosure Bass-Reflex type
 (Front Speaker Magnetically shielded)

Speaker configuration
 Woofer 80 mm (3"), cone type
 Tweeter 25 mm (1"), balanced dome type

Impedance 6 Ω

Maximum input power 40 W

Dimensions W: 111 mm (4-3/8")
 H: 156 mm (6-1/8")
 D: 129 mm (5-1/16")

Weight (net)
 Front speakers 0.9 kg (2.0 lb) (1 piece)
 Surround speaker 0.8 kg (1.8 lb) (1 piece)

KS-306DV Speakers (Center) (for U.S.A and Canada)

Enclosure Acoustic Air Suspension type (Magnetically shielded)

Speaker configuration
 Woofer 80 mm (3"), cone type
 Tweeter 25 mm (1"), balanced dome type

Impedance 6 Ω

Maximum input power 40 W

Dimensions W: 252 mm (9-15/16")
 H: 111 mm (4-3/8")
 D: 129 mm (5-1/16")

Weight (net) 1.1 kg (2.4lb)

SW-06DV Speaker (Subwoofer) (for U.S.A and Canada)

Enclosure Bass-reflex type (Magnetically shielded)

Speaker configuration
 Woofer 160 mm (6-1/2"), cone type

Impedance 6 Ω

Maximum input power 80 W

Dimensions W: 120 mm (8-11/16")
 H: 350 mm (13-3/4")
 D: 355 mm (14")

Weight (net) 5.9 kg

KSW-6100 Speakers

(Front/Center/Rear) (for other countries)

Enclosure Acoustic Air Suspension type (Magnetically shielded)

Speaker configuration
 Fullrange 50 mm, cone type

Impedance 6 Ω

Maximum input power 40 W

Dimensions W: 70 mm
 H: 125 mm
 D: 110 mm

Weight (net)
 Front and Center speakers 0.48 kg (1 piece)
 Surround speakers 0.36 kg (1 piece)

KSW-6100 Speaker (Subwoofer) (for other countries)

Enclosure Bass-reflex type

Speaker configuration
 Woofer 160 mm, cone type

Impedance 6 Ω

Maximum input power 80 W

Dimensions W: 190 mm
 H: 400 mm
 D: 355 mm

Weight (net) 5.7 kg



1. KENWOOD follows a policy of continuous advancements in development. For this reason specifications may be changed without notice.
2. Sufficient performance may not be possible at very low temperatures (0°C or less).

KENWOOD

For your records

Record the serial number, found on the back of the unit, in the spaces designated on the warranty card, and in the space provided below. Refer to the model and serial numbers whenever you call upon your dealer for information or service on this product.

Model _____ Serial Number _____

Free Manuals Download Website

<http://myh66.com>

<http://usermanuals.us>

<http://www.somanuals.com>

<http://www.4manuals.cc>

<http://www.manual-lib.com>

<http://www.404manual.com>

<http://www.luxmanual.com>

<http://aubethermostatmanual.com>

Golf course search by state

<http://golfingnear.com>

Email search by domain

<http://emailbydomain.com>

Auto manuals search

<http://auto.somanuals.com>

TV manuals search

<http://tv.somanuals.com>