

KENWOOD

AUDIO VIDEO SURROUND RECEIVER

VRS-N8100

INSTRUCTION MANUAL

KENWOOD CORPORATION

Quick Start Reference

Please read the following pages so that you can enjoy the surround sound at the best condition.

(These pages give shortcut explanations on how to connect the speaker system to the receiver, set up the speakers and play a source.)

"Let's play DVD video software" - 18 - 19

About the supplied remote control

Compared to standard remote controls, the remote control supplied with this receiver has several operation modes. These modes enable the remote control to control other audio/video components. In order to effectively use the remote control it is important to read the operating instructions and obtain a proper understanding of the remote control and how to switch its operation modes (etc.).

Using the remote control without completely understanding its design and how to switch the operation modes may result in incorrect operations.



MP3 / WMA



B60-5489-00 00 (MA) (K, P, E, X) (AP) 0403

Before applying power

 **Caution** : Read this page carefully to ensure safe operation.





Units are designed for operation as follows.

U.S.A. and Canada AC 120 V only
Australia AC 240 V only

Europe and U.K. AC 230 V only

Safety precautions

WARNING : TO PREVENT FIRE OR ELECTRIC SHOCK, DO NOT EXPOSE THIS APPLIANCE TO RAIN OR MOISTURE.

	CAUTION RISK OF ELECTRIC SHOCK DO NOT OPEN		CAUTION: TO REDUCE THE RISK OF ELECTRIC SHOCK, DO NOT REMOVE COVER (OR BACK). NO USER-SERVICEABLE PARTS INSIDE. REFER SERVICING TO QUALIFIED SERVICE PERSONNEL.
	THE LIGHTNING FLASH WITH ARROWHEAD SYMBOL, WITHIN AN EQUILATERAL TRIANGLE, IS INTENDED TO ALERT THE USER TO THE PRESENCE OF UNINSULATED "DANGEROUS VOLTAGE" WITHIN THE PRODUCT'S ENCLOSURE THAT MAY BE OF SUFFICIENT MAGNITUDE TO CONSTITUTE A RISK OF ELECTRIC SHOCK TO PERSONS.		
	THE EXCLAMATION POINT WITHIN AN EQUILATERAL TRIANGLE IS INTENDED TO ALERT THE USER TO THE PRESENCE OF IMPORTANT OPERATING AND MAINTENANCE (SERVICING) INSTRUCTIONS IN THE LITERATURE ACCOMPANYING THE APPLIANCE.		

How to use this manual

This manual is divided into five sections, Preparations, Receiver Operations, Network Operations, Remote Control, and Additional Information.

Preparations

Shows you how to connect your audio and video components to the receiver and prepare the surround processor. Since this receiver works with all your audio and video components, we will guide you in setting up your system to be as easy as possible.

Receiver Operations

Shows you how to operate the various functions available on the receiver.

Network Operations

By installing the application KENWOOD PC SERVER in a PC, the data stored in the PC can be imported in the libraries for listening to or viewing music, movie and photographic data in the PC on the libraries.

Remote Control

Shows you how to operate other components using the remote control, as well as a detailed explanation of all remote control operations. Once you have registered your components with the proper setup codes, you'll be able to operate both this receiver and your other AV components (TV, VCR, DVD player, CD player, etc.) using the remote control supplied with this receiver.

Additional Information

Shows you additional information such as "In case of difficulty" (trouble shooting) and "Specifications".

Unpacking

Unpack the unit carefully and make sure that all the accessories are present.

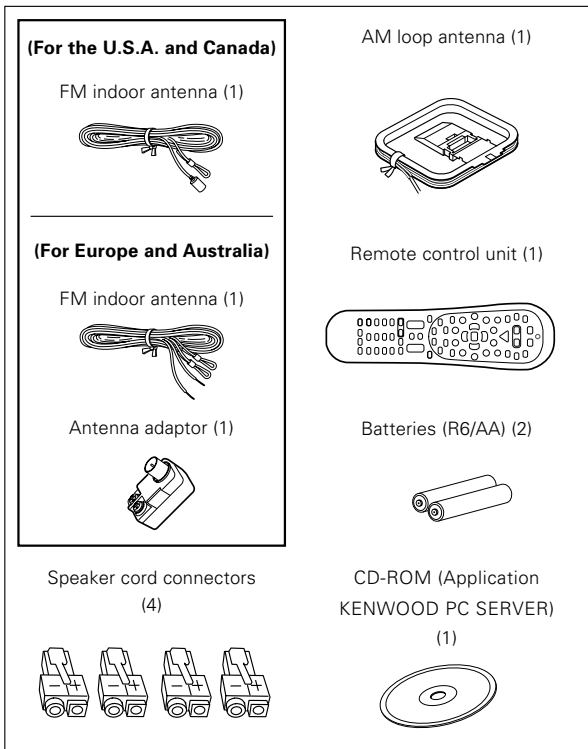

If any accessories are missing, or if the unit is damaged or fails to operate, notify your dealer immediately. If the unit was shipped to you directly, notify your shipper immediately. KENWOOD recommends that you retain the original carton and packing materials in case you need to move or ship the unit in the future.

Keep this manual handy for future reference.

Special features

Network function

Movie (video), music (audio) and photo (still image) data stored in the PC can be played back on a TV screen → 54

- ETHERNET jack → 10
- PC content editing/managing application "KENWOOD PC SERVER" → 46

PC card slot → 59

A PC card slot is provided on the front panel to enable playback of images (JPEG) captured with a digital camera.

True home theater sound → 38 ~ → 40

This receiver incorporates a wide variety of surround modes to bring you maximum enjoyment from your video software and audio source. Select a surround mode according to your equipment or the software you are going to play and enjoy!

- Dolby Digital EX
- Dolby PRO LOGIC IIX, Dolby PRO LOGIC II
- Dolby Digital
- DTS-ES
- DTS NEO:6
- DTS 96/24
- DTS
- DSP Mode
- Dolby Virtual Speaker
- Dolby Headphone

"Supreme" data audio quality improvement technology

Compressed music data such as MP3 data tends to lack expansion because the high frequencies should be cut off during compression. "Supreme" is KENWOOD-original technology for reproducing more realistic sound by estimating and interpolating the high frequencies that have been lost during compression.

The "Supreme" function is activated when music data that has 44.1 kHz sampling rate of the MP3, WMA or Ogg Vorbis format is played back. (The effects are variable depending on the bit rate.)

GAME mode function → 24

When you connect a game machine to the **GAME** jacks on the front panel, the input selector of the receiver switches automatically to "GAME" and the optimum sound field for enjoying games is set.

This feature improves your convenience in playing video games.

DUAL SOURCE function → 31

While you enjoy audio listening through the speakers, another person can enjoy another source (audio + video) through headphones by connecting the source to the **GAME, FRONT AUX** jacks.

ACTIVE EQ → 32

ACTIVE EQ mode will produce a more dynamic sound quality in any condition. You can enjoy a more impressive sound effect when ACTIVE EQ is turned on during Dolby Digital and DTS playback.

Remote control → 62

In addition to the basic receiver, the remote control supplied with this receiver can also operate almost all of your remote controllable audio and video components. Just follow the simple setup procedure to register the components you have connected.

RDS (Radio Data System) tuner (For Europe) → 36

The receiver is equipped with an RDS tuner that provides several convenient tuning functions: RDS Auto Memory, to automatically preset up to 40 RDS stations broadcasting different programs; station name display, to show you the name of the current broadcast station; and PTY search to let you tune stations by program type.

PTY (Program TYPE) search (For Europe) → 37

Tune the stations by specifying the type of program you want to hear.

Playable files with this unit

Some files may be unable to be played correctly on this unit depending on the conditions of data, connection environment and the PC in use.

■ Video data (MOVIE file) [Max. file size 2GB]

Item	Format	Extension	Detail	Audio
MPEG1	—	MPG/MPEG	Video resolution: 720 x 576 (Max.)/ Bitrate: 1.5 Mbps (Max.)	MPEG1 LAYER 1 & 2
MPEG2	—	MPG/MPEG	Video resolution: 720 x 576 (Max.)/ Bitrate: 8 Mbps (Max.)	MPEG1 LAYER 1 & 2
DivX® VIDEO *1	—	AVI	Video resolution: 720 x 576 (Max.)	WAV/MP3/ Dolby Digital
XviD	—	AVI	Video resolution: 720 x 576 (Max.)/ Bitrate: 6 Mbps (Max.)	WAV/MP3/ Dolby Digital

■ Audio data (MUSIC file) [Max. file size 2GB]

Item	Format	Extension	Detail
MPEG Audio	MPEG 1 AUDIO	MP1	LAYER 1/ Bitrate: 32~448 kbps/ CBR, VBR/ FS 32k, 44.1k, 48k
		MP2	LAYER 2/ Bitrate: 32~384 kbps/ CBR, VBR/ FS 32k, 44.1k, 48k
		MP3	LAYER 3 (MP3)/ Bitrate: 32~320 kbps/ CBR, VBR/ FS 32k, 44.1k, 48k
WMA	Ver8	WMA	Bitrate: 48~192 kbps/ CBR/ FS 32k, 44.1k, 48k
	Ver9	WMA	Bitrate: 48~192 kbps/ CBR, VBR/ FS 32k, 44.1k, 48k
WAV	—	WAV	16 bit/ FS 44.1k, 48k
Ogg Vorbis	—	OGG	Bitrate: 64~256 kbps/ FS 32k, 44.1k, 48k

■ Photo data (PHOTO file)

Item	Extension	Detail
JPEG	JPG/JPEG	24 bit True Color/ Max. file size 5MB
BMP *2	BMP	24 bit True Color/ Max. file size 5MB
GIF *2	GIF	24 bit True Color/ Max. file size 5MB
PNG *2	PNG	24 bit True Color/ Max. file size 5MB

■ Memory Card

Item	Extension	Detail
JPEG	JPG/JPEG	24 bit True Color/ Max. resolution 2,048 x 1,536/ Max. file size 2MB

*1 Plays DivX®5, DivX®4, DivX®3, DivX®VOD video content (in compliance with DivX Certified™ technical requirements)
Official DivX Certified™ product

*2 The photo data is converted into the JPEG format data when it is imported in the library.

Contents

Caution : Read the pages marked  carefully to ensure safe operation.

Preparations

- ⚠ Before applying power 2**
 - ⚠ Safety precautions 2
 - How to use this manual 3
 - Unpacking 3
 - Special features 3
 - Playable files with this unit 4
- Names and functions of parts 6**
 - Main unit 6
 - Remote control unit 7
- Setting up the system 9**
 - Connecting Ethernet cable 10
 - Connecting wireless LAN 10
 - Connecting a DVD player 11
 - Connecting video components,
audio components 12
 - Digital connections 13
 - Connecting the speakers 14
 - Connecting the speaker terminals ... 15
 - PRE OUT jacks connections 16
 - Connecting to the GAME jacks /
FRONT AUX jacks 16
 - Connecting the antennas 17
 - Preparing the remote control 17
- Let's play DVD video software 18**
- Preparing for playback 20**
 - Speaker settings 20
 - Re-assignment of rear panel jacks ... 25
 - Network settings 26

Receiver Operations

- Normal playback 30**
 - Listening to a source component ... 30
 - Listening with headphones 31
 - Adjusting the sound 31
- Recording 33**
 - Analog sources 33
 - Digital sources 33
- Listening to radio broadcasts 34**
 - Tuning (non-RDS) radio stations ... 34
 - Presetting radio stations 34
 - Receiving preset stations 35
 - Receiving preset stations in order
(P.CALL) 35
- Using RDS (Radio Data System) (For Europe only) 36**
 - Using the RDS Disp. (Display) key 36
 - Tuning by Program TYpe (PTY search) 37

Preparations

Receiver Operations

- Ambience effects 38**
 - Surround modes 38
 - Virtual modes 40
 - Surround play 41
- Convenient functions 43**
 - Adjusting the sound 43
 - Display dimmer adjustment 45
 - Sleep timer 45

Network Operations

- Installing KENWOOD PC SERVER 46**
 - Uninstalling KENWOOD PC SERVER 47
 - Updating KENWOOD PC SERVER 47
- Operating KENWOOD PC SERVER 48**
 - Names and functions of window components 48
 - Operations using the menu bar ... 48
 - Import of contents 49
- Playback of Network Server 54**
- Playback of Memory Card 59**

Remote Control

- Basic remote control operations for other components 62**
 - Setup code chart (RC-R0826) (For U.S.A., Canada and Australia) 64
 - Setup code chart (RC-R0826E) (For Europe) 69
 - DVD player , MD recorder, CD player & TV operations 76
 - VCR , Satellite receiver & Cable converter operations 77

Additional Information

- In case of difficulty 78**
 - Specifications (For U.S.A. and Canada) 81**
 - Specifications (For Europe and Australia) 82**
 - Firmware Update 83**

Maintenance of the unit
When the front panel or case becomes dirty, wipe with a soft, dry cloth. Do not use thinner, benzine, alcohol, etc. for these agents may cause discoloration.

In regard to contact cleaners
Do not use contact cleaners because it could cause a malfunction. Be specially careful not to use contact cleaners containing oil, for they may deform the plastic component.

Names and functions of parts

Main unit

TONE indicator, 96kHz fs indicator, AUTO DETECT indicator, DIGITAL indicator, Sleep Timer indicator

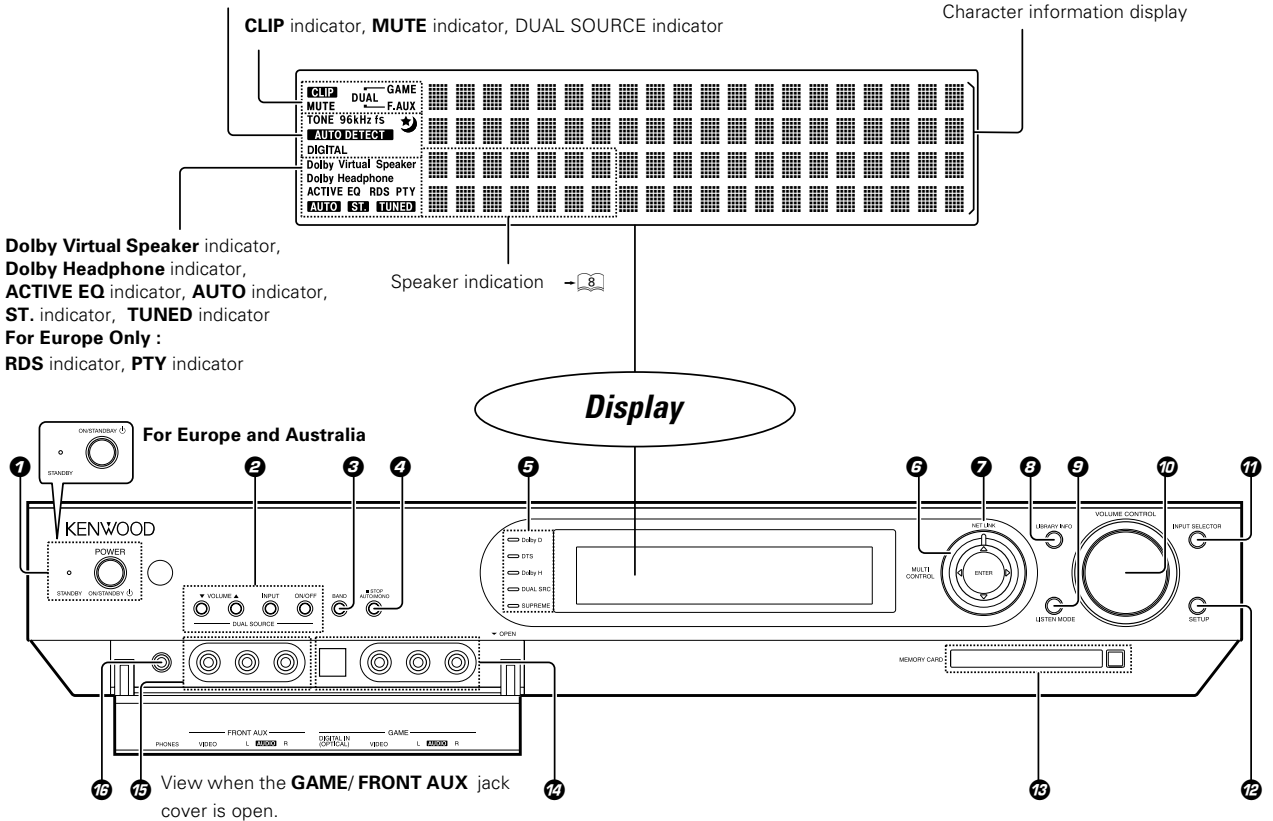

1 POWER ON/STANDBY \odot key

Use to turn the power ON/STANDBY. (For the U.S.A. and Canada) - [20] - [26]

ON/STANDBY \odot key

Use to turn the power ON/STANDBY. (For Europe and Australia) - [20] - [26]

STANDBY indicator

Lights when the power is in the standby mode.

2 DUAL SOURCE VOLUME $\blacktriangle/\blacktriangledown$ keys

Use to adjust the volume in the DUAL SOURCE mode. - [31]

DUAL SOURCE INPUT key

Use to select the input for the DUAL SOURCE mode. - [31]

DUAL SOURCE ON/OFF key

Use to switch the DUAL SOURCE mode ON/OFF. - [31]

3 BAND key

Use to select the radio broadcast band. - [34]

4 \blacksquare STOP AUTO/MONO key

Use to perform the network server operations. - [57] - [61]

Use to select the auto or manual tuning mode. - [34]

5 Dolby D indicator

Lights when the receiver is in the Dolby Digital mode. - [41]

DTS indicator

Lights when the receiver is in the DTS mode. - [41]

Dolby H indicator

Lights when the Dolby Headphone mode is ON. - [40]

DUAL SRC indicator

Lights when the DUAL SOURCE mode is ON. - [31]

SUPREME indicator

Lights when the SUPREME function is activated. - [3]

6 Joystick

MULTI CONTROL $\blacktriangle/\blacktriangledown$

Use to perform the network setup or speaker setup. - [20] - [26] - [54] - [59]

Use to tuning of radio broadcasting. - [34]

MULTI CONTROL $\blacktriangleleft/\blacktriangleright$

Use to perform the network setup or speaker setup. - [20] - [26] - [54] - [59]

Use to selection of preset radio stations. - [35]

ENTER

Use to establish a selection. - [20] - [26] - [54] - [59]

Use to presetting of radio stations. - [34]

7 NET LINK indicator

Lights when the connection to the network is established.

8 LIBRARY INFO key

Use to display the library list of the PC server on the display of this unit. - [59]

9 LISTEN MODE key

Use to select the listening mode. - [41]

10 VOLUME CONTROL knob

Use to adjust the receiver volume. - [30]

11 INPUT SELECTOR key

Use to select input sources. - [30]

12 SETUP key

Use to perform the network setup or speaker setup. - [20] - [26]

Also use to switch the REC mode ON and OFF. - [33]

13 PC card slot

Use to play images captured using a digital camera. - [59]

PC card eject button

- [59]

14 GAME jacks

- [16] - [24] - [31]

15 FRONT AUX jacks

- [16] - [31]

16 PHONES jack

Use for headphone listening. - [31]

Standby mode

While the standby indicator is lit, a small amount of power is supplied to the system to back up the memory. This is called standby mode. Under the condition, the system can be turned ON by the remote control unit.

Remote control unit

This remote control unit can be used not only for Kenwood products but also for other non-Kenwood products by setting the appropriate manufacturer's setup codes. [→ \[64\]](#)

For the U.S.A., Canada and Australia: RC-R0826

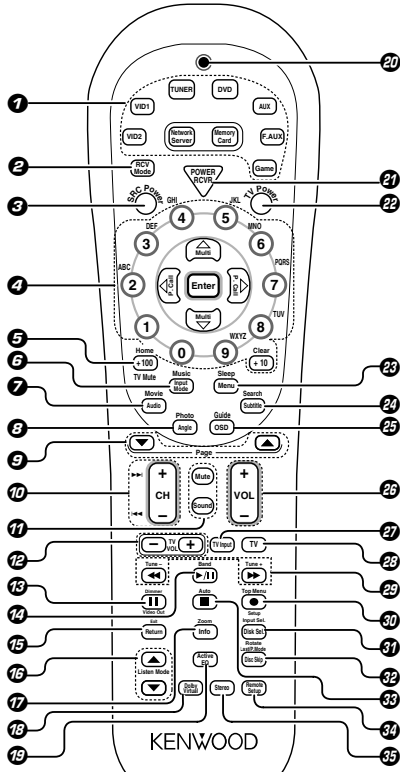

For Europe : RC-R0826E

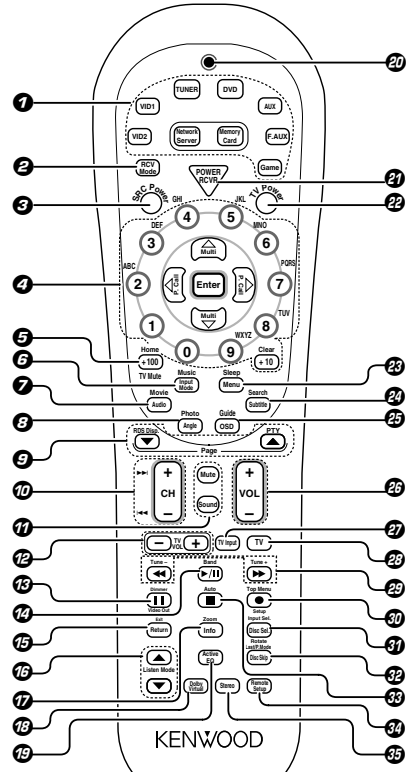

If the name of a function is different on the receiver and on the remote control, the name of the remote control key in this manual is indicated in parentheses.

1 Input Selector keys (TUNER, DVD, VID 1, VID 2, AUX, F. AUX, Game, Network Server, Memory Card)

Use to select input sources. [→ \[30\]](#)

Sources keys (DVD, VID 1, VID 2, AUX, F. AUX, Game)

To control one of the registered sources without switching the receiver's input selector to that source, press and hold the desired input selector key for more than 3 seconds. [→ \[62\]](#)

2 RCV (receiver) Mode key

Use to switch the remote control to the receiver control mode. [→ \[43\]](#)

3 SRC (source) Power key

Use to turn the other components ON/OFF. [→ \[62\]](#)

4 Numeric keys

Use to input numeric or alphabetic characters. [→ \[26\]](#) [→ \[57\]](#)

Use to selection of preset radio stations. [→ \[35\]](#)

Use to operate other components. [→ \[62\]](#)

Clear key

Use to clear a character input by mistake. [→ \[26\]](#) [→ \[57\]](#)

Multi (Δ/▽) keys

Use to perform the network setup or speaker setup.

[→ \[20\]](#) [→ \[26\]](#) [→ \[54\]](#) [→ \[59\]](#)

Use to tuning of radio broadcasting. [→ \[34\]](#)

Use to operate other components. [→ \[62\]](#)

P.Call </> keys

Use to perform the network setup or speaker setup.

[→ \[20\]](#) [→ \[26\]](#) [→ \[54\]](#) [→ \[59\]](#)

Use to selection of preset radio stations. [→ \[35\]](#)

Enter key

Use to establish a selection. [→ \[20\]](#) [→ \[26\]](#) [→ \[54\]](#) [→ \[59\]](#)

Use to operate other components. [→ \[62\]](#)

5 Home key

Use to perform the network server operations. [→ \[55\]](#) [→ \[60\]](#)

+100 key

Use to operate other components. [→ \[62\]](#)

TV Mute key

Use to temporarily mute the TV sound. [→ \[62\]](#)

6 Music key

Use to perform the network server operations. [→ \[54\]](#)

Input Mode key

Use to switch between the full auto, digital and analog input. [→ \[9\]](#)

7 Movie key

Use to perform the network server operations. [→ \[54\]](#)

Audio key

Use to operate the DVD component. [→ \[62\]](#)

8 Photo key

Use to perform the network server operations. [→ \[54\]](#)

Angle key

Use to operate the DVD component. [→ \[62\]](#)

9 Page ▲/▼ keys

Use to perform the network server operations. [→ \[55\]](#) [→ \[60\]](#)

Use to operate the DVD component. [→ \[62\]](#)

(For Europe only)

RDS Disp. key

Use to receive RDS broadcast. [→ \[36\]](#)

PTY key

Use for PTY search. [→ \[37\]](#)

Continued to next page

- 10** **▶▶ / ◀◀ keys**
Use to perform the network server operations. - [57] - [61]
Use to operate the CD, DVD or MD component. - [62]
- CH +/- keys**
Use to select the channels. - [62]
- 11** **Mute key**
Use to temporarily mute the sound. - [32]
- Sound key**
Use to adjust the sound quality and the ambience effects. - [31] - [32] - [43]
- 12** **TV VOL +/- keys**
Use to adjust the TV's volume. - [62]
- 13** **Video Out key**
Use to switch the video output temporarily. - [27] - [58]
- Dimmer key**
Use to adjust the brightness of the display. - [45]
- key**
Use to operate other components. - [62]
- 14** **▶/■ key**
Use to perform the network server operations. - [57]
Use to operate the CD, DVD, MD or VCR component. - [62]
- Band key**
Use to select the broadcast band. - [34]
- 15** **Return key**
Use to perform the network server operations. - [57] - [61]
Use to operate the DVD component. - [62]
- Exit key**
Use to operate other components. - [62]
- 16** **Listen Mode ▲/▼ keys**
Use to select the listening mode. - [41]
- 17** **Zoom key**
Use to perform the network server operations. - [58] - [61]
- Info key**
Use to operate other components. - [62]
- 18** **Dolby Virtual key**
Use to select the Dolby Virtual mode. - [40]
- 19** **Active EQ key**
Use to select ACTIVE EQ 's setting. - [32]
- 20** **LED indicator**
Blinks to show that signals are being transmitted.
- 21** **POWER RCVR (receiver) key**
Use to turn the receiver ON/STANDBY. - [20] - [26]
- 22** **TV Power key**
Use to turn the TV on and off. - [62]
- 23** **Sleep key**
Use to set the Sleep timer. - [45]
- Menu key**
Use to operate other components. - [62]
- 24** **Search key**
Use to perform the network server operations. - [57]
- Subtitle key**
Use to operate the DVD component. - [62]
- 25** **OSD key**
Use to operate the memory card. - [61]
Use to operate the DVD component. - [62]
- Guide key**
Use to operate other components. - [62]
- 26** **VOL +/- keys**
Use to adjust the receiver volume. - [30]
- 27** **TV Input key**
Use when in TV operation. - [62]
- 28** **TV key**
Use when in TV operation. - [62]
- 29** **◀◀ / ▶▶ keys**
Use to perform the network server operations. - [57]
Use to operate the CD, DVD, MD or VCR component. - [62]
- Tune +/- keys**
Use to tuning of radio broadcasting. - [34]

- 30** **Setup key**
Use to perform the network setup or speaker setup. - [20] - [26]
- key**
Use to operate the MD or VCR component. - [62]
- Top Menu key**
Use to operate the DVD component. - [62]
- 31** **Rotate key**
Use to perform the network server operations. - [58] - [61]
- Disc Sel. key**
Use to operate other components. - [62]
- Input Sel. key**
Use to operate other components. - [62]
- 32** **P.Mode key**
Use to perform the network server operations. - [57]
- Disc Skip key**
Use to operate the the multi-CD player . - [62]
- Last key**
Use to operate other components. - [62]
- 33** **■ key**
Use to perform the network server operations. - [57] - [61]
Use to operate the CD, MD, DVD or VCR component. - [62]
- Auto key**
Use to select the auto or manual tuning mode. - [34]
- 34** **Remote Setup key**
Use to register other components. - [62]
- 35** **Stereo key**
Use to switch the listen mode temporary to the stereo mode. - [42]

Speaker indication

Output channel indicators :

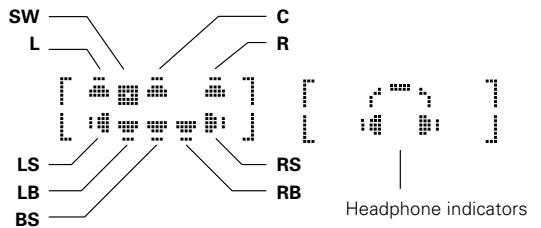

The output channel indicators light up to indicate the audio signals output from this unit. Headphone display is displayed when headphones are connected.

Input channel indicators :

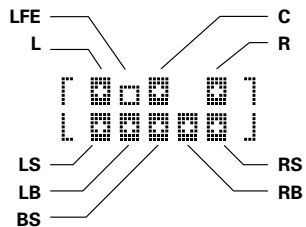

The Input channel indicators lights up to indicate the channels contained in the input signal.

Setting up the system

CAUTION

Make sure that the power cord plug is disconnected from the AC wall outlet before proceeding to connections. Also be sure to disconnect the power cord plug from the AC wall outlet before changing connections. For the connections of other system components, see pages 10 to 17.

When connecting an associated system component, be sure to read its instruction manual.

Microcomputer malfunction

If operation is not possible or an erroneous display appears, even though all connections have been made properly, reset the micro computer referring to "In case of difficulty". - [78]

Notes

1. Be sure to turn off the system components before connecting them.
2. Be sure to insert every connection cable completely into the jack. Incomplete connection may result in absence of audio output or production of noise.
3. Be sure to disconnect the power cord from the AC wall outlet before inserting or removing a connection cable.
4. Installation of outdoor antenna is a dangerous work. Please have your dealer or a specialized technician install it.
5. Select the speaker installation locations with care. If a speaker is installed near a source of magnetism including a magnet, the mutual interference with the speaker may produce color irregularities on the TV screen.

Analog audio connections

Audio connections are made using RCA pin cords. These cables transfer stereo audio signal in an "analog" form. This means the audio signal corresponds to the actual audio of two channels. These cables usually have 2 plugs on each end, one red for the right channel and one white for the left channel.

These cables are to be prepared separately by the user.

CAUTION

Be sure to adhere to the following, or proper ventilation will be blocked causing damage or fire hazard.

- Do not place any objects impairing heat radiation onto the top of the unit.
- Leave some space around the unit (from the largest outside dimension including projection) equal to or greater than, shown below.

Top panel	: 50 cm
Side panel	: 10 cm
Back panel	: 10 cm

Input mode settings

DVD, VIDEO 1, VIDEO 2, AUX and **GAME** inputs each include jacks for digital audio input and analog audio input.

The initial factory settings for audio signal playback for DVD, VIDEO 1, VIDEO 2, AUX and GAME are full auto.

After completing connections and turning on the receiver, follow the steps below.

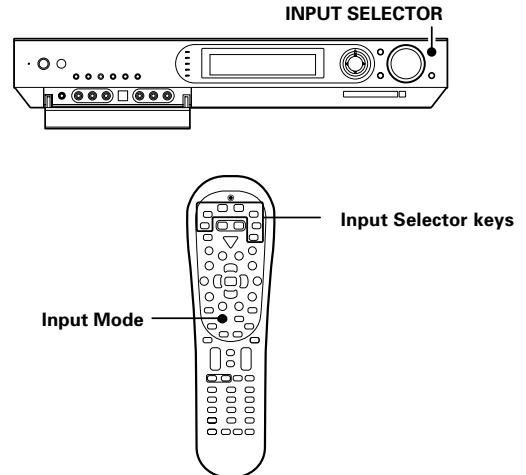

❶ Use the **INPUT SELECTOR** key (or **Input Selector keys**) to select **DVD, VIDEO 1, VIDEO 2, AUX** or **GAME**.

❷ Press the **Input Mode** key.

Each press switches the setting as follows:

- ① Auto detect:
("AUTO DETECT" indicator lights up)
 - ② Fixed to digital input:
("DIGITAL" indicator lights up)
 - ③ Fixed to analog input: *
- (* "AUTO DETECT", "DIGITAL" indicator goes off)
* Can not be selected for DTS playback.

Auto detect:

In **FULL AUTO** mode ("AUTO DETECT" indicator lights up), the receiver detects the digital or analog input signals automatically. The receiver will select the input mode and listening mode automatically during playback to match the type of input signal (Dolby Digital, PCM, DTS) and the speaker setting. - [41]
The **"DIGITAL"** indicator lights up when a digital signal is detected. The **"DIGITAL"** indicator is extinguished when no digital signal is detected.

Fixed to digital input:

Select this mode if you want to keep the decoding condition (Dolby Digital, DTS, PCM, etc.) in the current listen mode. When **DIGITAL MANUAL** mode is selected, the set listen modes may be changed automatically depending on the listen mode. - [41]

Fixed to analog input:

Select this setting to play analog signals from a VCR, etc.

If the **Input Mode** key is pressed quickly, sound may not be produced. Press the **Input Mode** key again.

Connecting Ethernet cable

When not using a broadband router or hub, connect this unit directly to the PC using a cross Ethernet cable. In this case, it is required to set the IP address and subnet mask manually. → 29

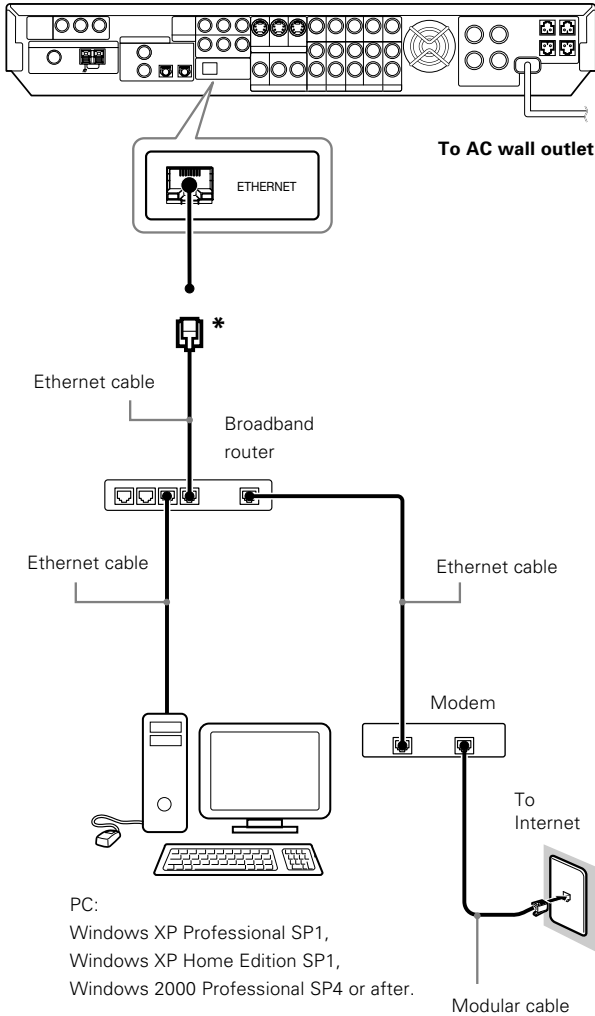

Connecting wireless LAN

Connect the wireless Ethernet bridge to the **ETHERNET** jack on the rear panel.

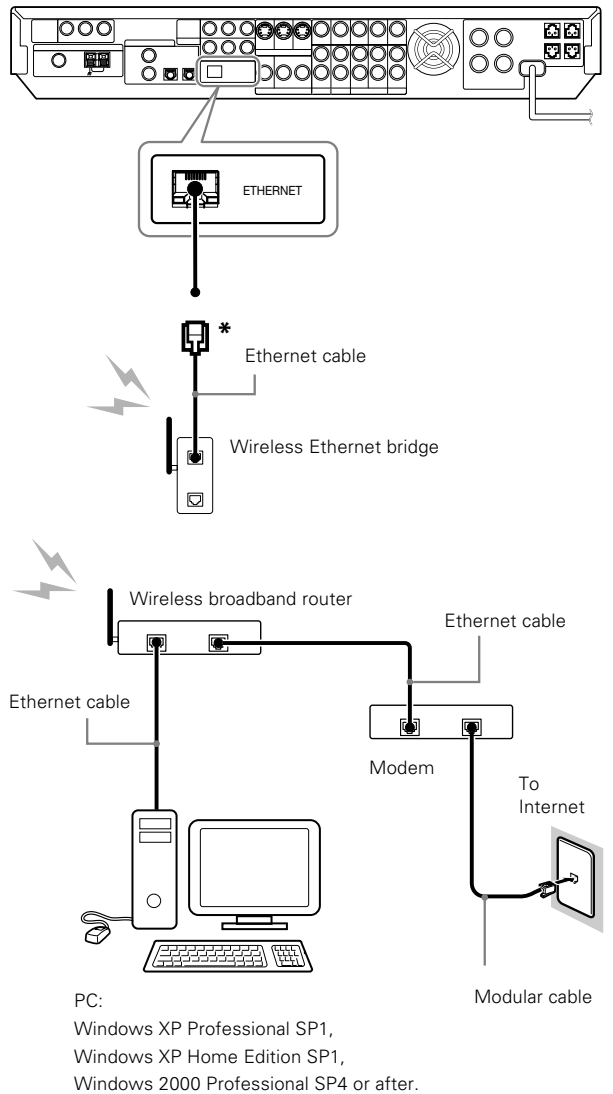

* Please refer to the instruction manual of your router or hub. Depending on your router or hub they may in rare case not work with a cross Ethernet cable.

- This unit is not provided with the Internet connection facility.
- When this unit is connected to a PC, FM broadcast reception may be interfered with noise. In this case, try the following remedial actions.
 1. Increase the distance between this unit and the PC.
 2. When the provided FM indoor antenna is in use, replace it with the FM outdoor antenna. → 17
 3. Replace the Ethernet cable with a shielded cable.

Connecting a DVD player

If you have connected a DVD player to the receiver with digital connection, be sure to read the "Input mode settings", "Re-assignment of rear panel jacks" section carefully. → [9] → [25]

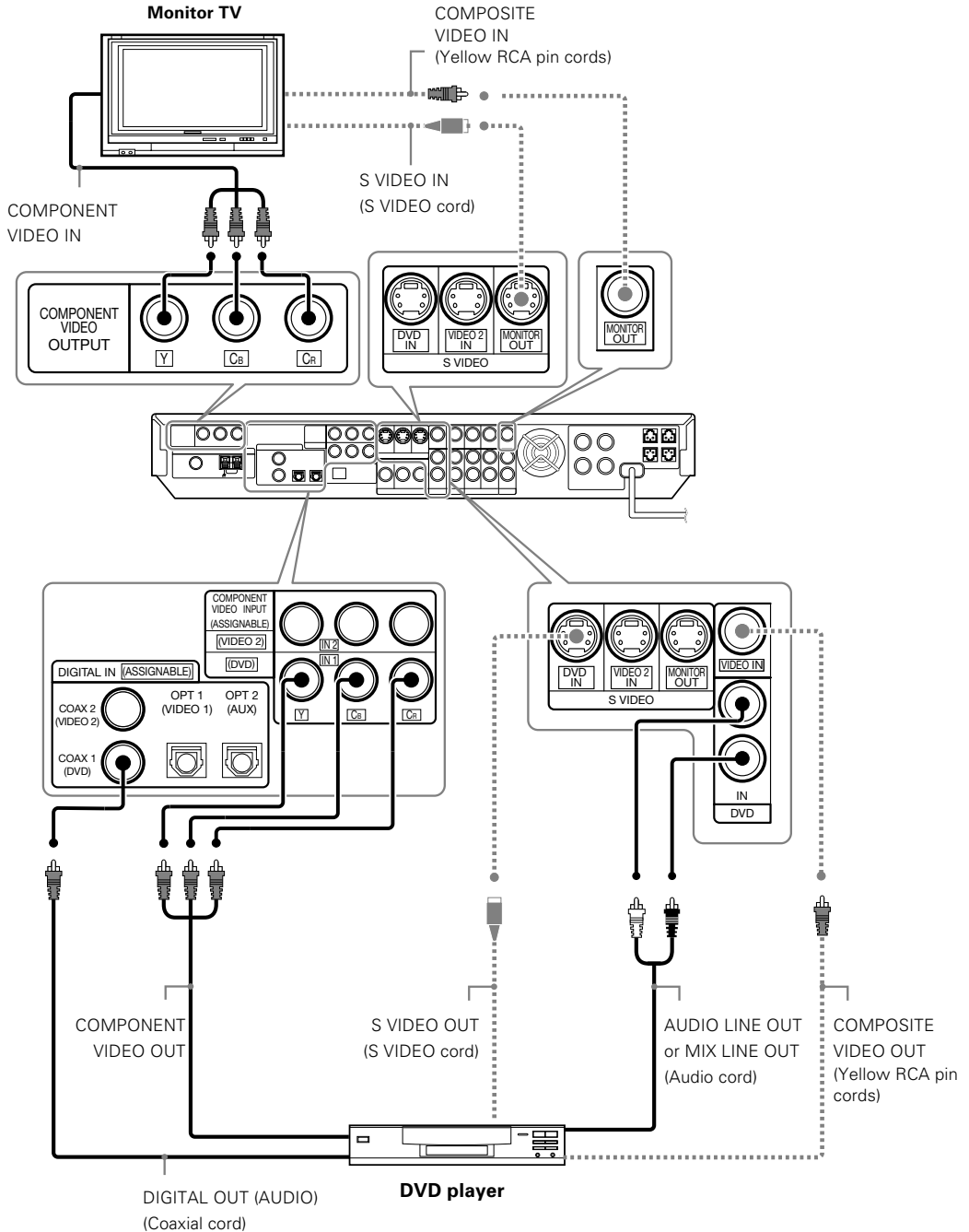

- Digital audio connections are required when playing multi-channel signals such as the Dolby Digital and DTS signals.
- To play the DVD player connected in this page, select the "DVD" input selector. → [30]

Connecting video components, audio components

Preparations

Audio components

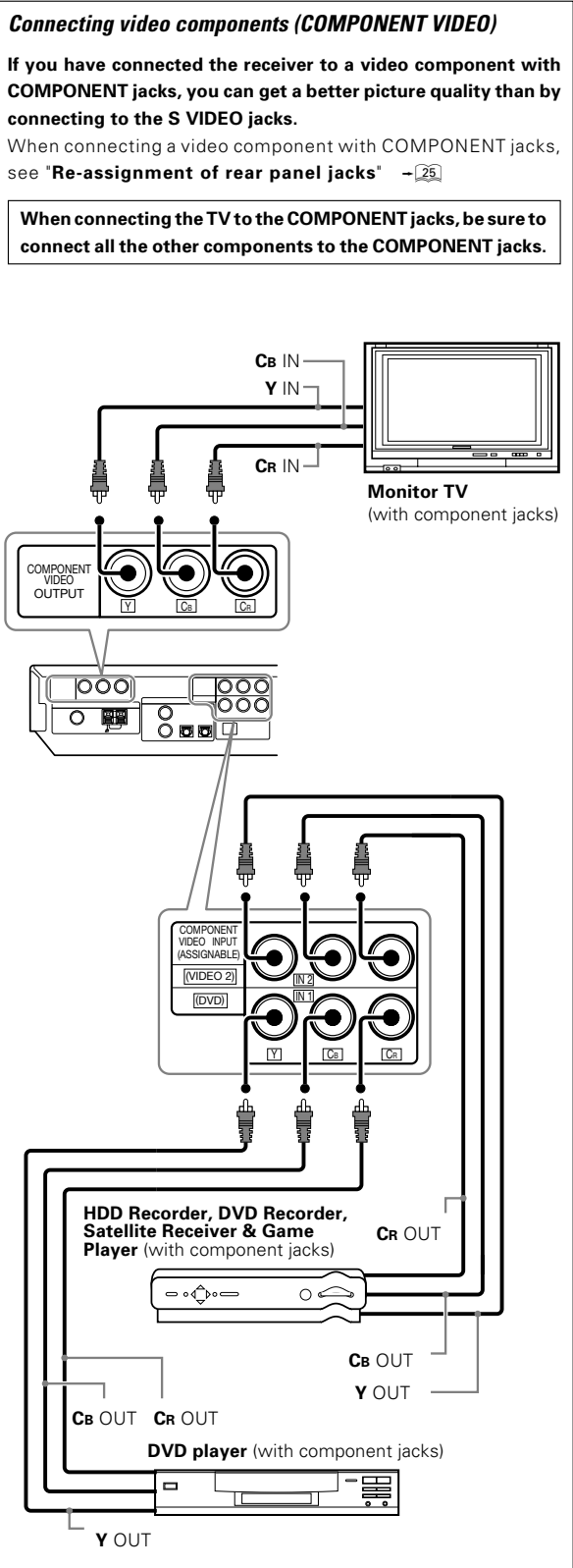
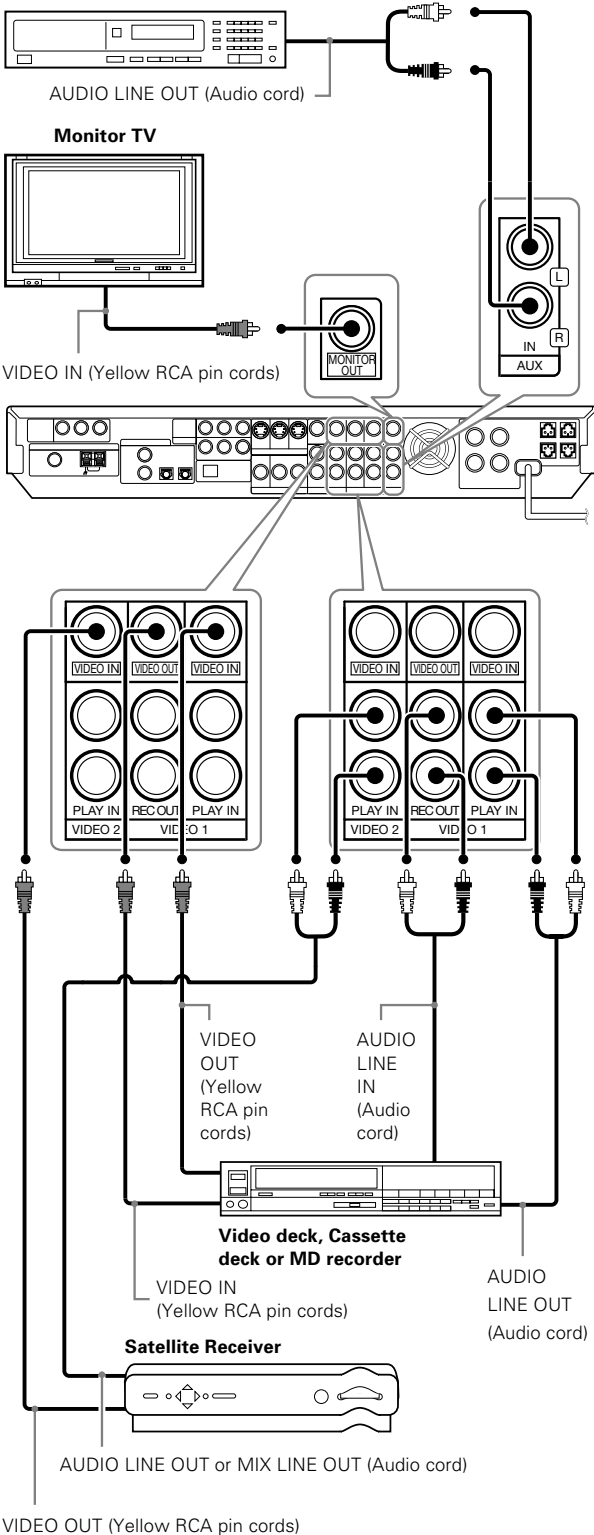

Digital connections

The digital in jacks can accept DTS, Dolby Digital, or PCM signals. Connect components capable of outputting DTS, Dolby Digital or PCM (CD) digital signals.

If you have connected a DVD player to the receiver with digital connection, be sure to read the "Input mode settings", "Re-assignment of rear panel jacks" section carefully. → 9 → 25

Connecting video components (S VIDEO)

Use the S VIDEO jacks to make connections to video components with S VIDEO IN/OUT jacks.

- If you use the S VIDEO jacks to connect your video playback components, be sure to use the S VIDEO jacks when connecting your monitor and video recording components.

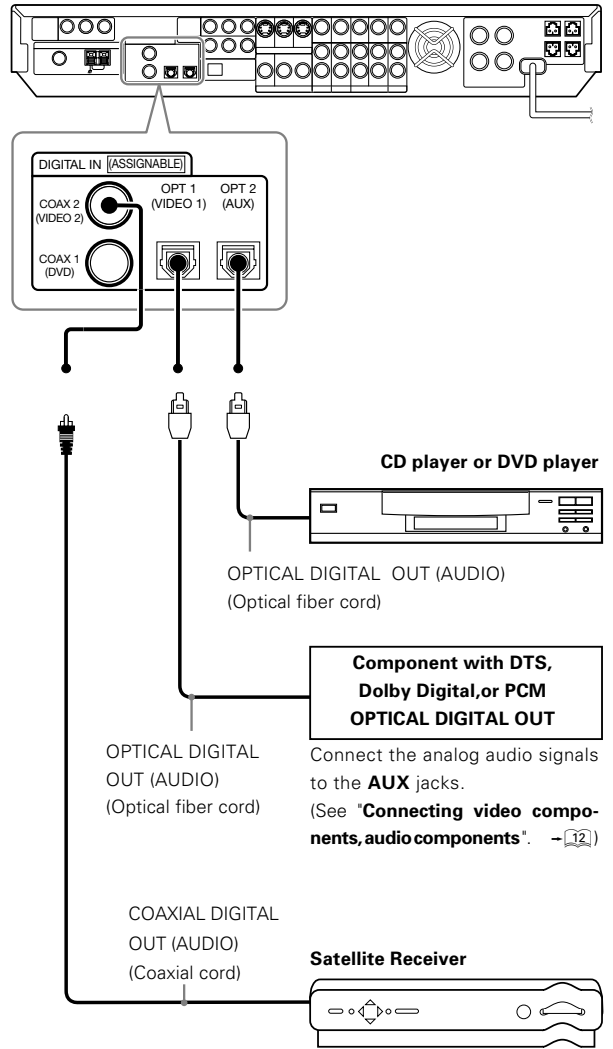
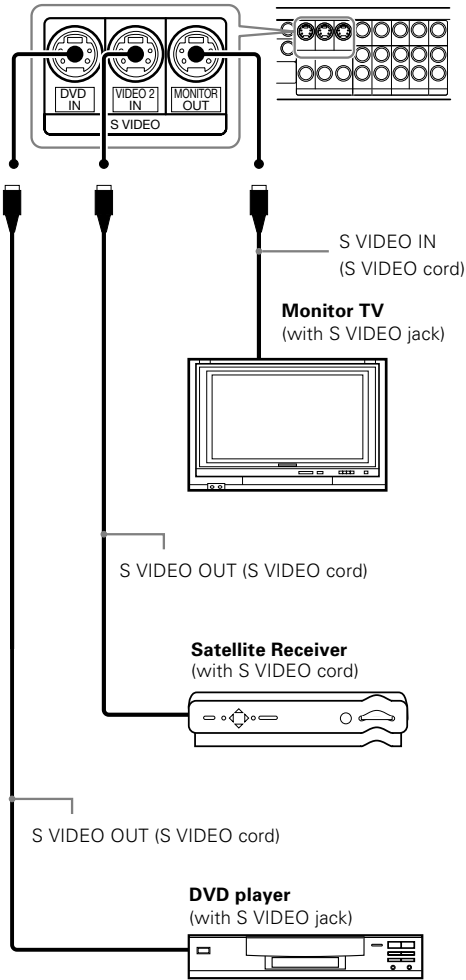

Connect the analog audio signals to the **AUX** jacks. (See "Connecting video components, audio components". → 12)

Connect the video signal and analog audio signals to the **VIDEO 2** jacks. (See "Connecting video components, audio components". → 12)

DTS disclaimer clause

When playing DTS-encoded discs, excessive noise will be exhibited from the analog stereo outputs of the CD or DVD player. To enjoy DTS Digital Surround™ playback, this unit must be connected to the digital output of the CD or DVD player.

Connecting the speakers

CAUTION

Make sure that the power cord plug is disconnected from the AC wall outlet before proceeding to speaker cord connections. If the conductor wires on the extremity of speaker cord are untwisted, there is a risk of short-circuiting. Be sure to twist them well before connecting the speaker cord.

Whether each speaker is connected properly can be confirmed by outputting the test tone and checking if each speaker channel outputs audio. For details, see "Speaker settings" (Step 2 Adjust the speaker volume level). → 23

Protection circuitry

This unit incorporates protection circuitry, which may be activated during high-power reproduction or in case of extreme rise in temperature.

When the protection circuitry is activated, the output from this unit is shut down and the **STANDBY** indicator blinks.

In this case, turn this unit OFF then ON again and reduce the output volume level.

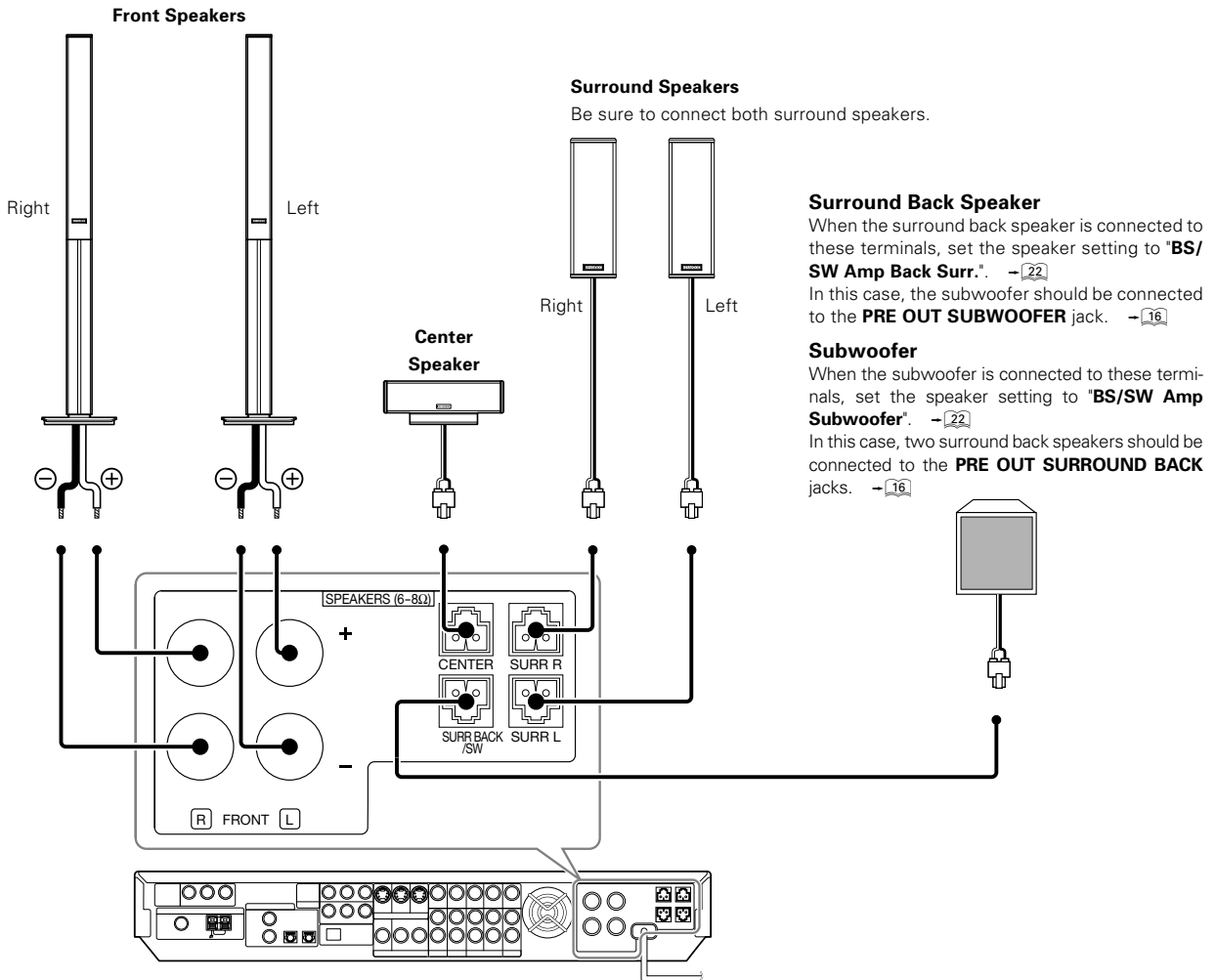

Connecting the speaker terminals

Front

1 Strip coating.

Twist

3 Insert.

2 Loosen.

4 Secure.

Center, Surround, Surround back, Subwoofer,

Attaching the speaker cord connectors;
Connect each speaker cord by matching the color of the connector with that of the terminal to which the speaker cord is to be connected.

Before connection, strip the vinyl coating by about 1 cm (0.4 in.) from each end of each speaker cord and twist the conductor wires so that they are not unbraided.

Connected speaker	Connector	Connected terminal
Center speaker	Green	CENTER
Surround speaker (Right)	Grey	SURR R
Surround speaker (Left)	Blue	SURR L
Surround back speaker or Subwoofer	Brown	SURR BACK/SW

While applying the projected part of the connector against a hard desktop, etc., insert the conductor sections of the speaker cord into the connector.

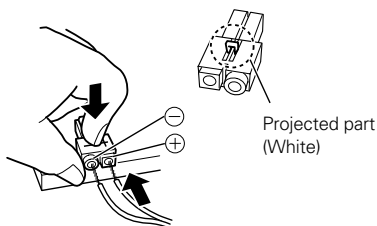

- After attaching the speaker cord connector, hold it and pull the speaker cord lightly to ensure that it will not come out.

Connect the connector to the terminal on the receiver with the same color by inserting the connector straight until it clicks.

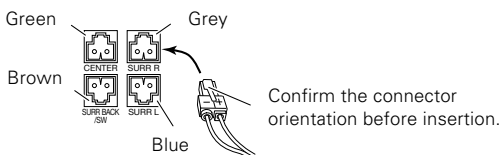

Be sure to use speaker cords matching the following requirements:
[AWG24-18 standard (conductor section diameter 0.511 to 1.024 mm(0.02 to 0.04 in.))]

- Never short circuit the + and - speaker cords.
- If the left and right speakers are connected inversely or the speaker cords are connected with reversed polarity, the sound will be unnatural with ambiguous acoustic imaging. Be sure to connect the speakers correctly.

Speaker impedance

After confirming the speaker impedance indications printed on the rear panel of the receiver, connect speakers with matching impedance ratings. Using speakers with a rated impedance other than that indicated on the rear panel of the receiver could result in malfunctions or damage to the speakers or receiver.

Speaker placement

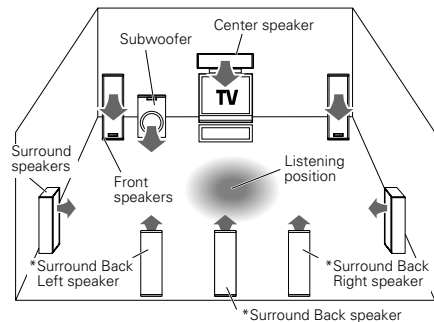

* For Surround Back speaker, you may place either two Surround Back speakers (Surround Back Left speaker and Surround Back Right speaker) for 7.1 channel surround sound system or one Surround Back speaker for 6.1 channel surround sound system.

Front speakers: Place the left and right speakers at each side of your TV. Angle the speakers towards the listening area to enhance the stereo effect.

Center speaker: Place the center speaker on the center between the front left and right speakers. Tilt the speaker upward or down-ward so that it is directly facing the listening area.

Surround speakers: Place the surround speakers as high as possible, either directly to the sides of the listening area or else slightly behind the listening area. Adjust the angles so that these speakers are facing directly towards the listeners.

Subwoofer: Usually, place the subwoofer in the front center position in the listening room, near one of the front speakers near the center speaker. (Since the subwoofer has less directivity than other speakers, it can be placed almost in any position that can offer the best low frequency reproduction according to the room layout.)

Surround back speakers: Place the surround back speaker behind the listening position, at the same height as the left and right surround speakers.

- Although the ideal surround system consists of all the speakers listed above, if you don't have a center speaker or a subwoofer, you can divide those signals between the available speakers in the speaker settings steps to obtain the best possible surround reproduction from the speakers you have available. - [20]

PRE OUT jacks connections

The receiver has additional **PRE OUT** jacks. Note that the output from the **PRE OUT** jacks needs to be connected to an external power amplifier.

If you want to connect surround back speakers to these jacks, be always sure to connect two surround back speakers for the left and right.

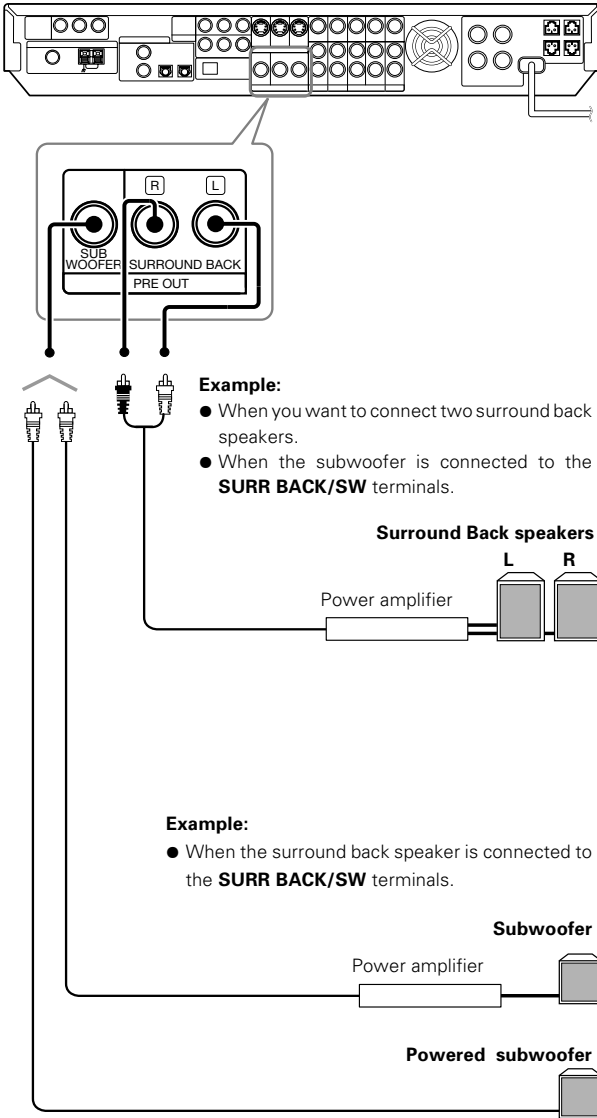

● Connecting a speaker cord directly to a **PRE OUT** jack will not produce any sound from the speaker.

Connecting to the GAME jacks / FRONT AUX jacks

If you use a component that you do not usually connect to the receiver, such as a portable video camera, connect it to the **GAME** or **FRONT AUX** jacks on the front panel of the receiver. These jacks are particularly convenient when dubbing audio/video from a portable video camera.

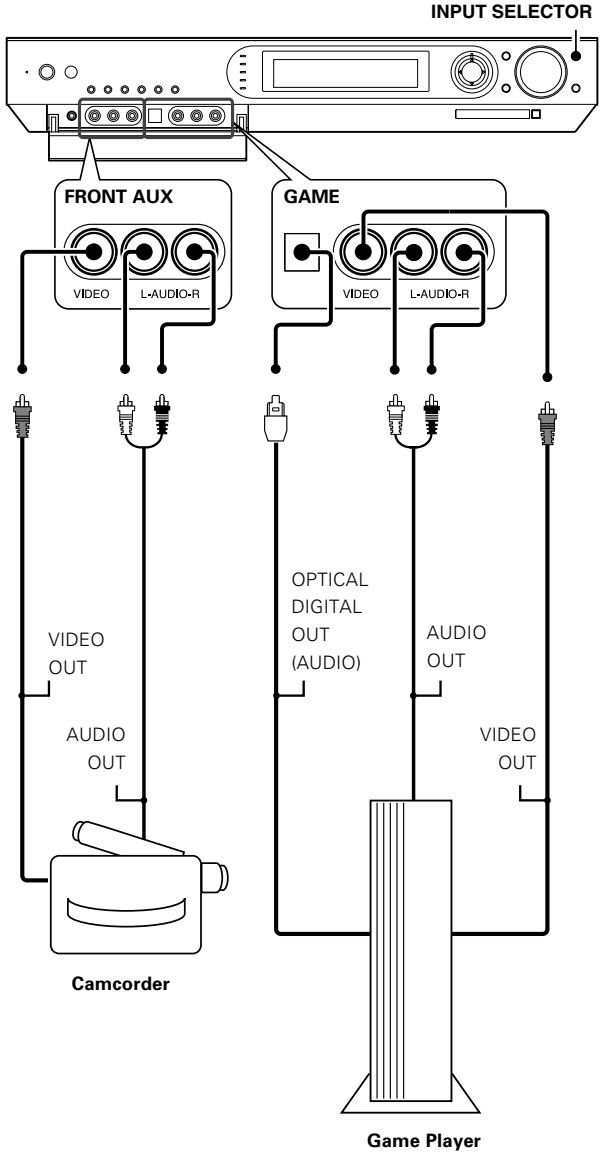

● The **DIGITAL IN (OPTICAL)** jack in the **GAME** jack section can be used for connection of digital audio input. This is convenient for playing a video game through the receiver. → 24

Connecting the antennas

The broadcast reception cannot be made unless the antennas are connected. Connect the antennas correctly as instructed below.

AM loop antenna

The supplied loop antenna is for use indoors. Place it as far as possible from the receiver, TV set, speaker cords and power cord, and adjust the direction for best reception.

AM antenna terminal connections

- ❶ Push lever.
- ❷ Insert cord.
- ❸ Release lever.

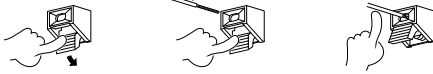

FM indoor antenna

The supplied indoor antenna is for temporary use only. For stable signal reception we recommend using an outdoor antenna. Disconnect the indoor antenna when you connect one outdoors.

FM antenna terminal connections

Insert the connector



(For the U.S.A. and Canada)

(For Europe and Australia)

FM outdoor antenna

Lead the 75Ω coaxial cable connected to the FM outdoor antenna into the room and connect it to the **FM 75Ω** terminal.

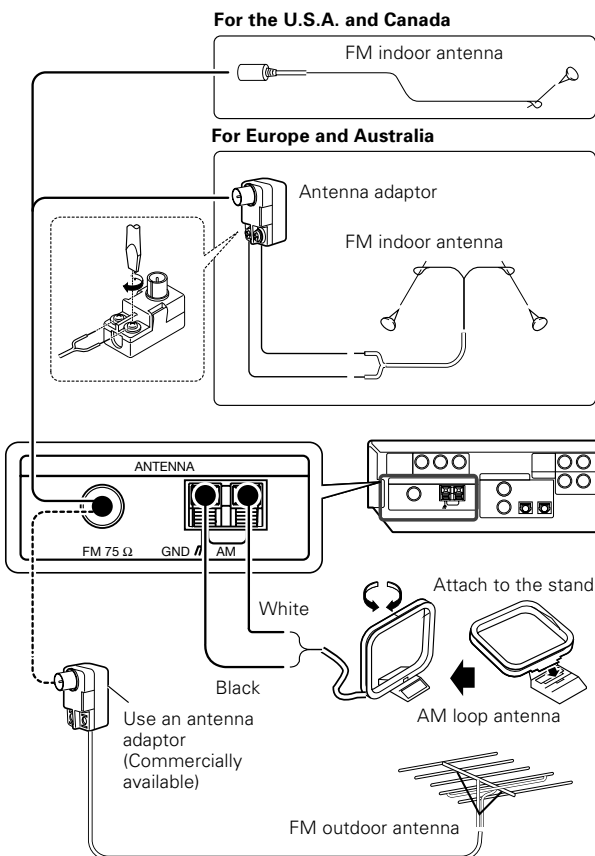

Preparing the remote control

Loading the batteries

- ❶ Remove the cover.
- ❷ Insert the batteries.

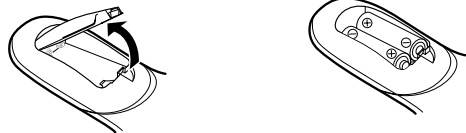

- ❸ Close the cover.



- Insert two AA-size (R6) batteries as indicated by the polarity markings.

Remote control operation

When the **STANDBY** indicator is lit, the power turns ON when you press the **POWER RCVR** on the remote control. When the power comes ON, press the key you want to operate.

Operating other component range

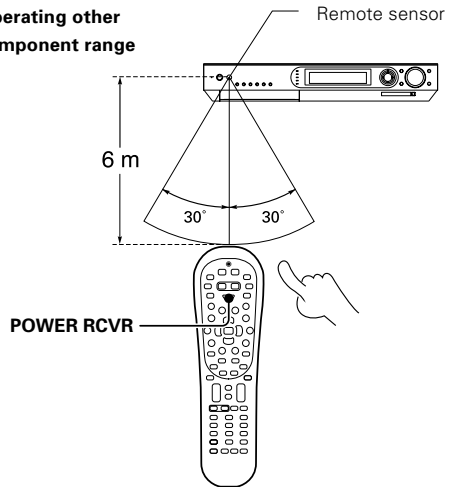

- When pressing more than one remote control key successively, press the keys securely by leaving an interval of 1 second or more between keys.

Notes

1. The supplied batteries may have shorter lives than ordinary batteries due to use during operation checks.
2. When the remote-controllable distance gets shorter than before, replace both batteries with new ones.
The remote control unit is designed so that the setup codes stored in it are saved even after the batteries are removed for replacement.
3. Placing the remote sensor in direct sunlight, or in direct light from a high frequency fluorescent lamp may cause a malfunction.
In such a case, change the location of the system installation to prevent malfunction.

STEP 1 Connect the speakers, TV and DVD to the receiver

For details, see "Setting up the system" - 9 ~ - 16

CAUTION

Make sure that the power cord plug is disconnected from the AC wall outlet before proceeding to speaker cord connections. If the conductor wires on the extremity of speaker cord are untwisted, there is a risk of short-circuiting. Be sure to twist them well before connecting the speaker cord.

Connection of speakers:

(A)	Front speakers (L,R)
(B)	Center speaker
(C)	Subwoofer
(D)	Surround speakers (L,R)
(E)	Surround back speaker

- If you want to connect two surround back speakers (LB and RB) to the **PRE OUT SURROUND BACK** jacks, see "PRE OUT jacks connections". - 16

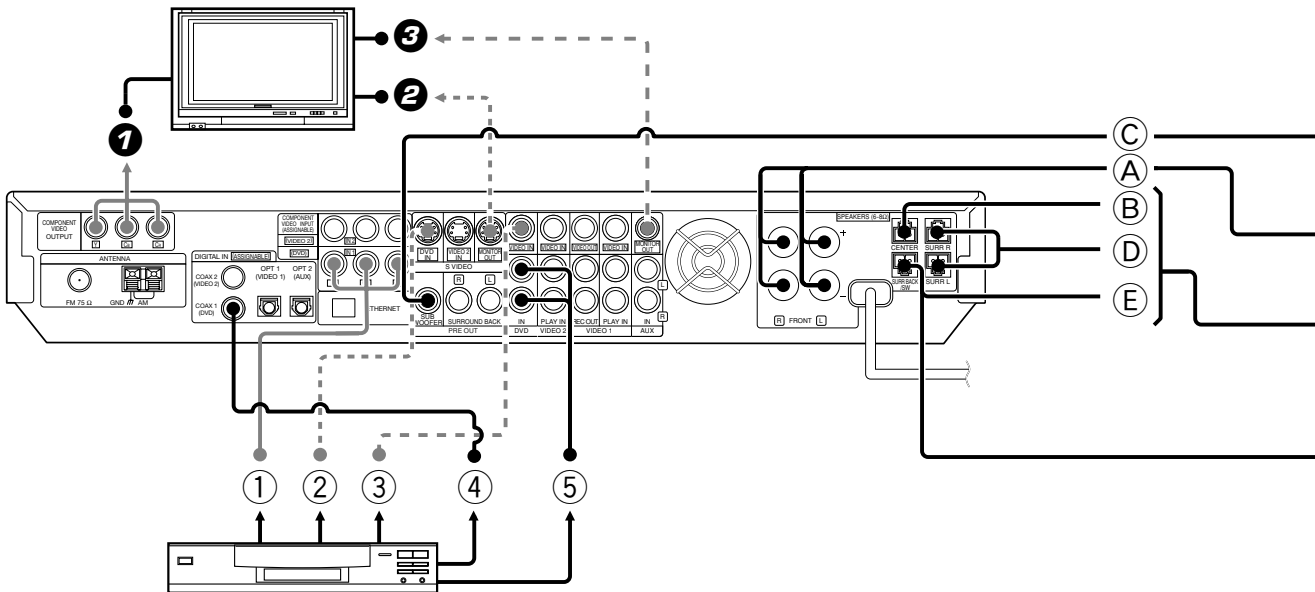
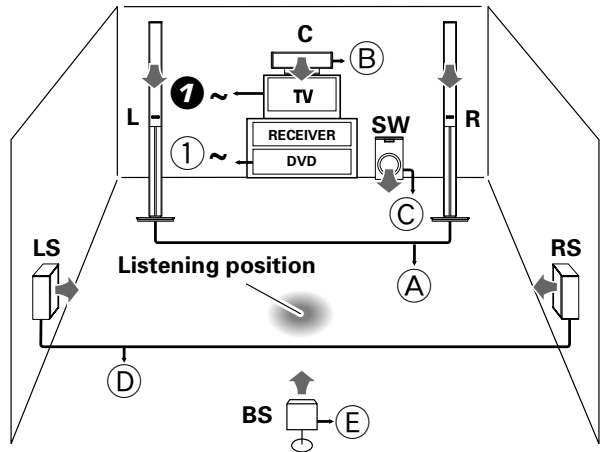

Connection of TV monitor:

①.....	Component video connection
②... ..	S video connection
③- - -	Composite video connection

Connection of DVD player:

①.....	Component video connection
②... ..	S video connection
③- - -	Composite video connection

- For the video input connection from the DVD player and the video output connection to the TV monitor, connect any one in a pair.

④	Digital audio connection (Coaxial cord)
⑤	Analog audio connection

STEP 2 Set up the speakers

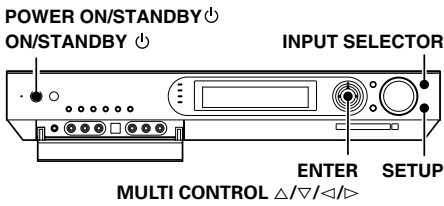

For details, see "Speaker settings" . → [20] ~ → [24]

- 1 Connect the power cord to the AC wall outlet and press or .
- 2 Press , press to select "SPEAKER SETUP" and press .

If you connect KENWOOD speaker system KS-2100HT, KS-3100EX, KS-708HT, KS-308HT, KS-708HT+KS-308EX, KS-308HT+KS-308EX, KS-908HT or KS-908EX:

Press to select the model of the connected speaker system and press .

"HTB1 6.1CH": Speaker system KS-3100EX.

"HTB1 5.1CH": Speaker system KS-2100HT.

"HTB2 6.1CH": Speaker system KS-708HT+KS-308EX or KS-308HT+KS-308EX.

"HTB2 5.1CH": Speaker system KS-708HT or KS-308HT.

"HTB3 6.1CH": Speaker system KS-908EX.

"HTB3 5.1CH": Speaker system KS-908HT.

Model availability may differ depending on the country and sales area.

If your selection is correct, press to select "YES" and press . Now the speaker setup is complete. (Select "NO" to return to the status before setup.)

- When the speaker setting is set to "HTB1 5.1CH", "HTB2 5.1CH" or "HTB3 5.1CH", the PL IIX, DTS-ES and DOLBY EX listen modes cannot be selected.

If you use another speaker system want a setup according to it:

Press to select "CUSTOM" and press to select each of the speaker setup items.

Press to select the speaker setup item	Press to select the setting for each item
"SUBWOOFER"	"SUBWOOFER ON": A subwoofer is connected. "SUBWOOFER OFF": A subwoofer is not connected.
"FRONT"	Speaker size ? "LARGE": Relatively large-size speakers. "NORMAL": Normal-size speakers.
"CENTER", "SURROUND", "BACK SURROUND"	Speaker size ? "LARGE": Relatively large-size speakers. "NORMAL": Normal-size speakers. "OFF": No speaker is connected.
"BS/SW AMP"	"BS/SW AMP BACK SURROUND": A surround back speaker is connected to the SURR BACK/SW terminals. "BS/SW AMP SUBWOOFER": A subwoofer is connected to the SURR BACK/SW terminals. "BS/SW AMP OFF": No speaker is connected.

After completing the setup, press . If your selection is correct, press to select "YES" and press .

Now the speaker setup is complete. (Select "NO" to return to the status before setup.)

- When the speaker setting is set to "BS/SW AMP OFF", the PL IIX, DTS-ES and DOLBY EX listen modes cannot be selected.
- More detailed settings such as the volume level of each speaker and distance to each speaker are also available. → [23] → [24]

STEP 3 Play a disc on the DVD player

1 Press to select "DVD".

2 Start playback of the DVD player.

For the operation, also refer to the instruction manual for your DVD player.

- You can select various listen modes to enjoy surround playback of various kinds of video software. → [41]

Preparing for playback

Speaker settings

To enable you to obtain optimum enjoyment from the receiver's listening modes, make sure to complete the speaker settings (subwoofer, front, center, surround and surround back speakers) as described below.

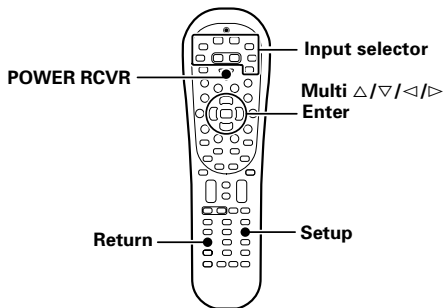
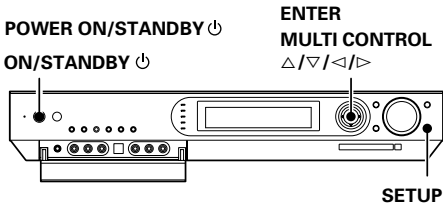

Preparation

Turn on the power to this receiver by pressing the **POWER ON/STANDBY** ⏻ (For U.S.A. and Canada) or the **ON/STANDBY** ⏻ (For Europe and Australia) key (or the **POWER RCVR** key on the remote).

Example: Setting with the "NET SERVER" input

- 1 Use the **INPUT SELECTOR** key (or the **Network Server** key) to select "NET SERVER".

When performing the speaker setup by selecting the "TUNER", "DVD", "VIDEO1", "VIDEO2", "GAME" or "F.AUX" input, press the **SETUP** (or **Setup**) key and start the procedure from step 2. In these cases, the setting information is displayed on the display of this unit.

When the "NET SERVER" input is selected, the OSD function on the TV screen is activated and detection of the server starts.



- 2 Use the **MULTI CONTROL** △/▽ (or the **Multi** △/▽ keys) to select "SETUP", and press the **ENTER** (or the **Enter** key).

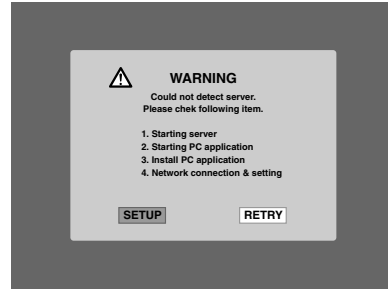

- 3 Use the **MULTI CONTROL** △/▽ (or the **Multi** △/▽ keys) to select "Receiver Setup", and press the **ENTER** (or the **Enter** key).

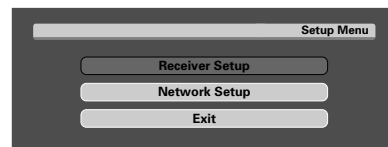

Use the **MULTI CONTROL** △/▽ (or the **Multi** △/▽ keys) for the following displays.

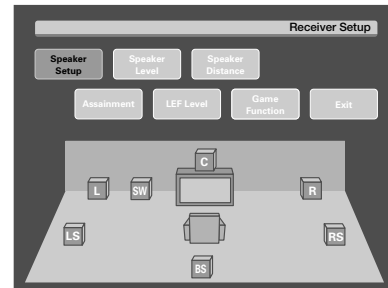

Indicates the direction of movement in the hierarchy when the **ENTER** (or the **Enter** key) is pressed.

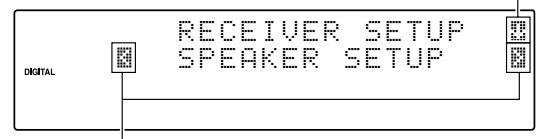

Indicates the direction of **MULTI CONTROL** (or **Multi** key) to be pressed for selecting the setting.

- ① "Speaker Setup": Select a speaker system. → [21]
- ② "Speaker Level": Adjust the speaker volume level. → [23]
- ③ "Speaker Distance": Input the distance to the speakers. → [23]
- ④ "Assignment": Re-assignment of rear panel jacks → [25]
- ⑤ "LFE Level": Adjust the LFE LEVEL (Low Frequency Effects level) → [24]
- ⑥ "Game Function": Set up the GAME jacks on the front panel. → [24]
- ⑦ "Exit": Select "Exit" and press the **ENTER** (or the **Enter** key) to return to the previous display.

- While the main setup screen is displayed, the setup mode can be canceled by pressing the **SETUP** key (or the **Setup** key).

Continued to next page

4 Select the setup method. Speaker Setup

- 1 Select "Speaker Setup" and press the ENTER key (or the Enter key) to select the speaker setup method.
- 2 Use the MULTI CONTROL </> (or the Multi </> keys) for the following displays.

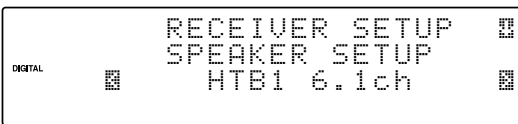
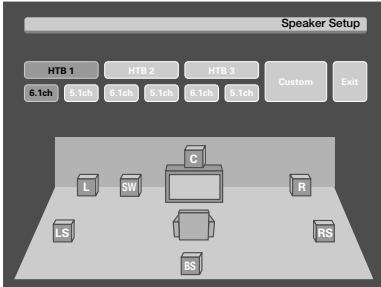

- 1 "HTB1 6.1CH": Select "HTB1 6.1CH" if you use speaker system KS-3100EX. *
- 2 "HTB1 5.1CH": Select "HTB1 5.1CH" if you use speaker system KS-2100HT. *
- 3 "HTB2 6.1CH": Select "HTB2 6.1CH" if you use speaker system KS-708HT+KS-308EX or KS-308HT+KS-308EX. *
- 4 "HTB2 5.1CH": Select "HTB2 5.1CH" if you use speaker system KS-708HT or KS-308HT. *
- 5 "HTB3 6.1CH": Select "HTB3 6.1CH" if you use speaker system KS-908EX. *
- 6 "HTB3 5.1CH": Select "HTB3 5.1CH" if you use speaker system KS-908HT. *
- 7 "Custom": Select to set up the speakers according to the speaker system in use. (Speaker setup is required every time after the speaker system is changed.)
- 8 "Exit": Select "Exit" and press the ENTER (or the Enter key) to return to the previous display.

* Model availability may differ depending on the country and sales area.

- When the 5.1 channel speaker system configuration is used or the speaker setting is set to "BS/SW Amp Off", the PL IIX, DTS-ES and DOLBY EX listen modes cannot be selected.

If you selected "HTB16.1CH", "HTB15.1CH", "HTB26.1CH", "HTB25.1CH", "HTB36.1CH" or "HTB35.1CH" in the above:

Press the ENTER (or the Enter key), then press the MULTI CONTROL </> (or the Multi </> keys) to select "Yes", and press the ENTER (or the Enter key) again to establish the setup.

- Select "No" to return to the status before setup.
- When you use a KENWOOD speaker system and select "HTB1 6.1CH", "HTB1 5.1CH", "HTB2 6.1CH", "HTB2 5.1CH", "HTB3 6.1CH" or "HTB3 5.1CH" set the speaker setup, the audio will be corrected automatically according to the speaker characteristics.

If you selected "Custom" in the above:

Press the ENTER (or the Enter key) to proceed to detailed setups. After this, continue the procedure from step 5. The flow of the SETUP is as follows;

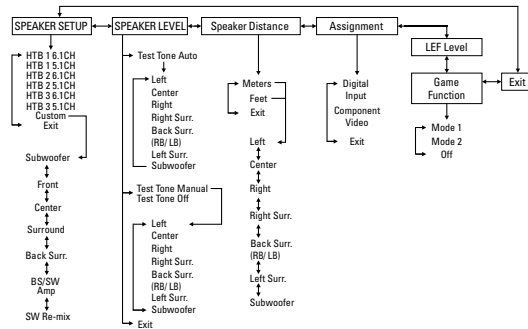

5 Select a speaker system.

- 1 Use the MULTI CONTROL </> (or the Multi </> keys) to select the appropriate subwoofer setting.

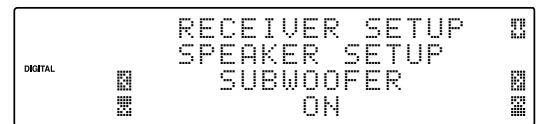
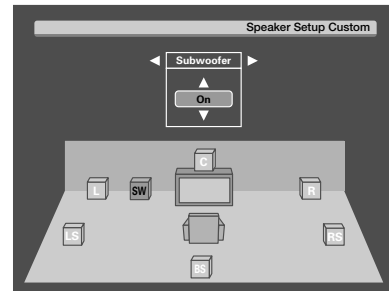

- 1 "Subwoofer On": When a subwoofer is connected.
- 2 "Subwoofer Off": When no subwoofer is connected.

- The initial setting is "Subwoofer On".
- When "Subwoofer Off" is selected and the selection is established by pressing the MULTI CONTROL > (or the Multi > key) in step 2 below, the front speakers are set automatically to "Front Large" and the procedure jumps to step 3.

- 2 Use the MULTI CONTROL > (or the Multi > key) to accept the setting.

- 3 Use the MULTI CONTROL </> (or the Multi </> keys) to select the appropriate front speakers setting.

- 1 "Front Large": Large front speakers are connected to the receiver.

② "Front Normal":

Average size front speakers are connected to the receiver.

- When the subwoofer setting is "Subwoofer On", front speakers setting is "Front Large" and a stereo source is played, the low frequencies may be reproduced through the front speakers and no audio output from the subwoofer in certain listen modes. In this case, set the subwoofer re-mix setting in step ⑫ to "SW Re-mix On" to output the low frequencies from the subwoofer.

④ Use the MULTI CONTROL ▷ (or the Multi ▷ key) to accept the setting.

⑤ Use the MULTI CONTROL △ / ▽ (or the Multi △ / ▽ keys) to select the appropriate center speaker setting.

① "Center Large": *

A large center speaker is connected to the receiver.

② "Center Normal":

An average size center speaker is connected to the receiver.

③ "Center Off":

When no center speaker is connected.

* "Center Large" cannot be selected when the front speakers have been set to "Front Normal".

⑥ Use the MULTI CONTROL ▷ (or the Multi ▷ key) to accept the setting.

⑦ Use the MULTI CONTROL △ / ▽ (or the Multi △ / ▽ keys) to select the appropriate surround speaker setting.

① "Surround Large":

Large surround speakers are connected to the receiver.

② "Surround Normal":

Average size surround speakers are connected to the receiver.

③ "Surround Off":

When no surround speakers are connected.

- When "Surround Off" is selected and the selection is established by pressing the MULTI CONTROL ▷ in step ⑧ below, the procedure jumps to step ⑫. However, if the subwoofer setting is "Subwoofer Off", the procedure jumps to step ⑭ so that you can complete the speaker setup and proceed to the speaker volume level adjustment in step ⑮.

⑧ Use the MULTI CONTROL ▷ (or Multi ▷ key) to accept the setting.

⑨ Use the MULTI CONTROL △ / ▽ (or the Multi △ / ▽ keys) to select appropriate surround back speaker setting.

① "Back Surr. Large": *

Large surround back speaker is connected to the receiver.

② "Back Surr. Normal":

Average size surround back speaker is connected to the receiver.

③ "Back Surr. Off":

When no surround back speakers is connected.

* "Back Surr. Large" cannot be selected when the surround speaker has been set to "Surround Normal" or "Surround Off".

⑩ Use the MULTI CONTROL ▷ (or the Multi ▷ key) to accept the setting.

⑪ Use the MULTI CONTROL △ / ▽ (or the Multi △ / ▽ keys) to select the appropriate BS/SW amp setting.

① "BS/SW Amp Back Surr.":

Select this setting when a surround back speaker is connected to the SURR BACK/SW terminals. In this case, the subwoofer signal will be output from the PRE OUT SUBWOOFER jack.

② "BS/SW Amp Subwoofer":

Select when the subwoofer speaker is connected to the SURR BACK/SW terminals. In this case, the surround back signals will be output from the PRE OUT SURROUND BACK jacks.

③ "BS/SW Amp Off":

Select when no speaker is connected to the SURR BACK/SW terminals. In this case, the subwoofer signal will be output from the PRE OUT SUBWOOFER jack and the surround back signals will be output from the PRE OUT SURROUND BACK jacks.

- If "BS/SW Amp Back Surr." is selected, only one surround back speaker can be connected to the receiver.
- If "BS/SW Amp Subwoofer" or "BS/SW Amp Off" is selected, two surround back speakers can be connected to the PRE OUT SURROUND BACK jacks through an external power amplifier. 

⑫ Use the MULTI CONTROL ▷ (or the Multi ▷ key) to accept the setting.

⑬ Use the MULTI CONTROL △ / ▽ (or the Multi △ / ▽ keys) to select the appropriate subwoofer re-mix setting.

If "SW Re-mix On" is selected as the subwoofer re-mix setting, the low frequencies are enhanced by adding the low frequencies of other channels to the subwoofer channel or adding the low frequencies of the subwoofer to other channels depending on the speaker setup.

① "SW Re-mix On":

Subwoofer re-mix setting mode to the receiver is ON.

② "SW Re-mix Off":

Subwoofer re-mix setting mode to the receiver is OFF.

- The initial setting is "SW Re-mix On".
- The subwoofer re-mix setting is possible only when the subwoofer setting is "Subwoofer On" and the front speaker setting is "Front Large".

⑭ Press the ENTER (or the Enter key). If your selection is correct, press the MULTI CONTROL △ / ▽ (or the Multi △ / ▽ key) to select "Yes".

Press the ENTER (or the Enter key) again to return to the main setup displays.

- Select "No" and press the ENTER (or the Enter key) to return to the status before setup.

Continued to next page

6 Adjust the speaker volume level. Speaker Level

From your usual listening position, adjust the volume levels. The volume levels from each speaker should be the same.

- In this step **6**, only the speaker channels that have been set and require the volume level adjustment are displayed.
- 1** Use the **MULTI CONTROL** $\triangleleft/\triangleright$ (or the **Multi** $\triangleleft/\triangleright$ keys) to select **"Speaker Level"** on setup displays, and press the **ENTER** (or the **Enter** key).
- 2** Use the **MULTI CONTROL** $\triangleleft/\triangleright$ (or the **Multi** $\triangleleft/\triangleright$ keys) to select **"Test Tone Auto"**, **"Test Tone Manual"** or **"Test Tone Off"**.

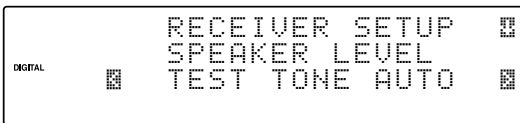
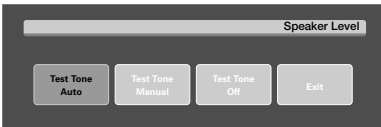

- 1 "Test Tone Auto"**: Select this setting to adjust the speaker volume levels using the test tone. The test tone will be output from every speaker channel in automatic sequence.
 - 2 "Test Tone Manual"**: Select the speaker channel to output the test tone using the **MULTI CONTROL** $\triangleleft/\triangleright$ (or the **Multi** $\triangleleft/\triangleright$ key).
 - 3 "Test Tone Off"**: Select to adjust the speaker volume levels using the current output signals. The speaker channel to output the signal can be selected using the **MULTI CONTROL** $\triangleleft/\triangleright$ (or the **Multi** $\triangleleft/\triangleright$ key).
 - 4 "Exit"**: Select **"Exit"** and press the **ENTER** (or the **Enter** key) to return to the previous display.
- Press the **SETUP** (or **Setup**) key to cancel the SETUP mode in the middle.

When **"Test Tone Auto"** or **"Test Tone Manual"** is selected and the **ENTER** (or the **Enter** key) is pressed again, the test tone output will start.

Use the **MULTI CONTROL** \triangle/\triangledown (or the **Multi** \triangle/\triangledown keys) to adjust the volume level of the test tone output from the speaker channel to be adjusted.

For **"Test Tone Auto"** selection, the first test tone is heard from the front left speaker for 2 seconds. The next test tone is heard from the speakers in the following sequence for 2 seconds each.

When the **"BS/SW Amp Back Surr."** has been selected:

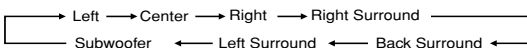

When the **"BS/SW Amp Subwoofer"** or **"BS/SW Amp Off"** has been selected:

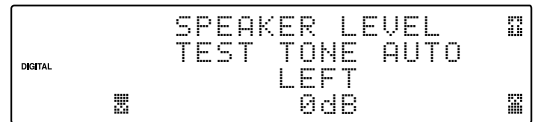
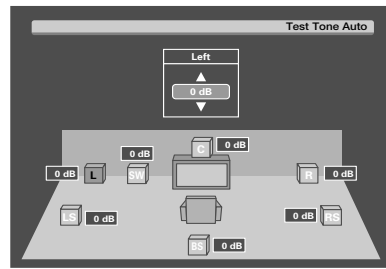
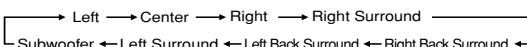

- If you change the volume level settings for the speakers while listening to music, the settings referred to on this page are also changed. → [43](#)
- When a speaker setup is set to off the volume level for the corresponding speakers is reset to 0 dB.

When **"Test Tone Manual"** or **"Test Tone Off"** is selected, press the **MULTI CONTROL** $\triangleleft/\triangleright$ (or the **Multi** $\triangleleft/\triangleright$ key) to select the speaker channel and then press the **MULTI CONTROL** \triangle/\triangledown (or the **Multi** \triangle/\triangledown key) to adjust the speaker volume level.

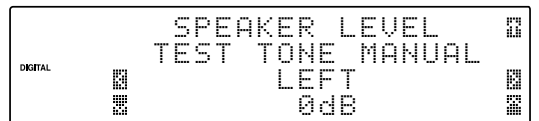
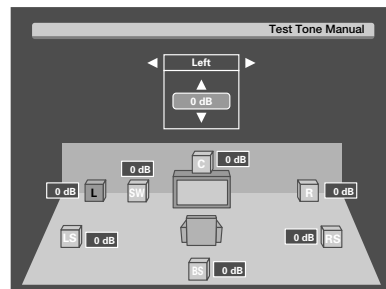

- 3** Press the **ENTER** (or the **Enter** key) again to return to the main setup displays.
 - The test tone is turned off and return to the main setup displays.

7 Input the distance to the speakers. Speaker Distance

This setting allows the signals output from different speakers to reach the listening position simultaneously.

- In this step **7**, only the speaker channels that have been set and require the volume level adjustment are displayed.

Measure the distance from the listening position to each of the speakers.

Jot down the distance to each of the speakers.

- Distance to Front speaker (L) : ___ feet (meters)
- Distance to Center speaker (C) : ___ feet (meters)
- Distance to Front speaker (R) : ___ feet (meters)
- Distance to Surround speaker (RS) : ___ feet (meters)
- Distance to Surround back speaker (RB) : ___ feet (meters)
- Distance to Surround back speaker (LB) : ___ feet (meters)
- Distance to Surround speaker (LS) : ___ feet (meters)
- Distance to Subwoofer (SW) : ___ feet (meters)

- ❶ Use the MULTI CONTROL $\triangleleft/\triangleright$ (or the Multi $\triangleleft/\triangleright$ keys) to select "Speaker Distance" on setup displays, and press the ENTER (or the Enter key).
- ❷ Use the MULTI CONTROL $\triangleleft/\triangleright$ (or the Multi $\triangleleft/\triangleright$ key) to select the unit and press the ENTER (or the Enter key).



- ❶ "Meters"
- ❷ "Feet"
- ❸ "Exit": Select "Exit" and press the ENTER (or the Enter key) to return to the previous display.

- Press the **SETUP** (or **Setup**) key to cancel the SETUP mode in the middle.

- ❸ Use the MULTI CONTROL $\triangleleft/\triangleright$ (or the Multi $\triangleleft/\triangleright$ keys) to select the speakers and the MULTI CONTROL \triangle/∇ (or the Multi \triangle/∇ keys) to adjust the distance to the front speakers.
- The speakers you have selected should appear on the display. Confirm that all the speakers have been correctly selected.

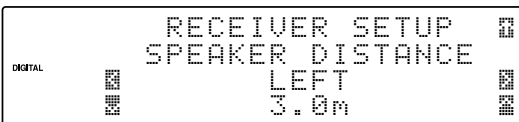
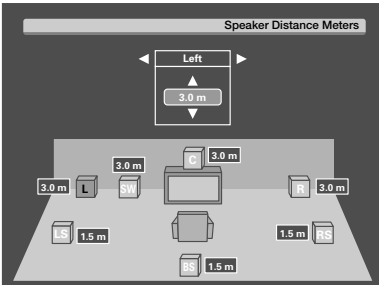

- The allowable setting range is 1 to 30 feet (0.3 to 9.0 m), adjustable in 1 foot (0.3 m) increments.

- ❹ Repeat steps ❸ to input the distance for each of the speakers.
- ❺ Press the ENTER (or the Enter key) again to return to the main setup displays.

❸ Adjust the LFE LEVEL (Low Frequency Effects level). LFE Level

Adjust the level of the low-frequency fields effect (LFE) signal, which is the signal used exclusively for giving the field effect of bass tone, in the Dolby Digital or DTS signal.

- ❶ Use the MULTI CONTROL $\triangleleft/\triangleright$ (or the Multi $\triangleleft/\triangleright$ keys) to select "LFE Level" on setup displays, and press the ENTER (or the Enter key).
- ❷ Use the MULTI CONTROL \triangle/∇ (or the Multi \triangle/∇ keys) to adjust the LFE LEVEL.

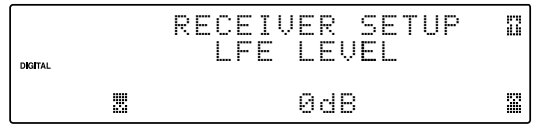
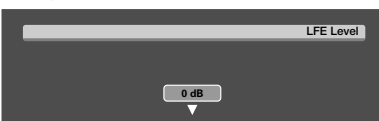

- The LFE LEVEL is adjusted from 0dB to -10dB in 1dB step decrements.

- ❸ Press the ENTER (or the Enter key) again to return to the main setup displays.

❹ Set up the GAME jacks on the front panel. Game Function

Perform the setup for convenience of playing a video game using the receiver.

- ❶ Use the MULTI CONTROL $\triangleleft/\triangleright$ (or Multi $\triangleleft/\triangleright$ keys) to select "GameFunction" on setup displays, and press the ENTER (or the Enter key).
- ❷ Press the MULTI CONTROL \triangle/∇ (or the Multi \triangle/∇ key) to select the game mode.

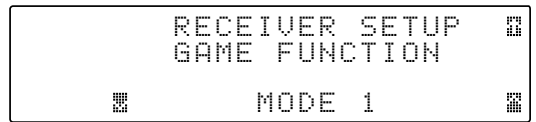
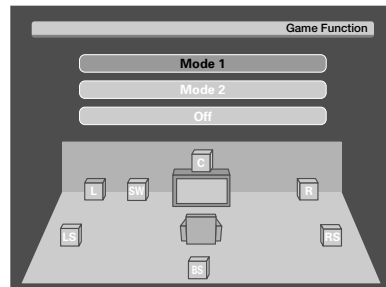

- ❶ "Mode 1":
When the connected game machine is turned ON, the input selector is switched automatically to "GAME". In addition, the ACTIVE EQ function is switched to "ACTIVE EQ GAME" and the listen mode is switched to the appropriate mode for games.

- ❷ "Mode 2":
When the connected game machine is turned ON, the input selector is switched automatically to "GAME".

- ❸ "OFF":
The game mode is switched OFF.

- Press the **SETUP** (or **Setup**) key to cancel the SETUP mode in the middle.
- The game mode is not activated if no video signal is input to the VIDEO jack in the GAME jack section.
- The game mode is not activated when the DUAL SOURCE function is switched ON. →[31]

- ❸ Press the ENTER (or the Enter key) again to return to the main setup displays.

Re-assignment of rear panel jacks

Assignment

The assignment of the input selector positions to the digital audio and component video input jacks can be changed as desired.

Perform the operations in "Preparation" in "Speaker settings" and its procedure steps 1 to 3. → 20

- Use the MULTI CONTROL </> (or the Multi </> keys) to select "Assignment" and press the ENTER key (or the Enter key).

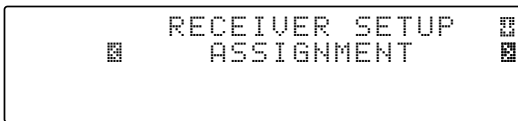
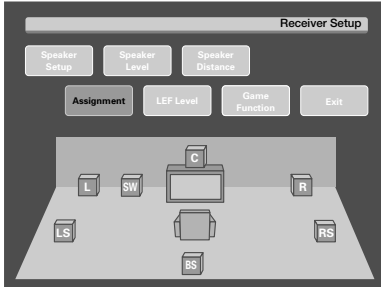

- Use the MULTI CONTROL </> (or the Multi </> keys) to select "Digital Input" or "Component Video", and press the ENTER (or the Enter key).

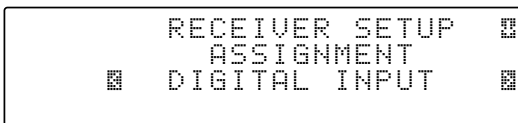
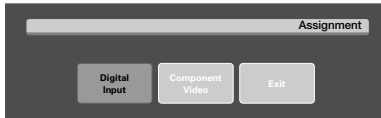

- "Digital Input":**
Select to change the assignment of the digital audio input jacks of the receiver.
 - "Component Video":**
Select to change the assignment of the component video input jacks of the receiver.
 - "Exit":** Select "Exit" and press the ENTER (or the Enter key) to return to the previous display.
- Press the **SETUP** (or **Setup**) key to cancel the SETUP mode in the middle.

- Use the MULTI CONTROL </> (or the Multi </> key) to select the input jack name and then press the MULTI CONTROL Δ/▽ (or the Multi Δ/▽ key) to select the input selector position.

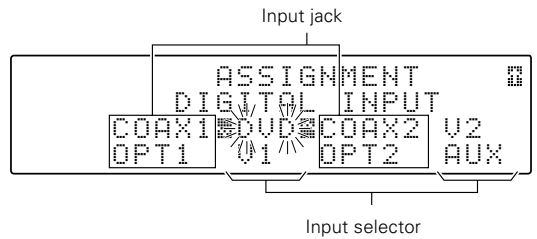
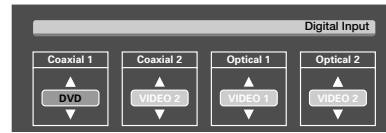

When the "Digital Input" has been selected :

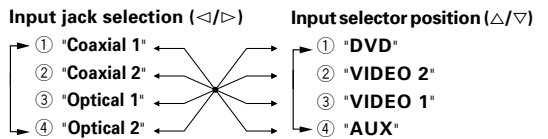

When the "Component Video" has been selected :

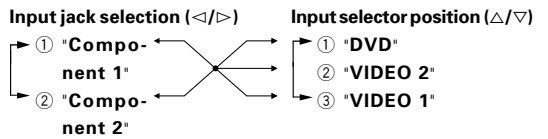

Use the following table for your memorandum.

Jack name	Assigned input selector
COAX1 (DVD)	
COAX2 (VIDEO 2)	
OPT1 (VIDEO 1)	
OPT2 (AUX)	
COMPONENT VIDEO INPUT IN1 (DVD)	
COMPONENT VIDEO INPUT IN2 (VIDEO 2)	

- It is not permitted to assign two input selector positions for one input jack.

- Repeat step 3 until you have assigned the desired jacks to the desired input selector positions.
- Press the ENTER (or the Enter key) again to return to the main setup displays.

Network settings

This unit can be connected to a PC through a LAN circuit. It is required to set up the network before connecting this unit to the PC.

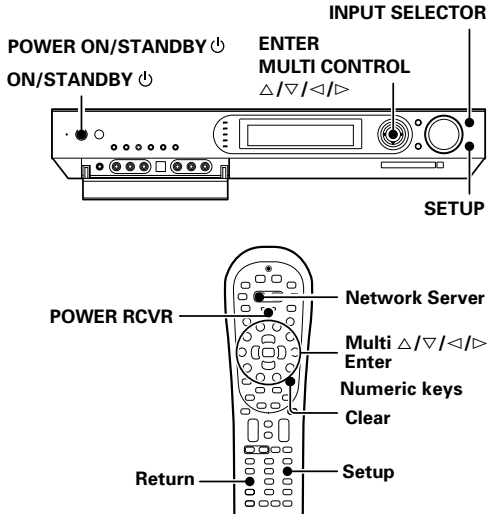

Preparation

Turn on the power to this receiver by pressing the **POWER ON/STANDBY** (For U.S.A. and Canada) or the **ON/STANDBY** (For Europe and Australia) key (or the **POWER RCVR** key on the remote).

1 Use the INPUT SELECTOR key (or the Network Server key) to select "NET SERVER".

When the "NET SERVER" input is selected, the OSD function on the TV screen is activated and detection of the server starts.



2 Use the MULTI CONTROL key (or the Multi key) to select "SETUP", and press the ENTER (or the Enter key).



3 Use the MULTI CONTROL key (or the Multi key) to select "Network Setup", and press the ENTER (or the Enter key).

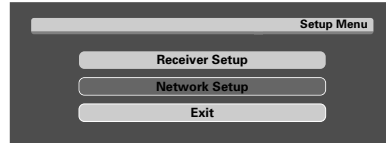

4 Use the MULTI CONTROL key (or the Multi key) to select the setting item, and press the ENTER (or the Enter key).

When the "Main" has been selected :

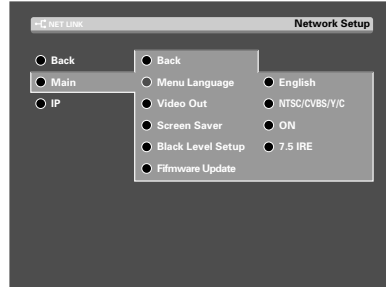

1 "Main" Setting: -27

This includes the setting of the language of the OSD menu, setting of the video format used when this unit outputs the video or photo data in PC that has been input through the network, setting of the screen saver, setting of the black level, and updating of the firmware.

2 "IP" Setting: -29

This consists of the setting of the IP address.

3 "Back": Select "Back" and press the ENTER (or the Enter key) to return to the previous display. (The same operation is also available by pressing the Return key or Multi < key)

- While the main setup screen is displayed, the setup mode can be canceled by pressing the **SETUP** key (or the **Setup** key).

5 Use the MULTI CONTROL key (or the Multi key) to select an option or input the desired numeric or alphabetic characters using the numeric keys, and then press the ENTER (or the Enter key).

- If you made a mistake, press the **Clear** key and input the correct character.

When the "Menu Language" has been selected :

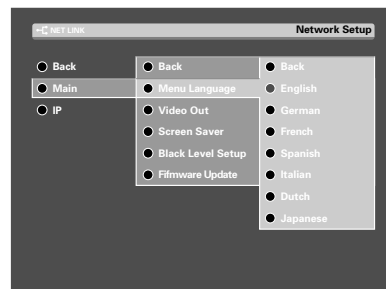

6 Press the ENTER (or the Enter key) again to return to the main setup displays.

7 Turn off the power to this receiver by pressing the POWER ON/STANDBY (For U.S.A. and Canada) or the ON/STANDBY (For Europe and Australia) key (or the POWER RCVR key).

“Main” Setting

The settings available in this menu includes the setting of the language of the OSD menu, setting of the video format used when this unit outputs the video or photo data in PC that has been input through the network, setting of the screen saver, setting of the black level, and updating of the firmware.

The default setups are as follows.

“Menu Language” Setting: “English”

“Video Out” Setting:

“NTSC CVBS&Y/C” (For U.S.A. and Canada)

“PAL CVBS&Y/C” (For Europe and Australia)

“Screen Saver” Setting: “ON”

“Black Level Setup” Setting: \rightarrow [28]

“7.5 IRE” (For U.S.A. and Canada)

“0 IRE” (For Europe and Australia)

“Menu Language” Setting:

This setting item is used to set the language used to display the setup menu and OSD on the TV screen.

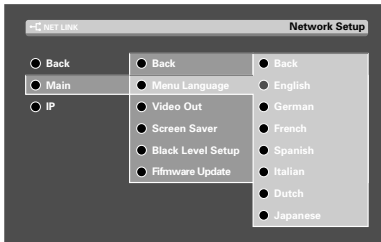

① “English”

② “German”

③ “French”

④ “Spanish”

⑤ “Italian”

⑥ “Dutch”

⑦ “Japanese”

“Video Out” Setting:

This setting item is used to select the format of the video signal output at the VIDEO OUT jacks.

The video format should be selected according to the video format of the connected TV.

Press the Video Out key to switch the video format temporarily. \rightarrow [58]

As this is merely a temporary setting, the video format should be re-set in the network setting operation.

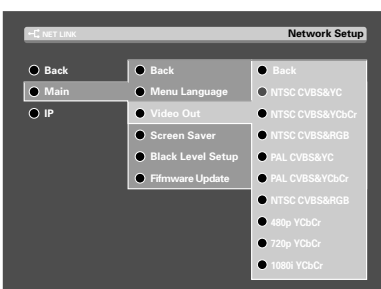

	Video Format	Composite Output	S Video Output	Component output
①	NTSC	CVBS	Y/C	—
②	NTSC	CVBS	—	Y Cb Cr
③	PAL	CVBS	Y/C	—
④	PAL	CVBS	—	Y Cb Cr
⑤	480p (NTSC)	—	—	Y Cb Cr
⑥	576p (PAL)	—	—	Y Cb Cr
⑦	720p	—	—	Y Cb Cr
⑧	1080i	—	—	Y Cb Cr

● The initial setting is “NTSC CVBS&Y/C” (For U.S.A. and Canada).

● The initial setting is “PAL CVBS&Y/C” (For Europe and Australia).

Video Formats

There are roughly two kinds of video formats that are used to display TV pictures and video data (NTSC and PAL). These formats are used according to the countries and regions.

TV formats in major countries

“NTSC”: Japan, Taiwan, Korea, USA, Canada, Mexico, Philippines, Chile, etc.

“PAL”: China, U.K., Germany, Australia, New Zealand, Kuwait, Singapore, etc.

Interlaced scanning and progressive scanning

These are the two scanning methods for displaying the TV picture. Interlaced scanning displays a TV picture by drawing every other scanning line from the top of the screen, and progressive scanning draws all scanning lines from the top of the screen.

Progressive scanning offers a TV picture with fewer flickers than interlaced scanning.

The figure used in the video format name indicates the number of effective scanning lines.

Example:

“720p”: Progressive scanning with 720 effective scanning lines

“1080i”: Interlaced scanning with 1080 effective scanning lines

“Screen Saver” Setting:

This setting item is used to set the screen saver function.

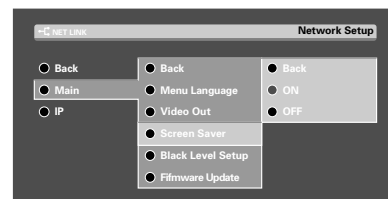

① “ON”: The screen saver starts when you leave this unit in stop mode for about 5 minutes.

② “OFF”

"Black Level Setup" Setting:

This setting item is used to set the black level.

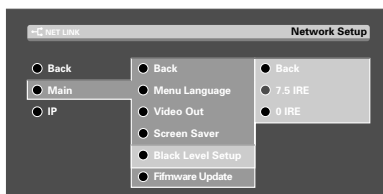

- ① **"7.5 IRE"**: Standard black level for the USA and Canada.
- ② **"0 IRE"**: Standard black level for Europe and Australia.

"Firmware Update":

Refer to page 83 for Firmware Update.

"IP" Setting

The default setups are as follows.

- "Obtaining Address" Setting: "Auto"
- "IP Address" Setting: "192.168.1.1"
- "Subnet Mask" Setting: "255.255.255.0"

Automatic setting:

To set the IP address automatically, set item "Obtaining Address" to "Auto".

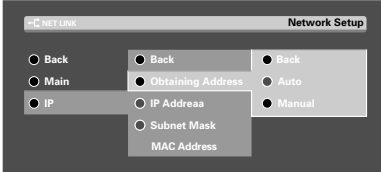

- ① "Auto": Automatic setting
- ② "Manual": Manual setting

- The initial setting is "Auto".

Usually, the IP address is set automatically when the network is connected. (If the network connection fails, it is required to set the IP address manually.)

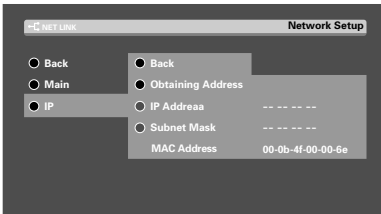

Manual setting:

To set the IP address manually, set item "Obtaining Address" to "Manual".

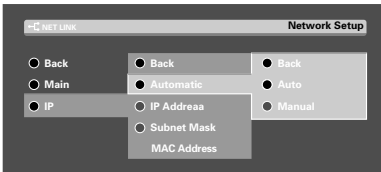

- ① "Auto": Automatic setting
- ② "Manual": Manual setting

- The initial setting is "Auto".

"IP Address" Setting:

Check the IP addresses of all of the devices connected to the network and set an unused IP address so that it does not overlap with any other. For the checking of IP addresses, see "How to check the IP address of the PC".

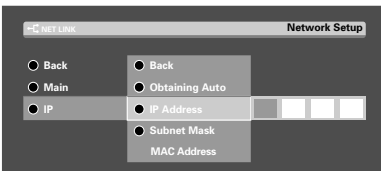

- It is recommended to set an IP address between 192.168.1.1 and 192.168.255.255.

"Subnet Mask" Setting:

Enter the subnet mask, which is issued by the provider, using the numeric keys. (It is usually 255.255.255.0.)

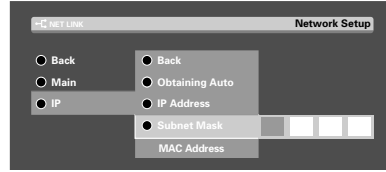

- It is recommended to set the subnet mask of 255.255.255.0.

"MAC Address" display:

The MAC (Media Access Control) Address assigned to this unit can be displayed. (The MAC address cannot be changed.)

How to check the IP address of the PC:

The operation of the PC is variable depending on the OS. Please refer to the instruction manual for your PC for details. The following description takes Windows XP as example.

To check the IP address of the PC, it is required to log on with the Administrator's authority.

Operation with Windows XP:

- ① Select [Start] ⇒ [Control Panel].
- ② Select [Network and Internet Connection] ⇒ [Network Connection], click the mouse right button on [Local Area Connection] and select the properties.
- ③ Click on [Internet Protocol (TCP/IP)], click on the [Properties] button.

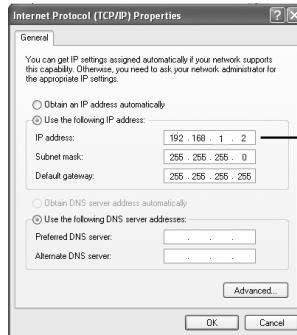

Check IP address here.

- When setting the IP address of this unit manually, set it so that it is not identical to the IP address checked here.

Example:

PC: 192.168.1.2
 VRS-N8100: 192.168.1.1

Normal playback

Some preparatory steps are needed before starting playback.

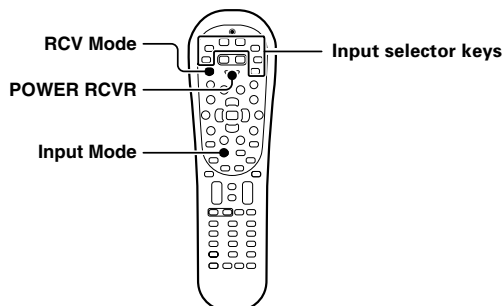
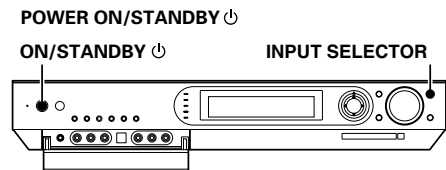

Listening to a source component

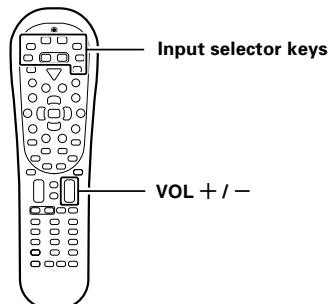
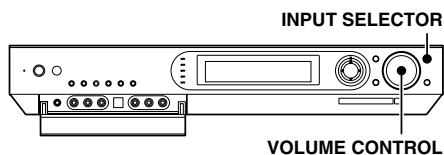

Turning on the receiver

- 1 Turn on the power to the related components.
- 2 Turn on the power to this receiver by pressing the POWER ON/STANDBY ⏻ or the ON/STANDBY ⏻ key (or the POWER RCVR key).
 - After turning off a power supply, the POWER ON/STANDBY ⏻ or the ON/STANDBY ⏻ key is not effective for 3 seconds.

Selecting the input mode

If you have selected a component connected to the COAX 1 (DVD), COAX 2 (VIDEO 1), OPT 1 (VIDEO 2), OPT 2 (AUX) or DIGITAL IN (OPTICAL) jacks, make sure that the input mode setting is correct for the type of audio signal to be used. → 9

- 1 Press the INPUT SELECTOR key (or the Input selector keys/ DVD, VID1, VID2, AUX, F.AUX, Game, TUNER, Network Server or Memory Card) to select the source.

- 1 "TUNER"
- 2 "DVD"
- 3 "VIDEO1"
- 4 "VIDEO2"
- 5 "GAME"
- 6 "F.AUX"
- 7 "AUX"
- 8 "NET SERVER"
- 9 "MEMORY CARD"

- When the "NET SERVER" or "MEMORY CARD" input is selected, the OSD function on the TV screen is activated and detection of the server starts. → 54 - 59

- 2 Start playback from the selected source.

- 3 Use the VOLUME CONTROL knob (or the VOL +/- keys) to adjust the volume.

Listening with headphones

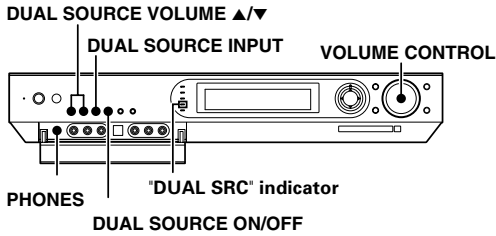

- 1 Connect headphones to the PHONES jack.



- 2 Use the VOLUME CONTROL knob (or the VOL +/- keys) to adjust the volume.

Playing different sources through speakers and headphones (DUAL SOURCE function)

While you enjoy audio listening through the speakers, another person can enjoy another source (audio + video) through headphones by connecting the source to the **GAME** or **FRONT AUX** jacks.

- 1 Connect headphones to the PHONES jack.
- 2 Press the DUAL SOURCE ON/OFF key to switch the DUAL SOURCE function ON.
 - When the DUAL SOURCE function is ON, the video and headphone outputs reproduce only the second input source of the DUAL SOURCE function. At this time, the audio from the main source, which is selected with the input selector, continues to be monitored through the speakers. Switching the DUAL SOURCE function OFF restores the main input source signals to the video and headphone outputs.

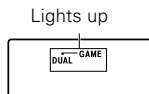

- 3 Press the DUAL SOURCE INPUT key to select the second input source for the DUAL SOURCE function.
 - 1 "DUAL SOURCE GAME" :
The "GAME" input is selected as the second input source for the DUAL SOURCE function.
 - 2 "DUAL SOURCE F. AUX" :
The "F. AUX" input is selected as the second input source for the DUAL SOURCE function.
- 4 Press the DUAL SOURCE VOLUME ▲ / ▼ to adjust the headphone listening volume.
 - When the DUAL SOURCE function is ON, the input mode for the second input source is fixed at "ANALOG". The listen mode cannot be changed. - [9] - [41]

Adjusting the sound

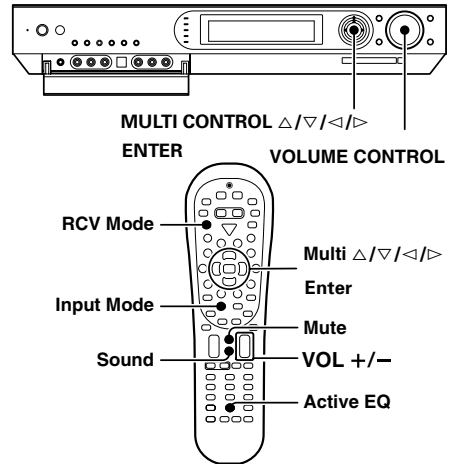

Adjusting the TONE (PCM stereo and analog stereo mode only)

- 1 Press the RCV Mode key on the remote control unit to set it to the receiver control mode.
- 2 Press the Sound key.
- 3 Use the MULTI CONTROL ◀ / ▶ (or the Multi ◀ / ▶ keys) to select "TONE CONTROL", and press the ENTER (or the Enter key).
- 4 Use the MULTI CONTROL ◀ / ▶ (or the Multi ◀ / ▶ keys) to select "ON", and press the ENTER (or the Enter key).

Lights up

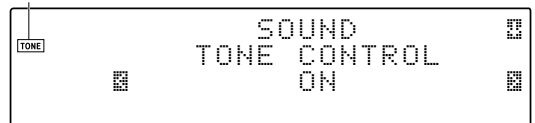

- 5 Use the MULTI CONTROL ◀ / ▶ (or the Multi ◀ / ▶ keys) to select "BASS" or "TREBLE".
 - 1 "BASS" :
Select this to adjust the low frequency range.
 - 2 "TREBLE" :
Select this to adjust the high frequency range.
- 6 Use the MULTI CONTROL ▲ / ▼ (or the Multi ▲ / ▼ keys) to adjust the sound quality.

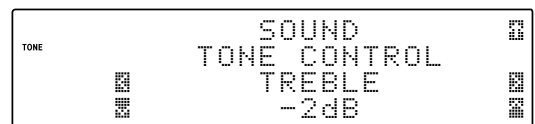

- 7 Repeat steps 5 and 6 as required.
 - The adjustment mode is displayed for approximately 20 seconds.
 - The bass and treble levels are adjustable from -10dB to +10dB in 2 step increments.
- 8 Press the Sound key again to return to the input indication.

Input level adjustment (analog sources only)

If the input level of an analog source signal is too high, the "CLIP" indicator will light up to indicate the source signal. Adjust the input level.



- ❶ Press the RCV Mode key on the remote control unit to set it to the receiver control mode.
- ❷ Press the Sound key.
- ❸ Use the MULTI CONTROL </> (or the Multi </> keys) to select "ANALOG INPUT LEVEL", and press the ENTER (or the Enter key).
- ❹ Use the MULTI CONTROL Δ / ∇ (or the Multi Δ / ∇ keys) to adjust the input level.

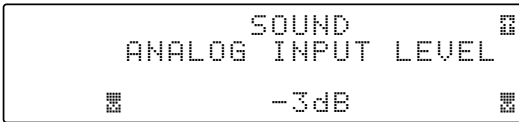

- The adjustment mode is displayed for approximately 20 seconds.
 - The input level may be adjusted to any one of three settings: 0dB, -3dB, and -6dB. (The initial setting is 0dB.)
 - You can store a separate input level for each input selector.
- ❺ Press the Sound key again to return to the input indication.

ACTIVE EQ mode

You can enjoy a more impressive sound effect when ACTIVE EQ is turned ON.

Press the **Active EQ** key for the following selections:

- ❶ "ACTIVE EQ MUSIC" : (The "ACTIVE EQ" indicator lights up)
Effective when listening to music.
- ❷ "ACTIVE EQ CINEMA" : (The "ACTIVE EQ" indicator lights up)
Effective when watching a movie.
- ❸ "ACTIVE EQ GAME" : (The "ACTIVE EQ" indicator lights up)
Effective when playing a game.
- ❹ "ACTIVE EQ OFF" : (The "ACTIVE EQ" indicator goes off)
The ACTIVE EQ function is turned OFF.

- The ACTIVE EQ function is not available in when the REC MODE or virtual mode is ON.

Muting the sound

The **Mute** key lets you mute the sound of the speakers or headphones.

Press the **Mute** key.



Blinks

To cancel

Press the Mute key again so that the "MUTE" indicator goes off.

- MUTE ON can also be deactivated by turning the **VOLUME CONTROL** knob or pressing the **VOL +/-** keys.

Recording

Analog sources

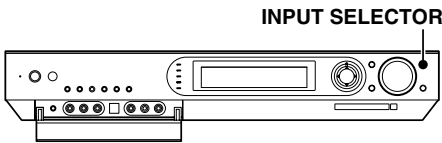

- 1 Use the **INPUT SELECTOR** key (or the input selector key) to select the source (other than "VIDEO 1") you want to record.
- 2 Put the component connected to the **VIDEO 1** jacks to the record-pause mode.
- 3 Start playback, then start recording.
 - Recording may not be normal for some video software. This is due to the copy guard condition.

Digital sources

Switch on the **REC MODE** to record a digital input source. When the digital mode changes during recording in the **REC MODE**, the audio signal may be interrupted momentarily.

Recording music in REC mode

When a multi-channel source such as the Dolby Digital or DTS input signal is recorded in **REC** mode, the multi channel signal in the current surround mode can be recorded down-mixed to 2-channel.

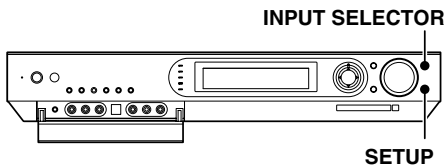

- 1 Use the **INPUT SELECTOR** key (or the Input Selector keys) to select the source ("DVD", "VIDEO 2", "AUX", "GAME" or "NET SERVER") you want to record.
- 2 Put the component connected to the **VIDEO 1** jacks to the record-pause mode.
- 3 Press and hold the **SETUP** key on the main unit for more than 2 seconds to select the "REC MODE".
 - 1 REC mode off
 - 2 "REC MODE": REC mode on

Multi-channel digital signals (DTS or Dolby Digital) are down-mixed to 2-channel before being output from the analog recording (REC OUT) jacks.

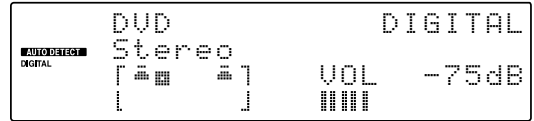

The display switches automatically.

- 4 Start playback, then start recording.

Listening to radio broadcasts

The receiver can store up to 40 stations in the memory and recall them by one-touch operation. Radio stations can be classified into RDS (Radio Data System) stations and other stations. To listen to or store RDS stations in the preset memory see "Using RDS (Radio Data System) (For Europe)". → 36

Tuning (non-RDS) radio stations

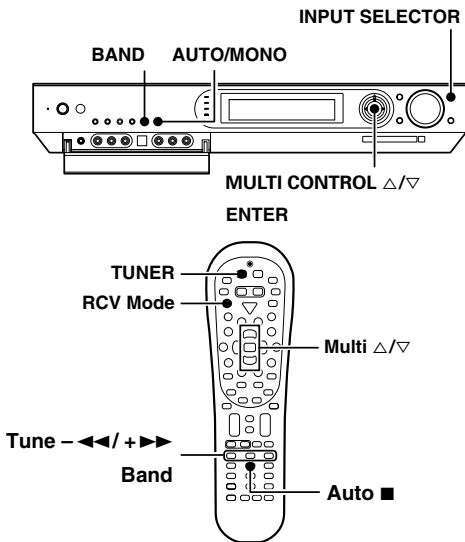

- 1 Use the **INPUT SELECTOR** key (or the **TUNER** key) to select the tuner.
- 2 Use the **BAND** key (or the **Band** key) to select the desired broadcast band.

Each press switches the band.



- 3 Use the **AUTO/MONO** key (or the **Auto ■** key) to select the desired tuning method.

Each press switches the tuning method to either auto or manual tuning.

- 1 Auto tuning:
The "AUTO" indicator lights up
- 2 Manual tuning:
The "AUTO" indicator goes off

 "AUTO" indicator lights up in the display.

- Normally, set to "AUTO" (auto tuning). If the radio waves are weak and there is a lot of interference, switch to manual tuning. (With manual tuning, stereo broadcasts will be received in monaural.)

- 4 Use the **MULTI CONTROL** Δ/∇ (or **Multi** Δ/∇ keys, **Tune** +/- keys) to select the station.

 "TUNED" indicator is displayed when a station is received. "ST." indicator lights when a broadcast is being received in stereo.

Auto tuning:

The next station is tuned automatically.

Manual tuning:

Use the **MULTI CONTROL** Δ/∇ (or **Multi** Δ/∇) to select the desired station.

Presetting radio stations

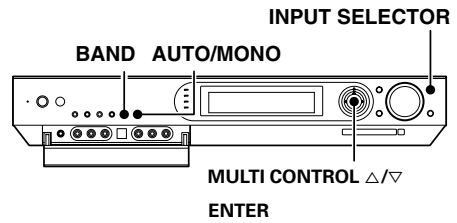

Collective presetting of stations

(For U.S.A., Canada and Australia)

- 1 Use the **INPUT SELECTOR** key (or the **TUNER** key) to select the tuner.
- 2 Use the **BAND** key (or the **Band** key) to select the broadcast band to "FM".
- 3 Press and hold the **ENTER** for more than 2 seconds.

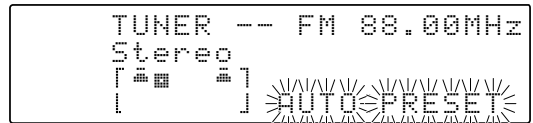

- A maximum of 40 stations of the band presently being received will be preset.
- Use the Manual Preset function if a desired FM station cannot be preset using the Auto Preset function or when it is required to preset AM stations.

Presetting radio stations manually

- 1 Tune to the station you want to store.
- 2 Press the **ENTER** while receiving the station.

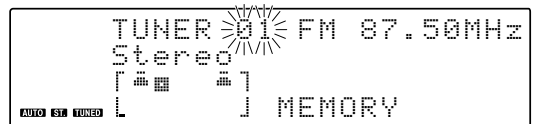

Proceed to step 3 within 20 seconds. (If more than 20 seconds elapse, press the ENTER again).

- 3 Use the **MULTI CONTROL** Δ/∇ (or the **Multi** Δ/∇ keys) to select one of the station presets (1 – 40).
- 4 Press the **ENTER** again to confirm the setting.

- Repeat steps 1, 2, 3, and 4 to store as many stations as necessary.
- If you store a station at a previously used preset, the old station will be replaced by the new one.

Receiving preset stations

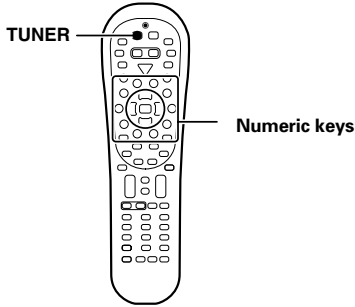
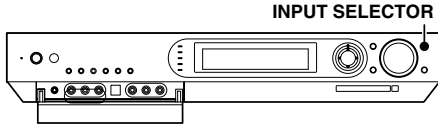

1 Use the **INPUT SELECTOR** key (or the **TUNER** key) to select tune as the source.

2 Enter the number of the preset station you want to receive (up to "40").

Press the numeric keys in the following order:

For "15", press **+10**, **5**

For "20", press **+10**, **+10**, **0**

- If you make a mistake entering a two digit number, press the **+10** key repeatedly to return to the original display and start again.



Receiving preset stations in order (P.CALL)

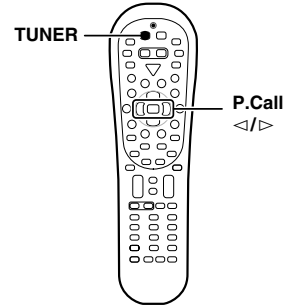
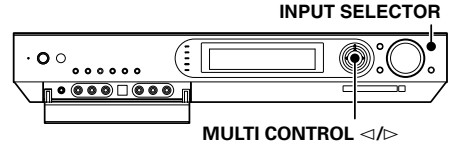

1 Use the **INPUT SELECTOR** key (or the **TUNER** key) to select tune as the source.

2 Use the **MULTI CONTROL** **</>** (or the **P.Call** **</>** keys) to select the desired station.

- Each time you push the Joystick, another preset station is received in order.

Pushing the Joystick to **>** does the following:

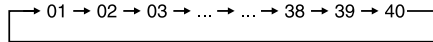

Pushing the Joystick to **<** does the following:

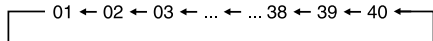

Holding the Joystick on **>** or **<** direction, lets you skip through the presets, receiving each preset station at 0.5 second intervals.

Using RDS (Radio Data System) (For Europe only)

RDS is a system that transmits useful information (in the form of digital data) for FM broadcasts along with the broadcast signal. Tuners and receivers designed for RDS reception can extract the information from the broadcast signal for use with various functions, such as automatic display of the station name.

RDS functions:

PTY (Program TYpe Identification) Search --[37]

Automatically tunes to a station that is currently broadcasting the specified program type (genre).

PS (Program Service Name) Display

Automatically displays the station name transmitted by the RDS station.

RDS AUTO MEMORY function --[37]

Automatically selects and stores up to 40 RDS stations in the preset memory.

If fewer than 40 RDS stations have been stored in the preset memory, regular FM stations will be stored in the remaining places.

Radio Text function

Displays the radio text data transmitted by some RDS stations when you press the RDS Disp. (display) key. There is **"No Radio Text"** if no text data is transmitted.

The **"RDS"** indicator lights up when an RDS broadcast (signal) is received.

```
TUNER -- FM 92.50MHz
Stereo
[ [ # # ] ] VOL -36dB
[ [ # # ] ] [ [ # # ] ]
```

Note

Some functions and function names may differ for certain countries and areas.

Before using a function utilizing the RDS, be sure to perform the RDS Auto Memory operation by referring to the description in **"Presetting RDS stations (RDS AUTO MEMORY)"**. --[37]

Using the RDS Disp. (Display) key

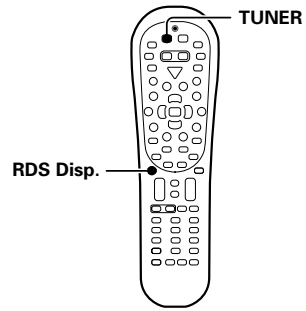

Pressing the RDS Disp. key changes the contents of the display.

Each press switches the display mode as follows :

- ① PS (Program Service name) display
- ② RT (Radio Text) display
- ③ Frequency display

① PS (Program Service name) display :

The station name is displayed automatically when an RDS broadcast is received.

If no PS data was sent, **"NO PS"** is displayed.

```
TUNER 01 FM107.95MHz
BAYERN 1
[ [ # # ] ] VOL -75dB
[ [ # # ] ] [ [ # # ] ]
```

② RT (Radio Text) display :

Text data accompanying the RDS broadcast scrolls across the display. **"No Radio Text"** or **"Radio Text Reading"** is displayed if the current RDS station does not provide RT data.

```
TUNER 01 FM107.95MHz
Radio Text...
[ [ # # ] ] VOL -75dB
[ [ # # ] ] [ [ # # ] ]
```

③ Frequency display :

Displays the frequency of the current station.

```
TUNER 01 FM107.95MHz
Stereo
[ [ # # ] ] VOL -75dB
[ [ # # ] ] [ [ # # ] ]
```

Presetting RDS stations (RDS AUTO MEMORY)

This function automatically stores up to 40 RDS stations in the preset memory. In order to use the PTY function, the RDS stations must be stored in the preset memory using the RDS Auto Memory function.

- 1 Use the **INPUT SELECTOR** key (or the **TUNER** key) to select tune as the source.
- 2 Use the **BAND** key (the **Band** key) to select the broadcast band to "FM".
- 3 Press and hold the **ENTER** for more than 2 seconds will start **AUTO MEMORY**.

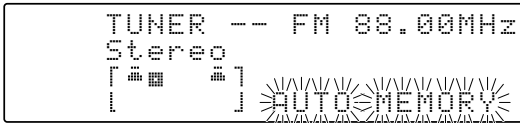

- After a few minutes, up to 40 RDS stations are preset in order from channel "01".
- Stations already stored in the preset memory may be replaced by RDS stations. (i.e., If the RDS AUTO MEMORY function detects 15 RDS stations, the stations currently preset at numbers 01~15 will be replaced by the RDS stations.)

Tuning by Program Type (PTY search)

This function lets you set the tuner to automatically search for stations which are currently broadcasting the type of program (genre) you want to listen to.

Under certain receiving conditions, it may take more than 1 minute to complete the search.

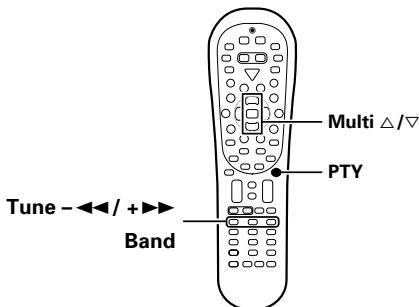

Preparations

- Execute the RDS auto memory procedure.
- Set the broadcast band to FM.
- Tune to an RDS station.

- 1 Press the **PTY** key to activate the **PTY** search mode.

Lights up

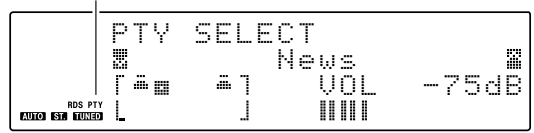

When an RDS broadcast is received, the program type is shown on the display. If no PTY data is available, or if the station is not an RDS station, "None" is displayed.

- 2 While the "PTY" indicator is lit, use the **MULTI CONTROL** </> /> (or the **P.Call** </> /> keys) to select the program type of your choice.

Program type table

Program Type Name	Display	Program Type Name	Display
Pop Music	Pop Music	Weather	Weather & Metr
Rock Music	Rock Music	Finance	Finance
Easy Listening Music	Easy Listening	Children's Programmes	Children's Progs
Light Classical Music	Light Classics M	Social Affairs	Social Affairs
Serious Classical Music	Serious Classics	Religion	Religion
Other Music	Other Music	Phone In	Phone In
News	News	Travel	Travel & Touring
Current Affairs	Current Affairs	Leisure	Leisure&Hobby
Information	Information	Jazz Music	Jazz Music
Sport	Sport	Country Music	Country Music
Education	Education	National Music	National Music
Drama	Drama	Oldies Music	Oldies Music
Culture	Cultures	Folk Music	Folk Music
Science	Science	Documentary	Documentary
Varied Speech	Varied Speech	Alarm Test	Alarm Test
Alarm	Alarm-Alarm!		

- 3 Press the **PTY** key to start searching.

Example: Searching for a Pop Music broadcast.

Display while searching.

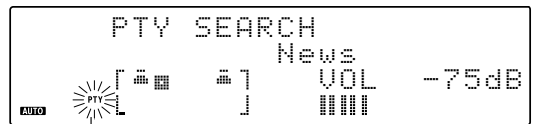

Blinks

Program type name display

Display when a station is received.



Goes out

Station name display

- No sound is heard while "PTY" is blinking.
- If the desired program type cannot be found, "NO PROGRAM" is displayed, then after several seconds the display returns to the original display.

To select another program type.

Repeat steps 1, 2 and 3.

Ambience effects

This receiver is equipped with listening modes that allow you to enjoy an enhanced sonic ambience with a variety of video sources.

In order to obtain the optimum effect from the surround modes, make sure to input the proper speaker settings beforehand. → [20]

Surround modes

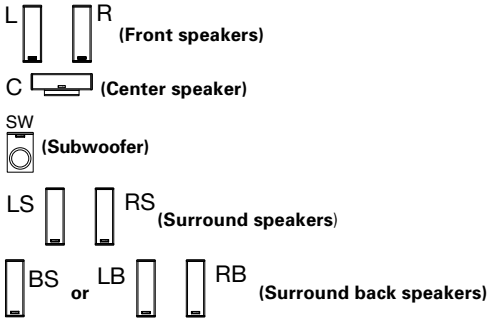

Dolby Digital EX

Dolby Digital EX is an extension of Dolby Digital technology, Dolby Digital EX creates six full-bandwidth output channels from 6.1-channel sources. This is done using a matrix decoder that derives three surround channels from the two in the original recording.

This is achieved by using three different surround signals, Left Surround, Right Surround, and Back Surround, each driving its own array of speakers. Think of it as adding a center channel for the rear speakers, which give more diffuse and natural surround effect, even if you wanted the ability to completely encircle the audience with sound, positioning sound effects exactly where they would be heard in real life.

Note

For best results, Dolby Digital EX should be used with movie soundtracks recorded with Dolby Digital Surround EX which contain a digital flag that will automatically activate this feature. However, for titles released prior to late 2001, this feature has to be activated manually.

This model lets you enjoy Dolby Digital (and Dolby Surround) program sources, even if you connect only the Front Speakers. However, in order to enjoy the benefit of true 6.1 channel Dolby Digital Surround EX sound, KENWOOD recommends that you connect a full set of speakers.

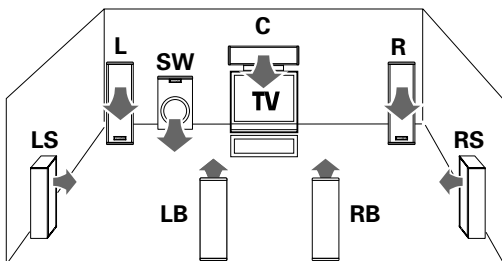

Dolby PRO LOGIC Ix/Dolby PRO LOGIC II

Dolby Pro Logic Ix was designed specifically to provide a new sense of spatiality, directionality and articulation of sounds from Dolby Surround encoded sources.

This is achieved with an intelligent, built-in feedback logic design, a matrix surround decoding and the decoding of stereo, full bandwidth surround outputs. The PRO LOGIC Ix modes programmed into this receiver are "MOVIE", "MUSIC" and "GAME". The "MOVIE" mode of the PRO LOGIC Ix has preset characteristics to produce a calibrated, high-level surround sound playback while the "MUSIC" mode has user-adjustable characteristics to offer the three optional controls, like "Dimension", "Center Width" and "Panorama" modes to allow optimization of the soundfields as desired. The "Dimension" control allows the user to gradually adjust the soundfield either towards the front or towards the rear; the "Center Width" control allows various adjustment of the left-center-right speakers' balance; the "Panorama" mode extends the front stereo image to include the surround speakers for an exciting "wraparound" effect with side wall imaging. The "GAME" mode is designed for playing video games and enhances the powerful feeling of sound.

Dolby PRO LOGIC Ix

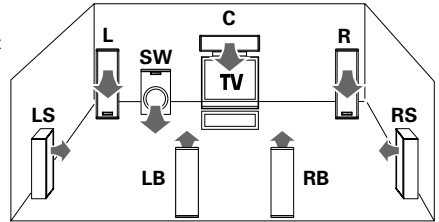

Dolby PRO LOGIC II

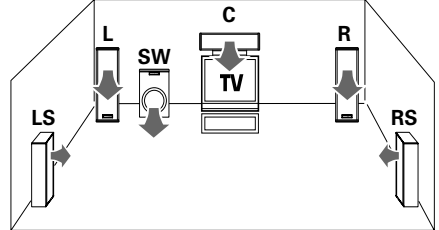

Dolby Digital

Dolby Digital surround format lets you enjoy up to 5.1 channels of digital surround sound from Dolby Digital program sources (such as Laserdisc or DVD software marked). Compared with previous Dolby surround, Dolby Digital provides even better sound quality, greater spatial accuracy, and improved dynamic range.

This model lets you enjoy Dolby Digital (and Dolby Surround) program sources, even if you connect only the Front Speakers. However, in order to enjoy the benefit of true 5.1 channel Dolby Digital surround sound, KENWOOD recommends that you connect a full set of speakers.

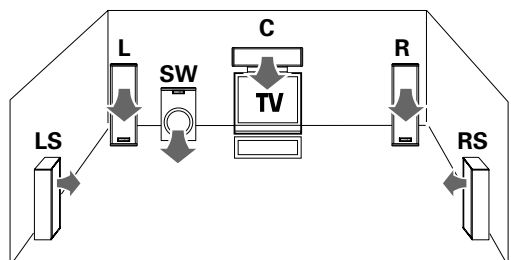

DTS-ES

The DTS-ES (Digital Theater System-Extended Surround) represents 6.1-channel Discrete Surround format, expanding upon 5.1 surround. DTS-ES format is a 6.1 channel sound system for movie theaters that includes an additional surround center channel matrixed within surround left and surround right. It's compatible on predecessor DTS 5.1 system. The extra channel allows more accurate placement and steering of sound across the rear soundstage. The DTS-ES receiver will be required, to experience a discrete 6.1-channel mix. The DTS-ES decoders used in home cinema systems have decoding options for utilizing the extra channel, in addition to processing existing 5.1 channel surround sound :

DTS-ES Discrete 6.1 and DTS-ES Matrix 6.1 add the surround back channel audio to the DTS 5.1-channel format to improve the acoustic positioning and makes acoustic image movement more natural with the 6.1-channel reproduction.

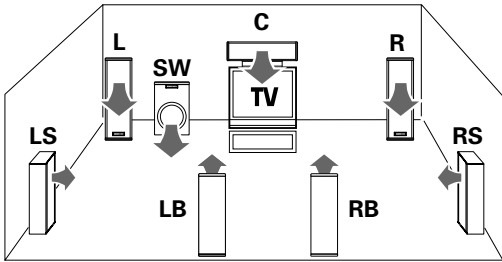

DTS

The DTS employs a larger amount of data than Dolby Digital to play surround sound with higher quality. The DTS can be used with DVD and LaserDisc software carrying the  mark. Although the number of channels is 5.1 and identical to Dolby Digital, the DTS format features lower audio compression rate in digital recording, which enables audio with more profoundness and higher S/N. The wider dynamic range and better channel separation also contribute to make the surround sound more precise and larger in scale.

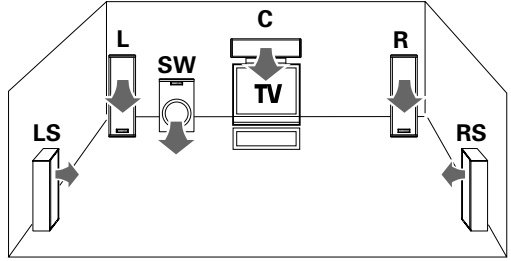

NEO:6

NEO:6 is a new technology which decodes 2-channel signals into 6-channel signals using high-accuracy digital matrix technology. For the best results, DTS-ES should be used with movie sound tracks recorded with DTS-ES format which contain a digital flag that will automatically activate this feature. However, for some titles, this feature has to be activated manually. According to the signals to be played back, DTS NEO:6 uses either the NEO:CINEMA mode optimized for movie playback or the NEO:MUSIC mode optimized for music playback.

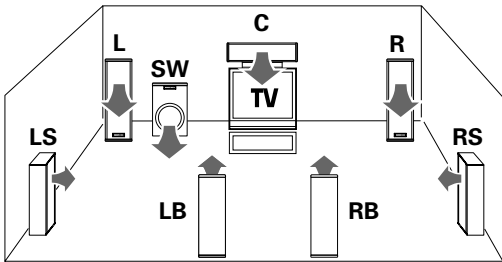

DSP mode

The DSP mode lets you add the atmosphere of a live concert or hall to almost any type of program source. These modes are particularly effective when used with stereo program sources, like CD, television, and FM radio. You might enjoy trying the ARENA, JAZZ CLUB, THEATER, STADIUM or DISCO mode the next time you watch a concert or sporting event!

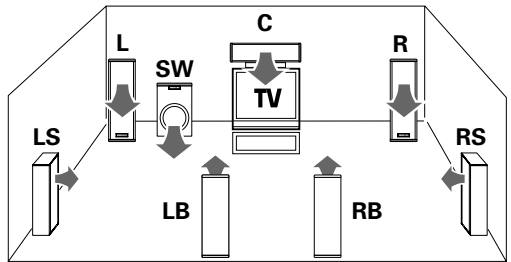

What's DSP?

DSP stands for Digital Signal Processor. The way a sound is heard in an actual environment depends on a variety of different factors. One of the most important is reverberation (the act of decaying elements of sound echoing in various places). The DSP modes produce the feeling of presence by using the DSP to create reverberation, without spoiling the sound quality of the original signal.

DTS 96/24

The DTS 96/24 enables 5.1-channel playback with broad bandwidth over 40 kHz and high resolution without affecting the picture quality of DVD video. As it is compatible with the DTS surround playback, it makes it possible to play DTS 5.1-channel surround audio even when the AV amplifier incorporates only the DTS or DTS-ES decoder.

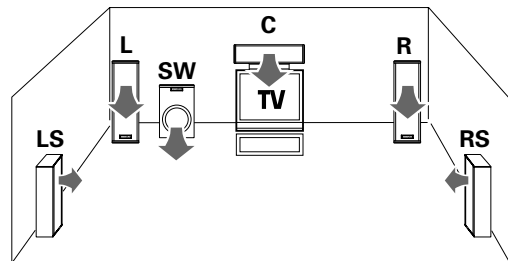

LFE = Low Frequency Effects. This channel delivers separate non-directional bass signals to the subwoofer for more dynamic deep bass sound effects. When there is a LFE channel input in the DOLBY DIGITAL or DTS format, the 'LFE' indicator lights on the display of the receiver.

Dolby Virtual Speaker

The Dolby Virtual Speaker features a virtual surround sound field. This implements an effect as if there are multiple speakers in the listening room.

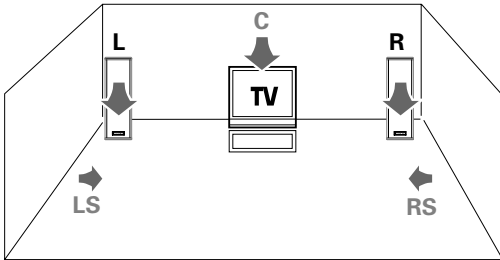

Dolby Headphone

When headphones are used in music listening, the audio of the left (or right) channel reaches only the left (or right) ear so the listener cannot feel the presence of acoustic images on the front.

The Dolby Headphone simulates a virtual room and include its acoustic characteristics in the left and right headphone signals. As a result, the listener can hear the same components as in speaker listening through the left and right ears and therefore feel as if the sound source is located on the front of the listener.

Virtual modes

The following modes allow you to enjoy powerful surround audio even when you use only two speakers or listen through headphones.

- In the Dolby Virtual Speaker and Dolby Headphone modes, only the listen modes for 2 channels can be selected. Also, the desired listen mode may be unable to be selected depending on the reproduced signals. → 41

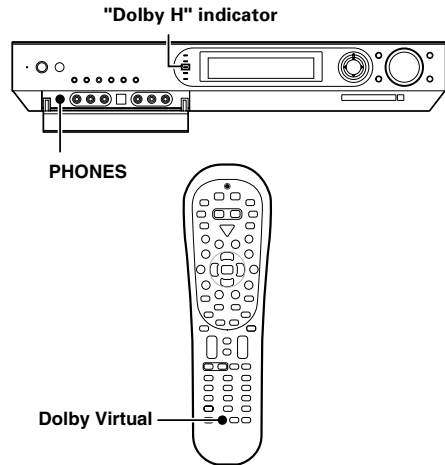

How to set the Dolby Virtual Speaker mode (when not using headphones):

Press the Dolby Virtual key for the following selections:

- ① **"DVS VS Wide"** :
The virtual surround effect can be given added expansion and spatial feeling.
 - ② **"DVS VS Ref."** : *
Standard setting.
 - ③ **"DVS VS Off"** : Cancel
- * This mode can be selected only when the surround speaker setting is OFF.

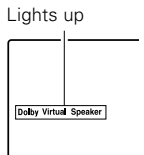

How to set the Dolby Headphone mode (when using headphones):

Press the Dolby Virtual key for the following selections:

- ① **"Dolby H DH 1"** :
Monitor room in a studio with small amount of reverberations.
- ② **"Dolby H DH 2"** :
General listening with optimum amount of reverberations.
- ③ **"Dolby H DH 3"** :
Wide space such as a movie theater.
- ④ **"Dolby H DH Off"** : Cancel

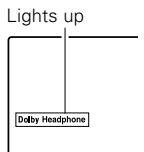

- The Dolby Virtual Speaker or Dolby Headphone mode is defeated when the DUAL SOURCE mode or REC MODE is ON.

Manufactured under license from Dolby Laboratories. "Dolby", "Pro Logic", "Surround EX" and the double-D symbol are trademarks of Dolby Laboratories.

"DTS", "DTS-ES Extended Surround", "Neo:6" and "DTS 96/24" are trademarks of Digital Theater Systems, Inc.

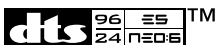

Surround play

The desired listen mode can be selected according to the input signal.

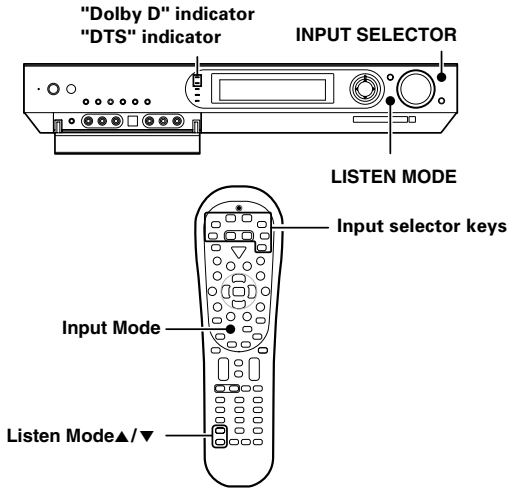

Preparations

- Turn ON related components.
- Complete **"Preparing for playback" (speaker settings)**. → 20
- Use the **INPUT SELECTOR** key (or Input Selector keys) to select the component you wish to play back with surround sound.
- Use the **Input Mode** key to select the input mode (analog or digital) for the source you wish to play back. → 9
- Noise will be produced when a DTS source is played by selecting the analog input.

1 Start playing the video software.

2 Press the LISTEN MODE key (or the Listen Mode ▲/▼ keys) to select the listening mode.

The listening mode settings are stored separately for each input selector.

If the input mode is set to full auto ("AUTO DETECT" lights), this model selects the optimal listening mode automatically based on the type of input signal and the speaker settings.

Each press the LISTEN MODE key (or the Listen Mode ▲/▼ keys) switches the setting as listed below. The listening mode settings are different depending on the type of input signal or speaker settings.

Listen modes available with Dolby Digital EX or Dolby Digital playback: ("Dolby D" indicator lights up)

Main example of medium:

Multi-channel digital source such as DVD.

- | | |
|----------------------------|--|
| ① "Dolby Digital": | DOLBY DIGITAL surround |
| ② "Dolby Digital EX": | DOLBY DIGITAL EX surround |
| ③ "Dolby D + PLIIx Movie": | DOLBY DIGITAL surround +
DOLBY PRO LOGIC IIX surround MOVIE mode* |
| ④ "Dolby D + PLIIx Music": | DOLBY DIGITAL surround +
DOLBY PRO LOGIC IIX surround MUSIC mode |
| ⑤ "Dolby Digital Stereo": | DOLBY DIGITAL stereo playback. |

* Can be selected only when two surround back speakers are connected.

- You can also adjust the midnight mode as desired. → 45

Listen modes available with DTS, DTS-ES (Matrix or Discrete) or DTS 96/24 playback: ("DTS" indicator lights up)

Main example of medium:

Multi-channel digital source such as DVD.

- | | |
|--------------------------|---|
| ① "DTS": | DTS surround |
| ② "DTS + NEO:6 Cinema": | DTS surround + DTS NEO:6 surround CINEMA mode |
| ③ "DTS + NEO:6 Music": | DTS surround + DTS NEO:6 surround MUSIC mode |
| ④ "DTS-ES Matrix 6.1": | DTS-ES 6.1-channel Matrix surround *1 |
| ⑤ "DTS-ES Discrete 6.1": | DTS-ES 6.1-channel Discrete surround *2 |
| ⑥ "DTS 96/24": | DTS 96/24 surround *3 |
| ⑦ "DTS Stereo": | DTS stereo playback |
| ⑧ "DTS 96/24 Stereo": | DTS 96/24 stereo playback |

*1 Can be selected only with DTS-ES 6.1ch Matrix Surround.

*2 Can be selected only with DTS-ES 6.1ch Discrete Surround.

*3 Can be selected only with DTS 96/24 Surround.

- You can also adjust the midnight mode as desired. → 45

Listen modes available with analog or PCM playback:

Main example of medium:

- Digital sources including DVD 96 kHz linear PCM and CD.
- Analog source such as VCR or radio broadcasting.

-
- ① **"Dolby PL IIX Movie":**
DOLBY PRO LOGIC IIX surround MOVIE mode *1

 - ② **"Dolby PL IIX Music":**
DOLBY PRO LOGIC IIX surround MUSIC mode *1 *2

 - ③ **"Dolby PL IIX Game":**
DOLBY PRO LOGIC IIX surround GAME mode *1

 - ④ **"Dolby PL II Movie":**
DOLBY PRO LOGIC II surround MOVIE mode

 - ⑤ **"Dolby PL II Music":**
DOLBY PRO LOGIC II surround MUSIC mode *2

 - ⑥ **"Dolby PL II Game":**
DOLBY PRO LOGIC II surround GAME mode

 - ⑦ **"Dolby Pro Logic":**
DOLBY PRO LOGIC surround

 - ⑧ **"NEO:6 Cinema" or "NEO:6 96k Cinema":**
DTS NEO:6 surround CINEMA mode

 - ⑨ **"NEO:6 Music" or "NEO:6 96k Music":**
DTS NEO:6 surround MUSIC mode *1 *3

 - ⑩ **"Arena":**
DSP surround ARENA mode *4

 - ⑪ **"Jazz Club":**
DSP surround JAZZ CLUB mode *4

 - ⑫ **"Theater":**
DSP surround THEATER mode *4

 - ⑬ **"Stadium":**
DSP surround STADIUM mode *4

 - ⑭ **"Disco":**
DSP surround DISCO mode *4

 - ⑮ **"Stereo":**
Normal stereo playback. *5

*1 Cannot be selected in Dolby Virtual Speaker and Dolby Headphone modes.

*2 The sound field can be adjusted as desired using the PANORAMA, DIMENSION and CENTER WIDTH modes. → [44]

*3 The sound field can be adjusted as desired using the CENTER IMAGE modes. → [45]

*4 Cannot be selected in Dolby Virtual Speaker and Dolby Headphone modes or with a 96 kHz linear PCM signal input.
The effect level of the DSP surround mode can be adjusted as desired. → [43]

*5 In Dolby Virtual Speaker and Dolby Headphone modes, the Dolby Digital signal input cannot be listened to in the stereo mode.

3 Adjust the volume.

Note

- Certain modes may be unavailable depending on the type of input signal or speaker setting.
- If an optimum surround effect cannot be obtained or the desired mode cannot be selected, check the speaker and input mode settings. → [9] → [20]

Dolby Digital Surround EX compliant disc :

Dolby Digital Surround EX compliant disc contains identification signals. When you choose FULL AUTO during "Input mode settings" (→ [9]), this amplifier detects the identification signals and change the LISTEN mode to the DOLBY DIGITAL EX (Dolby Digital Surround EX mode) automatically. But sometimes we find some discs which are Dolby Digital Surround EX compliant disc but it does not contain the identification signals. If you find the notice like "Surround EX" on the label of disc or package, you can choose DOLBY DIGITAL EX, then you can enjoy Dolby Digital Surround EX sound.

Switching the listen mode temporarily to the stereo mode

Press the **Stereo** key to switch the current listen mode temporarily to the Stereo mode. Pressing the key again restores the original listen mode.

- The original listen mode is also restored when the input selector is switched or the receiver is turned OFF then ON again.

Convenient functions

You can make further adjustments to the sound while listening to playback in the surround mode.

- The mode using **Sound** key is defeated when the REC MODE is ON. - [33]

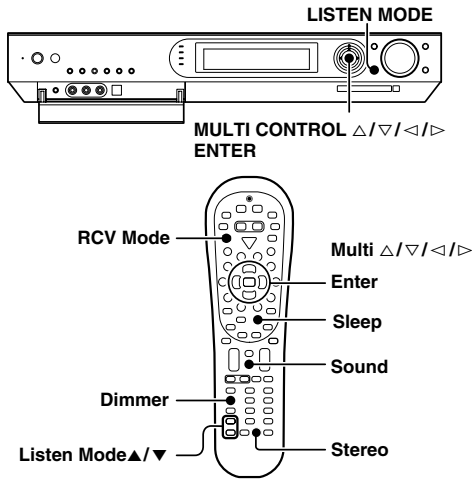

Adjusting the sound

- 1 Press the RCV Mode key on the remote control unit to set it to the receiver control mode.
- 2 Press the Sound key.
- 3 Press the MULTI CONTROL </> (or the Multi </> key) to select the setting item and press the ENTER (or the Enter key).

Note that some items are not displayed in certain modes.

- ① **"SPEAKER LEVEL":** *1
Adjusting the volume level of each channel
- ② **"ANALOG INPUT LEVEL":** (Analog mode only) - [32]
Input level adjustment
- ③ **"TONE CONTROL":** *2 - [31]
Tone level adjustment
- ④ **"EFFECT LEVEL":** (DSP mode only)
DSP effect level adjustment
- ⑤ **"DUAL MONO":** *3 - [44]
Selection between Stereo, Main audio, Sub audio and Main + Sub audio
- ⑥ **"MIDNIGHT MODE":** *4 - [45]
Midnight mode adjustment
- ⑦ **"PANORAMA":** *5 - [44]
Panorama mode ON/OFF
- ⑧ **"DIMENSION":** *5 - [44]
Dimension adjustment
- ⑨ **"CENTER WIDTH":** *5 - [44]
Center width adjustment
- ⑩ **"CENTER IMAGE":** *6 - [45]
Center image mode adjustment

- *1 The setting in the SOUND mode is temporary. It returns automatically to the original level set in "Speaker settings" when the receiver is turned OFF/ON.
- *2 PCM stereo and analog stereo mode only.
- *3 DOLBY DIGITAL mode only
- *4 DOLBY DIGITAL, DTS mode only
- *5 Only when the input signal is a 2-channel signal in the DOLBY PRO LOGIC IIx MUSIC or DOLBY PRO LOGIC II MUSIC mode.
- *6 Only when the input signal is a 2-channel signal in the DTS NEO:6 MUSIC mode.

- 4 Use the MULTI CONTROL Δ / ∇ (or the Multi Δ / ∇) to adjust the setting as desired.
 - The adjustment mode is displayed for approximately 20 seconds.
- 5 Press the Sound key again to return to the input indication.

Adjusting the volume level of each channel

The volume levels of the center speaker, subwoofer, surround speaker and surround back speaker channels can be adjusted during playback.

- 1 Press the RCV Mode key on the remote control unit to set it to the receiver control mode.
- 2 Press the Sound key.
- 3 Use the MULTI CONTROL </> (or the Multi </> keys) to select "SPEAKER LEVEL" on setup displays, and press the ENTER (or Enter key).
- 4 Use the MULTI CONTROL </> (or the Multi </> keys) to select the speaker.
 - ① Subwoofer level adjustment
 - ② Center speaker level adjustment
 - ③ Surround speaker level adjustment
 - ④ Surround back speaker level adjustment
- 5 Use the MULTI CONTROL Δ / ∇ (or the Multi Δ / ∇ keys) to adjust the speaker volume level.

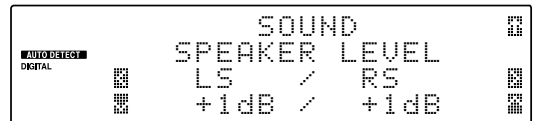

- The level of each speaker channel can be adjusted in 1 dB steps between -10 dB and +10 dB.
- 6 Repeat steps 4 and 5 as required.
 - 7 Press the Sound key again to return to the input indication.
 - The setting in the SOUND mode is temporary. It returns automatically to the original level set in "Speaker settings" when the receiver is turned OFF/ON.

Adjusting the DSP effect level (DSP mode only)

The DSP effect level can be adjusted when the listen mode is a DSP surround mode "Arena", "Jazz Club", "Theater", "Stadium" or "Disco".

- 1 Press the RCV Mode key on the remote control unit to set it to the receiver control mode.
- 2 Press the Sound key.
- 3 Use the MULTI CONTROL </> (or the Multi </> keys) to select "EFFECT LEVEL" on setup displays, and press the ENTER (or Enter key).
- 4 Use the MULTI CONTROL Δ / ∇ (or the Multi Δ / ∇) to adjust the EFFECT LEVEL.

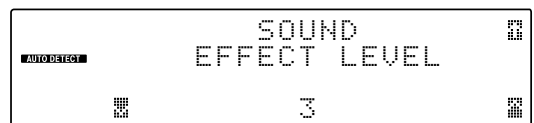

- The DSP effect level can be adjusted in the range between 1 and 5.
- 5 Press the Sound key again to return to the input indication.

Switching between main audio and sub audio

(DOLBY DIGITAL mode only)

When listening to audio multiplex broadcasting such as two-language satellite digital broadcasting, the main and sub audio can be switched over.

- ➊ Press the RCV Mode key on the remote control unit to set it to the receiver control mode.
- ➋ Press the Sound key while the DUAL MONO indicator ([]) is lit.
- ➌ Use the MULTI CONTROL </> (or the Multi </> keys) to select "DUAL MONO" on setup displays, and press the ENTER (or the Enter key).
- ➍ Use the MULTI CONTROL Δ / ▽ (or the Multi Δ / ▽ keys) to select the audio.

- ➎ ① "MAIN": The main audio is output.
- ➎ ② "SUB": The sub audio is output.
- ➎ ③ "MAIN + SUB": The mixture of main audio and sub audio is output.
- ➎ ④ "STEREO": The left channel outputs the main audio and the right channel outputs the sub audio.

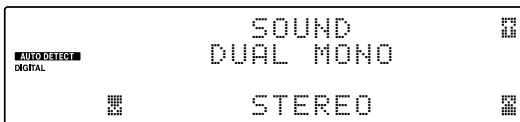

- ➏ Press the Sound key again to return to the input indication.
 - If the audio multiplex broadcasting is not monaural, the audio cannot be switched on this receiver. In this case, use the audio switching function on the tuner.

Panorama mode

(Only when the input signal is a 2-channel signal in the DOLBY PRO LOGIC IIx MUSIC or DOLBY PRO LOGIC II MUSIC mode)

When listening to music, you will be able to enjoy the "wraparound" sound effect when you adjust the panorama mode.

- ➊ Press the RCV Mode key on the remote control unit to set it to the receiver control mode.
- ➋ Press the Sound key.
- ➌ Use the MULTI CONTROL </> (or the Multi </> keys) to select "PANORAMA" on setup displays, and press the ENTER (or the Enter key).
- ➍ Use the MULTI CONTROL Δ / ▽ (or the Multi Δ / ▽) to select "ON" or "OFF".

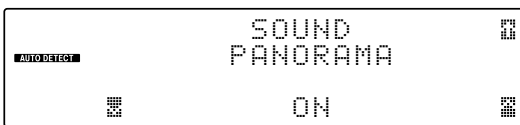

- ➏ Press the Sound key again to return to the input indication.

Dimension mode

(Only when the input signal is a 2-channel signal in the DOLBY PRO LOGIC IIx MUSIC or DOLBY PRO LOGIC II MUSIC mode)

When listening to music with certain recordings, you will also be able to achieve a suitable balance from all the speakers by adjusting the dimension mode.

- ➊ Press the RCV Mode key on the remote control unit to set it to the receiver control mode.
- ➋ Press the Sound key.
- ➌ Use the MULTI CONTROL </> (or the Multi </> keys) to select "DIMENSION" on setup displays, and press the ENTER (or the Enter key).

- ➍ Use the MULTI CONTROL Δ / ▽ (or the Multi Δ / ▽) to adjust the soundfield towards the rear or the front. Soundfield is adjusted towards the front.

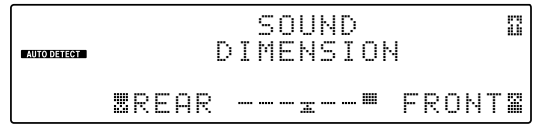

Standard setting.



Soundfield is adjusted towards the rear.

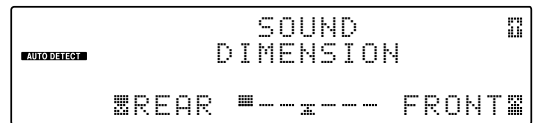

- ➏ Press the Sound key again to return to the input indication.

Center Width mode

(Only when the input signal is a 2-channel signal in the DOLBY PRO LOGIC IIx MUSIC or DOLBY PRO LOGIC II MUSIC mode)

Center width adjustment allows you to enjoy an enhanced sound when listening to music through center image from only center speaker, or left and right speakers or various combinations adjustments.

- ➊ Press the RCV Mode key on the remote control unit to set it to the receiver control mode.
- ➋ Press the Sound key.
- ➌ Use the MULTI CONTROL </> (or the Multi </> keys) to select "CENTER WIDTH" on setup displays, and press the ENTER (or the Enter key).
 - When the center speaker is switched OFF, this mode will not be effective.
- ➍ Use the MULTI CONTROL Δ / ▽ (or the Multi Δ / ▽) to adjust the left-center-right output.

Center image will be heard from center speaker only.

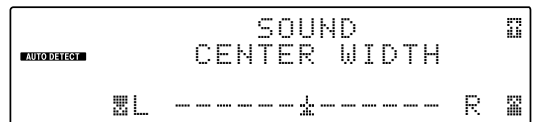

Center image will be heard from left and right speakers only.

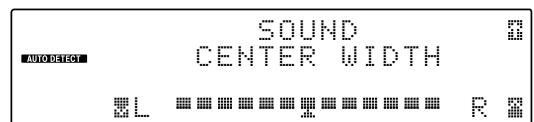

- When in other position, center image from center speaker, left and right speakers can be heard simultaneously with various combinations.

- ➏ Press the Sound key again to return to the input indication.

Center Image mode (Only when the input signal is a 2-channel signal in the DTS NEO:6 MUSIC mode.)

In the CENTER IMAGE setting mode of the NEO:6 MUSIC listen mode, it is possible to enhance the center channel audio by adjusting the center signal component.

- ➊ Press the RCV Mode key on the remote control unit to set it to the receiver control mode.
- ➋ Press the Sound key.
- ➌ Use the MULTI CONTROL </> (or the Multi </> keys) to select "CENTER IMAGE" on setup displays, and press the ENTER (or the Enter key).
 - When the center speaker is switched OFF, this mode will not be effective.
- ➍ Use the MULTI CONTROL Δ / ▽ (or the Multi Δ / ▽) to adjust the left-center-right output.



- Adjust the center component level.

- ➎ Press the Sound key again to return to the input indication.

Midnight mode (DOLBY DIGITAL and DTS mode only)

When watching movies at night, you might not be able to raise the volume as loud as normal. Midnight mode compresses the dynamic range of previously specified parts of the DOLBY DIGITAL or DTS sound track (like scenes with sudden increases in volume) to minimize the difference in volume between the specified and non-specified parts. This makes it easy to hear all of the sound track, even when listening at low volumes.

- ➊ Press the RCV Mode key on the remote control unit to set it to the receiver control mode.
- ➋ Press the Sound key.
- ➌ Use the MULTI CONTROL </> (or the Multi </> keys) to select "MIDNIGHT MODE" on setup displays, and press the ENTER (or the Enter key).
 - This can be selected only if DVD, VIDEO 1, VIDEO 2, AUX or GAME is selected as the source and the listen mode is set to "DOLBY DIGITAL" or "DTS".
- ➍ Use the MULTI CONTROL Δ / ▽ (or the Multi Δ / ▽) to select the "2", "1" or "OFF" setting.

- ➊ "2": Large effect
Suitable for late-night use.

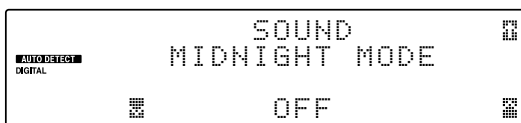
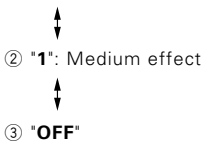

- The adjustment item is displayed for approximately 20 seconds.
- Some DOLBY DIGITAL or DTS software may not be compatible with the Midnight mode.

- ➎ Press the Sound key again to return to the input indication.

Display dimmer adjustment

The dimmer function lets you select the brightness of the receiver's display. You might find this useful if you darken your room to watch movies or listen to music.

Each time you press the Dimmer key, the display's brightness changes among the three available settings. Select the brightness level you find most pleasing.

- ➊ Bright
- ➋ Dark
- ➌ Dark (Indicators on the receiver are also OFF.)

Sleep timer

The sleep timer function turns the receiver OFF (to the standby mode) automatically when the set timer period has elapsed. The sleep timer period can be set in 10-minute steps up to 90 minutes.

Press the Sleep key repeatedly until the desired period before turning the receiver OFF (standby mode) is displayed.

- Each press increments the sleep timer period by 10 minutes.

10 → 20 → 3070 → 80 → 90 → Cancel → 10 → 20 → ...

The sleep timer indicator lights up

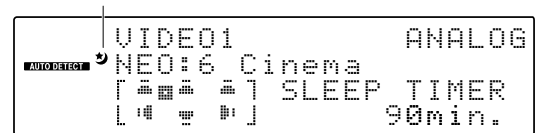

- Pressing the **Sleep** key after the sleep timer has started allows you to check the remaining time period.
- To cancel the sleep timer, turn the receiver OFF (standby mode) or press the Sleep key repeatedly until the **Sleep** timer indicator disappears.

Installing KENWOOD PC SERVER

By installing the application KENWOOD PC SERVER in a PC, the data stored in the PC can be imported in the libraries for listening to or viewing music, movie and photographic data in the PC on the libraries.

It is first necessary to connect the PC to this unit and set it up. - 10 - 26

Minimum requirements

Operating system (OS): Windows XP Professional SP1, Windows XP Home Edition SP1, Windows 2000 Professional SP4 or after.

Be sure to install the Service Pack for each OS.

PC: IBM PC/AT compatible model that supports one of the above-listed OSs officially.

CPU: Intel Pentium III, 800 MHz or higher.

Memory: 128 MB or more.

Hard disc space: 160 MB or more.

Ethernet interface: 100Base-TX recommended.

Number of VRS-N8100 units connectable to network: 3 units.

- The operation is not guaranteed for all of the environments matching the above requirements.
- Playback may be intermittent when 10Base-T is used as the Ethernet interface or IEEE802.11b is used for the wireless Ethernet bridge.

Before using the software, it should be installed in the PC with the following procedure.

- Exit from all software that is currently running.
- Check the operating environment of the PC.
- The driver software will be installed automatically when the software is launched for the first time after its installation.

For the installation, log on using the user name with the Administrator authority.

1 Place the "KENWOOD PC SERVER Installation CD-ROM" in the CD-ROM compatible drive connected to the PC.

The installer is launched automatically and the [Installer Language] screen is displayed. After selecting the language, the installation wizard is displayed.



- If the installer is not launched automatically, double-click on the [My Computer] icon on the desktop and then double-click on the CD-ROM drive in which the "KENWOOD PC SERVER Installation CD-ROM" is placed. The installer may also be launched by double-clicking on execution filename "SETUP.EXE".

2 Continue the installation procedure by following the instructions displayed on the wizard.

The wizard display changes in the following sequence:

[License Agreement] screen

[Choose Components] screen

[Choose install Location] screen

- The installation destination folder is set to [Program Files]. If you want to change this default, select [Browse] and specify the desired destination.

[Java2 Runtime Installer] screen

[KENWOOD PC SERVER Installer] screen

[Completing the KENWOOD PC SERVER Setup Wizard] screen

3 Reboot the PC.

- The following modules are added when the "KENWOOD PC SERVER" software is installed:
 - Microsoft® Data Access Components 2.5
©1981-1997 Microsoft Corporation.
All rights reserved.
 - Microsoft® DirectX® Media Runtime
©1998 Microsoft Corporation.
All rights reserved.
 - Java™
© Sun microsystems Corporation.
All rights reserved.
- The above modules are not deleted even when the "KENWOOD PC SERVER" software is uninstalled.

Trademark Information

- Supreme is a trademark of KENWOOD Corporation.
- Microsoft and Windows are registered trademarks or trademarks in the USA and other countries of Microsoft Corporation.
- IBM and PC/AT are registered trademarks of International Business Machines Corporation.
- Pentium is a trademark or registered trademark of Intel Corporation.
- Java and all trademarks and logo marks related to Java are registered trademarks or trademarks in the USA and other countries of Sun Microsystems Inc.
- Memory Stick is a trademark of Sony Corporation.
- DivX, DivX Certified, and associated logos are trademarks of DivXNetworks, Inc. and are used under license.

Other system names and product names are also trademarks or registered trademarks of their respective developers. Note that the "TM" and "®" markings are omitted in the text of this manual.

KENWOOD PC SERVER application

- It is prohibited to duplicate, modify, add or otherwise alter a part or the whole of this software.
- KENWOOD will not accept any liabilities for damages incurred by the user or a third party due to the use of this software.
- The specifications of this software may be subject to change without notice.

Uninstalling KENWOOD PC SERVER

When the software is no longer necessary, the software program can be removed by executing uninstallation. Be sure to exit from the software before proceeding to its uninstallation.

For the uninstallation, log on using the user name with the Administrator authority.

1 Select [Start] → [Control Panel] → [Add or Remove Programs].

2 In the [Change or Remove Programs] dialog box, select [KENWOOD PC SERVER] and click on the [Change/Remove] button.

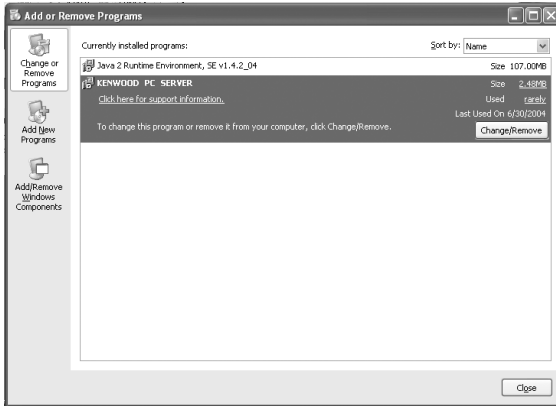

• The software can also be uninstalled by selecting [Program] → [KENWOOD PC SERVER] and then clicking on [Uninstall].

3 Execute the uninstallation procedure by following the instructions displayed.

- Even after the “KENWOOD PC SERVER” software has been uninstalled, the data edited with the software remains in the KENWOOD folder set as the data save destination folder of the software.
If you want to remove the software completely from the PC, delete the “KENWOOD” folder after uninstallation.

To change the software

Uninstall the existing software, reboot the PC and install the new software.
If the new software is installed immediately uninstalling the previous software, the operation of the new software will be abnormal.

Updating KENWOOD PC SERVER

The latest information and procedure to update your KENWOOD PC SERVER can be found in the "Technical Support" / "Service" section on the website of your resident country (if necessary you can find a link to your local website on www.kenwood.com <<http://www.kenwood.com>>).

- How to check the current version of KENWOOD PC SERVER ;
Lanch the KENWOOD PC SERVER, select [Help] → [Version Infomatioin]
- 1 **Uninstall the current KENWOOD PC SERVER and Java 2 Runtime, then reboot the PC.**
- 2 **Download the latest version of KENWOOD PC SERVER and Java 2 Runtime.**
- 3 **Install the new version of KENWOOD PC SERVER and Java 2 Runtime.** — 46

Operating KENWOOD PC SERVER

Double-click on shortcut icon  on the desktop to launch the KENWOOD PC SERVER.

Do not attempt to launch KENWOOD PC SERVER more than once.

Names and functions of window components

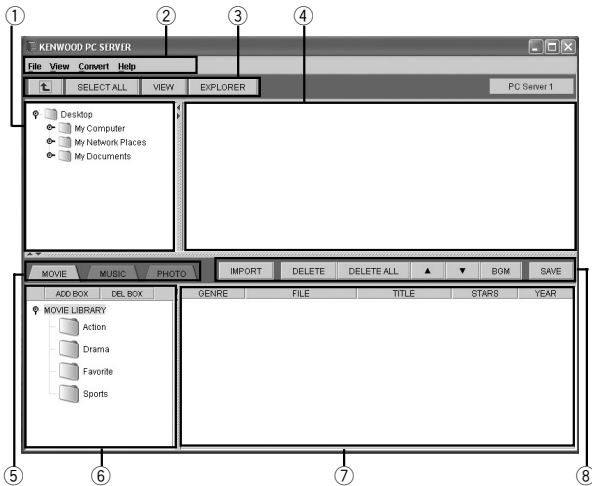

- ① **Folder window:**
Displays the contents of the PC's hard disk drive in the directory tree format.
- ② **Menu bar:**
- ③ **[SELECT ALL] button:**
Click on this button to move to the level directly above the level displayed in the list window.
[VIEW] button:
Click on this button to switch the display format the list window.
[EXPLORER] button:
Click on this button to open the Windows Explorer window showing the list of folders that can be displayed in the list window. The display format of the Explorer window depends on the setup made for the OS.
- ④ **List window:**
Displays the contents of the folder selected in the folder window.
 - The list window is used to display the contents (folders and files that can be imported using this software).
- ⑤ **[MOVIE] tag:**
Selects the [MOVIE LIBRARY].
[MUSIC] tag:
Selects the [MUSIC LIBRARY].
[PHOTO] tag:
Selects the [PHOTO LIBRARY].
- ⑥ **Library box:**
Displays the genre boxes and album boxes in the selected library in the directory tree format.
- ⑦ **Library list window:**
Displays the contents already imported in the selected library.
- ⑧ **[IMPORT] button:**
Click on this button to import the contents selected in the list window into the library.
[DELETE] button:
Click on this button to delete the files selected in the library list window.
[DELETE ALL] button:
Click on this button to clear all of the contents displayed in the library list window.
[▲] [▼] buttons:
Click on either button to move a file to change the order of playback of files. (Used only when the [MUSIC LIBRARY] or [PHOTO LIBRARY] is selected.)

[BGM] button:

Click on this button to link music with playback of a photo image. (Used only when the [PHOTO LIBRARY] is selected.)

[SAVE] button:

Click on this button to save the library list window data and let this unit recognize the contents of the corresponding library.

IMPORTANT: Before closing the KENWOOD PC SERVER software, be sure to save the changes you made otherwise they will be lost.

Operations using the menu bar

When one of the menu names is selected, a pull-down menu is displayed as described below.

When [File] is selected:

① [Name Setting]

The default server name is [PC Server 1]. The server name can be changed as desired.

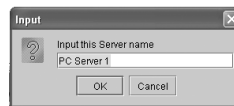

② [Movie Folder Setting]

[Music Folder Setting]

[Photo Folder Setting]

Specify the pathnames of the desired folders (up to three folders can be set per library). The files stored in the specified folders will be imported as "Temporary" files.

If you specify the folder for saving the recorded TV programs or that used usually as a library, its contents can be imported automatically into the server.

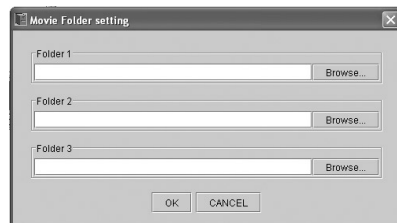

[Browse...]: Click on the [Browse] button to select the desired folder by following the directory.

After completing the folder setting, click on the [OK] button.

When MOVIE files are imported as "Temporary":

Only the contents in the highest layer below the specified folders are imported as "Temporary". (The files located immediately after the imported folders can be played back.)

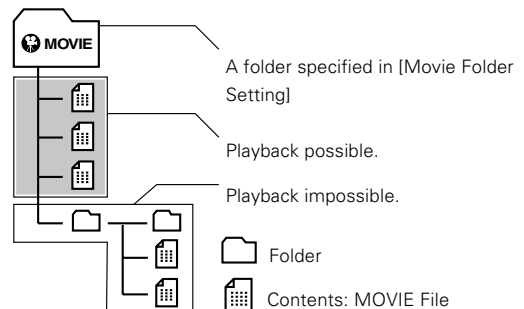

Continued to next page

When MUSIC files or PHOTO files are imported as "Temporary":

Only the files stored in the folders in the highest layer below the specified folders are imported. (The files located in folders below the folders in the highest layer cannot be played back.)

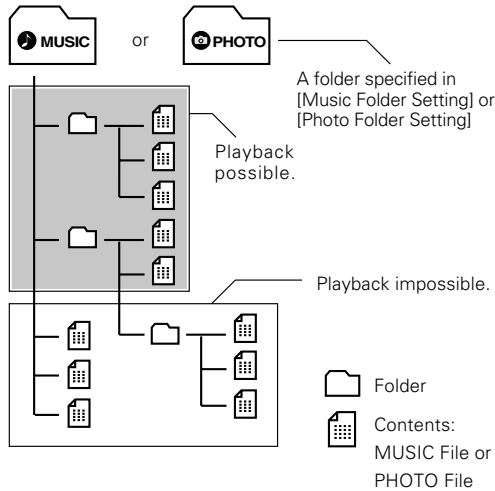

- When importing PHOTO files, open the menu bar, select [File] → [Save] and select [OK]. (The same operation is also possible by clicking on the [SAVE] button.)

- [Save]**
Saves the edited contents.
- [Exit]**
Exits from the software.

When [View] is selected:

- [Large Icons]**
- [Small Icons]**
- [List]**
- [Details]**
- [Renewal tree]**

When [Convert] is selected:

It is required to set the file copy operation for importing still image contents in the [PHOTO LIBRARY].

- [High Quality]:**
Setting for viewing high-resolution image.
- [Normal]:**
Standard setting.
- [Fast]:**
Setting for converting image into low-resolution image. This setting shortens the time required for import.

Import of contents

The contents of the PC can be imported in each library. To select a library, click on the [MOVIE], [MUSIC] or [PHOTO] tag.

For the data types that can be imported, see "Playable files with this unit". - 4

Importing contents in the [MOVIE LIBRARY]

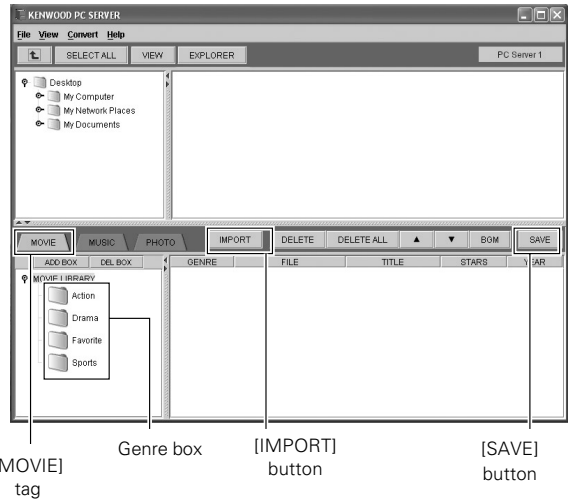

1 Select the genre box for the contents to be imported.

The library box displays the genre boxes for the [MOVIE LIBRARY], such as the [Action], [Drama], [Favorite] and [Sports] boxes.

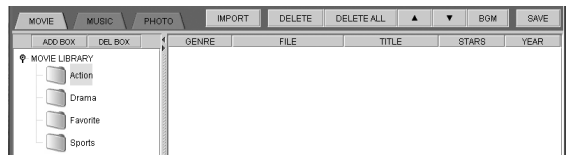

- Contents cannot be imported unless a genre box is selected.

2 Select the movie contents to be imported in the folder window so that they are displayed in the list window.

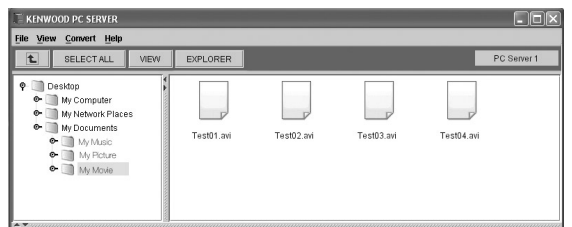

3 Drag & drop each content from the list window into the library list window.

- The same operation is also possible selecting a content and then clicking on the [IMPORT] button.
- When a genre box is selected in step 1 to display the folders storing the contents to be imported in the list window and then the required folder is dragged & dropped into the library list window, only the contents in the hierarchical directly below the folder will be imported.

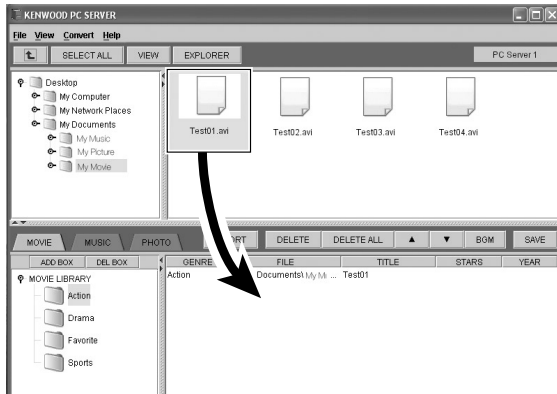

- It is also possible to select multiple contents and drag & drop them together.

4 In the menu bar, select [File] → [Save] and then click on [OK].

- The same operation is also possible by clicking on the [SAVE] button.

Editing the [MOVIE LIBRARY] box

How to add a genre box:

Select the [MOVIE LIBRARY] and click the mouse right button or select [ADD BOX].

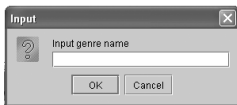

- Input the genre box name and click on the [OK] button to add the specified genre box.

How to delete a genre box:

Select the genre box to be deleted and click the mouse right button. When a pull-down menu is displayed, select [Delete Genre].

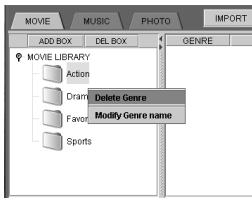

- A genre box can also be deleted by selecting the genre box name and then select [DEL BOX].

How to rename a genre box:

Select the genre box to be renamed and click the mouse right button. When a pull-down menu is displayed, select [Modify Genre name].

Editing the library list

How to delete a content:

Select the content to be deleted and click the mouse right button. When a pull-down menu is displayed, select [Delete Movie].

- A content can also be deleted by selecting the content name and then select [DELETE].

How to sort contents:

Click on an additional information tag in the library list window to sort the contents for the selected kind of information.

- This operation does not affect the list display on this unit.

How to add additional information:

The additional information for each content displayed in the library list window ("TITLE", "STARS" and "YEAR") can be edited.

- Some characters may be unable to be displayed in the library list on this unit.

Importing contents in the [MUSIC LIBRARY]

Click on the [MUSIC] tag to select the [MUSIC LIBRARY].

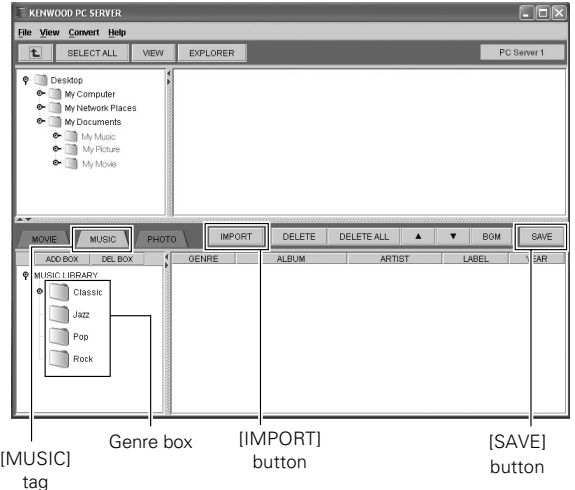

1 Select the genre box or album box for the contents to be imported.

The library box displays the genre boxes for the [MUSIC LIBRARY], such as [Classic], [Jazz], [Pop] and [Rock] boxes. Each genre box can have album boxes in the lower level.



- Contents cannot be imported unless a genre box or album box is selected.

2 Select the music contents to be imported in the folder window so that they are displayed in the list window.

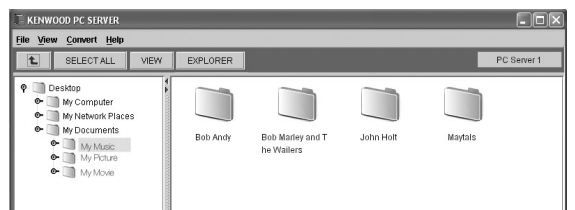

3 Drag & drop each content from the list window into the library list window.

- The same operation is also possible selecting a content and then clicking on the [IMPORT] button.

Continued to next page

Operation of import by selecting a folder:

When a genre box is selected in the library box (field on the bottom left), a new album box is created and the contents in the folder selected in the library list window (field on the top right) are imported in the album box. (At this time, the album box is given the same name as the folder.)

When an album box is selected in the library box (field on the bottom left), the contents in the folder selected in the library list window (field on the top right) are imported in the album box.

Operation of import by selecting files:

When a genre box is selected in the library box (field on the bottom left), a new album box is created and the content(s) selected in the library list window (field on the top right) are imported in the album box. (At this time, the album box is given the same name as the folder.)

When an album box is selected in the library box (field on the bottom left), the content(s) selected in the library list window (field on the top right) are imported in the album box. (One or multiple contents can be selected and imported.)

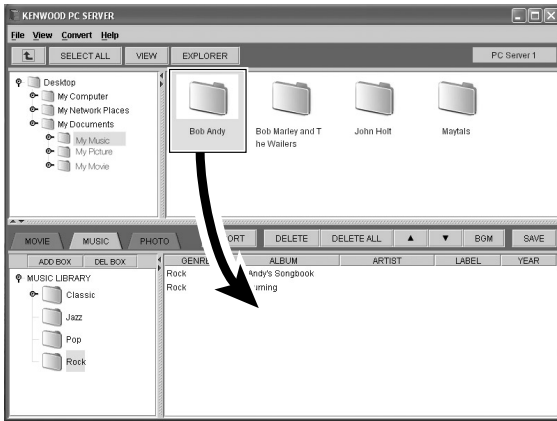

4 In the menu bar, select [File] → [Save] and then click on [OK].

- The same operation is also possible by clicking on the [SAVE] button.

Editing the [MUSIC LIBRARY] box

How to add a genre box:

Select the [MUSIC LIBRARY] and click the mouse right button or select [ADD BOX].



- Input the genre box name and click on the [OK] button to add the specified genre box.

How to delete a genre box:

Select the genre box to be deleted and click the mouse right button. When a pull-down menu is displayed, select [Delete Genre].

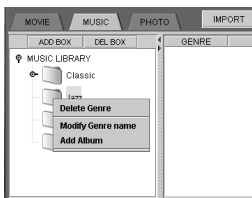

- A genre box can also be deleted by selecting the genre box name and then select [DEL BOX].

How to rename a genre box:

Select the genre box to be renamed and click the mouse right button. When a pull-down menu is displayed, select [Modify Genre name].

How to add an album box:

Select the genre box to which you want to add an album box and click the mouse right button. When a pull-down menu is displayed, select [Add Album].

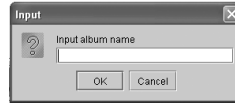

- Input the album box name and click on the [OK] button to add the specified album box.

How to rename an album box:

Select the album box to be renamed and click the mouse right button. When a pull-down menu is displayed, select [Modify Album name].

How to delete an album box:

Select the album box to be deleted and click the mouse right button. When a pull-down menu is displayed, select [Delete Album].

- An album box can also be deleted by selecting the album box name and then select [DEL BOX].

Editing the library list

How to delete a content:

Select the content to be deleted and click the mouse right button. When a pull-down menu is displayed, select [Delete Music].

- A content can also be deleted by selecting the content name and then select [DELETE].

How to sort contents:

Click on an additional information tag in the library list window to sort the contents for the selected kind of information.

- This operation does not affect the list displayed on this unit.

How to change the order of playback:

Select a content in the library list window and click on the [▲] or [▼] button to move its position up or down.

How to add additional information:

The additional information for each album displayed in the library list window ("ALBUM", "ARTIST", "LABEL", "YEAR" and "TITLE") can be edited.

- Some characters may be unable to be displayed in the library list on this unit.

Deleting a music content linked as "BGM" causes the background music link setting to be canceled.

Importing contents in the [PHOTO LIBRARY]

Click on the [PHOTO] tag to select the [PHOTO LIBRARY].

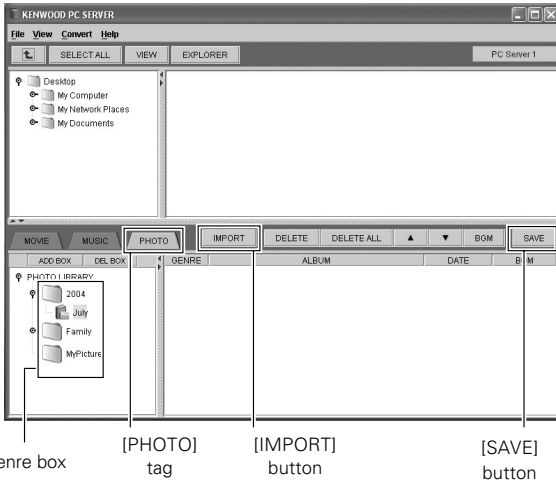

When an album box is selected in the library box (field on the bottom left), the content(s) selected in the library list window (field on the top right) are imported in the album box. (One or multiple contents can be selected and imported.)

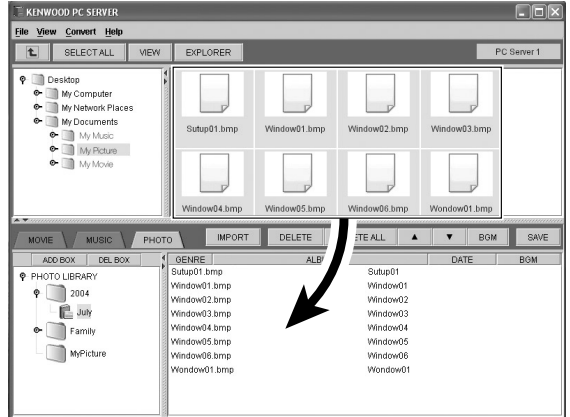

1 Select the genre box or album box for the contents to be imported.

The library box displays the genre boxes for the [PHOTO LIBRARY], such as [2004], [Family] and [MyPicture] boxes. Each genre box can have album boxes in the lower level.

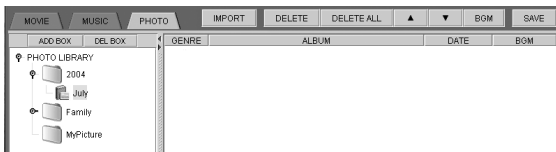

- Contents cannot be imported unless a genre box or album box is selected.

2 Select the photo contents to be imported in the folder window so that they are displayed in the list window.

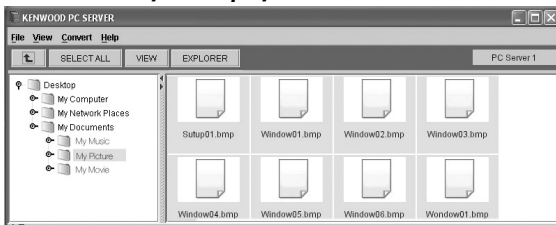

3 Drag & drop each content from the list window into the library list window.

- The same operation is also possible selecting a content and then clicking on the [IMPORT] button.

Operation of import by selecting a folder:

When a genre box is selected in the library box (field on the bottom left), a new album box is created and the contents in the folder selected in the library list window (field on the top right) are imported in the album box. (At this time, the album box is given the same name as the folder.)

When an album box is selected in the library box (field on the bottom left), the contents in the folder selected in the library list window (field on the top right) are imported in the album box.

Operation of import by selecting files:

When a genre box is selected in the library box (field on the bottom left), a new album box is created and the content(s) selected in the library list window (field on the top right) are imported in the album box. (At this time, the album box is given the same name as the folder.)

- When still-image data is imported as a content, a new file is created automatically by converting the size of the original file.

The user is therefore recommended to take care about the remaining capacity in the hard disk drive. It should also be noted that the processing may take time depending on the PC performance.

- When photographic image data in a format other than JPEG is imported, its copy file is converted into the JPEG format and resized.

4 In the menu bar, select [File] → [Save] and then click on [OK].

- The same operation is also possible by clicking on the [SAVE] button.

Editing the [PHOTO LIBRARY] box

How to add a genre box:

Select the [PHOTO LIBRARY] and click the mouse right button or select [ADD BOX].

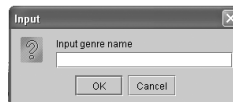

- Input the genre box name and click on the [OK] button to add the specified genre box.

How to delete a genre box:

Select the genre box to be deleted and click the mouse right button. When a pull-down menu is displayed, select [Delete Genre].

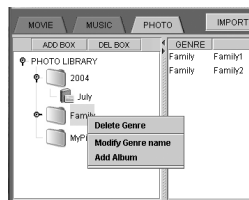

- A genre box can also be deleted by selecting the genre box name and then select [DEL BOX].

How to rename a genre box:

Select the genre box to be renamed and click the mouse right button. When a pull-down menu is displayed, select [Modify Genre name].

Continued to next page

How to add an album box:

Select the genre box to which you want to add an album box click the mouse right button. When a pull-down menu is displayed, select [Add Album].



- Input the album box name and click on the [OK] button to add the specified album box.

How to rename a album box:

Select the album box to be renamed and click the mouse right button. When a pull-down menu is displayed, select [Modify Album name].

How to delete an album box:

Select the album box to be deleted and click the mouse right button. When a pull-down menu is displayed, select [Delete Album].

- An album box can also be deleted by selecting the album box name and then select [DEL BOX].

Editing the library list

How to delete a content:

Select the content to be deleted and click the mouse right button. When a pull-down menu is displayed, select [Delete Photo].

- A content can also be deleted by selecting the content name and then select [DELETE].

How to sort contents:

Click on an additional information tag in the library list window to sort the contents for the selected kind of information.

- This operation does not affect the list display on this unit.

How to change the order of playback:

Select a content in the library list window and click on the [▲] or [▼] button to move its position up or down.

How to add additional information:

The additional information for each content displayed in the library list window ("ALBUM", "DATE", "BGM" and "TITLE") can be edited.

- Some characters may be unable to be displayed in the library list on this unit.

Linking BGM (BackGround Music) for SLIDE SHOW

Contents in the [MUSIC LIBRARY] can be linked to the contents in the [PHOTO LIBRARY].

When the photo images are played in slide show on this unit, the linked music files are played with the photo images as their background music.

- The photo image files and music files to be linked should be imported in their libraries in advance. The background music links a music content to an album box in the [PHOTO LIBRARY].

- 1 Click on the [PHOTO] tag to select the [PHOTO LIBRARY].
- 2 In the library list window, select the album to be linked as the background music source.

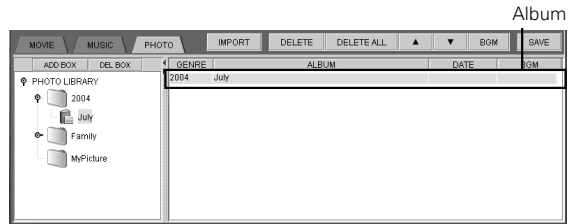

- No background music can be linked when no album is selected in the [PHOTO LIBRARY].

- 3 Click on the [BGM] button.

The [Background Music setting] dialog is displayed.

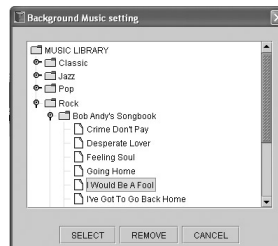

- Displays the contents imported in the [MUSIC LIBRARY].
- 4 Select the music contents to be linked as the background music for the album.
 - The music contents linked as background music are played repeatedly until the end of the slide show.
 - 5 In the menu bar, select [File] → [Save] and then click on [OK].
 - The same operation is also possible by clicking on the [SAVE] button.

Playback of Network Server

When the KENWOOD PC SERVER software is installed in the PC, libraries can be constructed by grouping contents and their contents can be played back. The contents should be edited and/or deleted before connection to the PC server.

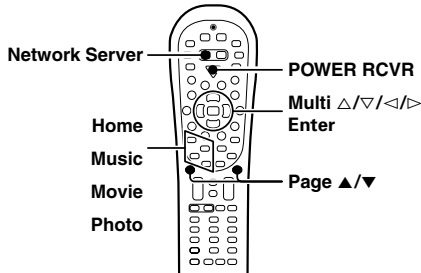
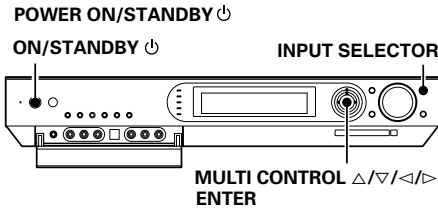

If there is no server that can be logged in, the following warning message is displayed.

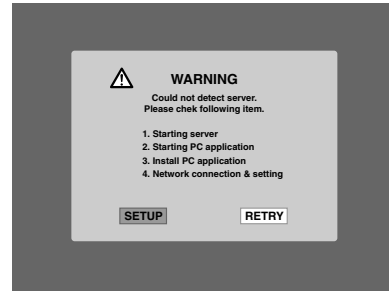

Use the MULTI CONTROL ◀/▶ (or the Multi ◀/▶ keys) to select "SETUP" or "RETRY", and press the ENTER (or the Enter key).

- ① "SETUP": The setup display appears to allow correction of inappropriate settings.
- ② "RETRY": The server detection is retried.

2 Select a library in the home display.

The home menu is displayed when a PC server is logged in. Now the contents imported using the KENWOOD PC SERVER can be played back on this unit.

Use the MULTI CONTROL ▲/▼/◀/▶ (or the Multi ▲/▼/◀/▶ keys) to select "MOVIE", "MUSIC" or "PHOTO", and press the ENTER (or the Enter key).

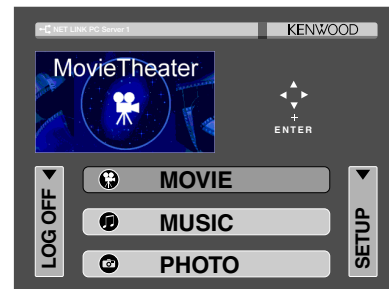

Operation icons in the home display:

- ① "MOVIE": Select to display the "MOVIE LIBRARY" display. (The same operation is also available by pressing the **Movie** key)
- ② "MUSIC": Select to display the "MUSIC LIBRARY" display. (The same operation is also available by pressing the **Music** key)
- ③ "PHOTO": Select to display the "PHOTO LIBRARY" display. (The same operation is also available by pressing the **Photo** key)
- ④ "SETUP": Select to display the setup display. (The same operation is also available by pressing the **Setup** key)
- ⑤ "LOG OFF": Select to log off from the server and return to the server selection display.

Preparation

- ① Turn on the power to this receiver by pressing the POWER ON/STANDBY ⏻ (For U.S.A. and Canada) or the ON/STANDBY ⏻ (For Europe and Australia) key (or the POWER RCVR key on the remote).
- ② Double-click on shortcut icon on the desktop to launch the KENWOOD PC SERVER.

1 Log into the PC server and its libraries.

- ① Use the INPUT SELECTOR key (or the Network Server key) to select "NET SERVER".

When the "NET SERVER" input is selected, the OSD function on the TV screen is activated and detection of the server starts.



- ② Use the MULTI CONTROL ▲/▼ (or Multi ▲/▼ keys) to select the PC server to be logged in, and press the ENTER (or the Enter key).

Up to sixteen PC servers can be logged in.

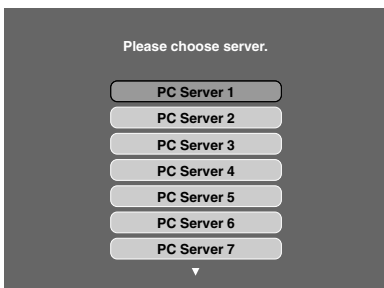

Certain time may be taken before the PC server is connected.

Continued to next page

3 Select the contents to be played in the library display.

The library display for the library selected in step 2 is displayed.

When the "MOVIE LIBRARY" has been selected :

1 Use the MULTI CONTROL $\Delta/\nabla/\triangleleft/\triangleright$ (or the Multi $\Delta/\nabla/\triangleleft/\triangleright$ keys) to select the genre icon.

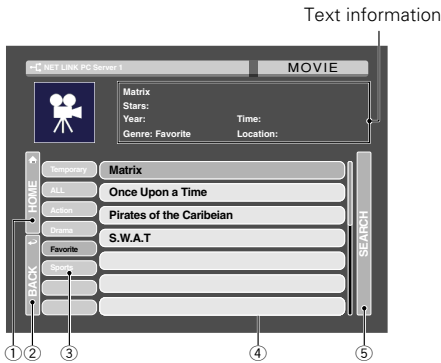

Operation icons in the library display:

- 1 **"HOME" icon:** Select to display the home display. (The same operation is also available by pressing the **Home** key)
 - 2 **"BACK" icon:** When the **Return** key is pressed to return to the library display in the middle of playback of content, the playback pauses temporarily. It can be resumed when the **"BACK"** icon is selected.
 - 3 **Genre icons: ***
The genre icons are displayed.
 - 4 **Content icons: ***
When a genre icon is selected, the contents belonging to the genre are displayed.
 - 5 **"SEARCH" icon:**
Select to display the library content search display. - [57]
- * If the display consists of more than one page, press the **Page** \blacktriangledown key to view the next page. Pressing the **Page** \blacktriangle key returns to the previous page.

Text information

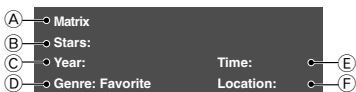

- A Title
- B Stars
- C Year
- D Genre
- E Not used with this unit.
- F Not used with this unit.

2 Use the MULTI CONTROL $\Delta/\nabla/\triangleleft/\triangleright$ (or the Multi $\Delta/\nabla/\triangleleft/\triangleright$ keys) to select the contents icon, and press the ENTER (or the Enter key).

- (The same operation is also available by selecting a contents icon and pressing the $\blacktriangleright/\parallel$ key.)
- Press the **Return** key to return to the previous display.

The playback display appears and the selected contents starts to be played back.

- When the input selector key is pressed during playback of a content, the playback pauses temporarily.

When the "MUSIC LIBRARY" has been selected :

1 Use the MULTI CONTROL $\Delta/\nabla/\triangleleft/\triangleright$ (or the Multi $\Delta/\nabla/\triangleleft/\triangleright$ keys) to select the genre icon.

Text information

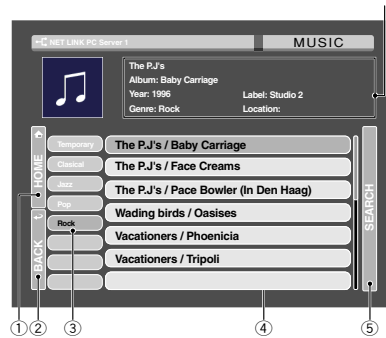

Operation icons in the library display:

- 1 **"HOME" icon:** Select to display the home display. (The same operation is also available by pressing the **Home** key)
 - 2 **"BACK" icon:** Select during pause of playback of a content to resume playback.
 - 3 **Genre icons: ***
The genre icons are displayed.
 - 4 **Content icons: ***
When a genre icon is selected, the albums belonging to the genre icon are displayed. When an album icon is selected and the **Enter** key is pressed, the contents belonging to the album are displayed.
 - 5 **"SEARCH" icon:**
Select to display the library content search display. - [57]
- * If the display consists of more than one page, press the **Page** \blacktriangledown key to view the next page. Pressing the **Page** \blacktriangle key returns to the previous page.

Text information

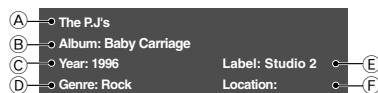

- A Artist
- B Album
- C Year
- D Genre
- E Label
- F Not used with this unit.

2 Use the MULTI CONTROL $\Delta/\nabla/\triangleleft/\triangleright$ (or the Multi $\Delta/\nabla/\triangleleft/\triangleright$ keys) to select the album icon, and press the ENTER (or the Enter key) .

- Press the **Return** key to return to the previous display.

Continued to next page

- ② Use the MULTI CONTROL $\Delta/\nabla/\triangleleft/\triangleright$ (or the Multi $\Delta/\nabla/\triangleleft/\triangleright$ keys) to select the contents icon, and press the ENTER (or the Enter key). (The same operation is also available by selecting a contents icon and pressing the \blacktriangleright /II key.)

- Press the Return key to return to the previous display.

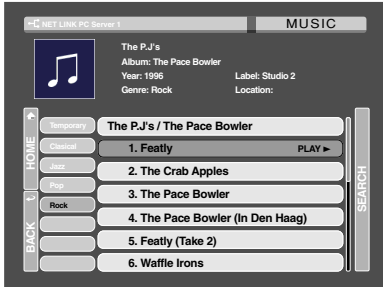

The selected content starts to be played.

- When the input selector key is pressed during playback of a content, the playback stops.

When the "PHOTO LIBRARY" has been selected :

- ① Use the MULTI CONTROL $\Delta/\nabla/\triangleleft/\triangleright$ (or the Multi $\Delta/\nabla/\triangleleft/\triangleright$ keys) to select the genre icon.

Text information

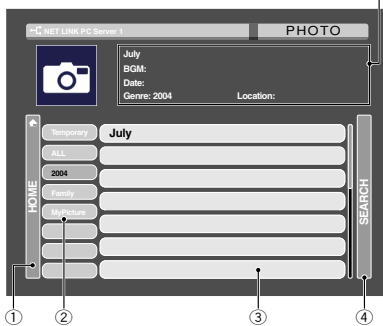

Operation icons in the library display:

- ① **"HOME" icon:** Select to display the home display. (The same operation is also available by pressing the Home key)
- ② **Genre icons: ***
The genre icons are displayed.
- ③ **Content icons: ***
When a genre icon is selected, the albums belonging to the genre icon are displayed. When an album icon is selected and the Enter key is pressed, the thumbnails of the photos belonging to the album are displayed.
- ④ **"SEARCH" icon:**
Select to display the library content search display.

* If the display consists of more than one page, press the Page \blacktriangledown key to view the next page. Pressing the Page \blacktriangle key returns to the previous page.

Text information



- A Album
- B BGM (BackGround Music)
- C Date
- D Genre
- E Not used with this unit.

- ② Use the MULTI CONTROL $\Delta/\nabla/\triangleleft/\triangleright$ (or the Multi $\Delta/\nabla/\triangleleft/\triangleright$ keys) to select the album icon, and press the ENTER (or the Enter key) .

- When the "SLIDE SHOW" icon is selected and ENTER (or the Enter key) is pressed, the slide show playback starts.
- Press the Return key to return to the previous display.

- ③ Use the MULTI CONTROL $\Delta/\nabla/\triangleleft/\triangleright$ (or the Multi $\Delta/\nabla/\triangleleft/\triangleright$ keys) to select the contents icon, and press the ENTER (or the Enter key). (The same operation is also available by selecting a contents icon and pressing the \blacktriangleright /II key.)

- Press the Return key to return to the previous display.



The playback display appears and the selected contents starts to be played back.

- When the input selector key is pressed during slideshow playback of contents, both the background music and slide show stop.
- The top and bottom ends, or the left and right ends of the photo may be cut off depending on the orientation of the photo file.

Operation keys of the playback display

The following operations are available on the playback display. (Some operations may be unavailable depending on the played content.)

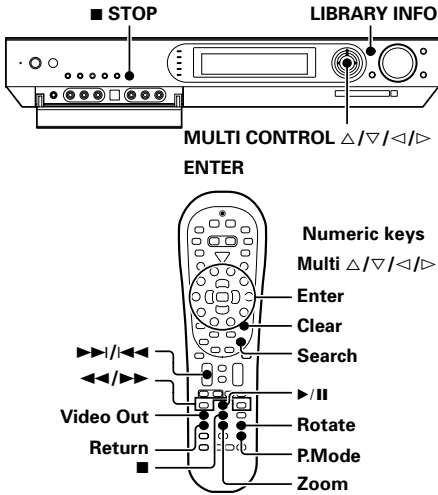

	Operation key with the "MOVIE LIBRARY" playback display
	Operation key with the "MUSIC LIBRARY" playback display
	Operation key with the "PHOTO LIBRARY" playback display

Start playback/ pause

Press the >/II key.
Each press alternates the pause and play modes.

Stopping playback

Press the ■ key.
Playback stops and the library display appears again.

Skipping a content

Press the >>I or I<<< key.

Returning to library display

Press the Return key.
Playback pauses temporarily and the library display appears again. Selecting the "BACK" icon during the pause resumes playback.

Fast forward/ Fast reverse

Press the <<< or >>> key.
Press the >/II key to resume normal playback.

Switching the playback modes

The playback modes can be switched on the playback display. However, some playback modes may be unavailable depending on the played content.

Press the P.MODE key during playback or pause.
Press the key for the following selects.

"When the "MOVIE LIBRARY" has been selected :

- ① "REPEAT TITLE": Title repeat mode
- ② "REPEAT GENRE": Genre repeat mode
- ③ "REPEAT CLEAR": Normal playback

When the "MUSIC LIBRARY" has been selected :

- ① "REPEAT TRACK": Track repeat mode
- ② "REPEAT ALBUM": Album repeat mode
- ③ "REPEAT GENRE": Genre repeat mode
- ④ "REPEAT CLEAR": Normal playback

Searching contents names

When the library display is shown, contents can be searched by entering a desired content name. ("MOVIE LIBRARY": Title, "MUSIC LIBRARY": Artist, "PHOTO LIBRARY": Album).

- ❶ Press the Search key or select the "SEARCH" icon to open the search display.
- ❷ Use the numeric keys to enter the first 3 characters of the file to be searched for.



- Up to three characters can be input.
- If you made a mistake, press the Clear key and input the correct character.

Characters that can be input with each numeric key

- 1 key: 1
- 2 key: A → B → C → a → b → c → 2 → A
- 3 key: D → E → F → d → e → f → 3 → D
- 4 key: G → H → I → g → h → i → 4 → G
- 5 key: J → K → L → j → k → l → 5 → J
- 6 key: M → N → O → m → n → o → 6 → M
- 7 key: P → Q → R → S → p → q → r → s → 7 → P
- 8 key: T → U → V → t → u → v → 8 → T
- 9 key: X → Y → Z → x → y → z → 9 → X
- 0 key: 0

- ❸ Use the MULTI CONTROL Δ/▽ (or the Multi Δ/▽ keys) to select "SEARCH" icon, and press ENTER (or the Enter key) .

- If there are no corresponding characters, the files with the names closest in alphabetic order are displayed in the column at the very top.

Switching the video outputs



If the video format used by the content does not match that used by the TV monitor, the output of the content may be abnormal. To obtain a normal video output, switch the video output of this unit.

During stop status, press the Video Out key to switch the video output signals as shown below.

	Video Format	Composite Output	S Video Output	Component output
①	NTSC	CVBS	Y/C	—
②	NTSC	CVBS	—	Y Cb Cr
③	PAL	CVBS	Y/C	—
④	PAL	CVBS	—	Y Cb Cr
⑤	480p (NTSC)	—	—	Y Cb Cr
⑥	576p (PAL)	—	—	Y Cb Cr
⑦	720p	—	—	Y Cb Cr
⑧	1080i	—	—	Y Cb Cr

- Note that the setting using the Video Out key is only temporary. To change the initial setting, change the "Video Out" setting in the "Main" settings on the Network Setup menu. -[27]

Zoom-up playback



Photo contents can be zoomed up when they are played.

Press the Zoom key during playback of a photo content to magnify the image.

Press the key for the following selects.

x 1.25 → x 1.5 → x 1.75 → x 2 → x 2.25 → x 2.5 → x 2.75 →
x 3 → x 3.25 → x 3.5 → x 3.75 → x 4 → x 1 → x 1.25 → ...

Rotated playback



Longitudinal photo images captured using a digital camera, etc. are displayed widthwise when they are played. In this case, the displayed image can be rotated.

Press the Rotate key during playback of a photo content to rotate the image by a certain angle.

Press the key for the following selects.

"ANGLE 2" (90° rotation) → "ANGLE 3" (180° rotation) →
"ANGLE 4" (270° rotation) → "ANGLE 1" → "ANGLE 2" ...

Displaying the library list



The library information list in each contents can be displayed on this unit.

- Press the LIBRARY INFO key to view the information of the content being selected.

Example: When the MOVIE LIBRARY is selected

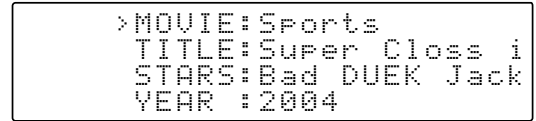

- Press the MULTI CONTROL Δ/∇ to move to the position of the information to be scrolled, and press the ENTER.

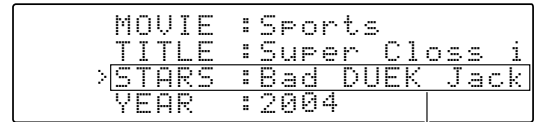

Scrolled

Pressing the LIBRARY INFO key again, the display is changed as below.

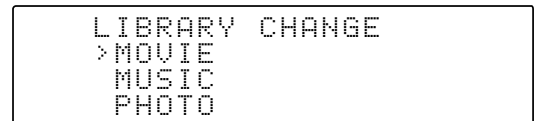

To move to the library display, press the MULTI CONTROL Δ/∇ to select "MOVIE", "MUSIC" or "PHOTO" and press the ENTER.

- To cancel, press the LIBRARY INFO key again.

Playback of Memory Card

Contents in a memory card, such as photo images captured using a digital camera, can be played back on this unit. (JPEG format only)

Layers which can be played back

Files in folders within the second layer can be played back.

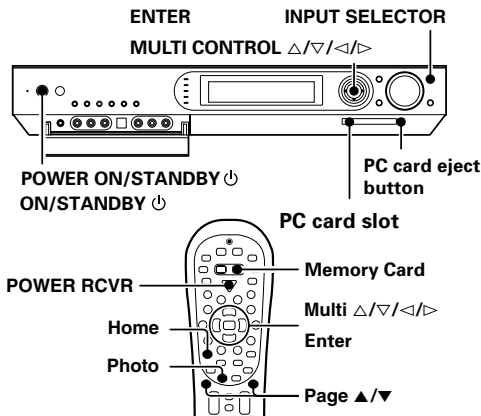
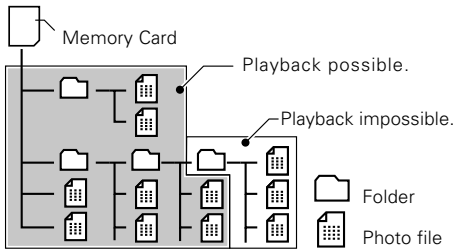

Preparation

- ① Turn OFF (STANDBY) the power to this receiver by pressing the POWER ON/STANDBY (For U.S.A. and Canada) or the ON/STANDBY (For Europe and Australia) key (or the POWER RCVR key on the remote).
 - Be sure to turn this unit off (to STANDBY) before inserting or removing the PC card.
 - To remove the PC card, press the PC card eject button and take out the card.
- ② Set a PC card on the PC card adapter, and insert the adapter into the PC card slot.

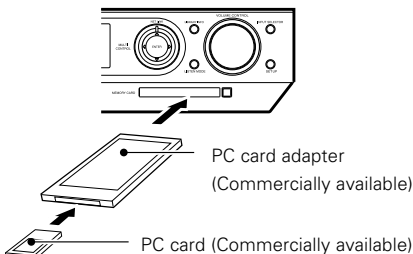

- ③ Turn on the power to this receiver by pressing the POWER ON/STANDBY (For U.S.A. and Canada) or the ON/STANDBY (For Europe and Australia) key (or the POWER RCVR key on the remote).

Types of memory cards with which operation has been confirmed

CompactFlash

- SanDisk SDCFB-32-801 (32 MB)
SDCFB-128-801 (128 MB)
- TDK TC064WA (64 MB)
- I-O DATA CFS-64MX (64 MB)
CFS-256MX (256 MB)

Memory Stick

- SanDisk SDMS-64 (64 MB)
SDMS-128-824 (128 MB)
- Sony MSA-64A (64MB)
MSA-128A (128MB)
- I-O DATA MSR-64 M/U (64 MB)

SDMemory Card

- Panasonic RP-SD064BL1A (64 MB)
- LEXAR SD-128-231 (128 MB)
- HAGIWARA SYS-COM HPC-SD128MY (128 MB)
- TDK TS128VS (128 MB)
- SanDisk SDSDB-256-801 (256 MB)

SmartMedia

- SanDisk SDSM-128-801 (128 MB)

Multi Media Card

- SanDisk SDMB-64-801 (64 MB)

Types of PC card adapters with which operation has been confirmed (PCMCIA PC card Type II)

CompactFlash adapter:

- SanDisk SDCF-03A
- I-O DATA PCCF-ADP

4 in 1 adapter:

- SanDisk SDDR-65
- Sitecom PC-200

- Playback is not guaranteed when a memory card or PC card adapter other than those specified above is used.
- Even when a memory card and PC card adapter specified above are used, playback may be impossible depending on the recording conditions of the content.
- With certain contents, longer time than usual may be required before playback.
- With certain contents, the displayed image may not be clear.
- When a PC card and/or PC card adapter other than those listed above is inserted, the system may halt. In this case, turn this unit OFF (STANDBY), press the PC card eject button, take out the PC card adapter, set a PC card compatible with this unit in the PC card adapter, and restart the procedure for "Preparation" from step ②.
- Please format the memory card with the digital camera you are using. Playback of memory cards formatted with a PC is not possible.

Continued to next page

1 Load the memory card data.

Use the **INPUT SELECTOR** key (or the Memory Card key) to select **"MEMORY CARD"**.

When the **"MEMORY CARD"** input is selected, the OSD function on the TV screen is activated and the data in the memory card is loaded in this unit.



- When no memory card or PC card adapter is inserted, or when the insertion is not sufficient, the unit will not switch to the HOME display. In this case, turn this unit OFF (STANDBY), insert the adapter, or press the PC card eject button, take out the PC card adapter, and re-set the memory card properly in it.

If this unit cannot recognize the memory card, a warning message is displayed.

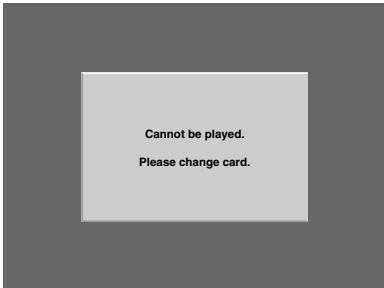

- The warning message may be displayed when this unit cannot recognize the memory card, when the card has a problem in it. In this case, turn this unit OFF (STANDBY), press the PC card eject button, take out the PC card adapter, and re-set the memory card properly in it.

2 Select a library from the home display.

The home display appears when the memory card is recognized.

Use the **MULTI CONTROL** $\Delta/\nabla/\triangleleft/\triangleright$ (or the **Multi** $\Delta/\nabla/\triangleleft/\triangleright$ keys) to select **"PHOTO"** icon, and press **ENTER** (or the **Enter** key).



Operation icons in the home display:

"PHOTO": Select to display the **"PHOTO FOLDER"** display.

"SETUP": Select to display the setup display.

3 Select the contents to be played in the "PHOTO FOLDER" display.

The hierarchy of data recorded in the memory card is displayed.

1 Press MULTI CONTROL $\Delta/\nabla/\triangleleft/\triangleright$ (or the **Multi** $\Delta/\nabla/\triangleleft/\triangleright$ keys) to select a folder or photo image file.

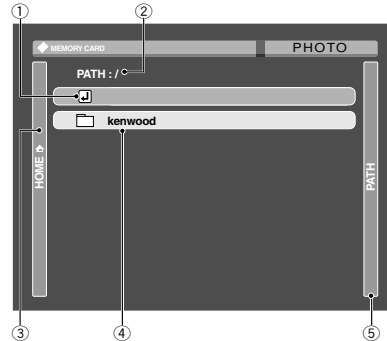

Operation icons in the "PHOTO FOLDER" display

1 Return icon: Select to switch to the HOME display or the folder display in the level immediately above the present level.

2 Display of the path to the current folder.

3 "HOME" icon: Select to display the home display. (The same operation is also available by pressing the **Home** key)

4 Folder icon, Photo file icon: *
Select a folder and press the **Enter** key to view the photo images in the album.

5 "PATH" icon:
Select to view the full path to the folder being displayed.

* If the display consists of more than one page, press the **Page** \blacktriangledown key to view the next page. Pressing the **Page** \blacktriangle key returns to the previous page.

2 Select a photo image file and press ENTER (or the Enter key).

(The same operation is also available by selecting a photo image file and pressing the \blacktriangleright /II key.)

The playback display appears and the photo image starts to be played.

- If the photo image file cannot be played because of the large image (resolution level or size matter), press the **POWER ON/STANDBY** \odot (for U.S.A. and Canada) or the **ON/STANDBY** \odot (for Europe and Australia) key to turn this unit OFF (STANDBY), and then press the **POWER ON/STANDBY** \odot (for U.S.A. and Canada) or the **ON/STANDBY** \odot (for Europe and Australia) key again to turn this unit ON.

- The top and bottom ends, or the left and right ends of the photo may be cut off depending on the orientation of the photo file.

Operation keys of the playback display

The following operations are available on the playback display. (Some operations may be unavailable depending on the played content.)

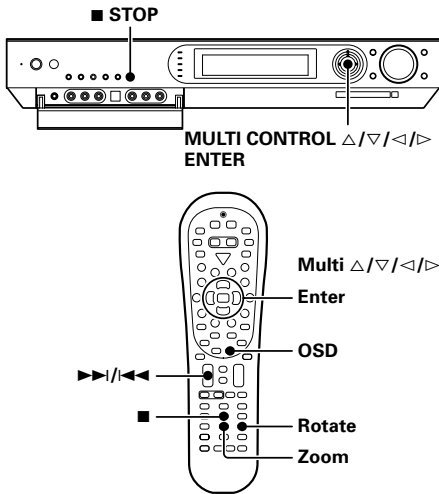

Stopping playback

Press the **■** key.

Playback stops and the "PHOTO FOLDER" display appears again.

Returning to the "PHOTO FOLDER" display.

Press the **■** key.

Playback stops and the "PHOTO FOLDER" display appears again.

Skipping a file

Press the **▶▶** or **◀◀** key.

Zoom-up playback

Photo contents can be zoomed up when they are played.

Press the Zoom key during playback of a photo content to magnify the image.

Press the key for the following selects.

x 1.25 → x 1.5 → x 1.75 → x 2 → x 2.25 → x 2.5 → x 2.75 →
x 3 → x 3.25 → x 3.5 → x 3.75 → x 4 → x 1 → x 1.25 → ...

Rotated playback

Longitudinal photo images captured using a digital camera, etc. are displayed widthwise when they are played. In this case, the displayed image can be rotated.

Press the Rotate key during playback of a photo content to rotate the image by a certain angle.

Press the key for the following selects.

"ANGLE 2" (90° rotation) → "ANGLE 3" (180° rotation) →
"ANGLE 4" (270° rotation) → "ANGLE 1" → "ANGLE 2" ...

File information

The information on the photo image file being played can be displayed.

Press the OSD key to view the information display. Pressing the key again switches off the information display.

File Name	: /dcim/kenwood/001.jpg
File Size	: 712 KB
Resolution	: 1280 X 1024
Rotate Angle	: 90 degrees

"File Name":

Current file name with path name.

"File Size":

Current file size (capacity in [KB]).

"Resolution":

Resolution of current file.

"Rotate Angle":

Rotate angle of current file.

Basic remote control operations for other components

The remote control supplied with this receiver is also capable of controlling components from a variety of manufacturers once you register the appropriate setup codes into the remote control unit.

Low battery warning

Replace all two batteries with new ones when you notice a shortening of the distance from which the remote control will operate. The remote control is designed to retain setup codes in memory while you change batteries.

Registering setup codes for other components

When the setup code defined for remote control of every system component is registered in one of the input selector keys of the remote control unit, you can control that component simply after selecting it using the corresponding input selector key of the remote control unit.

- When recording audio on a VCR or MD recorder, for example, you can also control the system component by switching only the remote control unit, without switching the input source of the receiver.

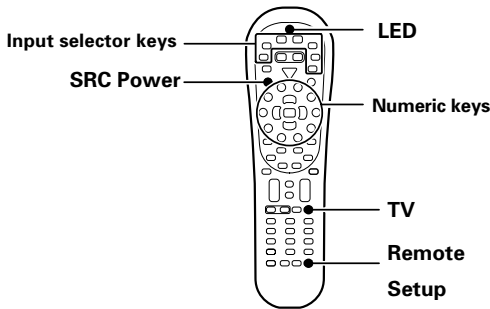

1 Find the setup code of the component to be registered.

Refer to the setup code lists to find the setup code for the component to be registered. → [64] → [69]

Example: To register a DVD made by KENWOOD, you would enter "0490" or "0534".

2 Press the input selector key (DVD, VID1, VID2, AUX, F.AUX, Game or TV) you want to register a system component.

The following table shows the type of components that can be registered in each input selector key.

Input selector key	Registerable component	Input jacks where the component is connected
DVD	DVD player	DVD
VID1	VCR	VIDEO1
VID2	Cable Converters Satellite Receivers	VIDEO2
AUX	CD player, MD recorder (KENWOOD)	AUX
F. AUX	Game player (Default: Xbox), DVD player	FRONT AUX
Game	Game player (Default: Play Station2), DVD player	GAME
TV	TV (including TVs incorporating VCR)	—

- Make sure that a source belonging to the registerable component is connected to the corresponding input jacks on the receiver.
- A second DVD recorder, CD player or VCR can also be connected by changing the assignment of the registerable component devices. See "Re-assigning device keys" on page 63.

3 Press and hold the Remote Setup key until the LED blinks twice, then release the Remote Setup key.

- Proceed to the next steps in less than 10 seconds after the LED blinks twice.

4 Press the numeric key to enter the four-digit code for the component to be registered.

- The LED blinks twice when registration is completed successfully.

5 Ensure that the registered component functions properly.

To ensure the proper function, perform the following operation and check if the component functions as intended.

Point the remote control unit to the component and press the **SRC Power** key (or the **TV Power** key if the component is a TV) once. If the setup code is registered properly, the component should be turned ON or OFF. If the component is a VCR, turn the VCR ON and load a video tape and perform an operation such as playback. The VCR should function as controlled if its setup code is registered properly.

If the component does not function properly:

If more than one setup code is listed for the component, try registering another setup code by performing steps 3 to 5.

- Repeat steps 1 to 5 above to register the setup code of another component.

- To change the registered setup code, register a new setup code again by performing steps 1 to 5 above.

Note

Although each setup code is designed to work with a number of different models, certain codes may not work with some models. (Also, certain codes may only operate some of the functions available on a given model.)

Searching for your code

If your component does not respond after trying all the codes listed for your component, or if your component is not listed at all, try searching for your code.

For example, to search for a code for your TV.

1 Press the TV key once.

When searching for the setup code of a component other than TV:

Press the desired input selector key instead of the **TV** key.

2 Press and hold the Remote Setup key until the LED blinks twice, then release the Remote Setup key.

- Proceed to the next steps in less than 10 seconds after the LED blinks twice.

3 Press the numeric key to enter "9 9 1".

- The LED will blink twice.

4 Point the remote control at the TV and slowly alternate between pressing the TV Power and TV keys. Stop when the TV turns on or off.

- In the search mode, the remote control will send IR codes from its library to the selected device, starting with the most popular code first.

When searching for the setup code of a component other than TV:

To search for the setup code of a DVD, CD, MD or VCR, press the input selector key pressed in 1 and the **SRC Power** key alternately and check if the component to be registered is turned ON and OFF. To search for the setup code of a VCR, turn the VCR ON, load a tape and press the input selector key pressed in step 1 (i.e. VID1) and an operation key such as the play key alternately and check if the VCR is controlled as intended.

5 Press the Remote Setup key once to lock in the code.

Checking the codes

The 4-digit setup codes registered in the input selector keys can be checked as follows.

- 1 Press the input selector key in which the setup code of the desired component is registered.**
- 2 Press and hold the Remote Setup key until the LED blinks twice, then release the Remote Setup key.**
 - Proceed to the next steps in less than 10 seconds after the LED blinks twice.
- 3 Press the numeric key to enter "9 9 0".**
 - The LED will blink twice.
- 4 Press the numeric key "1" once.**

The LED blinks for the same number of times as the numeral in the first digit of the 4-digit code. When the registered setup code is "1338", for example, the LED will blink once. If a code digit is "0", the LED will not blink.
- 5 Repeat step 4 three more times for the remaining digit. Use "2" for the second digit, "3" for the third digit, and "4" for the fourth digit.**

Re-assigning device keys

The type of component device that can be registered is assigned in advance in each input selector key, but this assignment can be changed as desired by the user.

For example, the initial status is set so that a VCR can be registered in the input selector **VID1** key. If you want to register the setup code of a DVD player in the **VID1** key just like in the **DVD** key, reassign the key (change the registerable component type assignment for the input selector key) as described below.

- 1 Press and hold the Remote Setup key until the LED blinks twice, then release the Remote Setup key.**
 - Proceed to the next steps in less than 10 seconds after the LED blinks twice.
- 2 Press the numeric key to enter "9 9 2".**
 - The LED will blink twice.
- 3 Press the DVD key once, then press the VID1 key once.**

The LED blinks twice, and it is possible to register the setup code of a DVD player in the **VID1** key just like in the **DVD** key. Now register the setup code according to the model of the DVD player. The combination of components assignable to the input selector keys can be changed by pressing different keys in step 2. For example, to change the key assignment so that the same component as that registered in input selector "B" key can be registered in input selector "A" key, press the "B" key then the "A" key after entering "9 9 2" with the numeric keys.

 - For the originally assigned relationship between the input selector keys and system component types, see the table on the previous page.
 - To restore the original component type assignment of an input selector key, press that input selector key twice after entering "9 9 2".
 - It is not possible to register a component in the **TUNER** key.

Examples of key re-assignment and the order of pressing the keys:

Registration of a DVD player in the **VID1** key

To change the VID1 key to the DVD key:

"9 9 2" → "DVD" → "VID1"

Restoration of the original key assignment

To return the VID1 key to the VID1 key:

"9 9 2" → "VID1" → "VID1"

Registration of a VCR in the **VID2** key

To change the VID2 key to the VID1 key:

"9 9 2" → "VID1" → "VID2"

Restoration of the original key assignment

To return the VID2 key to the VID2 key:

"9 9 2" → "VID2" → "VID2"

Operating other components

This operation lets you operate the registered components.

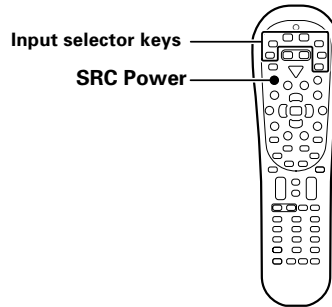

- 1 Use the Input Selector keys to select the component you desire.**

When the input selector key is pressed, the system component registered in the pressed key becomes ready to be controlled. The input selector of the receiver is also switched accordingly. If you want to control the component registered in the remote's input selector key without switching the receiver's input selector to that source, press and hold the input selector key for more than 3 seconds.

 - To put the remote control unit to the receiver control mode, press the **RCV Mode** key.
- 2 Turn the component ON.**
 - A DVD player, CD player, MD recorder or VCR registered in one of the remote's input selector keys can be turned ON by pressing the remote's **SRC Power**.
 - A TV registered in one of the remote's input selector keys can be turned ON by pressing the remote's **TV Power** key.
- 3 Press the operation keys you desire.**
 - For the keys that can be used with each system component, see pages 76 to 77.

Clearing all of the settings registered or stored in the remote control unit

You can reset the remote control unit to the initial status after purchase, clearing all of the component registration using setup codes and other data stored using the learning functions.

- 1 Press and hold the Remote Setup key until the LED blinks twice, then release the Remote Setup key.**
 - Proceed to the next steps in less than 10 seconds after the LED blinks twice.
- 2 Press the numeric key to enter "9 8 1".**
 - The LED blinks four times, and all of the data you registered or stored in the remote control unit is cleared.

Setup code chart (RC-R0826) (For U.S.A., Canada and Australia)

Even when a component is manufactured by a maker listed in the setup code chart, it may be unable to be registered depending on the model and year of production. Also, when a setup code of a non-KENWOOD maker is registered, certain component models may be unable to be controlled or only the limited functions may be controllable. In this case, it is recommended to use the remote control unit provided with the system component. For how to register the setup codes, read **'Registering setup codes for other components'** carefully. → [62](#)

Cable Converters

Maker	Setup codes
ABC	0003, 0008, 0014
Americast	0899
Bell & Howell	0014
Bell South	0899
Clearmaster	0883
ClearMax	0883
Coolmax	0883
Director	0476
General Instrument	0476, 0810, 0276, 0003
GoldStar	0144
Hamlin	0009, 0273
Jerrold	0476, 0810, 0276, 0003, 0014
Memorex	0000
Motorola	0476, 0810, 0276, 1254, 1376
Pace	0237
Panasonic	0000, 0107
Paragon	0000
Philips	0305, 0317
Pioneer	0877, 1877, 0144, 0533
Pulsar	0000
Quasar	0000
RadioShack	0883
Regal	0279, 0273
Runco	0000
Samsung	0144
Scientific Atlanta	877, 1877, 0477, 0008
Sony	1006
Starcom	0003
Supercable	0276
Supermax	0883
Torx	0003
Toshiba	0000
Tristar	0883
V2	0883
Viewmaster	0883
Vision	0883
Vortex View	0883
Zenith	0000, 0525, 0899

CD player

Maker	Setup codes
Kenwood	0681, 0826, 0626, 0028, 0037, 0339, 1490, 0338, 0523, 0859, 0190, 0340, 0677, 0858, 1338
Marantz	0626
Optimus	0037
Philips	0626
Sharp	0037
Yamaha	0036

MD recorder

Maker	Setup codes
Kenwood	0681, 0826, 1339

Audio Amp/Tuners

Maker	Setup codes
Kenwood (Sirius Satellite Radio)	2000

Video Accessories

Maker	Setup codes
Macro Image Technology	1383
MyHD	1383
Panasonic	1120
Pioneer	1010
Princeton	0113, 0295
Samsung	1490
Sensory Science	1126
Sharp	1010
Viewsonic	1329

Satellite Receivers

Maker	Setup codes
AlphaStar	0772
Chaparral	0216
Crossdigital	1109
DirecTV	0392, 0566, 0639, 1639, 1142, 0247, 0749, 1749, 0724, 0819, 1856, 1076, 1109, 0099
Dish Network System	1005, 0775
Dishpro	1005, 0775
Echostar	1005, 0775
Expressvu	0775
GE	0566
General Instrument	0869
GOI	0775
Hitachi	0819
HTS	0775
Hughes Network Systems	1142, 0749, 1749
JVC	0775
Magnavox	0724, 0722
Memorex	0724
Mitsubishi	0749
Motorola	0869
Next Level	0869
Panasonic	0247, 0701
Paysat	0724
Philips	1142, 0749, 1749, 0724, 1076, 0722, 0099
Proscan	0392, 0566
RadioShack	0869
RCA	0392, 0566, 0855, 0143
Samsung	1276, 1109
SKY	0856
Sony	0639, 1639
Star Choice	0869
Tivo	1142
Toshiba	0749, 1749, 0790, 1285
Uniden	0724, 0722
Zenith	0856, 1856

TV

Maker	Setup codes
Admiral	0093, 0463
Aiko	0092
Aiwa	1914
Akai	0812, 0702, 0030, 0672
Albatron	0843
America Action	0180
Ampro	0751
Anam	0180
AOC	0030
Apex Digital	0748, 0765, 1943
Audiovox	0451, 0180, 0092
Bell & Howell	0154
Bradford	0180
Broksonic	0236, 0463, 1935, 1929, 1938
Candle	0030
Carnivale	0030
Carver	0054
Celebrity	0000
Celera	0765
Changhong	0765
Citizen	0060, 0030, 1928, 0092
Clarion	0180
Contec	0180
Craig	0180
Crosley	0054
Crown	0180
Curtis Mathes	0047, 0054, 0154, 0451, 0093, 0060, 0702, 0030, 0145, 0166, 1919, 1347
CXC	0180
Daewoo	0451, 1661, 0672, 1928, 0092
Denon	0145
Dumont	0017
Durabrand	0180, 0178
Dwin	0720
Electroband	0000
Elektra	0017, 1661
Emerson	0154, 0236, 0463, 0180, 0178, 0171, 1944, 1929, 1928
Envision	0030
Epson	0833
Fisher	0154
Fujitsu	0853, 0809, 0683
Funai	0180, 0171
Futuretech	0180
Gateway	1756, 1755
GE	0047, 0051, 0451, 0178, 1347, 1922, 1919, 1917
Gibraltar	0017, 0030
GoldStar	0030, 0178, 1926
Grunpy	0180
Hallmark	0178
Harman/Kardon	0054
Harvard	0180
Havermy	0093
Hello Kitty	0451
Himitsu	0180
Hisense	0748
Hitachi	1145, 0145
Hyundai	0849
Infinity	0054
Inteq	0017

TV (Continued)

Maker	Setup codes
JBL	0054
JCB	0000
JVC	0053
KEC	0180
Kenwood	0030
KLH	0765
KTV	0180, 0030
LG	0856
LXI	0047, 0054, 0154, 0156, 0178
Magnasonic	1928, 1913
Magnavox	0054, 0030, 1454, 0706, 1254, 1931, 1913
Marantz	0054, 0030
Matsushita	0250, 0650
Megatron	0178, 0145
Memorex	0154, 0463, 0150, 0178, 1926
MGA	0150, 0030, 0178
Midland	0047, 0017, 0051
Mitsubishi	0093, 0150, 1250, 0178, 1917
Monivision	0843
Motorola	0093
MTC	0060, 0030
Multitech	0180
NAD	0156, 0178, 0866
NEC	0030, 1704, 0497
Nikko	0030, 0178, 0092
Norcent	0748, 0824
NTC	0092
Onwa	0180
Optimus	0154, 0250, 0166, 1913, 0650
Optonica	0093
Orion	0236, 0463, 1929
Panasonic	0250, 0051, 0650, 1946, 1941, 1919
Penney	0047, 0156, 0051, 0060, 0030, 0178, 1926, 1919, 1347
Philco	0054, 0030
Philips	0054, 1454, 0690
Pilot	0030
Pioneer	0166, 0866, 0679
Portland	0092
Prism	0051
Proscan	0047, 1922
Proton	0178
Pulsar	0017
Quasar	0250, 0051, 1919, 0650
RadioShack	0047, 0154, 0180, 0030, 0178
RCA	0047, 1919, 0090, 1247, 1917, 1948, 1047, 1547, 1922, 0679, 1347
Realistic	0154, 0180, 0030, 0178
Runco	0017, 0030, 0497, 0603
Sampo	0030, 1755
Samsung	0060, 0812, 0702, 0030, 0178, 1060, 0766, 1903
Sansui	0463, 1929
Sanyo	0154, 0799
Scotch	0178
Scott	0236, 0180, 0178
Sears	0047, 0054, 0154, 0156, 0178, 0171, 1926
Sharp	0093, 0688, 1917, 0491, 0851, 0689

TV (Continued)

Maker	Setup codes
Sheng Chia	0093
Sony	0000, 0834, 1925
Soundesign	0180, 0178
Squareview	0171
SSS	0180
Starlite	0180
Supreme	0000
SVA	0748
Sylvania	0054, 0030, 0171, 1944, 1931
Symphonic	0180, 0171, 1913
Tandy	0093
Technics	0250, 0051
Techwood	0051
Teknika	0054, 0180, 0150, 0060, 0092
Telefunken	0702
TMK	0178
TNCi	0017
Toshiba	0154, 0156, 0060, 1935, 0650, 1704, 1945, 1356, 1936, 0832
TVS	0463
Vector Research	0030
Victor	0053
Vidikron	0054
Vidtech	0178
Viewsonic	1755
Wards	0054, 0030, 0178, 0866
Waycon	0156
White Westinghouse	0463
Yamaha	0030, 0769, 0833
Zenith	0017, 0463, 0178, 0092, 1929

Video Projector

Maker	Setup codes
Ampro	0751
Dwin	0720
Epson	0833
NEC	0497
RCA	0047
Runco	0603, 0497
Sanyo	0799
Sharp	0688, 0491, 0851, 0689
Sony	0834
Toshiba	0832
Yamaha	0833
Zenith	0017

TV/VCR Combination

Maker	Setup codes
Aiwa	1914
America Action	0180
Audiovox	0180
Broksonic	1929
Citizen	1928
Curtis Mathes	1919
Daewoo	1928
Emerson	0236, 1929, 1928
GE	1922, 1919, 1917
GoldStar	1926
Magnasonic	1928, 1913
Magnavox	1913, 1931

TV/VCR Combination (Continued)

Maker	Setup codes
Memorex	1926
Mitsubishi	1917
Optimus	1913
Orion	1929
Panasonic	1919
Penney	1926, 1919
Quasar	1919
RCA	1922, 1919, 1917
Sansui	1929
Sears	1926
Sony	1925
Sylvania	1931
Symphonic	1913
Toshiba	1936
Zenith	1929

TV/DVD Combination

Maker	Setup codes
Apex Digital	1943
Broksonic	1935
Panasonic	1941
RCA	1948
Samsung	1903
Sylvania	0171
Toshiba	1935

VCR

Maker	Setup codes
Admiral	0048
Aiwa	0037
American High	0035
Asha	0240
Audiovox	0037
Beaumarck	0240
Bell & Howell	0104
Broksonic	0184, 0121
Calix	0037
Canon	0035
Carver	0081
Citizen	0037
Craig	0037, 0047, 0240
Curtis Mathes	0060, 0035, 0162
Cybernex	0240
Daewoo	0045
Denon	0042
Durabrand	0039
Electrohome	0037
Electroponic	0037
Emerex	0032
Emerson	0037, 0184, 0121, 0043
Fisher	0047, 0104
Fuji	0035, 0033
GE	0060, 0035, 0240
GoldStar	0037
Harman/Kardon	0081
HI-Q	0047
Hitachi	0042
Hughes Network Systems	0042
JVC	0067
KEC	0037

VCR (Continued)

Maker	Setup codes
Kenwood	0067
Kodak	0035, 0037
LXI	0037
Magnavox	0035, 0039, 0081
Magnin	0240
Marantz	0035, 0081
Marta	0037
Matsushita	0035, 0162
MEI	0035
Memorex	0035, 0162, 0037, 0048, 0039, 0047, 0240, 0104
MGA	0240, 0043
MGN Technology	0240
Minolta	0042
Mitsubishi	0067, 0043
Motorola	0035, 0048
MTC	0240
NEC	0104, 0067
Nikko	0037
Noblex	0240
Olympus	0035
Optimus	0162, 0037, 0048, 0104
Orion	0184
Panasonic	0035, 0162, 0616
Penney	0035, 0037, 0240, 0042
Pentax	0042
Philco	0035
Philips	0035, 0081, 0618
Pilot	0037
Pioneer	0067
Polk Audio	0081
Profitronic	0240
Proscan	0060
Pulsar	0039
Quasar	0035, 0162
Radix	0037
Randex	0037
RCA	0060, 0240, 0042, 0880
Realistic	0035, 0037, 0048, 0047, 0104
ReplayTV	0616
Runco	0039
Samsung	0240, 0045
Sanky	0048, 0039
Sansui	0067
Sanyo	0047, 0240, 0104
Scott	0184, 0045, 0121, 0043
Sears	0035, 0037, 0047, 0042, 0104
Sharp	0048
Shogun	0240
Sonic Blue	0616
Sony	0035, 0032, 0033, 0636
STS	0042
Sylvania	0035, 0081, 0043
Technics	0035, 0162
Teknika	0035, 0037
Tivo	1503, 0636, 0618
TMK	0240
Toshiba	0045, 0043, 1503
Totevision	0037, 0240
Unitech	0240
Vector	0045

VCR (Continued)

Maker	Setup codes
Video Concepts	0045
Videomagic	0037
Videosonic	0240
Wards	0060, 0035, 0048, 0047, 0081, 0240, 0042
XR-1000	0035
Zenith	0039, 0033

PVR

Maker	Setup codes
Panasonic	0616
Philips	0618
ReplayTV	0616
Sonic Blue	0616
Sony	0636
Tivo	0636, 0618

DVD player

Maker	Setup codes
Allegro	0869
Apex Digital	0672, 0717, 0796, 0794, 1061
Blaupunkt	0717
Blue Parade	0571
CineVision	0876, 0869
CyberHome	0816
Daewoo	0784, 0833
Denon	0490
DVD2000	0521
Emerson	0591, 0675
Enterprise	0591
Fisher	0670
Funai	0675
GE	0522, 0815, 0717
Go Video	0715, 0783
Greenhill	0717
Hitachi	0573, 0664
Hiteker	0672
Initial	0717
InterAct	0697
JVC	0558, 0623, 0867
Kenwood	0490, 0534
KLH	0717, 1020
Koss	0651
Lasonic	0798
Mad Catz	1108, 1002
Magnavox	0503, 0675
Marantz	0539
Microsoft	0522
Mintek	0717
Mitsubishi	1521, 0521
Nesa	0717
Norcent	1003
Onkyo	0503
Oritron	0651
Panasonic	0490, 1762
Pelican Accessories	0731
Philips	0503, 0539, 0646
Pioneer	0525, 0571
Polk Audio	0539
Proscan	0522

DVD player (Continued)

Maker	Setup codes
Qwestar	0651
RCA	0522, 0571, 0717, 0822
Rio	0869
Rotel	0623
Saitek	0731
Samsung	0490, 0573, 1075, 0820
Sanyo	0670, 0873
Sharp	0630
Shin Sonic	0533
Sonic Blue	0869
Sony	0864, 0772, 1033
Sylvania	0675
Symphonic	0675
Technics	0490
Theta Digital	0571
Thrustmaster	0498
Toshiba	0503
Tredex	0799
Urban Concepts	0503
Yamaha	0490, 0539, 0545
Zenith	0503, 0591, 0869

Game Player

Maker	Setup codes
Xbox	0522
Sony PlayStation2	0533

Setup code chart (RC-R0826E) (For Europe)

Even when a component is manufactured by a maker listed in the setup code chart, it may be unable to be registered depending on the model and year of production. Also, when a setup code of a non-KENWOOD maker is registered, certain component models may be unable to be controlled or only the limited functions may be controllable. In this case, it is recommended to use the remote control unit provided with the system component. For how to register the setup codes, read '**Registering setup codes for other components**' carefully. → 62

Cable Converters

Maker	Setup codes
ADB	1063
Birmingham Cable Communications	0276
Cable & Wireless	1068
Decsat	0423
Filmnet	0443
Golden Channel	1110, 1063
HyperVision	0619
Jerrold	0276
MNET	0443
Noos	0817
NTL	1068
Ono	1068
Pace	1068, 1060
Philips	0619
Sagem	0817
Supercable	0276
Tele Danmark	1016
Tele+1	0443
Telewest	1068
Thomson	1110
Visionetics	1064

CD player

Maker	Setup codes
Arcam	0157
Audio Research	0157
Audiolab	0157
Audiomeca	0157
Audioton	0157
Cairn	0157
Cyrus	0157
DMX Electronics	0157
Grundig	0157
Kenwood	0028, 0190, 0626, 1059, 0523, 0692, 0681, 0338, 0339, 0826, 0340, 0858, 0859, 1490, 1338
Linn	0157
Marantz	0157
Matsui	0157
Meridian	0157
Micromega	0157
Myryad	0157
Naim	0157
Philips	0157, 0626
Quad	0157
Revox	0157
Rotel	0157
Sharp	0037
Simaudio	0157

CD player (Continued)

Maker	Setup codes
TAG McLaren	0157
Thorens	0157
Thule	0157
Toshiba	0692
Trio	0677
Universum	0157
Yamaha	0036

MD recorder

Maker	Setup codes
Kenwood	1059, 0681, 1339

Satellite Receivers

Maker	Setup codes
@sat	1300
@Sky	1334
ABsat	0123
Amstrad	0847, 0811, 0501
Arcon	1205
Aston	1261
Astro	0173, 0548, 0501
Atsat	1300
AtSky	1334
Blaupunkt	0173
British Sky Broadcasting	0847, 1175, 1848
Canal Digital	0853
Canal Satellite	0853, 1339
Canal+	0853
CityCom	0115, 1176
Clark	0811
Conrad	0115
Cyrus	0200
D-box	0873
Daewoo	1201, 1296
Digenius	1161, 0299
Distratel	0885
DMT	1075
DNT	0200
Dream Multimedia	1237
Echostar	0853, 0167, 0610, 1086, 0511, 0871, 0775
Engel	1017
Fidelity	0811
Force NO AS	1101, 1194
Fracarro	0871
FTE	0811, 1121, 0863
Galaxis	1111, 0283, 1101, 0863
GbSAT	1214
GOI	0775
Gold Box	0853
Gooding	0571
Goodmans	1284
Grundig	0847, 0173, 0750, 1150, 0571, 0805, 1330
Hauppauge	1298
HDT	1011, 1159
Hirschmann	0173, 0573, 0501, 1085, 0882
HTS	0775
Humax	0283, 1176, 1048, 0863
Hyundai	1159, 1011
InVideo	0871

Satellite Receivers (Continued)

Maker	Setup codes
JVC	0571, 0775
Kathrein	0173, 0200, 1057, 0658, 1221, 0123, 0249, 1058
Kreiselmeier	0173
Labgear	1296
Logix	1017
Lorenzen	0299
Luxor	0573
Manhattan	1083, 1017
Marantz	0200
Maspro	0750
Matsui	0571
MediaSat	0853
Medion	1232
Metronic	1216, 1210, 1334
Micronik	1003
Minerva	0571
Morgan's	1103
Multichoice	0879, 0642
Myryad	0200
Netgem	1322
Neuhaus	0501
NextWave	1239, 1143, 1119
Nokia	0751, 0873, 1023, 1311, 1310, 1223, 1723, 0573
Opentel	1232
Optex	1069
Orbitech	1100, 0501
Pace	0847, 1175, 0241, 0867, 1323, 0791
Palladium	0571
Palsat	0501
Panasat	0879
Panasonic	0847, 1104, 1320
Philips	0853, 0200, 0805, 0133, 0750, 0571
Pioneer	0853, 0352, 0329
Pixx	0552
Praxis	0629
Preisner	1262
Radiola	0200
Radix	1317, 0882
Rebox	1214
RFT	0200
Saba	0885
Sagem	0820, 1114, 1307
Samsung	1244, 1243, 1293, 1017, 1292
Sat Control	1300
SatPartner	0811
Satstation	1083
Schneider	0805
Schwaiger	1111, 0552
SEG	1191, 1087
Siemens	0173
SKY	0847, 1175, 1848
SM Electronic	1200, 0587
Sony	0847, 0278
Strong	0879, 1105, 1158, 1157, 1146, 1159
Supermax	1143
TechniSat	0501, 1100, 1099, 0548
Technosat	0839

Satellite Receivers (Continued)

Maker	Setup codes
Telestar	1100, 0501, 1202
Thomson	0853, 1046, 0265, 1291
Topfield	1207, 1206
TPS	0820, 1307
Triasat	0501
Triax	0115
Universum	0173, 0571
Ventana	0200
Vortec	0815
WinsTec	1240, 1241
Wisi	0173
Wisplus	1258
Xsat	0123, 1323
Zehnder	1075, 0552, 1251

TV

Maker	Setup codes
Acura	0009
Admiral	0087, 0163
Adyson	0217
AGB	0516
Aiwa	1916, 0701
Akai	0361, 0208, 0602, 0516, 0696
Akura	0264, 0218
Alba	0037, 0668, 0218, 0036, 0235, 0009, 0581, 0371
Amplivision	0217
Amstrad	0037, 0433, 0412, 0009, 0371, 0516, 0177
Anitech	0009
Arcam	0216, 0217
ASA	0104, 0087
Asuka	0218
Atlantic	0206
Audiosonic	0037, 0109
Autovox	0206, 0087
Bang & Olufsen	0565, 0087
Barco	0479, 0410
Basic Line	0218, 0009
Baur	0037, 0361, 0512, 0349
Beaumark	0178
Beko	0714, 0486, 0715, 0370
Beon	0037
Binatone	0217
Blaupunkt	0195, 0191
Blue Sky	0668, 1037, 0218
Blue Star	0282
Boots	0217
BPL	0282
Brandt	0109, 0335
Brionvega	0087
Britannia	0216
Bruns	0087
BTC	0218
Bush	0037, 0668, 1037, 0698, 0218, 0036, 0282, 0371, 0581, 0009, 0355, 0519, 0349, 0374, 1900
Carrefour	0036
Cascade	0009
Cathay	0037

TV (Continued)

Maker	Setup codes
Centurion	0037
Century	0087
Cimline	0009
Clarivox	0037
Clatronic	0370
Condor	0370, 0320
Conrac	0808
Contec	0036, 0009, 0216
Crosley	0087
Crown	0037, 0370, 0579, 0009, 0418
CS Electronics	0216
Cybertron	0218
Daewoo	0037, 0634, 1909, 0374, 1902, 0009, 0499
Dainichi	0218
Dansai	0037
Dayton	0009
De Graaf	0548, 0208
Decca	0037, 0516, 0072
Digatron	0037
Dixi	0037, 0009
Dual	0519
Dual Tec	0217
Dumont	0087, 0070
Eiki	0735
Elbe	0259
Elin	0037, 0548
Elite	0218, 0320
Elta	0009
Emerson	1909, 0361, 0087
Erres	0037, 0012
Europhon	0516
Expert	0206
Ferguson	0037, 0560, 0073, 0193, 0190, 0335, 0109, 0238
Fidelity	0361, 0216, 0193
Finlandia	0208, 0346
Finlux	0037, 0070, 0104, 0411, 0087, 0346, 0072, 0105, 0516
Firstline	0668, 0216, 0009, 0217
Fisher	0370, 0208, 0104, 0217
Flint	0455
Forgestone	0193
Formenti	0037, 0087, 0320
Frontech	0264, 0163
Fujitsu	0683, 0206, 0072, 0853
Funai	0264
GE	1907, 0735, 1922
GEC	0037, 0072, 0516, 0217
Geloso	0009
Genexxa	0218, 0163
GoldStar	0037, 0217, 0178, 0109, 0377
Goodmans	0037, 0634, 1909, 0036, 0072, 0371, 0235, 0499, 0217, 0374, 1900
Gorenje	0370
GPM	0218
Graetz	0361, 0163
Granada	0037, 0208, 0516, 0072, 0339, 0045, 0217
Grandin	0610, 0282
Grundig	0556, 0195, 0487, 0587, 0070, 1935, 0191

TV (Continued)

Maker	Setup codes
Hanimex	1908
Hanseatic	0556, 0037, 0361, 0320
Hantarex	0516
Havermy	0093
HCM	0412, 0282, 0009
Hinari	0037, 0218, 0036, 1908, 0009
Hisawa	0455, 0282
Hitachi	0548, 1037, 0036, 0225, 0105, 0217, 0356, 0578, 0044, 0163, 0349, 0744, 1225, 0109, 0481, 0719, 1045
Huanyu	0374, 0216
Hypson	0037, 0264, 0282
ICE	0264, 0371, 0217
ICeS	0218
Imperial	0370, 0418
Indiana	0037
Ingelen	0163
Inno Hit	0072, 0516
Interfunk	0037, 0361, 0163, 0512
Intervision	0037, 0264, 0102, 0377, 0217
Isukai	0218
ITS	0371
ITT	0548, 0361, 0163
JVC	0606, 0036, 0653, 0371, 0683, 0190
Kaisui	0218, 0216, 0282, 0009, 0217
Kapsch	0206, 0163
Karcher	0610
Kathrein	0556
Kendo	0037, 0235
Kingsley	0216
Kneissel	0435, 0259
Konka	0725, 0726
Korpel	0037
Korting	0087
Koyoda	0009
L&S Electronic	0808
Leyco	0037, 0264, 0072
LG	0037, 0714, 1934, 0823
Liesenk & Tter	0037
Loewe	0790, 0512, 0087, 0791, 0633
Luma	0206
Luxor	0361, 0194, 0356, 0349
M Electronic	0037, 0480, 0104, 0163, 0374, 0109, 0346, 0009, 0105, 0217
Magnadyne	0516, 0102, 0087
Magnafon	0516, 0102
Magnin	1907
Magnum	0648
Manesth	0264, 0235, 0217, 0320
Manhattan	0778
Marantz	0556, 0037
Marelli	0087
Mark	0037
Matsui	0037, 0487, 0036, 0579, 0035, 0072, 0217, 0371, 0516, 0011, 0208, 0355, 0009, 0177, 0235, 0443
Maxivideo	0792
Mediator	0037, 0012
Medion	0668, 1037, 0808
Memorex	1037, 0009

TV (Continued)

Maker	Setup codes
Memphis	0337
Metronic	0625
Metz	0275, 0746, 0087, 0447, 0367
MGA	1907
Micromaxx	0808
Microstar	0808
Minerva	0487, 0070
Minoka	0412
Mirror	1900
Mitsubishi	0036, 0108, 0087, 0512
Mivar	0292, 0216, 0609, 0516
MTC	0512, 0349
Multitech	0216, 0102, 0009
Myryad	0556
NEC	0704, 0170, 1704
Neckermann	0556, 0037, 0087, 0349, 0191
NEI	0037, 0337
Nikkai	0037, 0264, 0218, 0035, 0216, 0337, 0072
Noblisko	0102
Nokia	0548, 0606, 0361, 1912, 0480, 0631
Nordmende	0560, 0109
Oceanic	0361, 0163
Onwa	0433
Orion	0037, 0177, 0355, 0655, 0320, 0516, 0235, 0443
Osaki	0264, 0218, 0217, 0412, 0072
Oso	0218
Osume	0072
Otto Versand	0556, 0037, 0036, 0512, 0191, 0349, 0320, 0217
Palladium	0370, 0418
Panama	0264, 0217
Panasonic	0650, 0226, 0163, 1930, 0367, 1650, 0850
Pathe Cinema	0320, 0238, 0216
Pausa	0009
Penney	1907
Perdio	0320
Philco	0087
Philips	0556, 0037, 0087, 0374, 0012, 0193, 0721
Phoenix	0087
Phonola	0037, 0012, 0087
Pioneer	0760, 0163, 0109
Plus	0771
Polytron	0697
Prandoni-Prince	0516
Profex	0361, 0009
Protech	0037, 0668, 0264, 0009, 0217, 0418, 0102, 0337
Pye	0037, 0012
Quelle	0037, 0361, 0011, 0104, 0070, 0512
Questa	0036
R-Line	0037
Radiola	0037, 0012
Radiomarelli	0087, 0516
Rank Arena	0036
RBM	0070
RCA	1922, 1907
Rediffusion	0361

TV (Continued)

Maker	Setup codes
Reoc	0714
Revox	0037
Rex	0264, 0206, 0163, 0259
RFT	0087
Roadstar	0264, 0218, 0009, 0418
Saba	0109, 0087, 0335, 0163
Saccs	0238
Sagem	0610, 0830
Saisho	0264, 0011, 0009, 0235, 0177, 0516
Salora	0548, 0361, 0194, 0163, 0356, 0349
Sambers	0516, 0102
Samsung	0556, 0037, 0264, 0370, 0587, 0618, 0009, 0217, 0644, 0060
Sandra	0216
Sansui	0655
Sanyo	0036, 0104, 0735, 0011, 0072, 0339, 1907, 0045, 0208, 0799
SBR	0037, 0012, 0193
Schaub Lorenz	0361
Schneider	0037, 0668, 1137, 0218, 0371
SEG	0668, 1037, 0264, 0036, 0217
SEI	0177, 0102, 0087, 0516
Seleco	0206, 0163, 0411, 0259
Sentra	0035
Sharp	0036, 1193, 0818, 0093
Siarem	0516, 0102, 0087
Siemens	0037, 0195, 0191
Silver	0036
Singer	0087
Sinudyne	0087, 0235, 0177, 0102, 0516
Skantic	0356
Skysonic	0696
Solavox	0163
Sonitron	0208
Sonoko	0037, 0009
Sonolor	0163, 0208
Sontec	0037
Sony	1505, 0036, 0011, 0732, 0353, 1010, 0742, 1651
Soundwave	0037, 0418
Standard	0218, 0009, 0217
Stern	0163, 0259, 0206
Sunkai	0355
Susumu	0218
SVA	0587
Sysline	0037
T + A	0447
Tandy	0218, 0163, 0072, 0217
Tashiko	0036, 0217
Tatung	0037, 0217, 0072, 0516
TCM	0808
Teac	0037, 0698, 0712, 1949, 0721
Tec	0217
Technema	0320
Technics	0650
Telefunken	0625, 0335, 0109
Telemagic	0735
Telemeister	0320
Teletech	0009
Teleton	0036, 0349, 0217, 0206

TV (Continued)

Maker	Setup codes
Tensai	0218, 0320
Texet	0218, 0216
Thomson	0625, 0560, 0349, 0109
Thorn	0037, 0361, 0190, 0499, 0035, 0104, 0072, 0193, 0512
Tomashi	0282
Toshiba	0036, 0618, 0508, 0035, 1508, 0070, 0718
Triumph	0177, 0516
Uher	0320, 0206
Ultravox	0102
Universum	0037, 0264, 0370, 0104, 0346, 0492, 0421, 0105, 1901
Vestel	0037
Videotechnic	0217
Vision	0320
Voxson	0163, 0087
Wallis	0792
Waltham	0356, 0217
Watson	0037, 0320
Watt Radio	0102
Wega	0036, 0087
White Westinghouse	0037, 0216, 0320
Yoko	0037, 0264, 0217
Zanussi	0206

Video Projector

Maker	Setup codes
Barco	0479, 0410
Eiki	0735
GE	0735
JVC	0683
LG	0823
Maxivideo	0792
Plus	0771
Sanyo	0799, 0735
Sony	0742, 0732, 0353
Wallis	0792

TV/VCR Combination

Maker	Setup codes
Aiwa	1916
Daewoo	1909
Emerson	1909
GE	1907, 1922
Goodmans	1909
Hanimex	1908
Hinari	1908
LG	1934
Magnin	1907
MGA	1907
Nokia	1912
Panasonic	1930
Penney	1907
RCA	1922, 1907
Sanyo	1907

TV/DVD Combination

Maker	Setup codes
Bush	1037, 1900
Daewoo	1902
Goodmans	1900
Grundig	1935
Mirror	1900
Teac	0698, 1949

VCR

Maker	Setup codes
Aiwa	0348, 0000, 0307
Akai	0315, 0106, 0041
Alba	0278, 0315
Amstrad	0000
ASA	0081, 0037
Asuka	0037
Baird	0000, 0041
Bang & Olufsen	0499
Basic Line	0278
Blaupunkt	0226, 0034
Brandt	0320
Brandt Electronic	0041
Bush	0278
CGE	0000
Crown	0278
Cyrus	0081
Daewoo	0278, 0637, 0642, 0561
De Graaf	0042, 0166
Decca	0081, 0000
Denon	0042
Dual	0041
Dumont	0081, 0000, 0105
Emerson	0637, 0561
ESC	0278, 0240
Fast	0897
Ferguson	0320, 0041
Fidelity	0000
Finlandia	0081
Finlux	0081, 0000, 0042, 0105
Firstline	0037, 0045, 0043
Fisher	0047, 0046
Funai	0000
GEC	0081
GoldStar	0037
Goodmans	0278, 0637, 0037, 0000
Graetz	0041, 0240
Granada	0081, 0046
Grandin	0037, 0000
Grundig	0081, 0226, 0034, 0349, 0080, 0347
Hanseatic	0037
Hinari	0240
Hitachi	0000, 0042, 0240, 0041, 0166, 0105
Imperial	0000
Interfunk	0081
ITT	0384, 0106, 0041, 0240, 0046
ITV	0278, 0037
JVC	0384, 0067, 0041, 0008
Kendo	0106
Kenwood	0041
Lenco	0278
Loewe	0081, 1562, 0037, 0080, 0866

VCR (Continued)

Maker	Setup codes
Logik	0240
Luxor	0048, 0043, 0106, 0046
M Electronic	0000
Manesth	0045
Marantz	0081, 0146
Matsui	0348
Medion	0348
Memorex	0037, 0000, 0046
Metronic	0081
Metz	1562, 0037, 0347
Mitsubishi	0081, 0067, 0043
Multitech	0000
Murphy	0000
Myryad	0081
NEC	0067, 0041
Neckermann	0081
Nokia	0106, 0046, 0041, 0240
Nordmende	0320, 0384, 0041
Oceanic	0000, 0041
Okano	0348, 0315
Orion	0348
Osaki	0037, 0000
Otto Versand	0081, 0080
Palladium	0037, 0041
Panasonic	1562, 0226
Pathe Marconi	0041
Pentax	0042, 0105
Perdio	0000
Philips	0081, 0384, 0080, 0146
Phonola	0081, 0080
Pioneer	0081, 0067
Profitronic	0240
Proline	0000
Pye	0081
Quartz	0046
Quelle	0081, 0080
Radiola	0081
Reoc	0348
Rex	0384, 0041
Roadstar	0278, 0037, 0240
Saba	0320, 0384, 0041
Salora	0043, 0106, 0046
Samsung	0432, 0240
Sansui	0067, 0041
Sanyo	0046
SBR	0081, 0080, 0146
Schaub Lorenz	0000, 0041
Schneider	0081, 0000, 0897
SEG	0240
SEI	0081
Seleco	0041
Sharp	0048, 0569
Siemens	0081, 0037, 0146
Silva	0037
Singer	0045
Sinudyne	0081
Sonolor	0046
Sontec	0037
Sony	0032, 0034, 0033, 1032
Sunkai	0348
Sunstar	0000
Suntronic	0000

VCR (Continued)

Maker	Setup codes
Tashiko	0000
Tatung	0081, 0000, 0041
Technics	0226
Teleavia	0041
Telefunken	0320, 0384, 0041
Tensai	0000
Thomson	0320, 0384, 0067, 0722, 0041
Thorn	0041
Tivo	0722
Toshiba	0081, 0384, 0045, 0043, 0041, 1008
Uher	0240
Universum	0081, 0037, 0000, 0106, 0240
Videomagic	0037
Villain	0000
Wharfedale	0615
Yoko	0240

DVD player

Maker	Setup codes
Acoustic Solutions	0730
Afreedy	0698
Aiwa	0641
Alba	0717
Amoisonic	0764
Amstrad	0713
Apex Digital	0795, 0672
Bush	0811, 0713, 0690
Cat	0789, 0787, 0786
Clatronic	0788
Clayton	0713
CyberHome	0714, 0816
Cytron	0716
Daewoo	0770, 0833, 0832
Dansai	0770
Decca	0770
Denon	0490, 0634
Denver	0778
DiViDo	0705
Enterprise	0591
Gamester	1030
GoldStar	0741
Goodmans	0790, 1004
GPX	0769
Greenhill	0717
Grundig	0539, 0695, 0775, 0705, 0701
H & B	0841, 0818
Harman/Kardon	0702
Himage	0518
Hitachi	0664
Hiteker	0672
HiIMAX	0843
Jaton	0665
JMB	0695
Joytech	0776
JVC	0623, 0558
Kenwood	0490, 0737, 0534
Kiss	0841, 0665
Konka	0711
Lasonic	0743
Lecson	0696

DVD player (Continued)

Maker	Setup codes
Lenco	0774
Lenoxx	0819
LG	0741, 0591
Limit	0768
Logix	0783
Mebetec	0562
Mediencom	0746
Metronic	0690
MiCO	0723
Minato	0752
Minowa	0712
Mirror	0752
Mitsubishi	0521
Monyka	0665
Mustek	0730
NAD	0692
Olidata	0672
Onkyo	0627
Optim	0747
Oritron	0651
Panasonic	0490, 1010
Philco	0690
Philips	0539, 0646
Pioneer	0571, 0525, 0631
Proline	0686
REC	0689
Redstar	0763, 0748
Remotec	0767
Reoc	0752
Revoy	0699
Roadstar	0689
Rotel	0623
Samsung	0573, 0744
Sanyo	0670
Schneider	0783
Schwaiger	0752
Scott	0718
Sharp	0630
Sherwood	0633
Shinco	0717
Skyworth	0766
SM Electronic	0730, 0690
Sony	0772, 1533, 1033
Tatung	0770, 0771
Teac	0759
Technics	0490
TerraTec	0825
Thomson	0551, 0522
Tokai	0665
Toshiba	0503, 1045
Tredex	0799, 0843
Umax	0531, 0690
Universum	0591
Wesder	0699
Wharfedale	0686, 0696
Xoro	0806
Xwave	0709
Yamada	1004
Yamakawa	0765, 0710, 0665
Yelo	0780

Game Player

Maker	Setup codes
Xbox	0522
Sony PlayStation2	0533

DVD player, MD recorder, CD player & TV operations

Refer to the following for the type of remote control operations available for each component.

- ❶ Select the input source.
- ❷ Press the keys corresponding to the operations you desire. Refer to the following sections for details.

- When pressing keys in succession, press each key firmly and be sure to wait at least 1 second before pressing the next key.
- Numeric keys function the same as the numeric keys on the original remote.

These keys can be used to perform the basic operations of KENWOOD and other manufacturers' components which the setup code for each component had been entered beforehand. - [64] - [69]

DVD player operation keys

MD recorder operation keys (made by KENWOOD)

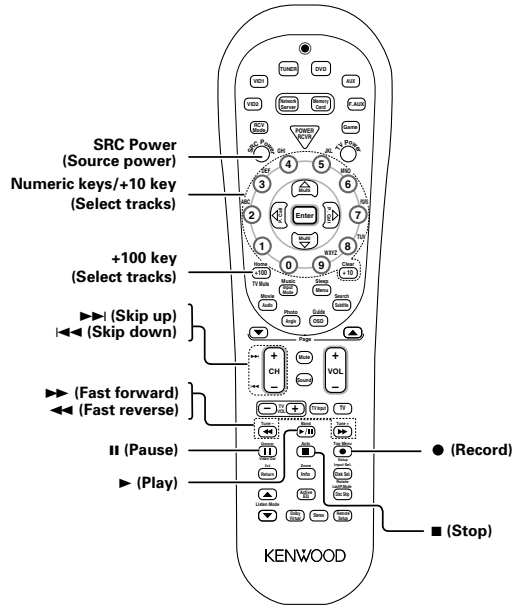
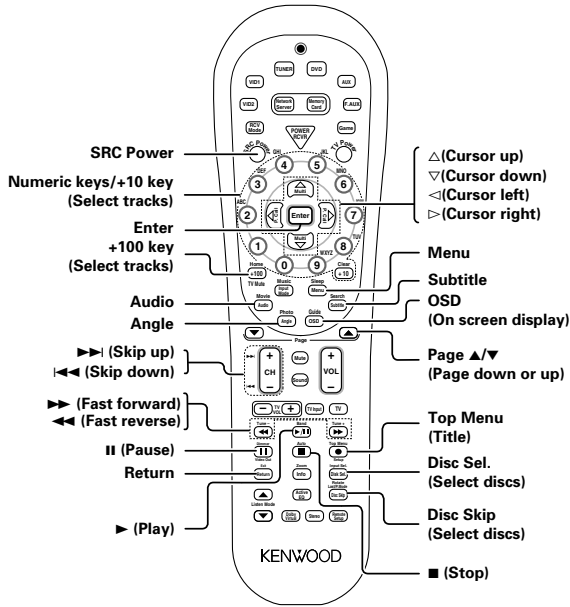

CD player operation keys

TV operation keys (including TVs incorporating VCR)

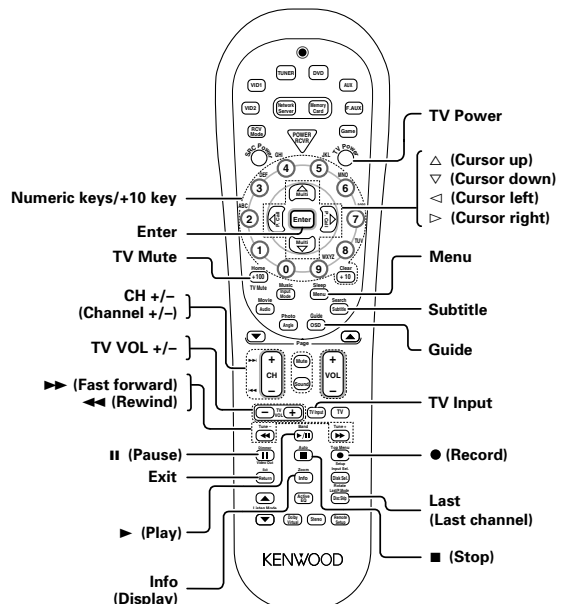
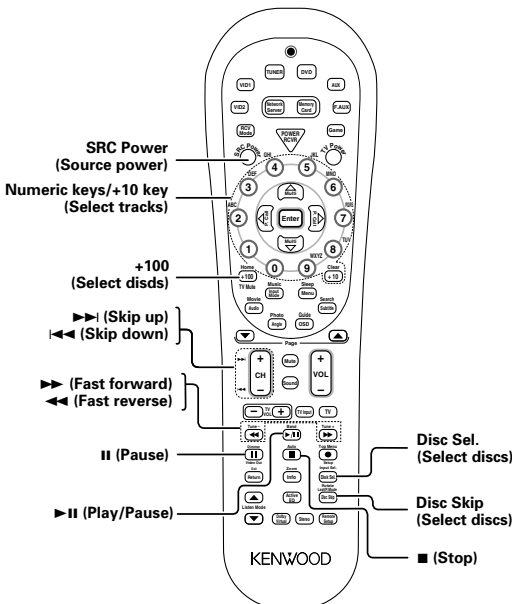

VCR, Satellite receiver & Cable converter operations

Refer to the following for the type of remote control operations available for each component.

- ❶ Select the input source.
- ❷ Press the keys corresponding to the operations you desire. Refer to the following sections for details.

- When pressing keys in succession, press each key firmly and be sure to wait at least 1 second before pressing the next key.
- Numeric keys function the same as the numeric keys on the original remote.

These keys can be used to perform the basic operations of KENWOOD and other manufacturers' components which the setup code for each component had been entered beforehand. - [64] - [69]

VCR operation keys

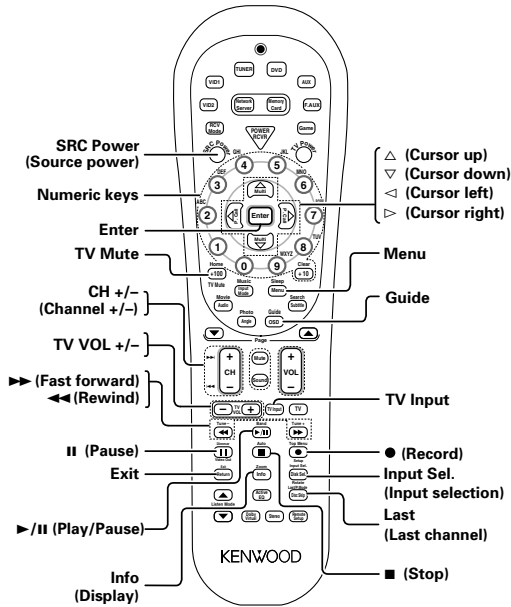

Satellite receiver operation keys

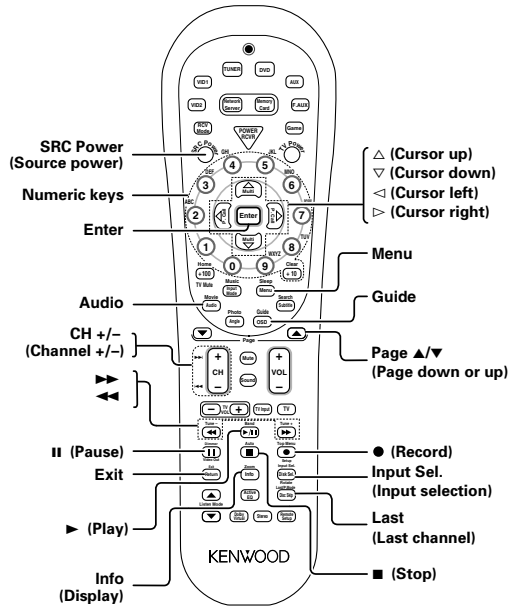

Cable converter operation keys

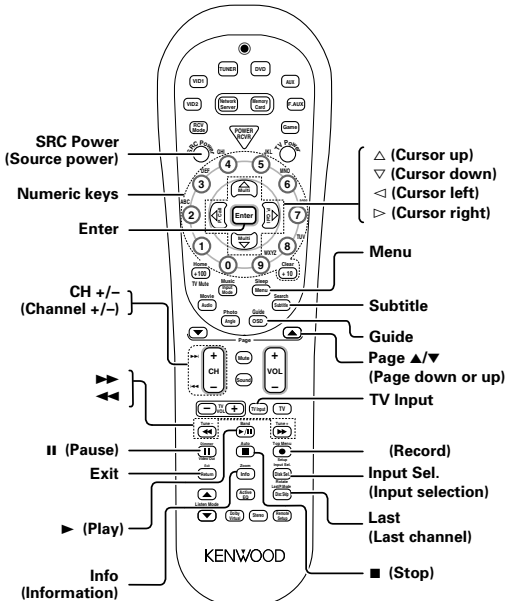

Sirius operation keys (made by KENWOOD)

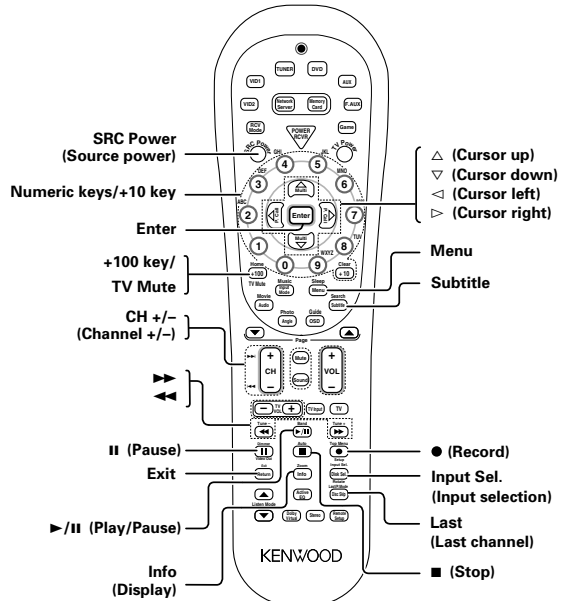

In case of difficulty



Resetting the Microcomputer



The microcomputer may malfunction (unit cannot be operated, or shows an erroneous display) if the power cord is unplugged while the power is ON, or due to some other external factor. If this happens, please try either procedure below.

Soft reset:



This reset procedure allows the setups made by the user to be held without being reset.



(For U.S.A and Canada)

Press POWER ON/STANDBY  key to turn this unit OFF (STANDBY), and then press POWER ON/STANDBY  key again to turn it ON.



- If a memory card is inserted, remove the memory card after pressing POWER ON/STANDBY  key to turn this unit OFF (STANDBY). After removal, press POWER ON/STANDBY  key again to turn it on.

(For Europe and Australia)

Press ON/STANDBY  key to turn this unit OFF (STANDBY), and then press ON/STANDBY  key again to turn it ON.







- If a memory card is inserted, remove the memory card after pressing ON/STANDBY  key to turn this unit OFF (STANDBY). After removal, press ON/STANDBY  key again to turn it on.

Reset to the factory default setups:

Unplug the power cord from the wall outlet, then plug it back in while holding down the POWER ON/STANDBY  (For U.S.A and Canada) or ON/STANDBY  key (For Europe and Australia).

- Please note that resetting the microcomputer will clear the contents of the memory and returns the unit to the state it was in when it left the factory.

Network

Symptom	Remedy
The KENWOOD PC SERVER application cannot be installed in the PC or the installed application will not run.	<ul style="list-style-type: none"> ● Check if the OS is supported.  46
The VRS-N8100 is not found in [My Computer] of the PC server.	<ul style="list-style-type: none"> ● The PC server does not recognize the VRS-N8100.
This unit cannot be used inside a firewall.	<ul style="list-style-type: none"> ● Set the firewall to OFF.
Playback interrupted or stopped while there is no problem in the network connection.	<ul style="list-style-type: none"> ● The network may be congested. Stop other devices connected to the same network and retry. ● If wireless connection is in use, the transfer rate may be dropped due to interference from other devices. Stop equipment that generates radio waves such as a microwave oven and retry.
The MOVIE, MUSIC or PHOTO files are not displayed.	<ul style="list-style-type: none"> ● Check the setup of the KENWOOD PC SERVER application.  48 ● Press "SAVE" of the KENWOOD PC SERVER and reload it.  48
Audio is not output when a video data (movie file) is played back.	<ul style="list-style-type: none"> ● The audio format used by the file may be incompatible with this unit. Try a video data (movie file) recorded using an audio format that is compatible with this unit.  4
The TV image is displayed in black and white.	<ul style="list-style-type: none"> ● The video format of the video output from this unit does not match that of the TV. Check the "Video Out" setting.  27
The image of a JPEG file cannot be displayed.	<ul style="list-style-type: none"> ● The resolution of the image is higher than the maximum resolution of this unit or the file size is larger than the maximum file size.  4
The JPEG files in a memory card are not displayed.	<ul style="list-style-type: none"> ● Check that the file has an extension of ".JPG" or ".JPEG". ● Check that the filename is composed only of alphanumeric characters (A to Z, 0 to 9, _).
Some buttons are not displayed by the KENWOOD PC SERVER application.	<ul style="list-style-type: none"> ● This display resolution setting is low. Increase the display resolution.

Amplifier

Symptom	Remedy
No sound from the speakers.	<ul style="list-style-type: none"> ● Connect them properly referring to "Connecting the speakers" - 14 ● If muting is ON, release it. - 32 ● If headphones are connected, disconnect them. - 31 ● Press the Input Mode key to select to full auto mode. - 9 ● Check if the assignment of digital audio input jacks is correct. - 25
Sound is not output from the speaker, or their sound is very small.	<ul style="list-style-type: none"> ● Connect them properly referring to "Connecting the speakers" - 14 ● See "Speaker settings" and check if the setting for all of the speakers is correct. - 20 ● Select a surround mode. ● Adjust the speaker levels using the test tone. - 23
The standby indicator blinks and sound is not output.	<ul style="list-style-type: none"> ● The protection circuitry is activated because speaker cords are short-circuited. Disconnect the power cord from the AC wall outlet, switch the receiver OFF, remove the short-circuiting and turn the receiver ON again. ● The protection circuitry is activated because the output power is too high. Turn this unit OFF then ON again and reduce the output volume level. ● The protection circuitry activated due to extreme rise in temperature. Turn this unit OFF then ON again and reduce the output volume level. ● The protection circuitry is activated because the impedance of the speakers in use is lower than specified. Use speakers of the specified impedance.
The audio and video of a different channel are output.	<ul style="list-style-type: none"> ● Check if the assignment of digital audio input jacks and component video jacks is correct. - 25
The video is not output.	<ul style="list-style-type: none"> ● Connect the video source to be played to this unit and this unit to the monitor TV using the same type of cords (Component video cords, S VIDEO cords or yellow RCA video cords) correctly. - 12
Audio cannot be recorded.	<ul style="list-style-type: none"> ● Connect the equipment correctly by referring to "Connecting video components, audio components" and "Digital connections". - 12 - 13 ● If it is the digital audio that you attempt to record, set up the unit correctly by referring to "Recording music in REC mode". - 33
A video source cannot be recorded normally.	<ul style="list-style-type: none"> ● Copy-guarded video software cannot be recorded. ● The S VIDEO and component video inputs cannot be recorded. Connect the video source to the yellow RCA video jack. - 12
When playing a digital source signal, the sound is cut off soon after it starts.	<ul style="list-style-type: none"> ● There are many possible causes for this problem, depending on the type of player used. Switch the input mode to DIGITAL MANUAL during playback of the digital source, and restart the playback from the beginning. - 9
Dolby Digital or DTS audio software cannot be played in multi-channel audio.	<ul style="list-style-type: none"> ● Check if the digital output setting of the digital audio player is correct.
The audio of a satellite digital broadcasting cannot be switched.	<ul style="list-style-type: none"> ● With certain broadcasting, the audio cannot be switched on the receiver. In this case, switch the audio on your satellite digital tuner.
The input for the unit is set automatically to "GAME" when the unit is turned ON.	<ul style="list-style-type: none"> ● The GAME mode function is activated. - 24

Tuner

Symptom	Remedy
Radio stations cannot be received.	<ul style="list-style-type: none"> ● Connect an antenna properly. - [17] ● Set the broadcast band properly. - [34] ● Tune the frequency of the desired station.
Interference.	<ul style="list-style-type: none"> ● Install the outdoor antenna away from the road. ● Turn off the power to the appliance. ● Install the receiver farther away from the TV.
A station which was preset cannot be received by pressing the corresponding numeric key.	<ul style="list-style-type: none"> ● Preset a station with a receivable frequency.

Remote control unit

Symptom	Remedy
Control of another component is impossible.	<ul style="list-style-type: none"> ● Register its setup code correctly. - [62]
Remote control operation is not possible.	<ul style="list-style-type: none"> ● Press the input selector key and select the optimum control mode. ● Replace with new batteries. ● Point the remote control unit to the remote sensor of the receiver. - [17] ● Connect the components properly referring to "Setting up the system". ● The remote control has not been set to the operation mode for the component you wish to control. Press the source select keys or the SRC Power key to activate the operation mode for the component you want to control before operation. - [63]

Frequently Asked Questions (FAQ):

If you still have questions concerning the product after reading this manual, please consult the FAQ section on the KENWOOD website of your resident country (if necessary you can find a link to your local website on www.kenwood.com <<http://www.kenwood.com>>).

Software and Firmware update:

The latest information and procedure to update your KENWOOD PC SERVER software and VRS-N8100 Firmware can be found in the "Technical Support" / "Service" section on the website of your resident country (if necessary you can find a link to your local website on www.kenwood.com <<http://www.kenwood.com>>).

Memory back-up function

If the power supply to the receiver is shut down for about a day or more, the following settings will be reset to the initial conditions. Please be careful.

- Power mode = OFF
- Volume level = - 66 dB
- Dimmer level = OFF (Brightest condition)
- Broadcast band = FM
- Frequency setting = 87.50 MHz
- Tuning mode = AUTO

For the U.S.A.

Note to CATV system installer

This reminder is provided to call the CATV system installer's attention to Article 820-40 of the NEC that provides guidelines for proper grounding and, in particular, specifies that the cable ground shall be connected to the grounding system of the building, as close to the point of cable entry as practical.

For the U.S.A.

FCC WARNING

This equipment may generate or use radio frequency energy. Changes or modifications to this equipment may cause harmful interference unless the modifications are expressly approved in the instruction manual. The user could lose the authority to operate this equipment if an unauthorized change or modification is made.

NOTE:

This equipment has been tested and found to comply with the limits for a Class B digital device, pursuant to Part 15 of the FCC Rules. These limits are designed to provide reasonable protection against harmful interference in a residential installation. This equipment may cause harmful interference to radio communications, if it is not installed and used in accordance with the instructions. However, there is no guarantee that interference will not occur in a particular installation. If this equipment does cause harmful interference to radio or television reception, which can be determined by turning the equipment off and on, the user is encouraged to try to correct the interference by one or more of the following measures:

- Reorient or relocate the receiving antenna.
- Increase the separation between the equipment and receiver.
- Connect the equipment into an outlet on a circuit different from that to which the receiver is connected.
- Consult the dealer or an experienced radio / TV technician for help.

For the U.S.A.



As an ENERGY STAR® Partner, Kenwood Corporation has determined that this products meets the ENERGY STAR® guidelines for energy efficiency. This product can save energy. Saving energy reduces air pollution and lowers utility bills.

Specifications (For U.S.A. and Canada)

AUDIO section

Rated power output during STEREO operation

70 watts per channel minimum RMS, both channels driven, at 8 Ω from 20 Hz to 20 kHz with no more than 0.7% total harmonic distortion. (FTC)

100 watts per channel minimum RMS, both channels driven, at 6 Ω from 20 Hz to 20 kHz with no more than 0.7% total harmonic distortion.

Effective power output during STEREO operation ... 130 W + 130 W
(1 kHz, 10% T.H.D. at 6 Ω)

Effective power output during SURROUND operation

FRONT 100 W + 100 W
(1 kHz, 0.5% T.H.D. at 6 Ω one channel driven)
130 W + 130 W
(1 kHz, 10% T.H.D. at 6 Ω one channel driven)

CENTER 100 W
(1 kHz, 0.5% T.H.D. at 6 Ω one channel driven)
130 W
(1 kHz, 10% T.H.D. at 6 Ω one channel driven)

SURROUND 100 W + 100 W
(1 kHz, 0.5% T.H.D. at 6 Ω one channel driven)
130 W + 130 W
(1 kHz, 10% T.H.D. at 6 Ω one channel driven)

SURROUND BACK/SUBWOOFER 100 W
(1 kHz, 0.5% T.H.D. at 6 Ω one channel driven)
130 W
(1 kHz, 10% T.H.D. at 6 Ω one channel driven)

Total harmonic distortion 0.09% (1 kHz, 50 W, 6 Ω)

Frequency response

DIGITAL IN (DVD, VIDEO 1, VIDEO 2, AUX, GAME)
..... 10 Hz ~ 44 kHz, Sampling frequency 96kHz, +0 dB ~ -3.0 dB

Signal to noise ratio

DIGITAL IN (DVD, VIDEO 1, VIDEO 2, AUX, GAME) 96 dB

Input sensitivity / impedance

LINE (DVD, VIDEO 1, VIDEO 2, AUX, FRONT AUX, GAME)
..... 200 mV / 47 kΩ

Output level / impedance

REC OUT 200 mV / 1 kΩ

PRE OUT (SURROUND BACK) 1 V / 1 kΩ

PRE OUT (SUBWOOFER) 1 V / 1 kΩ

Tone control

BASS ±10 dB (at 100 Hz)

TREBLE ±10 dB (at 10 kHz)

DIGITAL AUDIO section

Sampling frequency 32 kHz, 44.1 kHz, 48 kHz, 88.2 kHz, 96 kHz

Input level / impedance / wave length

Optical (VIDEO 1, AUX, GAME)
..... (-15 dBm ~ -24 dBm), 660 nm ±30 nm

Coaxial (DVD, VIDEO 2) 0.5 Vp-p / 75 Ω

VIDEO section

Input sensitivity / impedance

Composite (DVD, VIDEO 1, VIDEO 2, FRONT AUX, GAME)
..... 1 Vp-p / 75 Ω

S VIDEO (DVD, VIDEO 2)

Luminance signal 1 Vp-p / 75 Ω

Chrominance signal 0.286 Vp-p / 75 Ω

COMPONENT VIDEO (DVD, VIDEO 2)

Luminance signal 1 Vp-p / 75 Ω

Cb/Cr-signal 0.64 Vp-p / 75 Ω

Output level / impedance

Composite (VIDEO 1, MONITOR OUT) 1 Vp-p / 75 Ω

S VIDEO (MONITOR OUT)

Luminance signal 1 Vp-p / 75 Ω

Chrominance signal 0.286 Vp-p / 75 Ω

COMPONENT VIDEO (MONITOR OUT)

Luminance signal 1 Vp-p / 75 Ω

Cb/Cr-signal 0.64 Vp-p / 75 Ω

FM tuner section

Tuning frequency range 87.5 MHz ~ 108 MHz

Usable sensitivity (MONO)

..... 1.3 μV (75 Ω) / 13.2 dBf (75 kHz dev, SINAD 30 dB)

50 dB quieting sensitivity

STEREO 28 μV (75 Ω) / 40.2 dBf (75 kHz dev)

Total harmonic distortion (1 kHz)

MONO 0.5% (71.2 dBf input)

STEREO 0.7% (71.2 dBf input)

Signal to noise ratio (1 kHz)

MONO 75 dB (71.2 dBf input)

STEREO 68 dB (71.2 dBf input)

Selectivity (±400 kHz) 70 dB

Stereo separation (1 kHz) 40 dB

Frequency response (30 Hz ~ 15kHz) +0.5 dB, -3.0 dB

AM tuner section

Tuning frequency range 530 kHz ~ 1,700 kHz

Usable sensitivity (30% mod, S/N 20 dB) 16 μV / (600 μV/m)

Signal to noise ratio (30% mod, 400 Hz)

..... 50 dB (60 dBμ V EMF input)

GENERAL

Power consumption 95 W

Dimensions W: 440 mm (17-5/16")

H: 79 mm (3-1/8")

D: 364 mm (14-5/16")

Weight (Net) 4.6 kg (10.1 lb)

Notes

1.KENWOOD follows a policy of continuous advancements in development. For this reason specifications may be changed without notice.

2.The full performance may not be exhibited in an extremely cold location (under a water-freezing temperature).

Specifications (For Europe and Australia)

AUDIO section

For Europe

Rated power output during STEREO operation 100 W + 100 W
DIN/IEC (20 Hz ~ 20 kHz, 0.7% T.H.D. at 6 Ω)
Effective power output during STEREO operation 130 W + 130 W
(1 kHz, 10% T.H.D. at 6 Ω)

For Australia

Rated power output during STEREO operation

70 watts per channel minimum RMS, both channels driven,
at 8 Ω from 20 Hz to 20 kHz with no more than 0.7% total
harmonic distortion. (FTC)

Rated power output during STEREO operation .. 100 W + 100 W
DIN/IEC (20 Hz ~ 20 kHz, 0.7% T.H.D. at 6 Ω)
Effective power output during STEREO operation ... 130 W + 130 W
(1 kHz, 10% T.H.D. at 6 Ω)

Effective power output during SURROUND operation

FRONT 100 W + 100 W
(1 kHz, 0.5% T.H.D. at 6 Ω one channel driven)
130 W + 130 W
(1 kHz, 10% T.H.D. at 6 Ω one channel driven)
CENTER 100 W
(1 kHz, 0.5% T.H.D. at 6 Ω one channel driven)
130 W
(1 kHz, 10% T.H.D. at 6 Ω one channel driven)
SURROUND 100 W + 100 W
(1 kHz, 0.5% T.H.D. at 6 Ω one channel driven)
130 W + 130 W
(1 kHz, 10% T.H.D. at 6 Ω one channel driven)
SURROUND BACK/SUBWOOFER 100 W
(1 kHz, 0.5% T.H.D. at 6 Ω one channel driven)
130 W
(1 kHz, 10% T.H.D. at 6 Ω one channel driven)

Total harmonic distortion 0.09% (1 kHz, 50 W, 6 Ω)

Frequency response

DIGITAL IN (DVD, VIDEO 1, VIDEO 2, AUX, GAME)
..... 10 Hz ~ 44 kHz, Sampling frequency 96kHz, +0 dB ~ -3.0 dB

Signal to noise ratio

DIGITAL IN (DVD, VIDEO 1, VIDEO 2, AUX, GAME) 96 dB

Input sensitivity / impedance

LINE (DVD, VIDEO 1, VIDEO 2, AUX, FRONT AUX, GAME)
..... 200 mV / 47 kΩ

Output level / impedance

REC OUT 200 mV / 1 kΩ
PRE OUT (SURROUND BACK) 1 V / 1 kΩ
PRE OUT (SUBWOOFER) 1 V / 1 kΩ

Tone control

BASS ±10 dB (at 100 Hz)
TREBLE ±10 dB (at 10 kHz)

DIGITAL AUDIO section

Sampling frequency 32 kHz, 44.1 kHz, 48 kHz, 88.2 kHz, 96 kHz

Input level / impedance / wave length

Optical (VIDEO 1, AUX, GAME)
..... (-15 dBm ~ -24 dBm), 660 nm ±30 nm
Coaxial (DVD, VIDEO 2) 0.5 Vp-p / 75 Ω

VIDEO section

Input sensitivity / impedance

Composite (DVD, VIDEO 1, VIDEO 2, FRONT AUX, GAME)
..... 1 Vp-p / 75 Ω

S VIDEO (DVD, VIDEO 2)

Luminance signal 1 Vp-p / 75 Ω

Chrominance signal 0.286 Vp-p / 75 Ω

COMPONENT VIDEO (DVD, VIDEO 2)

Luminance signal 1 Vp-p / 75 Ω

Cb/CR-signal 0.7 Vp-p / 75 Ω

Output level / impedance

Composite (VIDEO 1, MONITOR OUT) 1 Vp-p / 75 Ω

S VIDEO (MONITOR OUT)

Luminance signal 1 Vp-p / 75 Ω

Chrominance signal 0.286 Vp-p / 75 Ω

COMPONENT VIDEO (MONITOR OUT)

Luminance signal 1 Vp-p / 75 Ω

Cb/CR-signal 0.7 Vp-p / 75 Ω

FM tuner section

Tuning frequency range 87.5 MHz ~ 108 MHz

Usable sensitivity (DIN at 75 Ω)

MONO 1.3 μV / 13.2 dBf (40 kHz dev, S/N 26 dB)

STEREO 45 μV / 42.1 dBf (40 + 6 kHz dev, S/N 46 dB)

Total harmonic distortion (DIN at 1 kHz)

MONO 0.2% (71.2 dBf input)

STEREO 0.8% (71.2 dBf input)

Signal to noise ratio (DIN weighted at 1 kHz)

MONO 65 dB (71.2 dBf input)

STEREO 60 dB (71.2 dBf input)

Selectivity (DIN ±300 kHz) 64 dB

Stereo separation (1 kHz) 36 dB

Frequency response (30 Hz ~ 15kHz) +0.5 dB, -3.0 dB

AM tuner section

Tuning frequency range 531 kHz ~ 1,602 kHz

Usable sensitivity (30% mod, S/N 20 dB) 16 μV / (600 μV/m)

Signal to noise ratio (30% mod, 400 Hz)

..... 50 dB (60 dBμ V EMF input)

GENERAL

Power consumption 85 W

Dimensions W: 440 mm (17-5/16")

H : 79 mm (3-1/8")

D : 364 mm (14-5/16")

Weight (Net) 4.6 kg (10.1 lb)

Notes

- 1.KENWOOD follows a policy of continuous advancements in development. For this reason specifications may be changed without notice.
- 2.The full performance may not be exhibited in an extremely cold location (under a water-freezing temperature).

Firmware Update

IMPORTANT: Be sure to update the KENWOOD PC SERVER software to the latest version before updating the Firmware. 

The latest information and procedure to update your KENWOOD PC SERVER software and VRS-N8100 Firmware can be found in the "Technical Support" / "Service" section on the website of your resident country (if necessary you can find a link to your local website on www.kenwood.com <<http://www.kenwood.com>>).

Exit from all software that is currently running. Do not perform any other operations while performing the operations of steps 1 to 7, but perform the steps one after the other.

1 Turn on the power to this receiver by pressing the **POWER ON/STANDBY**  (For U.S.A. and Canada) or the **ON/STANDBY**  (For Europe and Australia) key (or the **POWER RCVR** key on the remote).

2 Use the **INPUT SELECTOR** key (or the **Network Server** key) to select **"NET SERVER"**.

When the **"NET SERVER"** input is selected, the OSD function on the TV screen is activated and detection of the server starts.



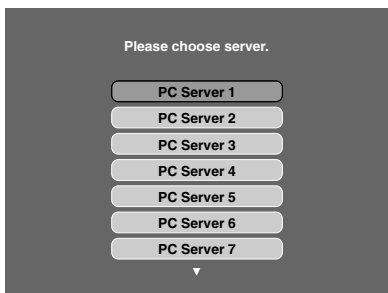

3 Use the **MULTI CONTROL**  (or **Multi**  keys) to select the PC server to be logged in, and press **ENTER** (or the **Enter** key).

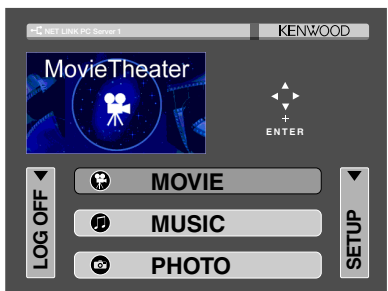

4 Use the **MULTI CONTROL**  (or the **Multi**  keys) to select **"SETUP"**, and press the **ENTER** (or the **Enter** key).

Home display



5 Use the **MULTI CONTROL**  (or the **Multi**  keys) to select **"Network Setup"**, and press the **ENTER** (or the **Enter** key).



6 Use the **MULTI CONTROL**  (or the **Multi**  keys) to select **"Firmware Update"** and press the **ENTER** (or the **Enter** key) to display the Update display.

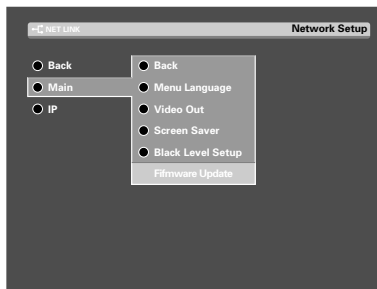

7 Select **"UPDATE"** and press the **ENTER** (or the **Enter** key) to start the updating.

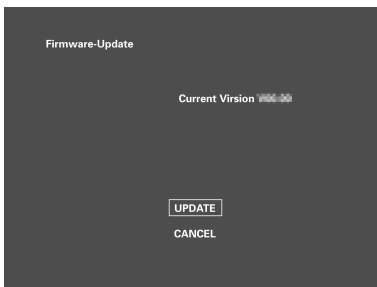

This unit turns OFF automatically when the firmware updating completes successfully.

- During update, don't turn off this unit, PC and router, or don't extract an Ethernet cable.
- When the update has been completed, **"UPDATE OK"** is displayed.
- If the update failed, **"ERROR"** is displayed on the screen.
- The update may fail and stop operating due to possible PC, network environment or power failure during the update process. In that case please remove the power cord from wall socket immediately and consult your dealer.

KENWOOD

For your records

Record the serial number, found on the back of the unit, in the spaces designated on the warranty card, and in the space provided below. Refer to the model and serial numbers whenever you call upon your dealer for information or service on this product.

Model _____ Serial Number _____

Free Manuals Download Website

<http://myh66.com>

<http://usermanuals.us>

<http://www.somanuals.com>

<http://www.4manuals.cc>

<http://www.manual-lib.com>

<http://www.404manual.com>

<http://www.luxmanual.com>

<http://aubethermostatmanual.com>

Golf course search by state

<http://golfingnear.com>

Email search by domain

<http://emailbydomain.com>

Auto manuals search

<http://auto.somanuals.com>

TV manuals search

<http://tv.somanuals.com>