

KENWOOD

SW-305

→ PAGE 2

SW-505D

→ PAGE 13

POWERED SUBWOOFER

INSTRUCTION MANUAL

KENWOOD CORPORATION

B61-1073-00 (EN)

Before applying power

 **Caution : Read this page carefully to ensure safe operation.**

SW-305 [EN]

2





Units are designed for operation as follows.

U.S.A. and Canada **AC 120 V only**

Europe and U.K. **AC 230 V only**

Safety precautions

WARNING : TO PREVENT FIRE OR ELECTRIC SHOCK, DO NOT EXPOSE THIS APPLIANCE TO RAIN OR MOISTURE.

| | | | |
|--|---|---------------------------------------|---|
|  <table border="1" data-bbox="263 1400 486 1478"><tr><td>CAUTION</td></tr><tr><td>RISK OF ELECTRIC SHOCK DO NOT OPEN</td></tr></table>  | CAUTION | RISK OF ELECTRIC SHOCK DO NOT OPEN | CAUTION: TO REDUCE THE RISK OF ELECTRIC SHOCK, DO NOT REMOVE COVER (OR BACK). NO USER-SERVICEABLE PARTS INSIDE. REFER SERVICING TO QUALIFIED SERVICE PERSONNEL. |
| CAUTION | | | |
| RISK OF ELECTRIC SHOCK DO NOT OPEN | | | |
|  | THE LIGHTNING FLASH WITH ARROWHEAD SYMBOL, WITHIN AN EQUILATERAL TRIANGLE, IS INTENDED TO ALERT THE USER TO THE PRESENCE OF UNINSULATED "DANGEROUS VOLTAGE" WITHIN THE PRODUCT'S ENCLOSURE THAT MAY BE OF SUFFICIENT MAGNITUDE TO CONSTITUTE A RISK OF ELECTRIC SHOCK TO PERSONS. | | |
|  | THE EXCLAMATION POINT WITHIN AN EQUILATERAL TRIANGLE IS INTENDED TO ALERT THE USER TO THE PRESENCE OF IMPORTANT OPERATING AND MAINTENANCE (SERVICING) INSTRUCTIONS IN THE LITERATURE ACCOMPANYING THE APPLIANCE. | | |

Introduction

Your choice of this product indicates that you are a devotee to excellence in sound reproduction.

We appreciate your patronage and take pride in the long tradition of quality components that our company represents.

So that you can get the most out of your unit, we suggest that you take the time to read through this manual before you hook up and operate your system. This will acquaint you with operating features and system-connection considerations so that your listening pleasure will be enhanced right from the start. You will notice that in all aspects of planning, engineering, styling, operating convenience and adaptability we have sought to anticipate your needs and desires.

Unpacking

Unpack the unit carefully and make sure that all accessories are put aside so they will not be lost.

Examine the unit for any possibility of shipping damage. If your unit is damaged or fails to operate, notify your dealer immediately. If your unit was shipped to you directly, notify the shipping company without delay. Only the consignee (the person or company receiving the unit) can file a claim against the carrier for shipping damage.

We recommend that you retain the original carton and packing materials for use should you transport or ship the unit in the future.

Keep this manual handy for future reference.

Accessories

Pin-plug cord (1)



Important Items

Maintenance of the unit

When the front panel or case becomes dirty, wipe with a soft, dry cloth. Do not use thinner, benzine, alcohol, etc. for these agents may cause discoloration.

In regard to contact cleaner

Do not use contact cleaners because it could cause a malfunction. Be specially careful not to use contact cleaners containing oil, for they may deform the plastic component.

Contents

Caution : Read the pages marked \triangle carefully to ensure safe operation.

| | |
|--|-----------|
| \triangle Before applying power | 2 |
| \triangle Safety precautions | 2 |
| Introduction | 3 |
| Important Items | 3 |
| IMPORTANT SAFEGUARDS | 4 |
| Installation | 6 |
| Connections | 7 |
| Controls and indicators | 10 |
| Sound adjustment | 11 |
| In case of difficulty | 11 |
| Specifications | 12 |

IMPORTANT SAFEGUARDS

 **Caution :** Read this page carefully to ensure safe operation.

SW-305 [EN]

4

Please read all of the safety and operating instructions before operating this appliance. Adhere to all warnings on the appliance and in the instruction manual. Follow all the safety and operating instructions. These safety and operating instructions should be retained for future reference.

1. Power sources – The appliance should be connected to a power supply only of the type described in the instruction manual or as marked on the appliance. If you are not sure of the type of power supply to your home, consult your appliance dealer or local power company. For appliances intended to operate from battery power, or other sources, refer to the instruction manual.

2. Power-cord protection – Power-supply cords should be routed so that they are not likely to be walked on or pinched by items placed upon or against them, pay particular attention to cords at plugs, convenience receptacles, and the point where they exit from the appliance.

Never pull or stretch the cord.

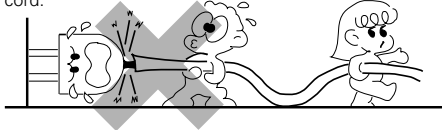

3. CAUTION – Polarization – This appliance may be equipped with a polarized alternating-current line plug (a plug having one blade wider than the other). This plug will fit into the power outlet only one way. This is a safety feature. If you are unable to insert the plug fully into the outlet, try reversing the plug. If the plug should still fail to fit, contact your electrician to replace your obsolete outlet. Do not defeat the safety purpose of the polarized plug.

4. Ventilation – Slots and openings in the cabinet are provided for ventilation and to ensure reliable operation of the appliance and to protect it from overheating, and these openings must not be blocked or covered. The appliance should be situated so that its location or position does not interfere with its proper ventilation.

To maintain good ventilation, do not put records or a table-cloth on the appliance. Place the appliance at least 10 cm away from the walls.

Do not use the appliance on a bed, sofa, rug or similar surface that may block the ventilation openings. This appliance should not be placed in a built-in installation such as a bookcase or rack unless proper ventilation is provided or the manufacturer's instructions have been adhered to.

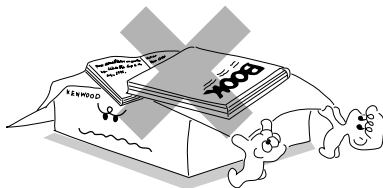

5. Water and moisture – The appliance should not be used near water - for example, near a bathtub, washbowl, kitchen sink, laundry tub, in a wet basement, or near a swimming pool, etc.

6. Temperature – The appliance may not function properly if used at extremely low, or freezing temperatures. The ideal ambient temperature is above +5°C (41°F).

7. Heat – The appliance should be situated away from heat sources such as radiators, heat registers, stoves, or other appliances (including amplifiers) that produce heat.

8. Electric shock – Care should be taken so that objects do not fall and liquid is not spilled into the enclosure through openings. If a metal objects, such as a hair pin or a needle, comes into contact with the inside of this appliance, a dangerous electric shock may result. For families with children, never permit children to put anything, especially metal, inside this appliance.

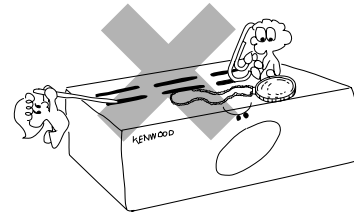

9. Enclosure removal – Never remove the enclosure. If the internal parts are touched accidentally, a serious electric shock might occur.

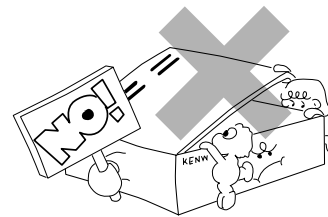

10. Magnetic fields – Keep the appliance away from sources of magnetic fields such as TV sets, speaker systems, radios, motorized toys or magnetized objects.

11. Cleaning – Unplug this appliance from the wall outlet before cleaning. Do not use volatile solvents such as alcohol, paint thinner, gasoline, or benzine, etc. to clean the cabinet. Use a clean dry cloth.

12. Accessories – Do not place this appliance on an unstable cart, stand, tripod, bracket, or table. The appliance may fall, causing serious injury to a child or adult, and serious damage to the appliance. Use only with a cart, stand, tripod, bracket, or table recommended by the manufacturer, or sold with the appliance. Any mounting of the appliance should follow the manufacturer's instructions, and should use a mounting accessory recommended by the manufacturer. An appliance and cart combination should be moved with care. Quick stops, excessive force, and uneven surfaces may cause the appliance and cart combination to overturn.



13. Lightning – For added protection for this appliance during a lightning storm, or when it is left unattended and unused for long periods of time, unplug it from the wall outlet and disconnect the antenna or cable system. This will prevent damage to the appliance due to lightning and power-line surges.

14. Abnormal smell – If an abnormal smell or smoke is detected, immediately turn the power OFF and unplug the appliance from the wall outlet. Contact your dealer or nearest service center.

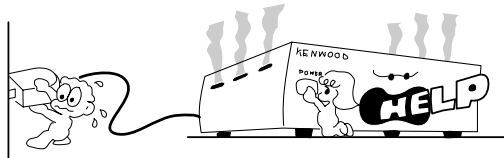

15. Damage requiring service – The appliance should be serviced by qualified service personnel when:

- A. The power-supply cord or the plug has been damaged.
- B. Objects have fallen, or liquid has been spilled into the appliance.
- C. The appliance has been exposed to rain or water.
- D. The appliance does not appear to operate normally by following the instruction manual. Adjust only those controls that are covered by the instruction manual as an improper adjustment of other controls may result in damage and will often require extensive work by a qualified technician to restore the appliance to its normal operation.
- E. The appliance has been dropped, or the enclosure damaged.
- F. The appliance exhibits a marked change in performance.

16. Servicing – The user should not attempt to service the appliance beyond that described in the instruction manual. All other servicing should be referred to qualified service personnel.

17. Outdoor antenna grounding – If an outside antenna is connected to the appliance, be sure the antenna system is grounded so as to provide some protection against voltage surges and built up static charges. Article 810 of the National Electrical Code ANSI/NFPA 70, provides information with respect to proper grounding of the mast and supporting structure, grounding of the lead-in wire to an antenna discharge unit, size of grounding conductors, location of antenna discharge unit, connection to grounding electrodes, and requirements for the grounding electrode. See Figure.

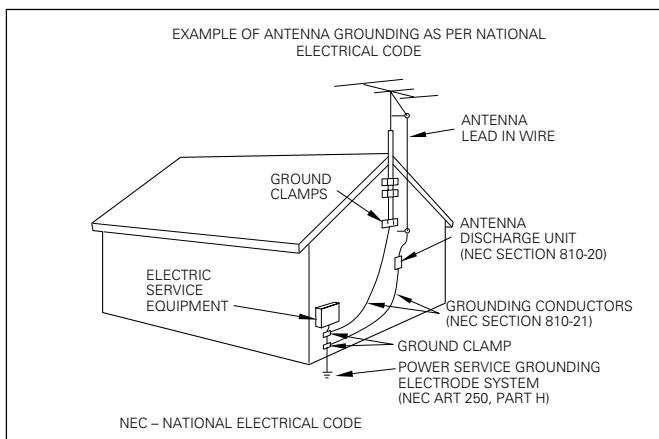

18. Power lines – An outside antenna system should not be located in the vicinity of overhead power lines or other electric light or power circuits, or where it can fall into such power lines or circuits. When installing an outside antenna system, extreme care should be taken to keep from touching such power lines or circuits as contact with them might be fatal.

19. AC outlets – Do not connect other audio equipment with a power consumption larger than that specified to the AC outlet on the rear panel. Never connect other electrical appliances, such as an iron or toaster, to it to prevent fire or electric shock.

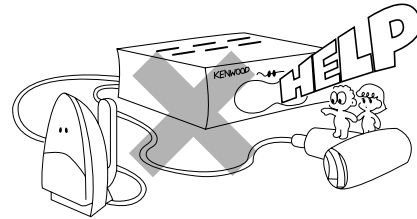

20. Overloading – Do not overload wall outlets, extension cords, or integral convenience receptacles as this can result in a risk of fire or electric shock.

21. Attachment – Do not use attachments not recommended by the appliance manufacturer as they may cause hazards.

22. Replacement parts – When replacement parts are required, be sure the service technician has used replacement parts specified by the manufacturer or have the same characteristics as the original parts. Unauthorized substitutions may result in fire, electric shock, or other hazards.

23. Safety check – Upon completion of any service or repairs to this appliance, ask the service technician to perform safety checks to determine that the appliance is in proper operating condition.

Notes:

- 1. Item 3 is not required except for grounded or polarized equipment.
- 2. Item 17 and 18 are not required except for units provided with antenna terminals.
- 3. Item 17 complies with UL in the U.S.A.

The Subwoofer is a virtually omnidirectional speaker, so it can be installed in almost any location. For example, the Subwoofer can be installed next to the component system (consisting of an amplifier, tuner, cassette deck, etc.), or in a corner of the room, etc. The Subwoofer's deep-bass reproduction characteristics are richest when the Subwoofer is installed in a corner or near a wall. Since the low-bass component in music is usually monaural, only one Subwoofer is necessary to obtain a sufficient stereo effect when used in combination with a stereo music system.

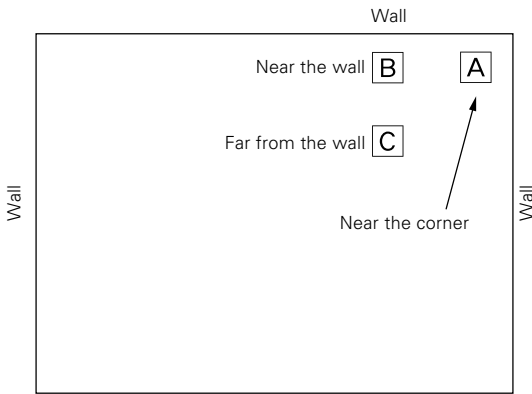

Speaker installation position, viewed from above

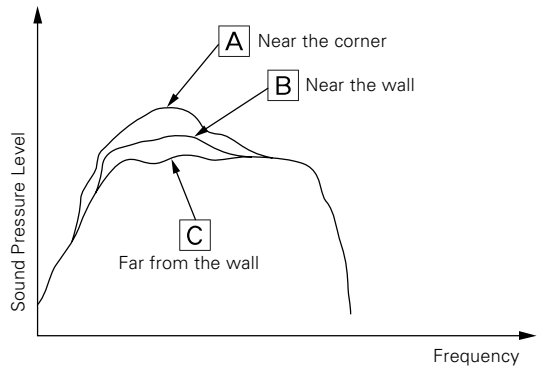

Except for U.S.A. and Canada

CAUTION

Be sure to adhere followings. Or proper ventilation will be blocked causing damage or fire hazard.

- Do not place any objects impairing heat radiation onto the top of unit.
- Leave a space around the unit (from the largest outside dimension including projection) equal or greater than, shown below.

- Top panel : 50 cm
- Side panel : 10 cm
- Back panel : 10 cm

For U.S.A. and Canada

CAUTION

Be sure to adhere followings. Or proper ventilation will be blocked causing damage or fire hazard.

- Do not place any objects impairing heat radiation onto the top of unit.

Howling

If the Subwoofer is installed near an analog record turntable, a howling sound may be generated. If this occurs, place the Subwoofer farther away from the turntable or reduce the Subwoofer volume (By rotating the VOLUME CONTROL counterclock-wise). The howling phenomenon may also occur due to cross interference with a cassette deck, compact disc player, or Laserdisc player, although this is very rare. If sound or picture seems to be distorted due to this reason, place the Subwoofer farther away from other components or reduce its volume.

Operation near a TV

If the Subwoofer is installed too close to a TV, color irregularities may be observed on the TV screen. If such irregularities occur, switch the power of the TV to OFF and then switch it ON again after waiting for a period of 15 to 30 minutes. The influence of the Subwoofer on the TV picture may be improved by self-demagnetization of the TV set. If the color irregularities still persist, move the Subwoofer farther away from the TV.

Input/output terminals

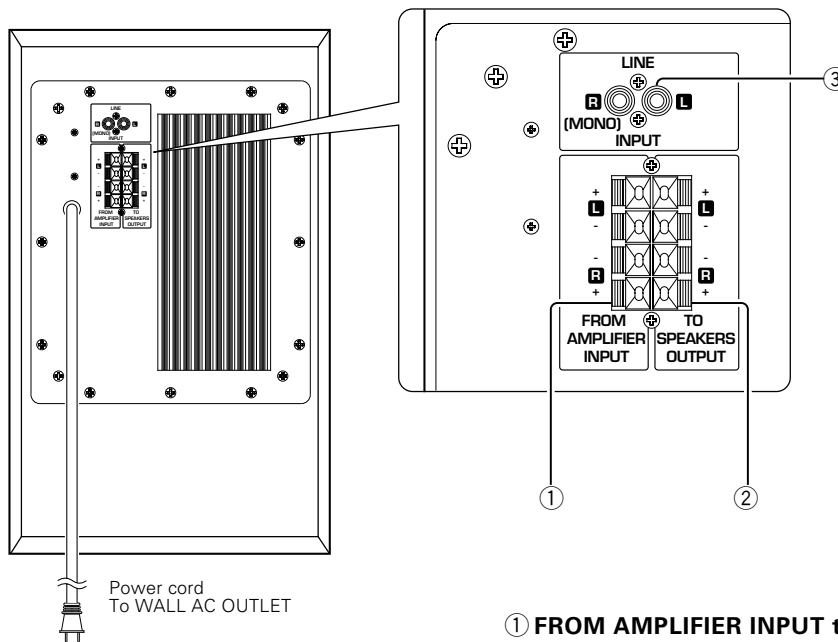

- ① **FROM AMPLIFIER INPUT terminals**
These terminals are used to connect the FRONT SPEAKER terminals of the amplifier to this unit.
- ② **TO SPEAKERS OUTPUT terminals**
- ③ **LINE jacks (RCA-type pin-plug)**
These jacks are used to connect the Subwoofer Pre-Out jacks of the amplifier.

If the amplifier is equipped with a Subwoofer Pre-Out jack

Before connection: Set the **POWER** switches of the amplifier and Subwoofer to **OFF**. If they are connected with the **POWER** switch(es) left **ON**, one or both components may be damaged.

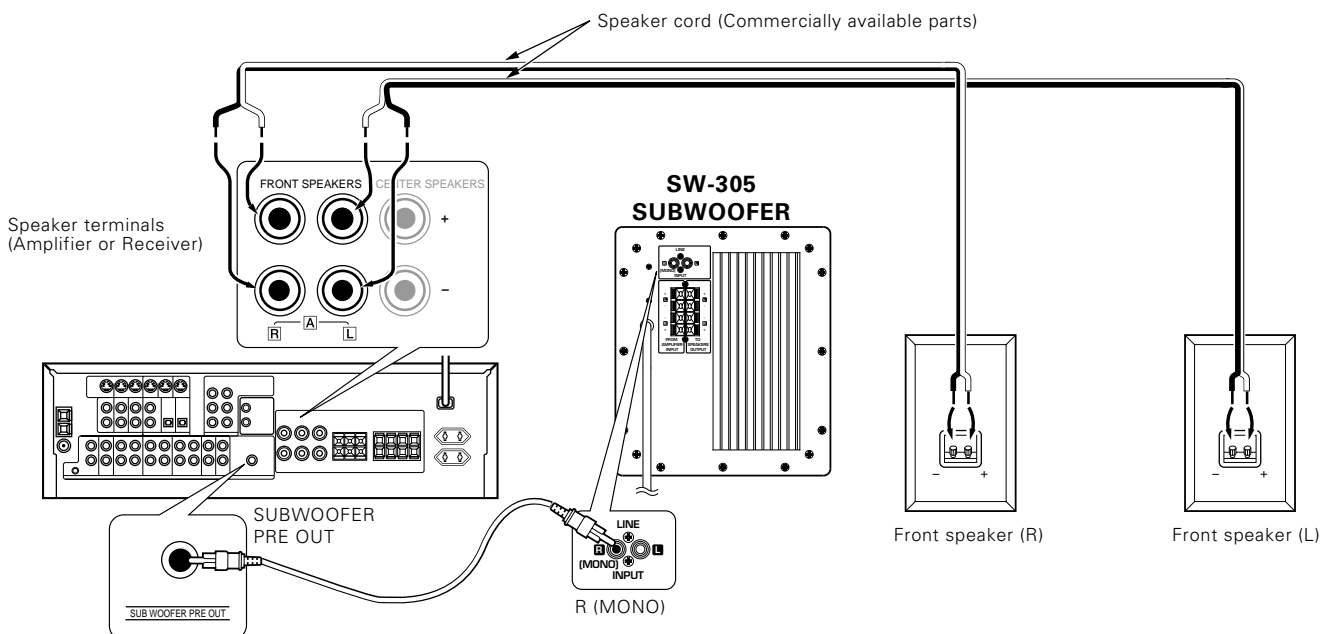

If the amplifier is not equipped with a Subwoofer Pre-Out jack or if two subwoofers are to be used

Before connection: Set the POWER switches of the amplifier and Subwoofer to OFF. If they are connected with the POWER switch(es) left ON, one or both components may be damaged.

When connecting the Subwoofer to the amplifier, be sure to always connect the "+" terminals to "+" terminals and the "-" terminals to "-" terminals. If terminals are connected incorrectly, the amplifier may be damaged.

Note Speaker cords are not supplied, Please use a speaker cords with thick conductor.

Using one subwoofer

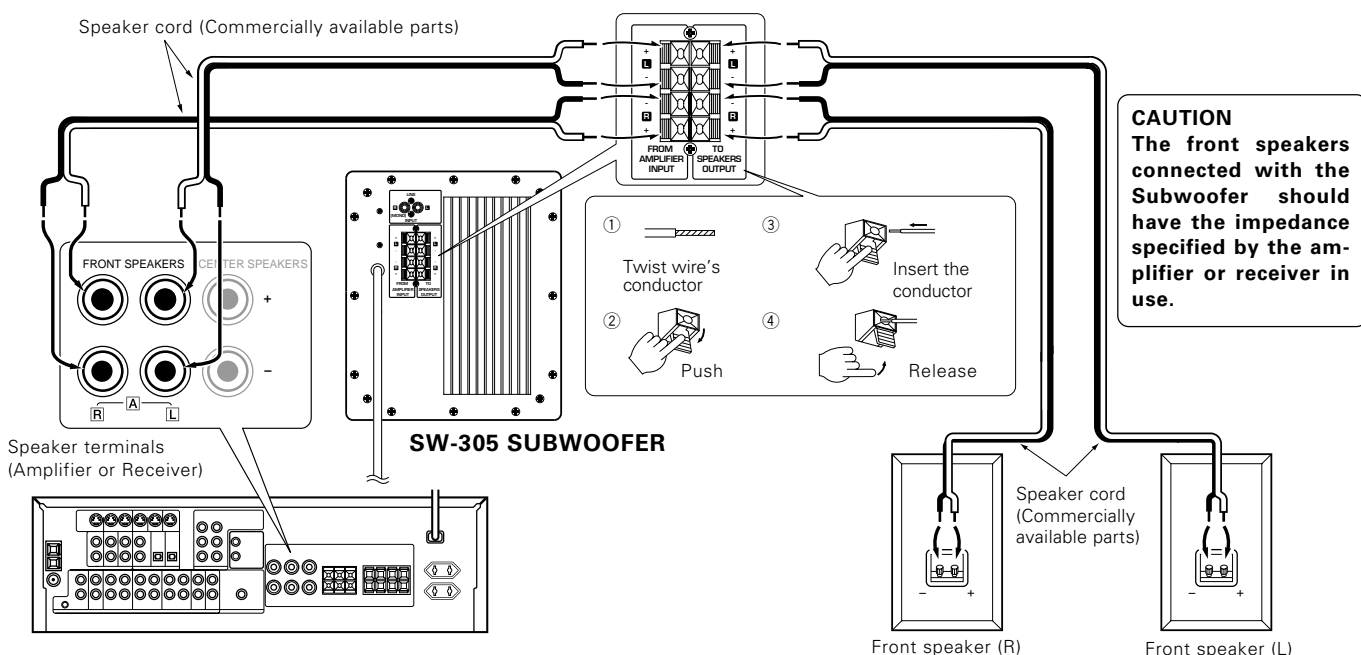

Using two subwoofers

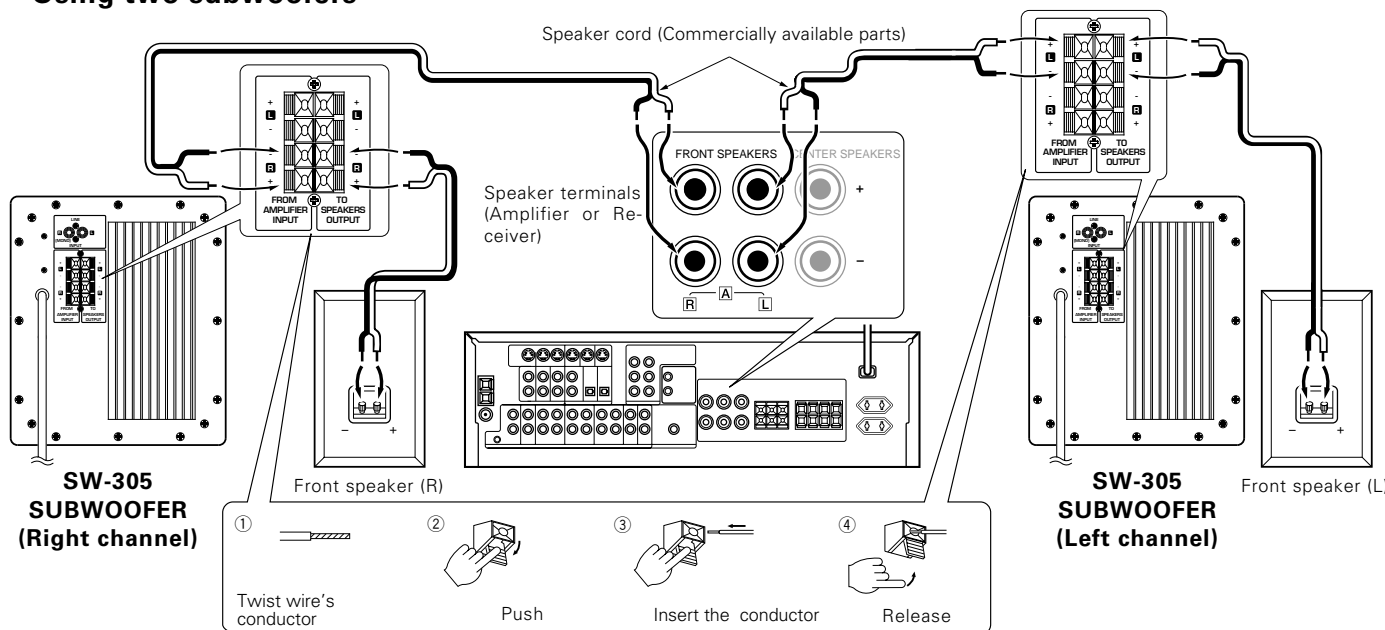

CAUTION
The front speakers connected with the Subwoofer should have the impedance specified by the amplifier or receiver in use.

Note When the amplifier has two stereo speaker output circuits which can output signals simultaneously, the front speakers do not have to be connected through the subwoofer(s) but can be connected directly to the amplifier, whether the number of subwoofers used is one or two.

Using the Pre-Out jacks

Before connection: Set the POWER switches of the amplifier and Subwoofer to OFF. If they are connected with the POWER switch(es) left ON, one or both components may be damaged.

When connecting the Subwoofer to the amplifier, be sure to always connect the "+" terminals to "+" terminals and the "-" terminals to "-" terminals. If terminals are connected incorrectly, the amplifier may be damaged.

Using one subwoofer

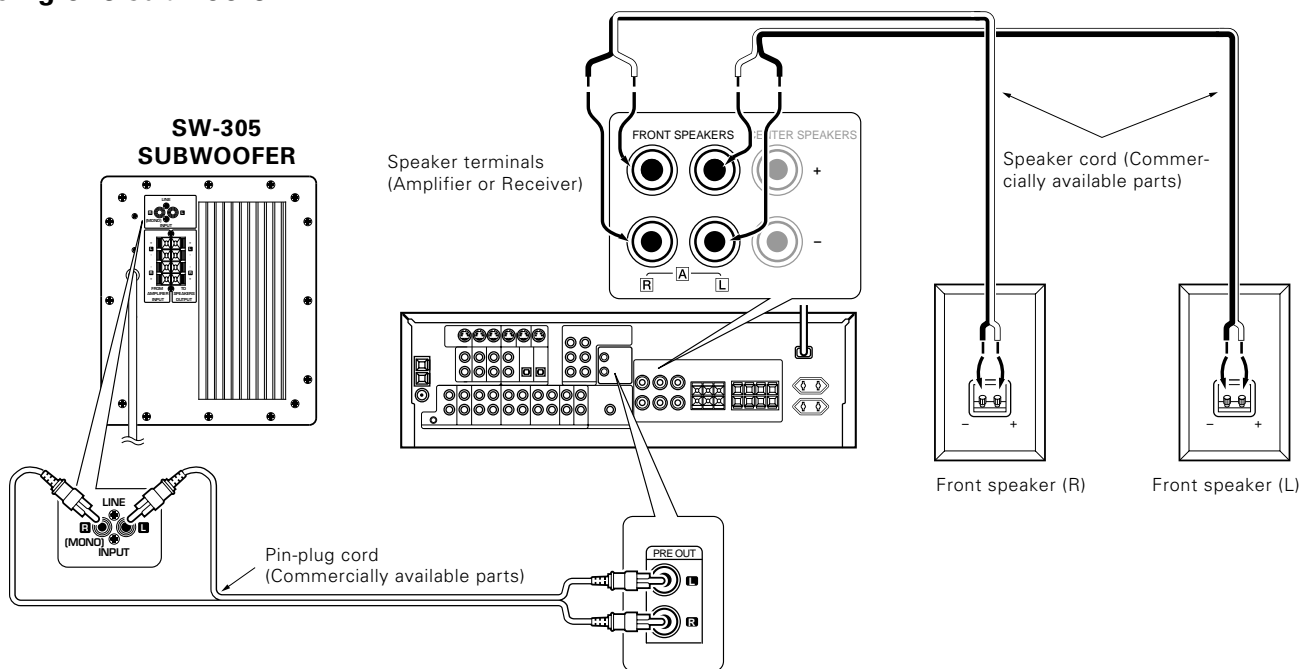

Using two subwoofers

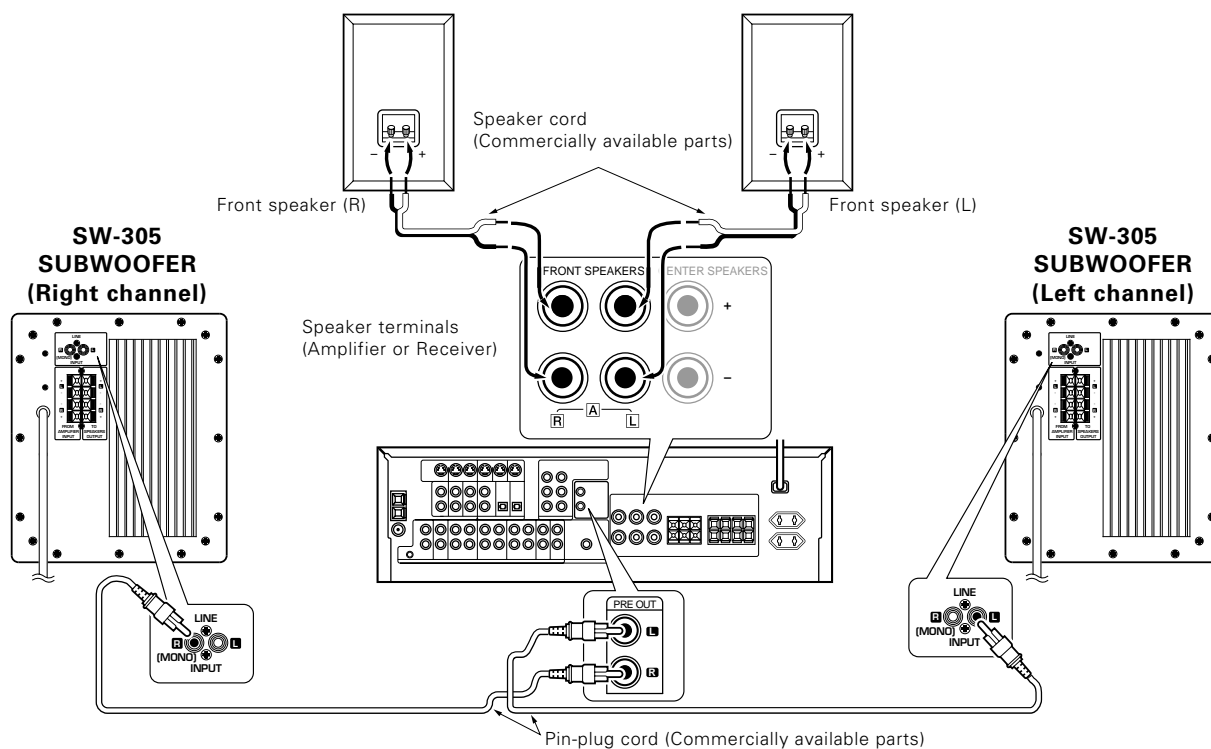

The subwoofer(s) can also be connected to the REC OUT or LINE OUT jacks of the amplifier in the same way as above. In this case, however, the volume of the subwoofer(s) cannot be interlocked with the amplifier volume. (Every time the amplifier volume is varied, the subwoofer volume should also be varied.)

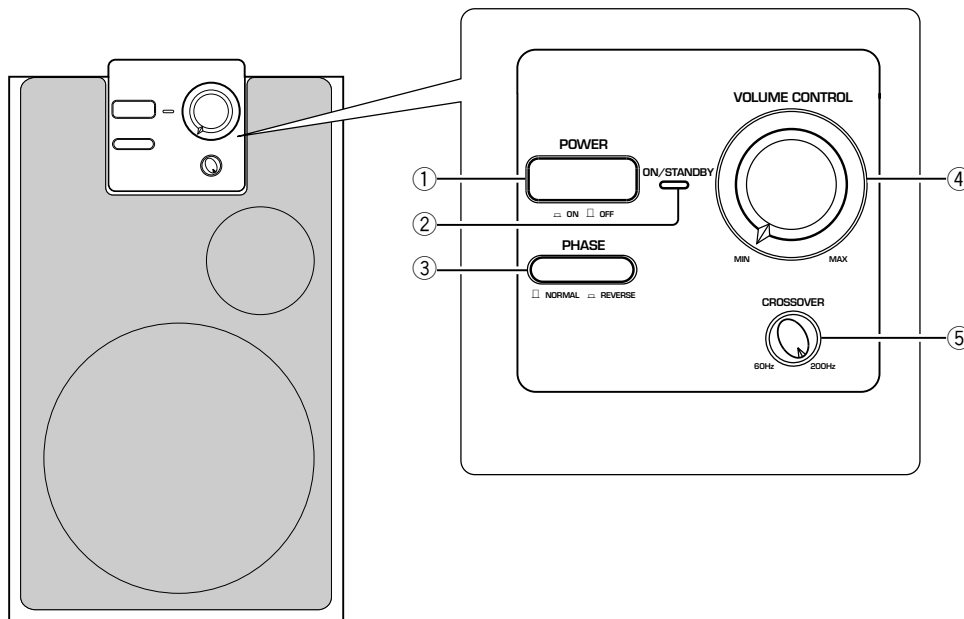

① POWER switch

Press to switch the power to the Subwoofer ON/OFF.

② ON/STANDBY indicator

Lights up according to the operation modes of this unit as described below.

Green Power ON (Operating status)

Amber Standby mode initiated by Auto Shut-off function

Extinguished Power OFF or power supply failure

Auto Shut-off.

The Subwoofer automatically returns to STANDBY mode (amber light) when no signal has been input for about 8 minutes.

When standby is initiated by Auto Shut-off:

The unit turns ON (operating status) again in a few seconds after a signal is input.

③ PHASE selector switch



Press to switch the phase of the sound output from the Subwoofer.

④ VOLUME CONTROL knob



Adjusts the volume level of the output of the Subwoofer. Rotating the knob clockwise increases the volume level, and rotating the knob counterclockwise decreases the volume level.

⑤ CROSSOVER control knob



Turn the control knob to adjust the cutoff frequency of the high-frequency components in the sound output from the Subwoofer.

Standby mode

When the STANDBY indicator is lit amber, it indicates that the power of the unit is in the Standby mode.

In the Standby mode, the audio output is cut off in order to prevent unnecessary noise from the subwoofer when no signal is input to it.

If the subwoofer is not to be used, turn its power off by pressing the POWER switch.

Caution concerning operation

An excessive input level to the Subwoofer may impair the sound quality or damage the unit. Careful attention should therefore be paid to the following precautions.

1. Do not increase the output of the amplifier to a high level while the low-frequency level is enhanced by the amplifier's tone control or loudness control.

2. When operating the amplifier switches or when placing the stylus on an analog record, set the amplifier volume to its minimum level.

How to use the VOLUME CONTROL knob, PHASE selector switch, CROSSOVER control knob

The VOLUME CONTROL knob, PHASE selector switch and CROSSOVER control knob can be adjusted to match the condition of the listening room and/or the characteristics of the left and right front speakers.

CROSSOVER control knob function

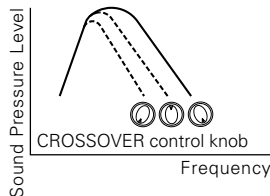

The characteristics above express the images and the details are different from the actual characteristics.

Examples of standard adjustment according to the type of front speakers

Crossover frequency adjustment (CROSSOVER control knob)

| Front speaker | Crossover Frequency |
|----------------|---------------------|
| Small speaker | 120 ~ 200 Hz |
| Medium speaker | 80 ~ 120 Hz |
| Large speaker | 60 ~ 80 Hz |

Depending on the listening room condition and the front speaker characteristics, other adjustment setting than the examples shown above may provide more natural bass sound and more effective bass reproduction. Try various adjustment settings to select the optimum one for your listening room.

In case of difficulty

A simple mistake may often be misunderstood as a failure. In case of a trouble, check the applicable symptom in the following table before calling for service.

| Symptom | Cause | Remedy |
|-----------------------------|--|---|
| No sound is output. | <ul style="list-style-type: none"> The connection cords are not plugged into the jacks properly. The volume is set to the minimum. The connected amplifier or receiver does not output the subwoofer pre-out signal (applicable when the amplifier or receiver is equipped with the pre-out on/off function). | <ul style="list-style-type: none"> Connect them properly by referring to "Connections". → 7 Adjust to an optimum volume. → 10 Switch the subwoofer pre-out switch of the connected amplifier or receiver to ON. |
| Sound volume is low. | <ul style="list-style-type: none"> The speaker cords are connected in the reverse phase. The phase selection is not correct. The pre-out signal level of the connected amplifier or receiver is set to the minimum (applicable when the amplifier or receiver is equipped with the pre-out level control function). | <ul style="list-style-type: none"> Connect the R and L cords with correct + and - polarity by referring to "Connections". → 7 Set the PHASE switch to a different phase. → 10 Adjust the pre-out level of the connected amplifier or receiver to an optimum level. |

Type **Subwoofer system with built-in amplifier
(Magnetically shielded)**

[Amplifier]

Rated Output Power **100 W RMS 30 Hz ~ 200 Hz, 4 Ω**

Phase Switching **NORMAL, REVERSE**

Input Sensitivity & Input Impedance

RCA-type pin-plug jack **100 mV /12 kΩ**

200 mV /12 kΩ (MONO Input)

Push-type terminals **1.7 V /15 kΩ**

[Speaker]

Enclosure **Bass-Reflex, Floor Standing Type**

Speaker Unit **200 mm (8") Cone type**

Nominal Impedance **4 Ω**

[General]

Rated Power Consumption **90 W**

Dimensions **Width : 250 mm (9-13/16")**

Height : 422 mm (16-5/8")

Depth : 408 mm (16-1/16")

Net Weight **12.2 kg (26.9 lb)**



KENWOOD follows a policy of continuous advancements in development. For this reason specifications may be changed without notice.

- Sufficient performance may not be exhibited at extremely cold locations (where water freezes).

KENWOOD

SW-505D

POWERED SUBWOOFER

INSTRUCTION MANUAL

KENWOOD CORPORATION

B61-1183-00 (EN)

Before applying power

 **Caution : Read this page carefully to ensure safe operation.**

SW-505D (EN)

14





Units are designed for operation as follows.

U.S.A. and Canada AC 120 V only

Europe AC 230 V only

Safety precautions

WARNING : TO PREVENT FIRE OR ELECTRIC SHOCK, DO NOT EXPOSE THIS APPLIANCE TO RAIN OR MOISTURE.

| | | | |
|--|---|---------------------------------------|---|
|  <table border="1" data-bbox="263 1400 486 1489"><tr><td>CAUTION</td></tr><tr><td>RISK OF ELECTRIC SHOCK DO NOT OPEN</td></tr></table>  | CAUTION | RISK OF ELECTRIC SHOCK DO NOT OPEN | CAUTION: TO REDUCE THE RISK OF ELECTRIC SHOCK, DO NOT REMOVE COVER (OR BACK). NO USER-SERVICEABLE PARTS INSIDE. REFER SERVICING TO QUALIFIED SERVICE PERSONNEL. |
| CAUTION | | | |
| RISK OF ELECTRIC SHOCK DO NOT OPEN | | | |
|  | THE LIGHTNING FLASH WITH ARROWHEAD SYMBOL, WITHIN AN EQUILATERAL TRIANGLE, IS INTENDED TO ALERT THE USER TO THE PRESENCE OF UNINSULATED "DANGEROUS VOLTAGE" WITHIN THE PRODUCT'S ENCLOSURE THAT MAY BE OF SUFFICIENT MAGNITUDE TO CONSTITUTE A RISK OF ELECTRIC SHOCK TO PERSONS. | | |
|  | THE EXCLAMATION POINT WITHIN AN EQUILATERAL TRIANGLE IS INTENDED TO ALERT THE USER TO THE PRESENCE OF IMPORTANT OPERATING AND MAINTENANCE (SERVICING) INSTRUCTIONS IN THE LITERATURE ACCOMPANYING THE APPLIANCE. | | |

Introduction

Your choice of this product indicates that you are a devotee to excellence in sound reproduction.

We appreciate your patronage and take pride in the long tradition of quality components that our company represents.

So that you can get the most out of your unit, we suggest that you take the time to read through this manual before you hook up and operate your system. This will acquaint you with operating features and system-connection considerations so that your listening pleasure will be enhanced right from the start. You will notice that in all aspects of planning, engineering, styling, operating convenience and adaptability we have sought to anticipate your needs and desires.

Unpacking

Unpack the unit carefully and make sure that all accessories are put aside so they will not be lost.

Examine the unit for any possibility of shipping damage. If your unit is damaged or fails to operate, notify your dealer immediately. If your unit was shipped to you directly, notify the shipping company without delay. Only the consignee (the person or company receiving the unit) can file a claim against the carrier for shipping damage.

We recommend that you retain the original carton and packing materials for use should you transport or ship the unit in the future.

Keep this manual handy for future reference.

Accessories

Pin-plug cord (1)

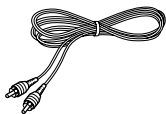

Batteries (R03/ AAA)

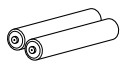

Remote control unit (1)

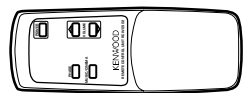

Important Items

For the U.S.A.

FCC WARNING

This equipment may generate or use radio frequency energy. Changes or modifications to this equipment may cause harmful interference unless the modifications are expressly approved in the instruction manual. The user could lose the authority to operate this equipment if an unauthorized change or modification is made.

NOTE:

This equipment has been tested and found to comply with the limits for a Class B digital device, pursuant to Part 15 of the FCC Rules. These limits are designed to provide reasonable protection against harmful interference in a residential installation. This equipment may cause harmful interference to radio communications, if it is not installed and used in accordance with the instructions. However, there is no guarantee that interference will not occur in a particular installation. If this equipment does cause harmful interference to radio or television reception, which can be determined by turning the equipment off and on, the user is encouraged to try to correct the interference by one or more of the following measures:

- Reorient or relocate the receiving antenna.
- Increase the separation between the equipment and receiver.
- Connect the equipment into an outlet on a circuit different from that to which the receiver is connected.
- Consult the dealer or an experienced radio / TV technician for help.

Maintenance of the unit

When the front panel or case becomes dirty, wipe with a soft, dry cloth. Do not use thinner, benzine, alcohol, etc. for these agents may cause discoloration.

In regard to contact cleaner

Do not use contact cleaners because it could cause a malfunction. Be specially careful not to use contact cleaners containing oil, for they may deform the plastic component.

Contents

Caution : Read the pages marked \triangle carefully to ensure safe operation.

| | |
|--|-----------|
| \triangle Before applying power | 14 |
| \triangle Safety precautions | 14 |
| Introduction | 15 |
| Important Items | 15 |
| Installation | 16 |
| Connections | 17 |
| Controls and indicators | 20 |
| Remote control operation | 21 |
| Sound adjustment | 22 |
| In case of difficulty | 22 |
| Specifications | 23 |

The Subwoofer is a virtually omnidirectional speaker, so it can be installed in almost any location. For example, the Subwoofer can be installed next to the component system (consisting of an amplifier, tuner, cassette deck, etc.), or in a corner of the room, etc. The Subwoofer's deep-bass reproduction characteristics are richest when the Subwoofer is installed in a corner or near a wall. Since the low-bass component in music is usually monaural, only one Subwoofer is necessary to obtain a sufficient stereo effect when used in combination with a stereo music system.

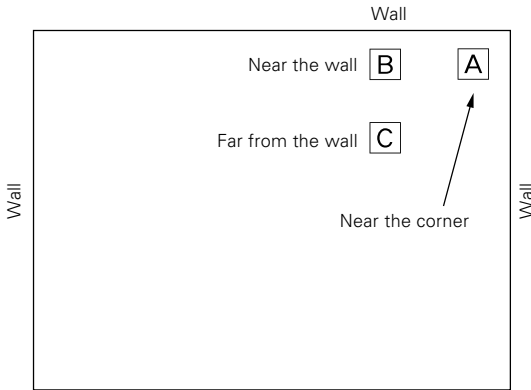

Speaker installation position, viewed from above

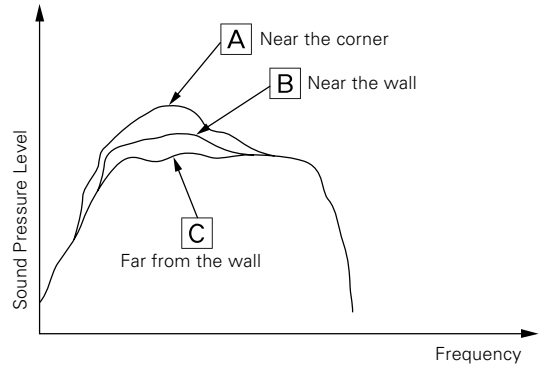

Except for U.S.A. and Canada

CAUTION

Be sure to adhere followings. Or proper ventilation will be blocked causing damage or fire hazard.

- Do not place any objects impairing heat radiation onto the top of unit.
- Leave a space around the unit (from the largest outside dimension including projection) equal or greater than, shown below.

- Top panel : 50 cm
- Side panel : 10 cm
- Back panel : 10 cm

For U.S.A. and Canada

CAUTION

Be sure to adhere followings. Or proper ventilation will be blocked causing damage or fire hazard.

- Do not place any objects impairing heat radiation onto the top of unit.

Howling

If the Subwoofer is installed near an analog record turntable, a howling sound may be generated. If this occurs, place the Subwoofer farther away from the turntable or reduce the Subwoofer volume (By rotating the VOLUME CONTROL counterclock-wise). The howling phenomenon may also occur due to cross interference with a cassette deck, compact disc player, or Laserdisc player, although this is very rare. If sound or picture seems to be distorted due to this reason, place the Subwoofer farther away from other components or reduce its volume.

Interference in radio broadcasts

This unit employs digital circuitry to amplify signals with high efficiency. As a result, when a radio receiver such as an audio receiver or tuner is installed near this unit, the reception may be interfered with by noise. In such a case, install this unit and radio receiver at a larger distance.

- If the radio reception is still interfered with by noise even when the power of this unit is switched off or the volume is minimized, the interference is not due to this unit.
- When the indoor antenna of the audio receiver or tuner can be installed apart from this unit, install the antenna as apart as possible from this unit. Also distribute the antenna cable as apart as possible from this unit.

Operation near a TV

If the Subwoofer is installed too close to a TV, color irregularities may be observed on the TV screen. If such irregularities occur, switch the power of the TV to OFF and then switch it ON again after waiting for a period of 15 to 30 minutes. The influence of the Subwoofer on the TV picture may be improved by self-demagnetization of the TV set. If the color irregularities still persist, move the Subwoofer farther away from the TV.

Input/output terminals

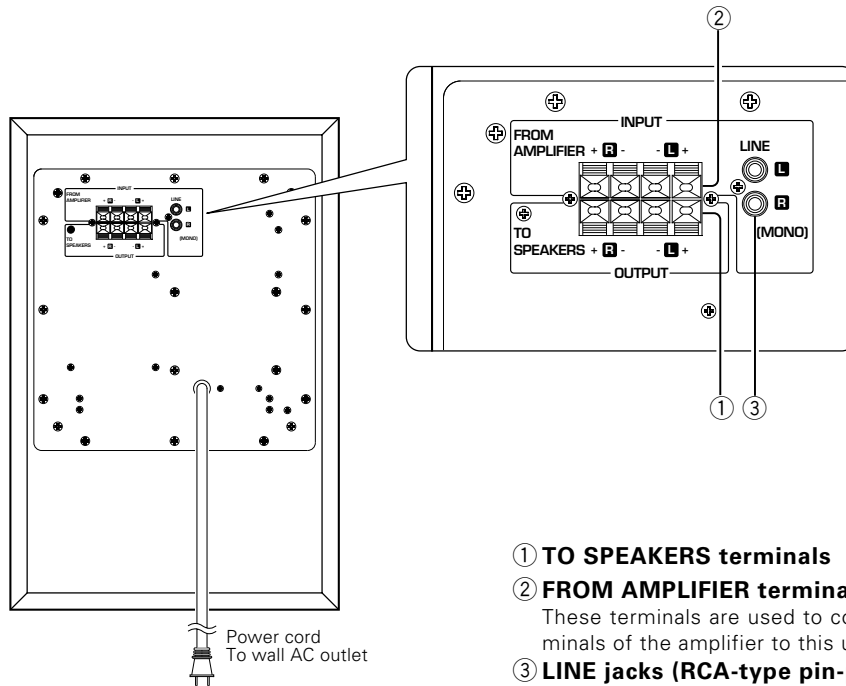

- ① **TO SPEAKERS terminals**
- ② **FROM AMPLIFIER terminals**
These terminals are used to connect the FRONT SPEAKER terminals of the amplifier to this unit.
- ③ **LINE jacks (RCA-type pin-plug)**
These jacks are used to connect the Subwoofer Pre-Out jacks of the amplifier.

If the amplifier is equipped with a Subwoofer Pre-Out jack

Before connection: Set the POWER switches of the amplifier and Subwoofer to OFF. If they are connected with the POWER switch(es) left ON, one or both components may be damaged.

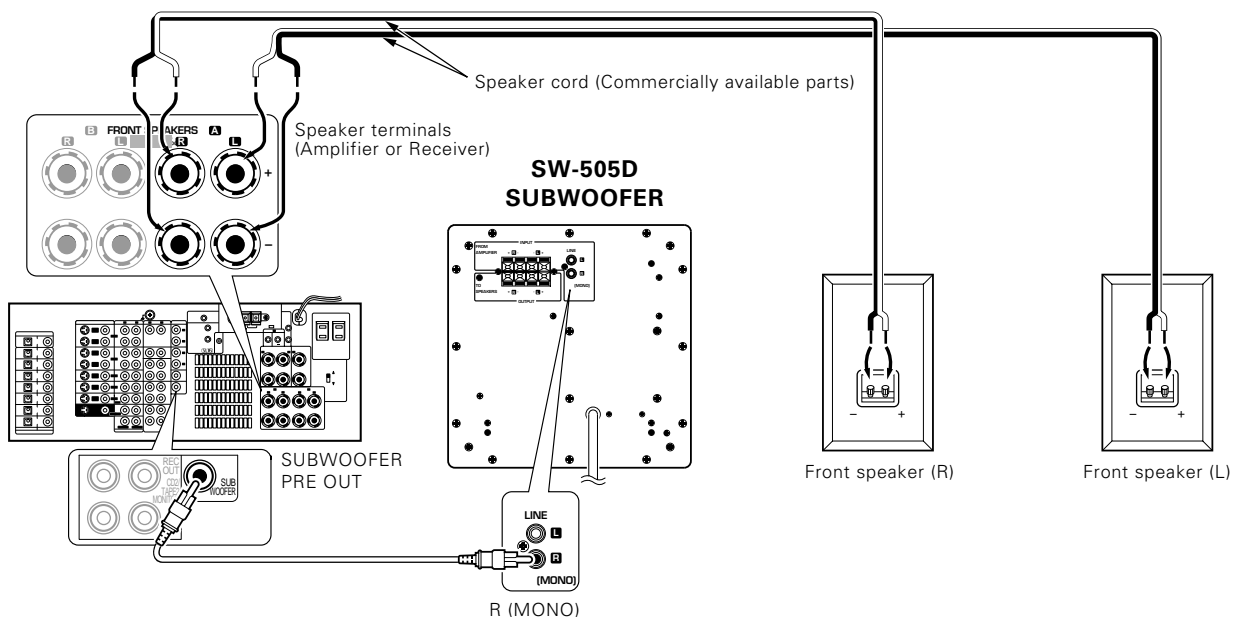

If the amplifier is not equipped with a Subwoofer Pre-Out jack or if two subwoofers are to be used

Before connection: Set the POWER switches of the amplifier and Subwoofer to OFF. If they are connected with the POWER switch(es) left ON, one or both components may be damaged.

When connecting the Subwoofer to the amplifier, be sure to always connect the "+" terminals to "+" terminals and the "-" terminals to "-" terminals. If terminals are connected incorrectly, the amplifier may be damaged.

Note Speaker cords are not supplied, Please use a speaker cords with thick conductor.

Using one subwoofer

Speaker cord (Commercially available parts)

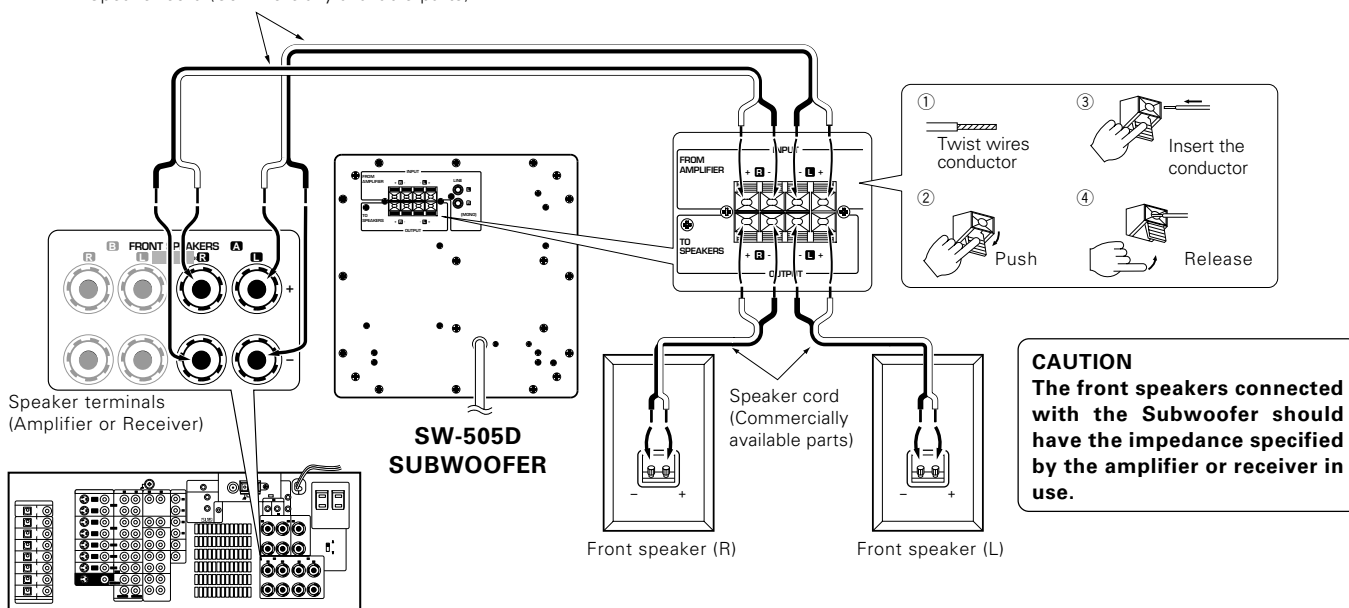

Using two subwoofers

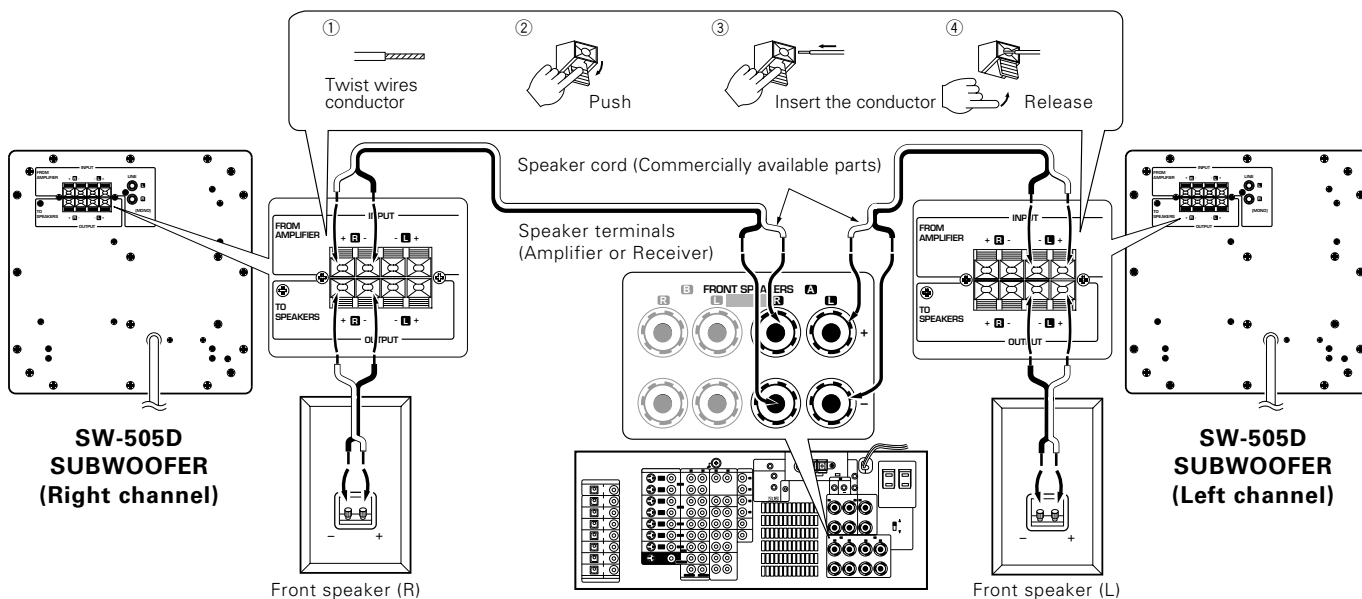

CAUTION
The front speakers connected with the Subwoofer should have the impedance specified by the amplifier or receiver in use.

Note When the amplifier has two stereo speaker output circuits which can output signals simultaneously, the front speakers do not have to be connected through the subwoofer(s) but can be connected directly to the amplifier, whether the number of subwoofers used is one or two.

Using the Pre-Out jacks

Before connection: Set the POWER switches of the amplifier and Subwoofer to OFF. If they are connected with the POWER switch(es) left ON, one or both components may be damaged.

When connecting the Subwoofer to the amplifier, be sure to always connect the "+" terminals to "+" terminals and the "-" terminals to "-" terminals. If terminals are connected incorrectly, the amplifier may be damaged.

Using one subwoofer

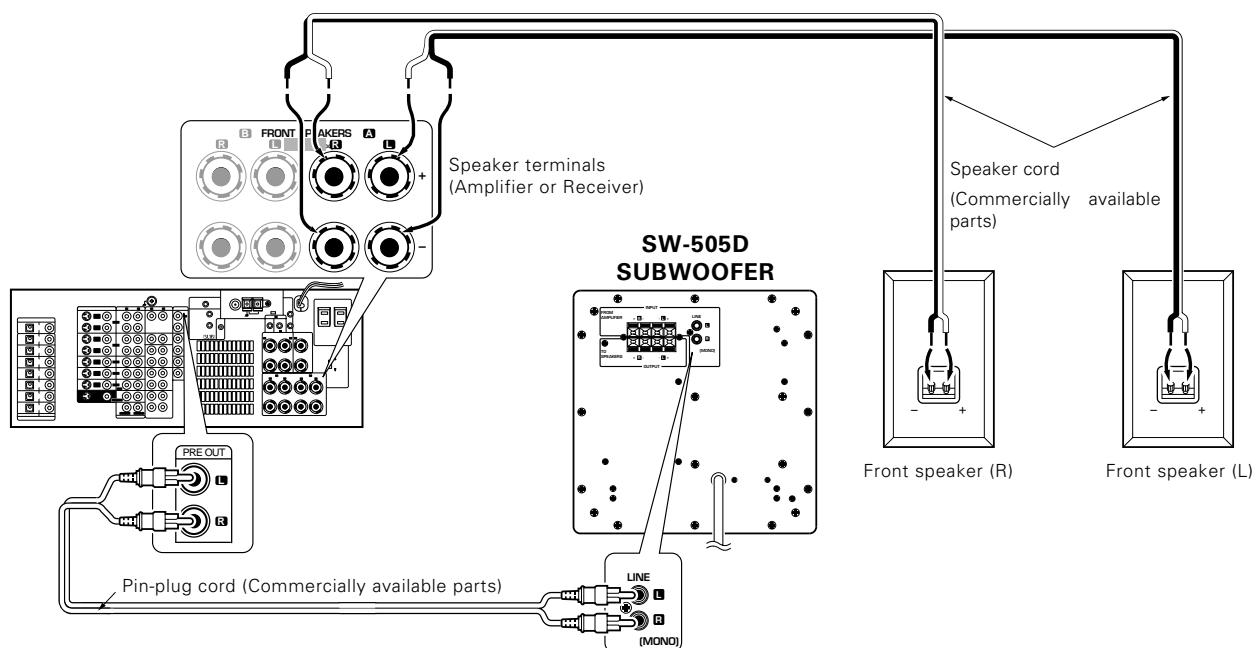

Using two subwoofers

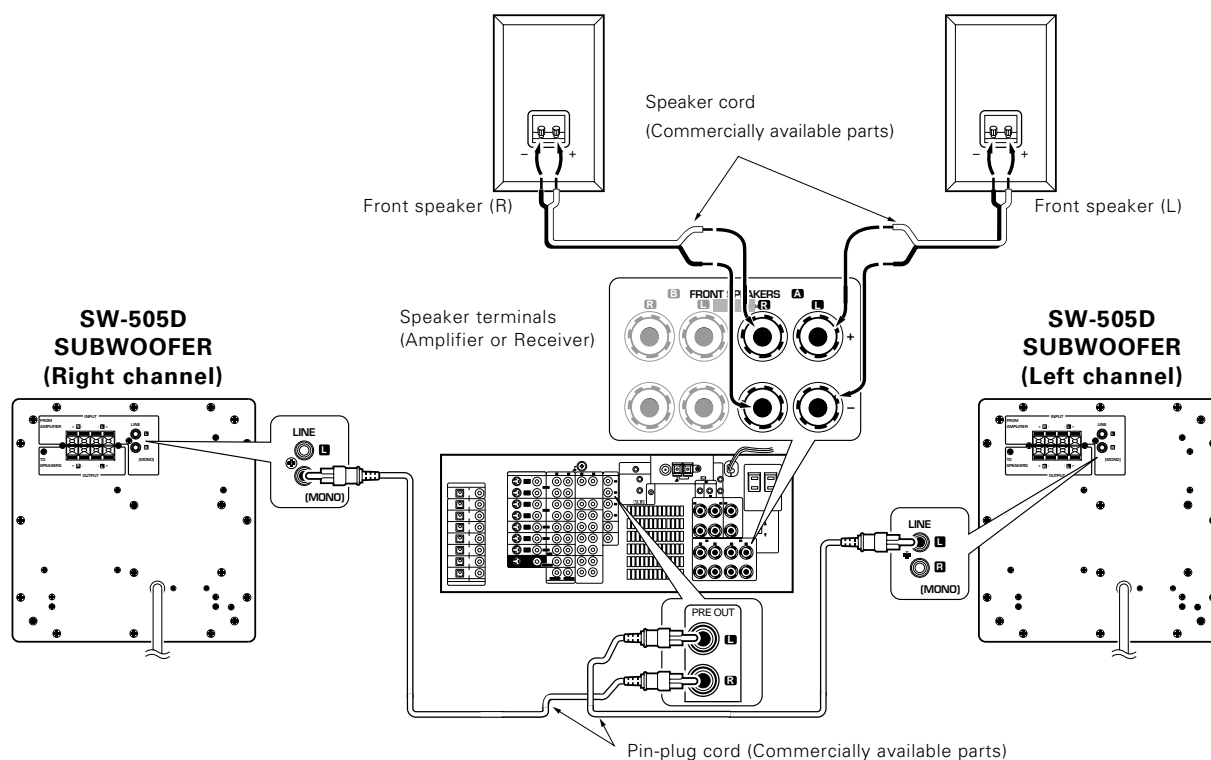

The subwoofer(s) can also be connected to the REC OUT or LINE OUT jacks of the amplifier in the same way as above. In this case, however, the volume of the subwoofer(s) cannot be interlocked with the amplifier volume. (Every time the amplifier volume is varied, the subwoofer volume should also be varied.)

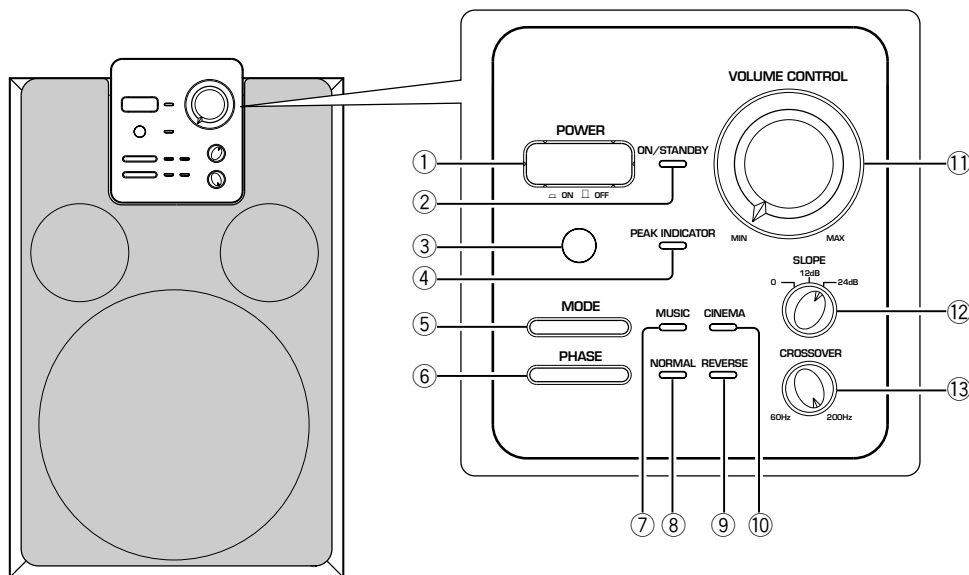

① POWER switch

Press to switch the power to the Subwoofer ON/OFF.

② ON/STANDBY indicator

Lights up according to the operation modes of this unit as described below.

- Green Power ON (Operating status)
- Red Standby mode initiated by remote control
- Amber Standby mode initiated by Auto Shut-off function
- Extinguished Power OFF or power supply failure

Auto Shut-off.

The Subwoofer automatically returns to STANDBY mode (amber light) when no signal has been input for about 8 minutes.

When standby is initiated by Auto Shut-off:

The subwoofer returns to the power ON status (operating status) in a few seconds when a signal is input or when the power key of the remote control unit is pressed.

③ Remote control sensor

Receives the transmission from the remote control unit.

④ PEAK INDICATOR indicator

The brightness of this indicator varies according to the amplitude of the low-frequency component in the input signal.

The PEAK INDICATOR indicator lights very brightly when the built-in amplifier of the Subwoofer is overdriven.

If the Subwoofer is used in this condition, the sound is distorted and the Subwoofer itself may also fail. To prevent this, reduce the volume of the Subwoofer or adjust the amplifier or receiver in order to reduce the input signal to the Subwoofer.

⑤ MODE select key

This key selects the sound mode of the Subwoofer. The Subwoofer incorporates the music and movie modes which can provide optimum deep-bass reproduction characteristics for the music source and movie audio respectively. Each press switches the mode as follows.

- When MUSIC indicator lights music mode
- When CINEMA indicator lights movie mode

⑥ PHASE select key



Each press of this key switches the phase of the sound output from the Subwoofer.

- When NORMAL indicator lights Normal phase
- When REVERSE indicator lights Reverse phase

⑦ MUSIC indicator

⑧ NORMAL indicator

⑨ REVERSE indicator

⑩ CINEMA indicator

⑪ VOLUME CONTROL knob



Adjusts the volume level of the output of the Subwoofer. Rotating the knob clockwise increases the volume level, and rotating the knob counterclockwise decreases the volume level.

⑫ SLOPE selector switch



This switch selects the attenuation characteristic of the sound output from the Subwoofer.

⑬ CROSSOVER control knob



Turn the control knob to adjust the cutoff frequency of the high-frequency components in the sound output from the Subwoofer.

Standby mode

While the standby indicator of the unit is lit in red or amber, a small amount of current is flowing into the unit's internal circuitry to back up the memory. This condition is referred to as the standby mode of the unit. While the unit is in the standby mode, it can be turned ON from the remote control unit.

Caution concerning operation

An excessive input level to the Subwoofer may impair the sound quality or damage the unit. Careful attention should therefore be paid to the following precautions.

- 1. Do not increase the output of the amplifier to a high level while the low-frequency level is enhanced by the amplifier's tone control or loudness control.**
- 2. When operating the amplifier switches or when placing the stylus on an analog record, set the amplifier volume to its minimum level.**

How to operate

Operation range

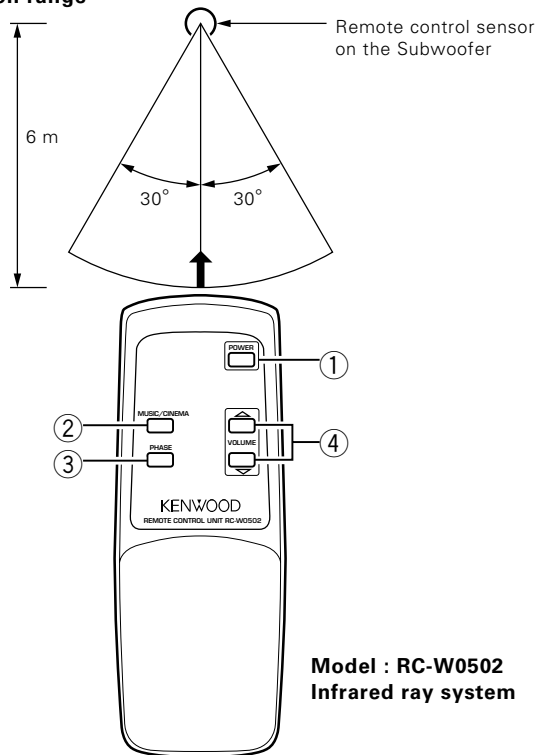

① POWER key

Press to switch the power ON/STANDBY when the POWER switch of the Subwoofer set to ON.

② MUSIC/CINEMA select key



This key has the same function as the MODE key on the Subwoofer.

When MUSIC indicator lights music mode

When CINEMA indicator lights movie mode

③ PHASE select key



This key has the same function as the PHASE select key on the Subwoofer.

When NORMAL indicator lights Normal phase

When REVERSE indicator lights Reverse phase

④ VOLUME control keys



• This keys have the same function as the VOLUME CONTROL knob on the Subwoofer.

Plug in the power supply plug of the Subwoofer to the AC outlet and press the POWER switch on the Subwoofer to turn ON.

When power is ON : Remote control operation is immediately available.

In Standby mode : First press the POWER key of the remote control unit to ON, then press the desired key.

Loading batteries

1. Remove the back cover.

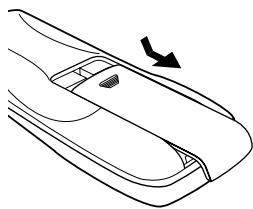

Open by pushing the position marked with the arrow.

2. Insert batteries.

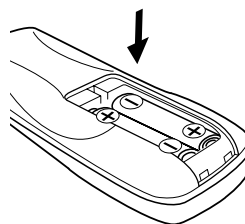

Insert two R03 ("AAA"-size) batteries according to the polarity indication.

3. Close the back cover.

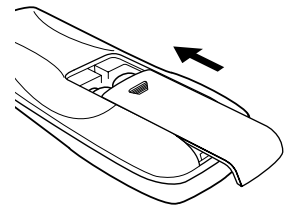

1. The batteries initially supplied are intended for use in checking the remote control operations, so their service life may be shorter than usual. When the remote controllable distance shortens or remote control becomes impossible, replace both of the batteries with new ones.

2. Malfunction may occur if direct sunlight or the light of a highfrequency lighting fluorescent lamp enters the remote control light sensor. In such a case, change the system installation position to prevent the malfunction.

How to use the VOLUME CONTROL knob, PHASE select key, CROSSOVER control knob and SLOPE selector switch

The VOLUME CONTROL knob, PHASE select key, CROSSOVER control knob and SLOPE selector switch can be adjusted to match the condition of the listening room and/or the characteristics of the left and right front speakers.

CROSSOVER control knob and SLOPE selector switch function

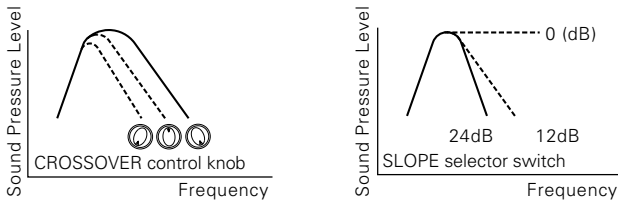

The characteristics above express the images and the details are different from the actual characteristics.

Examples of standard adjustment according to the type of front speakers

① Crossover frequency adjustment (CROSSOVER control knob)

| Front speaker | Crossover Frequency |
|----------------|---------------------|
| Small speaker | 120 ~ 200 Hz |
| Medium speaker | 80 ~ 120 Hz |
| Large speaker | 60 ~ 80 Hz |



Depending on the listening room condition and the front speaker characteristics, other adjustment setting than the examples shown above may provide more natural bass sound and more effective bass reproduction. Try various adjustment settings to select the optimum one for your listening room.

② Crossover slope adjustment (SLOPE selector switch)

24 dB position: To be used when the Subwoofer is combined with bass-reflex type front speakers.

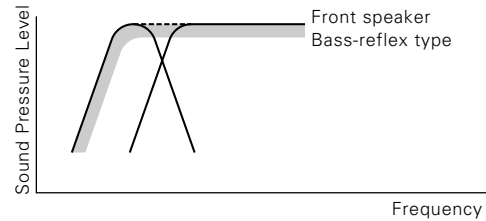

12 dB position: To be used when the Subwoofer is combined with acoustic air-suspension type front speakers.

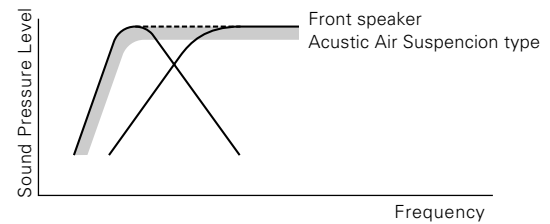

0 (dB) position: To be used for reproducing sound from the subwoofer without electrically attenuating the high-frequency components in the input signal. Use this position when the high frequencies in the subwoofer signal have already been cut by the Dolby Digital or DTS circuitry. The crossover frequency adjustment is invalid when this position is set.

In case of difficulty

A simple mistake may often be misunderstood as a failure. In case of a trouble, check the applicable symptom in the following table before calling for service.

| Symptom | Cause | Remedy |
|---|--|---|
| No sound is output. | <ul style="list-style-type: none"> The connection cords are not plugged into the jacks properly. The volume is set to the minimum. The connected amplifier or receiver does not output the subwoofer pre-out signal (applicable when the amplifier or receiver is equipped with the pre-out on/off function). | <ul style="list-style-type: none"> Connect them properly by referring to "Connections". Adjust to an optimum volume. → 10 → 7 → 11 Switch the subwoofer pre-out switch of the connected amplifier or receiver to ON. |
| Sound volume is low. | <ul style="list-style-type: none"> The speaker cords are connected in the reverse phase. The phase selection is not correct. The pre-out signal level of the connected amplifier or receiver is set to the minimum (applicable when the amplifier or receiver is equipped with the pre-out level control function). | <ul style="list-style-type: none"> Connect the R and L cords with correct + and - polarity by referring to "Connections". Set the phase to a different phase. → 10 → 7 → 11 Adjust the pre-out level of the connected amplifier or receiver to an optimum level. |
| Radio broadcasts are interfered with by noise. | <ul style="list-style-type: none"> The interfered unit is installed near the subwoofer. | <ul style="list-style-type: none"> Install the subwoofer more apart from the radio receiver. → 6 |

Type **Subwoofer system with built-in amplifier
(Magnetically shielded)**

[Amplifier]

Rated Output Power **150 W RMS 30 Hz ~ 200 Hz, 4 Ω**

Phase Switching **NORMAL, REVERSE**

Input Sensitivity & Input Impedance

RCA-type pin-plug jack **100 mV /12 k Ω**

200 mV /12 k Ω (MONO Input)

Push-type terminals **1.7 V /15 k Ω**

[Speaker]

Enclosure **Bass-Reflex, Floor Standing Type**

Speaker Unit **250 mm(10") Cone type**

Nominal Impedance **4 Ω**

[General]

Rated Power Consumption **50 W**

Dimensions **Width : 294 mm (11-9/16")**

Height : 457 mm (18")

Depth : 415 mm (16-5/16")

Net Weight **15.2 kg (33.5 lb)**



KENWOOD follows a policy of continuous advancements in development. For this reason specifications may be changed without notice.

- Sufficient performance may not be exhibited at extremely cold locations (where water freezes).

KENWOOD

For your records

Record the serial number, found on the back of the unit, in the spaces designated on the warranty card, and in the space provided below. Refer to the model and serial numbers whenever you call upon your dealer for information or service on this product.

Model _____ Serial Number _____

Free Manuals Download Website

<http://myh66.com>

<http://usermanuals.us>

<http://www.somanuals.com>

<http://www.4manuals.cc>

<http://www.manual-lib.com>

<http://www.404manual.com>

<http://www.luxmanual.com>

<http://aubethermostatmanual.com>

Golf course search by state

<http://golfingnear.com>

Email search by domain

<http://emailbydomain.com>

Auto manuals search

<http://auto.somanuals.com>

TV manuals search

<http://tv.somanuals.com>