

KENWOOD

POWER AMPLIFIER

KM-X1000 KM-X1000(G)

INSTRUCTION MANUAL

KENWOOD CORPORATION

Manufactured under license from Lucasfilm Ltd, Lucasfilm and THX are trademarks of Lucasfilm Ltd.

For your records

Record the serial number, found on the back of the unit, in the spaces designated on the warranty card, and in the space provided below. Refer to the model and serial numbers whenever you call upon your dealer for information or service on this product.

Model _____ Serial Number _____

Unpacking

Unpack the unit carefully and make sure that all accessories are put aside so they will not be lost. Examine the unit for any possibility of shipping damage. If your unit is damaged or fails to operate, notify your dealer immediately. If your unit was shipped to you directly, notify the shipping company without delay. Only the consignee (the person or company receiving the unit) can file a claim against the carrier for shipping damage. We recommend that you retain the original carton and packing materials for use should you transport or ship the unit in the future.

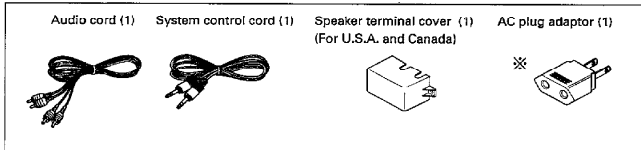

Accessories



※ Use to adapt the plug on the power cord to the shape of the wall outlet. (Accessory only for regions where use is necessary.)

Contents

Caution: Read the pages marked  carefully to ensure safe operation.

Special features	2
 Before applying power	2
 Safety precautions	2
System connections	3
Connections of speaker cords	3
Connection with a KENWOOD receiver	3
Use as a stereo power amplifier	5
Use as a monaural power amplifier (BTL connection)	5
Controls and indicators	6
In case of difficulty	7
Specifications	8

For Europe and U.K.

CE NOTICE

This (these) equipment(s) is (are) in conformity with the provision of EMC Directive, 89/336/EEC, 92/31/EEC and 93/68/EEC.

B60-2136-00 (SI) (K,P,Y,M,X,T) 

HOME THX CINEMA® compatibility

BTL connection providing a high-power output

The performance of the HOME THX CINEMA® system can be fully exhibited and its sound effects fully enjoyed.

When the unit is operated as a monaural power amplifier based on BTL connection, the output power can be doubled compared to the output from a single channel with stereo connection.

HOME THX CINEMA® is a registered trademark of Lucasfilm Ltd.

Before applying power

 **Caution: Read this section carefully to ensure safe operation.**

Units are designed for operation as follows.

U.S.A. and Canada AC 120 V only
Australia AC 240 V only

Europe and U.K. AC 230 V only
*Other countries AC110-120/220-240 V switchable

For the United Kingdom

Factory fitted moulded mains plug

1. The mains plug contains a fuse. For replacement, use only a 13-Amp ASTA-approved (BS1362) fuse.
2. The fuse cover must be refitted when replacing the fuse in the moulded plug.
3. Do not cut off the mains plug from this equipment. If the plug fitted is not suitable for the power points in your home or the cable is too short to reach a power point, then obtain an appropriate safety approved extension lead or adapter, or consult your dealer. If nonetheless the mains plug is cut off, remove the fuse and dispose of the plug immediately, to avoid a possible shock hazard by inadvertent connection to the mains supply.

IMPORTANT: The wires in the mains lead are coloured in accordance with the following code:

Blue : Neutral
Brown : Live

Do not connect those leads to the earth terminal of a three-pin plug.

* AC voltage selection

The AC voltage selector switch on the rear panel is set to the voltage that prevails in the area to which the unit is shipped. Before connecting the power cord to your AC outlet, make sure that the setting position of this switch matches your line voltage. If not, it must be set to your voltage in accordance with the following direction.

AC voltage selector switch

Move switch lever to match your line voltage with a small screwdriver or other pointed tool.

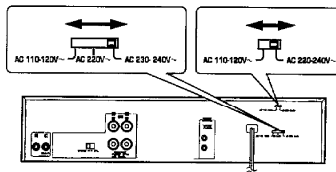





Note:
Our warranty does not cover damage caused by excessive line voltage due to improper setting of the AC voltage selector switch.

Safety precautions

 **Caution: Read this section carefully to ensure safe operation.**

WARNING: TO PREVENT FIRE OR ELECTRIC SHOCK, DO NOT EXPOSE THIS APPLIANCE TO RAIN OR MOISTURE.

	CAUTION RISK OF ELECTRIC SHOCK DO NOT OPEN		CAUTION: TO REDUCE THE RISK OF ELECTRIC SHOCK, DO NOT REMOVE COVER (OR BACK). NO USER-SERVICEABLE PARTS INSIDE. REFER SERVICING TO QUALIFIED SERVICE PERSONNEL.
	THE LIGHTNING FLASH WITH ARROWHEAD SYMBOL, WITHIN AN EQUILATERAL TRIANGLE, IS INTENDED TO ALERT THE USER TO THE PRESENCE OF UNINSULATED "DANGEROUS VOLTAGE" WITHIN THE PRODUCT'S ENCLOSURE THAT MAY BE OF SUFFICIENT MAGNITUDE TO CONSTITUTE A RISK OF ELECTRIC SHOCK TO PERSONS.		
	THE EXCLAMATION POINT WITHIN AN EQUILATERAL TRIANGLE IS INTENDED TO ALERT THE USER TO THE PRESENCE OF IMPORTANT OPERATING AND MAINTENANCE (SERVICING) INSTRUCTIONS IN THE LITERATURE ACCOMPANYING THE APPLIANCE.		

Make connection as shown below.

When connecting the related system components, refer also to the instruction manuals of the related components. Do not plug in the power lead until all connections are completed.

Connections of speaker cords

For U.S.A. and Canada

CAUTION:

If the unit is used in the U.S.A. or Canada, please read the supplement to the operating instruction entitled "Connection of speaker cords".

Warning!

Particular attention must be given to making good electrical contact at the amplifier-output and speaker terminals. Poor or loose connections can cause sparking or burning at the terminals because of the very high power that the amplifier can deliver.

Connections of speaker cords

① Strip coating.



② Loosen.



③ Insert.



④ Secure.



Connection of banana plugs (Except for some countries, like Singapore, etc.)

① Secure.



② Insert.

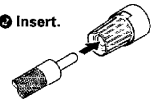

• Sound will not be heard if the speaker terminal is not fully secured.

CAUTION: Never attempt to connect two or more speaker cords to a single speaker terminal.

- Never short-circuit the + and - speaker cords.
- If the left and right speakers are connected inversely or if the speaker cords are connected with reversed polarity, the sound becomes unnatural with ambiguous acoustic image positioning. Be sure to connect the speakers and speaker cords correctly.

Connection with a KENWOOD receiver

Use this connection method when reproducing the pre-out signal of the subwoofer channel of the KENWOOD receiver. Also read the instruction manual of the receiver.

In case two subwoofer speakers are connected

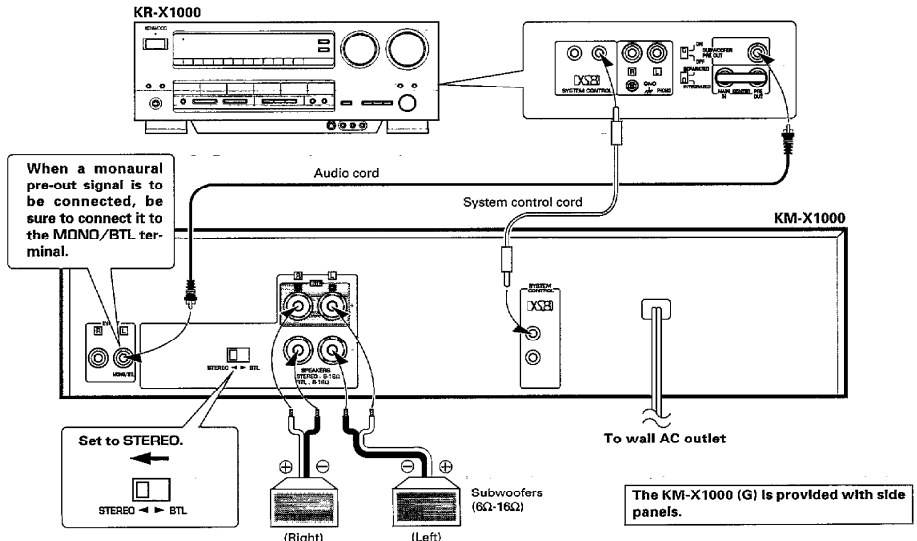

In case one subwoofer speaker is connected (BTL connection)

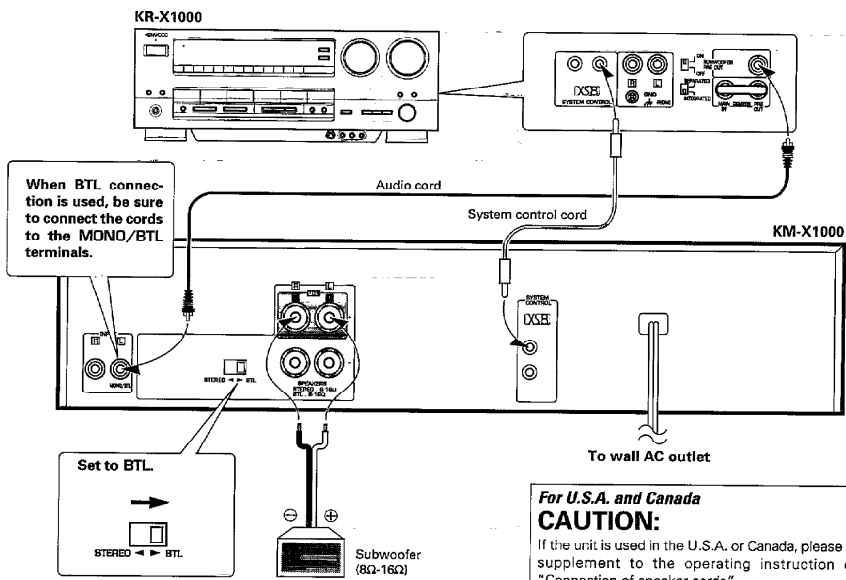

BTL (Balanced Transformer-Less) connection

CAUTION: TO PREVENT FIRE OR DAMAGE REQUIRING SERVICE, SET THE STEREO/BTL SWITCH AS DESCRIBED BELOW.

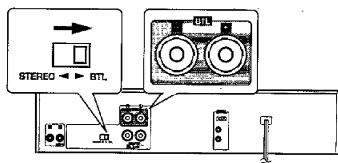

The BTL connection refers to a connection method which uses a stereo amplifier as a single amplifier (monaural). The use of a stereo amplifier for one signal allows to increase the output power.

To use BTL Connection, set the **STEREO/BTL** switch to **BTL** and connect the speaker cords to the BTL terminals. This allows to use this unit as a monaural amplifier.

Set the **STEREO/BTL** switch to **STEREO** when this unit is used as an ordinary stereo amplifier.

Connect the speaker cords properly according to the setting of the **STEREO/BTL** switch.

- Turn power OFF before connecting speaker cords or changing the position of the **STEREO/BTL** switch.

Remote control operation

By connecting the SYSTEM CONTROL jack of this unit to the "DXS" or "DXSE" system control jack of the KENWOOD amplifier or receiver, the power of this unit can be turned ON/OFF using the remote control unit provided with the amplified or receiver.



1. Connect all cords firmly. If connections are loose, there could be loss of sound or noise produced.
2. When plugging and unplugging connection cords, be sure to first remove the power cord from the AC outlet. Plugging/unplugging connection cords without removal of the power cord can cause malfunctions or damage to the unit.
3. Insert the system control plugs completely into the jacks.
4. If the system control cords or audio cords are not connected properly, the remote control or automatic operation between system components will not work properly.

Use as a stereo power amplifier

This unit can be used as a stereo power amplifier by connecting it to a commercially available preamplifier.

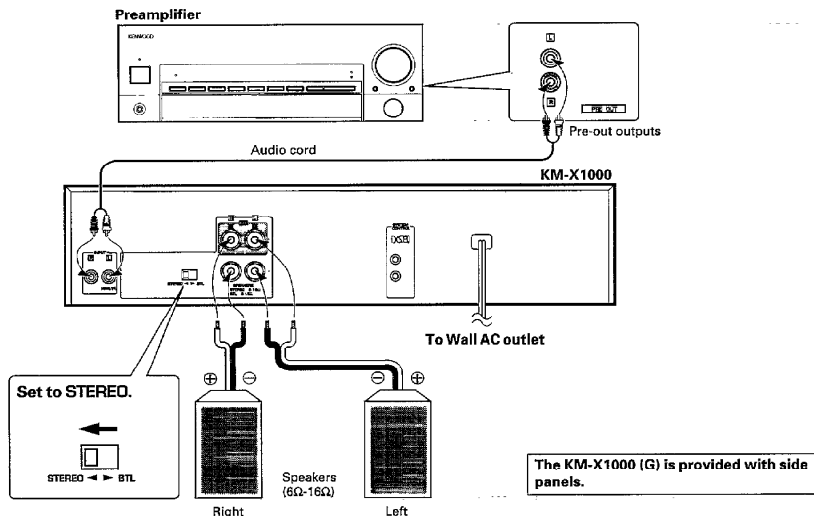

Use as a monaural amplifier (BTL connection)

This unit can be used as a monaural power amplifier by connecting it to a commercially available preamplifier.

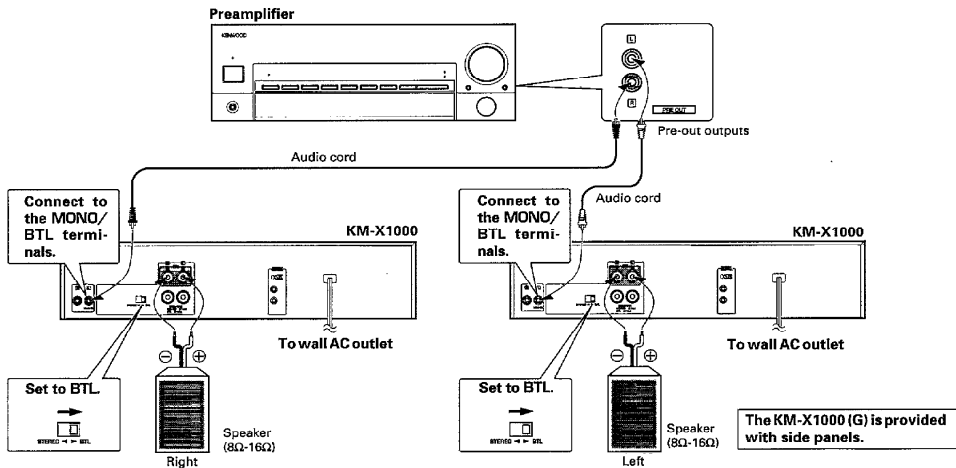

6 Other connection examples

Example of connection with a 6-channel surround preamplifier

● Normal (stereo) connection (use of three KM-X1000 units)

* Use speaker with impedances from 6 to 16 ohms.

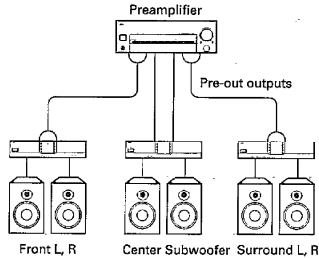

● BTL connection (use of six KM-X1000 units)

* Use speakers with impedances from 8 to 16 ohms.

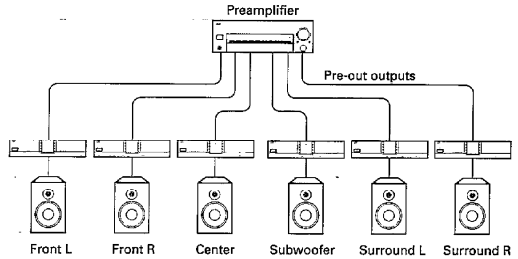

Controls and indicators

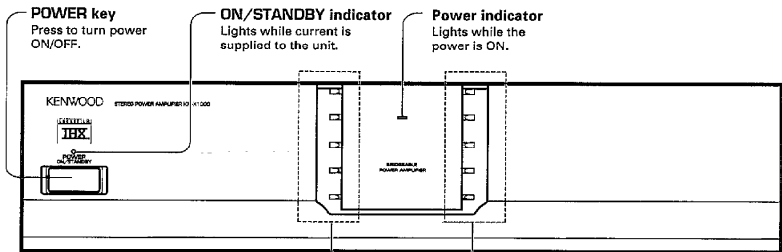

The KM-X1000 (G) is provided with side panels.

Air intake

The ventilation fan inside the air intake rotates during high-power operation. Do not place any object in front of the air intake.

Notes on heat generation

- This unit incorporates a ventilation fan to process heat generated during operation. As the fan starts to rotate automatically when the internal temperature of this unit rises, avoid installing or setting which may prevent ventilation of the unit.

* Leave clearance of more than 5 cm to the left and right and those of more than 10 cm above and in front and rear of the unit. Also, do not close the surroundings of the unit tightly when it is mounted on a rack.

- The ventilation fan of this unit has been designed to intake external air into the unit. If curtain or a piece of paper is attracted by the air intake, the internal temperature will rise and protection circuitry will be activated. In this case, the sound will not be output.

To allow ventilation, leave clearances between this unit and rack partitions or surround walls as indicated with dotted lines.

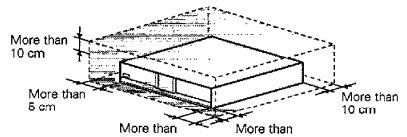

STANDBY mode of POWER switch

When the power cord of this unit is plugged into an AC outlet, the **STANDBY** indicator lights up regardless of the ON/OFF setting of the **POWER** switch. This indicates that a small amount of current is being supplied to the unit to back up the memory contents. This mode is referred to as the Standby mode.

Operation to reset

The microcomputer fall into may malfunction (impossibility to operate) when the power cord is unplugged while power is ON or due to an external factor. In this case, execute the following procedure to reset the microcomputer and return it to normal condition.

Unplug the power cord from the power socket and, while holding the **POWER** key depressed, plug the power cord into the socket again.

Symptom	Cause	Remedy
Sound is not output.	<ul style="list-style-type: none">• The speaker cords are disconnected.• The audio cords are disconnected.• The STEREO/BTL switch is not set properly.	<ul style="list-style-type: none">• Connect them properly referring to "System connections"• Connect them properly referring to "System connections"• Connect them properly referring to "System connections"
The STANDBY indicator blinks and sound is not output.	<ul style="list-style-type: none">• Speaker cords are short-circuited.• The internal temperature of the unit rose and the protection circuitry was activated.	<ul style="list-style-type: none">• Turn the power off, eliminate the short-circuiting, then turn on the power again.• Turn power OFF and wait until the internal temperature drops. After ensuring that the temperature has dropped, turn power ON again. As the current installation condition may not be appropriate, improve it following the "Notes on heat generations"
Sound is not output from one of the speakers.	<ul style="list-style-type: none">• The speaker cord is disconnected.• The audio cords are disconnected.	<ul style="list-style-type: none">• Connect it properly referring to "System connections".• Connect it properly referring to "System connections".



Do not use contact cleaners because it could cause a malfunction. Be specially careful against contact cleaners containing oil, for they may deform the plastic components.

For the U.S.A

FCC WARNING

This equipment may generate or use radio frequency energy. Changes or modifications to this equipment may cause harmful interference unless the modifications are expressly approved in the instruction manual. The user could lose the authority to operate this equipment if an unauthorized change of modification is made.

NOTE:

This equipment has been tested and found to comply with the limits for a Class B digital device, pursuant to Part 15 of the FCC Rules. These limits are designed to provide reasonable protection against harmful interference in a residential installation. This equipment may cause harmful interference to radio communications, if it is not installed and used in accordance with the instructions. However, there is no guarantee that interference will not occur in a particular installation. If this equipment does cause harmful interference to radio or television reception, which can be determined by turning the equipment off and on, the user is encouraged to try to correct the interference by one or more of the following measures:

- Reorient or relocate the receiving antenna.
- Increase the separation between the equipment and receiver.
- Connect the equipment into an outlet on a circuit different from that to which the receiver is connected.
- Consult the dealer or an experienced radio/TV technician for help.

For Canada

DOC REGULATION

"This digital apparatus does not exceed the CLASS B limits for radio noise emissions from digital apparatus as set out in the radio interference regulations of the Canadian Department of Communications."

Rated power output

For the U.S.A and Canada

STEREO MODE

130 watts per channel minimum RMS, both channels driven at 8 Ω, from 20 Hz to 20,000 Hz with no more than 0.01 % total harmonic distortion (FTC)

MONO (BTL) MODE

270 watts minimum RMS, at 8 Ω, from 20 Hz to 20,000 Hz with no more than 0.03 % total harmonic distortion (FTC)

For U.K.

(IHF'66)

STEREO MODE

From 20 Hz to 20 kHz, 0.01 % T.H.D. at 8 Ω
..... 130 W + 130 W

MONO (BTL) MODE

From 20 Hz to 20 kHz, 0.03 % T.H.D. at 8 Ω
..... 270 W

(DIN)

STEREO MODE

1 kHz, 0.5 % T.H.D. at 8 Ω 145 W + 145 W
1 kHz, 0.5 % T.H.D. at 6 Ω 190 W + 190 W

MONO (BTL) MODE

1 kHz at 8 Ω 340 W

(IEC/NF)

STEREO MODE

From 63 Hz to 12,500 Hz, 0.5 % T.H.D. at 8 Ω
..... 145 W+ 145 W

From 63 Hz to 12,500 Hz, 0.5 % T.H.D. at 6 Ω
..... 190 W+ 190 W

MONO (BTL) MODE

From 63 Hz to 12,500 Hz, 0.5 % T.H.D. at 8 Ω
..... 325 W

For other countries

(IHF'66)

STEREO MODE

From 20 Hz to 20 kHz, 0.01 % T.H.D. at 8 Ω
..... 130 W + 130 W

MONO (BTL) MODE

From 20 Hz to 20 kHz, 0.03 % T.H.D. at 8 Ω
..... 270 W

(IEC/NF)

STEREO MODE

From 63 Hz to 12,500 Hz, 0.5 % T.H.D. at 8 Ω
..... 145 W+ 145 W

From 63 Hz to 12,500 Hz, 0.5 % T.H.D. at 6 Ω
..... 190 W+ 190 W

MONO (BTL) MODE

From 63 Hz to 12,500 Hz, 0.5 % T.H.D. at 8 Ω
..... 325 W

(EIAJ)

STEREO MODE

1 kHz, 10 % T.H.D. at 8 Ω 180 W+ 180 W
1 kHz, 10 % T.H.D. at 6 Ω 230 W+ 230 W

MONO (BTL) MODE

1 kHz, 10 %, T.H.D. at 8 Ω 420 W

Total harmonic distortion

STEREO MODE

..... 0.01 % (20 Hz ~ 20 kHz, 130 W, 8 Ω)
..... 0.001 % (1 kHz, 130 W, 8 Ω)

MONO (BTL) MODE

..... 0.03 % (20 Hz ~ 20 kHz, 270 W, 8 Ω)
..... 0.001 % (1 kHz, 270 W, 8 Ω)

Frequency response

MAIN IN 3 Hz ~ 100 kHz, +0 dB, -3 dB

Signal to noise ratio

(IHF'66)

MAIN IN 124 dB

(IHF'78)

MAIN IN 101 dB

(DIN)

MAIN IN 66 dB (50 mW output)

Input sensitivity / Impedance

STEREO MODE

MAIN IN 1.1 V / 20 kΩ

MONO (BTL) MODE

MAIN IN 1.5 V / 100 kΩ

GENERAL

Power consumption 3.5 A
..... 310 W

Dimensions (KM-X1000)

W: 440 mm (17-5/16")

H: 113 mm (4-7/16")

D: 394 mm (15-1/2")

(For the U.S.A. and Canada)

D: 384 mm

(Except for the U.S.A. and Canada)

Dimensions (KM-X1000(G))

W: 479 mm

H: 113 mm

D: 384 mm

Weight (net) (KM-X1000) 13.3 kg (29.4 lb)

Weight (net) (KM-X1000(G)) 14.1 kg



KENWOOD follows a policy of continuous advancements in development. For this reason specifications may be changed without notice.

Free Manuals Download Website

<http://myh66.com>

<http://usermanuals.us>

<http://www.somanuals.com>

<http://www.4manuals.cc>

<http://www.manual-lib.com>

<http://www.404manual.com>

<http://www.luxmanual.com>

<http://aubethermostatmanual.com>

Golf course search by state

<http://golfingnear.com>

Email search by domain

<http://emailbydomain.com>

Auto manuals search

<http://auto.somanuals.com>

TV manuals search

<http://tv.somanuals.com>