

KENWOOD

KMF-X9000

POWER AMPLIFIER

INSTRUCTION MANUAL

Introduction

Thank you for selecting our power amplifier as part of your high-fidelity system. We at KENWOOD are confident that your choice will bring you years of rich listening pleasure. Please take the time to read through this booklet carefully. It will help you to obtain the peak performance your power amplifier can deliver.

Features

Lucasfilm THX® Ultra Certification

THX® Ultra certification means that the KMF-X9000 meets Lucasfilm's most stringent performance standards. This ensures superb sound quality and compatibility with other THX®-certified products.

Operation Modes

The KMF-X9000 can be used in one of three different operation modes: 2-channel stereo, 2-channel mono, or Mono (bridged, or BTL), so it can fit into almost any system configuration and deliver all the power your speakers need.

12 V Relay Power Control

The KMF-X9000 can be powered on and off by an external 12 volt trigger signal, so it can be installed in a remote location.



Lucasfilm and THX are trademarks of Lucasfilm Ltd.

Before applying power

⚠ Caution: Read this page carefully to ensure safe operation.

Units are designed for operation as follows.

Europe and U.K. AC 230 V only

*Other countries AC 110-120 V/220 V-240 V switchable

*AC voltage selection

The AC voltage selector switch on the rear panel is set to the voltage that prevails in the area to which the unit is shipped. Before connecting the power cord to your AC outlet, make sure that the setting position of this switch matches your line voltage. If not, move the switch to match your line voltage with a screwdriver or similar tool.

Note:

Our warranty does not cover damage caused by excessive line voltage due to improper setting of the voltage selector switch.

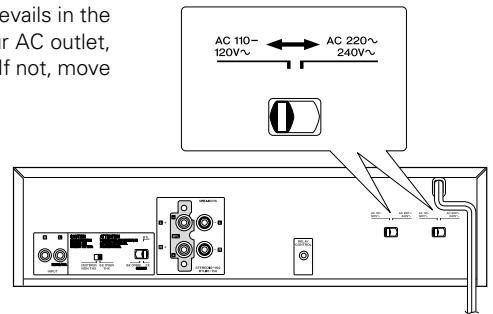

Safety precautions

⚠ Caution: Read this page carefully to ensure safe operation.

WARNING: TO PREVENT FIRE OR ELECTRIC SHOCK, DO NOT EXPOSE THIS APPLIANCE TO RAIN OR MOISTURE.

	CAUTION RISK OF ELECTRIC SHOCK DO NOT OPEN		CAUTION: TO REDUCE THE RISK OF ELECTRIC SHOCK, DO NOT REMOVE COVER (OR BACK). NO USER-SERVICEABLE PARTS INSIDE. REFER SERVICING TO QUALIFIED SERVICE PERSONNEL.
	THE LIGHTNING FLASH WITH ARROWHEAD SYMBOL, WITHIN AN EQUILATERAL TRIANGLE, IS INTENDED TO ALERT THE USER TO THE PRESENCE OF UNINSULATED "DANGEROUS VOLTAGE" WITHIN THE PRODUCT'S ENCLOSURE THAT MAY BE OF SUFFICIENT MAGNITUDE TO CONSTITUTE A RISK OF ELECTRIC SHOCK TO PERSONS.		
	THE EXCLAMATION POINT WITHIN AN EQUILATERAL TRIANGLE IS INTENDED TO ALERT THE USER TO THE PRESENCE OF IMPORTANT OPERATING AND MAINTENANCE (SERVICING) INSTRUCTIONS IN THE LITERATURE ACCOMPANYING THE APPLIANCE.		

Contents

⚠ Before applying power	2	Mono (bridged, or BTL) configuration	5
⚠ Safety precautions	2	2-Channel mono configuration	6
Unpacking	3	12 V Relay power control	6
Installation	3	Controls and indicators	7
Notes on heat generation	3	In case of difficulty	7
Connections	3	Operation to reset	7
Connections of speaker cords	3	Troubleshooting	7
2-Channel stereo configuration	4	Specifications	Back cover

Unpacking

Unpack the unit carefully and make sure that all accessories are put aside so they will not be lost.

Examine the unit for any possibility of shipping damage. If your unit is damaged or fails to operate, notify your dealer immediately. If your unit was shipped to you directly, notify the shipping company without delay. Only the consignee (the person

or company receiving the unit) can file a claim against the carrier for shipping damage.

We recommend that you retain the original carton and packing materials for use should you transport or ship the unit in the future.

Accessories

Audio cord (1)

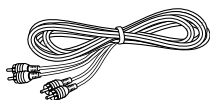

Stereo mini-plug cord (1)

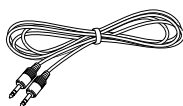

Speaker terminal cover (1) (Except for Europe)

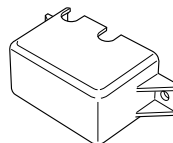

Installation

Notes on heat generation

- This unit incorporates a ventilation fan to process heat generated during operation. As the fan starts to rotate automatically when the internal temperature of this unit rises, avoid installing or setting which may prevent ventilation of the unit.
- * Leave clearance of more than 10 cm (4 in.) to the left and right, more than 50 cm (20 in.) above and more than 10 cm (4 in.) in front and rear of the unit. Also, do not close the surroundings of the unit tightly when it is mounted on a rack.
- The ventilation fan of this unit has been designed to intake external air into the unit. If curtain or a piece of paper is attracted by the air intake, the internal temperature will rise and protection circuitry will be activated. In this case, the sound will not be output.

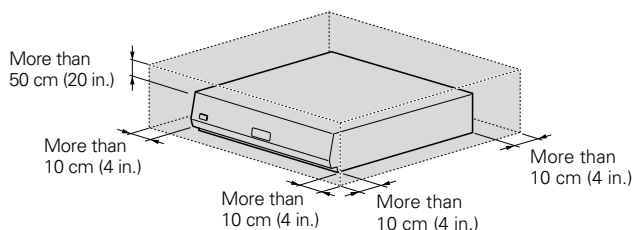

Connections

Make connection as shown below. When connecting the related system components, refer also to the instruction manuals of the related components. Do not plug in the power lead until all connections are completed.

Connections of speaker cords

For U.S.A.

CAUTION:

If the unit is used in the U.S.A., please read the supplement to the operating instruction entitled "Connection of speaker cords".

Connections of speaker cords

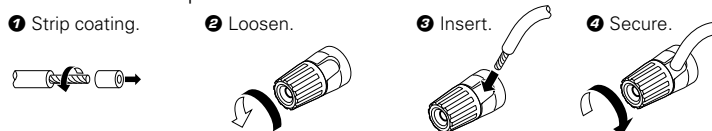

Warning!

Particular attention must be given to making good electrical contact at the amplifier-output and speaker terminals.

Poor or loose connections can cause sparking or burning at the terminals because of the very high power that the amplifier can deliver.

Connection of banana plugs (Except for some countries, like Singapore, etc.)



- Sound will not be heard if the speaker terminal is not fully secured.

CAUTIONS:

- Connect all cords firmly. If connections are loose, there could be loss of sound or noise produced.
- Never attempt to connect two or more speaker cords to a single speaker terminal.
- Never short-circuit the + and - speaker cords.
- If the left and right speakers are connected inversely or if the speaker cords are connected with reversed polarity, the sound becomes unnatural with ambiguous acoustic image positioning. Be sure to connect the speakers and speaker cords correctly.

2-Channel stereo configuration

This is the 'standard' stereo operation mode, with the amplifier driving 2 speakers in stereo (such as the Surround Back Left and Surround Back Right speakers in a THX Surround EX® home theater system). The amplifier delivers its rated stereo power output into each speaker.

- 1** Make sure that the KMF-X9000's power cord is unplugged from the wall outlet before making any connections.
- 2** According to the speakers to be used, set the speaker impedance selector switch as follows:
 - For 2 Ω speakers: Set the 2Ω (STEREO)/6Ω OVER switch to 2Ω (STEREO) and 6Ω OVER/2Ω switch to 2Ω.
 - For 6-16 Ω speakers: Set the 2Ω (STEREO)/6Ω OVER switch to 6Ω OVER and 6Ω OVER/2Ω switch to 6Ω OVER.
- 3** Connect the amplifier as shown in the diagram.

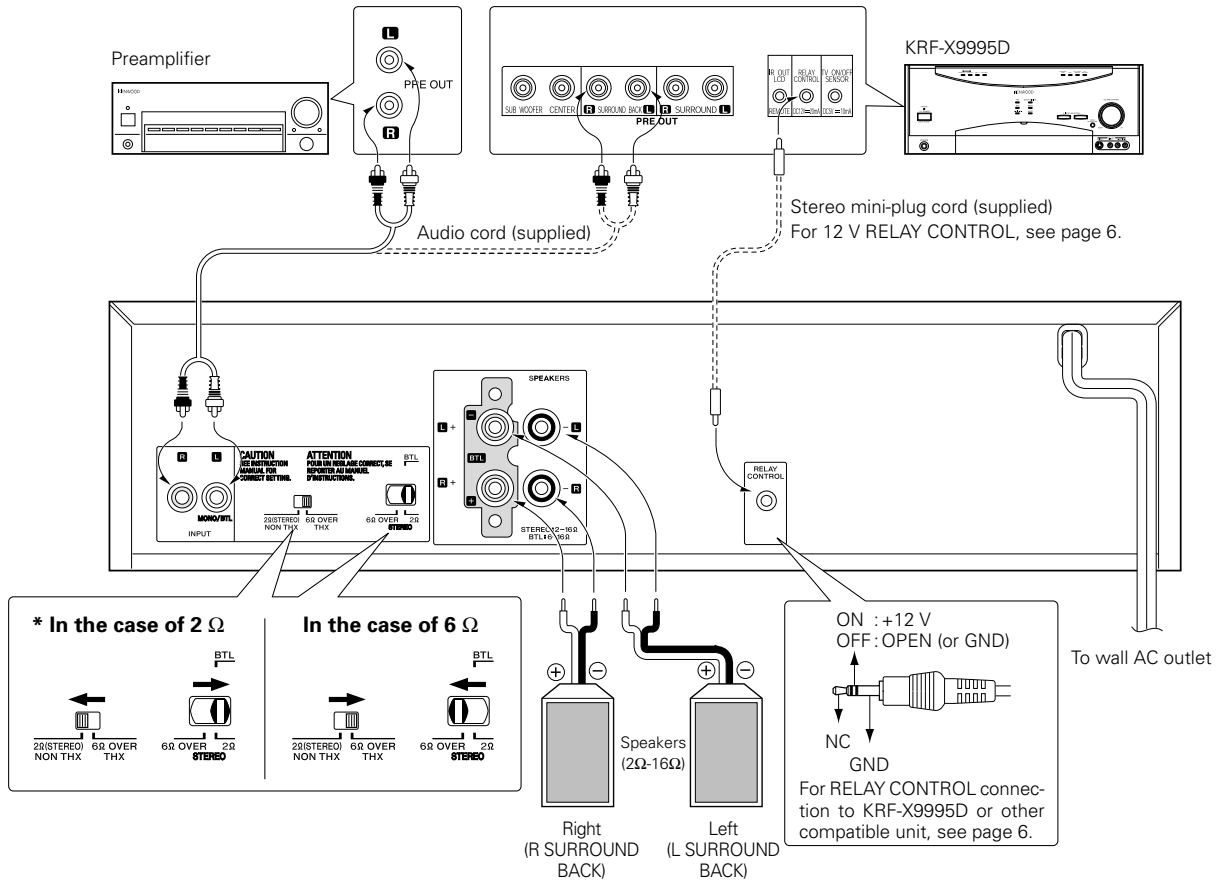

* If you connect more than one pair of speakers to the KMF-X9000, move the 2Ω (STEREO)/6Ω OVER (THX) switch to the 2Ω (STEREO) position. The amplifier's performance is not THX®-certified when the switch is set in the 2Ω (STEREO) position.

Now you can plug the power cord of this unit into the AC outlet!

CAUTION:

Before reconnecting a speaker cord or switching a selector switch, turn OFF the power and unplug the power cord to avoid malfunctions or damage to the unit.

■ Mono (bridged, or BTL) configuration

In this configuration, the KMF-X9000's two individual channels operate together to drive a single speaker (such as a subwoofer) in mono. This allows the amplifier to deliver more than double the power of one of its channels to the speaker.

- 1** Make sure that the KMF-X9000's power cord is unplugged from the wall outlet before making any connections.
- 2** According to the speakers to be used, set the speaker impedance selector switch as follows:
 - For 6-16 Ω speakers: Set the 2 Ω (STEREO)/6 Ω OVER switch to 6 Ω OVER and 6 Ω OVER/2 Ω switch to 2 Ω .
- 3** Connect the amplifier as shown in the diagram.
 - Make sure to connect the audio input cable to the **MONO/BTL** input.

Except for Europe

Note: Since bridged operation produces enough output power to pose a small risk of electrical shock from the speaker terminals, please attach the terminal cover as shown in the diagram below:

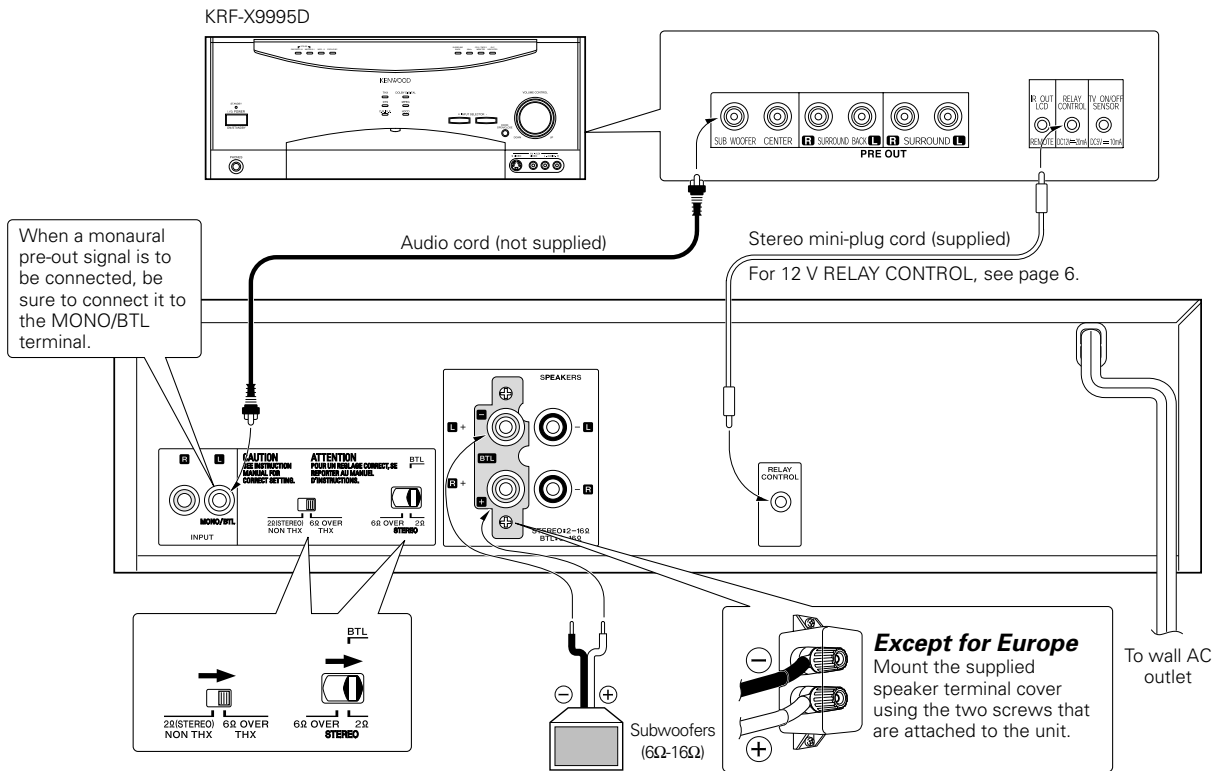

Now you can plug the power cord of this unit into the AC outlet!

CAUTION:

Before reconnecting a speaker cord or switching a selector switch, turn OFF the power and unplug the power cord to avoid malfunctions or damage to the unit.

2-Channel mono configuration

In this configuration you can connect 2 speakers (such as 2 subwoofers) to the KMF-X9000 and send a single preamp signal (such as a mono subwoofer output) to both speakers without using a Y-adaptor. The amplifier delivers its rated stereo power output to each speaker.

- 1 Make sure that the KMF-X9000's power cord is unplugged from the wall outlet before making any connections.
- 2 According to the speakers to be used, set the speaker impedance selector switch as follows:
 - For 2 Ω speakers: Set the 2Ω (STEREO)/6Ω OVER switch to 2Ω (STEREO) and 6Ω OVER/2Ω switch to 2Ω.
 - For 6-16 Ω speakers: Set the 2Ω (STEREO)/6Ω OVER switch to 6Ω OVER and 6Ω OVER/2Ω switch to 6Ω OVER.
- 3 Connect the amplifier as shown in the diagram.
 - Make sure to connect the audio input cable to the **MONO/BTL** input.

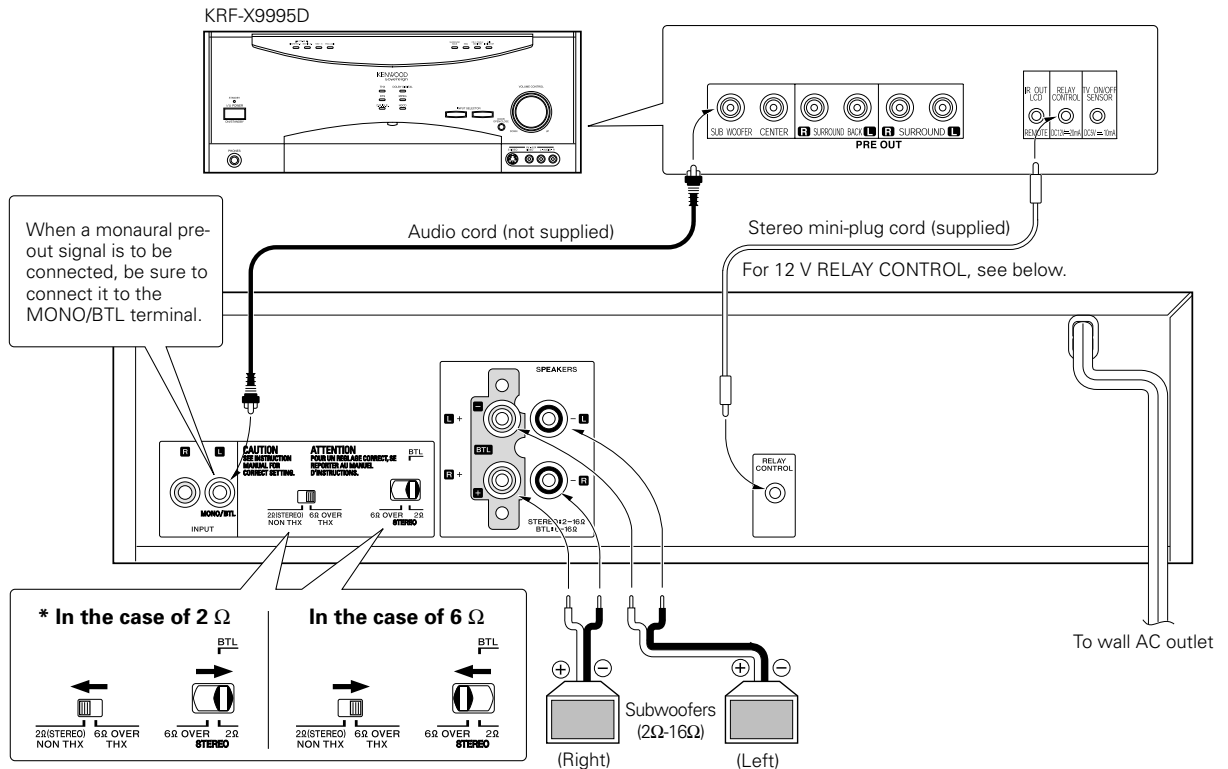

- * If you connect more than one pair of speakers to the KMF-X9000, move the 2Ω (STEREO)/6Ω OVER (THX) switch to the 2Ω (STEREO) position. The amplifier's performance is not THX®-certified when the switch is set in the 2Ω (STEREO) position.

Now you can plug the power cord of this unit into the AC outlet!

CAUTION:

Before reconnecting a speaker cord or switching a selector switch, turn OFF the power and unplug the power cord to avoid malfunctions or damage to the unit.

12 V Relay power control

The KMF-X9000 can be powered on and off by a 12 volt trigger signal from a compatible component (such as the Kenwood KRF-X9995D receiver).

- 1 Make sure that the KMF-X9000's power cord is unplugged from the wall outlet before making any connections.
- 2 Connect the supplied mini cable to the KMF-X9000's RELAY CONTROL input and the 12 V relay control output of the KRF-X9995D or other compatible component.
 - When the KMF-X9000's **POWER** switch is turned ON, the amplifier will remain in the **STANDBY** mode (the **STANDBY** indicator will be lit) as long as there is no signal at the **RELAY CONTROL** input.
 - The KMF-X9000 will automatically turn ON when a 12 V signal is applied to the **RELAY CONTROL** input.
 - When the 12 V signal is removed from the KMF-X9000's **RELAY CONTROL** input, the amplifier will go back into the **STANDBY** mode.
 - If there is no cable connected to the KMF-X9000's **RELAY CONTROL** input, the amplifier's **STANDBY** indicator will not function, and its ON/OFF status will be controlled by the **POWER** switch.

Controls and indicators

This unit has the following switch and indicators.

The power indicator and the STANDBY indicator will let you know the status of this unit.

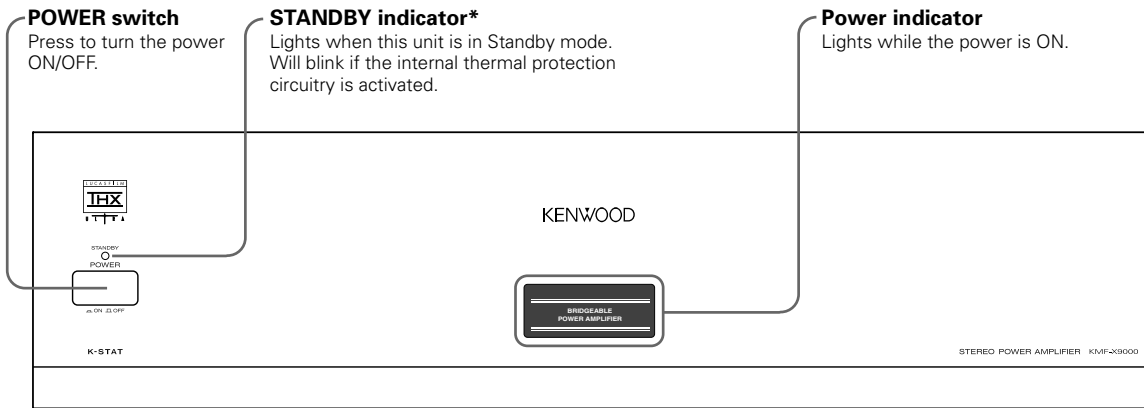

*: The STANDBY indicator is activated only when the supplied mini-plug cord is connected between this unit and the KENWOOD receiver (such as the Kenwood KRF-X9995D receiver). The STANDBY indicator will light when the KENWOOD receiver is turned OFF and it will go out when the KENWOOD receiver is turned ON.

When the supplied mini-plug cord is not used, the STANDBY indicator does not work.

Standby mode

While the standby indicator is lit, a small amount of power is supplied to the system to back up the memory. This is called standby mode. Under the condition, the system can be turned ON by the remote control unit.

In case of difficulty

■ Operation to reset

The microcomputer may malfunction when the power cord is unplugged while power is ON or due to an external factor. In this case, execute the following procedure to reset the microcomputer and return it to normal condition.

- Unplug the power cord from the AC outlet and, while holding the **POWER** switch depressed, plug the power cord into the AC outlet again.

■ Troubleshooting

Symptom	Cause	Remedy
Sound is not output from one or all speakers.	<ul style="list-style-type: none"> • The speaker cords are disconnected. • The audio cords are disconnected. • The STEREO/BTL switch is not set properly. 	<ul style="list-style-type: none"> • Connect them properly referring to "Connections". • Connect them properly referring to "Connections". • Set it properly referring to "Connections".
The STANDBY indicator blinks and sound is not output.	<ul style="list-style-type: none"> • Speaker cords are short-circuited. • The internal temperature of the unit rose and the protection circuitry was activated. 	<ul style="list-style-type: none"> • Turn the power OFF, eliminate the short-circuiting, then turn ON the power again. • Turn the power OFF and wait until the internal temperature drops. After ensuring that the temperature has dropped, turn the power ON again. As the current installation condition may not be appropriate, improve it following the "Notes on heat generation".
STANDBY indicator does not lights.	<ul style="list-style-type: none"> • The cord for RELAY CONTROL is not connected. 	<ul style="list-style-type: none"> • Connect it between this unit and the KENWOOD receiver (such as the Kenwood KRF-X9995D receiver).

Specifications

Power amplifier section

Rated power output

- For other countries

STEREO MODE

130 watts per channel minimum RMS, both channels driven at 6 Ω , from 20 Hz to 20,000 Hz with no more than 0.02 % total harmonic distortion (FTC)

MONO (BTL) MODE

270 watts minimum RMS, at 6 Ω , from 20 Hz to 20,000 Hz with no more than 0.03 % total harmonic distortion (FTC)

Frequency response

MAIN IN 5 Hz ~ 100 kHz, +0 dB, -3 dB

Signal to noise ratio

(IHF'66)

MAIN IN 115 dB

Input sensitivity / Impedance

STEREO MODE

MAIN IN 1.1 V / 20 k Ω

MONO (BTL) MODE

MAIN IN 1.5 V / 100 k Ω

- For Europe

(IEC)

STEREO MODE

From 20 Hz to 20,000 Hz, 0.7 % T.H.D. at 6 Ω
..... 130 W + 130 W

MONO (BTL) MODE

From 20 Hz to 20,000 Hz, 0.7 % T.H.D. at 6 Ω
..... 270 W

(DIN)

STEREO MODE

1 kHz, 0.7 % T.H.D. at 6 Ω 145 W + 145 W

MONO (BTL) MODE

1 kHz, 0.7 % T.H.D. at 6 Ω 285 W

Total harmonic distortion

STEREO MODE

..... 0.02 % (20 Hz ~ 20 kHz, 130 W, 6 Ω)
..... 0.0018 % (1 kHz, 130 W, 6 Ω)
..... 0.05 % (1 kHz, 50 W, 2 Ω)

MONO (BTL) MODE

..... 0.03 % (20 Hz ~ 20 kHz, 270 W, 6 Ω)
..... 0.0018 % (1 kHz, 270 W, 6 Ω)

General

Power consumption 3.5 A
..... 320 W
..... Less than 2 W (Standby)

Dimensions

W: 440 mm (17-5/16")

H: 128 mm (5-1/32")

D: 385 mm (15-5/32")

Weight (net) 12.3 kg (27.2 lb)

- KENWOOD follows a policy of continuous advancements in development. For this reason specifications may be changed without notice.
- Manufactured under license from Lucasfilm Ltd. Lucasfilm and THX are trademarks or registered trademarks of Lucasfilm Ltd.

For U.S.A.

FCC WARNING

This equipment may generate or use radio frequency energy. Changes or modifications to this equipment may cause harmful interference unless the modifications are expressly approved in the instruction manual. The user could lose the authority to operate this equipment if an unauthorized change of modification is made.

NOTE:

This equipment has been tested and found to comply with the limits for a Class B digital device, pursuant to Part 15 of the FCC Rules. These limits are designed to provide reasonable protection against harmful interference in a residential installation. This equipment may cause harmful interference to radio communications, if it is not installed and used in accordance with the instructions. However, there is no guarantee that interference will not occur in a particular installation. If this equipment does cause harmful interference to radio or television reception, which can be determined by turning the equipment off and on, the user is encouraged to try to correct the interference by one or more of the following measures:

- Reorient or relocate the receiving antenna.
- Increase the separation between the equipment and receiver.
- Connect the equipment into an outlet on a circuit different from that to which the receiver is connected.
- Consult the dealer or an experienced radio/TV technician for help.

KENWOOD

For your records

Record the serial number, found on the back of the unit, in the spaces designated on the warranty card, and in the space provided below. Refer to the model and serial numbers whenever you call upon your dealer for information or service on this product.

Model _____

Serial Number _____

Free Manuals Download Website

<http://myh66.com>

<http://usermanuals.us>

<http://www.somanuals.com>

<http://www.4manuals.cc>

<http://www.manual-lib.com>

<http://www.404manual.com>

<http://www.luxmanual.com>

<http://aubethermostatmanual.com>

Golf course search by state

<http://golfingnear.com>

Email search by domain

<http://emailbydomain.com>

Auto manuals search

<http://auto.somanuals.com>

TV manuals search

<http://tv.somanuals.com>