

KR-910

Introduction

Your choice of this product indicates that you are a devotee to excellence in sound reproduction.

We appreciate your patronage and take pride in the long tradition of quality components, that our company represents.

So that you can get the most out of your unit, we suggest that you take the time to read through this manual before you hook up and operate your system.

This will acquaint you with operating features, and system-connection considerations, so that your listening pleasure will be enhanced right from the start. You will notice that in all aspects of planning, engineering, styling, operating convenience and adaptability, we have sought to anticipate your needs and desires.

Keep this manual handy for future reference.

For your records

Record the serial number, found on the back of the unit, in the spaces designated on the warranty card, and in the space provided below. Refer to the model and serial numbers whenever you call upon your dealer for information or service on this product.

Model KR-910 Serial Number _____

Unpacking

Unpack the unit carefully and make sure that all accessories are put aside so they will not be lost.

Examine the unit for any possibility of shipping damage. If your unit is damaged or fails to operate, notify your dealer immediately. If your unit was shipped to you directly, notify the shipping company without delay. Only the consignee (the person or company receiving the unit) can file a claim against the carrier for shipping damage.

We recommend that you retain the original carton and packing materials for use should you transport or ship the unit in the future.

Safety precautions

Service or modifications

Do not remove the cabinet or touch internal parts. Refer all service to qualified service personnel. Unauthorized modifications can result in a dangerous shock hazard and can void the warranty.

Power cord

Always insert or remove the power plug from the AC outlet by grasping the plug body. Never pull or stretch the cord. Take care that the cord is not subject to traffic or bent sharply around furniture. Keep heavy objects off the cord; never route it under rugs, and avoid the use of extra extension cords. Attention to these precautions will avoid fire or shock hazards.

Installation precautions

- a) Avoid locations subject to direct sunlight.
- b) Avoid high or low temperature extremes.
- c) Keep the unit away from heat radiating sources.
- d) Choose a location that is relatively free of vibration or excessive dust.
- e) Make sure power is off before making any system connections.
- f) Always place the unit horizontally.

Before applying power

Important!

U.S.A. and Canada

Units shipped to the U.S.A. and Canada are designed for operation on 120 volts AC only. These units are not equipped with an AC voltage selector switch and the discussion of such a switch that follows should be disregarded.

All other countries

Units shipped to countries other than the U.S.A., Canada and U.K. are equipped with an AC voltage selector switch on the rear panel. Refer to the following paragraph for the proper setting of this switch.

AC voltage selection

This unit operates on 110 – 120 volts or 220 – 240 volts AC. The AC voltage selector switch on the rear panel is set to the voltage that prevails in the area to which the unit is shipped. Before connecting the power cord to your AC outlet, make sure that the setting position of this switch matches your line voltage. If not, it must be set to your voltage in accordance with the following direction.

Note:

Our warranty does not cover damage caused by excessive line voltage due to improper setting of the AC voltage selector switch.

For United Kingdom

The mains plug must be removed from the wall socket prior to any internal examination.

Important

The wires in this mains lead are coloured in accordance with the following code:

Blue..... Neutral
Brown..... Live

The wires in this mains lead must be connected to the terminals in the plug as follows:

Wire colour

Plug terminal marking

Blue..... N or Black
Brown..... L or Red

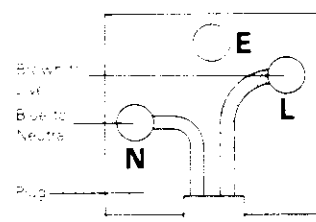

Notes:

1. If a 13-amp plug is used, this must be fitted with a 5-amp fuse.
2. If a 3-pin plug with earthing contact is used, no wire must be connected to the E terminal.

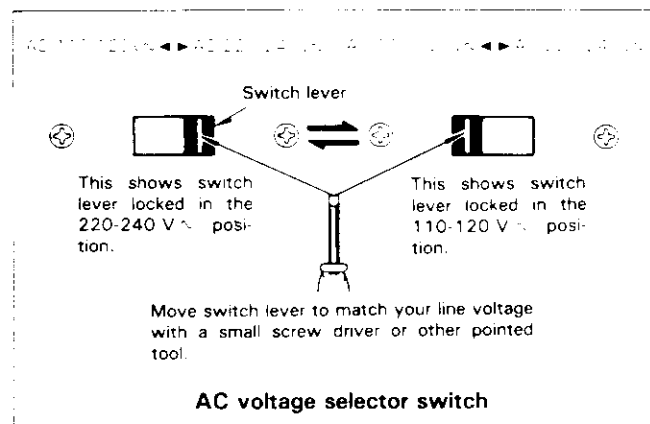

WARNING:

TO PREVENT FIRE OR ELECTRIC SHOCK, DO NOT EXPOSE THIS APPLIANCE TO RAIN OR MOISTURE.

Safety precautions

| | |
|--|---|
| <p style="text-align: center;">CAUTION RISK OF ELECTRIC SHOCK DO NOT OPEN</p> | <p>CAUTION- TO REDUCE THE RISK OF ELECTRIC SHOCK, DO NOT REMOVE COVER (OR BACK). NO USER-SERVICEABLE PARTS INSIDE. REFER SERVICING TO QUALIFIED SERVICE PERSONNEL.</p> |
| | <p>The lightning flash with arrowhead symbol, within an equilateral triangle, is intended to alert the user of the presence of uninsulated "dangerous voltage" within the product's enclosure, that may be of sufficient magnitude to constitute a risk of electric shock to persons.</p> |
| | <p>The exclamation point within an equilateral triangle is intended to alert the user of the presence of important operating and maintenance (servicing) instructions in the literature accompanying the appliance.</p> |

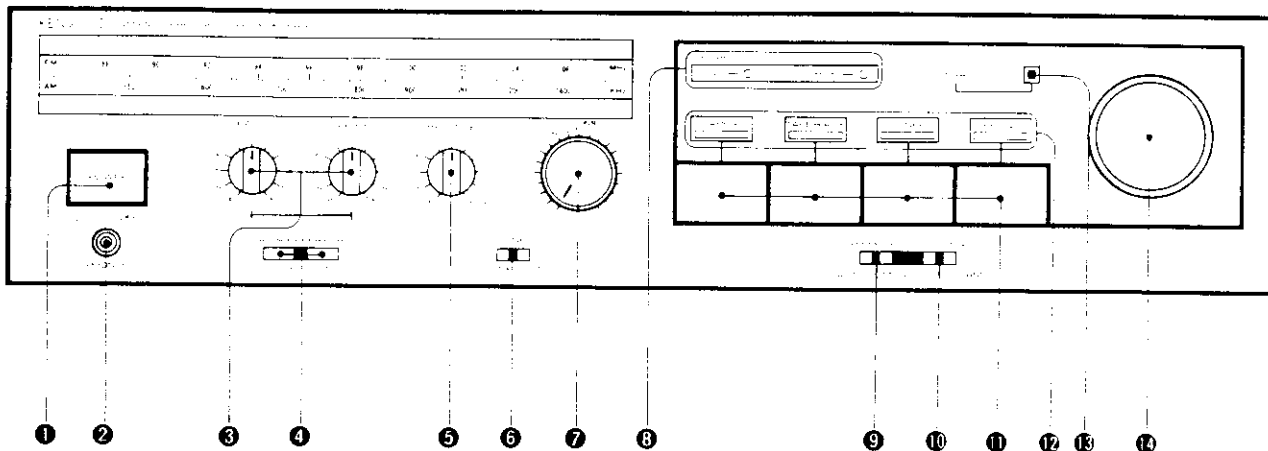

1 POWER switch

Turns the power to the unit on and off.

2 PHONES jack

Stereo headphones are plugged into this jack.

3 BASS and TREBLE controls

Turn clockwise to increase bass or treble response, counterclockwise to reduce bass or treble response. Response is flat when set to the center.

4 SPEAKERS switches

A, B OFF — Silences all speakers to permit private use of headphones.

A ON — Activates speakers connected to the SPEAKERS A terminals on the rear panel.

B ON — Activates speakers connected to the SPEAKERS B terminals on the rear panel.

A, B ON — Activates speakers connected to the SPEAKERS A and B terminals simultaneously.

5 BALANCE control

This control permits balancing of left and right channels when an imbalance exists in the sound source or to correct acoustic imbalance due to room conditions. Turn it to the left from the center position to boost the left channel, turn it to the right of center to raise the level of the right channel.

6 LOUDNESS switch

This switch boosts bass response to compensate for the lack of response in human hearing to those frequencies at low volume levels. This switch should be switched off when listening at normal and high levels.

7 VOLUME control

This control adjusts left- and right-channel volume simultaneously. Set it for the desired listening level.

8 SIGNAL indicators

These indicators show the relative signal levels of incoming broadcasts. For best reception, both the FM and AM antennas should be installed so that both the LOW and HIGH lamps will light.

9 FM MODE switch

AUTO — The receiver switch automatically between stereo and monaural operation in accordance with the manner in which the selected station is operating. And this position is applied to silence interstation noise when tuning. To receive very weak stations, stations that are too weak to overcome the muting threshold, push in to disable muting (MONO).

MONO — Provides monaural operation regardless of the transmitting mode.

10 SELECTOR switches

FM — For reception of FM broadcasts.

AM — For reception of AM broadcasts.

11 Input selector switches

TAPE A — Push this button to select input from a tape deck connected to the TAPE A jacks.

TAPE B/AUX — Push this button to select input from a component connected to the TAPE B PLAY/AUX jacks, or to dub from a tape deck connected to the TAPE B PLAY/AUX jacks to a tape deck connected to TAPE A jacks. The TAPE B/AUX button is only selected to the playback.

TUNER — Push this button to listen to broadcasts.

PHONO — Push this button to select input from a turntable connected to the PHONO jacks.

Note:

The input selector switch has priority. The order of priority is TAPE A, TAPE B/AUX and TUNER or PHONO. For example, when the TAPE A, TAPE B/AUX and TUNER indicators light yellow, TAPE A has priority.

12 Input selector indicators

These indicators turn from green to yellow when the corresponding input selector switches are pressed.

13 STEREO indicator

With the FM MODE switch set to AUTO the lamp lights to indicate that the selected station is broadcasting in stereo. It remains out for monaural broadcasts and when the FM MODE switch is set to MONO.

14 TUNING knob

AM and FM stations are selected by turning this knob.

System connections

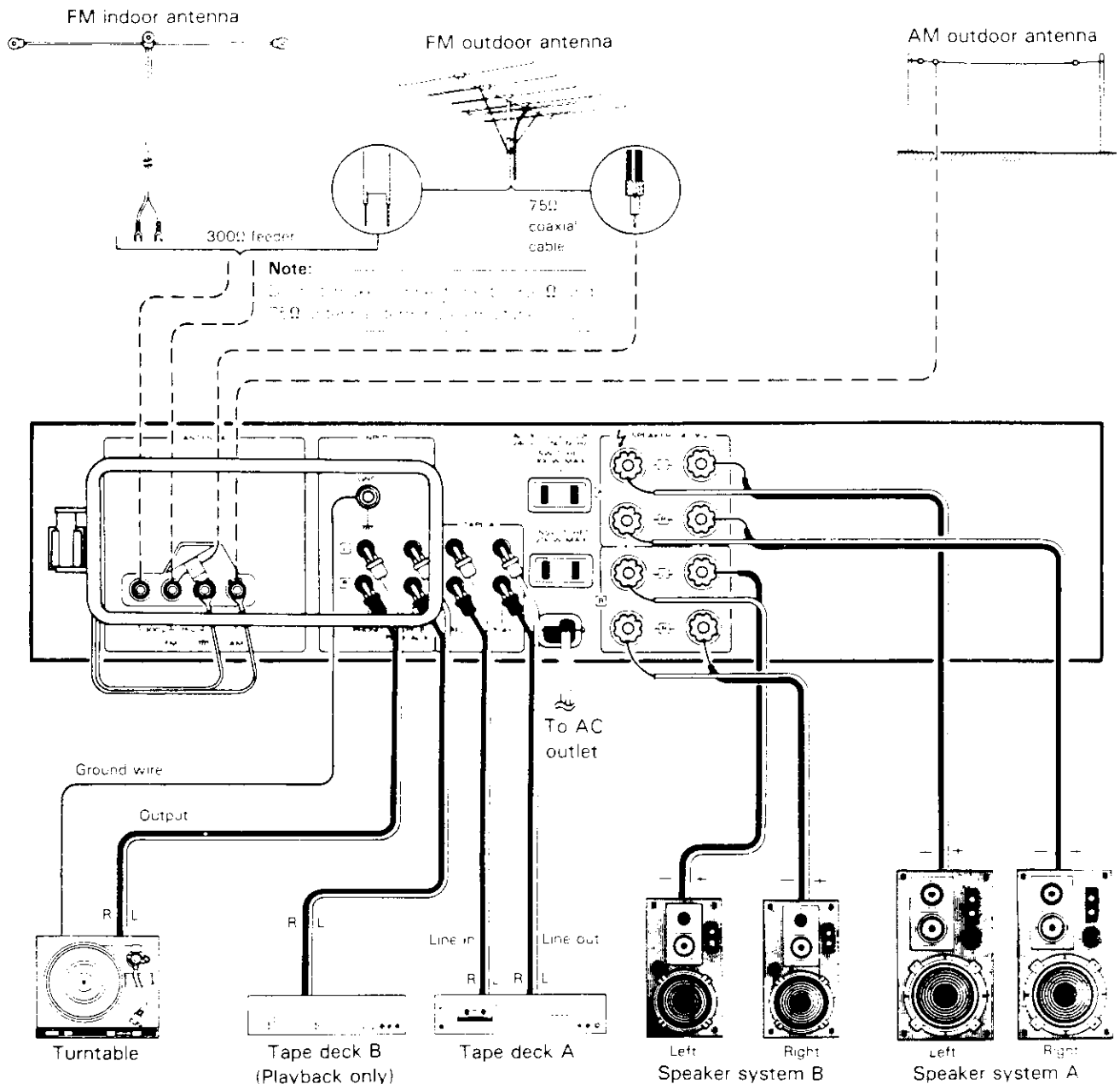

Speakers



If only one set of speakers is to be connected, make connections to the terminals marked **SPEAKERS A**. Connect the speakers to the **1** and **2** terminals in accordance with the location selected for each speaker. To ensure correct speaker phasing, observe polarity marks; connect terminals marked (+) on the receiver to similarly-marked speaker terminals. Do the same for receiver and speaker terminals marked with a minus sign. Reversal of speaker leads will result in loss of bass tones and poor stereo separation.

If a second set of speakers is to be used make connections at the set of terminals, marked **B**.

It is recommended that the tips of the speaker leads be soldered, or the strands of individual leads be twisted together to eliminate any possibility of short circuits forming in the speaker connecting network.

Note:

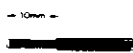
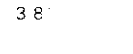
When connecting speakers to the units shipped to the U.S.A. and Canada, be sure that each speaker must be rated at a minimum 16-watt. Units shipped to the countries other than the U.S.A. and Canada, 16-watt speakers must be used.

-  Remove insulation from lead tip
-  3/8"
-  Twist wire tightly, and solder.

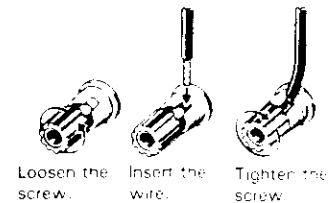



Fig. 1 Speaker lead connection

Tape decks



If only one tape deck is to be connected to the system it is recommended that it be connected to the jacks marked TAPE A.

Tape deck input and output cables are normally terminated with phone plugs.

Playback

Plug the left and right output cables of the tape deck into the  and  TAPE A PLAY jacks.

Record

Plug the left and right input cables of the tape deck into the  and  TAPE A REC jacks.



Second tape deck

Plug the output cables from the second tape deck into the TAPE B PLAY/AUX jacks.

TAPE B PLAY/AUX

The TAPE B PLAY/AUX jacks are used to connect other high-level signal sources, such as extra tape decks, tuners, TV or VTR sound outputs, mic preamps, etc.

Turntable

Your stereo turntable has two audio cables that are terminated with phone plugs. Plug the left and right channel plugs into the  and  PHONO input jacks, as shown.

If the turntable has a ground wire, connect it to this unit's GND terminal to avoid hum.

Ground

For maximum safety, and minimum interference connect the GND terminal to a good earth ground if practicable. A good earth ground is a cold water pipe or a metal stake driven into moist earth.

FM antennas

FM outdoor antenna

Consult with your dealer or service man about the best method of selecting and erecting an outdoor FM antenna. The choice of lead-in (feeder) wire is also important. The flat ribbon-shaped twin lead performs well electrically, is cheaper and is somewhat easier to handle in routing through windows and around rooms. Coaxial cable is more expensive, does a much better job of minimizing interference, is less prone to the effects of weather and close-by metal objects, and is nearly as good a signal conductor as the ribbon type wire. The latter is particularly true of foam-type coaxial cables. Coaxial cable is somewhat more difficult to install at the point where the cable enters the building. If coaxial cable is selected, make sure the antenna is designed to drive that type of cable. In many cases a matching transformer (balun) must be used to connect the antenna terminals to the coaxial cable.

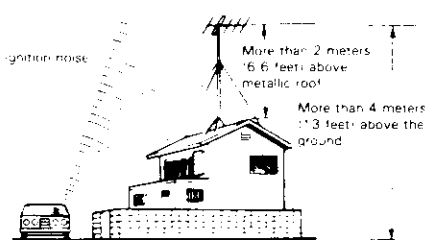

Fig. 2 FM outdoor antenna installation

- To minimize auto-ignition noise, locate the antenna as far from heavy traffic as possible.
- Keep the feeder or coaxial cable as short as possible. Do not bundle or roll up excess cable.
- The antenna should be at least two meters (6.6 feet) from reinforced concrete walls, or metal structures.

FM indoor antenna

Connect the T-shaped indoor antenna (supplied) to the 300 Ω FM ANTENNA terminals as shown in the system connection diagram. Spread the two arms that form the top of the "T" horizontally and hold them against convenient wall surfaces. Try several locations for best results on your favorite stations. Tape the antenna in place where the best compromise is found between listening results and appearance.

AM antennas

AM loop antenna

Tune in your favorite AM station and position the Loop antenna for best reception. Try other stations and find the position that gives best overall reception.

When this unit is mounted in a rack or placed on a shelf with insufficient space behind, remove the loop antenna and hang it from a wall in the direction which gives best reception. If the length of the lead wire is too short, add a lead wire of an appropriate length.

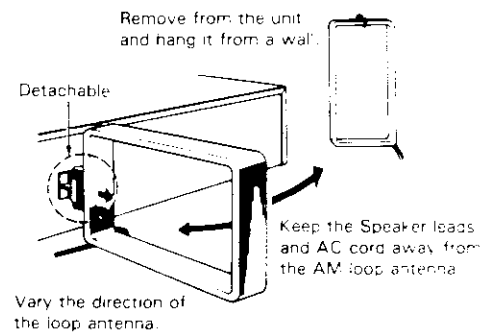

Fig. 3 AM loop antenna setting

AM outdoor antenna

In steel buildings or at a great distance from the transmitter, it may be necessary to install an outside longwire antenna. The end of this wire should be stripped of insulation and connected to the AM terminal. At this time, keep the loop antenna connected.

AC outlets

The AC outlets on the rear panel of the unit may be used to supply power to other components such as a turntable, tape deck, etc. Never connect here any equipment whose power consumption exceeds the capacity of each outlet.

1. SWITCHED outlet: This is 100 watts maximum in capacity and is controlled by the POWER switch on the front panel.
2. UNSWITCHED outlet: This is 200 watts maximum in capacity and power is available at all times.

Operating instructions

AM-FM reception

1. Push the TUNER button. Confirm that only the TUNER indicator turns yellow.
2. Set the SELECTOR switch to AM or FM.
3. Turn the TUNING knob to place the tuning pointer at the desired frequency. The SIGNAL lamps indicate the level of the incoming signal. With weak signals, only the LOW lamp will light, both the LOW and HIGH lamps will light with strong signals.
4. In the FM mode, the STEREO indicator will light when the FM MODE switch is set to AUTO and a stereo broadcast is strong enough to overcome muting.
5. Adjust VOLUME and tone for your preference.

Abnormal condition on FM reception

6. In cases where the desired signal is extremely weak, a high frequency noise (hiss) may accompany stereo broadcasts. In such case better results may be obtained by setting the FM MODE switch to MONO.

Turntable

1. Push the PHONO button. Confirm that only the PHONO indicator turns yellow.
2. Operate the turntable.
3. Adjust VOLUME and tone for your preference.

TAPE B/AUX

1. Push the TAPE B/AUX button.
2. Operate the component (tape deck, TV, etc.) connected to the TAPE B PLAY/AUX jacks.
3. Adjust VOLUME and tone for your preference.

Tape decks

Playback

1. Push the TAPE A or B/AUX button to select input from a tape deck connected to the TAPE A or TAPE B PLAY/AUX jacks.
2. Operate the tape deck.
3. Adjust VOLUME and tone for your preference.

Recording

1. Push the PHONO, TUNER or TAPE B/AUX button to select the desired program source.
2. Set up the program source component for operation and set up your tape deck connected to the TAPE A jacks for recording.
3. Set recording level with the controls on your tape deck.
4. To monitor the recording, push the TAPE A button. The volume and tone controls on the receiver do not affect the signal recorded.

Note:

The tape deck connected to the TAPE B PLAY/AUX jacks can only be used for playback.

Monitoring

If the tape deck connected to the TAPE A jacks is equipped with three heads, you can compare the sound quality of recording in progress with that of the source material by pushing the TAPE A button while the recording is being made.

Tape-to-tape dubbing

1. Push the TAPE B/AUX button.
2. Set the tape deck connected to the TAPE A jacks in the recording mode and operate the tape deck connected to the TAPE B PLAY/AUX jacks simultaneously.
3. Set recording levels on the deck which is being used for recording using that deck's operating controls.
4. To monitor the recording, push the TAPE A button. The volume and tone controls on the receiver do not affect the signal recorded.

Note:

Dubbing is only possible from a tape deck connected to the TAPE B PLAY/AUX jacks to a tape deck connected to the TAPE A jacks.

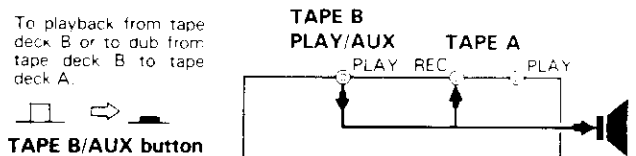
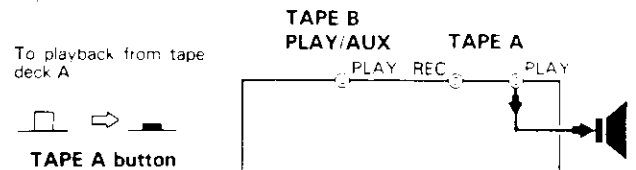
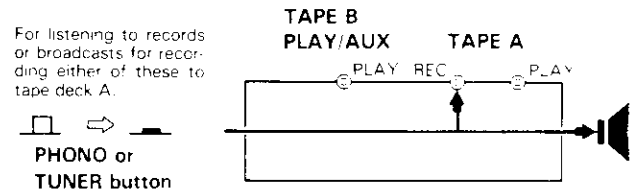
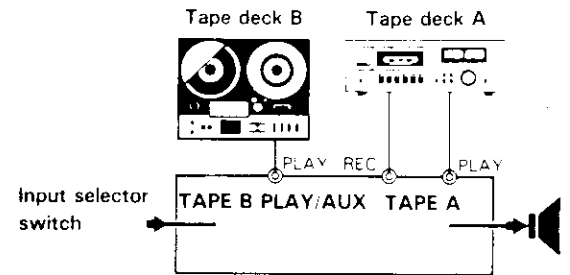

In case of difficulty

If your unit should not perform as expected, consult the table below to see if the problem can be corrected before seeking help from your dealer or service representative.

| Occurs during AM reception only | Cause | Remedy |
|--|--|--|
| Continuous low-frequency buzz. Most noticeable on weak stations or at night. | Interference from fluorescent lamps, lamp dimmers, other appliances. | Turn off fluorescent lamps or lamp dimmer. (Interference may come from neighbor's lamps.) Try AM outdoor antenna and good ground at GND connections. This problem may be impossible to remove altogether. |
| High-frequency whistle especially at night. | Interference from TV set. Beat from adjacent AM station. | Turn off TV set, if problem disappears try relocating TV set. Impossible to eliminate. |
| Occurs during FM reception only | Cause | Remedy |
| Continuous hiss or buzzing with broadcast. | Weak antenna signal. | Install outdoor antenna. |
| Occasional sharp rhythmic cracking noise. | Ignition interference from autos. | Locate outdoor antenna as far from road as possible, use coaxial feeder cable. |
| FM automatic circuit fail to respond to stereo broadcast. | Incoming signal is too weak. | Reposition indoor antenna or erect an outdoor antenna. |
| PHONO playback only | Cause | Remedy |
| No sound from both or one speaker. | Turntable output disconnected. | Check phono cables. |
| Load hum drowns out sound. | Poor ground connection at phono-cable connections. | Check phono plugs, particularly outer-shell connections. |
| Background buzz. | TV signal picked up by phono cable (especially near transmitter). | Route phono cables to minimize buzz. |

Audio Section

Power Output
30 watts* per channel minimum RMS, both channels driven at 8 ohms from 40 Hz to 20,000 Hz with no more than 0.09% total harmonic distortion.

| | |
|--|--|
| Both Channels Driven | |
| Into 8 ohms at 1,000 Hz | 31 W + 31 W |
| Into 4 ohms at 1,000 Hz | 31 W + 31 W |
| Dynamic Power Output at 4 ohms | 100 W |
| Total Harmonic Distortion (40 Hz to 20,000 Hz from AUX) | |
| rated power into 8 ohms | 0.09% |
| 1 watt power into 8 ohms | 0.05% |
| Intermodulation Distortion (60 Hz:7 kHz = 4:1 SMPTE) | |
| rated power into 8 ohms | 0.04% |
| 1 watt power into 8 ohms | 0.03% |
| Damping Factor | 30 at 1 kHz, 8 ohms |
| Input Sensitivity/Impedance | |
| PHONO | 2.5 mV/50k ohms |
| TAPE, AUX | 150 mV/50 k ohms |
| Signal to Noise Ratio (A weighted) | |
| PHONO | 72 dB for 2.5 mV input 78 dB for 5.0 mV input |
| TAPE, AUX | 100 dB for 150 mV input |
| Maximum PHONO Input Level | |
| at 1,000 Hz | 120 mV (RMS), THD 0.05% |
| Frequency Response | |
| PHONO RIAA Standard Curve | 20 Hz to 20,000 Hz ± 0.3 dB |
| TAPE, AUX | 10 Hz to 100 kHz +0 dB, -3 dB |
| Tone Control | |
| BASS | ± 8 dB at 100 Hz |
| TREBLE | ± 8 dB at 10 kHz |
| Loudness Control (VOL. -30 dB) | +10 dB at 100 Hz |
| Output Level/Impedance | |
| TAPE REC Out (Pin) | 150 mV/560 ohms |

FM Tuner Section

| | |
|--|---|
| Usable Sensitivity | 10.8 dBf (1.9 μ V) |
| 50 dB Quieting Sensitivity | |
| Mono | 17.2 dBf (4.0 μ V) |
| Stereo | 37.2 dBf (140 μ V) |
| Signal-to-Noise Ratio at 65 dBf | |
| Mono | 75 dB |
| Stereo | 70 dB |
| Total Harmonic Distortion at 1,000 Hz | |
| Mono | 0.1% |
| Stereo | 0.2% |
| Frequency Response | |
| | 30 Hz to 15,000 Hz, +0.2 dB, -0.2 dB |
| Capture Ratio | 1.5 dB |
| Image Rejection Ratio | 50 dB |
| Spurious Response Ratio | 80 dB |
| IF Response Ratio | 90 dB |
| Alternate Channel Selectivity | 45 dB at 400 kHz |
| AM Suppression Ratio | 65 dB |
| Stereo Separation Ratio | |
| | 40 dB at 1,000 Hz |
| | 35 dB at 50 Hz to 10 kHz |
| Subcarrier Product Ratio | 45 dB |
| Antenna Impedance | 300 ohms balanced and 75 ohms unbalanced |
| FM Frequency Range | 87.5 MHz to 108 MHz |

AM Tuner Section

| | |
|-----------------------|------------|
| Usable Sensitivity | 13 μ V |
| Signal-to-Noise Ratio | 48 dB |
| Image Rejection | 45 dB |
| Selectivity | 25 dB |

General

| | |
|--------------------------|-------------------------------|
| Power Consumption | |
| | 1.1 A (UL and CSA) |
| | 120 W (8 ohms at rated power) |
| | 22 W (No Signal) |
| AC Outlet | |
| | Switched 1, Unswitched 1 |
| Dimensions | |
| W | 440 mm (17-5/16") |
| H | 109 mm (4-19/64") |
| D | 250 mm (9-51/64") |
| Weight (Net) | |
| | 5.2 kg (11.4 lb) |
| (Gross) | |
| | 5.8 kg (12.8 lb) |

* Measured pursuant to Federal Trade Commission's Trade Regulation rule on Power Output Claims for Amplifier in U.S.A.

Note:

We follow a policy of continuous advancements in development. For this reason specifications may be changed without notice.

Audio Section

| | |
|---|---------------------------------|
| Rated Power Output | |
| 8 ohms at 40 Hz to 20 kHz no more than 0.09% T.H.D. (FTC) | 30 W + 30 W |
| 4 ohms at 63 Hz to 12.5 kHz no more than 0.7% T.H.D. (IEC) | 30 W + 30 W |
| Total Harmonic Distortion | |
| Rated Power Output into 8 ohms | 0.09% |
| Intermodulation Distortion | |
| | 0.04% |
| Frequency Response | |
| | 10 Hz ~ 100 kHz +0 dB, -3 dB |
| S/N Weighted: Rated Output Power (IEC-A) | |
| () = Unweighted, at 50 mV (DIN) | |
| PHONO | 72 dB (55 dB) |
| TAPE, AUX | 100 dB (60 dB) |
| Damping Factor at 8 ohms, 1 kHz | 30 |
| Input Sensitivity/Impedance | |
| PHONO | 2.5 mV/50 k Ω |
| TAPE, AUX | 150 mV/50 k Ω |
| Tone Control | |
| Bass 100 Hz | ± 8 dB |
| Treble 10 kHz | ± 8 dB |
| Loudness Control (-30 dB) | +10 dB at 100 Hz |

FM Tuner Section

| | |
|----------------------------------|--------------------------------------|
| Sensitivity at 75 ohms | |
| Mono: S/N 26 dB, 40 kHz Dev. | 0.9 μ V |
| Stereo: S/N 46 dB, 46 kHz Dev. | 25 μ V |
| Limiting Level | |
| -3 dB Point, 40 kHz Dev. | 0.9 μ V |
| Frequency Response | |
| | 30 Hz to 15 kHz, +0.2 dB, -2.0 dB |
| Total Harmonic Distortion | |
| Mono: 1 kHz, 40 kHz Dev. | 0.15% |
| Stereo: 1 kHz, 46 kHz Dev. | 0.3% |
| S/N Weighted (IEC-A) | |
| Mono: 40 kHz Dev., 1 mV Input | 70 dB |
| Stereo: 46 kHz Dev., 1 mV Input | 65 dB |
| S/N Ratio (IHF) | |
| Mono: 75 kHz Dev., 1 mV Input | 75 dB |
| Stereo: 75 kHz Dev., 1 mV Input | 70 dB |

FM Stereo Separation : 1 mV Input (DIN)

| | |
|------------------------------|--------|
| 250 Hz | 38 dB |
| 1 kHz | 40 dB |
| 6.3 kHz | 35 dB |
| 12.5 kHz | 30 dB |
| Image Rejection Ratio | |
| | 50 dB |
| Selectivity | |
| 300 kHz, 20 dB Input | 70 dB |
| IF Rejection Ratio | 90 dB |
| AM Suppression Ratio | 65 dB |
| Spurious Response Ratio | 80 dB |
| Capture Ratio | 1.5 dB |

AM Tuner Section

| | |
|-----------------------|------------|
| Sensitivity S/N 20 dB | 13 μ V |
| S/N Ratio: 1 mV Input | 48 dB |
| Image Rejection Ratio | 45 dB |

General

| | |
|--------------------------|--------|
| Power Consumption | |
| IEC | 200 W |
| Rated Power at 8 ohms | 120 W |
| No signal | 22 W |
| Dimensions | |
| W | 440 mm |
| H | 109 mm |
| D | 250 mm |
| Weight (net) | |
| | 5.2 kg |

Free Manuals Download Website

<http://myh66.com>

<http://usermanuals.us>

<http://www.somanuals.com>

<http://www.4manuals.cc>

<http://www.manual-lib.com>

<http://www.404manual.com>

<http://www.luxmanual.com>

<http://aubethermostatmanual.com>

Golf course search by state

<http://golfingnear.com>

Email search by domain

<http://emailbydomain.com>

Auto manuals search

<http://auto.somanuals.com>

TV manuals search

<http://tv.somanuals.com>