

2

Using your Kenwood Audio System

Spectrum 360

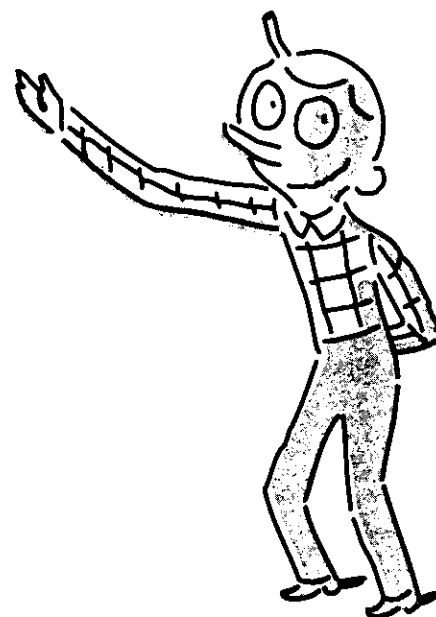

KENWOOD

Contents

Welcome.....	5	Using the CD player.....	20
Using the controls.....	6	The front panel controls and display	20
Front panel controls	6	Before using the CD player	22
Reading the display	7	Compatible CDs.....	22
Remote.....	8	Handling CDs.....	22
A few tips	8	Cleaning CDs.....	22
Loading and replacing the batteries	9	Storing CDs.....	22
The basic audio functions.....	10	Damaged CDs.....	22
Selecting the input source	10	Condensation.....	22
The tape 2 monitor input	10	Before you transport your CD player.....	22
Adjusting the volume	11	Loading CDs	23
Adjusting the tone	11	Changing CDs	23
Activating the speakers	12	Displaying CD time information	23
Adjusting the speaker balance	12	Playing CDs.....	24
Muting the sound	13	From the beginning	24
Making the sound fuller at low volumes	13	From a specific track	25
Using SRS 3D sound	14	Playing a combination of tracks	26
Using headphones.....	15	Programming tracks.....	26
Using the tuner.....	16	To check a program.....	27
Tuning stations automatically	16	To resume normal play.....	27
Tuning stations manually	16	To cancel a program and stop play.....	27
Storing preset stations	17	Adding a track to a program.....	27
Tuning preset stations	17	Changing a track in a program.....	27
Scrolling through preset stations	18	Clearing a track in a program.....	27
Using the Equalizer.....	19	Clearing a whole program.....	27
Front panel controls	19	Playing CDs over (repeat play)	28
To change the tone quality.....	19	Repeating a single CD.....	28
To listen without any equalizer effect.....	19	Repeating all loaded CDs.....	28
		Repeating programmed tracks.....	28
		To stop repeat play.....	28
		Playing tracks in random order (random play)	29
		To select another track during random play.....	29
		To cancel random play.....	29
		Using a timer to play CDs	29

Using the cassette deck	30	Specifications	40
The front panel controls and display	30	Receiver (KR-597)	40
Before using the cassette deck	32	CD player (DP-R797)	40
Preventing accidental recording on		Cassette deck (KX-W597)	41
pre-recorded tape	32	Equalizer (KE-597)	41
If there is slack in the tape	32	Speakers (JL-507)	41
Storing cassettes.....	32		
Special tapes.....	32		
Listening to tapes	33		
Playing tapes	33		
Fast-winding tapes	33		
Recording tapes	34		
Setting the recording level	34		
Recording a tape	35		
To pause the recording.....	35		
To resume recording	35		
To stop recording	35		
Copying (dubbing) a tape	35		
To pause recording	35		
To resume recording	35		
To stop recording	35		
Maintaining the cassette deck	36		
Cleaning the heads	36		
Demagnetizing the heads	36		
Troubleshooting guide	37		
Receiver	37		
CD player	38		
Cassette deck	38		

Welcome

Now that you've set up your SPECTRUM system, the real fun begins! Operating your system is easy, if you follow the step-by-step instructions in this manual. Spend a little time with the manual before you jump in, so you become familiar with the many capabilities of your system. You'll find a handy table of contents to guide you to the information you need. Then put up your feet, sit back and enjoy the fabulous sound of your SPECTRUM system!

Using the controls

Front panel controls

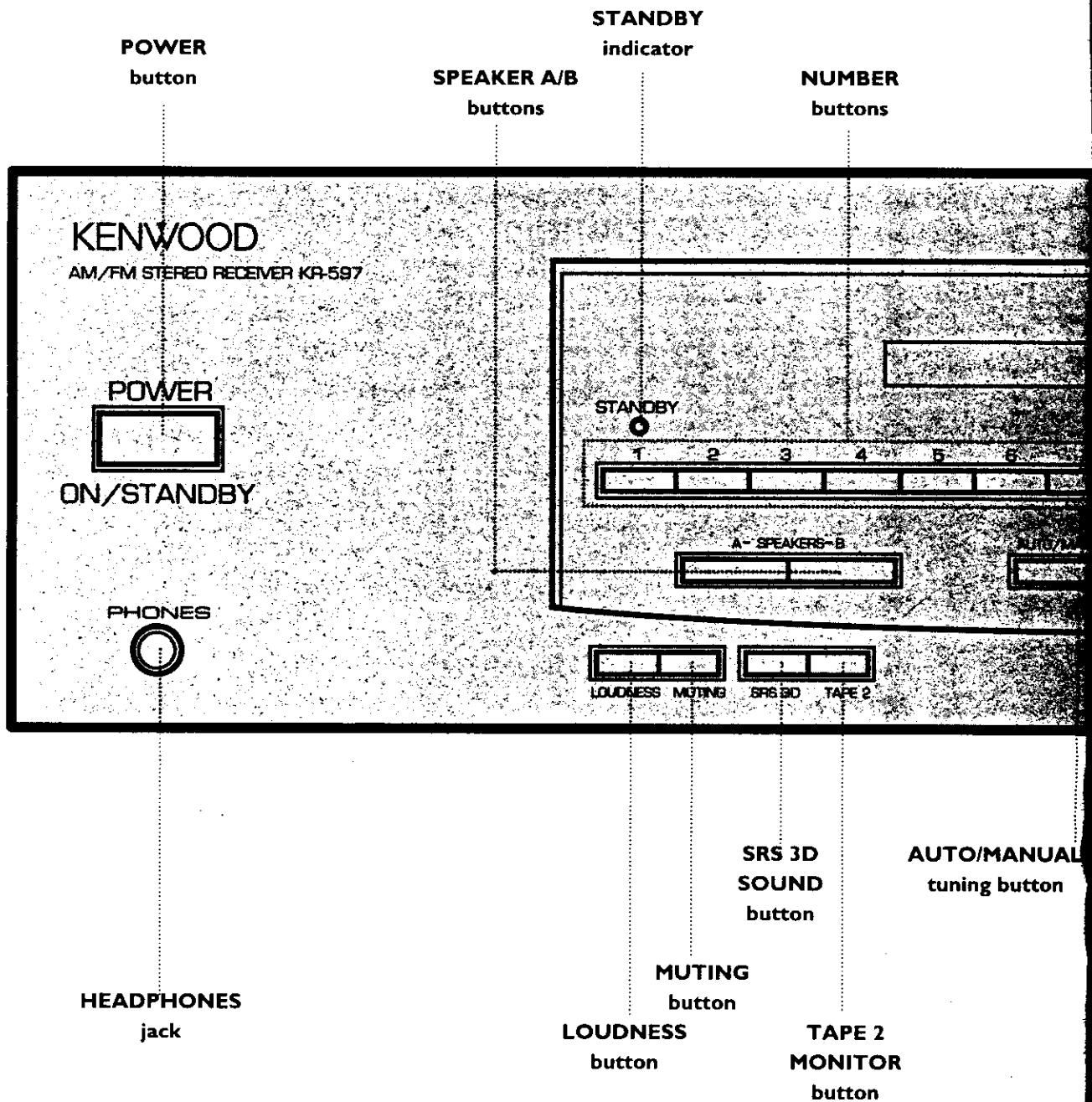

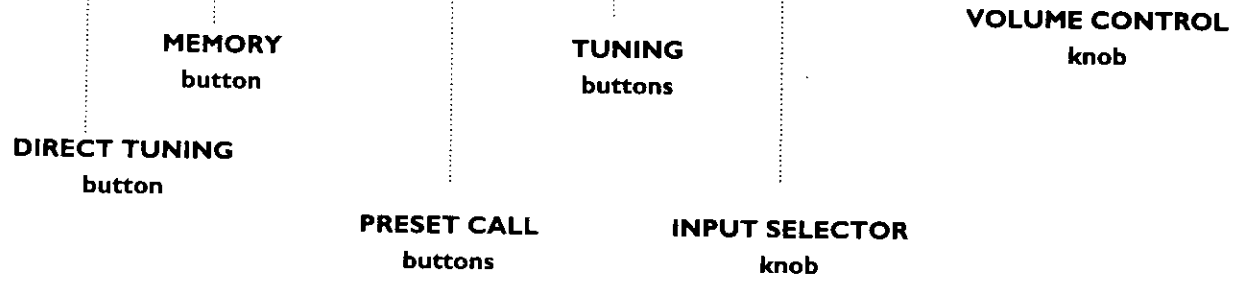
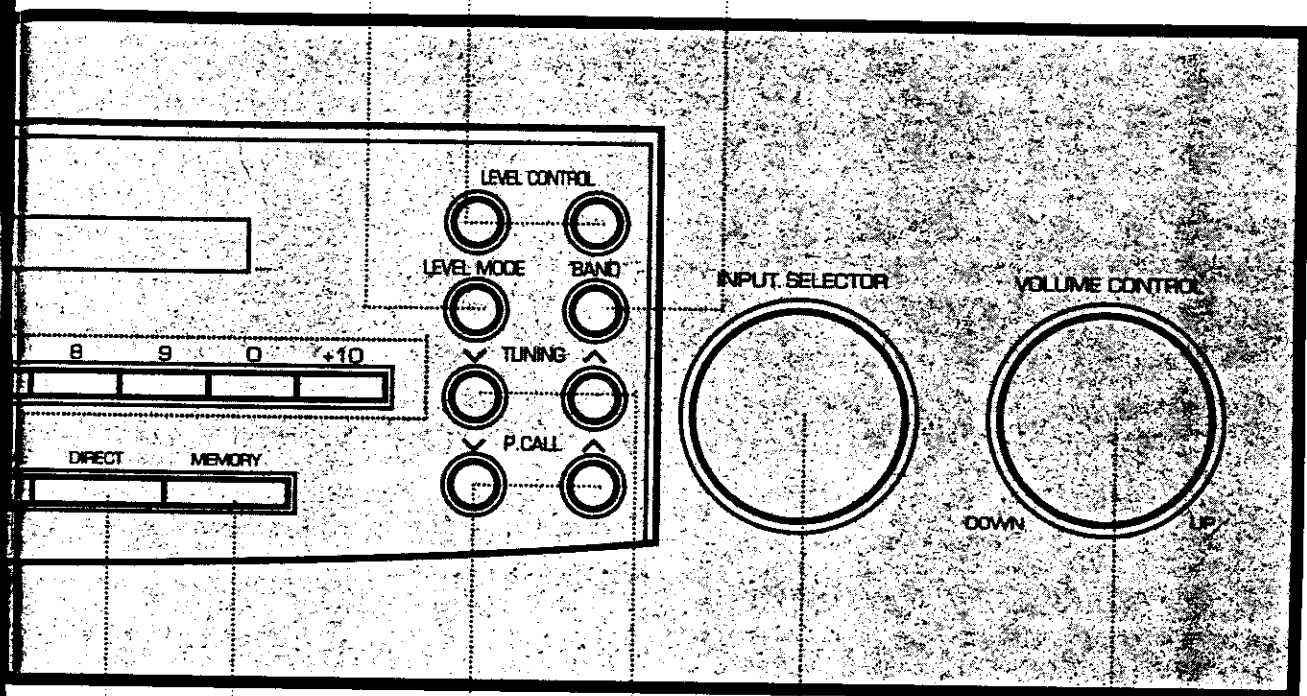
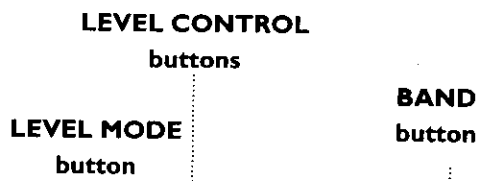
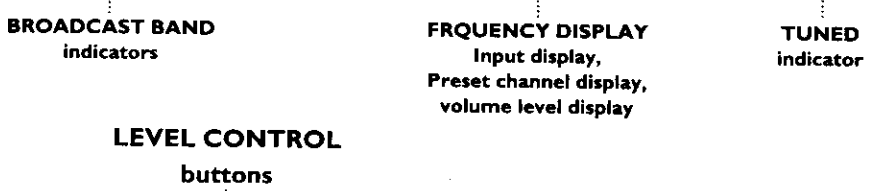
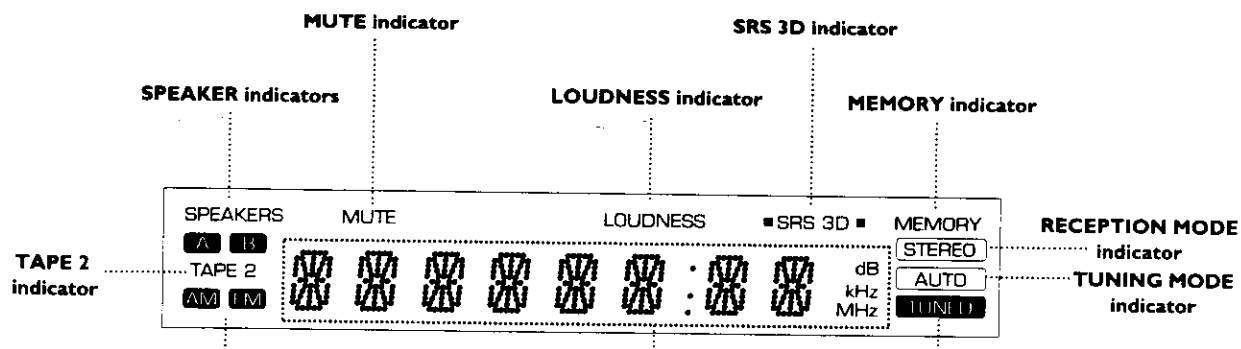

The remote

You can use your SPECTRUM system remote for many functions.

A few tips

- Depending on temperature, humidity and other environmental conditions, the operating range of your remote is approximately 30' and up to 30° on either side of the receiver's remote light sensor.
- When the operating distance of your remote begins to get shorter, replace both alkaline batteries with new ones.

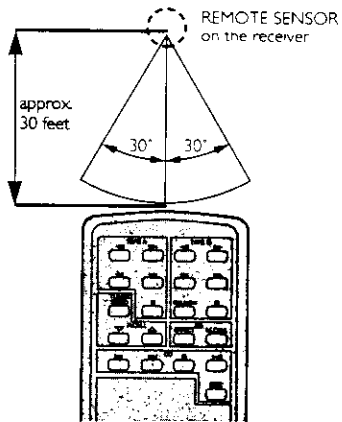

- When you press 2 buttons one after the other, press each button securely for more than 1 second each.
- The remote may malfunction if direct sunlight or high-frequency fluorescent light enters the light sensor. In this case, either move the audio system or remove the light source.

Important:

The batteries that came with this system are test batteries and may not last as long as alkaline batteries.

POWER button

- Press to turn the system on and off.

TUNER BAND button

- Press to select AM or FM
- **P. CALL Buttons:** Press to scroll through preset stations

CD PLAYER buttons

- Press **▶||** to play a disc, press again to pause the disc
- Press **■** to stop the disc
- Press **▶▶** to skip to the next track
- Press **◀◀** to skip to the previous track
- Press **DISC SKIP** to change to next disc

SRS-3D

Sound button
Press to activate SRS 3D sound

LEVEL MODE button

Press to activate balance, bass and treble adjustments

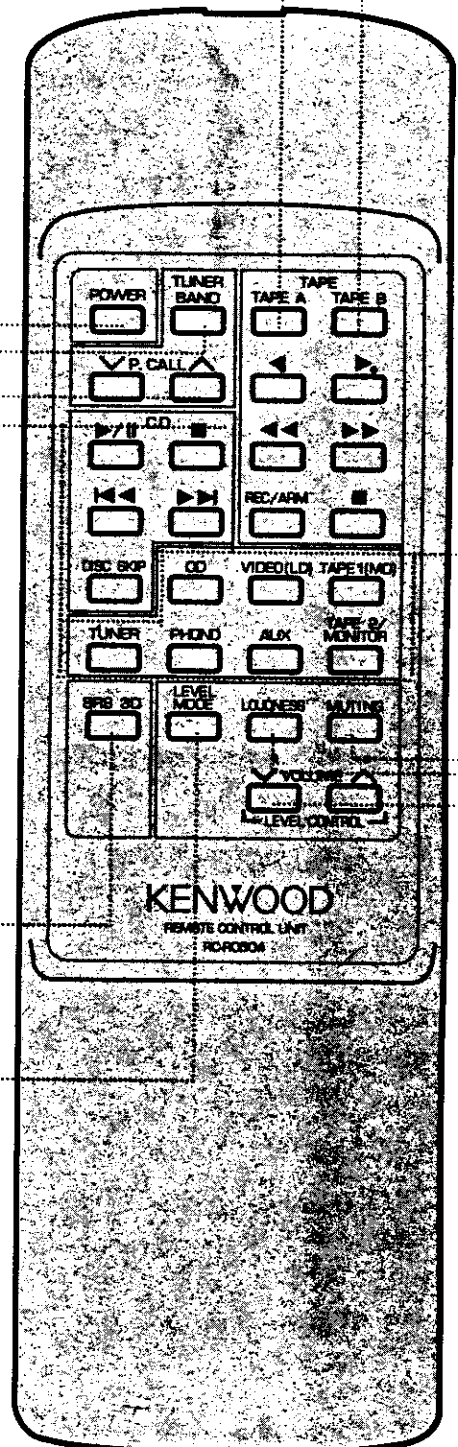

..... **TAPE DECK buttons**

Note: These buttons only work with a Kenwood cassette deck with system control connections (not included with this system)

- Press ◀ or ▶ to play or reverse the tape
- Press ◀◀ or ▶▶ to fast-forward or rewind the tape
- Press ■ to stop the tape
- Press REC/ARM to put the player into the RECORD/PAUSE mode

..... **INPUT buttons**

Press to select the input source

..... **MUTE button**

Press to MUTE the sound; press again to restore the sound

..... **LOUDNESS button**

Press to activate the loudness circuit

..... **VOLUME buttons**

Press ▲ or ▼ to increase or decrease volume. In level control mode, press to make balance, bass and treble adjustments

Loading and replacing the batteries

If the receiver doesn't respond when you press a button on the remote, you need new batteries. We recommend replacing both batteries at the same time for longer battery life.

- 1 Remove the cover by pushing in at the indentation and sliding it off in the direction of the arrow.
- 2 Insert 2 AA-size alkaline batteries (be sure to pay attention to the (+) and (-) signs when you're inserting the batteries).
- 3 Close the cover.

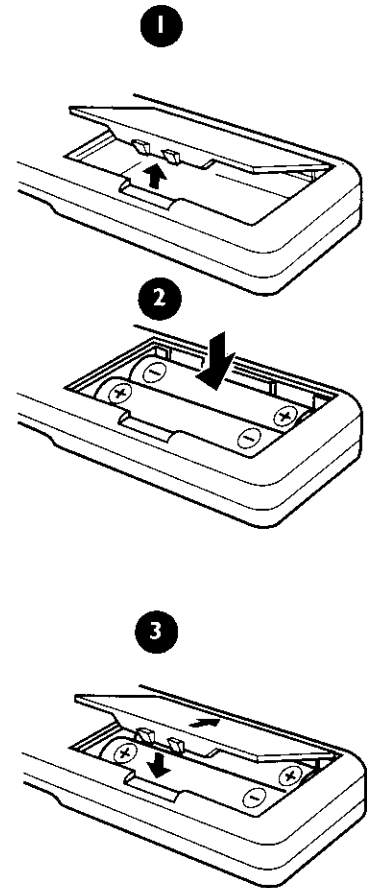

The basic audio functions

Selecting the input source

You can play audio from as many as 5 different sources, including:

- TUNER
- CD
- PHONO
- TAPE
- VIDEO
- AUX

Selecting from the front panel

Rotate the INPUT SELECTOR knob until you see the input source you want on the display.

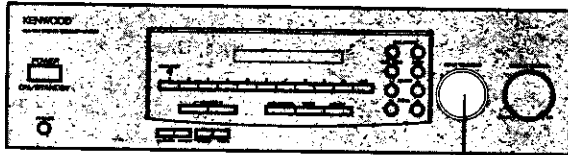

Selecting from the remote

Press the button for the source you want to listen to. You will see the input source you want on the display.

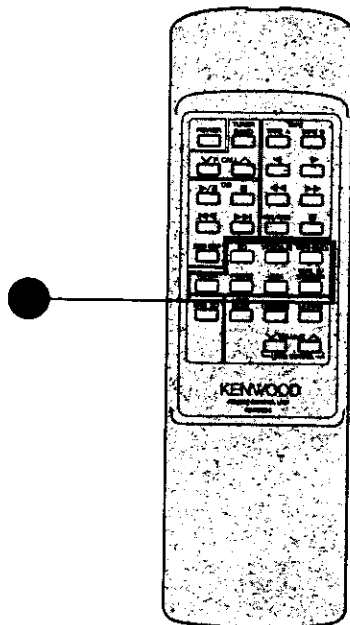

The Tape 2 monitor input

To listen to a source connected to the TAPE 2 MONITOR inputs press the TAPE 2 MONITOR button on the front panel or the remote. The TAPE 2 indicator turns ON.

Although you can rotate the input selector (and the display will show the sources changing) when the TAPE 2 input is active, the source connected to the TAPE 2 inputs will still be heard.

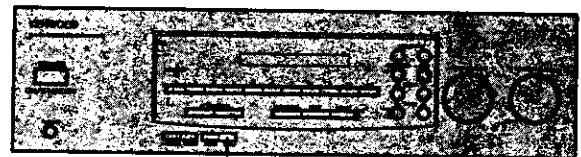
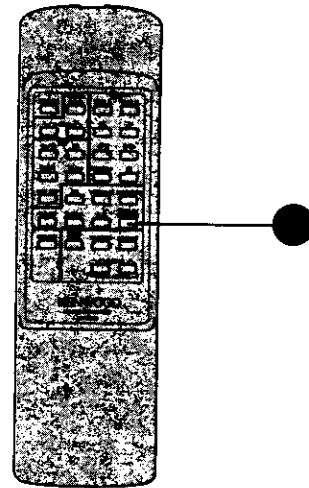

Adjusting the volume

You can increase or decrease the volume level in 1 decibel (dB) increments. The display shows the decibel level change.

Adjusting from the front panel:

Turn the VOLUME knob clockwise to increase the volume. Turn the knob counter-clockwise to decrease it.

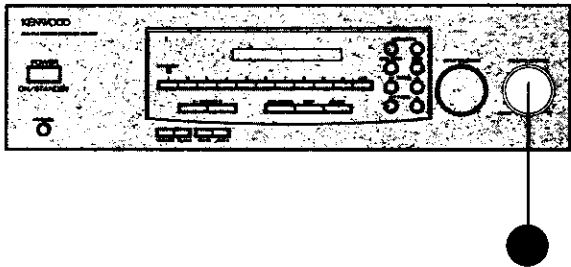

Adjusting from the remote:

Press the VOLUME buttons to increase or decrease the volume level.

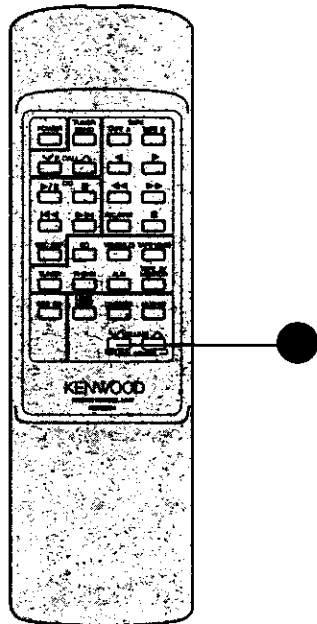

Adjusting the tone

You can increase or decrease the bass and treble to personalize the sound.

From the remote:

1 Push the LEVEL MODE button on the remote once to adjust the bass and twice to adjust the treble. The display will show which is being adjusted.

2 Use the VOLUME/LEVEL CONTROL buttons on the remote to increase or decrease the bass and treble to your taste.

3 The display will show the source when you've finished adjusting the tone.

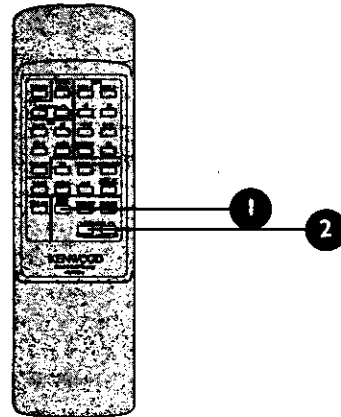

From the front panel:

1 Push the LEVEL MODE button on the front panel once to adjust the bass and twice to adjust the treble. The display will show which is being adjusted.

2 Use the LEVEL CONTROL buttons on the front panel to increase or decrease the bass and treble to your taste.

3 The display will show the source when you've finished adjusting the tone.

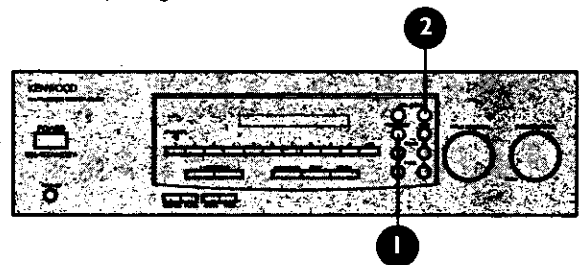

Activating the speakers

You can turn speakers A or B ON or OFF with the SPEAKERS buttons.

- 1 Press the SPEAKERS A button to activate the speakers connected to the "A" terminals. The SPEAKER A indicator on the display will turn ON.
- 2 Press the SPEAKERS B button to activate the speakers connected to the "B" terminals. The SPEAKER B indicator on the display will turn OFF.

You can activate both sets of speakers at the same time.

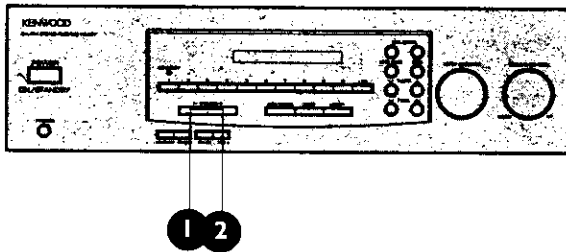

Note: If you cannot activate both sets of speakers at the same time, check the setting of the SPEAKERS IMPEDANCE SELECTOR switch on the receiver's rear panel. Refer to the Setting Up Your Kenwood Audio System section for details on the proper setting of this switch.

Adjusting the speaker balance

You can adjust the balance of the volume between the left and right speakers.

- 1 Press the LEVEL CONTROL button on the remote or the front panel until the receiver goes into the balance adjust mode.
- 2 Use the LEVEL CONTROL buttons on the front panel or the VOLUME/LEVEL CONTROL buttons on the remote to adjust the balance.

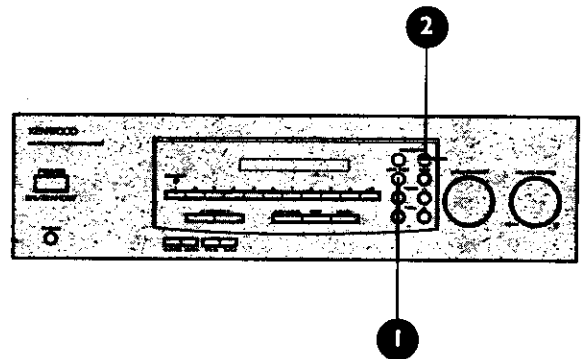

While you're adjusting the balance, the display shows the relative balance between the left and right speakers.

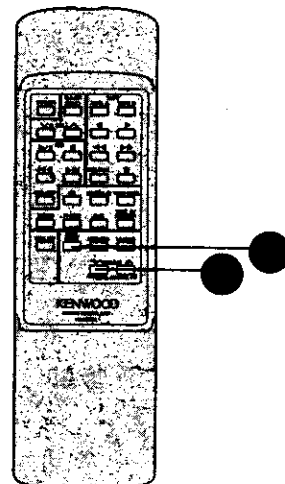

Muting the sound

You can quickly turn OFF the sound (when the phone rings, for example) and turn it ON again without stopping play.

Press the MUTE button on the remote or the front panel to turn the sound OFF. Press it again to turn the sound ON. The MUTE light on the display flashes while MUTE is ON.

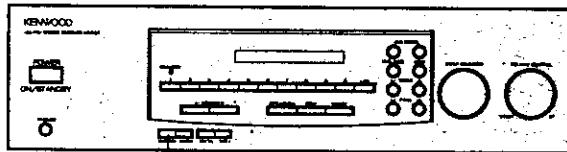
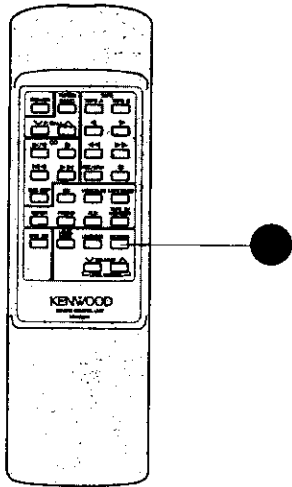

Making the sound fuller at low volumes

You can adjust the bass when you're listening at low volumes. This compensates for the fact that your hearing is less sensitive to bass at these volumes.

Press the LOUDNESS button on either the remote or the front panel to increase the bass. Press it again to restore normal tonal balance.

The LOUDNESS indicator on the display turns ON when Loudness is ON and goes OFF when Loudness is OFF.

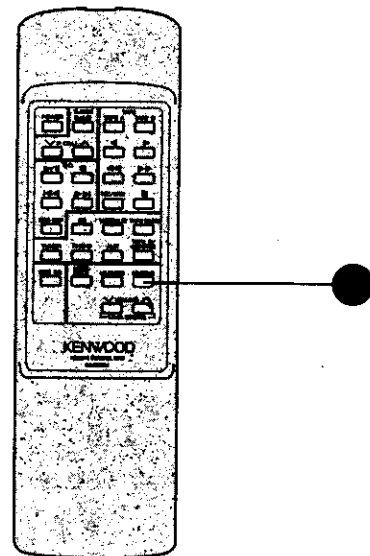
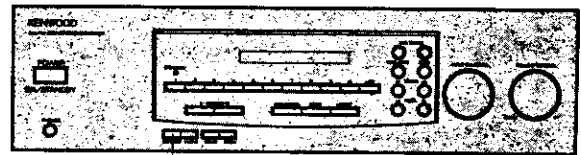

Using SRS 3D Sound

SRS 3D Sound is an exciting technology that helps to make music sound richer and more 3-dimensional. With the SRS 3D mode on, the sound will seem to come from beyond the edges of the speakers, making the sound more life-like and improving the stereo effect for people who aren't sitting directly between the speakers.

Press the SRS 3D button on the front panel or the remote.

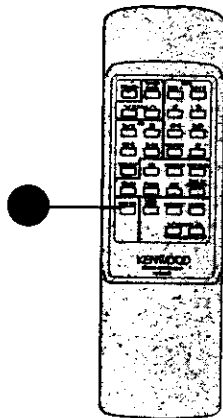
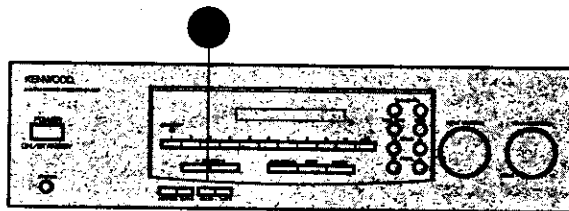

You can also record music with the SRS 3D effect (for playback on a stereo that doesn't have SRS 3D Sound, such as in a car).

If SRS 3D Sound is ON when you're recording, the tape will be recorded with the SRS 3D effect.

Using headphones

You can use headphones to listen to music in private.

- 1 Turn the speakers OFF.
- 2 Insert the headphone plug into the HEADPHONE jack, and then put them on.

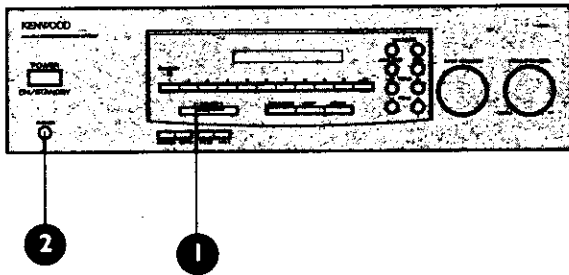

Important

There are a few things to keep in mind when using headphones:

- Turn the volume down before switching the speakers back on.
- You can use your headphones with the speakers on but be careful. The volume delivered through the headphones is usually lower than that delivered through speakers. When you turn up the volume for the headphones, be careful not to turn it up so loud you damage your speakers.

Using the tuner

Tuning stations automatically

You can automatically find the strongest radio station signals.

- 1 Select the TUNER input.
- 2 Press the BAND button to select FM or AM.
- 3 Press the AUTO/MANU button to select AUTO. The AUTO indicator light turns ON.
- 4 On the TUNING buttons, press ▲ to move up the broadcast band, or ▼ to move down the broadcast band.

The tuner stops automatically when it finds a strong station, and the TUNED light turns ON. If the station is broadcasting in stereo, the STEREO light turns ON.

- 5 Press ▲ or ▼ again to find the next strong signal.

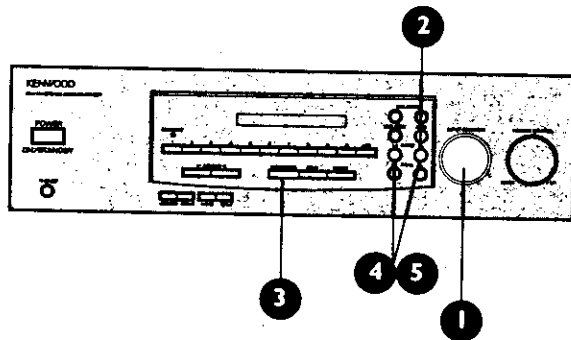

Tuning stations manually

You can search for radio stations in small steps up and down the broadcast band to tune in a weak station that automatic tuning might miss.

- 1 Select the TUNER input.
- 2 Press the BAND button to select FM or AM.
- 3 Press the AUTO/MANU button to select MANUAL. The AUTO indicator light turns OFF.
- 4 On the TUNING buttons, press ▲ to move up the broadcast band, or ▼ to move down the broadcast band to the station you want.

The frequency changes by 0.1 MHz (FM) or 10 kHz (AM) each time you press the button, or it continually changes if you hold the button down.

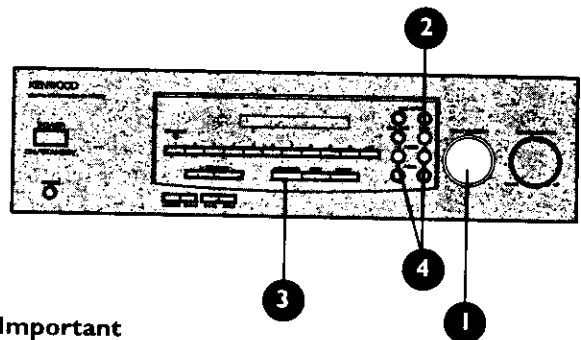

Important

During manual tuning, the tuner receives stations only in mono.

- To receive a tuned station in stereo, press the AUTO/MANU button so the AUTO light turns ON. If the station is broadcast in stereo, you receive it in stereo.
- You may receive weaker stations with more background noise in stereo than in mono. To decrease the noise, press the AUTO/MANU button so the AUTO light goes OFF.

Storing preset stations

You can store up to 40 of your favorite radio stations in memory.

- 1 Tune in the station you want to preset.
- 2 Press the MEMORY button. The MEMORY light turns ON.
- 3 Within 5 seconds, enter the preset number using the number buttons. For example, to select preset #15, press the +10 button, then 5. To select preset #20, press the +10 button, the +10 button again, then 0.

If you've already assigned a station to a preset number, assigning a new station erases the old one.

- 4 To preset additional stations, repeat these steps.

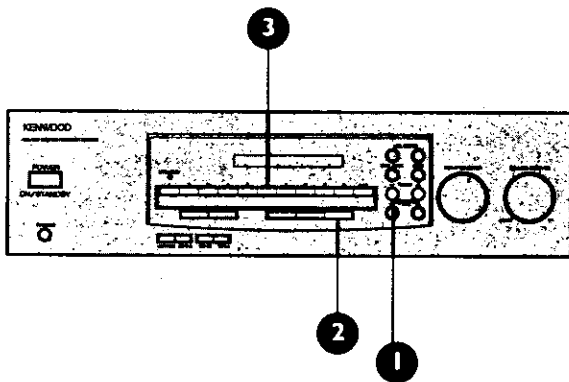

Tuning to preset stations

You can quickly tune to any preset station.

- 1 Select the tuner input.
- 2 Press the number buttons assigned to the station.

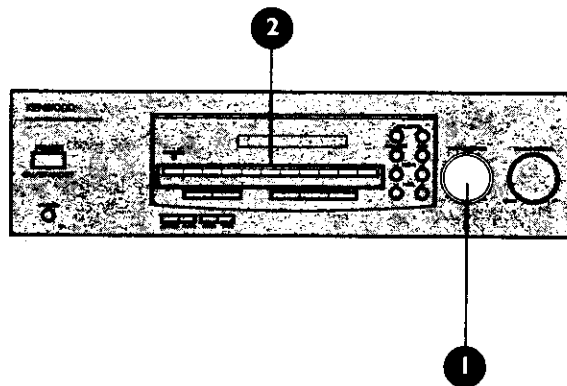

Scrolling through preset stations

Scrolling from the front panel

You can scroll through all preset stations in sequence.

- 1 Select the tuner input.
- 2 Press one of the P.CALL (Preset Call) buttons. Each time you press one of the buttons, the tuner advances to the next or previous preset station number. The display shows the preset numbers.

If you hold either of the buttons down, the tuner advances through the preset stations at 1/2-second intervals. When you release the button, you hear the station tuned in at that time.

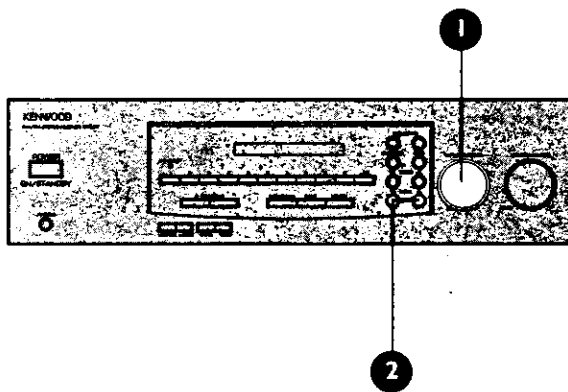

Scrolling from the remote

- 1 Select the tuner input.
- 2 Press the P. CALL buttons to scroll up or down through the preset stations. Each time you press the button, the tuner changes to the next or previous preset station number. The display shows the preset numbers. If you hold either button down, the tuner scrolls through the preset stations at 1/2-second intervals. When you release the button, you hear the station tuned in at that time.

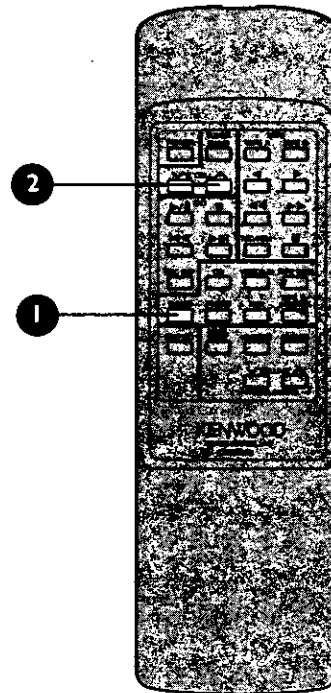

Using the equalizer

Front panel controls:

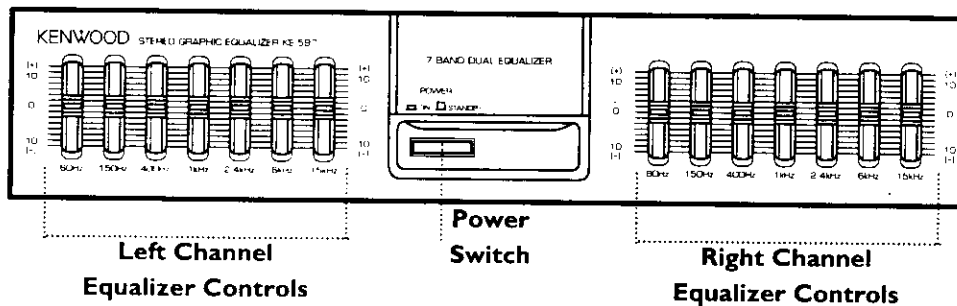

The equalizer allows you to control the tone quality of the sound much more precisely than you can with conventional tone controls. You can adjust the sound of each channel independently at 7 different frequencies, from the deepest bass up to the highest treble.

To change the tone quality:

Each slider controls a specific tonal range. Moving a slider up increases the volume of that tonal range. Moving a slider down decreases the volume of that tonal range. The "0" (center detented) position is neutral, with no change made to the original sound. The individual equalizer sliders are:

- **60Hz: Deep Bass.** Increasing this range can add power and drama to the sound. Decreasing this range can eliminate "boominess."
- **150Hz: Mid-Bass.** Increasing this range can add impact to drums and fullness to other instruments. Decreasing this range can control room resonances that cause the sound to be "muddy".
- **400Hz: Lower Midrange.** Increasing or decreasing this range can add or reduce richness and presence in male voices and instruments like guitar and piano.
- **1kHz: Midrange.** Increasing or decreasing this range can affect the overall sense of "presence" or "liveness" of most sounds.
- **2.4kHz: Upper Midrange.** Increasing this range can add brilliance to most instruments or voices. Decreasing this range can control sound that is too "metallic".

- **6kHz: Lower Treble.** Increasing this range can add presence to instruments like trumpets and flutes. Decreasing this range can reduce harshness in overly bright sounding recordings.
- **15kHz: High Treble.** Increasing this range can add "sparkle" to instruments like cymbals and synthesizers. Decreasing this range can reduce tape or FM noise.

To listen without any equalizer effect:

Move all of the sliders to the "0" (center detented) position.

Using the CD player

The front panel controls and display

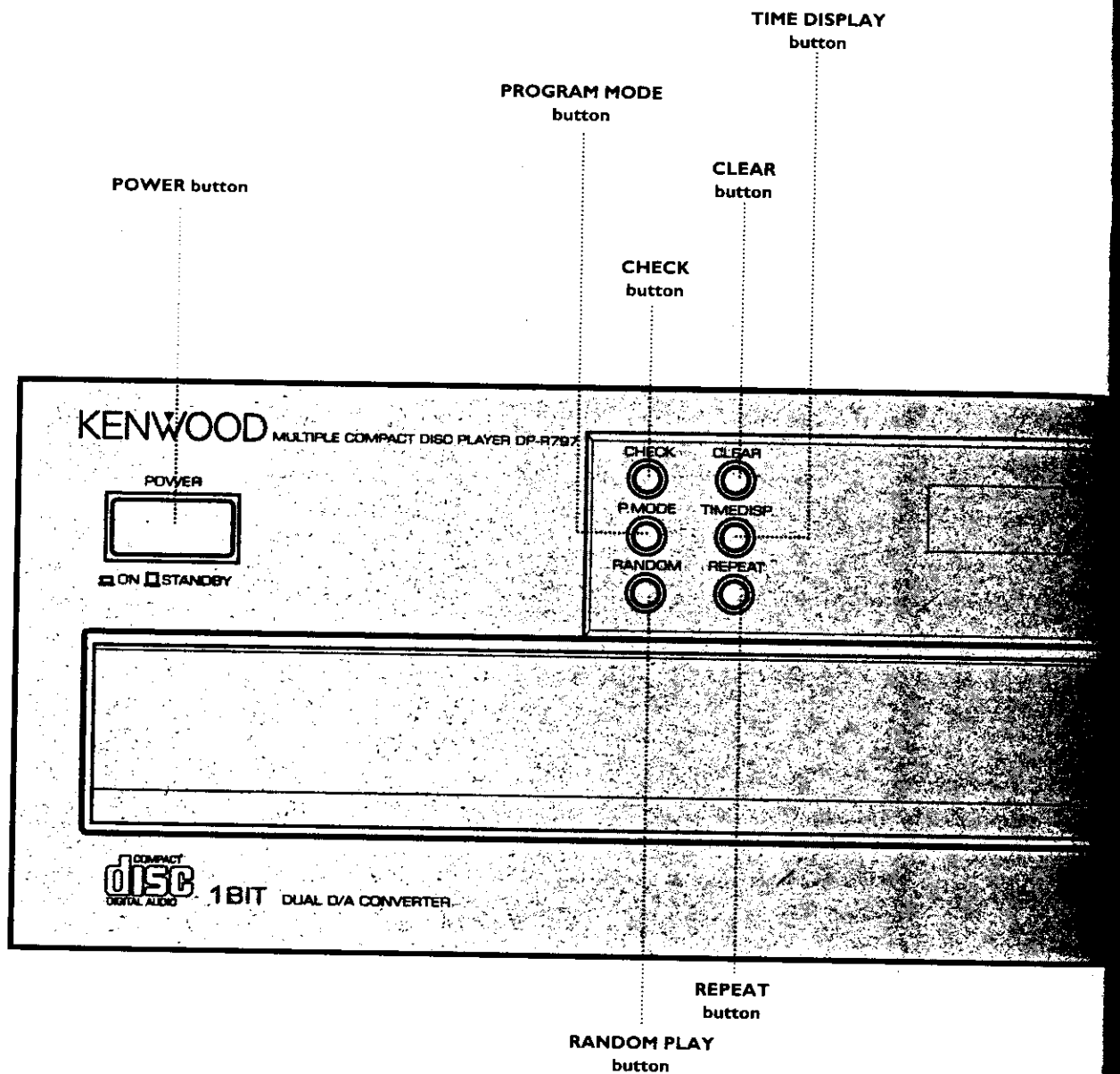

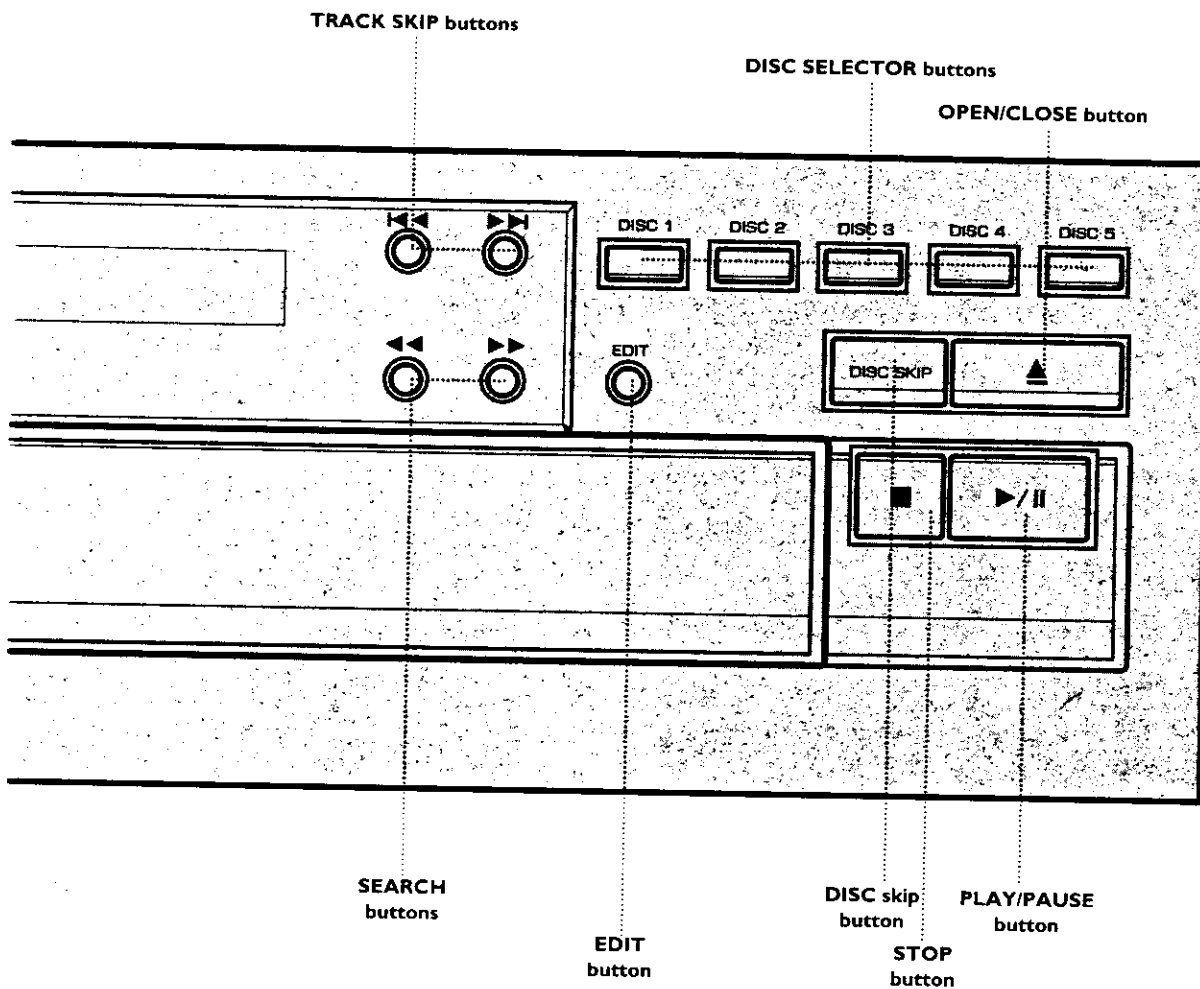
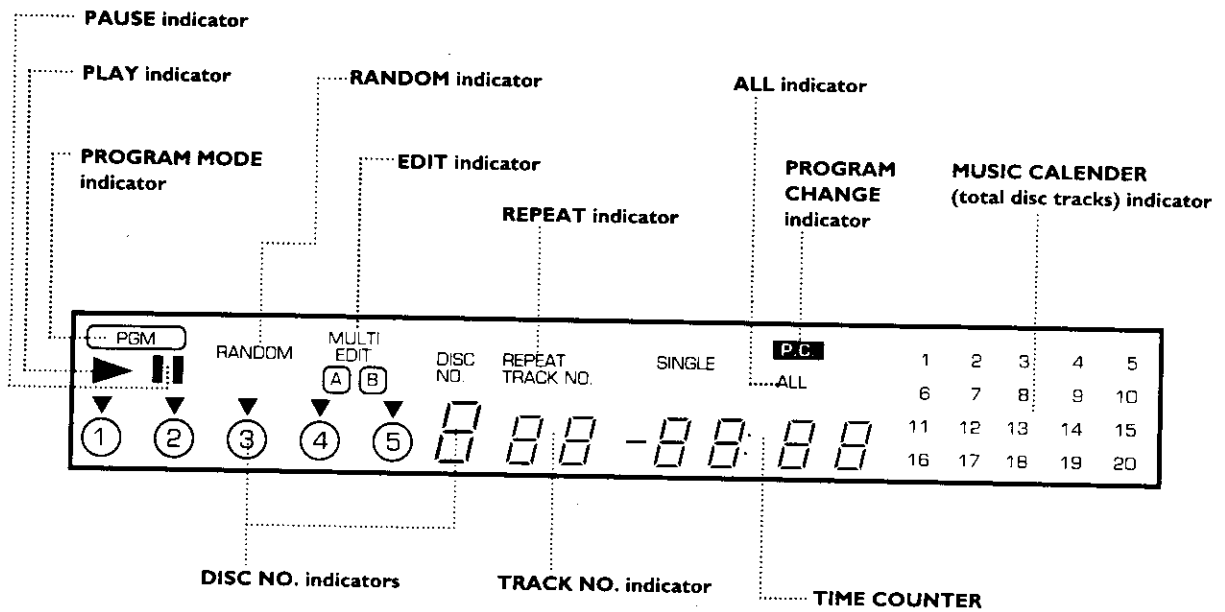

Before using the CD player

Please read the following instructions carefully to help prevent damage to your CD player and your CDs.

Compatible CDs

Your CD player plays standard 5" CDs and 3" CD singles and the audio portion of CDV discs and CD-G (CD plus graphics) discs.

Handling CDs

Hold a CD by its edges and center hole. Don't touch the playing surface or attach labels or tape to either side of the CD.

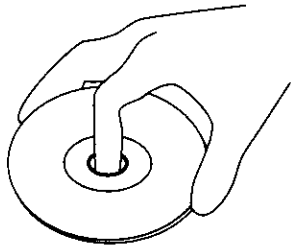

Cleaning CDs

To clean fingerprints or other dirt from a CD, gently wipe it with a soft cotton cloth moving in circles outward from the center.

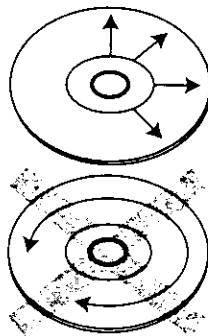

Storing CDs

To protect your CDs, store them in their cases. Don't leave them in the player for a long time.

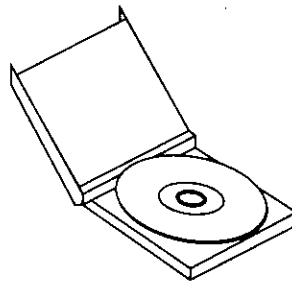

Damaged CDs

To avoid possible damage to your player, don't attempt to play cracked or warped CDs.

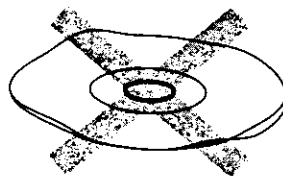
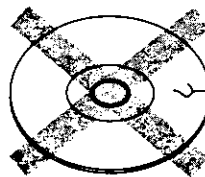

Condensation

Condensation of water vapor on the pickup lens may prevent proper operation of your CD player. To eliminate the condensation, leave the player ON for several hours. Condensation may occur when:

- You bring the player from a cool or cold place to a warm or humid place.

- You operate a heater in the vicinity of the player.
- There's a big difference between the player's internal temperature and the temperature of the room the player is in.

Before you transport your CD player

- 1 Turn the player's power ON. Don't load any CDs.
- 2 Wait until 5 seconds after NO DISC appears on the display.
- 3 Turn the player's power OFF.

Loading CDs

- 1 Press the OPEN/CLOSE button to open the tray.
- 2 Place a CD in one of the tray's circular wells. While the tray is open, you can insert a CD in each of the 2 exposed wells.

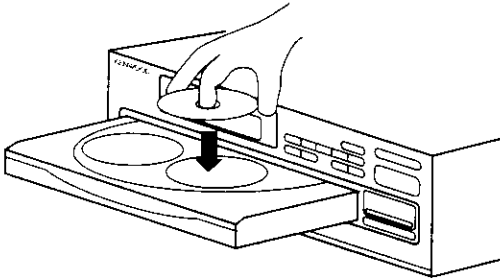

- 3 To insert more CDs, press the DISC SKIP button to rotate the tray. Insert a CD when the tray stops rotating.
- 4 When you're done, press the OPEN/CLOSE button to close the tray.

Changing CDs

During play

- 1 Press the OPEN/CLOSE button to open the tray.
- 2 Change CDs in the exposed wells. If you want to put a CD in an unexposed well, press the DISC SKIP button to rotate the tray. You can't change the CD currently playing.

When the player is stopped

- 1 Press the OPEN/CLOSE button to open the tray.
- 2 Change CDs in the exposed wells. If necessary, press the DISC SKIP button to rotate the tray.

Displaying CD time information

You can view time information for the CD you're playing.

Press the TIME DISP. button to cycle between:

TRACK TIME: Elapsed and remaining time of the current track.

TOTAL TIME: Elapsed and remaining time of the CD.

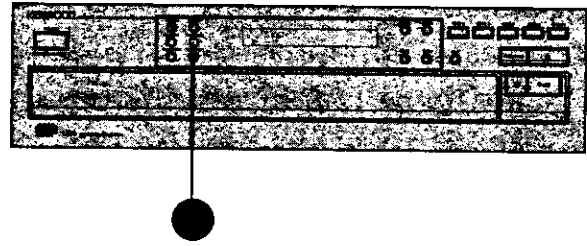

Playing CDs

From the beginning

Playing from the front panel

- 1 Load one or more CDs.
- 2 Select the CD using the DISC SELECTOR buttons. An indicator ▼ appears on the display over the number of the selected CD. The selected CD automatically begins playing.

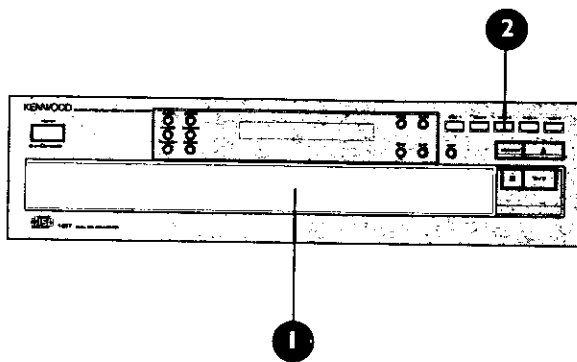

Playing from the remote

- 1 Load one or more CDs.
- 2 Press the DISC button until the indicator ▼ appears on the player's display over the number of the selected CD. The selected CD automatically begins playing.

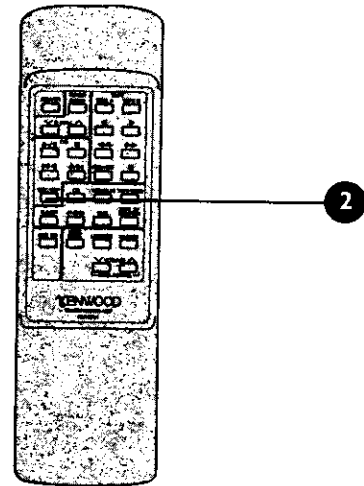

Whether you use the front panel or remote:

- If you don't select a CD when you've inserted more than 1 CD, the CDs play in order, starting with the CD in the lowest-numbered CD well.
- If you don't select a CD and you press the PLAY/PAUSE button, play begins with the CD number currently indicated on the display.

From a specific track

Playing from the front panel

- 1 Make sure that the PGM (Program Mode) light is OFF. If the PGM light is ON, press the P.MODE button.
- 2 Select the CD using the DISC SELECTOR buttons.
- 3 Select the track using the **1◀◀** and **▶▶1** buttons. Play begins from the selected track and continues.

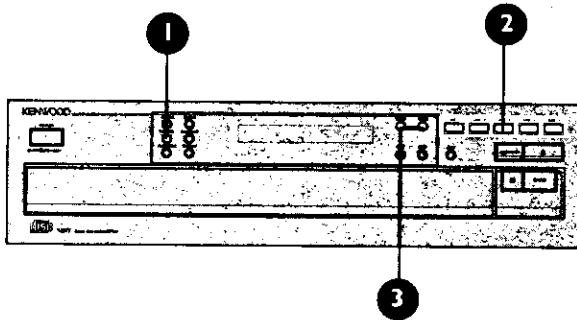

Playing from the remote

- 1 Make sure that the PGM light is OFF. If the PGM light is ON, press the P.MODE button.
- 2 Select the CD using the DISC button.
- 3 Select the track using the **1◀◀** and **▶▶1** buttons. Play begins from the selected track and continues.

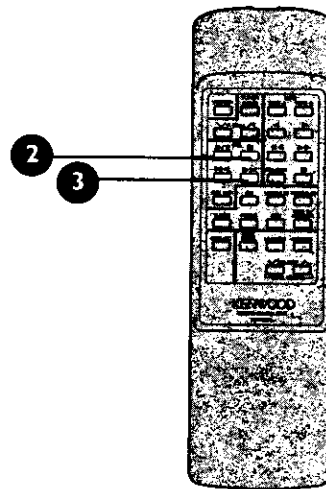

Playing a combination of tracks

You can program up to 32 tracks from any combination of CDs to play in any order.

A few hints:

- The player automatically adds a space of about 4 seconds between tracks in the PGM mode. This makes it easy to record tapes that are compatible with the track-finding function of Kenwood cassette decks. However, the PGM mode also inserts a 4-second space between 2 continuous, consecutive tracks programmed into memory, such as those on classical and live recordings.
- If you select the wrong track, press the CLEAR button, and select the correct track.
- When selecting tracks using the number buttons on the remote, you don't have to press the P.MODE button after each selection.
- Once you've programmed 32 tracks, the display indicates FULL, and you can't program any more tracks.
- If you press **⏮** or **⏭** buttons during Programmed play, the player skips the current track either forward or backward.

Programming tracks

- 1 Press the STOP button.
- 2 Press the P.MODE button. The PGM light turns ON.
- 3 Select a CD.
- 4 Select a track.
- 5 Press the P.MODE button. The PLAY light flashes, and the display shows the selected CD and track and indicates P—01.
- 6 Repeat steps 3 through 5 above to program each track.
- 7 Press the PLAY button to play.

You can program all the tracks on a CD (in order) by pressing the P.MODE button without selecting any track numbers. The CD takes up only 1 program memory slot, regardless of how many tracks are on it.

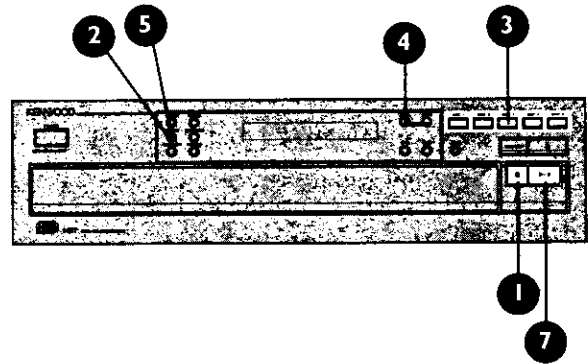

To check a program

Press the CHECK button. Each time you press the button, you see the CD and track numbers in the order you programmed them on the display.

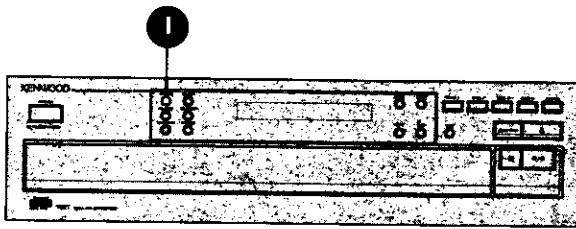

To resume normal play

Press the P.MODE button. After the current track is done, the tracks continue to play in the order on the CD.

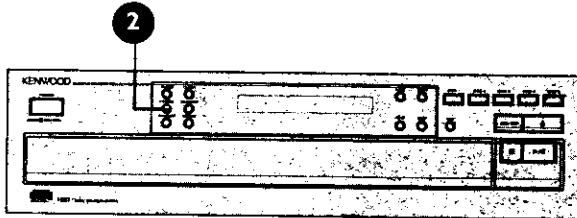

To stop play

Press the STOP button.

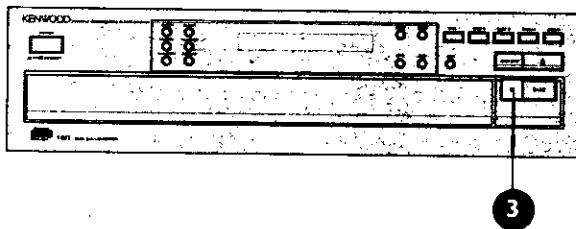

Adding a track to a program

You can add another track to the end of a program after the program has started playing.

- 1 Press the STOP button.
- 2 Select the CD and track to add.
- 3 Press the P.MODE button.

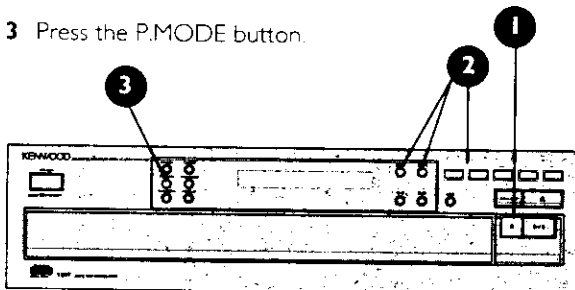

Changing a track in a program

You can change a track in a program after the program has started playing.

- 1 Press the STOP button.
- 2 Press the CHECK button until you see the P—# you want on the display. The P.C. light turns ON.
- 3 Select the new CD and track.
- 4 Press the P.MODE button.

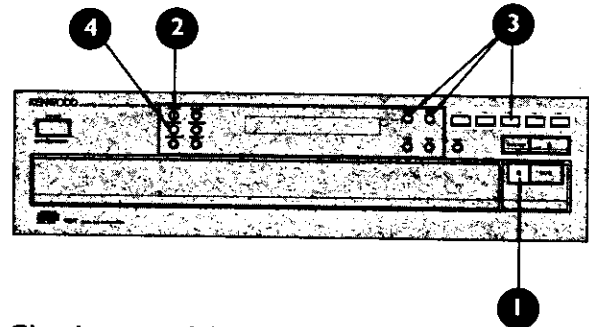

Clearing a track in a program

You can clear upcoming tracks in a program while it's playing.

Press the CLEAR button. Each time you press the button, you clear the tracks in order from the last track. You can't clear the track currently playing.

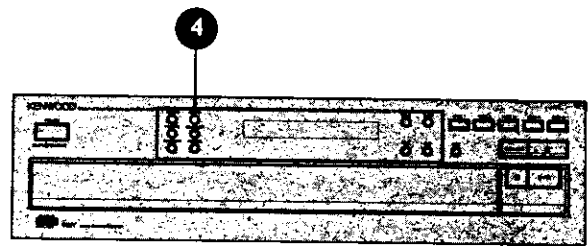

Clearing a whole program

Press either the P.MODE button or the OPEN/CLOSE button.

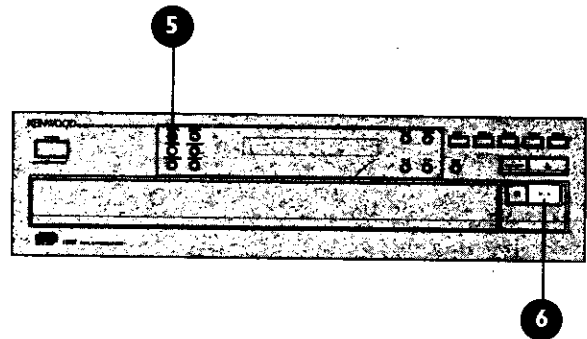

Playing CDs over (repeat play)

You can repeat a single CD, all loaded CDs, or the contents of a program.

Repeating a single CD

- 1 Press the STOP button.
- 2 Press the P.MODE button. The PGM light turns ON.
- 3 Select a CD.
- 4 Press the P. Mode button. The ALL indicator light turns on.
- 5 Press the REPEAT button. The REPEAT light turns ON.
- 6 Press the PLAY button.

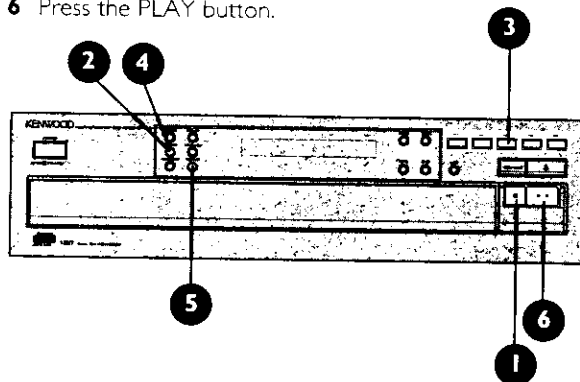

Repeating all loaded CDs

- 1 Make sure that the PGM light is OFF. If the PGM light is ON, press the P.MODE button.
- 2 Press the REPEAT button. The REPEAT light turns ON.
- 3 If you weren't already playing CDs, press the PLAY button.

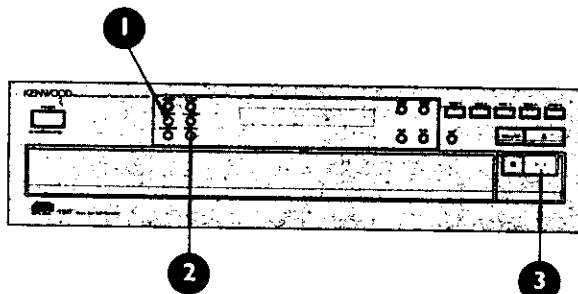

Repeating programmed tracks

You can repeat a programmed combination of tracks (see page 26, 'Programming Tracks'). If you only programmed 1 track, it plays over and over again.

- 1 Make sure that the program is playing (and the PGM light is ON).
- 2 Press the REPEAT button. The REPEAT light turns ON.

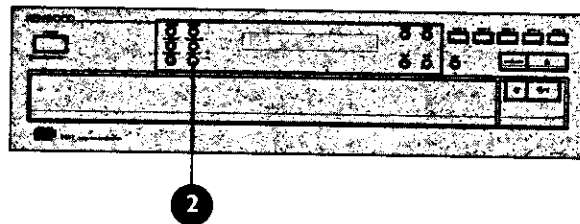

To stop repeat play

Press the REPEAT button while repeat play is ON. The REPEAT light goes OFF.

Playing tracks in random order (random play)

You can randomly play all the tracks from the CDs in the tray without repeating any tracks.

- 1 Make sure the PGM light is OFF. If the PGM light is ON, press the P.MODE button.
- 2 Press the RANDOM button. The RANDOM light turns ON, and the MUSIC CALENDAR flashes.

Random play continues until all tracks have been played.

You can continuously repeat random play by pressing the REPEAT button during random play.

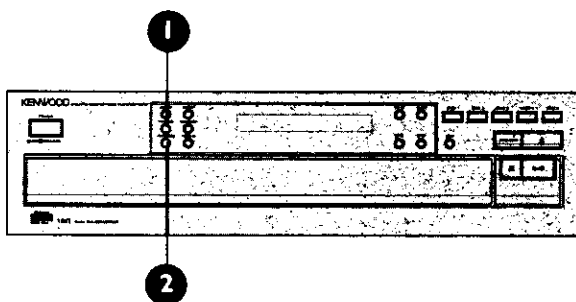

To select another track during random play

Press the Forward TRACK SKIP button.

To cancel random play

Press either the STOP, OPEN/CLOSE, or RANDOM buttons. If you press RANDOM, normal play starts from the track you're currently playing.

Using a timer to play CDs

You can use your CD player with an audio timer (you'll have to buy it on your own) to play CDs at a time you choose.

- 1 Connect the power cords of the SPECTRUM system to the audio timer so that the timer turns the system on. Be sure to follow the instructions included with the timer.
- 2 Turn the system ON.
- 3 Insert 1 or more CDs. If you insert more than 1 CD, play begins with the CD in the lowest-numbered CD well.
- 4 Set the volume.
- 5 Set the timer. At the set time, the system will turn on, and the CD player will begin playing.

Using the cassette deck

The front panel controls and display

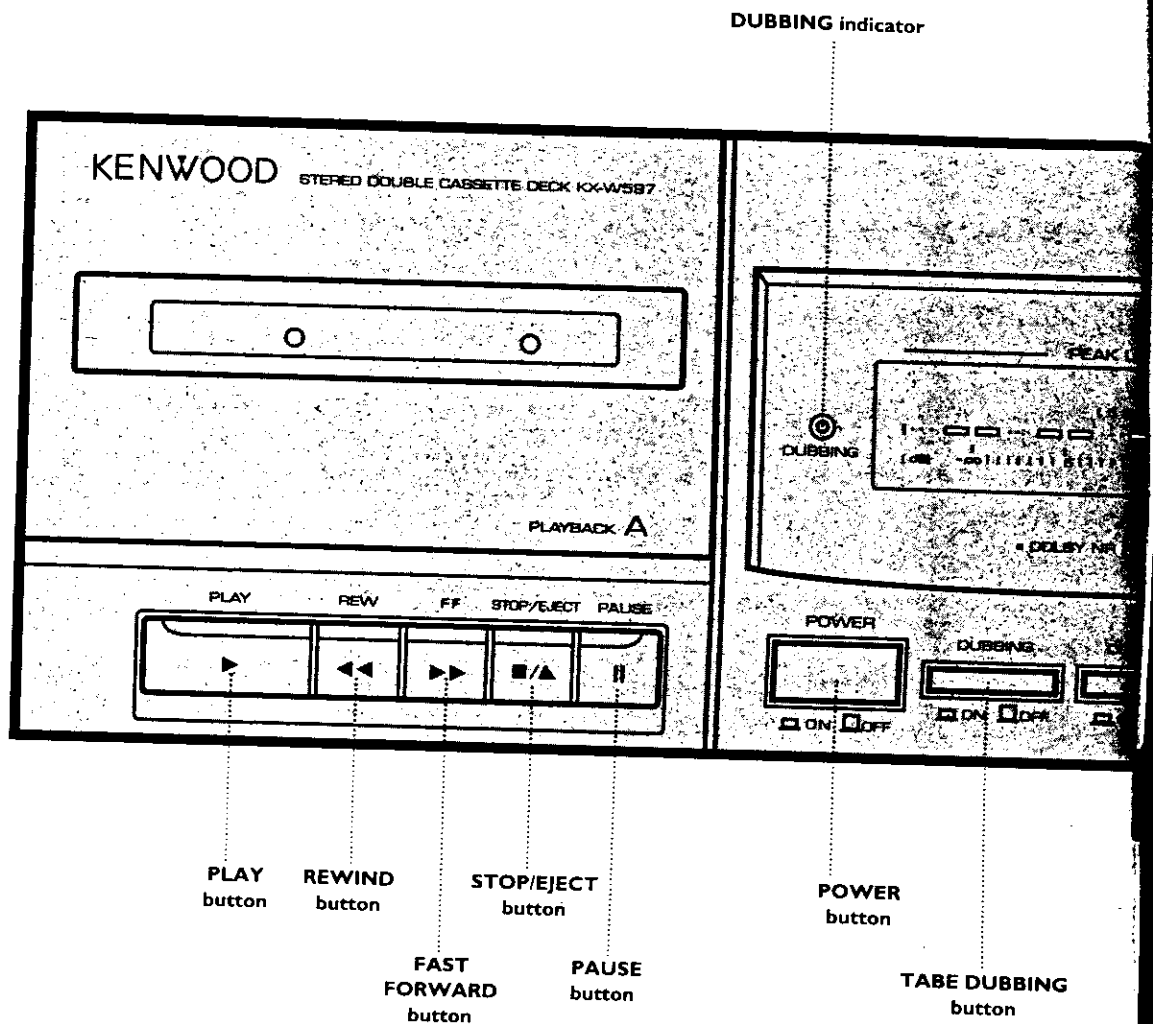

PEAK LEVEL METER

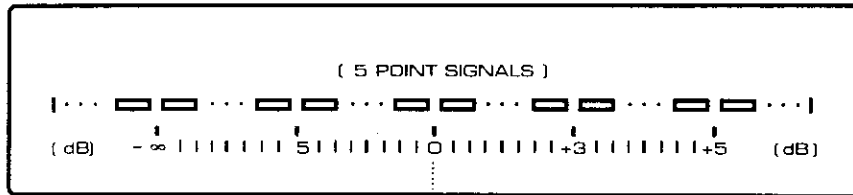

DOLBY NR
reference level

RECORDING indicator

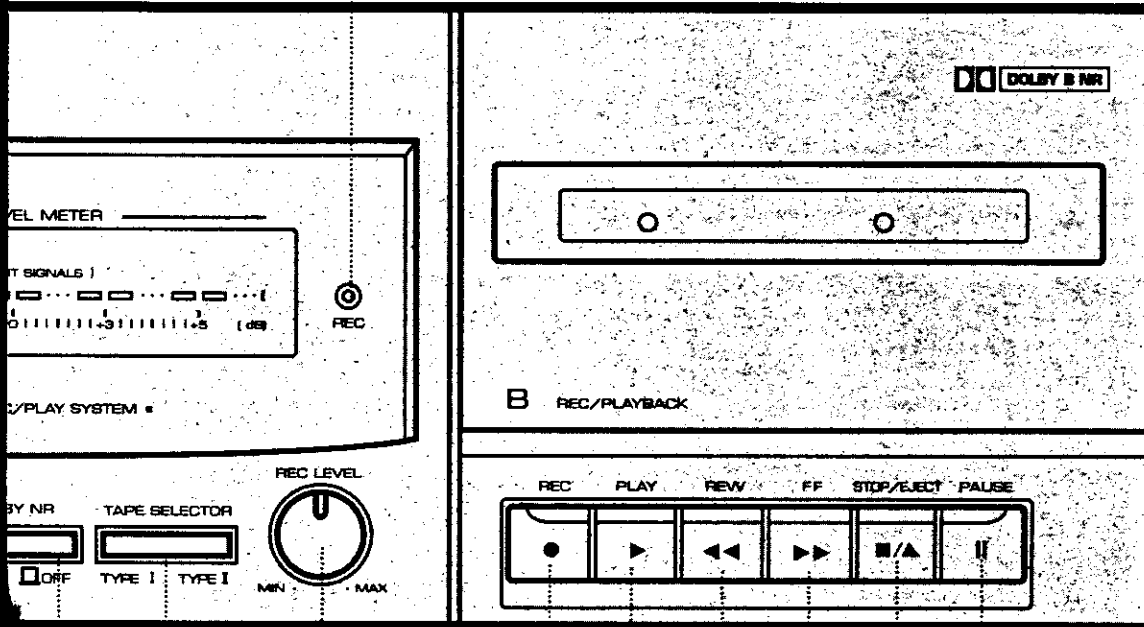

TAPE SELECTOR
button

REWIND
button

FAST
FORWARD
button

PAUSE
button

DOLBY NR
button

RECORD LEVEL
button

RECORD
button

PLAY
button

STOP/EJECT
button

Before using the cassette deck

Please read the following instructions carefully to help prevent damage to your cassette tapes.

Preventing accidental recording on pre-recorded tape

To prevent the accidental recording of a tape, use a small screwdriver or other tool to remove the recording-activation tabs on the top edge of the cassette case.

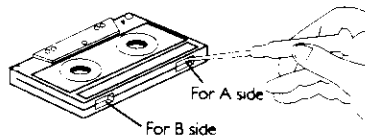

To record on the tape after you've removed the tabs, use cellophane tape to cover the portion of the hole previously covered by the tabs. Covering the entire hole may interfere with the operation of the cassette deck's automatic tape-type sensing mechanism.

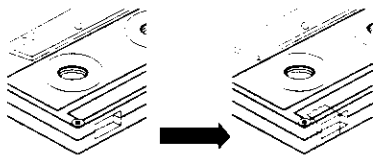

If there is slack in the tape

Insert a pencil into the tape reel hole, and wind the excess tape into the cassette case.

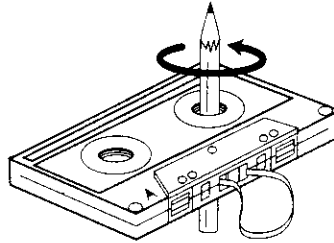

Storing cassettes

Store tapes away from direct sunlight, magnetic fields (including those produced by speakers and television sets), and heaters.

Special tapes

Using 120-minute tapes and/or endless tapes could damage the tape mechanisms. We don't recommend them.

Listening to tapes

Playing tapes

- 1 Insert a tape into a tape well. On tape A, the tape type (Normal or Chrome) is automatically selected. On tape B, press the TAPE SELECTOR button to select the proper tape type.

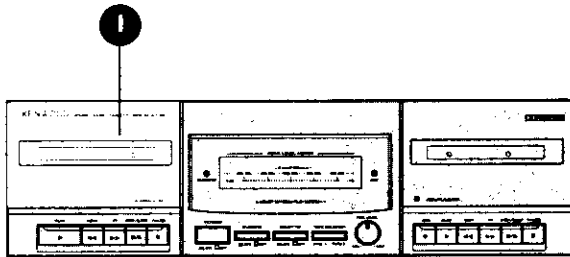

- 2 Select Dolby Noise Reduction for the tape you're playing. For example, if you're playing a tape recorded using Dolby, select ON.
- 3 Press the ► button to begin play.
- 4 Press the ■ button to stop play.

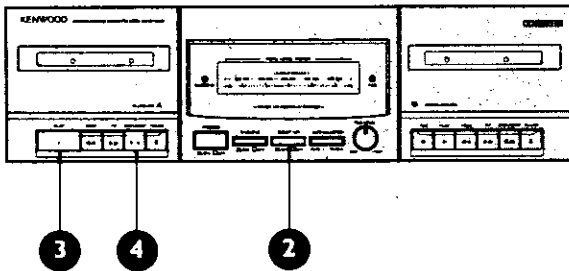

Fast-winding tapes

- 1 Press the ■ button to stop play.
- 2 Press the ►► button to fast-forward through the tape, or press the ◀◀ button to rewind through the tape.
- 3 Press the ■ button to stop fast-winding.

Recording tapes

You can record tapes from any source connected to your system: CDs, other tapes, records (if you've connected a record player), the radio, and even the audio portion of videotapes or laser discs (if you have these components connected).

A few tips:

- To record tapes, use tape well B.
- You can't make recordings on metal tapes.
- Dolby Noise Reduction reduces tape hiss produced during the record/play process. Dolby B is the most widely used noise reduction system on pre-recorded tapes. Be sure you mark the tapes you record either Dolby B or not so you can play them back properly.

Setting the recording level

Setting the proper recording level is an important part of making good tapes. If the recording level is too low, tape hiss may mask the music's softer parts. If the recording level is too high, the music may sound distorted. These instructions help you set the optimum recording level.

- 1 Put a blank tape in tape well B.
- 2 Press the PAUSE button, and then press the REC and PLAY buttons simultaneously.
- 3 Set the input of the receiver to the source you want to record. You can't select TAPE.
- 4 Find a loud section from the source you want to record, and play it.
- 5 Using the REC LEVEL knob, adjust the recording level so that the level indicators flash at 0 dB on the music's loudest passages. Turn the knob clockwise to increase the recording level or counter-clockwise to reduce it.

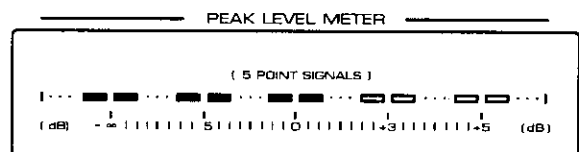
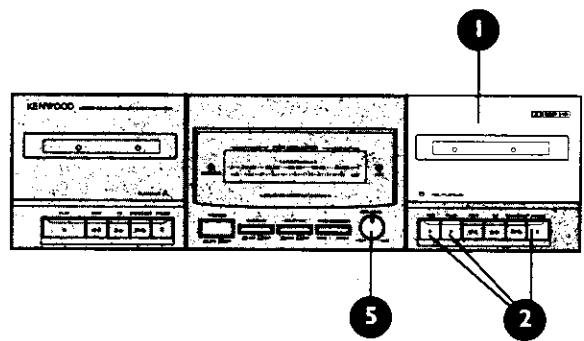

Recording a tape

- 1 Put a blank tape in tape well B.
- 2 Press the PAUSE button, and then press the REC and PLAY buttons simultaneously.
- 3 Set the input of the receiver to the source you want to record. You can't select TAPE.
- 4 Set the record level (see above).
- 5 Set the source at the beginning.
- 6 Press the PAUSE button to release the cassette from pause.
- 7 Play the music source.

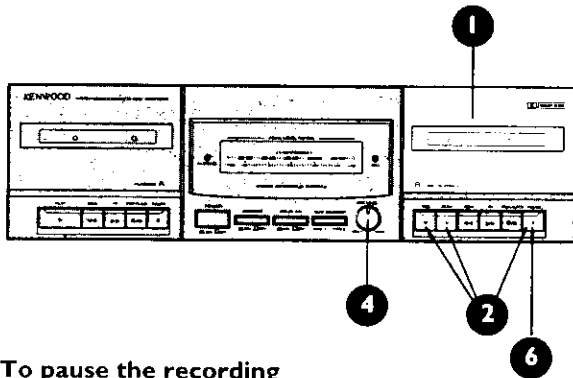

To pause the recording

Press the PAUSE button.

To resume recording

Press the PAUSE button again.

To stop recording

Press the STOP button.

Copying (dubbing) a tape

You can automatically copy a tape in tape well A onto a tape in tape well B.

A few tips about recording tape-to-tape:

- You can't adjust recording level during copying. It is set automatically.
- The new recording in tape well B will automatically have the same noise reduction as the original recording in tape well A. This means you can't add Dolby Noise Reduction during dubbing.

- 1 Insert the tape to copy into tape well A, and a blank tape into tape well B.
- 2 Select the tape type for tape well B.
- 3 Press the DUBBING button.

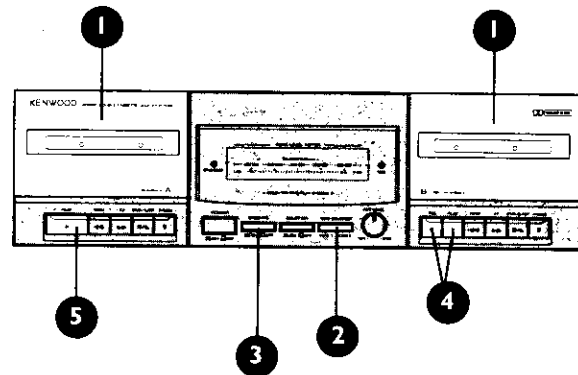

- 4 Press the REC and PLAY buttons for tape well B simultaneously.
- 5 Press the PLAY button for tape well A. Dubbing starts automatically.

- Dubbing stops automatically when the side has been recorded.
- Remember to turn the DUBBING switch OFF after you've finished dubbing the tape.

To pause dubbing

Press the PAUSE button for tape well B.

To resume dubbing

Press the PAUSE button for tape well B again.

To stop dubbing

Press the STOP/EJECT buttons for both tape wells.

Maintaining the cassette deck

Performing routine maintenance helps keep your cassette deck operating at peak performance.

Cleaning the heads

We recommend that you clean the head assemblies, tape guides, capstans, and pinch rollers of both cassette wells after every 10 hours of use. For best results, use tape head cleaning fluid and long-handled cotton swabs. (Using alcohol to clean the pinch rollers may cause them to dry out over a long period of time.) Be careful not to press too hard during cleaning, because the parts are precisely aligned.

- 1 Open the cassette well doors.
- 2 Dip a swab into the cleaning fluid, and clean the surface of the heads.

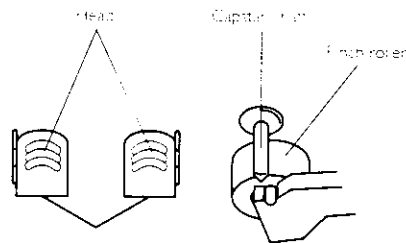

- 3 Using a clean swab, clean the capstan shafts, making sure to clean all the way around them.
- 4 Using a clean swab, clean the pinch rollers, making sure to clean all the way around them. Use a clean swab to keep them from tumbling.

Demagnetizing the heads

Since tape is magnetic, when the tape heads and capstan shaft contact the tapes, they become magnetized over time, increasing distortion. Playing tapes on a player with magnetized heads and capstans can also deteriorate the recordings on the tapes. For best performance, use a head demagnetizer to demagnetize the heads and capstans of both cassette wells.

Troubleshooting guide

Sometimes things just don't seem to be working right.

When this happens:

- First, look back over this manual to find the instructions for what you're trying to do. You may find the solution to your problem right there.
- If that doesn't work, look for the problem in this Troubleshooting guide.
- If you have a problem with another component, check the manual for that unit.
- If you still can't solve the problem, call the store where you purchased your system, or call a Kenwood Authorized Service Center.

To find a Kenwood Authorized Service Center

- Call 1-800-536-9663 in the continental US, 24 hours a day, 7 days a week.

Receiver

Remote doesn't operate

- Check the batteries, and replace them if needed.
- Check that the remote is close enough to the system; that the controlling angle is small enough, that there's no obstacle in between.
- Check that you've placed your CD, videotape, laser disc, or other source in the proper player.
- Check to make sure that the audio cables and system control cables are connected properly.

No sound from the system

- Check that the volume is set at a proper level.
- Check that the mute is OFF.
- Check that the equalizer's power switch is on.

- Check that the speakers are turned ON. If the speakers are ON, the speaker indicator is ON.
- Check that all your power cords are connected properly.
- Check that the speaker cables are connected properly.
- Check that the input cable from the source component is connected properly.
- Check that the shorting plugs have not been removed from the ADAPTER loop jacks.

No sound from one of the speakers

- Check that the balance between the left and right speakers isn't set too far to one side.
- Check that the audio and speaker cables are connected properly.

No sound from the "B" speakers

- Check that the "B" speakers are turned on
- Check that the speakers' impedance selector switch is in the proper position.

The STANDBY light blinks, but there is no sound

- Check that the speaker cables aren't short-circuited—that is, the (+) and (-) wires aren't touching each other. If they are, separate the wires.

A hum when you select the PHONO input

- Check that the audio cables are plugged securely into the PHONO jacks.
- Check that the turntable is grounded on the rear panel. The ground wire should be connected to the screw labeled GND.

None of the functions operate, or the display shows wrong information

- Reset the receiver's microcomputer by unplugging the power cord from the AC outlet and plugging it back in while holding down the POWER button.

You can't receive radio stations

- Check that the station is tuned in properly.
- Check that the TUNER input is selected.
- Check that the antenna is connected properly.

You can't receive a preset station by pressing the corresponding number buttons

- Check that the TUNER input is selected.
- Check that the preset station is a receivable frequency.
- Check that the preset memory hasn't been cleared because the power cord was unplugged for a long time. If so, preset the station again.

Interference with reception

- Check for interference from electrical appliances. If so, turn them OFF.
- Check for interference from the TV set. If so, turn it OFF, or move the antenna away from the TV.
- Check for interference from automobiles. If so, install the outdoor antenna away from roads.

CD player

Power light doesn't come on

- Check that the power cord is properly plugged into the AC outlet on the back of the receiver.

Player doesn't play a loaded CD

- Check that the CD is loaded right-side up.
- Check that the CD isn't cracked or dirty.
- There may be condensation on the lens. Leave the player on for at least 1 hour before using it.

No sound

- Check that the CD is loaded properly.
- Check that the CD isn't cracked or dirty.
- Check that the PLAY mode is active (the PLAY indicator light should be ON).
- Check that the audio cables are connected properly.

Skipping (mis-tracking)

- Check that the CD isn't cracked or dirty.
- Make sure that the player isn't subjected to strong vibrations.

CD automatically plays when power is turned on

- Remove all CDs before turning the unit OFF. The player is designed to automatically begin playing when the power is turned ON.

Cassette deck

No sound when the PLAY button is pressed

- Check that the tape isn't blank.
- Check that the tape is wound properly in the cassette case. If not, replace the tape.
- Check that the audio cables are connected properly.
- Check that the tape heads are clean.

None of the operation buttons work

- Make sure that a tape has been inserted into the well.
- Make sure the cassette well door is completely closed.
- Make sure that the tape isn't fully wound to the end. If it is, reinsert the tape facing the other direction.
- Check that the tape is wound properly in the cassette case. If not, replace the tape.

Recordings sound dull

- Check that the tape heads are clean.
- The recording level may be too high. Set the recording level according to the section 'Setting the recording level' on page 34.
- Make sure that Dolby Noise Reduction isn't activated when playing tapes recorded with no Dolby Noise Reduction.

Recordings are distorted

- The recording level may be too high. Set the recording level according to the section 'Setting the recording level' on page 34.

Pressing the REC and PLAY buttons simultaneously doesn't start recording

- Make sure that the recording-activation tabs have not been removed from the tape.
- Make sure that the cassette well door is completely closed.
- Check that the recording level isn't set to minimum.
- Check that the tape isn't fully wound to the end.

Tape noise (hiss) level is high

- Make sure that the proper Dolby Noise Reduction is selected for play.
- Make sure that the head is demagnetized properly.
- The tape may have been recorded at too low a recording level. If so, record it again at a higher level.

Sound is 'sour', with unstable pitch

- Make sure that the capstans and pinch rollers are clean.
- Make sure that the tape is wound properly in the cassette case.

None of the functions operate, or the display shows wrong information

- Reset the unit's microcomputer by unplugging the power cord from the AC outlet and plugging it back in while holding down the STOP button.

Specifications

Receiver (KR-597)

Power amp section

100 watts per channel minimum RMS, both channels driven, at 8 ohms, from 20 Hz to 20 kHz, with no more than 0.09% total harmonic distortion (FTC)

Pre amp section

Signal-to-noise ratio (IHF-A)

Phono: 75 dB

CD, Tape, Video: 93 dB

Input sensitivity/impedance

Phono: 2.5 mV/47 k-ohms

CD, Tape, Video: 200 mV/47 k-ohms

FM tuner section

Tuning frequency range:

87.5 MHz ~ 108 MHz

Useable sensitivity (IHF):

14.2 dBf (1.4 μ V at 75 ohms)

50 dB quieting sensitivity (stereo):

44.2 dBf (44 μ V at 75 ohms)

Total harmonic distortion (1 kHz):

Stereo: 0.7%

Mono: 0.6%

Signal-to-noise ratio at 65 dBf (IHF):

Stereo: 68 dB

Mono: 75 dB

Selectivity (IHF+400 kHz): 50 dB

Stereo separation at 1 kHz (IHF):

40 dB

Frequency response:

30 Hz ~ 15 kHz, +0.5 dB, -3.0 dB

AM tuner section

Tuning frequency range:

530 ~ 1700 kHz

Useable sensitivity:

20 μ V/(560 μ V/m)

Total harmonic distortion: 0.7%

Signal-to-noise ratio: 48 dB

Selectivity: 30 dB

General

Power consumption: 2.5 A

AC outlet (2 switched): 150 W

1.25 A max. total

Dimensions

Width: 17-5/16"

Height: 5"

Depth: 14-15/16"

Weight (net): 19.2 lb

CD player (DP-R797)

Format

Laser: Semiconductor laser

Channel format: 2 channel

Disc rotation speed: 200 ~ 500 rpm (CLV)

D/A converters: Dual 1 Bit

Oversampling digital filter:

8 fs (352.8 kHz)

Performance

Frequency response: 4 Hz ~ 20 kHz, +1.0 dB

Signal-to-noise ratio: >96 dB

Dynamic range: >94 dB

Total harmonic distortion + noise: <0.007% (1 kHz)

Channel separation: >90 dB (1 kHz)

Wow and flutter: Unmeasurable

Output level/impedance:

2.0 V/3.3 k-ohms

General

Power consumption: 10 W

Dimensions

Width: 17-5/16"

Height: 4-3/16"

Depth: 15-9/16"

Weight (net): 11 lb

Cassette deck (KX-W597)

Format

Track system: 4 track, 2 channel

Recording system: AC bias
(105 kHz)

Heads

Well-A: Playback head x 1

Well-B: Record/playback head x 1.

Erase head x 1

Performance

Wow and flutter: 0.3% (WRMS)

Fast-wind time: Approx 110
seconds (C-60 tape)

Frequency response:

Normal tape: 30 Hz ~ 13 kHz, +3 dB

High-bias tape: 30 Hz ~ 13 kHz, +3 dB

Signal-to-noise ratio: (3% 3rd
harmonic distortion, high bias tape):

Dolby NR OFF: >57 dB

Dolby B NR ON: >66 dB

Harmonic distortion (315 Hz,
250 nWb/m, high bias tape): <1%

Input sensitivity/impedance:
122.8 mV/47 k-ohms

Output level/impedance:
775 mV/3.3 k-ohms

General

Power consumption: 12 W

Dimensions

Width: 17-5/16"

Height: 5-1/16"

Depth: 9-13/16"

Weight (net): 8.8 lb

Equalizer (KE-597)

Performance

Center frequencies:
60Hz, 150Hz, 400Hz, 1kHz, 2.4kHz,
6kHz, 15kHz

Adjustment range: +10dB

Total harmonic distortion
(20Hz ~ 20kHz): <0.008%

Signal-to-noise ratio
(IHF-A weighting): 96dB

Input impedance: 47k-ohms

Maximum output level/impedance
4.3V/2k-ohms

General

Power consumption: 5W

Dimensions:

Width: 17-5/16"

Height: 2-15/16"

Depth: 10-3/4"

Weight: 5 lb

Speakers (JL-507)

Drivers

Woofer: 12" cone-type

Midrange: 4" cone-type

Tweeter: 1/2" dome-type

Power handling: 100 watts

General

Dimensions

Width: 14-3/16"

Height: 35-7/16"

Depth: 9-3/8"

Weight (net): 27.5 lbs

Because Kenwood follows a policy
of continuous product improve-
ment, these specifications may be
changed without notice.

Notes

Notes

KENWOOD USA CORPORATION
PO Box 22745
Long Beach, California 90801-5745
www.kenwoodusa.com



Free Manuals Download Website

<http://myh66.com>

<http://usermanuals.us>

<http://www.somanuals.com>

<http://www.4manuals.cc>

<http://www.manual-lib.com>

<http://www.404manual.com>

<http://www.luxmanual.com>

<http://aubethermostatmanual.com>

Golf course search by state

<http://golfingnear.com>

Email search by domain

<http://emailbydomain.com>

Auto manuals search

<http://auto.somanuals.com>

TV manuals search

<http://tv.somanuals.com>