

KENWOOD

LIFE STYLE HI-FI COMPONENT SYSTEM

C-707I

INSTRUCTION MANUAL

Kenwood Corporation

This model consists of a main unit (RD-C707) and a pair of speakers (LS-C707).



**Declaration of Conformity with regard to
the EMC Directive 2004/108/EC**

Manufacturer:

Kenwood Corporation
2967-3 Ishikawa-machi, Hachioji-shi, Tokyo, 192-8525 Japan

EU Representative's:

Kenwood Electronics Europe BV
Amsterdamseweg 37, 1422 AC UITHOORN, The Netherlands



© B60-5700-08/00 (E/X) AB

Safety Precautions

Before Applying Power

 **Caution:** Read this page carefully to ensure safe operation.





Units are designed for operation as follows.

Australia AC 240 V only

Europe AC 230 V only

Safety precautions

WARNING : TO PREVENT FIRE OR ELECTRIC SHOCK, DO NOT EXPOSE THIS APPLIANCE TO RAIN OR MOISTURE.

 <div style="display: inline-block; border: 1px solid black; padding: 5px; text-align: center;">CAUTION RISK OF ELECTRIC SHOCK DO NOT OPEN</div> 	
CAUTION: TO REDUCE THE RISK OF ELECTRIC SHOCK, DO NOT REMOVE COVER (OR BACK). NO USER-SERVICEABLE PARTS INSIDE. REFER SERVICING TO QUALIFIED SERVICE PERSONNEL.	
	THE LIGHTNING FLASH WITH ARROWHEAD SYMBOL, WITHIN AN EQUILATERAL TRIANGLE, IS INTENDED TO ALERT THE USER TO THE PRESENCE OF UNINSULATED "DANGEROUS VOLTAGE" WITHIN THE PRODUCT'S ENCLOSURE THAT MAY BE OF SUFFICIENT MAGNITUDE TO CONSTITUTE A RISK OF ELECTRIC SHOCK TO PERSONS.
	THE EXCLAMATION POINT WITHIN AN EQUILATERAL TRIANGLE IS INTENDED TO ALERT THE USER TO THE PRESENCE OF IMPORTANT OPERATING AND MAINTENANCE (SERVICING) INSTRUCTIONS IN THE LITERATURE ACCOMPANYING THE APPLIANCE.

The marking of products using lasers



The marking this product has been classified as Class 1. It means that there is no danger of hazardous radiation outside the product.

Location: Back panel

IMPORTANT SAFETY INSTRUCTIONS

⚠ Caution: Read this page carefully to ensure safe operation.

Read Instructions

– All the safety and operating instructions should be read before the product is operated.

Retain Instructions

– The safety and operating instructions should be retained for future reference.

Heed Warnings

– All warnings on the product and in the operating instructions should be adhered to.

Follow Instructions

– All operating and use instructions should be followed.

1. Cleaning

– Unplug this product from the wall outlet before cleaning. Do not use liquid cleaners or aerosol cleaners. Use a damp cloth for cleaning.

2. Attachments

– Do not use attachments not recommended by the product manufacturer as they may cause hazards.

3. Water and Moisture

– This product shall not be exposed to dripping and splashing – for example, near a bath tub, wash bowl, kitchen sink, or laundry tub; in a wet basement; or near a swimming pool; and the like. Do not place an object containing liquid, such as a flower vase, on the appliance.

4. Accessories

– Do not place this product on an unstable cart, stand, tripod, bracket, or table. The product may fall, causing serious injury to a child or adult, and serious damage to the product. Use only with a cart, stand, tripod, bracket, or table recommended by the manufacturer. Any mounting of the product should follow the manufacturer's instructions, and should use a mounting

accessory recommended by the manufacturer.

A product and cart combination should be moved with care.

Quick stops, excessive force, and uneven surfaces may cause the product and cart combination to overturn.



5. Ventilation

– Slots and openings in the cabinet are provided for ventilation and to ensure reliable operation of the product and to protect it from overheating, and these openings must not be blocked or covered. The openings should never be blocked by placing the product on a bed, sofa, rug, or other similar surface. This product should not be placed in a built-in installation such as a bookcase or rack unless proper ventilation is provided or the manufacturer's instructions have been adhered to.

6. Power Sources

– This product should be operated only from the type of power source indicated on the product. If you are not sure of the type of power supply to your home, consult your product dealer or local power company.

7. Polarization

– This product may be equipped with a polarized alternating-current line plug (a plug having one blade wider than the other). This plug will fit into the power outlet only one way. This is a safety feature. If you are unable to insert the plug fully into the outlet, try reversing the plug. If the plug should still fail to fit, contact your electrician to replace your obsolete outlet. Do not defeat the safety purpose of the polarized plug.

Continued to next page

IMPORTANT SAFETY INSTRUCTIONS

8. Power Cord Protection

– Power-supply cords should be routed so that they are not likely to be walked on or pinched by items placed upon or against them, paying particular attention to cords at plugs, convenience receptacles, and the point where they exit from the product.

9. Lightning

– For added protection for this product during a lightning storm, or when it is left unattended and unused for long periods of time, unplug it from the wall outlet and disconnect the antenna or cable system. This will prevent damage to the product due to lightning and power-line surges.

10. Overloading

– Do not overload wall outlets, extension cords, or integral convenience receptacles as this can result in a risk of fire or electric shock.

11. Object and Liquid Entry

– Never push objects of any kind into this product through openings as they may touch dangerous voltage points or short-out parts that could result in a fire or electric shock. Never spill liquid of any kind on the product.

12. Servicing

– Do not attempt to service this product yourself as opening or removing covers may expose you to dangerous voltage or other hazards. Refer all servicing to qualified service personnel.

13. Damage Requiring Service

– Unplug this product from the wall outlet and refer servicing to qualified service personnel under the following conditions:

- a) When the power-supply cord or plug is damaged,
- b) If liquid has been spilled, or objects have fallen into the product,
- c) If the product has been exposed to rain or water,
- d) If the product does not operate normally by following the operating instructions.
- e) If the product has been dropped or damaged in any way, and
- f) When the product exhibits a distinct change in performance – this indicates a need for service.
- g) If an abnormal smell or smoke is detected.

14. Replacement Parts

– When replacement parts are required, be sure the service technician has used replacement parts specified by the manufacturer or have the same characteristics as the original part. Unauthorized substitutions may result in fire, electric shock, or other hazards.

15. Safety Check

– Upon completion of any service or repairs to this product, ask the service technician to perform safety checks to determine that the product is in proper operating condition.

16. Wall or Ceiling Mounting

– This product should be mounted to a wall or ceiling only as recommended by the manufacturer.

17. Heat

– This product should be situated away from heat sources such as radiators, heat registers, stoves, or other products that produce heat. Do not place a flaming object, such as a candle or lantern, or near the product.

18. Power Lines

– An outside antenna system should not be located in the vicinity of overhead power lines or other electric light or power circuits, or where it can fall into such power lines or circuits. When installing an outside antenna system, extreme care should be taken to keep from touching such power lines or circuits as contact with them might be fatal.

19. Outdoor Antenna Grounding

– If an outside antenna or cable system is connected to the product, be sure the antenna or cable system is grounded so as to provide some protection against voltage surges and built-up static charges. Article 810 of the National Electrical Code, ANSI/NFPA 70, provides information with regard to proper grounding of the mast and supporting structure, grounding of the lead-in wire to an antenna discharge unit, size of grounding conductors, location of antenna-discharge unit, connection to grounding electrodes, and requirements for the grounding electrode.

EXAMPLE OF ANTENNA GROUNDING AS PER NATIONAL ELECTRICAL CODE

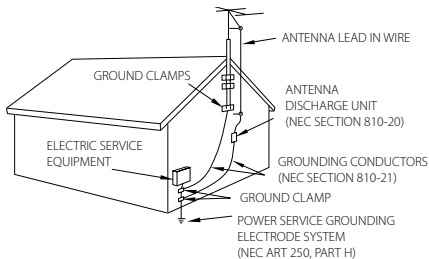

NEC – NATIONAL ELECTRICAL CODE

Notes:

1. Item 7 is not required except for grounded or polarized equipment.
2. Item 19 complies with UL in the U.S.A.

Information on Disposal of Old Electrical and Electronic Equipment (applicable for EU countries that have adopted separate waste collection systems)



Products with the symbol (crossed-out wheeled bin) cannot be disposed as household waste. Old electrical and electronic equipment should be recycled at a facility capable of handling these items and their waste byproducts. Contact your local authority for details in locating a recycle facility nearest to you. Proper recycling and waste disposal will help conserve resources whilst preventing detrimental effects on our health and the environment.

How to Use This Manual

Operation procedure

While this system can be controlled from either the remote control or the main unit, the explanations in this manual primarily describe operation procedures using the remote control.

Remote control keys used in the procedure

Display shown during or after an operation

- The displays shown in this instruction manual may differ from the actual displays.



CD

This section explains how to play a CD. In addition to commercially available music CDs, you also can play discs with MP3 and WMA audio files recorded on them. For details, see <Supported Media> (page 24).

Playing a CD

Load and play the CD.

- If a disc is already loaded, simply press the [CD▶/II] key to turn the system on and begin playback.

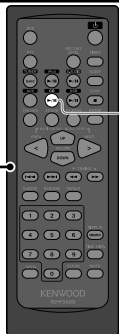

1 Open the slide door and load the CD.

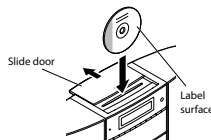

- Center the CD with the inlet slot with the label side facing towards the front of the main unit.
- After you insert the CD part way, it will be pulled automatically the rest of the way in.

2 Slide the slide door towards the front panel to close it.

- The CD will not play unless the slide door is closed.

3 Press the [CD▶/II] key.

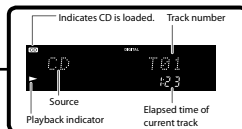

- Track numbers may not display correctly while following types of discs are playing.
 - Discs recorded in Mix mode*
 - Discs recorded in multiple sessions
 - Discs recorded in mixed formats of CD-DA format and non-music data formats
- * Mix mode combines the CD-DA format with audio files, such as MP3 and WMA.

Operation icons



Explains the procedure for CDs.



Explains the procedures for USB devices.



Explains the procedure for the radio.



Explains the procedure for digital audio players.



Explains the procedures for iPods.



Explains the procedures for external components.



Explains how to set the sound quality.



Explains how to set up component units.



Explains how to carry out system maintenance.



Explanations of remote control procedures



Explanations of main unit procedures

Supplementary information about procedures

Related functions that may also be helpful

CD

Related Information

- Supported Media → Page 24
- Audio Settings → Page 63 onwards
- Selecting Track Program Playback Mode → Page 39



• Cautions when loading a CD

- A CD cannot be loaded while the system is in Standby mode.
- Do not try to force a CD into the inlet slot while the system is in Standby mode. Doing so can cause malfunction.
- If you experience problems loading a CD, pull it out and then re-insert it.
- Do not touch the playing surface of the disc.
- Use of an 8 cm CD adapter is not supported.
- If you insert an 8 cm CD so it is off center relative to the inlet slot, it will not slide all the way into the slot. Take care when using an 8 cm CD.
- If a CD is already loaded, opening the slide door will eject it.

Removing a CD



1 Press the [■] key to stop playback.



2 Slide the slide door cover towards the back panel to eject the CD.

Sliding the slide door will eject the CD.

- If the CD is playing when you slide the slide door to the back panel, playback will stop and the CD will be ejected.

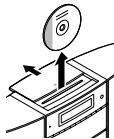

3 Slide the slide door towards the front panel to close it.



- A CD cannot be ejected while the system is in Standby mode.
- Ejecting a CD deletes all program playback settings. (Page 39)



What the System Can Do



Wide range of recording formats

Disc Playback

As well as music CDs, the system will also play discs containing recorded audio files (MP3/WMA).



Supports USB device connection

USB Input Port

A USB port supports connection of USB flash memory and USB mass storage class compliant digital audio players.



Supports iPod connection

iPod Input Connector

An iPod connector lets you enjoy using the system with your Apple iPod.



Supports many types of components

External Input Terminals

An AUX input terminal supports connection of a cassette deck, a video deck, or other device.



Kenwood digital audio player support

D.AUDIO IN terminal

This input terminal supports use of a Kenwood digital audio player, which can be controlled using the system or remote control.



Supports recording from a variety of sound sources

REC OUT Function

Connecting a Kenwood memory audio player provides support of various different sound sources.



To ensure safety, read the items by this mark carefully.

Before Using the System

Be sure to read these precautions.

⚠ Safety Precautions.....	2
⚠ Before Applying Power	2
⚠ IMPORTANT SAFETY INSTRUCTIONS	3
How to Use This Manual	6
Accessories	10
Installing the System	11
Connecting the System	12
Component Names and Functions	18
Basic Operation	22
Important Information	24

Procedures by Input Source ▶▶ P.29

This chapter explains how to connect and use the system with the different input sources.

- CD
- USB
- CD/USB Playback Operations
- Receiving Radio Broadcasts
- RDS (Radio Data System)
- D.AUDIO
- iPod
- External Components

Audio Settings ▶▶ P.63

This chapter explains how to tailor the system to your audio preferences.

- EX.BASS
- SOUND

Component Settings ▶▶ P.67

This chapter explains how to select the settings for the system.

- Setting the System Clock
- Setting the Timer
- Display Settings
- Auto Power Save

Maintenance ▶▶ P.77

This chapter explains how to store and maintain your system so that it continues to give pleasure for many years to come.

- Messages
- Troubleshooting
- Glossary
- Care and Storage
- Specifications



Accessories

Check that all accessories are present in the package.

AM loop antenna (1)

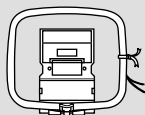

FM indoor antenna (1)



Remote control (RC-F0509E: 1)

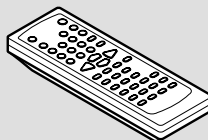

Remote control batteries (R6: 2)

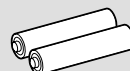

Speaker cords (50 cm: 2)



- The speaker cords are connected at the factory.

AC adapter (AC-120400A: 1)

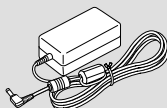

Power cord (1)

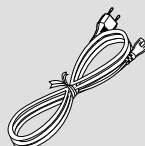

If any accessories are missing, or if the unit is damaged or fails to operate, notify your dealer immediately. If the unit was shipped to you directly, notify your shipper immediately. Kenwood recommends that you retain the original carton and packing materials in case you need to move or ship the unit in the future. Keep this manual handy for future reference.

Installing the System

Notes on installing the system

- Always install the system on a flat, stable surface. When installing the system on a stand of some sort, be sure to check the strength of the stand.
- Do not locate the speakers too close to a TV or PC. The magnets used in the speakers may cause color irregularities on TV or PC screens.
- When moving this system, be sure to hold onto the main unit. Holding onto the speakers can cause the main unit to fall.

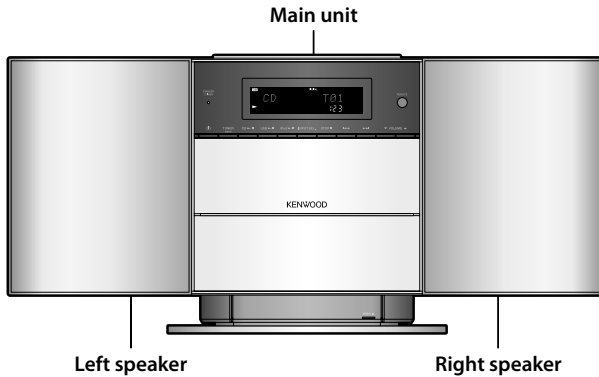

CAUTION

Observe the following cautions when installing the system. Insufficient heat radiation may build up internal heat and cause a malfunction or fire hazard.

- Do not place any object on the system that may hinder heat radiation.
- Leave spaces around the cabinets of the main unit as specified below.
Top panel: 50 cm or more, Side panel: 10 cm or more, Back panel: 10 cm or more

Install the system so the power outlet is easily accessible, and unplug the power cord from the power outlet immediately in case of any trouble.

Note that the power supply to the system is not shut down completely by simply setting the power switch to OFF.

To shut down the power supply completely, unplug the power cord.

Getting the best acoustic effect

The sound will vary depending on the positioning of the speakers. To get the best possible sound quality, note the guidelines below.

- Ensure that the areas around the left and right speakers are as identical as possible. Set up the left and right speakers away from the wall and hang thick curtains on any windows to minimize echoes or reverberation.
- Position the speakers at the same height as your ears when you are using the system.

Connecting the System

Main Connections

Caution for Connection

Do not plug the AC power cord into an AC wall outlet until all the connections are completed. Before disconnecting any cords or cables, always turn the system off and unplug the power cord from the AC wall outlet.

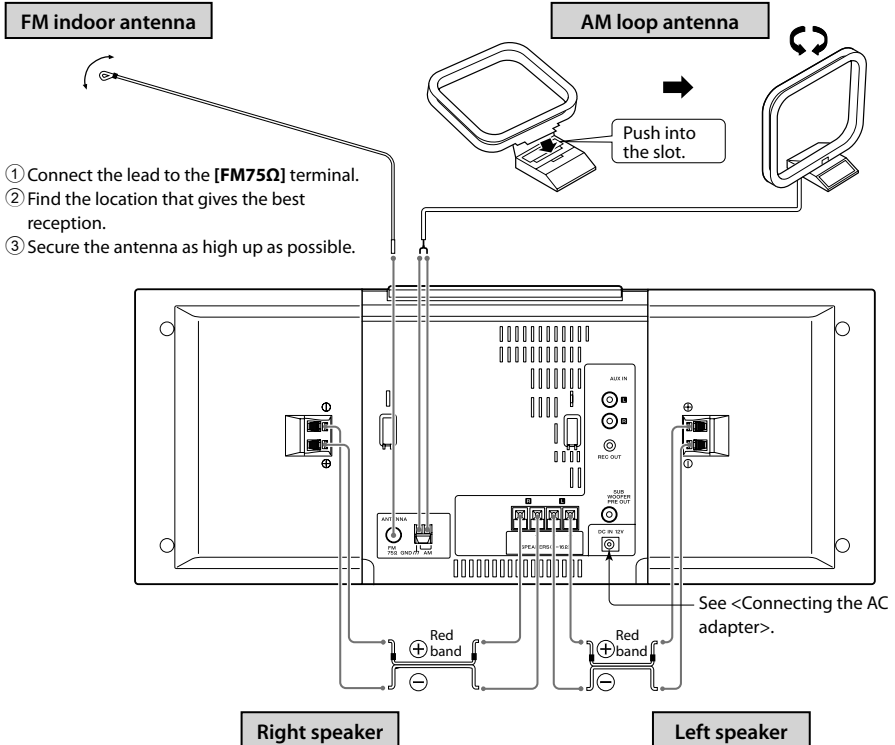

- 1 Connect the lead to the **[FM75Ω]** terminal.
- 2 Find the location that gives the best reception.
- 3 Secure the antenna as high up as possible.

- The speaker cords are connected at the factory.

Microcomputer malfunctions

If the system does not operate normally or shows display errors, reset the microcomputer. (Page 81)

Connecting the AC adapter

Use only the AC-120400A that comes with this product.

To ensure optimum operation of the system, locate the AC adapter as far away as possible from the system.

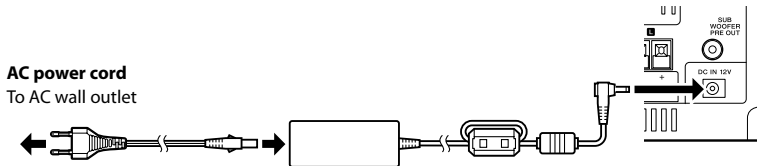
**⚠ AC adapter cautions**

- Do not cover or wrap the AC adapter with cloth, blanket or other material. Doing so will result in fire due to excessive heat accumulating in the adapter.

Connecting the AM loop antenna

The antenna supplied with the system is for indoor use. Place it as far away as possible from the system, your TV set, the speaker cords, AC adapter and the power cord, and point it in the direction that provides the best reception.

• Connecting the antenna cord

Connect the AM antenna cord to the **[AM]** and **[GND]** terminals, as shown on the right.

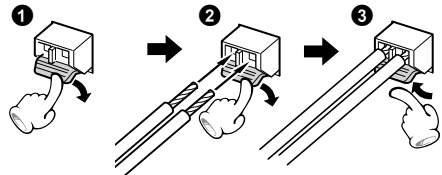
**Connecting the FM indoor antenna**

The antenna supplied with the system is a basic antenna for indoor use. For stable signal reception, the use of an outdoor antenna (commercially available) is recommended. Disconnect the indoor antenna first before connecting an outdoor antenna.

Detaching and attaching the speakers

You can detach the speakers from the main unit and position them as you like.

Before detaching or attaching the speakers, or replacing the speaker cords, always turn the system off and unplug the power cord from the AC wall outlet. If there is a disc in the main unit, remove it.

When only one of the speakers is detached, the unit is unstable and can tip over when subjected to vibration or impact. Take care whenever detaching or attaching speakers.

When attaching the speakers, make sure they are attached securely. Improper installation creates the risk of the speaker falling.

Detaching the speakers

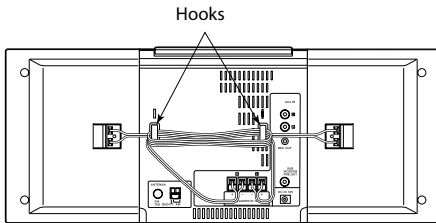

Remove the speaker cords from the hooks on the back of the main unit.

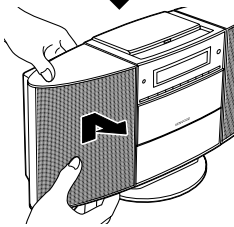

From the back of the speaker, move it as indicated by the arrow.

Take care so you do not drop the speaker.

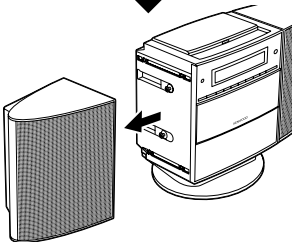

Detach the speaker from the main unit.

■ Placing a detached speaker on a flat surface

Lay the speaker onto the flat surface with the side that attaches to the main unit downwards.

The side of the speaker that attaches to the main unit has non-skid feed.

- The magnets used in the speakers may cause color irregularities on TV or PC screens. Do not locate the speakers too close to a TV or PC.

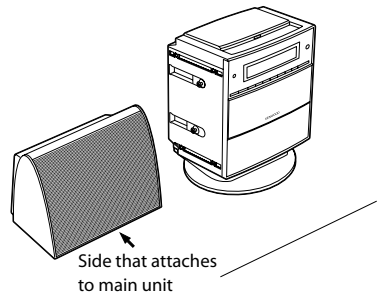

Side that attaches to main unit

Connecting the speakers

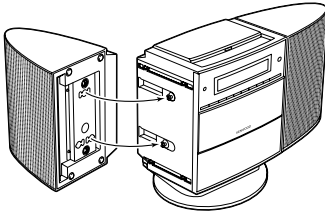

Align the speaker with the main unit so the protrusions in the main unit enter the installation holes of the speaker.

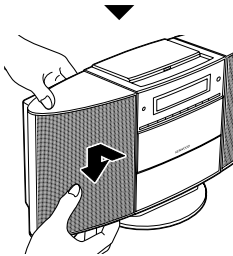

From the front of the speaker, move it as indicated by the arrow.

Replacing the speaker cords

If you want to use the speakers while they are detached from the main unit and the speaker cords are too short, you can replace the supplied cords with the following type of commercially available speaker cords: AWG24-18 (Conductor Diameter: 0.511 mm - 1.024 mm).

Strip about 1 cm of the vinyl insulation from the tips of both ends of the replacement speaker cords, twist the ends of the wires together so they do not unravel when you connect them.

- **Preparing the ends of the speaker cords**

Twist the plastic sleeve on the end of the cord as you pull it off.



- **Connecting the speaker cords**

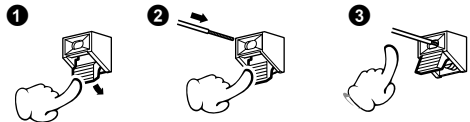

Notes on connecting the speaker cords

Never short-circuit the positive (+) and negative (-) ends of the speaker cords. (Do not touch the + and - cords together.) Mistakenly reversing the positive and negative polarity will result in unnatural and unclear sound.

Connecting Other (Commercially Available) Devices



- When connecting a related system component, read the instruction manual that comes with the component too.
- Ensure that all the cords are securely connected. Loose or incomplete connections may result in noise interference or no sound at all.



Caution for outdoor antenna installation

Since antenna installation requires skill and experience, always consult your dealer before installation. The antenna should be located away from power lines. If the antenna falls over, contact with a power line creates the risk of electric shock.

Opening the front panel

To connect other devices to the front panel connectors of the main unit, raise the panel cover and then connect the devices.

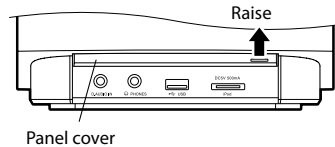

D.AUDIO IN

Connect digital audio players to the **[D.AUDIO IN]** terminal on the front panel of the main unit.

- If you connect a Kenwood player that supports digital audio link using the dedicated cable, you can control the player from the main unit and the remote control. (Page 48) It can also be connected using a 3.5 mm stereo mini-plug cable (commercially available unit).
- When you are not using the digital audio player, unplug the mini-plug cable from the main unit.

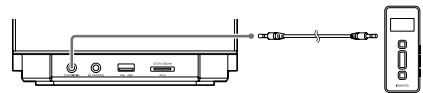

Digital audio player

USB

Connect USB flash memory or USB mass storage class compliant digital audio players to the **[USB]** port on the front panel of the main unit.

- Depending on the device being connected, it may take some time for the system to recognize it.
- With some models, a USB connection mode selection screen will appear. Select "Storage Mode".

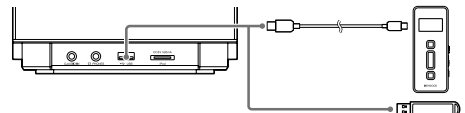

iPod

Connect an iPod to the **[iPod]** terminal on the front panel of the main unit.

- To connect an iPod, you will need a PNC-iP120 iPod connection cable (optional accessory).
- When you are not using the iPod, unplug the iPod connection cable from the main unit.
- For information about supported iPod models, see page 27.

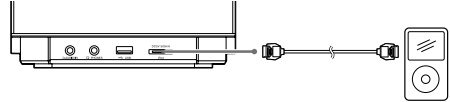

AUX IN

Connect the audio OUT terminals on components such as VCRs to the **[AUX IN]** terminal on the rear panel of the main unit.

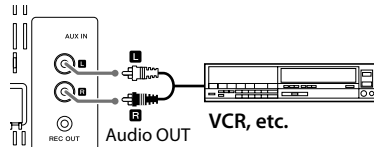

REC OUT

Connect a Kenwood digital audio player with direct encode feature to the **[REC OUT]** terminal on the rear panel of the main unit.

- **[REC OUT]** outputs an analog audio signal.

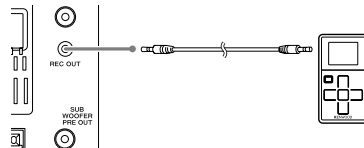

SUB WOOFER PRE OUT

Connect a subwoofer (such as the optional SW-40HT) to the **[SUB WOOFER PRE OUT]** terminal on the rear panel of the main unit.

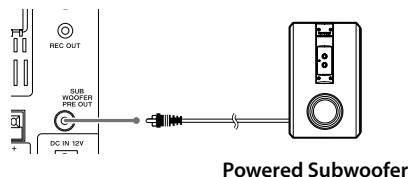

PHONES

Plug headphones equipped with a 3.5 mm stereo mini-plug into the **[PHONES]** jack on the front panel of the main unit.

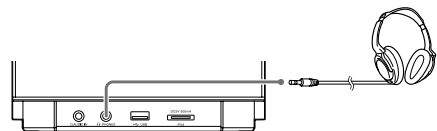

Component Names and Functions

Main unit

■ Top

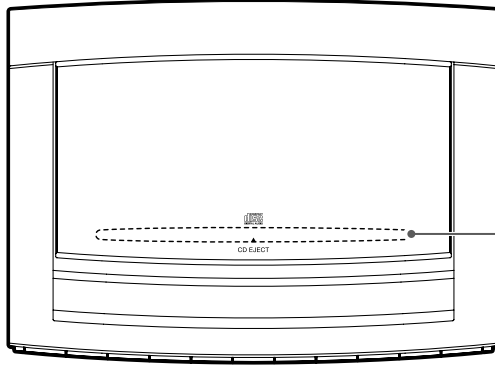

CD slot (Page 30)

■ Front

Standby timer indicator

Red:
Normal standby
Orange:
Timer standby

Power (Page 23)

Turns the system on or off (Standby).

TUNER/band (Page 42)

CD / (Page 30)

USB / (Page 32)

iPod / (Page 56)

[D.AUDIO IN] terminal (Pages 16, 48)

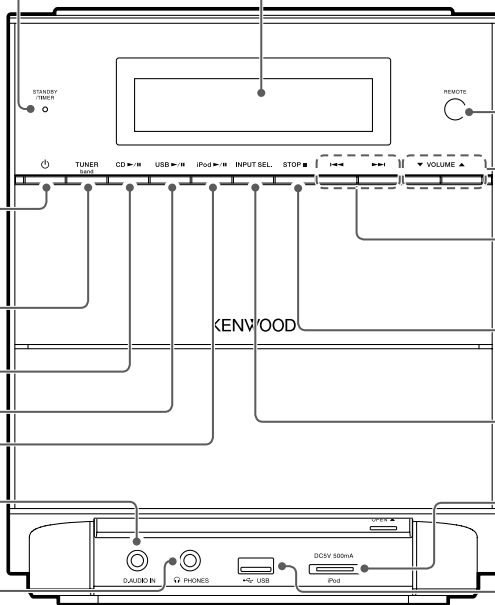

[PHONES] jack (Page 17)



Display (Page 19)

Remote sensor (Page 21)

VOLUME (Page 22)

 
(Pages 34, 35, 50, 57)

STOP 
(Pages 34, 35)

INPUT SEL.
(Pages 48, 60)









[iPod] terminal
(Pages 17, 56)

[-USB] port
(Pages 16, 32)

Standby Mode

While the [STANDBY/TIMER] indicator on the main unit is lit, the system is using very weak current to maintain the built-in memory. This is called Standby mode. When system main unit is in this mode, you can turn it on using the remote control.

One-touch Operation

This system features a convenient one-touch operation function. In Standby mode, pressing any of the following keys will turn on system power: [TUNER/band], [CD  / ], [USB  / ], [iPod  / ], [D.AUDIO  / ] (remote control only) or [AUX] (remote control only). If there is a disc loaded, playback will begin.

Display

The displays shown here may differ from the actual display.

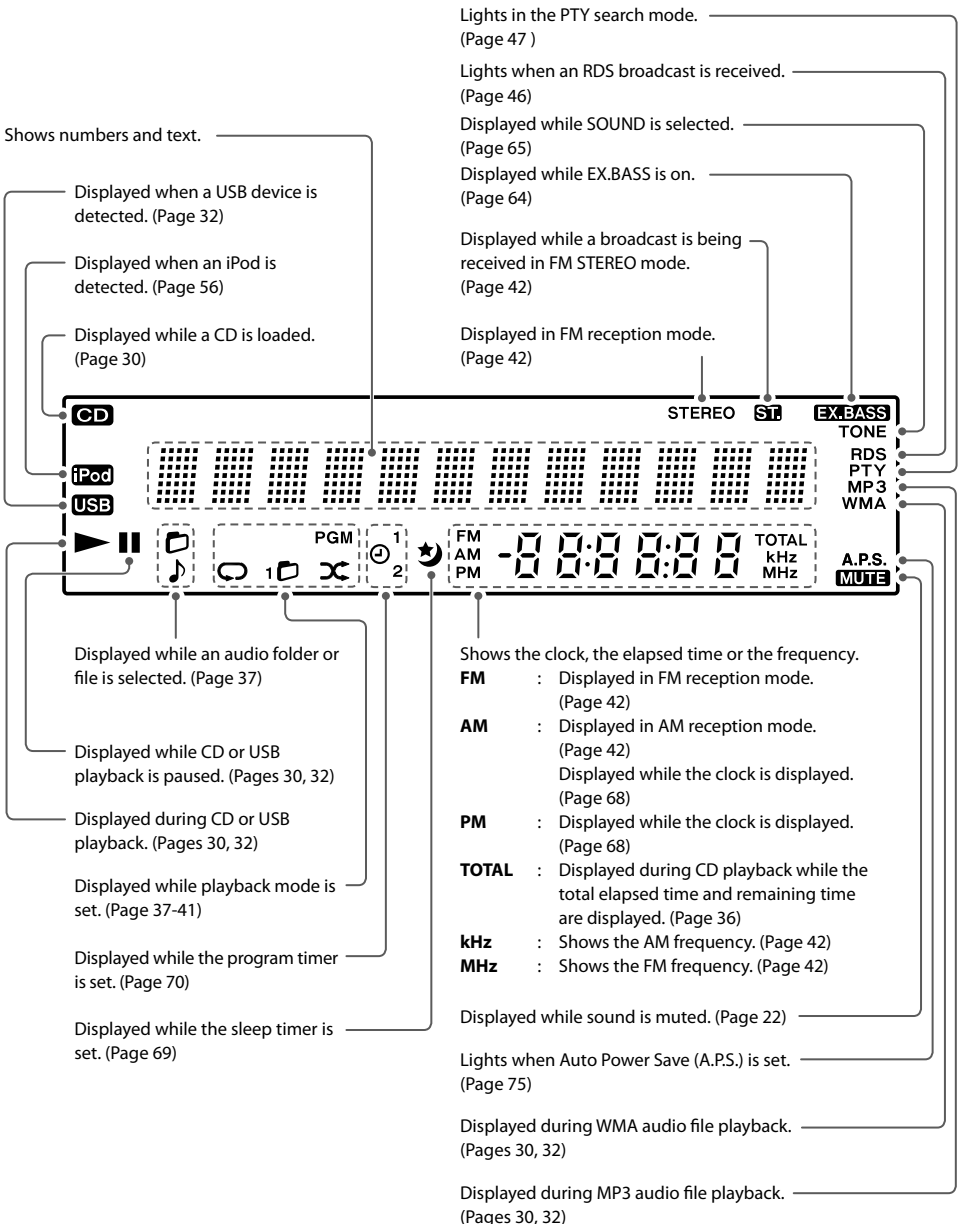

Remote control

Remote control keys with the same names as keys on the main unit have the same functions as the main unit keys.

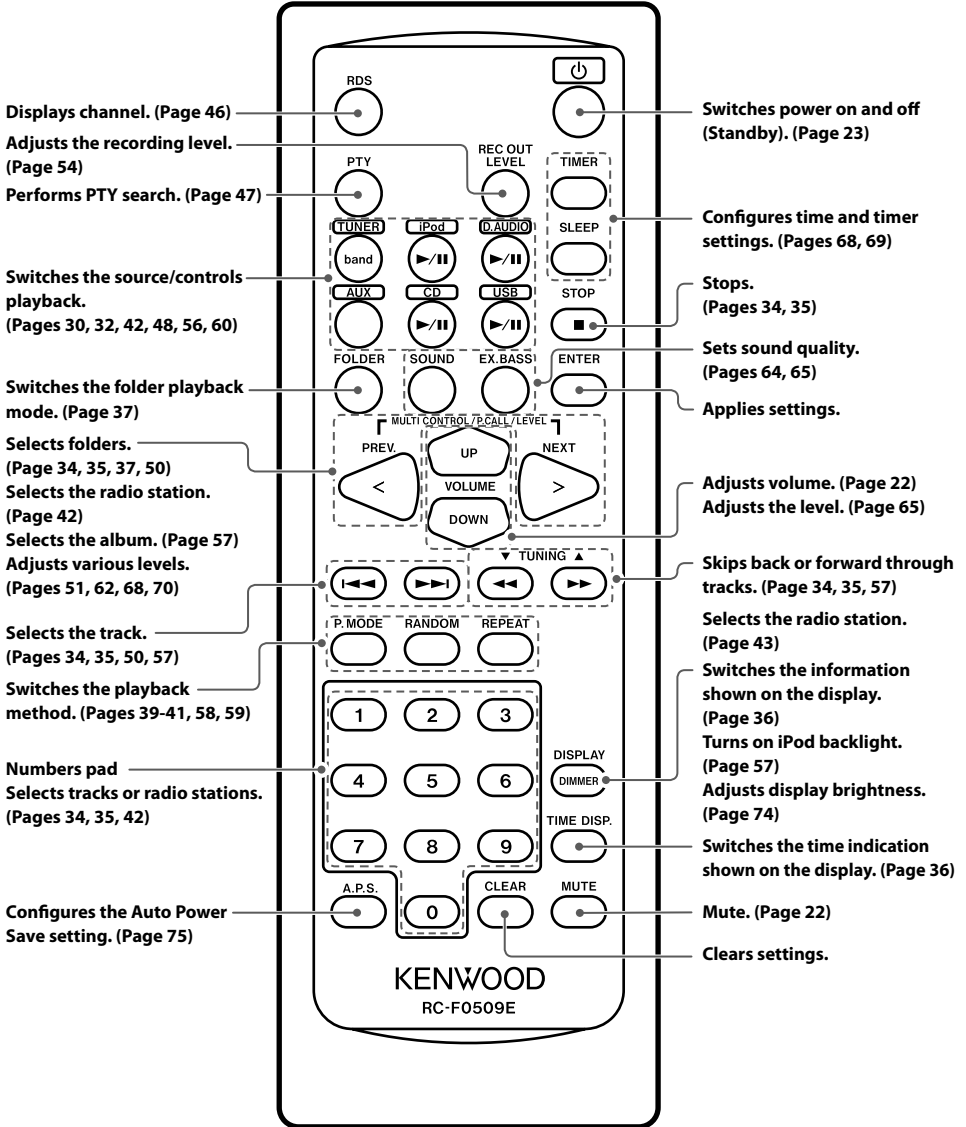

Using the remote control

After plugging the main unit into an AC wall outlet, press the power [⏻] key on the remote control unit to turn the system on.
After the system powers up, press the key for the function you want to use.
Point the remote control at the remote sensor when using it.

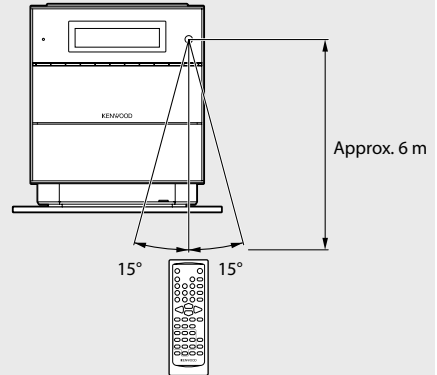

- The remote control may not operate correctly if direct sunlight or light from a high-frequency fluorescent lamp (such as an inverter type) is shining on the remote sensor. If this happens, move the system to a different location to avoid this type of malfunction.

Loading the remote control batteries

- The batteries supplied with the system are for operational testing and may last only for a short time.

① Remove the battery cover.

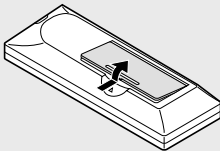

② Load the R6-size batteries supplied with the system.

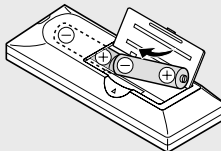

③ Close the battery cover.

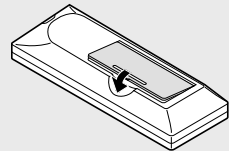

⚠ CAUTION

- Always replace the batteries with two new ones.
- Check the polarity of the batteries (⊕ ⊖) when loading them.
- Never heat or take apart the batteries, or put them in the fire or the water.
- If batteries are not used correctly, they may burst or leak. This will cause a fire, injury to persons or damage to the surroundings.

Basic Operation

This section explains basic general operations and how to play music.

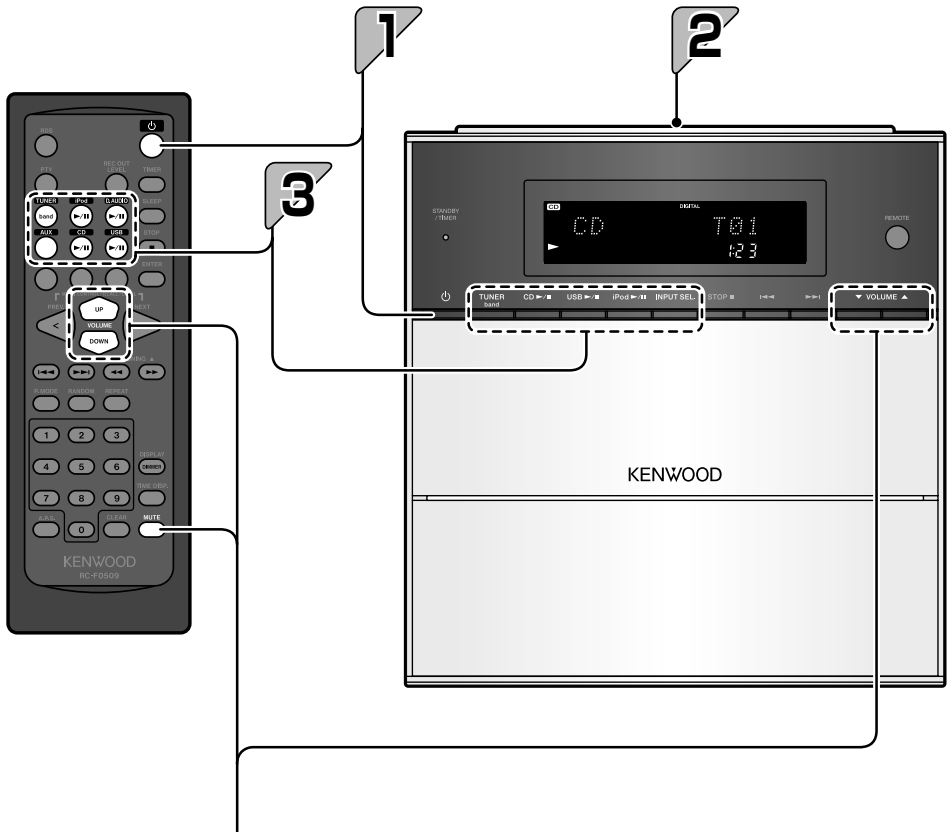

■ Adjusting the volume level



Lowers the volume

▼ VOLUME ▲

Raises the volume



Raises the volume



Lowers the volume

■ Mute



- Press this key again to unmute the sound.

Preparations

- Check the connections. (Pages 12-17)
- Have the remote control ready. (Page 21)
- If you plan to use a USB device, digital audio player, iPod, or other external device, connect the device to the main unit. (Pages 16, 17)

1

Turn on the system.

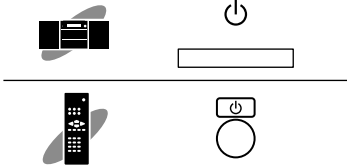

- Pressing the **[TUNER/band]**, **[CD▶/II]**, **[USB▶/II]**, **[iPod▶/II]**, **[INPUT SEL.]** (main unit only), **[D.AUDIO▶/II]** (remote control only), or **[AUX]** (remote control only) key will turn on power.
- Pressing the power [**⏻**] key when the system is on turns it off (Standby mode).

2

Load a disc (CD).

For other types (non-CD) of playback, proceed to step 3.

- See page 30 for information about how to load a CD.

3

Start playback.

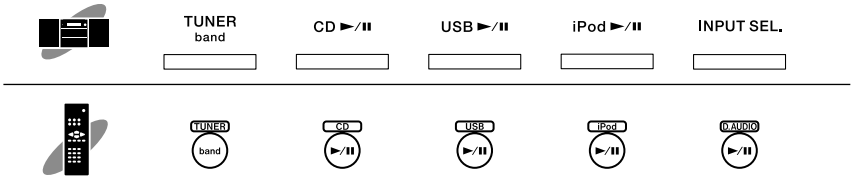

Press the Play/Pause key for the input source. See <Procedures by Input Source> (pages 29-62) for details. If you are using an external device, perform the required operation on the external device to start playback.



- You can select the sound quality you want. See <Audio Settings> (pages 63-65) for details.
- If the system is not operated for a specified period of time the display starts to scroll to protect the screen from image burn and uneven brightness.

Important Information

Supported Media

Media	Icon in this manual	Explanation
USB USB flash memory USB mass storage class compliant digital audio player		<ul style="list-style-type: none">● Never connect any other device besides USB flash memory or a USB mass storage class compliant digital audio player to the [USB] terminal. Note that Kenwood will not be held liable for any losses related to malfunction, damage, or data loss due to connection of any other type of device.
CD Commercially available music CDs CD-R/CD-RW recorded with CD-DA format CD-ROM/CD-R/CD-RW discs recorded with MP3/WMA files		<ul style="list-style-type: none">● You may not be able to play discs that do not conform to the CD standard, such as Copy Control CDs.● Discs must be finalized during writing.● In this manual, MP3 and WMA files are referred to collectively as "audio files".● Depending on the equipment or recording mode used for recording onto a CD-ROM, CD-R or CD-RW disc, and depending on the type of CD-ROM, CD-R or CD-RW disc used, you may not be able to play the disc on this system.

Precautions when writing data to discs

- Discs recorded in Packet Write mode or UDF (Universal Disc Format) cannot be played.
- When writing data to a disc, always close the session or finalize the disc. The disc may not play properly if you do not close the session or finalize the disc.
- Depending on the specifications of the writing software used, the recorded folder names and file names may not be displayed correctly.
- Playback for multi-session discs or discs that contain large numbers of folders may take longer to begin than for normal discs.
- If you write audio files and music CD tracks (CD-DA format) to the same disc, the disc may not play correctly.
- Before writing audio files to a disc, check that the files play back correctly on the PC being used to write the files. After you finish writing, check that the written files are played back correctly.
- Use the correct file extensions (mp3, wma) in the names of audio files. Files without file extensions will not play. Also, do not use audio file extensions (mp3, wma) for files that are not audio files.
For more information on file extensions, see <Supported Audio Files> on the right.

Supported Audio Files

On this system, you can play the audio file types listed below (MP3, WMA), which have been recorded with a CD-ROM, CD-R, CD-RW, or USB device.

MP3 files

File formats: MPEG 1 Audio Layer 3/ MPEG 2 Audio Layer 3/ MPEG 2 Audio Layer 3, Lower sampling rate (MPEG 2.5)

Extension: .mp3

Sampling frequency: 8 kHz to 48 kHz

Bit rate: 32 kbps to 320 kbps

WMA files

File format:

Windows Media™ Audio compliant

Extension: .wma

Sampling frequency: 32 kHz to 48 kHz

Bit rate: 64 kbps to 192 kbps

- Files created using functions in Windows Media™ Player 9 or later cannot be played.
 - WMA Professional
 - WMA Lossless
 - WMA Voice

Disc formats

ISO 9660 Level 1

ISO 9660 Level 2

Joliet

Romeo

USB Supported File Systems

FAT16

FAT32

Number of File Limits

Max. files/folders: 65280 in total

Max. folders: 255

Files per folder: 256

Maximum number of displayable characters

File names: 32 (including file extension)

Folder names: 32

Tag display (Title/Album/Artist): 30

- This system is capable of displaying alphanumeric characters. Other character types are displayed as pound (#) marks.

Other notes

- Note that even where audio files comply with the above standards, playback may fail due to factors such as the disc characteristics or recording conditions.
- Playback also may fail depending on the specifications of the encoding software or the settings used for encoding.
- DRM (Digital Rights Management) files cannot be played.
- Audio files encoded using VBR (Variable Bit Rate) may use bit rates that fall outside the supported range. Audio files with bit rates outside the supported range cannot be played.

Windows Media is a trademark of Microsoft Corporation registered in the U.S. and other countries.

Handling Discs

Handling precautions

- When handing a disc, never touch the playing surface.

Discs playable on the system

- This system can play back CD (12 cm, 8 cm), CD-ROM, CD-R, or CD-RW discs, or the audio part of CD-EXTRA discs.
- Use of an 8 cm CD adapter is not supported.

Notes on CD-ROM/CD-R/CD-RW discs

If the CD-ROM, CD-R or CD-RW disc being used has a printable label surface, the label surface may cause sticking that makes it impossible to remove the disc from the system. To prevent malfunction of the system, do not use such discs.

Cautions on CD discs



Always use a disc carrying the  marking.

A disc without this marking may be unable to be played back correctly.

The disc rotates at a high speed during playback. Never use a cracked, chipped or greatly warped disc. Otherwise, damage or malfunction of the player may result. Also, do not use a disc with a non-circular shape as this may result in malfunction.

Handling USB devices

Handling precautions

- Be sure to read the instruction manual that comes with the device you are using.
- This system does not come with a USB device. It is up to you to purchase a commercially available USB device separately.
- The -USB port on the front panel of the main unit supports USB2.0 (Full speed).
- Do not use a USB device connected via a USB hub.
- Certain conditions while using a USB device can cause contents stored on the USB device to be lost. Note that Kenwood will not be held liable for any losses arising out of loss of stored contents.

Supported USB devices

The following are the limitations on the type of USB devices that can be used and on the scope of their use.

- USB mass storage class compliant
Consult your retailer to find out whether your USB device is USB mass storage class compliant.
- Maximum current consumption of 500 mA
Use of a USB device that does not comply with the above conditions may result in improper playback of track files. Even if a USB device does satisfy the above conditions, certain device types and conditions may make proper playback impossible.
- This system supplies power to USB devices, which means you can enjoy listening to music while charging your device. To do this, the system must be turned on and USB must be selected as the source.

Handling an iPod

Handling precautions

- Be sure to read the instruction manual that comes with the iPod you are using.
- This system does not come with an iPod. It is up to you to purchase an Apple iPod separately.
- Certain conditions while using an iPod can cause contents stored on the iPod to be lost. Note that Kenwood will not be held liable for any losses arising out of loss of stored contents.

Supported iPod models

- To connect an iPod, you will need a PNC-iP120 iPod connection cable.
- The following are the iPod models that can be connected to this system. (As of November 2007)

Controllable iPod	iPod Software version
iPod 4th Generation (Click wheel) 20GB/40GB	3.02 or more
iPod mini 4GB/6GB	1.2 or more
iPod 4th Generation (Color display) 20GB/30GB/40GB/60GB	1.0 or more
iPod nano (1st Generation) 1GB/2GB/4GB	1.0 or more
iPod nano (2nd Generation) 2GB/4GB/8GB	1.0 or more
iPod video (iPod 5th Generation) 30GB/60GB/80GB	1.0 or more
iPod nano 3rd Generation (video)* 4GB/8GB	1.0 or more
iPod classic*	1.0 or more

* Some functions not supported.

- This system supplies power to your iPod, which means you can enjoy listening to music while charging your iPod. To do this, the system must be turned on and iPod must be selected as the source.

Apple and iPod are trademarks of Apple Inc., registered in the U.S. and other countries.

Notes on transporting or moving the system

Before transporting or moving this system, take the following actions:

- ① Disconnect any iPod, USB flash memory, or USB audio player connected to the main unit. If there is a CD loaded in the system, remove it.
- ② Press the **[CD ► / III]** key and check to make sure that "NO DISC" appears on the display.
- ③ Wait a few seconds and then turn the system off.
- ④ If there are any other components connected to the system, check to make sure they are all turned off before disconnecting the cables.

Whenever moving the system, make sure you hold onto the main unit. The main unit may fall if you hold onto the speakers.

Procedures by Input Source

This chapter explains the operation procedures for each input source. For information on the sound quality settings and component settings regardless of the input source, see <Audio Settings> (page 63) and <Component Settings> (page 67). If an error is displayed or a problem arises, see <Maintenance> (page 77).

CD

- Playing a CD 30
- Removing a CD 31

USB

- Playing back from a USB device 32
- Disconnecting a USB device 33

CD/USB Playback Operations

- Operations During Playback 34
- Switching Display Contents 36
- Selecting Folder Playback Mode 37
- Selecting Track Program Playback Mode 39
- Track Random Playback Mode 41
- Track Repeat Playback Mode 41

Receiving Radio Broadcasts

- Listening to FM/AM Radio 42
- Presetting Stations 44
- Clearing All Preset Stations 45

RDS (Radio Data System)

- PS (Program Service) Name Display 46
- Searching for a Desired Program Type (PTY Search) 47

D.AUDIO

- Playing Back from a Digital Audio Player 48
- Disconnecting the Digital Audio Player 49
- Adjusting the Input Level 51
- Recording to a Digital Audio Player 52
- Adjusting the Recording Level 54

iPod

- Connecting and Playing Back from an iPod 56
- Disconnecting an iPod 56
- Random Track Playback Mode (Shuffle) 58
- Track Repeat Playback Mode 59

External Components

- Playback from External Components 60
- Disconnecting the External Component 61
- Adjusting the Input Level 62





CD

This section explains how to play a CD. In addition to commercially available music CDs, you also can play discs with MP3 and WMA audio files recorded on them. For details, see <Supported Media> (page 24).

Playing a CD

Load and play the CD.

- If a disc is already loaded, simply press the [CD▶/II] key to turn the system on and begin playback.

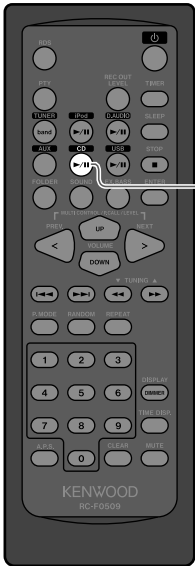

1 Open the slide door and load the CD.

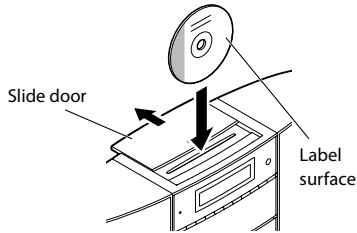

- Center the CD with the inlet slot with the label side facing towards the front of the main unit.
- After you insert the CD part way, it will be pulled automatically the rest of the way in.

2 Slide the slide door towards the front panel to close it.

- The CD will not play unless the slide door is closed.

3 Press the [CD▶/II] key.

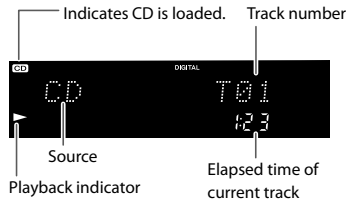

- Track numbers may not display correctly while following types of discs are playing.
 - Discs recorded in Mix mode*
 - Discs recorded in multiple sessions
 - Discs recorded in mixed formats of CD-DA format and non-music data formats
- * Mix mode combines the CD-DA format with audio files, such as MP3 and WMA.

- Supported Media → Page 24
- Audio Settings → Page 63 onwards
- Selecting Track Program Playback Mode → Page 39



- Cautions when loading a CD
 - A CD cannot be loaded while the system is in Standby mode.
 - Do not try to force a CD into the inlet slot while the system is in Standby mode. Doing so can cause malfunction.
 - If you experience problems loading a CD, pull it out and then re-insert it.
 - Do not touch the playing surface of the disc.
 - Use of an 8 cm CD adapter is not supported.
 - If you insert an 8 cm CD so it is off center relative to the inlet slot, it will not slide all the way into the slot. Take care when using an 8 cm CD.
 - If a CD is already loaded, opening the slide door will eject it.

Removing a CD

1 Press the [■] key to stop playback.

2 Slide the slide door cover towards the back panel to eject the CD.

Sliding the slide door will eject the CD.

- If the CD is playing when you slide the slide door to the back panel, playback will stop and the CD will be ejected.

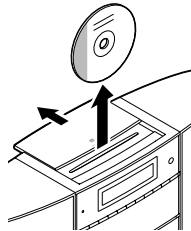

3 Slide the slide door towards the front panel to close it.



- A CD cannot be ejected while the system is in Standby mode.
- Ejecting a CD deletes all program playback settings. (Page 39)



USB

This section explains how to connect USB flash memory or a USB mass storage class compliant digital audio player to the system and play its MP3 or WMA audio files.

Playing back from a USB device

This section explains how to play MP3 or WMA audio files from USB flash memory or a USB mass storage class compliant digital audio player.

- Also refer to the instruction manual that comes with the USB device you are connecting.

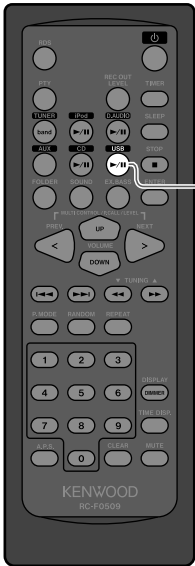

1

Connect a USB flash memory or the cable of a USB audio player to the [USB] port on the front panel of the main unit.

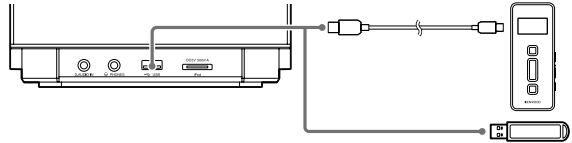

- Before connecting a USB device to the system, turn off both the system and the USB device.

2

Press the [USB▶/II] key.

The system finds the MP3 and WMA audio files on the connected device and start playback.

- See page 38 for the playback sequence when there are multiple folders or audio files on the connected device.
- Playback does not start if there are no playable MP3 or WMA audio files on the connected device.



- Depending on the connected device, the number of files, and other factors, reading of files can take some time.
- If you are using a Kenwood digital audio player, a USB connection mode selection screen may appear. Select "Storage Mode" and then press the [USB▶/II] key again.

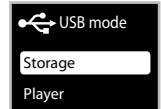

- Do not disconnect the USB device while playback is in progress. Doing so can cause malfunction.
- Never touch the USB device port with your fingers. Doing so can cause malfunction.

Related Information

- Connecting Other (Commercially Available) Devices → Page 16
- Supported Media → Page 24
- Handling USB devices → Page 26
- Audio Settings → Page 63 onwards
- Selecting Track Program Playback Mode → Page 39

Disconnecting a USB device

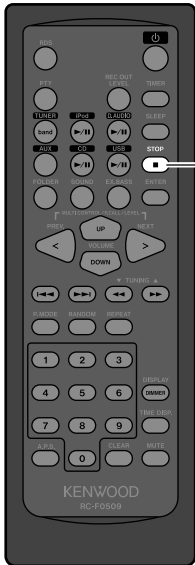

1 Press the [■] key to stop playback.

2 Press the [■] key again.

3 When the message "REMOVE OK" appears, disconnect the USB device.

REMOVE OK



- Disconnecting a USB device deletes all program playback settings. (Page 39)



CD/USB Playback Operations

This section explains how to do normal playback, in addition to folder playback, program playback, random playback and repeat playback.

Operations During Playback

■ Operations during CD playback

Pausing and resuming playback

Press the [CD ▶/II] key.

Stopping playback

Press the [■] key.

Playing the tracks in the previous/next folder (in Folder Playback mode)

To go to the previous folder, press the [PREV.] key.
To go to the next folder, press the [NEXT] key.

Skipping tracks, skipping back, skipping to the start

To skip to the previous or next track: Press the [I◀◀] key (previous) or [▶▶I] key (next).

To return to an earlier track: Press the [I◀◀] key two or more times in succession.
To return to the beginning of a track: Press the [I◀◀] key once.

Skipping forward/back

Hold down the [◀◀] key or [▶▶] key.

Specifying a track number

To play the 5th track, press the [5] key and then the [ENTER] key.

To play the 17th track, press the [1] key, press the [7] key, and then press the [ENTER] key.

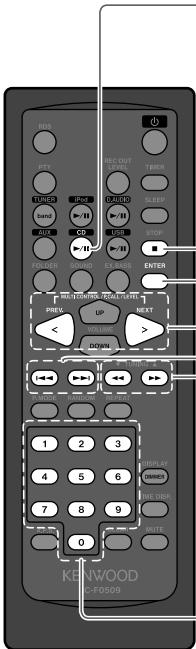

- Audio Settings → Page 63 onwards
- Selecting Folder Playback Mode → Page 37



■ Operations during USB playback

Pausing and resuming playback

Press the **[USB ▶/||]** key.

Stopping playback

Press the **[■]** key.

Playing the tracks in the previous/next folder (in Folder Playback mode)

To go to the previous folder, press the **[PREV.]** key.

To go to the next folder, press the **[NEXT]** key.

Skipping tracks, skipping back, skipping to the start

To skip to the previous or next track: Press the **[I◀◀]** key (previous) or **[▶▶I]** key (next).

To return to an earlier track: Press the **[I◀◀]** key two or more times in succession.

To return to the beginning of a track: Press the **[I◀◀]** key once.

Skipping forward/back

Hold down the **[◀◀]** key or **[▶▶]** key.

Specifying a track number

To play the 5th track, press the **[5]** key and then the **[ENTER]** key.

To play the 17th track, press the **[1]** key, press the **[7]** key, and then press the **[ENTER]** key.

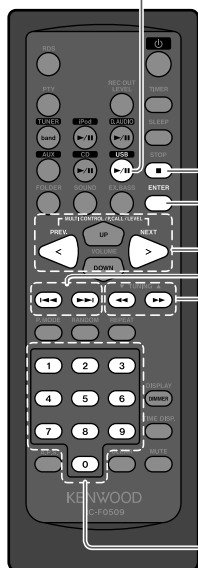

Switching Display Contents

Selecting title display and TAG information display

MP3/WMA

TAG information such as track titles, artist names and album names are recorded in audio files.

The display changes as shown below each time you press the [DISPLAY] key.

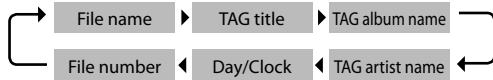

- Any display for which there is no title or TAG information available is skipped.
- Depending on the settings and specifications of the software used for encoding, TAG information may not be displayed correctly.
- Non-supported characters are displayed as pound (#) marks.
- If clock settings are not configured, the day/clock screen is skipped.

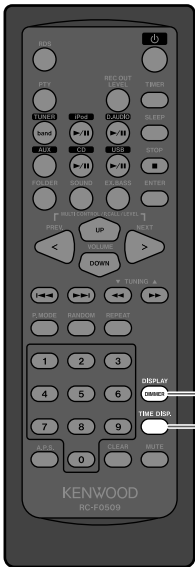

Switching time display contents

Music CD

The display changes as shown below each time you press the [TIME DISP.] key.

During CD track playback/Program playback

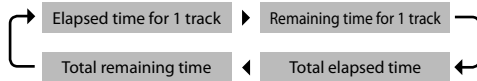

During random playback/repeat playback

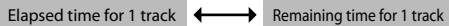

- "--:--" will appear when the time exceeds 400 minutes.

MP3/WMA

The elapsed time for only 1 track is displayed.

Related Information

- Supported Audio Files → Page 25
- Audio Settings → Page 63 onwards
- Selecting Track Program Playback Mode → Page 39
- Setting the System Clock → Page 68
- Track Random Playback Mode → Page 41
- Track Repeat Playback Mode → Page 41

Selecting Folder Playback Mode

MP3/WMA

This mode plays the files in the selected folder only.



1 Press the [■] key to stop playback.

2 Press the [FOLDER] key to select folder playback mode.

The mode changes as shown below each time you press the key.

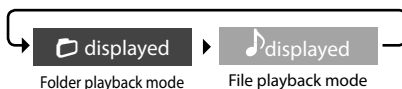

3 Press the [PREV.] or [NEXT] key to select the folder to be played.



When folder number 8 is selected.

4 Press the [CD▶/||] key or the [USB▶/||] key to begin playback.

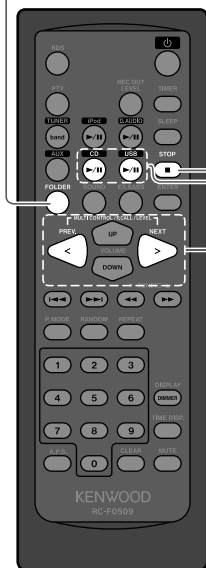

■ Playback sequence for folders and track files

MP3/WMA

When you play a CD or music from a USB device that contains recorded audio files, the track files are played sequentially beginning with the files in the ROOT folder, as shown in the figure.

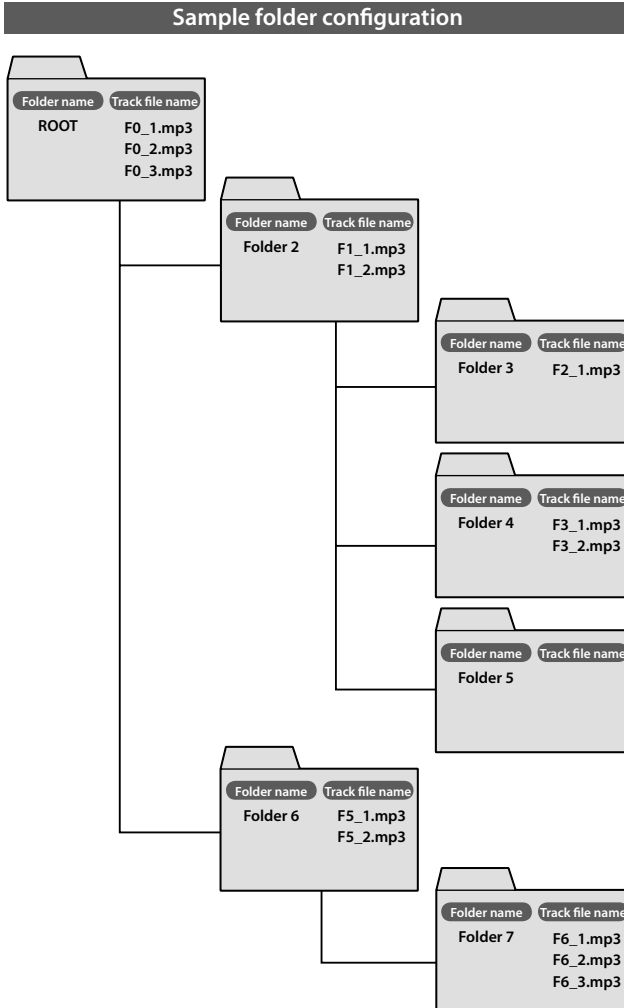

■ Track file playback sequence

Track 1.....F0_1.mp3
 Track 2.....F0_2.mp3
 Track 3.....F0_3.mp3
 Track 4.....F1_1.mp3
 Track 5.....F1_2.mp3
 Track 6.....F2_1.mp3
 Track 7.....F3_1.mp3
 Track 8.....F3_2.mp3
 Track 9.....F5_1.mp3
 Track 10.....F5_2.mp3
 Track 11.....F6_1.mp3
 Track 12.....F6_2.mp3
 Track 13.....F6_3.mp3



- A folder that does not contain any tracks cannot be selected.
- You can specify the playback sequence by adding a number from "01" to "99" at the beginning of each file name before you record the files onto the disc.

Related Information

- Supported Audio Files → Page 25
- Track Random Playback Mode → Page 41
- Track Repeat Playback Mode → Page 41
- Audio Settings → Page 63 onwards

Selecting Track Program Playback Mode

You can select the sequence for up to 32 tracks.

- If the CD is already playing, press the [■] key to stop playback.
- In folder playback mode, you can program the tracks in the currently selected folder.

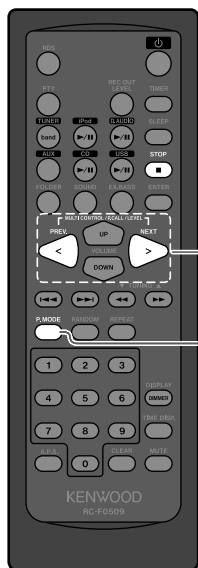

1 File playback mode

Press the [P.MODE] key to select programming mode.

The mode changes as shown below each time you press the key.

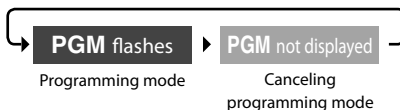

Folder playback mode (MP3/WMA)

1 Select the folder you want to use for program playback.

Select using [PREV.] or [NEXT].



Folder 8 selected

2 Press the [P.MODE] key to select program playback mode.

The mode changes as shown below each time you press the key.

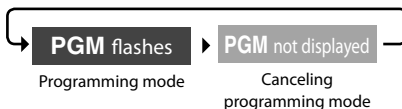

Continued to next page

2 Use the number keys or the [◀◀] and [▶▶] keys to select the track or file you want to listen to.

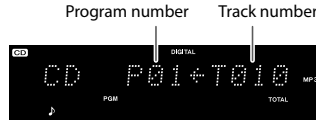

Track 10 selected as program track 1

3 Press the [ENTER] key.

- If you enter the wrong track or file in a program, press the [ENTER] key and then the [CLEAR] key. Return to step 2 and repeat the procedure.

4 If you want to select more tracks, repeat steps 2 and 3.

- You can select up to 32 tracks for playback. If you attempt to select more tracks, the message "PGM FULL" appears on the display.

5 Press the [CD▶/II] key or the [USB▶/II] key to begin playback.

"PGM" appears on the display.

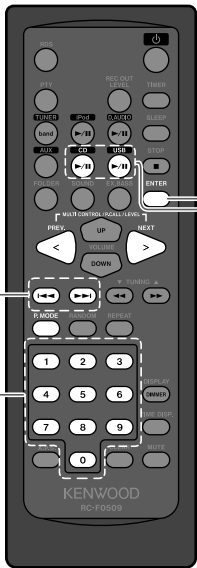

■ **To cancel program mode**

Stop playback and then press the [CLEAR] key. This erases the current program.

■ **To remove a track from a program**

- Stop playback and then press the [P.MODE] key.
- Next, each press of the [CLEAR] key will sequentially delete the last track of the program. Use the [<] and [>] keys to select a program number. When the number of the track you want to delete is displayed, press the [CLEAR] key.

■ **To add a track to the end of the program**

Stop playback if it is in progress. Next, perform steps 1 through 5 of the above procedure.

■ **Checking the contents of the program**

Stop playback and then press the [◀◀] or [▶▶] key.



- Turning off the system, ejecting the CD, or disconnecting the USB device erases the current program.

Related Information

- Selecting Folder Playback Mode → Page 37
- Selecting Track Program Playback Mode → Page 39
- Audio Settings → Page 63 onwards

Track Random Playback Mode

This mode plays the tracks in the current CD or in a folder in a random sequence.

- If "PGM" is displayed, press the [CLEAR] key while playback is stopped so it disappears from the display.

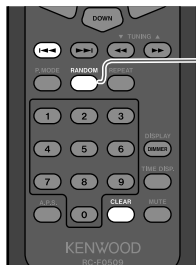

1 Press the [RANDOM] key.

The mode changes as shown below each time you press the key.



- During folder playback, this mode plays the files in the folder in random order.
- Pressing the [I◀◀] key skips back to the beginning of the track being played.

Track Repeat Playback Mode

This mode repeats a particular track or all the tracks on a CD.

1 Press the [CD▶/II] or [USB▶/II] key to start playback of a track you want to repeat.

2 Press the [REPEAT] key to begin repeat playback.

The mode changes as shown below each time you press the key.

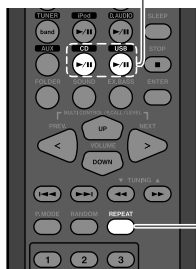

- During folder playback, this mode plays the files in the folder repeatedly.
- During program playback, this mode plays the tracks in the program repeatedly.





Receiving Radio Broadcasts

This section explains how to listen to the FM/AM radio and set radio stations.

Listening to FM/AM Radio

- Simply pressing the **[TUNER/band]** key turns on the system and allows you to listen to the radio.

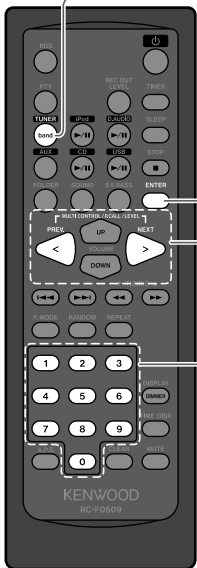

1

Select a reception mode.

Press the **[TUNER/band]** key.

The mode changes as shown below each time you press the key.

FM (Stereo)

FM (Monaural)

AM

- “ST” is displayed while a stereo broadcast is being received in FM (Stereo) reception mode.

2

Select a station.

Choosing from preset stations (Preset Call)

Select a preset station.

- You need to preset stations before you can perform these operations. (Page 44)

■ Selection with the **[P.CALL]** keys

Each press of the [**<**] or [**>**] key cycles sequentially through the preset stations.

Holding down the [**<**] or [**>**] key will scan sequentially through the preset stations at a 5-second interval.

■ Selecting a preset station with the number keys

To select station P17, press the **[1]** key, press the **[7]** key, and then press the **[ENTER]** key.

To select station P23, press the **[2]** key, press the **[3]** key, and then press the **[ENTER]** key.

Related Information

- Presetting Stations → Page 44
- Audio Settings → Page 63 onwards
- Setting the System Clock → Page 68

Choosing from stations that are not preset (Auto/Manual Tuning)

■ Using Auto Tuning

Holding down the [TUNING ◀◀/▶▶] key for more than 1 second will cause the system to jump automatically to the next receivable station. Repeat this step until you find the station you want.

■ Using Manual Tuning

Use the [TUNING ◀◀/▶▶] key to change the frequency until you find the station you want.

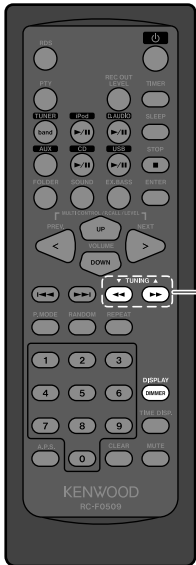

- There is no sound output while Auto Tuning is in progress.
- The display changes as shown below each time you press the [DISPLAY] key. If you want to display "Day/Clock" screen, configure time settings. (Page 68)

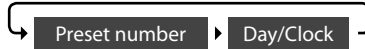

Presetting Stations

Use this procedure to make the station you are currently listening to a preset number. If the selected preset number is already assigned a station, the existing station is overwritten by the new station.

- You can preset up to 40 FM and AM stations.

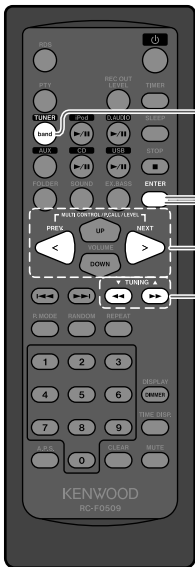

1 Select the reception mode you want to use to preset a station.

Press the [TUNER/band] key to switch the source.

- To receive FM stereo broadcasts, select "FM (Stereo)".

2 Tune in the station you want to preset, and then press the [ENTER] key.

Use Auto Tuning or Manual Tuning to tune in the desired station. (Page 43)



The preset number flashes.

- The above indicates there are no preset numbers assigned stations.

3 Select the desired preset number (P01 to P40).

Press the [<] or [>] key.



Currently selected preset number.

- If the selected preset number is already assigned a station, the existing station is overwritten by the new station.

4 Press the [ENTER] key.



Clearing All Preset Stations

This procedure deletes all of the currently preset stations.

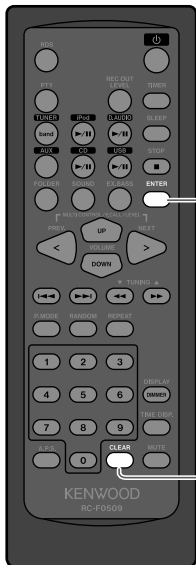

1

Hold down the [CLEAR] key for about 4 seconds.



- The message "TUNER CLEAR?" remains on the display for about 10 seconds.

2

Press the [ENTER] key.

While the "TUNER CLEAR?" message is on the display, press the [ENTER] key.





RDS (Radio Data System)

This system is designed for RDS reception, it can extract the information from the broadcast signal for use with various functions such as automatic display of the station name.

- Select the FM band. (Page 42)

PS (Program Service) Name Display

When an RDS broadcast is received, the station name is automatically displayed.



- The "RDS" lights up when an RDS broadcast (signal) is received.

To switch the displays

Press the **[RDS]** key.

- The mode changes as shown below each time you press the key.

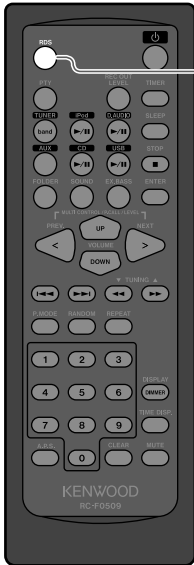
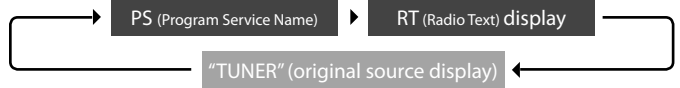

- Some stations may not be provided or be given different names depending on countries or areas.
- "NO PS" is displayed if there is no Program Service name.
- "NO RT" is displayed if there is no Radio Text.

Searching for a Desired Program Type (PTY Search)

The tuner automatically searches for a station which is currently broadcasting a specified program type (genre).

1 Press the [PTY] key.



- When an RDS broadcast is received, the program type is shown on the display. If no PTY data is available, or if the station is not an RDS station, "None" is displayed.

2 Press the [<] or [>] key to select the desired program type.

- Select it while "PTY" is lit.
- Use program type table for your convenience.

Program type table

Program Type Name	Display
Pop Music	Pop M
Rock Music	Rock M
Easy Listening Music	Easy M
Light Classical	Light M
Serious Classical	Classics
Other Music	Other M
News	News
Current Affairs	Affairs
Information	Info
Sport	Sport
Education	Educate
Drama	Drama
Culture	Culture
Science	Science
Varied	Varied

Program Type Name	Display
Weather	Weather
Finance	Finance
Children's programs	Children
Social Affairs	Social
Religion	Religion
Phone In	Phone In
Travel	Travel
Leisure	Leisure
Jazz Music	Jazz
Country Music	Country
National Music	Nation M
Oldies Music	Oldies
Folk Music	Folk M
Documentary	Document

3 Press the [PTY] key.

- No sound is heard while "PTY" is flashing.
- If a program of the desired type is found, that program is received and the program type name display changes to the station name display.

■ To cancel the PTY search

Press the [PTY] key.



- If a program of the desired type cannot be found, "NO PTY" flashes, then after several seconds the display returns to the original display.

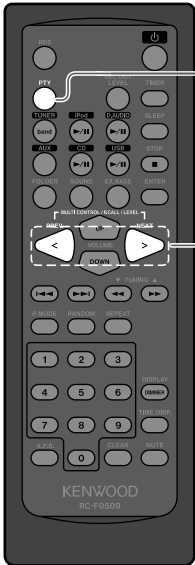



D.AUDIO

You can connect a Kenwood digital audio player (referred to hereafter simply as “digital audio player”) to the system and use it to play tracks.

Playing Back from a Digital Audio Player

Use this procedure to connect a digital audio player to the system and play tracks.

- Also refer to the instruction manual that comes with the digital audio player you are connecting.
- Connecting the digital audio player using the dedicated cable allows you to operate the digital audio player using the main unit or the remote control.

Compatible Kenwood digital audio players (As of November 2007)

Memory audio player	M2GD55, M1GD55, M1GC7, M2GC7
---------------------	------------------------------



- 1 **Connect the digital audio player to the [D.AUDIO IN] terminal on the front panel of the main unit.**

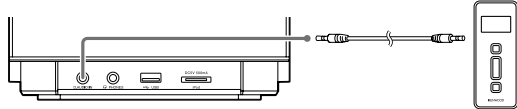

- Always turn this system and the digital audio player off before connecting the digital audio player.

- 2 **Turn on the digital audio player.**

- 3 **Play back from a digital audio player.**



Press the [D.AUDIO ► / ||] key.

- Simply pressing the [D.AUDIO ► / ||] key turns on the system and begins playback.



Press the [INPUT SEL.] key.

The source changes as shown below each time you press the key.



**Related
Information**

- Connecting Other (Commercially Available) Devices → Page 16
- Audio Settings → Page 63 onwards
- Adjusting the Input Level → Page 51

Disconnecting the Digital Audio Player

1 Turn off this system and the digital audio player.

2 Disconnect the digital audio player.

- Disconnect the digital audio player's connection cable from the [D.AUDIO IN] terminal.

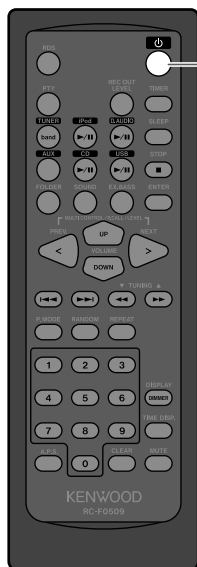

■ Operations during digital audio player playback

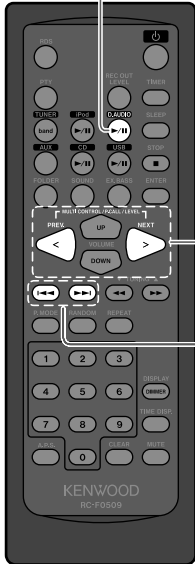

Pausing and resuming playback
Press the **[D.AUDIO ▶/II]** key.

Playing the tracks in the previous/next folder
To go to the previous folder, press the **[PREV.]** key.
To go to the next folder, press the **[NEXT]** key.

Skipping forward/back
Hold down the **[I◀◀]** or **[▶▶I]** key.

Skipping tracks, skipping back, skipping to the start
To skip to the previous or next track: Press the **[I◀◀]** key (previous) or **[▶▶I]** key (next).
To return to an earlier track: Press the **[I◀◀]** key two or more times in succession.
To return to the beginning of a track: Press the **[I◀◀]** key once.



- If you use the dedicated cable for the connection, the volume and sound quality settings on the digital audio player are disabled.
- If the digital audio player is not connected using the dedicated cable, use the controls on the connected digital audio player.
- With the following digital audio players, you cannot select a folder for playback. M2GD55, M1GD55

- Playing Back from a Digital Audio Player → Page 48
- Audio Settings → Page 63 onwards

Adjusting the Input Level

Use the following procedure to adjust the input level of a digital audio player.

Use this adjustment when the volume from an external component is noticeably higher or lower than other input sources at the same volume setting.

1 Turn off the digital audio player.

2 Press the [D.AUDIO ► / II] key to switch the source.

3 Adjust the Input Level.

Press the [<] or [>] key.

INPUT -2

- You can adjust the input level in a range from -3 to +3.

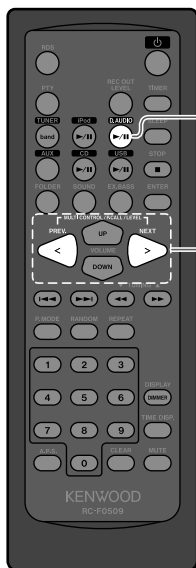

- Adjusting the input level also changes the volume of the external component connected to the [D.AUDIO IN] terminal.

Recording to a Digital Audio Player

This section explains how to record from a variety of different sources to a Kenwood digital audio player. You also can configure the digital audio player to detect silence and divide the recording into tracks automatically.

- Always turn this system and the digital audio player off before connecting the digital audio player.
- Refer to the instruction manual that comes with the digital audio player you are connecting also.
- The following assumes that the source device is already connected to the system.

Compatible Kenwood digital audio players (As of November 2007)

Memory audio player	M2GC7, M1GC7
---------------------	--------------

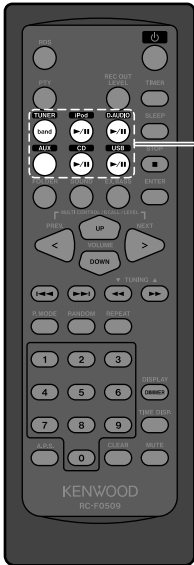

- 1 **Connect the digital audio player to the [REC OUT] terminal on the rear panel of the main unit.**

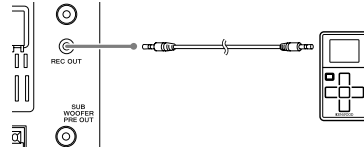

- 2 **Select the input source.**
Press the [CD▶/II], [USB▶/II], [iPod▶/II], [TUNER/band], [INPUT SEL.] (main unit only), or [D.AUDIO▶/II] (remote control only) key.

Related Information

- Connecting Other (Commercially Available) Devices → Page 16
- Adjusting the Recording Level → Page 54

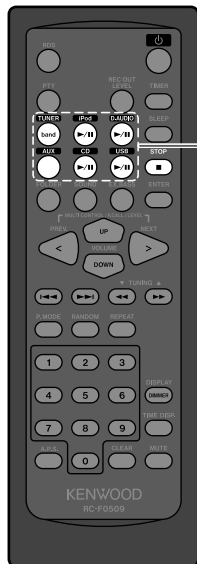

3 Prepare the source to be recorded.

■ Recording from a CD, USB, iPod

Press the [CD ▶/||], [USB ▶/||], or [iPod ▶/||] key to pause playback. Select the track you want to record or pause at the location from which you want to start recording. (Pages 30, 32, 34, 35, 56)

■ Recording from a digital audio player

Press the [D.AUDIO ▶/||] key (remote control only) to pause playback. Select the track you want to record or pause at the location from which you want to start recording. (Page 48)

■ Recording from the radio

Tune in the station you want to record. (Page 42)

4 On the digital audio player, perform the required operation to start recording.

5 Start recording.

■ CD, USB, iPod

Press the [CD ▶/||], [USB ▶/||], or [iPod ▶/||] key to start playback.

■ Digital audio player

Press the [D.AUDIO ▶/||] (remote control only) to start playback.

■ Recording from the radio

This step is not required.

■ To stop recording

Press the [■] key.

- Perform the required operation on the connected digital audio player to stop recording.

■ If you notice distortion or if the recorded sound is too low

- Adjust the recording level. (Page 54)



Adjusting the Recording Level

If you notice distortion or if the recorded sound is too low, adjust the output level.

1 Select the output level.

Press the [REC OUT LEVEL] key to toggle between the recording levels.

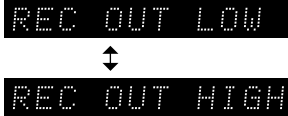

- When a Kenwood digital audio player is connected to the [REC OUT] terminal, it is recommended that you select the optimal recording level for each device.

M2GC7, M1GC7 connected This system: HIGH
 M2GC7 } Mid
 M1GC7 }

- When the source is a digital audio player, disconnect the digital audio player from the [REC OUT] terminal before adjusting the recording level.

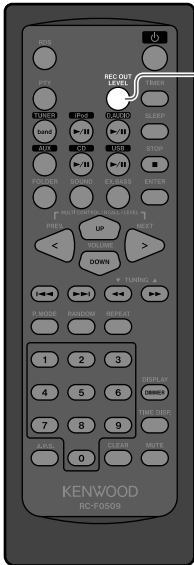



iPod

This section explains how to connect and play back from an iPod.

Connecting and Playing Back from an iPod

Use this procedure to connect an iPod to the system for playback.

- Also refer to the instruction manual that comes with the iPod you are connecting.
- Use the PNC-iP120 connecting cable (optional accessory) to connect an iPod.
- For information about supported iPod models, see to page 27.

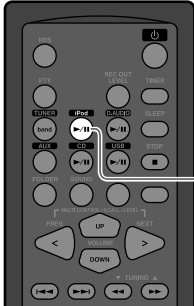

- 1 Connect the PNC-iP120 connection cable (optional accessory) to connect the iPod to the [iPod] terminal on the main unit's front panel.**

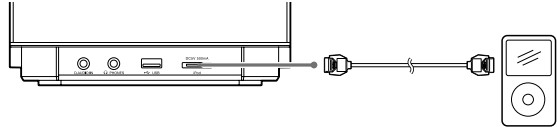

- Always turn this system and the iPod off before connecting the iPod.

- 2 Press the [iPod ▶/||] key to begin playback.**

- Perform main operations on the iPod.

Disconnecting an iPod

- 1 Turn off this system and the iPod.**

- 2 Disconnect the iPod.**

- After you are finished using the iPod, disconnect its connection cable from the [iPod] terminal.



Related Information

- Connecting Other (Commercially Available) Devices → Page 16
- Supported iPod Models → Page 27
- Audio Settings → Page 63 onwards

■ Operations during iPod playback

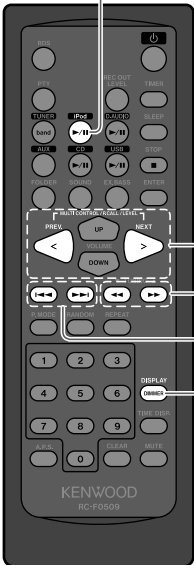

Pausing and resuming playback
Press the [**iPod ▶/||**] key.

Playing the tracks in the previous/next album
To go to the previous album, press the [**PREV.**] key.
To go to the next album, press the [**NEXT**] key.

Skipping forward/back
Hold down the [**◀◀**] key or [**▶▶**] key.

Skipping forwards, backwards, and to the beginning
To skip to the previous or next track: Press the [**◀◀**] key (previous) or [**▶▶**] key (next).
To return to an earlier track: Press the [**◀◀**] key two or more times in succession.
To return to the beginning of a track: Press the [**◀◀**] key once.

Turning on the backlight
Press the [**DISPLAY**] key.
Turns on the iPod backlight for approximately 30 seconds.



- The volume level and sound quality settings of the iPod are ignored while it is connected to the system.
- Do not disconnect the iPod while playback is in progress. Doing so can cause a malfunction.
- Certain functions may not be supported depending on the iPod model.

Random Track Playback Mode (Shuffle)

This mode plays the tracks on an iPod in random sequence.

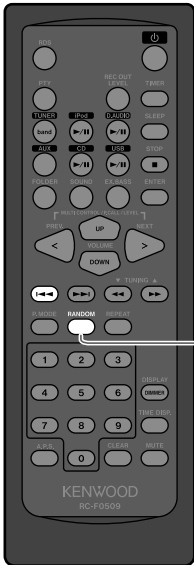

1

Press the [RANDOM] key.

The mode changes as shown below each time you press the key.

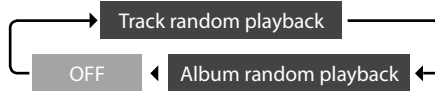

- Check the iPod display to see the currently selected shuffle mode.



- This mode is not supported with the iPod classic (6th generation) and iPod nano (3rd generation).
- Pressing the [I◀◀] key skips back to the beginning of the track being played.

Track Repeat Playback Mode

This mode repeatedly plays the tracks on an iPod.

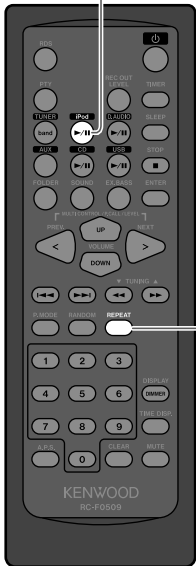

1 Press the [iPod ▶ / ||] key to play a track you want to repeat.

2 Press the [REPEAT] key to begin repeat playback.

The mode changes as shown below each time you press the key.

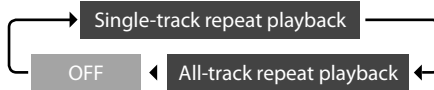

- Check the iPod display to see the currently selected repeat mode.



- This mode is not supported with the iPod classic (6th generation) and iPod nano (3rd generation).
- During album playback, this mode repeatedly plays the album.
- During random playback, after all the tracks are played back randomly, they are repeated in a different random sequence.

When both random playback and album playback are being used, the tracks in the albums are repeatedly played in a different random sequence each time.





External Components

This section explains how to connect external components to the system and play back tracks.

Playback from External Components

Connect the external component to the system as described in <Connecting Other (Commercially Available) Devices> (page 17).

- When connecting external components, always turn this system and the external components off beforehand.
- Also refer to the instruction manual that comes with the external component being connected.

1 Connect the external component to the [AUX IN] terminal on the back panel of the main unit.

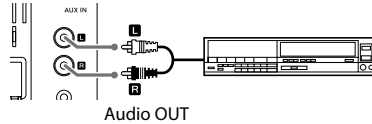

2 Select AUX as the source.



Press the [AUX] key.



Press the [INPUT SEL.] key.

The source changes as shown below each time you press the key.



3 Begin playback on the connected external component.

Perform the required operation on the connected external component to start playback.



**Related
Information**

- Connecting Other (Commercially Available) Devices → Page 17
- Audio Settings → Page 63 onwards
- Adjusting the Input Level → Page 62

Disconnecting the External Component

1 Turn off this system and the external component.

2 Disconnect the external component.

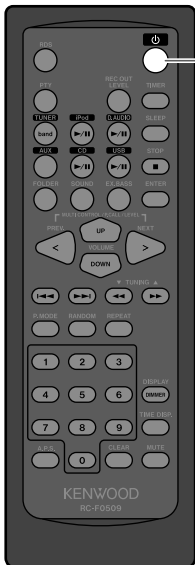

Adjusting the Input Level

Use the procedure below to adjust the input level for the external component connected to the [AUX IN] terminal.

Use this adjustment when the volume from an external component is noticeably higher or lower than other input sources at the same volume setting.

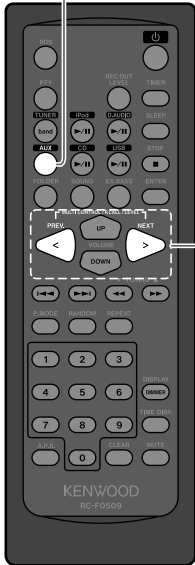

1 Select AUX as the source.



Press the [AUX] key.



Press the [INPUT SEL.] key.

The source changes as shown below each time you press the key.



2 Adjust the input level.

Press the [<] or [>] key.



- You can adjust the input level in a range from -3 to +3.



- Adjusting the input level also changes the volume of the external component connected to the [AUX IN] terminal.

Audio Settings

Use the procedures in this chapter to specify the sound quality settings for your stereo system.

The EX.BASS setting can be adjusted for enhanced bass, and the SOUND setting can be adjusted to bring out the optimal sound quality of each track.

EX.BASS

- Enhancing the Bass Range 64

SOUND

- Adjusting the High Range and Low Range..... 65



EX.BASS

The EX.BASS setting can be used to enhance the bass range.

Enhancing the Bass Range

1

Press the [EX.BASS] key.

The setting changes as shown below each time you press the [EX.BASS] key.

EX. BASS ON

"EX.BASS" appears.



EX. BASS OFF

"EX.BASS" disappears.

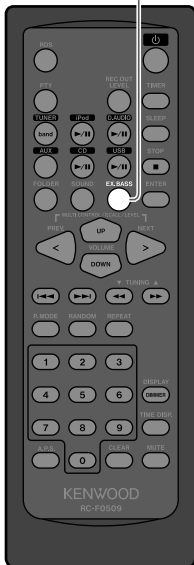

- Turning on EX.BASS disables the SOUND function automatically.

SOUND

Use this setting to adjust the low and right ranges and achieve the type of sound you want.

Adjusting the High Range and Low Range

1 Press the [SOUND] key to select the range level.

The range being adjusted changes as shown below each time you press the [SOUND] key.

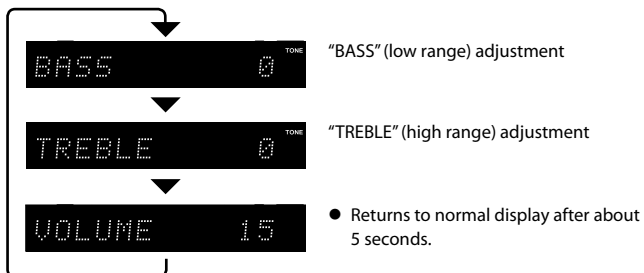

2 Adjust the level.

Use the [UP] and [DOWN] keys.



- "BASS," "TREBLE" both can be adjusted within a range of -3 to +3.
- "TONE" appears on the display when the "BASS" or "TREBLE" setting is something other than 0.



- Changing the SOUND setting disables EX.BASS automatically.

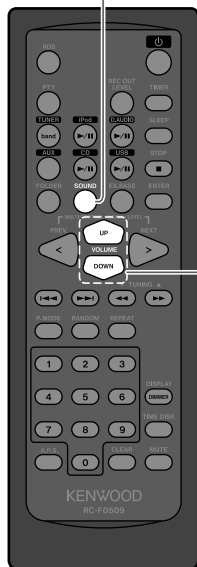

Component Settings

This chapter explains basic timekeeping settings, as well as settings for the timer, display, and other functions that help make the system easier to use.

Setting the System Clock68

Setting the Timer

- Setting the Sleep Timer (SLEEP) 69
- Setting the Program Timer (PROGRAM) 70

Display Settings

- Setting the Display Brightness (DIMMER) 74

Auto Power Save75



Setting the System Clock

Set the system clock to the correct time. If the system clock time setting is not correct, the Program Timer will not start playback at the correct time.

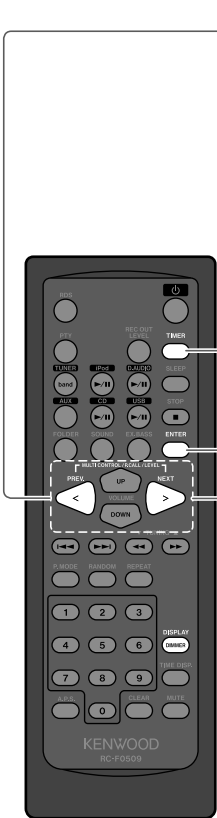

1 Press the [TIMER] key.

Press the [<] or [>] key.

TIME ADJUST ▶ Press the [ENTER] key.

- The current time will appear if clock settings are already configured.

Press the [ENTER] key and advance to step 2.

2 Set the day of the week.

Use the [<] and [>] keys to set the day of the week.

SUNDAY AM 12:00 ▶ Press the [ENTER] key.

3 Select the timekeeping format.

Press the [<] or [>] key.

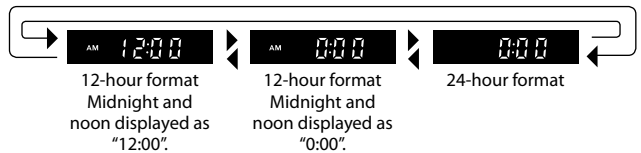

Press the [ENTER] key.

4 Set the time.

Use the [<] and [>] keys to set the hour.

SUNDAY AM 12:00 ▶ Press the [ENTER] key.

Use the [<] and [>] keys to set the minutes.

SUNDAY AM 12:00 ▶ Press the [ENTER] key.

- The currently set day of the week and time are displayed.



- If you make a mistake, repeat the procedure from the beginning.
- If there is a power failure or if the system is unplugged from the wall outlet for some time, you must reset the system clock time.
- Pressing the [DISPLAY] key while the system is in the Standby mode (OFF) will display the time for 5 seconds.

Setting the Timer

A Sleep Timer automatically turns the system off after a set interval, while a Program Timer starts playback at a specified time.

Setting the Sleep Timer (SLEEP)

The timer turns the system off automatically after a preset interval. You can set an interval from 10 to 90 minutes, in 10-minute increments.

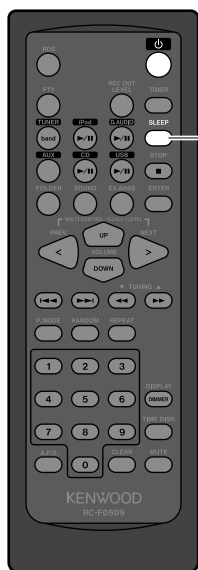

1

Press the [SLEEP] key.

The interval increases by 10 minutes each time you press the key. The next setting after 90 minutes is timer off.

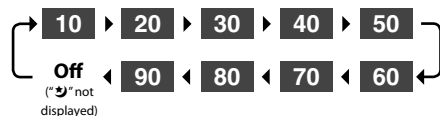

- The display goes dark and illumination turns off while the Sleep Timer is on.
- While the Sleep Timer is running, you can check the remaining time by pressing the [SLEEP] key.

■ To cancel the Sleep Timer

Press the power [⏻] key to turn the system off (Standby) or press the [SLEEP] key so "not" is no longer displayed.



Setting the Program Timer (PROGRAM)

This function allows you to use the timer to start playback automatically at a specified time. You can set two timers (PROG. 1 and PROG. 2) at the same time.

- Set the system clock to the correct time before performing this procedure. (Page 68)
- If you want the radio to play when the programmed time is reached, preset the station before performing this procedure. (Page 44)
- Make sure the times for PROG. 1 and PROG. 2 are different by at least one minute to ensure that their operations do not overlap.

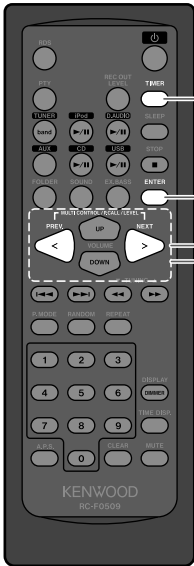

1 Press the [TIMER] key.

Press the [<] or [>] key.



Press the [ENTER] key.

2 Select "PROG. 1" or "PROG. 2".

Press the [<] or [>] key.



Press the [ENTER] key.

3 Select "ON" or "OFF".

Press the [<] or [>] key.



Example: PROGRAM 1 off



Example: PROGRAM 1 on

Press the [ENTER] key.

- Selecting "OFF" ends the operation and returns to the original display.

- Presetting Stations → Page 44
- Setting the System Clock → Page 68

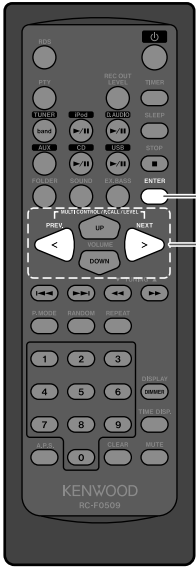

4 Select the day (or days) on which the Program Timer will run.

Press the [**<**] or [**>**] key.

The mode setting cycles as shown below each time you press a key.



Press the [**ENTER**] key.

- If you selected "EVERYDAY", "MON-FRI", "TUE-SAT" or "SAT-SUN", proceed to step 6.

5 Select "EVERY WEEK" or "ONETIME".

Press the [**<**] or [**>**] key.



- The timer runs every week.



- The specified timer runs once only.

Press the [**ENTER**] key.

6 Specify the "ON TIME" (start time).

Use the [**<**] and [**>**] keys to set the hour.



- ▶ Press the [**ENTER**] key.

Use the [**<**] and [**>**] keys to set the minutes.



- ▶ Press the [**ENTER**] key.

Continued to next page

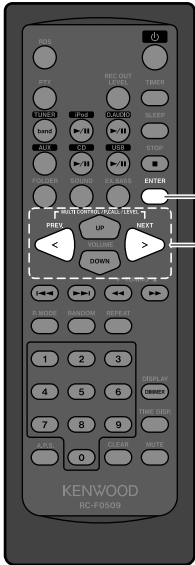

7 Specify the "OFF TIME" (off time).

Use the [<] and [>] keys to set the hour.



Press the **[ENTER]** key.

Use the [<] and [>] keys to set the minutes.



Press the **[ENTER]** key.

8 Select "PLAY" or "AI PLAY".

Press the [<] or [>] key.



- Playback is at the volume you set in step 9.



- This setting causes the volume to increase gradually up to the volume level you set in step 9.

Press the **[ENTER]** key.

9 Set the volume.

Press the [<] or [>] key.



Press the **[ENTER]** key.

- You cannot use the **[VOLUME]** key to set the volume.

10 Select the input source.

Press the [<] or [>] key.

The mode setting cycles as shown below each time you press a key.



Press the **[ENTER]** key.

- If you selected an input source other than "TUNER"; this completes the setting procedure. The message "COMPLETE" will appear on the display briefly, followed by the normal display.
- If you selected "TUNER"; use the [<] and [>] keys to select a preset number, and then press the **[ENTER]** key. This completes the setting procedure. "COMPLETE" will appear on the display briefly, followed by the normal display.



11 Press the power [⏻] key to turn the power OFF.

- The [STANDBY/TIMER] indicator on the main unit lights in orange.

■ **To exit the setting procedure part way through**

Press the [TIMER] key.

■ **To turn a timer off or on**

When the system is turned on, hold down the [TIMER] key for about 2 seconds.

The setting changes each time you hold down the [TIMER] key for about 2 seconds.

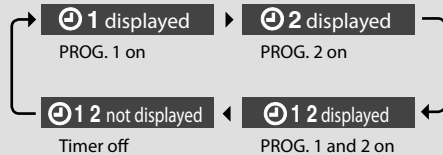

- Even when a timer is off, its settings are retrained.
- The [STANDBY/TIMER] indicator will light in red if there was a power failure or the system was unplugged from the wall outlet for some time. If this happens, set the system clock to the correct time again. (Page 68)



- To modify the program settings, reconfigure the timer settings from the beginning.



Display Settings

Use this procedure to adjust the brightness of the display.

Setting the Display Brightness (DIMMER)

The brightness of the display can be adjusted to one of 2 levels. Adjust the brightness according to your preferences and the conditions in the room.

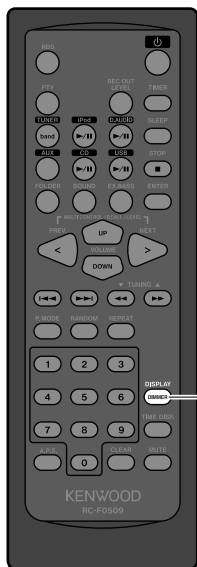

1

Hold down the [DIMMER] key for about 2 seconds.

The setting changes as shown below each time you press the key.

Display: Dark
Illumination: On

Display: Dark
Illumination: Off

Display: Bright
Illumination: On

Auto Power Save

Auto Power Save (A.P.S.) is automatically turns the system off if no operation is performed for 30 minutes after a CD or a USB connected device stops playing.

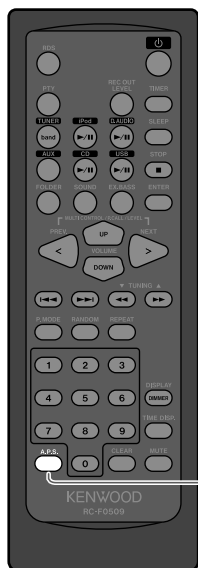

1

Hold down the [A.P.S.] key for about 2 seconds.

The setting toggles on and off each time you hold down the key.



"A.P.S." appears.



"A.P.S." disappears.



- If the input source is "TUNER", "D.AUDIO", "iPod", or "AUX", A.P.S. is triggered whenever the volume is set to zero (VOLUME 0) or when MUTE is on.
- When recording to a device connected to the system's [REC OUT] terminal, turn off A.P.S. or set the volume so that it is higher than zero.



Maintenance

This chapter explains what to do when error messages appear on the display or when problems arise. It also describes how to store and maintain the system so it continues to provide enjoyment for many years to come.

Messages	78
Troubleshooting	79
Glossary	82
Care and Storage	83
Specifications	84



Messages

Displayed Message	Meaning
Can't READ * (* is a number or symbol.)	<ul style="list-style-type: none"> ● CD disc information cannot be read correctly. → The disc is dirty. Clean the disc. (See <Care and Storage>.) (Page 83) → Insert the disc correctly in the center of the inlet slot. (Page 30) ● The CD is loaded the other way around. → Load the CD correctly. (Page 30)
CD NO DISC	<ul style="list-style-type: none"> ● There is no CD loaded. The CD cannot be recognized. → Load a CD. (Page 30)
Er-CD01	<ul style="list-style-type: none"> ● The CD unit is not operating correctly. → Request servicing.
NOT SUPPORT	<ul style="list-style-type: none"> ● You are trying to play back data from a copyright protected WMA audio file or from an unsupported file format. ● There are no playable MP3 or WMA audio files.
REMOVE OK	<ul style="list-style-type: none"> ● The USB device can be removed safely. → Disconnect the USB device from the [ USB] port. (Page 33)
USB NO MEDIA	<ul style="list-style-type: none"> ● A USB device is not connected. The USB device cannot be recognized. → Check the connections. (Page 16)
** READING (** is the media name.)	<ul style="list-style-type: none"> ● The media's TOC^{*1} information is being read.

*1: In addition to audio signals, information called the Table of Contents (TOC) is recorded on each CD. The TOC is similar to the contents page of a book and information such as the text, playing times and number of tracks including some items that cannot be rewritten.

Troubleshooting

Whenever the system is not operating as expected, check the following tables to see if you can resolve the problem yourself before requesting service.

Amplifier/Speakers

Symptoms	Solution	Ref. page
No sound output.	<ul style="list-style-type: none">● Check all connections as described in <Connecting the System>.● Increase the volume.● Cancel the MUTE setting.● Unplug any headphones plugged into the main unit.	12 - 17 22 22 17
No sound from the headphones.	<ul style="list-style-type: none">● Check that the headphone plug is inserted correctly.● Increase the volume.● Cancel the MUTE setting.	17 22 22
No sound from one of the speakers.	<ul style="list-style-type: none">● Check all connections as described in <Connecting the System>.	12, 15
No time display	<ul style="list-style-type: none">● Set the clock as described in <Setting the System Clock>.	68
The timer does not work.	<ul style="list-style-type: none">● Set a start time and end time for the program timer.	70 - 73

Tuner

Symptoms	Solution	Ref. page
No radio reception.	<ul style="list-style-type: none">● Connect the antennas.● Select the correct band (reception mode).● Tune the radio to the frequency of the desired station.● Move the main unit, antenna, and AC adapter away from each other.	12 42 43 12, 13
Interference (noise)	<ul style="list-style-type: none">● Install an outdoor antenna away from roads.● Turn off any electrical appliances that may be causing interference.● Move the system away from the TV.● Move the main unit, antenna, and AC adapter away from each other.	— — — 12, 13

USB

Symptoms	Solution	Ref. page
No sound output when USB flash memory or a USB audio player is connected.	<ul style="list-style-type: none">● Plug in the USB flash memory correctly.● Connect the USB cable correctly.● Check to make sure the USB audio player is turned on.	16 16 32



CD

Symptoms	Solution	Ref. page
A CD does not play back when loaded.	<ul style="list-style-type: none"> ● Load the disc correctly with the label side facing towards the front of the main unit. ● Clean the disc. (See <Care and Storage>.) ● Allow any condensation to evaporate. (See <Be careful against condensation>.) ● Close the slide door. 	<p>30</p> <p>83</p> <p>83</p> <p>30</p>
No sound output.	<ul style="list-style-type: none"> ● Press the [CD▶/III] key. ● Clean the disc. (See <Care and Storage>.) 	<p>30</p> <p>83</p>
Playback skips.	<ul style="list-style-type: none"> ● Clean the disc. (See <Care and Storage>.) 	83
Some audio files can't be played back.	<ul style="list-style-type: none"> ● The system will not play audio files that are corrupted. ● Make sure the audio file is supported for playback on the system. 	<p>—</p> <p>25</p>
Delay before playback starts.	<ul style="list-style-type: none"> ● A large number of folders or files can cause delay prior to playback. 	25
TAG information is not displayed correctly.	<ul style="list-style-type: none"> ● Refer to <Supported Audio Files> to check which TAG information can be displayed on this system. 	25
CD does not eject.	<ul style="list-style-type: none"> ● Slide the slide door towards the back of the main unit to stop playback and eject the disc. If this does not cause the CD to eject, perform the following procedure to eject it. <ol style="list-style-type: none"> ① Check that the source is CD. (If music is playing, press the [■] key to stop playback.) ② Slide the slide door towards the back of the main unit to open it. ③ Hold down the main unit's [■] key for more than two seconds. Press and hold the [■] key until the CD comes all the way out of the main unit. If this does not eject the CD, request servicing. 	—

Components connected to the [D.AUDIO IN] terminal

Symptoms	Solution	Ref. page
The main unit and remote control cannot control a Kenwood digital audio player.	<ul style="list-style-type: none"> ● Use a dedicated cable for connection. ● Check whether the connected model is compatible. 	<p>16</p> <p>48</p>

Device connected to the [iPod] terminal

Symptoms	Solution	Ref. page
iPod is not recognized.	<ul style="list-style-type: none"> ● Connect with a PNC-iP120 iPod connection cable (optional accessory). ● Connect the PNC-iP120 iPod connection cable securely. ● Check that the iPod model is compatible for playback by the system. 	<p>17</p> <p>17</p> <p>27</p>
Cannot control the iPod.	<ul style="list-style-type: none"> ● Disconnect the iPod from the system, disconnect all devices from the iPod, and then re-connect it to the system. ● Check that the iPod model is compatible for playback by the system. 	<p>17</p> <p>27</p>
Poor response.	<ul style="list-style-type: none"> ● iPod response becomes poor when there is a large number of tracks on the iPod. This is particularly true when shuffle is turned on for a large number of tracks, which can cause poor response of the iPod itself. 	<p>27</p>

Remote control

Symptoms	Solution	Ref. page
The remote control does not work.	<ul style="list-style-type: none"> ● Load new batteries. ● Use the remote control within its effective range. 	<p>21</p> <p>21</p>

Resetting the microcomputer

Symptoms	Solution
Microcomputer malfunction (the system does not work, the display is faulty, etc.).	<p>Reset Procedure (Main unit only)</p> <ol style="list-style-type: none"> 1 Turn off the power (press the [⏻] key to enter Standby mode). 2 While holding down the [▶▶] and [STOP■] keys on the main unit, hold down the main unit's power [⏻] key until the message "CLEAR ALL" appears on the display. <p>CLEAR ALL</p> <ul style="list-style-type: none"> ● Remember that resetting erases any stored information and restores the system's default settings.



Glossary

Term	Meaning	Page
CD-DA	Refers to music CDs. Almost all discs normally referred to as "CDs" are actually CD-DA discs.	24
MP3	An audio compression method developed by Germany's Fraunhofer IIS, which achieves high rates of data compression by discarding data not readily audible to humans. MP3 can compress data down to rates of approximately 1/11 (128 kbps) while retaining sound quality equivalent to a music CD.	25
USB hub	An adapter that provides simultaneous connection of multiple USB devices.	26
USB mass storage class	A standard for computer control of a USB device. It also makes it possible for a computer to recognize a connected USB device as an external storage device.	16, 24
VBR (Variable Bitrate)	A system that varies the amount of data per time segment in accordance with the music data volume.	25
WMA	An abbreviation for the "Windows Media™ Audio" audio compression and encoding system developed by Microsoft Corporation of the U.S.	25
Sampling frequency	A value that indicates the number of times per second analog signals are sampled for conversion to digital signals. The sampling frequency for music CDs is 44.1 kHz. Normally, the higher the sampling frequency, the better the sound quality.	25
Bitrate	A value indicating the amount of information processed per second. The higher the bitrate, the better the sound quality.	25

Care and Storage

Care and storage of main unit

■ Keep the system out of the following locations

- Areas exposed to direct sunlight.
- Areas subjected to excessive humidity or dust.
- Areas exposed to direct heat from heating equipment.

■ Be careful against condensation

Extreme differences between system temperature and air temperature can cause water droplets (condensation) to form on the system. The system will not operate properly while condensation is present. If condensation forms, do not use the system for a few hours to allow the condensation to dry.

Take special care against condensation when the system is moved between two locations of very different temperatures, or into a room where high humidity is present.

■ When the main unit becomes dirty

When the front panel or case gets dirty, wipe it with a soft dry cloth. Never use lacquer thinner, benzine, alcohol or contact revitalizer, which will cause discoloration or deformation.

Care and storage of CDs

■ Storing a CD

If you do not plan to use a CD for a long time, remove it from the main unit and store it in its case.

■ Cleaning a CD

- When a disc becomes soiled with fingerprints or other stains, use a soft, dry cloth to wipe it gently in a pattern radiating from the center of the disc.
- Do not use a phonograph record cleaner, lacquer thinner, benzine or alcohol to clean CDs.
- Do not use any disc accessory (stabilizer, protective sheet, protective ring, etc.) or lens cleaner.

■ Other cautions

- Do not write on a CD with a pencil or ballpoint pen.
- Do not use a CD if its sticker or label is peeling or if any adhesive is coming out from under the sticker or label.
- Do not affix paper, stickers or labels to CDs.

Care and storage of connected components

Be sure to read the instruction manual that comes with each component.



Specifications

Main Unit (RD-C707)

■ Amplifier

Effective output power during STEREO operation	10 W + 10 W RMS (1 kHz, 10 % T.H.D., 6Ω)
EX.BASS	+4 dB (70 Hz, Vol. 20)
Input terminals (Sensitivity/Impedance)	
LINE (D. AUDIO/AUX)	600 mV / 47 kΩ (At input level 0)
Output terminals (Level/Impedance)	
REC OUT (D. AUDIO)	2.2 V / 10 kΩ (HIGH) 1 V / 10 kΩ (LOW)
SUB WOOFER PREOUT	2.2 V / 10 kΩ

■ Tuner

FM tuner	
Reception frequency range	87.5 MHz to 108.0 MHz
Antenna impedance	75 Ω unbalanced
AM tuner	
Reception frequency range	531 kHz to 1,602 kHz

■ USB

Usable USB device	USB Mass storage class
Interface	USB 2.0 (Full speed) USB 1.1 compatible
File system	FAT 16/32
Playback formats	
MP3 sampling frequency	8 kHz to 48 kHz
Bitrate (CBR/VBR *)	32 kbps to 320 kbps
WMA (WMA9 standard, non-DRM) sampling frequency	
	32 kHz to 48 kHz
Bitrate (CBR/VBR *)	64 kbps to 192 kbps
ID3 tag	Version 1.0 / 1.1 / 2.2 / 2.3
Max. folders	255
Max. folder nesting	8 levels
Max. files	65280 (FAT 32)
Supply current	Max. 500 mA

* VBR audio data may produce bitrates outside the above range, which may make playback impossible.

■ iPod

Max. supply power	DC 5 V / 500 mA
-------------------	-----------------

■ CD player

Scanning method	Semiconductor laser
D/A Conversion	24 bit
Oversampling	8 fs (352.8 kHz)
Frequency characteristics	20 Hz to 20 kHz
MP3/ WMA Max. folders	512
Max. folder nesting	8 levels
MP3/ WMA Max. files	512

■ Power Supply, etc.

Supplied AC adapter	
Australia	12 V DC (240 V AC, 50 Hz)
Europe	12 V DC (230 V AC, 50 Hz)
Power consumption	12 W
Standby power consumption	Less than 0.5 W
Dimensions	Width: 210 mm (8-1/4") Height: 228 mm (9") Depth: 187 mm (7-3/8")
Weight (net)	2.2 kg (4.9 lb)

Speakers (LS-C707)

System	Full-range speaker system (Magnetically shielded)
Enclosure	Bass-reflex
Loudspeaker	80 mm (3-1/8") Cone type
Nominal impedance	6 Ω
Nominal input power	10 W
Max input power	20 W
Dimensions	Width: 149 mm (5-7/8") Height: 191 mm (7-1/2") Depth: 128 mm (5-1/16")
Weight (net)	1.2 kg (2.7 lb) (each)

- Design and specifications are subject to change without notice.
- Full performance is not guaranteed in extremely cold environments (under water-freezing temperatures).

KENWOOD

For your records

Record the serial number, found on the back of the unit, in the spaces designated on the warranty card, and in the space provided below. Refer to the model and serial numbers whenever you call upon your dealer for information or service on this product.

Model _____
Serial Number _____

Free Manuals Download Website

<http://myh66.com>

<http://usermanuals.us>

<http://www.somanuals.com>

<http://www.4manuals.cc>

<http://www.manual-lib.com>

<http://www.404manual.com>

<http://www.luxmanual.com>

<http://aubethermostatmanual.com>

Golf course search by state

<http://golfingnear.com>

Email search by domain

<http://emailbydomain.com>

Auto manuals search

<http://auto.somanuals.com>

TV manuals search

<http://tv.somanuals.com>