

KENWOOD

STEREO CASSETTE DECK

CT/KXF-W SERIES

CT-203 KXF-W4010

CT-2050 KXF-W6010

INSTRUCTION MANUAL

KENWOOD CORPORATION

This manual contains instructions for four models. Model availability and features (functions) may differ depending on country and sales area.

B60-3706-00 (HZ) (K, P, T, M, X, Y) ID
99/3 2 1 98/12 11 10 9 8 7 6 5 4 3

2 Before applying power

 **Caution : Read this section carefully to ensure safe operation.**

Units are designed for operation as follows.





U.S.A. and Canada AC 120 V only
Australia AC 240 V only

Europe and U.K. AC 230 V only
*Other countries AC 110-120 / 220-240 V switchable

Safety precautions

 **Caution : Read this section carefully to ensure safe operation.**

WARNING : TO PREVENT FIRE OR ELECTRIC SHOCK, DO NOT EXPOSE THIS APPLIANCE TO RAIN OR MOISTURE.

	CAUTION RISK OF ELECTRIC SHOCK DO NOT OPEN		CAUTION: TO REDUCE THE RISK OF ELECTRIC SHOCK, DO NOT REMOVE COVER (OR BACK). NO USER-SERVICEABLE PARTS INSIDE. REFER SERVICING TO QUALIFIED SERVICE PERSONNEL.
	THE LIGHTNING FLASH WITH ARROWHEAD SYMBOL, WITHIN AN EQUILATERAL TRIANGLE, IS INTENDED TO ALERT THE USER TO THE PRESENCE OF UNINSULATED "DANGEROUS VOLTAGE" WITHIN THE PRODUCT'S ENCLOSURE THAT MAY BE OF SUFFICIENT MAGNITUDE TO CONSTITUTE A RISK OF ELECTRIC SHOCK TO PERSONS.		
	THE EXCLAMATION POINT WITHIN AN EQUILATERAL TRIANGLE IS INTENDED TO ALERT THE USER TO THE PRESENCE OF IMPORTANT OPERATING AND MAINTENANCE (SERVICING) INSTRUCTIONS IN THE LITERATURE ACCOMPANYING THE APPLIANCE.		

Special features

Dolby HX pro and Auto-Bias function

- The Dolby HX pro headroom extension and auto-bias function provide a recording with superior high-frequency characteristics.

DPSS function

- Simple operations allow you to use the following convenient functions.
 - ① Skip Play
 - ② Rewind & Play
 - ③ Single-tune repeated playback
 - ④ Dash & Play (DPSS: Direct program Search System)

CCRS function

- This function automatically sets the optimum recording level of the disc to be recorded, making it easy to record a CD. (CCRS: Computer-Controlled CD Recording System)

Dubbing function

- With an easy operation, the tape loaded in deck A can be dubbed onto the tape in deck B, making it easy to record a CD.

Unpacking

Unpack the unit carefully and make sure that all accessories are put aside so they will not be lost.

Examine the unit for any possibility of shipping damage. If your unit is damaged or fails to operate, notify your dealer immediately. If your unit was shipped to you directly, notify the shipping company without delay. Only the consignee (the person or company receiving the unit) can file a claim against the carrier for shipping damage.

We recommend that you retain the original carton and packing materials for use should you transport or ship the unit in the future.

Keep this manual handy for future reference.

Accessories

Check that the following accessories are present.

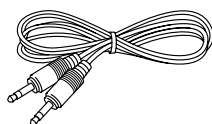
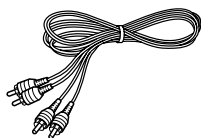

Audio cord (2)

System control cord (1)



Contents

Caution: Read the pages marked  carefully to ensure safe operation.

Introduction	2	Normal recording	16
 Before applying power	2	Relay recording (CT-2050/KXF-W6010 only)	19
 Safety precautions	2	Relay recording	19
Special features	3	Tape dubbing operation (Deck A → Deck B)	20
Important items	4	Tape dubbing	20
Maintenance	4	Convenient CD recording (CT-203/KXF-W4010; Deck B only)	21
Reference	4	CD synchro recording	21
System connections	6	Recording of CD playback (CCRS)(Deck B only)	22
Controls and indicators	8	Timer operations	23
Preparation for playback (recording)	10	Timer playback of tape	23
Playback (recording) preparation	10	Timer recording of tuner broadcast(CT-203/KXF-W4010; Deck B only)	24
Listening to cassette tapes	11	In case of difficulty	25
Normal playback	11	Glossary	27
Relay playback	12	Specifications	28
Convenient music search (DPSS)	14		
Skip play operation	14		
Rewind & Play operation	15		
Single-tune repeated playback operation	15		
Dash & Play operation	15		
How to record (CT-203/KXF-W4010; Deck B only) ..	16		

Maintenance

Cleaning

Unplug this appliance from the wall outlet before cleaning. Do not use volatile solvents such as alcohol, paint thinner, gasoline, or benzene, etc. to clean the cabinet. Use a clean dry cloth.

Caution against contact revitalizer

Do not use contact cleaners because it could cause a malfunction. Be specially careful against contact cleaners containing oil, for they may deform the plastic components.

Cleaning the head section

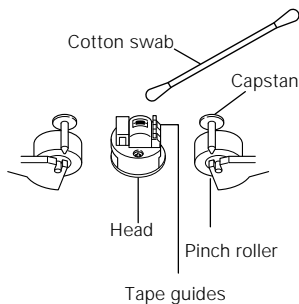

Cleaning the heads and peripheral components

For maintaining the best condition of the deck and for longer service life, always keep the head (recording/playback/erase), capstan and pinch roller clean. To clean them, perform the following:

1. Open the cassette holder.
2. Using a cotton swab dipped in alcohol, clean the head (recording/playback/erase), capstan and pinch roller carefully.

Demagnetizing the head

When the recording/playback head is magnetized, the sound quality will be deteriorated. In such a case, demagnetize the head using a commercially available demagnetizer (head eraser).



There are precisely aligned parts around the heads, including the tape guides. When cleaning, pay special attention so as not to apply shock to them.

Reference

Caution on condensation

Condensation (of dew) may occur inside the unit when there is a great difference in temperature between this unit and the outside. This unit may not function properly if condensation occurs. In this case, leave the unit for a few hours with the power left ON, and restart the operation after the condensation has dried up.

Be specially cautions against condensation in a following circumstance:

When this unit is carried from a place to another across a large difference in temperature, when the humidity in the room where this unit is installed increases, etc.

Dolby noise reduction and HX Pro headroom extension manufactured under license from Dolby Laboratories Licensing Corporation. HX Pro originated by Bang & Olufsen. "DOLBY", the double-D symbol and "HX PRO" are trademarks of Dolby Laboratories Licensing Corporation.

WARNING NOTICE:

IN MOST CASES IT IS AN INFRINGEMENT OF COPYRIGHT TO MAKE COPIES OF TAPES OR DISCS WITHOUT THE PERMISSION OF THE COPYRIGHT OWNERS. ANYONE WISHING TO COPY COMMERCIALY AVAILABLE TAPES OR DISCS SHOULD CONTACT THE MECHANICAL COPYRIGHT PROTECTION SOCIETY LIMITED OR THE PERFORMING RIGHTS SOCIETY LIMITED.

Handling the cassette tape

Notes on cassette tape

Safety tab (accidental erasure prevention tab)

After an important recording has been finished, break the safety tab, to prevent the recorded contents from being erased or recorded on accidentally.

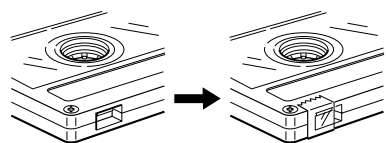
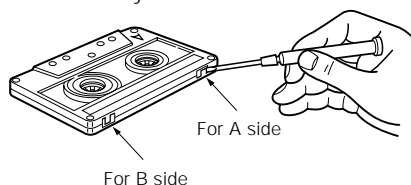

To re-record

Apply tape only to the position where the tab has been removed.

To store cassette tapes

Do not store the tapes in a place which is subject to direct sunlight, or near equipment that generates heat. Keep the cassette tapes away from any magnetic field.

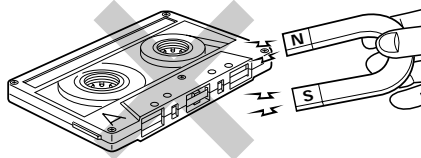

When there is slack in the tape

In such a case, insert a pencil into the reel hole and wind the reel hub to remove the slack.

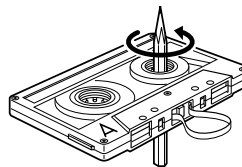

1. Longer tape than 110 minutes cassette tape

Since longer tape than 110 minutes cassette tape is very thin, the tape could adhere to the pinch roller or be easily cut. It is recommended that these tapes not be used with this unit to prevent possible damage.



2. Endless tapes

Do not use an endless tape, as this could damage the mechanism of the unit.

System connections

CT-2050/203/KXF-W6010/W4010 (En/M)

6

Make connections as shown below. When connecting the related system components, refer also to the instruction manuals of the related components.

Caution: Do not plug in the power lead until all connections are completed.

Malfunction of microcomputer



If operation is not possible or erroneous display appears even though all connections have been made properly, reset the microcomputer referring to "In case of difficulty". → 25

Except for U.S.A., Canada

Caution regarding placement

To maintain proper ventilation, be sure to leave a space around the unit (from the largest outer dimensions including projections) equal to, or greater than, shown below.

Left and right panels: 10 cm, rear panel: 10 cm

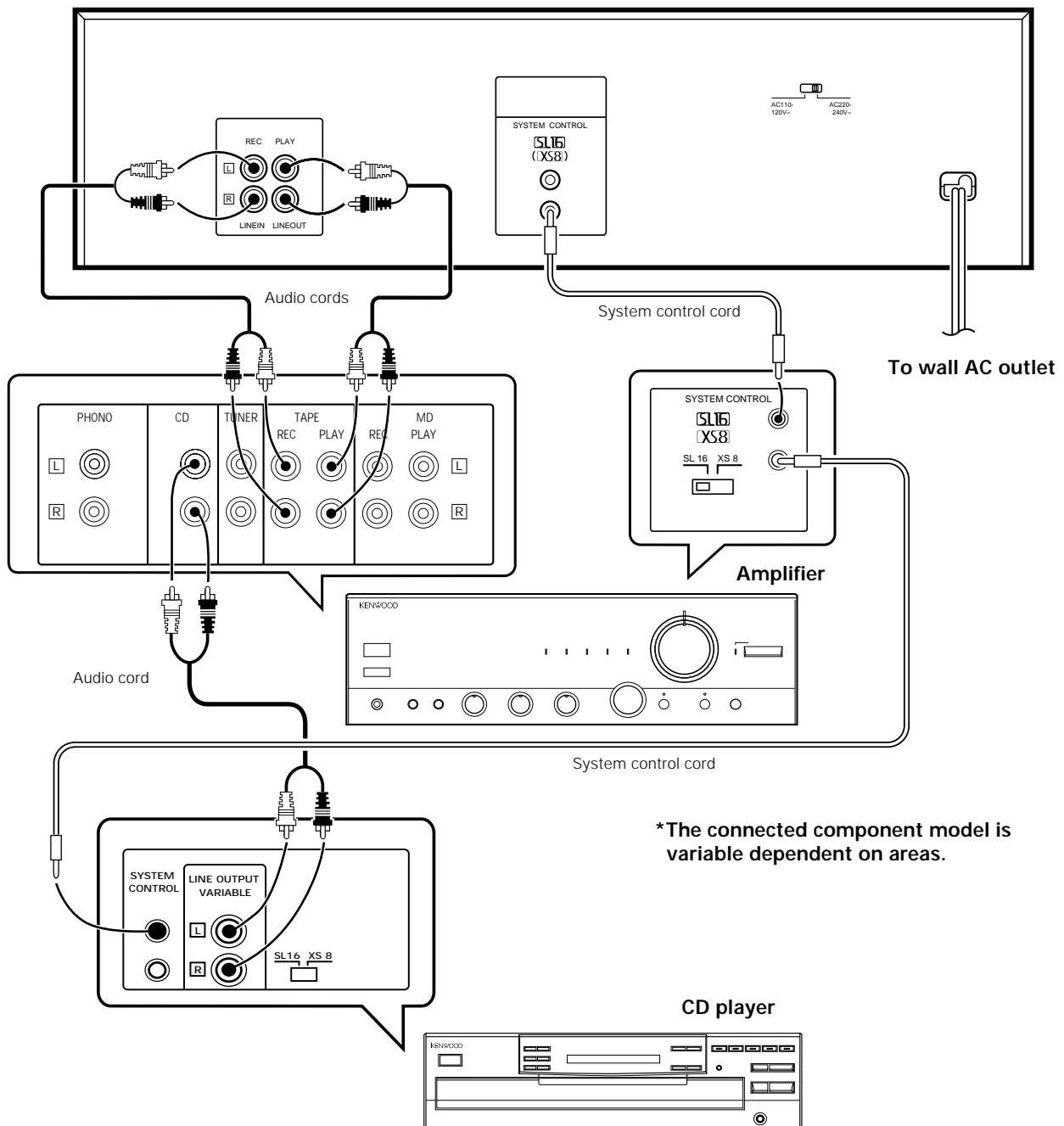

1. Connect all cords firmly. If connections are loose, there could be loss of sound or noise produced.
2. When plugging and unplugging connection cords, be sure to first remove the power cord from the AC outlet. Plugging/unplugging connection cords without removal of the power cord can cause malfunctions or damage to the unit.

ABOUT THE SYSTEM CONTROL CONNECTIONS

Connecting system control cords after connecting a KENWOOD audio component system lets you take advantage of convenient system control operations.

There are two KENWOOD system control modes. Make connections according to the groups of terminal symbols shown below.

[XS8] Mode : lets you combine [XR], [XS] and [XS8] terminals

[SL16] Mode : for [SL16] terminals only

This unit is compatible with both [XS8] and [SL16] modes. It comes from the factory set to the [SL16] mode. To switch to the [XS8] mode, follow the instructions in "SWITCHING FROM [SL16] TO [XS8]" below.



1. [SL16] equipment cannot be combined with [XR], [XS], and [XS8] equipment for system operations. If your equipment consists of this kind of combination, please do not connect any system control cords. Even without system control cords, normal operations can be carried out without affecting performance.
2. If your amplifier or receiver does not have a system control terminal, do not connect any system control cords to the system control terminals on the other components.
3. Do not connect system control cords to any components other than those specified by KENWOOD. It may cause a malfunction and damage your equipment.
4. Be sure the system control plugs are inserted all the way in to the system control terminals.

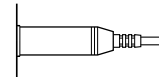

ABOUT THE SYSTEM CONTROL OPERATIONS

Remote Control

Lets you operate this unit with the system remote supplied with the amplifier or receiver.

Automatic Operation (except [XR] equipment)

Automatically switches the input selector on the amplifier or receiver when you start playback from this unit.

Synchronized Recording (except [XR] equipment)

Lets you synchronize recording with the start of playback when recording from CD, MD, LD, or analog discs. Also, the simple CCRS operation lets you make great recordings from CD.

SWITCHING FROM [SL16] TO [XS8]

You can easily change the system control mode with the following operation. Do this operation after completing all connections.

Switching to [XS8]: Hold down the ◀◀ (rewind) key on Deck B and switch the POWER key from OFF to ON. →

Switching back to [SL16]: Hold down the ▶▶ (fast forward) key on Deck B and switch the POWER key from OFF to ON. →

- This operation will not affect items stored in the memory.

Controls and indicators

CT-2050/203/KXF-W6010/W4010 (En/M)

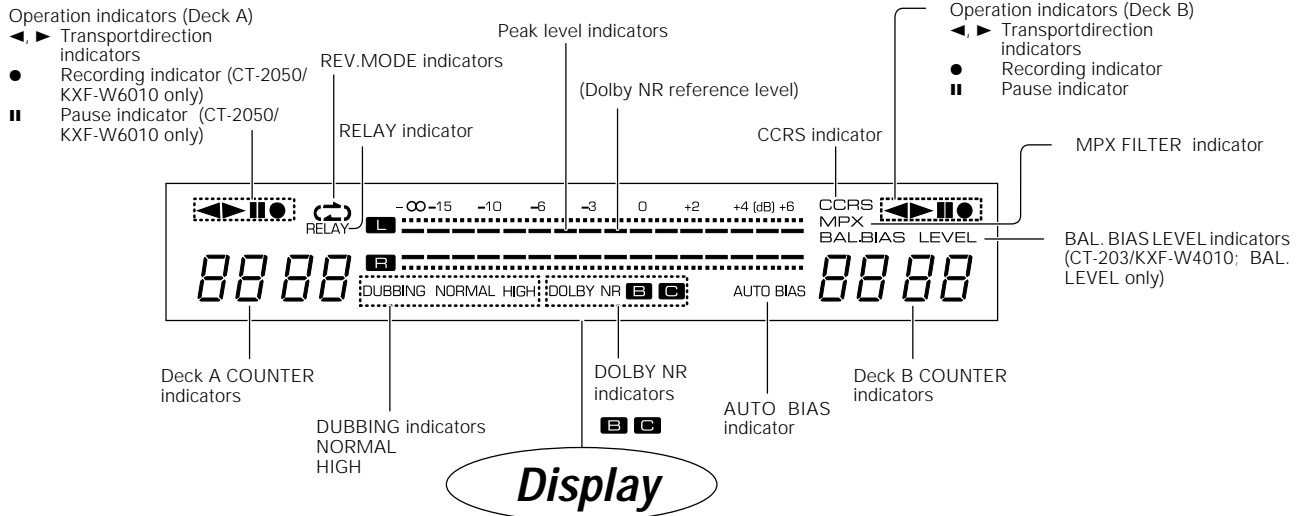

CT-2050/KXF-W6010

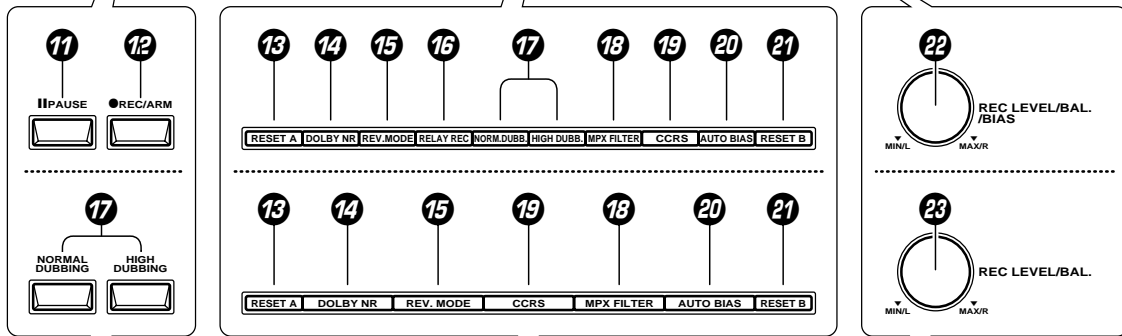
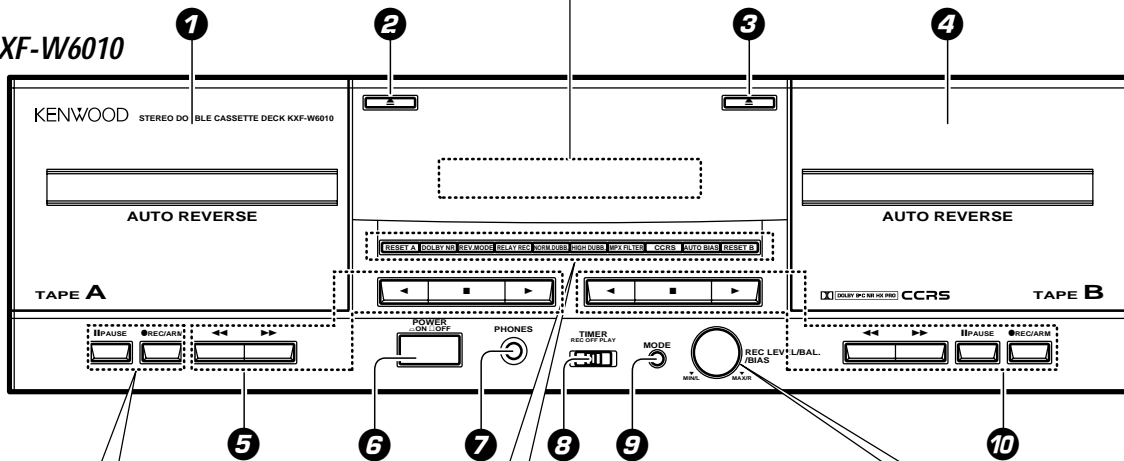

CT-203/KXF-W4010

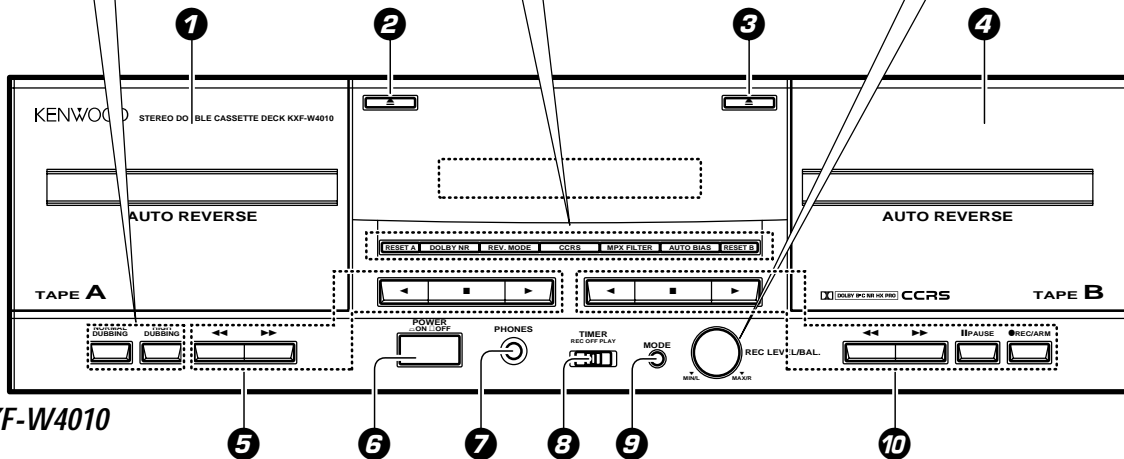

- 1 Deck A**
This deck is used exclusively for playback. (CT-203/KXF-W4010 only)
This deck is capable of both playback and recording. (CT-2050/KXF-W6010 only)
- 2 Deck A eject (▲) key** → 10
Press to open the cassette holder of deck A.
- 3 Deck B eject (▲) key** → 10
Press to open the cassette holder of deck B.
- 4 Deck B**
This deck is capable of both playback and recording.
- 5 Deck A operation keys** → 10 ~ → 11
◀◀ : Rewind key (for fast winding of tape toward the left reel seen from you)
▶▶ : Fast Forward key (for fast winding of tape toward the right reel seen from you)
◀, ▶ : Play keys
■ : Stop key (Stop)
- 6 POWER switch** → 10
Press to turn this unit **ON** and **OFF**.
- 7 PHONES jack** → 11
Connect stereo headphones (optional) here.
- 8 TIMER switch** → 23
This switch is used in setting of timer playback and timer recording.
- 9 MODE key** → 16
Press to change the recording level, balance, or bias settings.
- 10 Deck B operation keys** → 10 ~ → 11
◀, ▶ : Play keys
■ : Stop key (Stop)
◀◀ : Rewind key (for fast winding of tape toward the left reel seen from you)
▶▶ : Fast Forward key (for fast winding of tape toward the right reel seen from you)
PAUSE (||) key → 11
: Press to let tape transport pause temporarily.
REC/ARM (●) key → 16
: Press in stop mode to start recording or press in record mode to let the recording pause after leaving a non-recorded blank of 4 seconds.
- 11 Deck A PAUSE (||) key (CT-2050/KXF-W6010 only)** → 11
Press to let tape transport pause temporarily.
- 12 Deck A REC/ARM (●) key (CT-2050/KXF-W6010 only)** → 16
Press in stop mode to start recording or press in record mode to let the recording pause after leaving a non-recorded blank of 4 seconds.
- 13 RESET A key** → 11
Press to reset the tape counter of deck A to "0000".
- 14 DOLBY NR key** → 10
Press to switch the Dolby Noise Reduction mode to **B** → **C** → **OFF**. This makes it possible to use the Dolby NR effect in recording and playback.
- 15 REV. MODE key** → 10
Press to change the tape transport direction.
- 16 RELAY REC key (CT-2050/KXF-W6010 only)** → 19
Press to perform continuous recording from deck A to deck B.
- 17 DUBB. keys (NORM./HIGH) (CT-2050/KXF-W6010 only)** → 20
DUBBING keys (NORMAL/HIGH) (CT-203/KXF-W4010 only) → 20
Press to start tape dubbing.
NORM./NORMAL : Dubbing at the normal speed.
HIGH : Dubbing at a high speed.
- 18 MPX FILTER key** → 17
Press to reduce beat noise when recording FM broadcasts.
- 19 CCRS key** → 22
Press to start recording after automatic setting of the optimum CD recording level and optimum tape recording bias.
- 20 AUTO BIAS key** → 16
When this key is pressed, the bias level appropriate for the tape is set automatically for recording.
- 21 RESET B key**
Press to reset the tape counter of deck B to "0000".
- 22 REC LEVEL/BAL./BIAS knob (CT-2050/KXF-W6010 only)** → 16
Adjust this before recording.
- 23 REC LEVEL/BAL. knob (CT-203/KXF-W4010 only)** → 16
Adjust this before recording.

Preparation for playback (recording)

CT-2050/203/KXF-W6010/W4010 (En/M)

10

Before playback (recording)

① Set the **TIMER** switch to OFF.



② Set the **POWER** switch to ON.

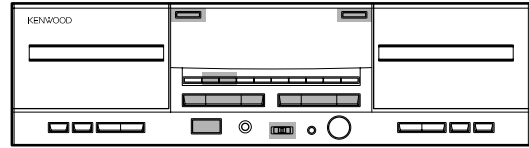

: Keys and control used in the operations described on this page.

Playback (recording) preparation

1 Load a cassette tape in deck A or B.

① Press the eject () key.



② Insert a tape and close the cassette holder.

Deck A:
Playback only. (CT-203/
KXF-W4010 only)
Playback/recording available. (CT-2050/KXF-W6010 only)

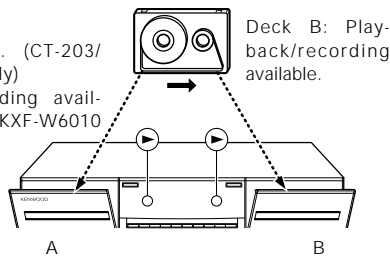

Deck B: Playback/recording available.

- Be sure to remove tape slack before insertion.
- The type of tape, that is, the Normal, High position or Metal position (playback only) is selected automatically.
- This unit cannot record sound on a Metal tape.
- Be sure to close the cassette holder securely by pushing it.

Normal position	TYPE I
High position	TYPE II
Metal position (playback only)	TYPE IV

2 Select the tape transport direction.

① Press the play (or) key.



To play (record) tape side B. To play (record) tape side A.

Feed the tape section which cannot be played or recorded onto in the forward direction.

② Press the stop () key.



Tape transport direction indicators

The and indicators show the direction the tape is transported during recording or playback. The direction used when the tape is last stopped is held in memory even after this unit has been turned OFF, and the tape transport starts in the indicated direction when the unit is started automatically by a timer, etc. To change the tape transport direction, press the play key for the opposite direction and immediately press the stop () key.

Deck A direction indicators.

Deck B direction indicators.

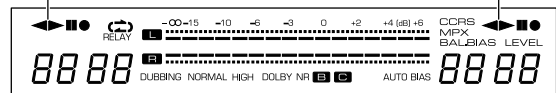

3 Determine the playback (recording) condition.

① Select the playback (recording) mode.



② Select the Dolby NR mode.



Each press switches the indication.

- ① : Double-side playback (recording) which stops tape stops after having played (or recorded) both sides.
- ② : Playback is endless, but recording stops after having recorded both sides.
- ③ : One-way playback (recording) which stops tape after having played (or recorded) a single side.

Each press switches the indication.

- ① DOLBY NR "OFF" (extinguished): Dolby NR is not used.
- ② DOLBY NR "B": Noise reduction of the ordinary type.
- ③ DOLBY NR "C": Noise reduction with higher performance.

- Select the Dolby NR mode according to the tape recording status.

Listening to cassette tapes

CT-2050/203/KXF-W6010/W4010 (En/M)

Preparation

Make "Playback (recording) preparation".



To use the headphones

Connect commercially-available stereo headphones to the PHONES jack for private listening.

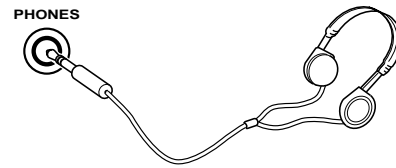

Normal playback

Start playback

Press the play (◀ or ▶) key.

To play side B. To play side A.



- Tapes are played in the directions indicated by their respective indicators on the display.

Fast forwarding or rewinding tape

① Stop playback.



② Press the ◀◀ key or ▶▶ key.

- ◀◀: Fast tape winding in the ← direction.
- ▶▶: Fast tape winding in the → direction.



- Press the stop (■) key to stop fast tape winding.

To pause playback (CT-203/KXF-W4010; Deck B only)

CT-2050/KXF-W6010

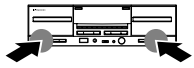

CT-203/KXF-W4010

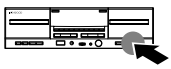

|| PAUSE



- The || indicator lights.

To stop playback



- Do not press the eject (▲) button until the tape has stopped completely.

Usage of counter

Before starting recording (playback), press the **RESET A** or **RESET B** key to reset the counter to "0000", and write down the counter reading when the recording (playback) should be stopped in the middle of the tape, etc.; this will make it easy to locate the same position when you want to continue recording (playback) next time. It is also possible to use the Zero-stop function to return to the position where recording (playback) was started.



Deck A counter.

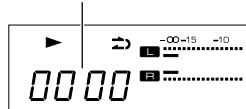

Display example.

Zero-stop operation

Fast winding in the → direction

Press simultaneously.



Fast winding in the ← direction

Press simultaneously.



- Tape is wound until counter reading near "0000" where it stops.

This function plays back the tapes in both decks A and B continuously and repeatedly.

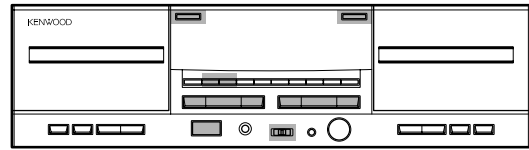

 : Keys and control used in the operations described on this page.

Relay playback

1 Load cassette tapes in both decks.

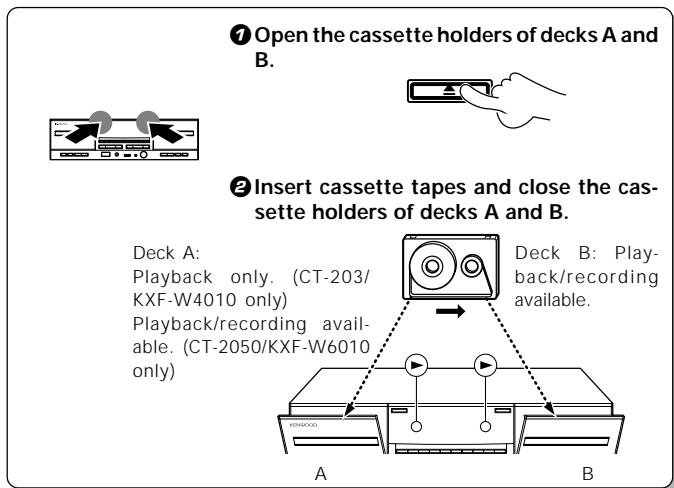

- Be sure to remove tape slack before insertion.
- Be sure to close the cassette holder securely by pushing it.

2 Determine the playback condition.

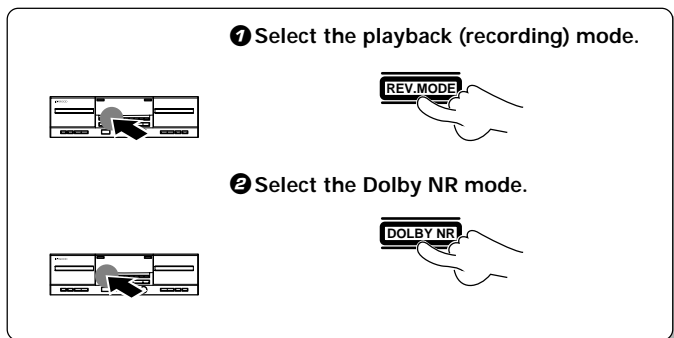

Each press switches the indication.

- ① "↔" : Relay playback of two sides of tapes in decks A and B is repeated.
- ② "↔" : Relay playback is not available with this setting.
- ③ "↔" : Relay playback of only one side of tapes in decks A and B is repeated.

Each press switches the indication.

- ① DOLBY NR "OFF" (extinguished): Dolby NR is not used.
- ② DOLBY NR "B": Noise reduction of the ordinary type.
- ③ DOLBY NR "C": Noise reduction with higher performance.

- Select the Dolby NR mode according to the tape recording status.

3 Start playback.

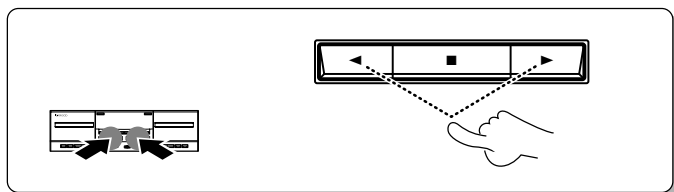

- Tapes are played in the directions indicated by their respective indicators on the display.
- The playback starts with the deck the play key of which is pressed.

To Stop relay playback



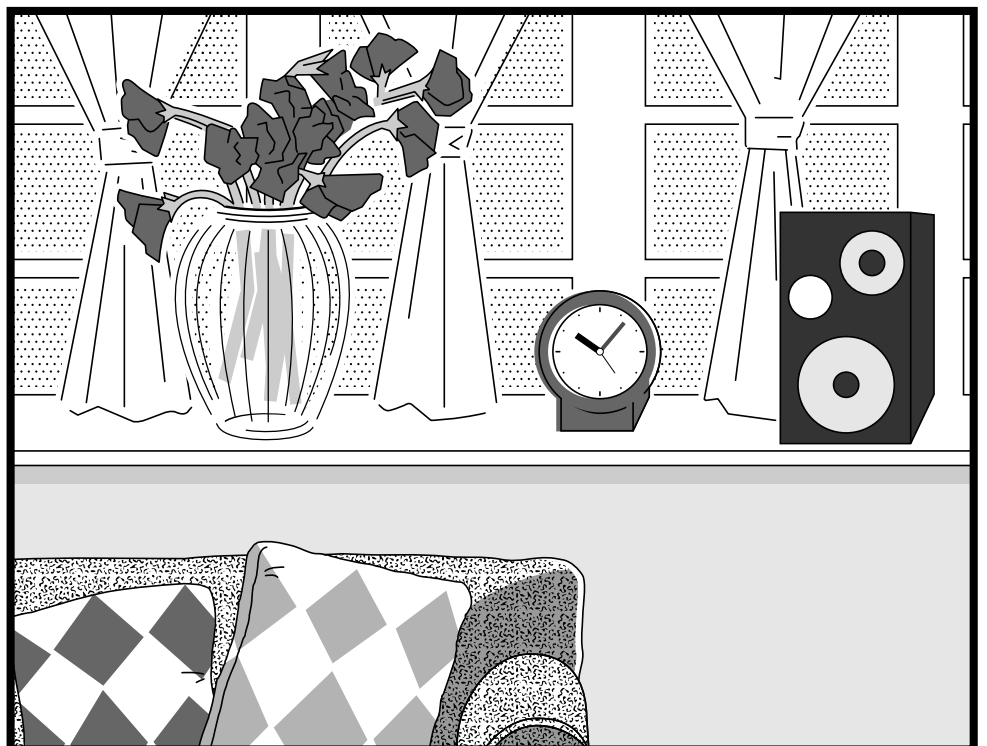

Convenient music search (DPSS)

CT-2050/203/KXF-W6010/W4010 (En/M)

14

The DPSS (Direct Program Search System) enables the following convenient operations according to the instructions of the operation keys (these operation are however not available on both decks simultaneously). The DPSS functions are based on the detection of non-recorded spaces of 4 seconds or more between tunes.

- 1. Skip play** : By specifying a tune located several tunes beyond (or behind) the tune being played, skips tunes between the current tune and the selected tune and starts playback from the beginning of the selected tune. Up to 16 tunes can be skipped in Skip Search.
- 2. Rewind & Play** : Rewinds the tape to the beginning and starts playback from there.
- 3. Single-tune repeated playback** : One single tune is played back repeatedly up to 16 times.
- 4. Dash & Play** : If a non-recorded space of more than 10 seconds is detected during playback, that space will be skipped by fast forward tape winding.

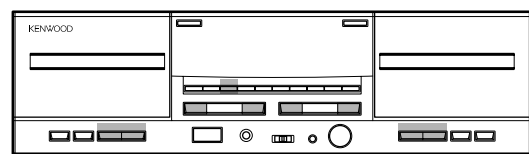
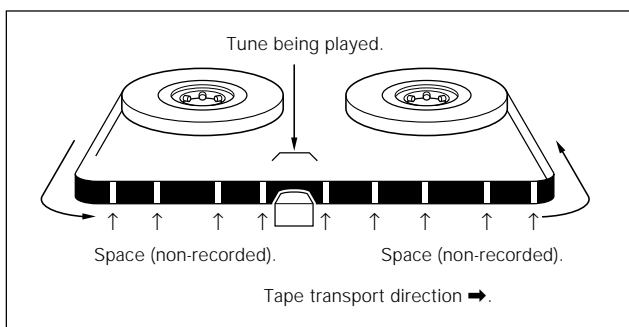

 : Keys and control used in the operations described on this page.

Skip play operation

The example below shows the case in which the direction indicated by the tape transport direction indicator is ►. If the direction indicated by the tape direction indicator is ◀, always press the keys for the opposite directions to those shown in the illustrations below.

To play a tune located immediately after the tune being played



Press once during the playback.

To play the tune being played from the beginning



Press once during the playback.

To play a tune located 4 tunes beyond



Press 4 times during the playback.

To play the tune located 4 tunes behind



Press 5 times during the playback.

DPSS will not function properly with the following types of tapes.

- Tapes containing spaces of 4 seconds or more, such as conversations and speeches.
- Tape containing extremely low levels or non-recorded spaces in the middle of tunes, such as classical music.
- Tapes containing recording of large noise between tunes.
- Tapes containing spaces of less than 4 seconds between tunes.
- Tapes recorded with low recording level.
- Tapes recorded using Cross-fade recording.



Rewind & Play operation

This operation cannot be performed with the remote control (of the separately sold amplifier).

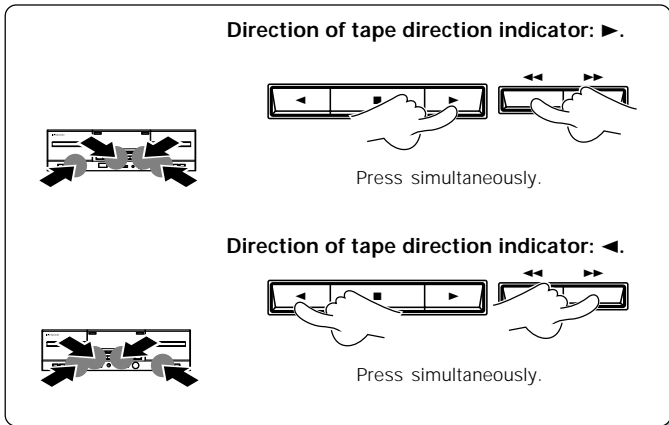

- Tape returns to the beginning of the tape side being played and playback restarts from there.
- Press the stop (■) key to stop playback and cancel this operation.

Single-tune repeated playback operation

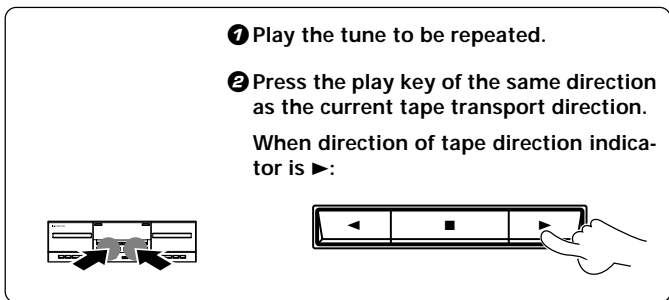

- Normal playback resumes after repeating the same tune for 16 times.
- Press the stop (■) key to stop playback and cancel this operation.

Dash & Play operation

The Dash & Play skips long non-recorded spaces automatically as the tape is played.

This operation cannot be performed with the remote control (of the separately sold amplifier).

1 Determine the playback mode (conditions).

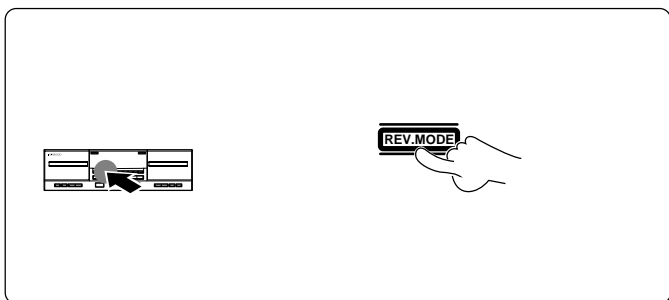

Each press switches the indication.

- ① "↔": Two sides are played only once, after which playback stops.
- ② "↻": Two sides are repeated 8 times, after which playback stops.
- ③ "↷": One side is repeated 8 times, after which playback stops.

- In case the REV.MODE key is set to "↷" and tapes are inserted in both of the decks, when a deck finishes Dash & Play, the other deck starts Dash & Play for 16 times, after which it stops.

2 Press the ◀◀ and ▶▶ keys simultaneously.

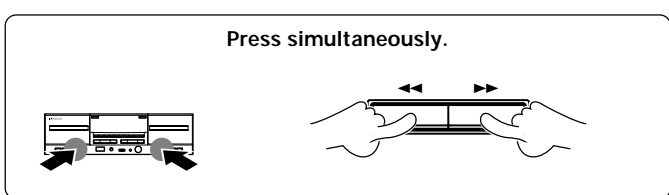

- Press the stop (■) key to stop playback and cancel this operation.

How to record (CT-203/KXF-W4010; Deck B only)

CT-2050/203/KXF-W6010/W4010 (En/M)

16

The cassette deck incorporates the Dolby HX Pro headroom extension function and auto-bias function to provide a recording with superior high-frequency characteristics. Since this unit is not designed for recording with metal (TYPE IV) tapes, do not use metal tapes for recording.

- Preparation**
- 1 Make "Playback (recording) preparation".
(CT-203/KXF-W4010; Insert a tape in deck B.)
 - 2 (Load a disc in the CD player.)

CT-2050/KXF-W6010 only

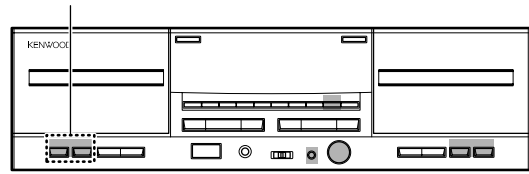

: Keys and control used in the operations described on this page.

Normal recording

1 Select the source to be recorded.

- Select by operating the input selector of the amplifier (optional).
- In case of recording a FM broadcast, refer to description of "How to use the MPX FILTER key".

2 Perform auto-bias adjustment. (The bias adjustment is applied to deck B.)

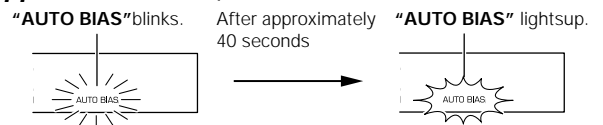
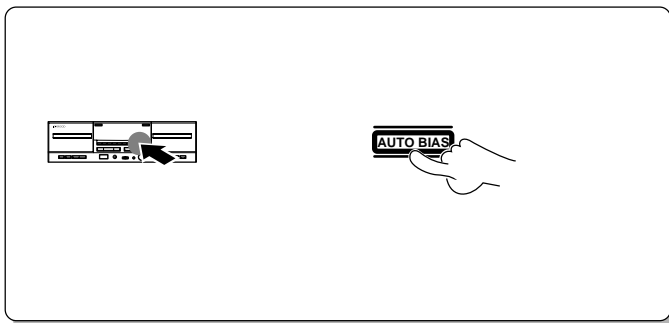

- The optimum bias is set in about 40 seconds, after which the deck enters the stop mode.
- For a fine adjustment after setting **AUTO BIAS**, refer to the description of "Bias level adjustment". (CT-2050/KXF-W6010 only)
- To cancel the auto-bias adjustment operation in the middle, press the stop (■) key.
- Recording is possible even when the auto-bias setting is omitted.
- If the amount of remaining tape is small, the auto-bias adjustment may be canceled in the middle and tape stopped at that position.
- The bias level is canceled when the eject (▲) key is pressed.

3 Set the recording level.

- 1 Play a music source.
- 2 Enter the record-pause mode.
CT-2050/KXF-W6010
CT-203/KXF-W4010
- 3 Press the MODE key and select the "BAL." mode.
MODE
- 4 Adjust the recording balance.
REC LEVEL/BAL./BIAS
MIN/L MAX/R
Right sound decreases. Left sound decreases.
- 5 Press the MODE key and select the "LEVEL" mode.
MODE
- 6 Adjust the recording level.
REC LEVEL/BAL./BIAS
MIN/L MAX/R
Recording level decreases. Recording level increases.
- 7 Stop playing the source.

- While pressing the PAUSE (||) key, press the REC/ARM (●) key.

Each press of the MODE key changes the setting.

- 1 "LEVEL" lights up: Recording level setting mode
- 2 "BAL." lights up: Recording balance setting mode
- 3 "BIAS" lights up: Recording bias setting mode (Deck B of the CT-2050/KXF-W6010 only)
- 4 "LEVEL", "BAL.", and "BIAS" go off: Counter display mode

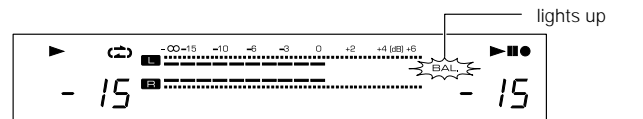

Left channel level Right channel level

- In counter, adjust the recording balance level so that the left and right displays are the same. You can also check with the [L] and [R] peak level indicators.

Each press of the MODE key changes the setting.

- 1 "LEVEL" lights up: Recording level setting mode
- 2 "BAL." lights up: Recording balance setting mode
- 3 "BIAS" lights up: Recording bias setting mode (Deck B of the CT-2050/KXF-W6010 only)
- 4 "LEVEL", "BAL.", and "BIAS" go off: Counter display mode

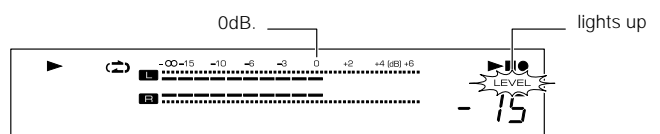

Recording level display.

- Adjust the recording level so that the 0 dB of the peak level indicators sometimes lights up.
- The recording level can be adjusted on both decks A and B. (CT-203/KXF-W4010; Deck B only)

4 Start recording.

1 Press the REC/ARM (●) key.

CT-2050/KXF-W6010

CT-203/KXF-W4010



● REC/ARM

Press once.

2 Play the music source from the beginning.

- Recording will start.
- The deck enters the stop mode automatically when the tape has been recorded till the end.

Bias level adjustment (Deck B of the CT-2050/KXF-W6010 only)

The MODE key can be used to adjust the bias level.

1 Press the MODE key and select the "BIAS" mode.



MODE

2 Adjust the bias level.

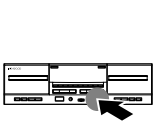

REC LEVEL/BAL./BIAS

MIN/L

MAX/R

The high frequency decreases.

The high frequency increases.

Each press of the MODE key changes the setting.

- ① "LEVEL" lights up: Recording level setting mode
- ② "BAL." lights up: Recording balance setting mode
- ③ "BIAS" lights up: Recording bias setting mode (Deck B of the CT-2050/KXF-W6010 only)
- ④ "LEVEL", "BAL.", and "BIAS" go off: Counter display mode



- To adjust the bias level, play back the recorded sound and adjust to the suitable level. Repeat if necessary.
- The bias can be adjusted to a value of ± 3 .

How to use the MPX FILTER key

Use this function when recording a radio (FM) broadcasts.



MPX FILTER

Depending on the tuner, a recorded FM broadcast may produce a "beat" sound. In this case, press the MPX FILTER key before recording. To cancel, press the MPX FILTER key again.

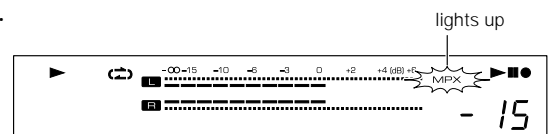

To pause recording temporarily

Pause

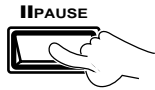

● The **||** indicator lights.

To resume recording



To stop recording

CT-2050/KXF-W6010

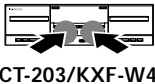

CT-203/KXF-W4010



① Stop the tape transport.

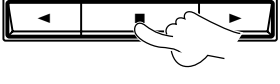

② Stop playing the source component.

How to provide non-recorded blanks between programs

In stop mode

Press successively twice.



During recording

Press once.



- After leaving a non-recorded blank of about 4 seconds, the deck enters the record-pause mode.

To start recording again from the beginning

The following procedure is useful when you want to cancel recording in progress and re-start it.

A non-recorded space of about 4 seconds or more should be reserved before the position where recording was started.

① Rewind during recording.

During recording in the ► direction:



During recording in the ◀ direction:

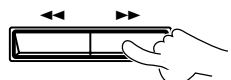

② Press the REC/ARM (●) key twice.

CT-2050/KXF-W6010

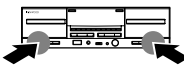

CT-203/KXF-W4010

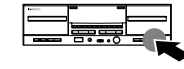

③ Replay the tune you wish to record.

④ Press the REC/ARM (●) key once.



- When the ►► (or ◀◀) key is pressed during recording, recording is aborted and tape is rewound as shown below if there is a non-recorded space of more than 4 seconds before the recording start position.

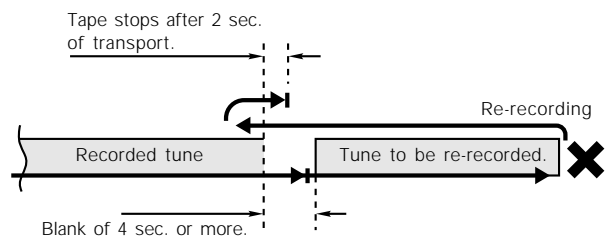

- If there is no recorded tune before, the tape will be rewound then stopped.
- When re-recording from the beginning of tape, feed the leader tape (the first portion of tape that cannot be recorded) before starting re-recording.

- A non-recorded space of about 4 seconds is reserved on tape, then the tape transport stops.

- Recording starts.

Relay recording (CT-2050/KXF-W6010 only)

CT-2050/203/KXF-W6010/W4010 (En/M)

This function allows to record sound continuously from deck A to B.

Since this unit is not designed for recording with metal (TYPE IV) tapes, do not use metal tapes for recording.

Preparation Make "Playback (recording) preparation".
→ 10
(If relay recording is required, insert tapes in both decks A and B. Select the recording mode to set to "←" or "→" only.)

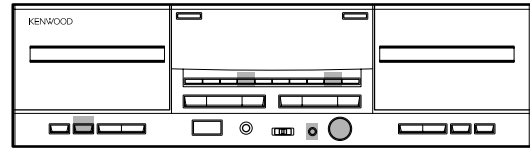

■ : Keys and control used in the operations described on this page.

Relay recording

1 Set the relay recording mode.

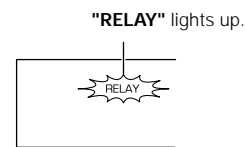

2 Perform auto-bias adjustment. (The bias adjustment is applied to deck B.)

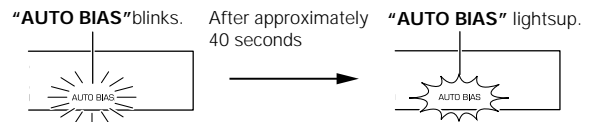
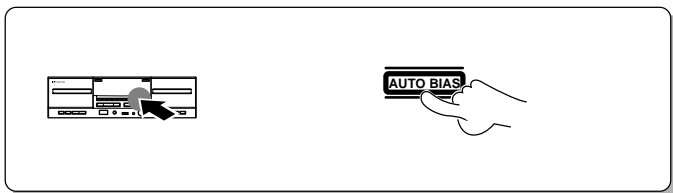

- The optimum bias is set in about 40 seconds, after which the deck enters the stop mode.
- Recording is possible even if the auto-bias adjustment operation is omitted.

3 Adjust the recording level.

- 1 Play the music source.
- 2 Set the record-pause mode. (deck A).
- 3 Adjust the recording balance and recording level. → 16
- 4 Stop playing the music source.

4 Start recording.

- 1 Press the REC/ARM (●) key (of deck A).
-
- REC/ARM
- 2 Play the music source from the beginning.

- Recording will start.
- Recording on deck B starts immediately after recording on deck A has completed.

To cancel relay recording

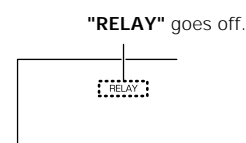
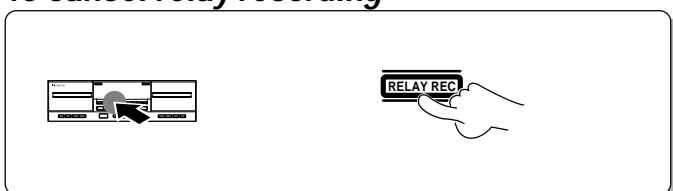

- Press the RELAY REC key again.



Relay recording cannot be performed if the REV.MODE key is set to "↔".

Tape dubbing operation (Deck A → Deck B)

CT-2050/203/KXF-W6010/W4010 (En/M)

The dubbing refers to the copy of the recorded contents of a tape to another tape (tape in Deck A → tape in Deck B). Since this unit is not designed for recording with metal (TYPE IV) tapes, do not use metal tapes for recording.

- Preparation**
- 1 Load the tape to be played in deck A and the tape to be recorded in deck B. 
 - 2 Set the tape transport directions of decks A and B to the same direction (by pressing the play (▶) key then pressing the stop (■) key immediately after it).
 - 3 Make "Playback (recording) preparation".

CT-203/KXF-W4010 only CT-2050/KXF-W6010 only

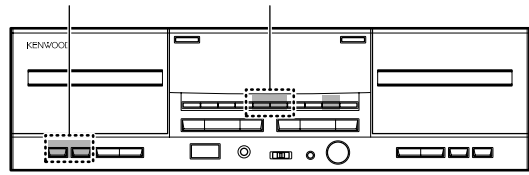



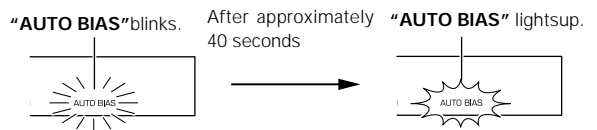
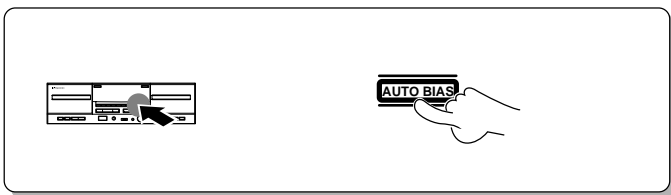

 : Keys and control used in the operations described on this page.

Tape dubbing

1 Perform auto-bias adjustment. (The bias adjustment is applied to deck B.)



- The optimum bias is set in about 40 seconds, after which the deck enters the stop mode.
- Recording is possible even if the auto-bias adjustment operation is omitted.

<p>For normal-speed dubbing.</p>  <p>CT-2050/KXF-W6010</p> <p>NORMAL DUBBING</p>  <p>CT-203/KXF-W4010</p>	<p>For high-speed dubbing.</p>  <p>CT-2050/KXF-W6010</p> <p>HIGH DUBBING</p>  <p>CT-203/KXF-W4010</p>
---	---

Normal dubbing:
Dubbing at the normal speed.

"DUBBING NORMAL" lights up.

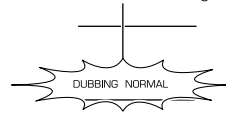



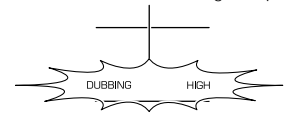

High-speed dubbing:
Dubbing at about twice the normal speed.

"DUBBING HIGH" lights up.



To pause dubbing

<p>For normal-speed dubbing.</p>  <p>CT-2050/KXF-W6010</p> <p>NORMAL DUBBING</p>  <p>CT-203/KXF-W4010</p>	<p>For high-speed dubbing.</p>  <p>CT-2050/KXF-W6010</p> <p>HIGH DUBBING</p>  <p>CT-203/KXF-W4010</p>
---	---

- Only deck B enters the record-pause mode after leaving a non-recorded space of about 4 seconds in case of normal-speed dubbing, or about 6 seconds in case of high-speed dubbing.
- To resume dubbing after pause, press the same **DUBBING** key as above (**NORMAL DUBBING** or **HIGH DUBBING**) again.

To stop dubbing

Press the stop (■) key of Deck B.

- Both decks A and B enter the stop mode.



1. The recording balance and recording level cannot be adjusted for dubbing.
2. The **DOLBY NR** is not active during dubbing.
The tape recorded by dubbing features the same NR system as the original tape in Deck A.
3. Noise from TV may interfere with dubbed sound if high-speed dubbing is executed near a TV set. To prevent this, install the system farther from the TV set.
4. If the original tape was recorded at a high level, the sound quality may be degraded, if high-speed dubbing is used. In such a case, use normal-speed dubbing.

Convenient CD recording (CT-203/KXF-W4010; Deck B only)

CT-2050/203/KXF-W6010/W4010 (En/M)

By connecting this unit with a KENWOOD "XS", "XS8", "SL16 (XS8)", type amplifier (receiver) with a SYSTEM CONTROL jack and a KENWOOD CD player with a SYSTEM CONTROL jack using system control cords, recording on this unit and playback on the CD player can be started simultaneously.

Since this unit is not designed for recording with metal (TYPE IV) tapes, do not use metal tapes for recording.

- Preparation**
- 1 Complete the connections referring to "System connections". → 6
 - 2 Make "Playback (recording) preparation". → 10
(CT-203/KXF-W4010; Insert a tape in deck B.)
 - 3 (Load a disc in the CD player.)

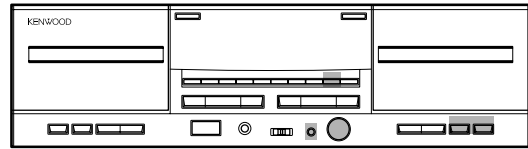

 : Keys and control used in the operations described on this page.

CD synchro recording

1 Perform auto-bias adjustment. (The bias adjustment is applied to deck B.)

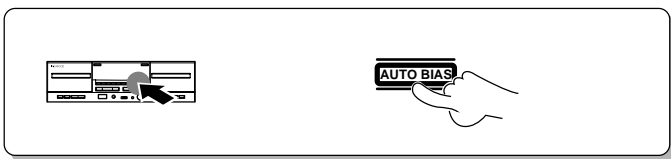

- The optimum bias is set in about 40 seconds, after which the deck enters stop mode.
- For a fine adjustment after setting AUTO BIAS, refer to the description of "Bias level adjustment". (CT-2050/KXF-W6010 only) → 17
- To cancel the auto-bias adjustment operation in the middle, press the stop (■) key.
- Recording is possible even when the auto-bias setting is omitted.

2 Adjust the recording level.

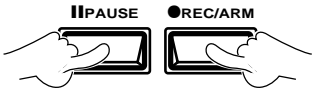
1 Play a CD. Press the ►/ key of the CD player.	2 Set the record-pause mode.  • While pressing the PAUSE () key, press the REC/ARM (●) key.	3 Adjust the recording balance and recording level. "How to record." → 16	4 Put the CD player in stop mode. Press ■ key of the CD player.
---	---	---	---

3 Set the record-pause mode.

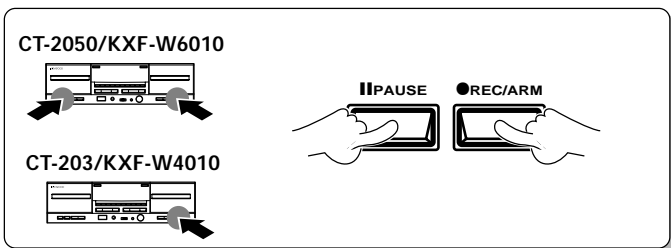

- While pressing the PAUSE (||) key, press the REC/ARM (●) key.

4 Start playing the CD.

Press the ►/|| key of the CD player.

- Synchro recording is not possible when tracks of more than one CD are programmed using a Carrousel type CD player.
- Recording starts at this moment.
- When the CD player has completed playback, the cassette deck stops recording and enters the stop mode.

To pause	: Press the ►/ key of the CD player.
To restart recording	: Press the ►/ key of the CD player.
To stop	: Press the ■ key of the CD player.

- If the stop (■) key of the cassette deck is pressed, the cassette deck enters the stop mode but the CD player does not stop.

When connected with a KENWOOD amplifier, CD player provided with "XS", "XS8", "SL16" (XS8) marking through the system control cord, this unit allows to use the CCRS, which starts recording automatically after setting the optimum recording level for the CD and tape to be used in recording.

Since this unit is not designed for recording with metal (TYPE IV) tapes, do not use metal tapes for recording.

Preparation

- 1 Complete the connections referring to "System connections". → 6
- 2 (Set the input selector of the amplifier to CD.)
- 3 (Load a disc in the CD player.)
(Edit tracks as required on the CD player.)

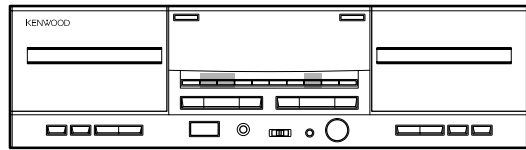

■ : Keys and control used in the operations described on this page.

Recording of CD playback (CCRS) (Deck B only)

1 Insert a tape in deck B.

2 Determine the recording condition.

1 Select the recording mode.

2 Select the Dolby NR mode.

● For the tape direction setting, see the description below "Select the tape transport direction". → 10

Each press switches the indication.

- 1 "↔" : Double-side recording.
- 2 "↔" : (Tape also stops after having recorded both sides.)
- 3 "→" : One-way recording.

Each press switches the indication.

- 1 DOLBY NR "OFF" (extinguished): Dolby NR is not used.
- 2 DOLBY NR "B": Noise reduction of the ordinary type.
- 3 DOLBY NR "C": Noise reduction with higher performance.

3 Press the CCRS key.

CT-2050/KWF-W6010

CT-203/KXF-W4010

- Program-edit recording is not possible when tracks of more than one CD are programmed using a Carrousel type CD player.
- When performing CCRS recording with a CD player which can be loaded multiple compact discs, set the CD palyer to TRACK mode, press the disc selector key and press the CCRS key of the cassette deck.
- The CCRS indicator blinks, and actual recording starts in about 20 to 200 seconds (after creating a non-recorded blank of about 8 seconds).

How to cancel CCRS

During recording level setting:

Press the Stop key of the CD player or the stop key of the cassette deck.

During CCRS recording:

Press the Stop key of the CD player, then press the OPEN / CLOSE key of the CD player.

After completion of CCRS recording:

Press the OPEN / CLOSE key of the CD player.

- After recording, the cassette deck and CD player enter the stop mode automatically.
- After completion of CCRS recording, be sure to cancel the CCRS and ensure that the CCRS indicator has gone off.



1. If the CCRS key is pressed during CD playback, playback stops and CCRS operation begins.
2. If the remaining amount of tape is small, CCRS may not function correctly or CCRS operation may be canceled in mid-operation.
3. Once the CCRS recording level has been set, the recording balance and recording level cannot be adjusted while the CCRS operation is being carried out.
4. The CCRS function sets the peak level for the entire CD in approx. 20~200 seconds. On very rare occasions, however, the function may not be able to set the optimum recording level. If this occurs, carry out recording manually referring to the "Normal recording" section. → 16
5. The CCRS recording level setting is canceled when the open/close key of the CD player is pressed or when the power is switched OFF.
6. With CD players equipped with the EDIT function, it is possible to make recordings in which the last songs on sides A and B are not cut off in the middle and in which the recording capacity of the tape is used to the fullest extent. (Set the REV.MODE key of the deck to "↔".)

Timer operations

CT-2050/203/KXF-W6010/W4010 (En/M)

23

This unit incorporates a built-in timer standby function. By using an audio timer optionally available in the market, wake-up playback and unattended recording of tape can be started at any time of the day. Connect the power cords of the components directly or indirectly to the timer so that their powers can be turned on via the timer.

The timer setup operation varies depending on the timer. Also read carefully the instruction manual of your audio timer.

Preparation

- 1 Set the power switches of the components to ON.
- 2 Set the input selector of the amplifier to TAPE.
- 3 Make "Playback (recording) preparation".

(If relay playback is required, insert tapes in both decks A and B.)

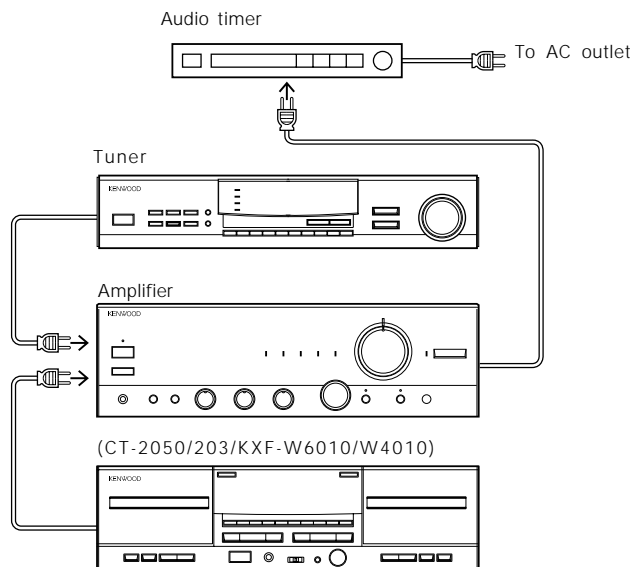

Timer playback of tape

1 Start playback.

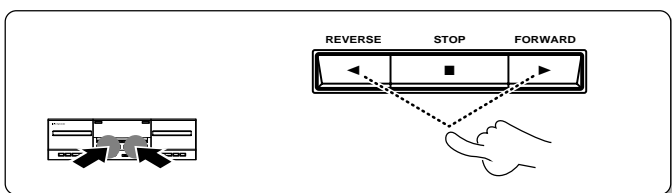

2 Adjust the volume of the amplifier.

3 Rewind the tape(s) to the start position.

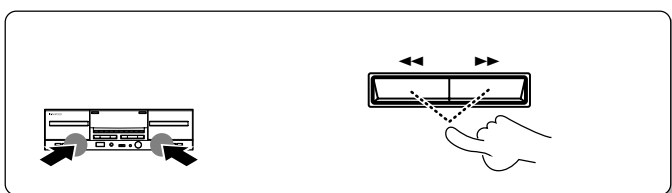

4 Set the TIMER switch to PLAY.

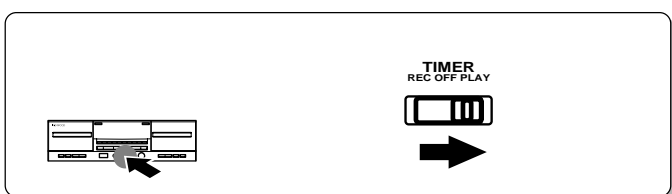

5 Set the timer.

- Set the timer so that the tape starts at the desired time of the day.
- When the set time comes, tape playback starts automatically.
- Read carefully the instruction manual of your audio timer.



1. When connecting the KENWOOD equipment (amplifier, CD player) and the system, remove the disc from the CD player.
2. If relay playback is required, set to "D" or "E".
3. If tapes are inserted in both decks A and B, timer playback starts with deck B.
4. Switch on the power to the cassette deck. (The timer will not operate if it is switched off.)

- Preparation**
- 1 Set the power switches of the components to ON.
 - 2 Set the input selector of the amplifier to TUNER.
 - 3 Receive the desired radio station with the tuner.
 - 4 Make "Playback (recording) preparation".
→ 10
 (If relay recording is required, insert tapes in both decks A and B.)
 - 5 (Remove the disc from the CD player.)

CT-2050/KXF-W6010 only

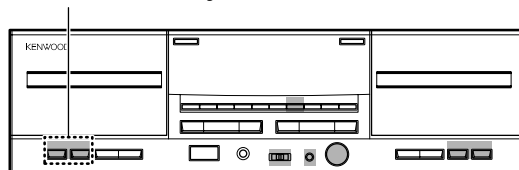

: Keys and control used in the operations described on this page.

Timer recording of tuner broadcast (CT-203/KXF-W4010; Deck B only)

1 Press the MPX FILTER key to ON. (when recording FM broadcasts only)

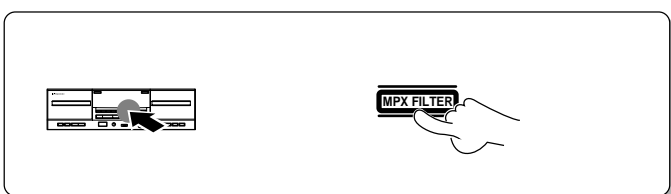

- Refer to the "How to use the MPX FILTER key". → 17
- To cancel, press the MPX FILTER key again.

2 Adjust the recording level.

CT-2050/KXF-W6010

CT-203/KXF-W4010

- 1 Set the record-pause mode.
|| PAUSE ● REC/ARM
- 2 Adjust the recording balance and recording level.

- While pressing the PAUSE (||) key, press the REC/ARM (●) key.
- Refer to the "How to record". → 16

3 Set the amplifier volume to the minimum position.

4 Set the TIMER switch to REC.



5 Set the timer.

- Set the desired time when the recording is to be started.
- When the set time comes, the powers of the related components are turned ON and recording starts.
- Recording stops when the end of side to be recorded is reached.
- Read carefully the instruction manual of your audio timer.

Timer relay recording (CT-2050/KXF-W6010 only)

- 1 Press the MPX FILTER key to ON. → 17
- 2 Complete the procedure 1, 2, 3 of "Relay recording". → 19
- 3 Complete the procedure 3, 4, 5 of "Timer recording of tuner broadcast".

• Relay recording is not set, deck B will record.



1. To ensure that the cassette deck's automatic shut off switch operates before the power is shut off, set the timer so that it operates for a little longer than the playing time of the tape.
2. Switch on the power to the cassette deck. (The timer will not operate if it is switched off.)





What appears to be a malfunction may not always be serious. If your unit should not perform as expected, consult the table below to see if the problem can be corrected before seeking help from your dealer or service representative.

Operation to reset

The microcomputer may fall into malfunction (impossibility to operate, erroneous display, etc.) when the power cord is unplugged while this unit is ON or due to an external factor. In this case, execute the following method to reset the microcomputer and return it to normal condition.

Turn the power switch on and off again while pressing the stop (■)key on deck B.

- Please note that resetting microcomputer clears contents stored in and returns it to the condition when it left the factory.

Symptom	Cause	Remedy
Sounds is not produced when the Play key is pressed.	<ul style="list-style-type: none"> ● The connection cords are connected improperly. ● The head is dirty. ● Tape is irregularly wound and hard to take up. ● A non-recorded tape is being played. 	<ul style="list-style-type: none"> ● Connect the cords properly referring to "System connections". →  ● Clean the head referring to "Cleaning the head section". →  ● Replace the tape. ● Play a recorded tape.
The deck does not work when an operation key is pressed.	<ul style="list-style-type: none"> ● The cassette holder is not closed completely. ● The operation key was pressed immediately after closing the cassette holder. ● An operation key is pressed in less than 3 seconds after this unit is turned ON. ● Tape is not inserted. ● Tape is irregularly wound and hard to take up. ● Tape has been fully wound to reel. 	<ul style="list-style-type: none"> ● Close the cassette holder completely. ● Press the desired operation key in a few seconds after closing the cassette holder. ● Press the desired operation key in more than 3 seconds after turning the power on. ● Insert a tape. ● Replace the tape. ● Change the tape transport direction or insert the tape inversely.
DPSS malfunctions.	<ul style="list-style-type: none"> ● The tape is not suitable for DPSS operation, for example the spaces between tunes are too short. 	<ul style="list-style-type: none"> ● Read "Convenient music search (DPSS)". → 
CCRS does not work.	<ul style="list-style-type: none"> ● A recordable tape is not inserted in deck B. ● A disc is not placed in the CD player. ● The system control cord may be disconnected. ● The disc is dirty. 	<ul style="list-style-type: none"> ● Insert a recordable tape in deck B and press the CCRS key. ● Place a disc in the CD player and press the CCRS key. ● Connect the system control cord securely. ● Clean the disc, place it in the CD player, and press the CCRS key.
The dubbing on Deck A and Deck B ends at different timing.	<ul style="list-style-type: none"> ● This is due to the difference in tape length or to the characteristics of the cassette deck mechanisms. 	<ul style="list-style-type: none"> ● A small time difference is not regarded as a failure.
The cassette holder does not open when the eject (▲)key is pressed.	<ul style="list-style-type: none"> ● The key is pressed during recording or playback. 	<ul style="list-style-type: none"> ● Press in the stop mode.
Sound is hoarse, or high frequencies are not audible.	<ul style="list-style-type: none"> ● The head is dirty. ● The tape is stretched or wrinkled. 	<ul style="list-style-type: none"> ● Clean the head referring to "Cleaning the head section". →  ● Replace the tape.
Sound is distorted.	<ul style="list-style-type: none"> ● The recording level was too high. ● A tape recorded with distorted sound is being played. 	<ul style="list-style-type: none"> ● Adjust the recording level referring to "How to record". →  ● Replace the tape.

Symptom	Cause	Remedy
Recording is not initiated when the REC/ARM (●) key is pressed.	<ul style="list-style-type: none"> ●The protection tab on the cassette has been broken. ●The cassette holder is not closed completely. ●The recording level is set to the minimum position. ●The TAPE input selector is selected on the amplifier. ●Tape has been fully wound to a reel. 	<ul style="list-style-type: none"> ●Use a cassette with unbroken tab or close the hole. ●Close the cassette holder completely. ●Adjust the recording level referring to "How to record". → 16 ●Press the input selector key of the source to be recorded. ●Change the tape transport direction of deck or insert the tape inversely.
Noise level is high.	<ul style="list-style-type: none"> ●The head is magnetized. ●External noise is induced. ●The system assembly position is wrong. ●The recording level was too low. ●A tape recorded with Dolby NR ON is being played with Dolby NR OFF. 	<ul style="list-style-type: none"> ●Demagnetize the head referring to "Cleaning the head section". → 4 ●Install the system apart from other electrical appliances and TV set. ●Change the arrangement or the position of the equipment. ●Adjust the recording level referring to "How to record". → 16 ●Set the DOLBY NR key to B or C.
Sound is vibrating.	<ul style="list-style-type: none"> ●The capstans or pinch rollers are dirty. ●Tape is irregularly wound. 	<ul style="list-style-type: none"> ●Clean the capstans and pinch rollers. ●Wind the tape regularly by fast forwarding, rewinding or playing it fully from one reel to another.
Playback or recording starts immediately when the power is switched ON.	<ul style="list-style-type: none"> ●The TIMER switch is set to PLAY or REC. 	<ul style="list-style-type: none"> ●Set the TIMER switch to OFF unless timer playback or timer recording is required.



With some tapes, a squeaky noise is produced when the tape is stopped automatically. This is due to the tape protection function, and not a malfunction.

Dolby noise reduction system

→ 10

Dolby noise reduction system

The Dolby noise reduction system was developed to reduce the tape hiss noise generated during playback.

The optimum effect of the Dolby NR system is obtained when the same type NR system is used for both recording and playback. If a different type NR system is used, playback is not performed correctly. Make sure that the same type noise reduction system is used for both recording and playback.

Dolby B NR

The most popular noise reduction system used in home audio components. Usually, Dolby NR system corresponds to B NR.

Dolby C NR

Dolby C NR offers improved noise reduction performance over that of the Dolby B NR. It features a superior noise reduction effect, use Dolby C NR to record or playback with this unit.

It is recommended that tapes recorded with the Dolby NR system be marked "B" or "C", so that they can easily be distinguished.

DPSS (Direct Program Search System)

→ 14

The DPSS detects non-recorded blanks of 4 seconds or more between music and enables the following four types of simple playback operations according to the instructions given by pressing operation keys. (It is not possible to perform DPSS operations simultaneously on the two decks.)

1. Skip play : By specifying a tune located several tunes beyond (or behind) the tune being played, skips tunes between the current tune and the selected tune and starts playback from the beginning of the selected tune. Up to 16 tunes can be skipped in Skip Search.
2. Rewind & Play : Rewinds the tape to the beginning and starts playback from there.
3. Single-tune repeated playback : One single tune is played back repeatedly up to 16 times.
4. Dash & Play : If a non-recorded space of more than 10 seconds is detected during playback, that space will be skipped by fast forward tape winding.

Recording with Dolby HX Pro

→ 16

What is Dolby HX Pro?

In ordinary recording using high-frequency biasing, the high-frequency bias current, which should be constant, is increased with some recording sources due to the high-frequency component contained in the music, etc. This increase affects the recording characteristics with distorted high frequencies and degraded dynamic range and frequency response.

The Dolby HX Pro circuit detects the high-frequency component contained in the music source being recorded, and reduces excessive bias current to make it constant. As a result, the recording characteristics of high frequencies are drastically improved, and the improved high-frequency reproduction can also be enjoyed even when the tape is played on tape decks which are not equipped with circuit.

Auto-bias function

→ 16

The auto-bias function automatically adjusts the tape's bias value to ensure optimum recording performance with each and every tape.

CCRS (Computer-controlled CD Recording System) → 22

When connected with a KENWOOD amplifier, CD player provided with "[XS]", "[XS8]", "[SL16] (XS8)" marking through the system control cord, this unit allows to use the CCRS, which starts recording automatically after setting the optimum recording level for the CD and tape to be used in recording.

1. The CD starts to be played, and the peak value is sampled from the levels of the signals on the CD.
2. The optimum recording level for the specific CD is determined and set based on the peak value sampled.
3. The recording preparation steps above take about 20~200 seconds, after which the actual recording starts.
4. After recording (when the CD player is stopped or when the tape has run out), both the cassette deck and CD player stop.

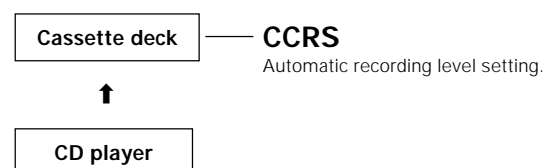

CT-2050/KXF-W6010

Track System	4 track, 2 channel stereo
Recording System	AC bias (Frequency: 105 kHz)
Heads	A DECK
	Playback/recording heads 1
	Erasing head 1
	B DECK
	Playback/recording heads 1
	Erasing head 1
Motors	A DECK DC motor × 1
	B DECK DC motor × 1
Wow and Flutter	±0.17 % (IEC)
	±0.28 % (DIN)
	0.1 % (W.R.M.S)
Fast Winding Time	Approx. 110 seconds (C-60 tape)
Frequency Response	
TYPE I tape	30 Hz to 18,000 Hz, ±3 dB
TYPE II tape	30 Hz to 19,000 Hz, ±3 dB
Signal to Noise Ratio	
Dolby NR OFF	56 dB
(IEC, 250 nWb/m, TYPE II tape)	
Dolby NR OFF	59 dB
Dolby B NR ON	68 dB
Dolby C NR ON	75 dB
(3rd, H.D., 3 %, TYPE II tape)	
Harmonic Distortion	Less than 1.2 %
(at 315 Hz, 3rd H.D., 250 nWb/m, TYPE II tape)	
Input sensitivity/Impedance	
LINE IN	122.8 mV/47 kΩ
Output Level/Impedance	
LINE OUT	775 mV/1.0 kΩ
Headphones	0.5 mW/32 Ω
[General]	
Power Consumption	30 W
Dimensions	W: 440 mm (15-3/4")
	H: 134 mm (5-9/16")
	D: 369 mm (15-3/8")
Weight (Net)	4.6 kg (10.6 lb)

CT-203/KXF-W4010

Track System	4 track, 2 channel stereo
Recording System	AC bias (Frequency: 105 kHz)
Heads	A DECK
	Playback head 1
	B DECK
	Playback/recording heads 1
	Erasing head 1
Motors	A DECK DC motor × 1
	B DECK DC motor × 1
Wow and Flutter	±0.17 % (IEC)
	±0.28 % (DIN)
	0.1 % (W.R.M.S)
Fast Winding Time	Approx. 110 seconds (C-60 tape)
Frequency Response	
TYPE I tape	30 Hz to 18,000 Hz, ±3 dB
TYPE II tape	30 Hz to 19,000 Hz, ±3 dB
Signal to Noise Ratio	
Dolby NR OFF	56 dB
(IEC, 250 nWb/m, TYPE II tape)	
Dolby NR OFF	59 dB
Dolby B NR ON	68 dB
Dolby C NR ON	75 dB
(3rd, H.D., 3 %, TYPE II tape)	
Harmonic Distortion	Less than 1.2 %
(at 315 Hz, 3rd H.D., 250 nWb/m, TYPE II tape)	
Input sensitivity/Impedance	
LINE IN	122.8 mV/47 kΩ
Output Level/Impedance	
LINE OUT	775 mV/1.0 kΩ
Headphones	0.5 mW/32 Ω
[General]	
Power Consumption	30 W
Dimensions	W: 440 mm (15-3/4")
	H: 134 mm (5-9/16")
	D: 369 mm (15-3/8")
Weight (Net)	4.6 kg (10.6 lb)



1. KENWOOD follows a policy of continuous advancements in development. For this reason specifications may be changed without notice.
2. The full performance may not be exhibited in an extremely cold location (under a water-freezing temperature).

KENWOOD

For your records

Record the serial number, found on the back of the unit, in the spaces designated on the warranty card, and in the space provided below. Refer to the model and serial numbers whenever you call upon your dealer for information or service on this product.

Model _____ Serial Number _____

Free Manuals Download Website

<http://myh66.com>

<http://usermanuals.us>

<http://www.somanuals.com>

<http://www.4manuals.cc>

<http://www.manual-lib.com>

<http://www.404manual.com>

<http://www.luxmanual.com>

<http://aubethermostatmanual.com>

Golf course search by state

<http://golfingnear.com>

Email search by domain

<http://emailbydomain.com>

Auto manuals search

<http://auto.somanuals.com>

TV manuals search

<http://tv.somanuals.com>