

KENWOOD

AUDIO VIDEO SURROUND RECEIVER

KRF-X9080D

INSTRUCTION MANUAL

KENWOOD CORPORATION

About the supplied remote control

Compared to standard remote controls, the remote control supplied with this receiver has several operation modes. These modes enable the remote control to control other audio/video components. In order to effectively use the remote control, it is important to read the operating instructions and obtain a proper understanding of the remote control and how to switch its operation modes (etc.). Using the remote control without completely understanding its design and how to switch the operation modes may result in incorrect operations.

ENGLISH

FRANÇAIS

DEUTSCH

NEDERLANDS

ITALIANO

ESPAÑOL

Before applying the power

 **Caution : Read this page carefully to ensure safe operation.**

Units are designed for operation as follows.

U.S.A. and Canada	AC 120 V only
Australia	AC 240 V only
Europe and U.K.	AC 230 V only
China and Russia	AC 220 V only
Other countries	AC 110-120 / 220-240 V switchable

ENGLISH

How to use this manual

This manual is divided into four sections, Preparations, Operations, Remote Control, and Additional Information.

Preparations

Shows you how to connect your audio and video components to the receiver and prepare the surround processor.

Since this receiver works with all your audio and video components, kindly follow the instructions in this manual for the correct connections.

Operations

Shows you how to operate the various functions available on the receiver.

Remote Control

Shows you how to operate other components using the remote control, as well as a detailed explanation of all remote control operations. Once you have registered your components with the proper setup codes, you'll be able to operate both this receiver and your other AV components (TV, VCR, DVD player, CD player, etc.) using the remote control supplied with this receiver.

Additional Information

Shows you additional information such as "In case of difficulty" (troubleshooting) and "Specifications".

Safety precautions

WARNING :

TO PREVENT FIRE OR ELECTRIC SHOCK, DO NOT EXPOSE THIS APPLIANCE TO RAIN OR MOISTURE.

Maintenance of the unit

When the front panel or case becomes dirty, wipe with a soft, dry cloth. Do not use thinner, benzine, alcohol, etc. for these agents may cause discoloration.

In regard to contact cleaner

Do not use contact cleaners because it could cause a malfunction. Be specially careful not to use contact cleaners containing oil, for they may deform the plastic component.



CAUTION
RISK OF ELECTRIC SHOCK
DO NOT OPEN



CAUTION: TO REDUCE THE RISK OF ELECTRIC SHOCK, DO NOT REMOVE COVER (OR BACK). NO USER-SERVICEABLE PARTS INSIDE. REFER SERVICING TO QUALIFIED SERVICE PERSONNEL.



THE LIGHTNING FLASH WITH ARROWHEAD SYMBOL, WITHIN AN EQUILATERAL TRIANGLE, IS INTENDED TO ALERT THE USER TO THE PRESENCE OF UNINSULATED "DANGEROUS VOLTAGE" WITHIN THE PRODUCT'S ENCLOSURE THAT MAY BE OF SUFFICIENT MAGNITUDE TO CONSTITUTE A RISK OF ELECTRIC SHOCK TO PERSONS.



THE EXCLAMATION POINT WITHIN AN EQUILATERAL TRIANGLE IS INTENDED TO ALERT THE USER TO THE PRESENCE OF IMPORTANT OPERATING AND MAINTENANCE (SERVICING) INSTRUCTIONS IN THE LITERATURE ACCOMPANYING THE APPLIANCE.

Contents

Caution : Read the pages marked  carefully to ensure safe operation.

△ Before applying the power	2
△ Safety precautions	2
How to use this manual	2
Unpacking	4
Preparing the remote control	4
Special features	5
Names and functions of parts	6
Main unit	6
Remote control unit	7

Preparations	Setting up the system	8
	Connecting the terminals	9
	Connecting audio components	10
	Connecting video components	11
	Digital connections	12
	Connecting video components (COMPONENT VIDEO)	13
	Connecting a DVD player (6-channel input)	14
	Connecting the speakers	15
	PRE OUT connections	16
	Connecting to another room (ROOM B)	17
	Connecting to the AV AUX jacks	18
	Connecting the antennas	18
	Preparing for surround sound	19
	Speaker settings	19

Operations	Normal playback	23
	Preparing for playback	23
	Listening to a source component	23
	Adjusting the sound	24
	Recording	26
	Recording audio (analog sources)	26
	Recording video	26
	Recording audio (digital sources)	26
	Listening to radio broadcasts	27
	Tuning (non RDS) radio stations	27
	Using RDS (Radio Data System)	27
	Presetting radio stations manually	28
	Receiving preset stations	28
	Receiving preset stations in order (P.CALL) ...	28
	Using the RDS DISP (Display) key	29
Presetting RDS stations (RDS AUTO MEMORY)	29	
Tuning by Program TYpe (PTY search)	30	
Ambience effects	31	
Surround modes	31	
Surround play	34	
DVD 6-channel playback	36	
Convenient functions	36	

Remote Control	Basic remote control operations for other components	39
	Registering setup codes for other components	39
	Searching for your codes	39
	Checking the codes	39
	Re-assigning device keys	40
	Operating other components	40
	Storing the remote control of the other components	41
	Setup code chart	42
	Cassette deck, CD player & MD recorder operations	47
	Other components' operations	48

Additional Information	In case of difficulty	50
	△ Specifications	52

Unpacking

Unpack the unit carefully and make sure that all accessories are present.

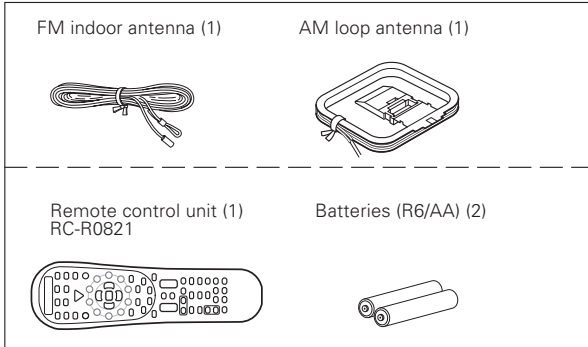

If any accessories are missing, or if the unit is damaged or fails to operate, notify your dealer immediately. If the unit was shipped to you directly, notify your shipper immediately. Kenwood recommends that you retain the original carton and packing materials in case you need to move or ship the unit in the future.

Keep this manual handy for future reference.

Memory back up function

Please note that the following items will be deleted from the unit's memory if the power cord is disconnected from the AC outlet for approximately 1 day.

- Power mode
- Input selector settings
- Picture output
- Speaker ON/OFF
- Volume level
- BASS, TREBLE, INPUT level
- TONE ON/OFF
- LOUDNESS ON/OFF
- Dimmer level
- MD/TAPE settings
- Listen mode setting
- Speaker settings
- Distance setting
- Input mode setting
- Sound mode settings
- Broadcast band
- Frequency setting
- Preset stations
- Tuning mode
- ACTIVE EQ mode
- SPEAKER EQ mode

Preparing the remote control

Loading the batteries

① Remove the cover.

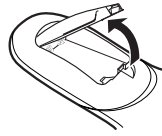

② Insert the batteries.

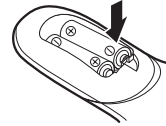

③ Close the cover.



- Insert two AA-size (R6) batteries as indicated by the polarity markings.

Operation

When the **STANDBY** indicator is lit, the power turns ON when you press the **POWER RCVR** key on the remote control. When the power comes ON, press the key you want to operate.

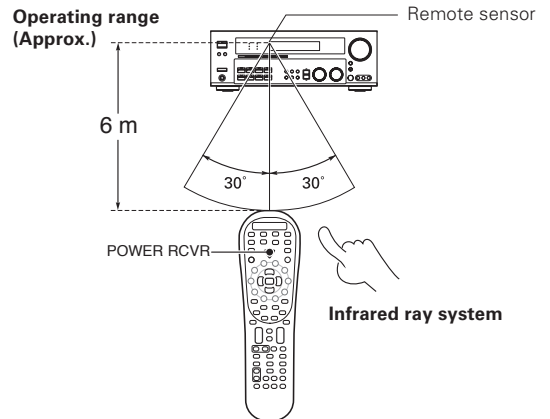

- When pressing more than one remote control key successively, press the keys securely by leaving an interval of 1 second or more between keys.

Notes

1. The supplied batteries may have shorter lives than ordinary batteries due to use during operation checks.
2. When the remote-controllable distance gets shorter than before, replace both batteries with new ones.
3. Placing the remote sensor in direct sunlight, or in direct light from a high frequency fluorescent lamp may cause malfunction. In such a case, change the location of the system installation to prevent malfunction.

Special features

True home theater sound

This receiver incorporates a wide variety of surround modes to bring you maximum enjoyment from your video software. Select a surround mode according to your equipment or the software you are going to play and enjoy! → [31]

THX

THX mode activates proprietary THX features that help recreate the cinematic experience in a home environment. → [35]

THX Surround EX

During THX Surround EX mode, film soundtracks that have been encoded with Dolby Digital Surround EX technology are able to reproduce an extra channel which has been added during the mixing of the program. This channel is called Surround Back.

THX Surround EX mode activates proprietary THX features that help recreate the cinematic experience in a home environment. → [35]

Dolby Digital and Dolby Digital EX

The DOLBY DIGITAL mode lets you enjoy full digital surround from software processed in the Dolby Digital format. Dolby Digital provides up to 5.1 channels of independent digital audio for better sound quality and more powerful presence than conventional Dolby Surround.

As for Dolby Digital EX, it creates six full-bandwidth output channels from the 5.1 channel sources. This is done using a matrix decoder that derives three surround channels from the two in the original recording. For best results, Dolby Digital EX should be used with movie soundtracks recorded with Dolby Digital Surround EX.

Dolby PRO LOGIC IIx and Dolby PRO LOGIC II

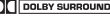
DOLBY PRO LOGIC II, whilst totally compatible with its predecessor PRO LOGIC, provides greater advantages in surround sound. It allows user to enjoy the conventional stereo or Dolby Surround with a convincing "5.1 like" presentation. PRO LOGIC II offers special features for controlling the overall spatial, dimensionality and frontal sound field imaging. PRO LOGIC II produces an impressive surround sound from video software marked  and three-dimensional space from music CD. When listening to music, you will be able to enjoy the experience of sheer STEREO surround sound.

DOLBY PRO LOGIC IIx enhanced DOLBY PRO LOGIC II's features. It creates 6.1 channel and 7.1 channel surround sound from stereo or 5.1 channel signals. This feature provides you an astonishing ambience effect which makes you feel you are surrounded by natural sound. Especially 7.1 channel surround sound can produce real back sound from Surround Back speakers.

DTS and DTS-ES

DTS (Digital Theater System) is a 5.1 channel digital audio format that provides five full spectrum channels and one low-frequency (subwoofer) channel for unprecedented clarity, optimum channel separation and a (wide) dynamic range.

DTS-ES (Extended Surround) presents 6.1 channels surround system with additional Surround Back channel which evolved from the conventional 5.1 channels surround system. DTS-ES format that was recorded in DVD, CD or LD comprises of two modes. DTS-ES Discrete 6.1 produce the discrete surround back which is completely independent and DTS-ES Matrix 6.1 produces the surround back which synthesized within the left and right surround channels using matrix technology. DTS-ES has perfect compatibility with the conventional 5.1 channels surround system. 6.1 channels surround with an additional surround back presents a more natural presence and surround effects by increasing the impression of the sound image from back.

Important:

When a DTS disc is played on a CD, LD or DVD player, noise may be output from the analog output. It is recommended that you connect the digital output of the player to the digital input of this unit.

DTS 96/24

DTS 96/24 made it possible to achieve a wide frequency range of over 40 kHz by increasing the sampling frequency to 96 or 88.2 kHz. Moreover, DTS 96/24's ability of 24 bit resolution offers the same frequency band and dynamic range as 96 kHz/24 bit PCM.

DTS 96/24 is, as with conventional DTS Surround, compatible with multi-channels. Therefore, sources recorded using DTS 96/24 technologies can be played in high sampling frequency, multi-channel audio with ordinary DVDs and CDs.

Neo:6

Neo:6 is a new technology which was developed by DTS. It can produce high grade 6 channels surround with an astonishing fidelity from 2 channels content. Neo:6 has 2 mode, "CINEMA" mode is for movie playback and "MUSIC" mode is for music playback.

DSP surround modes

The DSP (Digital Signal Processor) used for this receiver incorporates a variety of high quality adjustable sound fields, like "ARENA", "JAZZ CLUB", "THEATER", "STADIUM" and "DISCO". It is compatible with almost any kind of program source.

DVD 6-channel input

If you own a DVD player equipped with 6-channel output, this receiver allows you to obtain the full surround sound impact of DVD source material featuring multi-channel encoding. Since the source signals are digital and each channel is input independently, the resulting ambience is far superior to what can be achieved with conventional surround sound systems.

ACTIVE EQ

ACTIVE EQ mode will produce a more dynamic sound quality in any condition. You can enjoy a more impressive sound effect when ACTIVE EQ is turned on.

SPEAKER EQ

SPEAKER EQ function is to adjust the receiver's audio output characteristics with the speakers' characteristics which differs depending on the size of the speakers. When activating the SPEAKER EQ function, you will be able to enjoy a more natural and dynamic sound experience even with small size speakers.

Universal IR (InfraRed) remote control

In addition to the basic receiver, the remote control supplied with this receiver can also operate almost all of your remote controllable audio and video components. Just follow the simple setup procedure to register the components you have connected.

Video up conversion

This receiver can convert the incoming composite video signals to S-Video signal.

If your monitor TV has S-Video jacks, it is not necessary to do the composite video connections, just use an S-Video cord to connect the receiver and your monitor TV.

RDS (Radio Data System) tuner

The receiver is equipped with an RDS tuner that provides several convenient tuning functions: RDS Auto Memory, to automatically preset up to 40 RDS stations broadcasting different programs; station name display, to show you the name of the current broadcast station; and PTY search to let you tune stations by program type.

PTY (Program Type) search

Tune the stations by specifying the type of program you want to hear.

Names and functions of parts

Main unit

***Input channel indicators**
The Input channel indicators lights up to indicate the channels contained in the input signal. The "S" indicator lights when the surround component consists of a single channel.

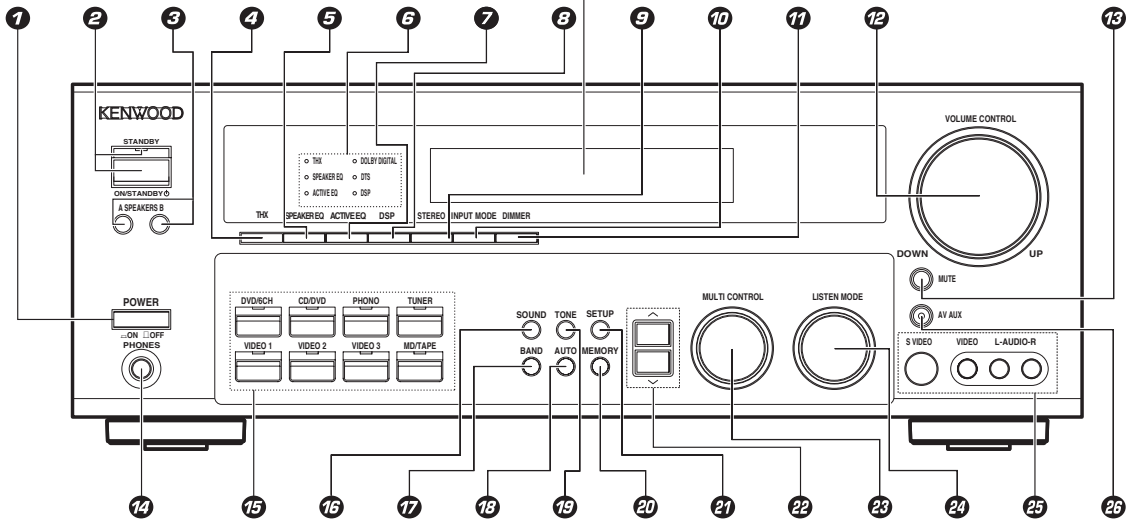
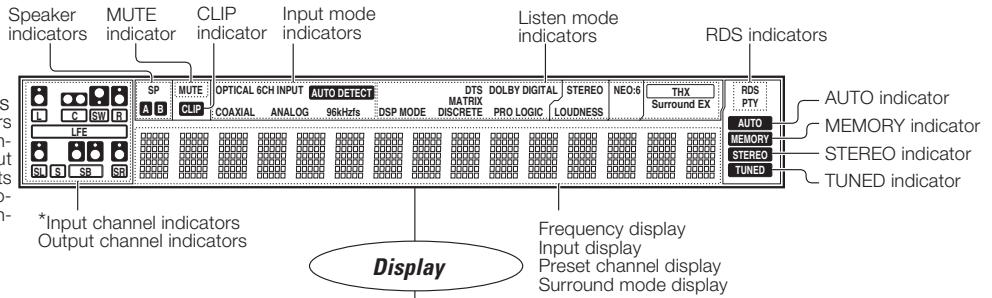

- | | | |
|--|---|--|
| <p>1 POWER ON/OFF key - [19]
Use to turn the main power on or off.</p> <p>2 ON/STANDBY \updownarrow key - [19]
Use to turn the power ON/STANDBY when the POWER is turned on.</p> <p>3 STANDBY indicator</p> <p>4 SPEAKERS keys - [23]
Use to turn the A/B speakers on or off.</p> <p>4 THX key - [34]
Use to switch the status of THX.</p> <p>5 SPEAKER EQ key - [24]
Use to select SPEAKER EQ's setting.</p> <p>6 Surround LED (light-emitting diode) indicators</p> <p>THX indicator - [36]
Lights when the THX mode has been chosen. THX mode may or may not be activated depending upon the applicable playback mode.</p> <p>SPEAKER EQ indicator - [25]
Lights when the receiver is in the SPEAKER EQ mode.</p> <p>ACTIVE EQ indicator - [24]
Lights when the receiver is in the ACTIVE EQ mode.</p> <p>DOLBY DIGITAL indicator - [34]
Lights when the receiver is in the Dolby Digital mode.</p> | <p>DTS indicator - [34]
Lights when the receiver is in the DTS mode.</p> <p>DSP indicator - [34]
Lights when the receiver is in the DSP mode.</p> <p>7 ACTIVE EQ key - [24]
Use to select ACTIVE EQ's setting.</p> <p>8 DSP key - [34]
Use to select any of the DSP mode.</p> <p>9 STEREO key - [34]
Use to switch the listen mode to STEREO.</p> <p>10 INPUT MODE key - [8]
Use to switch between the full auto, digital and analog inputs.</p> <p>11 DIMMER key - [26]
Use to select the REC MODE.
Use to adjust the brightness of the display.</p> <p>12 VOLUME CONTROL knob - [36]
13 MUTE key - [24]
Use to temporarily mute the sound.</p> <p>14 PHONES jack - [25]
Use for headphone listening.</p> <p>15 Input Selector keys - [23]
DVD/6CH, CD/DVD, PHONO, TUNER, VIDEO 1, VIDEO 2, VIDEO 3, MD/TAPE
Use to select input sources.</p> | <p>16 SOUND key - [36]
Use to adjust the sound quality and the ambience effects.</p> <p>17 BAND key - [27]
Use to select the broadcast band.</p> <p>18 AUTO key - [27]
Use to select the auto or manual tuning mode.</p> <p>19 TONE key - [24]
Use to switch the status of TONE control.</p> <p>20 MEMORY key - [28]
Use to store radio stations in the preset memory and to start the Auto Memory.</p> <p>21 SETUP key - [19]
Use to select the speakers' settings etc.</p> <p>22 \wedge/\vee keys - [19]
Use for selection adjustments during sound, setup and preset channel functions.</p> <p>23 MULTI CONTROL knob - [19]
Use to control a variety of settings.</p> <p>24 LISTEN MODE knob - [34]
Use to select the listening mode.</p> <p>25 AV AUX (S VIDEO, VIDEO, L-AUDIO-R) jacks - [18]
26 AV AUX key - [18]
Use to switch the input to AV AUX.</p> |
|--|---|--|

Standby mode

While the standby indicator is lit, a small amount of power is supplied to the system to back up the memory. This is called standby mode. Under the condition, the system can be turned ON by remote control unit.

CAUTION

The power in this equipment will not be completely cut off from the AC wall outlet when the main switch is turned OFF.

Remote control unit

This remote control unit can be used not only for Kenwood products but also for other non-Kenwood products by setting the appropriate manufacturer's setup codes. - [39]

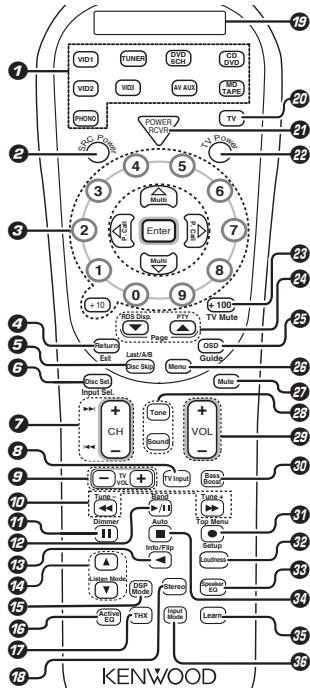

If the name of a function on the receiver is different from the one's on the remote control, the name of the remote control key in this manual is indicated in parentheses.

- 1 Source keys (MD/TAPE, CD/DVD, DVD/6CH, TUNER, VID1, VID2, VID3, AV AUX, PHONO)** - [39]
When press and hold for more than 3 seconds, they are used to select the registered components.
Input Selector keys (MD/TAPE, CD/DVD, DVD/6CH, TUNER, VID1, VID2, VID3, AV AUX, PHONO) - [23]
When press and release in less than 3 seconds, they are used to select the input sources.
- 2 SRC (source) Power key**
Use to turn the other source components on or off.
- 3 Numeric keys** - [39]
Provide functions identical to those of the original remote control supplied with the component you are controlling.
Multi (multi control) Δ/∇ keys - [19]
Use to control a variety of settings.
Use to operate other components.
P.Call $\triangleleft/\triangleright$ keys - [28]
Use for selection adjustments during sound, set up and preset channel functions.
Enter key
Use to operate other components.
- 4 Return key**
Use to operate the DVD component.
Exit key
Use to operate other components.

- 5 Disc Skip key**
If CD is selected as the input source, this key functions as the multi-CD player disc skip key.
Last/ A/B key
If TAPE is selected as the input source, this is A and B deck of a double cassette deck.
Use to operate other components.
- 6 Disc Sel. key**
Use to operate other components.
Input Sel. key
Use to operate other components.
- 7 CH +/- keys**
Use to select the channels.
 $\triangleright/\triangleleft$ keys
If CD, MD and DVD as the input source, these keys function as skip keys.
- 8 TV Input key**
Use when in TV operation.
- 9 TV VOL +/- keys**
Use to adjust the TV's volume.
- 10 \lll/\ggg keys**
If CD, MD or Tape is selected as the input source, this key functions as search keys.
Tune - / + keys - [27]
Use to operate the tuner mode.
- 11 II key**
Use to operate other components.
Dimmer key
Use to select the REC MODE. - [26]
Use to adjust the brightness of the display. - [36]
- 12 \triangleright/II key**
If CD is selected as the input source, this key functions as the play/pause key.
If MD or TAPE key is selected as input source, this key functions as the play key.
Band key - [27]
Use to select the broadcast band.
- 13 \triangleleft key**
If Tape is selected, this key functions as reverse play key.
Info/Flip key
Use to operate other components.
- 14 Listen Mode $\blacktriangle/\blacktriangledown$ keys** - [34]
Use to select the listening mode.
- 15 DSP Mode key** - [34]
Use to select any of the DSP mode.
- 16 Active EQ key** - [24]
Use to select ACTIVE EQ's setting.
- 17 THX key** - [34]
Use to switch the status of THX.
- 18 Stereo key** - [34]
Use to switch the listen mode to STEREO.
- 19 LCD (Liquid Crystal Display)**
- 20 TV key**
Use to select the TV equipment.
- 21 POWER RCVR (receiver) key** - [19]
Use to turn the receiver on or off.
- 22 TV Power key**
Use to turn the TV on or off.
- 23 +100 key**
Use to select the disc number with the multi-CD player.
TV Mute key
Use to temporarily mute the TV sound.
- 24 Page $\blacktriangle/\blacktriangledown$ keys**
Use to operate the DVD component.
RDS Disp. key - [29]
Use to receive RDS broadcast.
PTY key - [30]
Use for PTY search.

- 25 OSD (on screen display) key**
Use to operate the DVD component.
Guide key
Use to operate other components.
- 26 Menu key**
Use to operate other key components.
- 27 Mute key** - [24]
Use to temporarily mute the sound. - [24]
- 28 Tone key** - [24]
Use to switch the status of TONE control.
Sound key - [36]
Use to adjust the sound quality and the ambience effects.
- 29 VOL +/- keys** - [23]
Use to adjust the receiver's volume.
- 30 Bass Boost key** - [24]
Use to select the maximum adjustment setting for the low frequency range.
- 31 \bullet key**
If MD or Tape is selected, this key functions as record key.
If VCR is selected, this key functions as record key when it pressed twice sequentially.
Top Menu key
Use to operate the DVD component.
Setup key - [19]
Use to select the speakers' settings etc.
- 32 Loudness key** - [24]
Use to switch the status of LOUDNESS.
- 33 Speaker EQ key** - [24]
Use to select SPEAKER EQ's setting.
- 34 \blacksquare key**
If CD, MD, or TAPE is selected as the input source, this key functions as the stop key.
Auto key - [27]
Use to select the auto or manual tuning mode.
- 35 Learn key** - [39]
Use to register other components. - [41]
Use to memorize the operation of the other remote controls. - [8]
- 36 Input Mode key** - [8]
Use to switch between the full auto, digital and analog inputs.

Setting up the system

Make connections as shown in the following pages. When connecting the related system components, be sure to refer to the instruction manuals supplied with the components you are connecting. Do not connect the power cord to a wall outlet until all connections are completed.

Notes

1. Be sure to insert all connection cords securely. If their connections are imperfect, sound may not be produced or there will be noise interference.
2. Be sure to remove the power cord from the AC outlet before plugging or unplugging any connection cords. Plugging/unplugging connection cords without disconnecting the power cord can cause malfunctions and may damage the unit.
3. Do not connect power cords from components whose power consumption is larger than what is indicated on the AC outlet at the rear of this unit.

Analog connections

Audio connections are made using RCA pin cords. These cables transfer stereo audio signal in an "analog" form. This means the audio signal corresponds to the actual audio of two channels. These cables usually have 2 plugs on each end, one red for the right channel and one white for the left channel. These cables are usually packed together with the source unit, or are available at your local electronics retailer.

Microcomputer malfunction

If operation is not possible or an erroneous display appears, even though all connections have been made properly, reset the microcomputer referring to "In case of difficulty". - 50

Input mode settings

CD/DVD, VIDEO 2, VIDEO 3 and DVD/6CH inputs each include jacks for digital audio input and analog audio input.

The initial factory settings for audio signal playback for CD/DVD, DVD/6CH and VIDEO 2 and VIDEO 3.

After completing connections and turning on the receiver, follow the steps below.

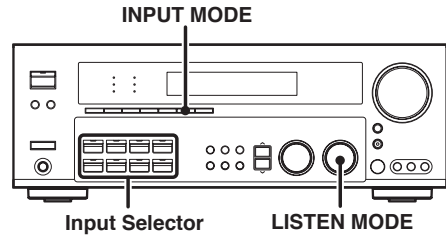

1 Use the Input Selector keys to select CD/DVD, VIDEO 2, VIDEO 3 or DVD/6CH.

2 Press the INPUT MODE key.

Each press switches the setting as follows:

In DTS play mode

- 1 FULL AUTO (digital input, analog input)
- 2 DIGITAL MANUAL (digital input)

In CD/DVD, VIDEO 2, VIDEO 3 or DVD/6CH play mode

- 1 FULL AUTO (digital input, analog input)
- 2 DIGITAL MANUAL (digital input)
- 3 6CH INPUT (DVD/6CH input)
- 4 ANALOG (analog input)

Digital input:

Select this setting to play digital signals from a DVD, CD, or LD player.

Analog input:

Select this setting to play analog signals from a cassette deck, VCR, or record player.

Auto detect:

In "FULL AUTO" mode (AUTO DETECT indicator light up), the receiver detects the digital or analog input signals automatically. Priority is given to digital signal during input mode selection. The receiver will select the input mode and listening mode automatically during playback to match the type of input signal (Dolby Digital, PCM, DTS) and the speaker setting. The OPTICAL and COAXIAL indicator on the display will light up when digital signal is detected. If the input signal is analog, the ANALOG indicator will light up.

To keep the receiver set to the currently selected listening mode, use the INPUT MODE key to select "DIGITAL MANUAL" (manual sound). However, even when this setting is selected, there may be cases in which the listening mode is selected automatically to match a Dolby Digital source signal depending on the combination of listening mode and source signal.

At DIGITAL MANUAL, if the audio reproduction stops in the middle due to change in the input signals, etc. press the LISTEN MODE knob.

If the INPUT MODE key is pressed quickly, sound may not be produced. Press the INPUT MODE key again.

Connecting the terminals

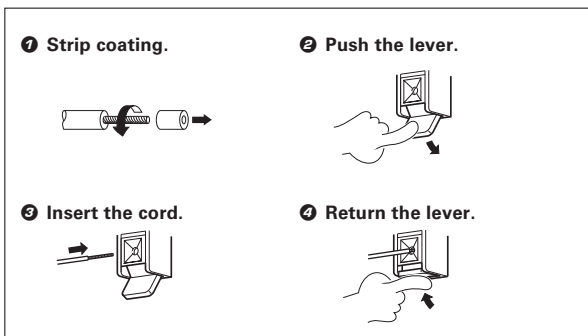
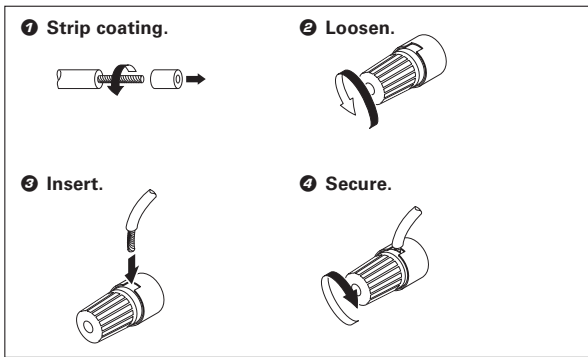

- Never short circuit the + and – speaker cords.
- If the left and right speakers are connected inversely or the speaker cords are connected with reversed polarity, the sound will be unnatural with ambiguous acoustic imaging. Be sure to connect the speakers correctly.

Speaker impedance

After confirming the speaker impedance indications printed on the rear panel of the receiver, connect speakers with matching impedance ratings. Using speakers with a rated impedance other than that indicated on the rear panel of the receiver could result in malfunctions or damage to the speakers or receiver.

Speaker placement

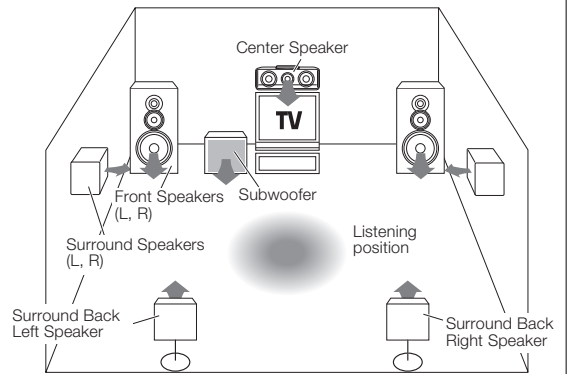

Front (Left and Right) Speakers

Place at the front left and right of the listening position. Front speakers are required for all surround modes.

Center Speaker

Place front and center. This speaker stabilizes the sound image and helps recreate sound motion. Required for surround playback.

Surround (Left and Right) Speakers

Place at the direct left and right, or slightly behind, the listening position at even heights, approximately 1 meter above the ears of the listeners. These speakers recreate sound motion and atmosphere. Required for surround playback.

Subwoofer

Reproduces powerful deep bass sounds.

Surround Back (Left and Right) Speakers

Place the speakers directly at the rear of the listening position. The optimum position depends mainly on the room condition.

- Although the ideal surround system consists of all the speakers listed above, if you don't have a Center Speaker or a Subwoofer, you can divide those signals between the available speakers in the speaker settings steps to obtain the best possible surround reproduction from the speakers you have available. 

Connecting audio components

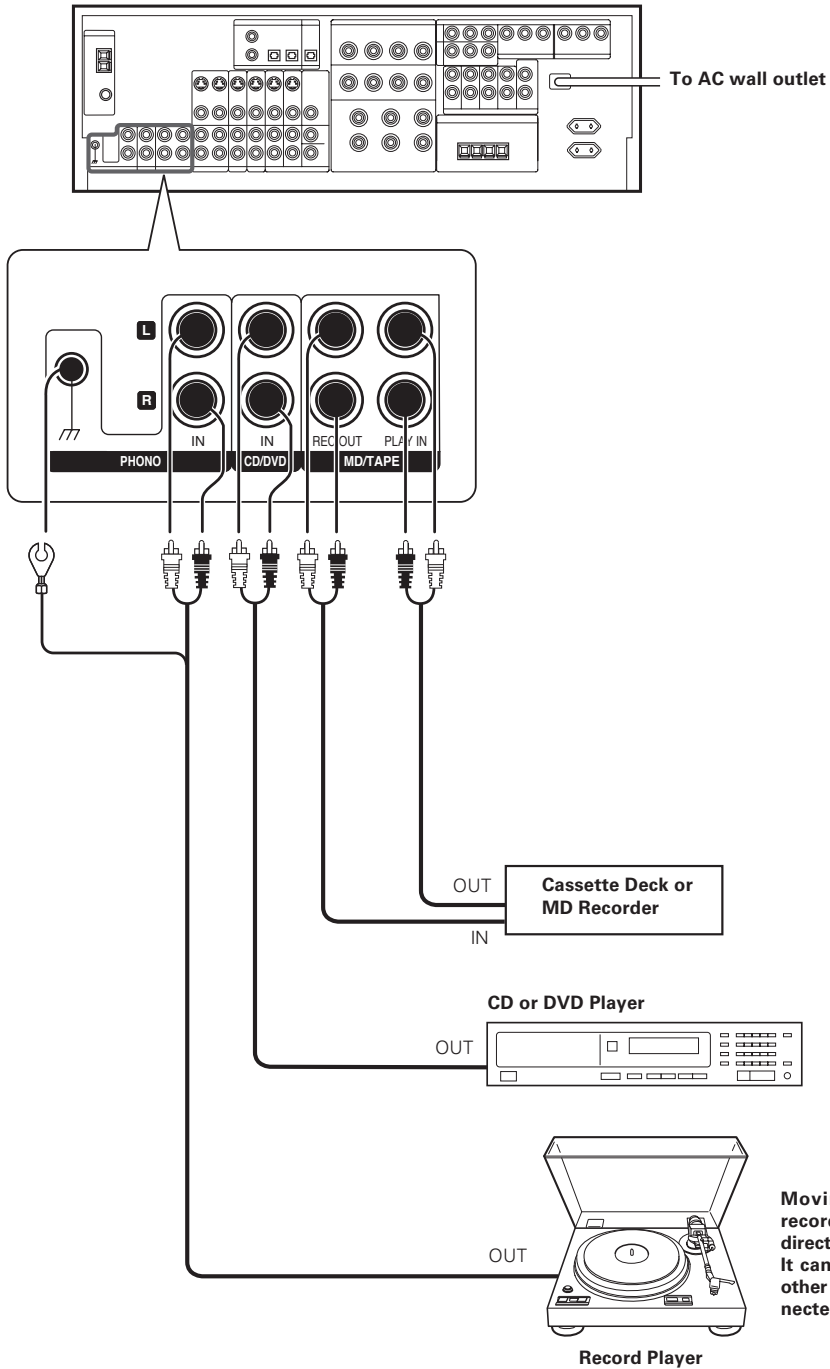

Moving coil (MC) cartridge record player cannot be used directly from the receiver unit. It can only be used when another equalizer amplifier is connected.

CAUTION

Be sure to adhere to the following, or proper ventilation will be blocked causing damage or fire hazard.

- Do not place any objects impairing heat radiation onto the top of the unit.
- Leave some space around the unit (from the largest outside dimension including projection) equal to or greater than, shown below.

Top panel : 50 cm

Side panel : 10 cm

Back panel : 10 cm

Connecting video components

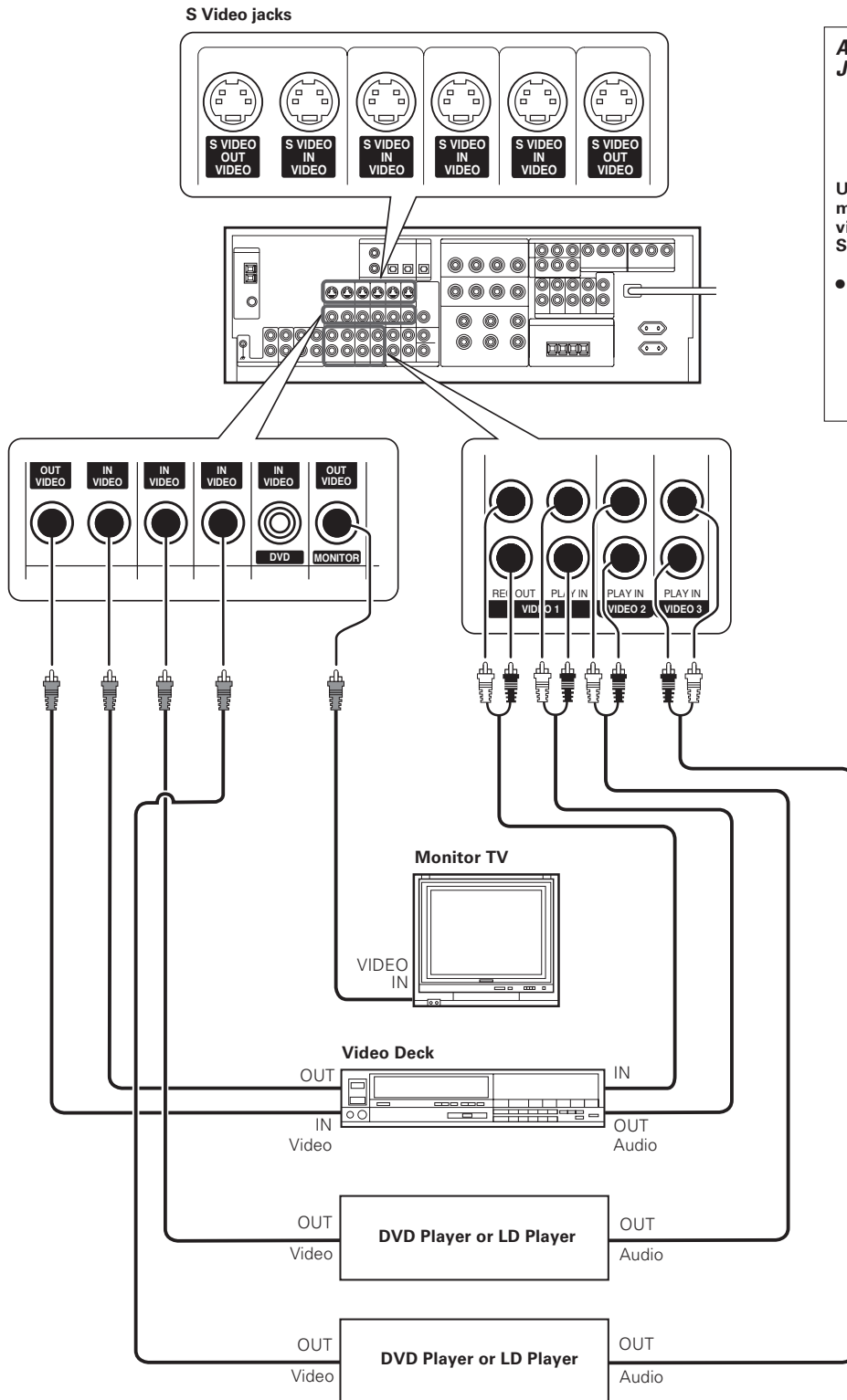

About the S VIDEO Jacks

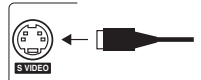

Use the S VIDEO Jacks to make connections to video components with S VIDEO IN/OUT Jacks.

- If you use the S VIDEO jacks to connect your video playback components, be sure to use the S VIDEO jacks when connecting your monitor and video recording components.

A video component with digital audio outputs should be connected to the VIDEO 2 or VIDEO 3 jacks.

Digital connections

The digital in jacks can accept DTS, Dolby Digital, or PCM signals. Connect components capable of outputting DTS, Dolby Digital, or standard PCM (CD) format digital signals.

If you have connected any digital components to the receiver, be sure to read the "Input mode settings" section carefully.



ENGLISH

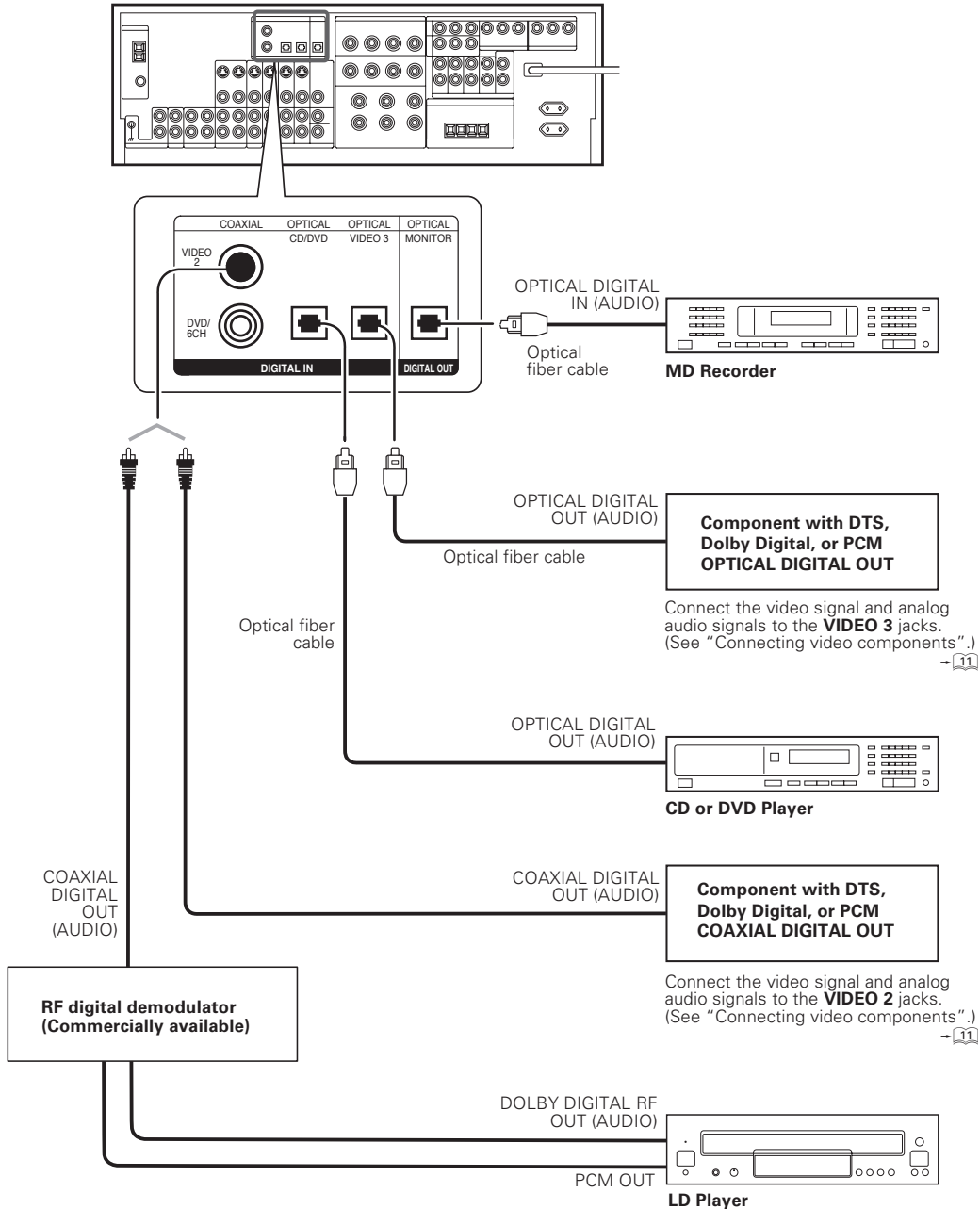

Component with DTS, Dolby Digital, or PCM OPTICAL DIGITAL OUT

Connect the video signal and analog audio signals to the **VIDEO 3** jacks. (See "Connecting video components".)

CD or DVD Player

Component with DTS, Dolby Digital, or PCM COAXIAL DIGITAL OUT

Connect the video signal and analog audio signals to the **VIDEO 2** jacks. (See "Connecting video components".)

LD Player

To connect an LD player with a DIGITAL RF OUT, connect the LD player to a RF digital demodulator (commercially available). Next, connect the DIGITAL OUT jacks of the demodulator to the DIGITAL IN jacks of the receiver. Connect the video signal and analog audio signals to the VIDEO 2 or VIDEO 3 jacks. (See "Connecting video components".)

Connecting video components (COMPONENT VIDEO)

If you have connected the receiver to a video component with COMPONENT jacks, you can get a better picture quality than by connecting to the S-VIDEO jacks.

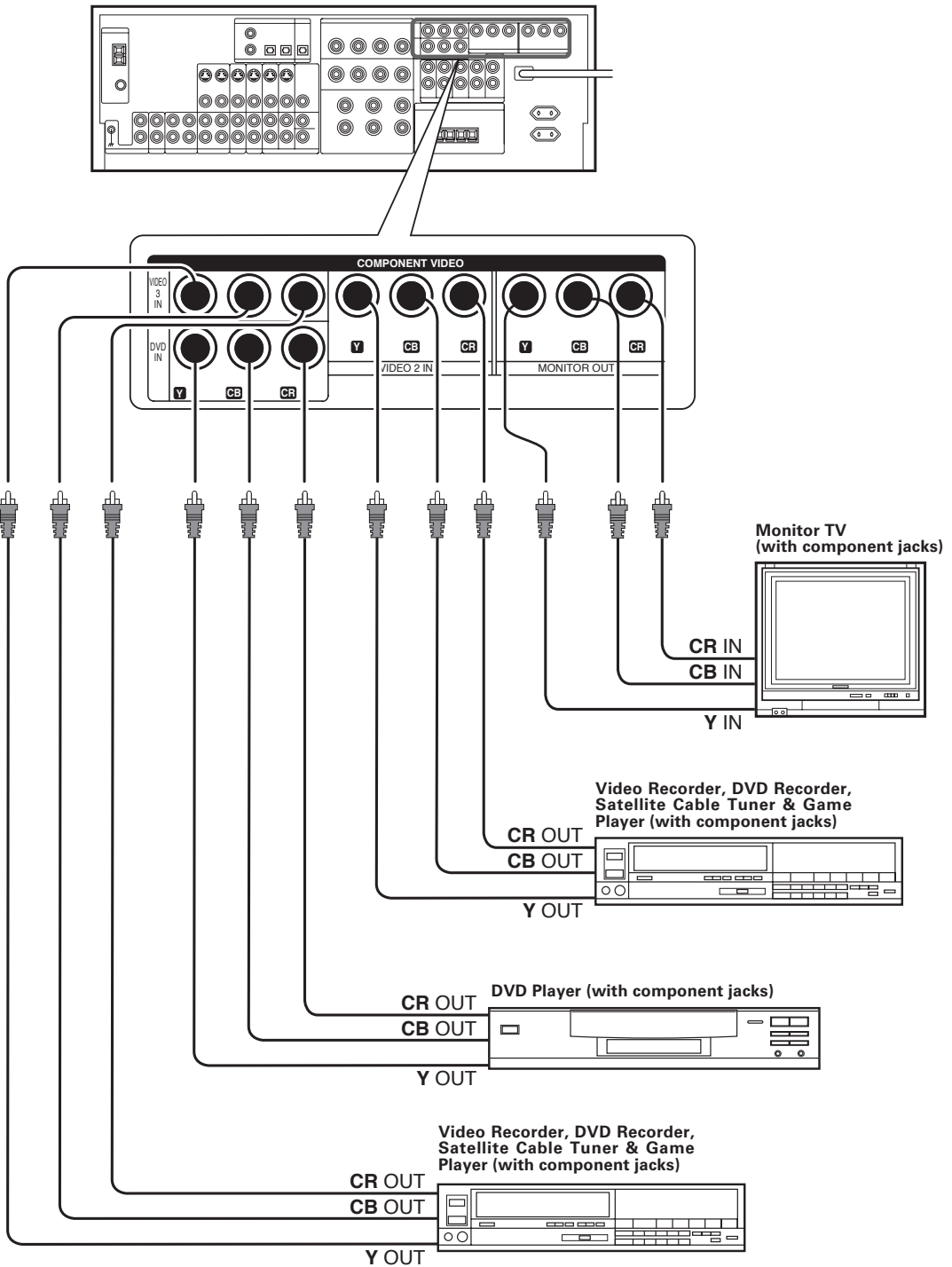

When connecting the TV to the COMPONENT jacks, be sure to connect all the other components to the COMPONENT jacks.

Connecting a DVD player (6-channel input)

If you have connected a DVD player to the receiver with digital connection, be sure to read the "Input mode settings" section carefully.



ENGLISH

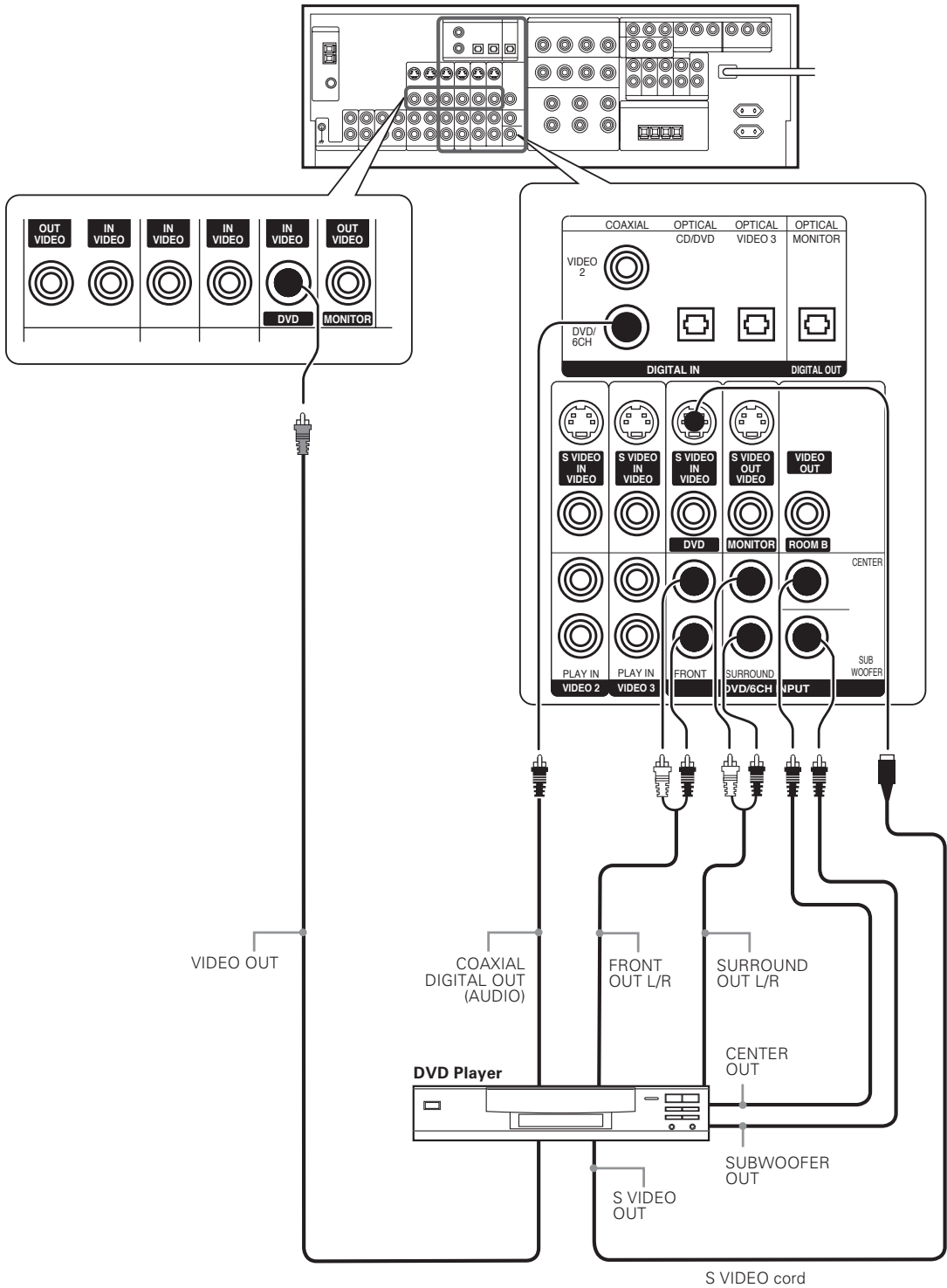

Connecting the speakers

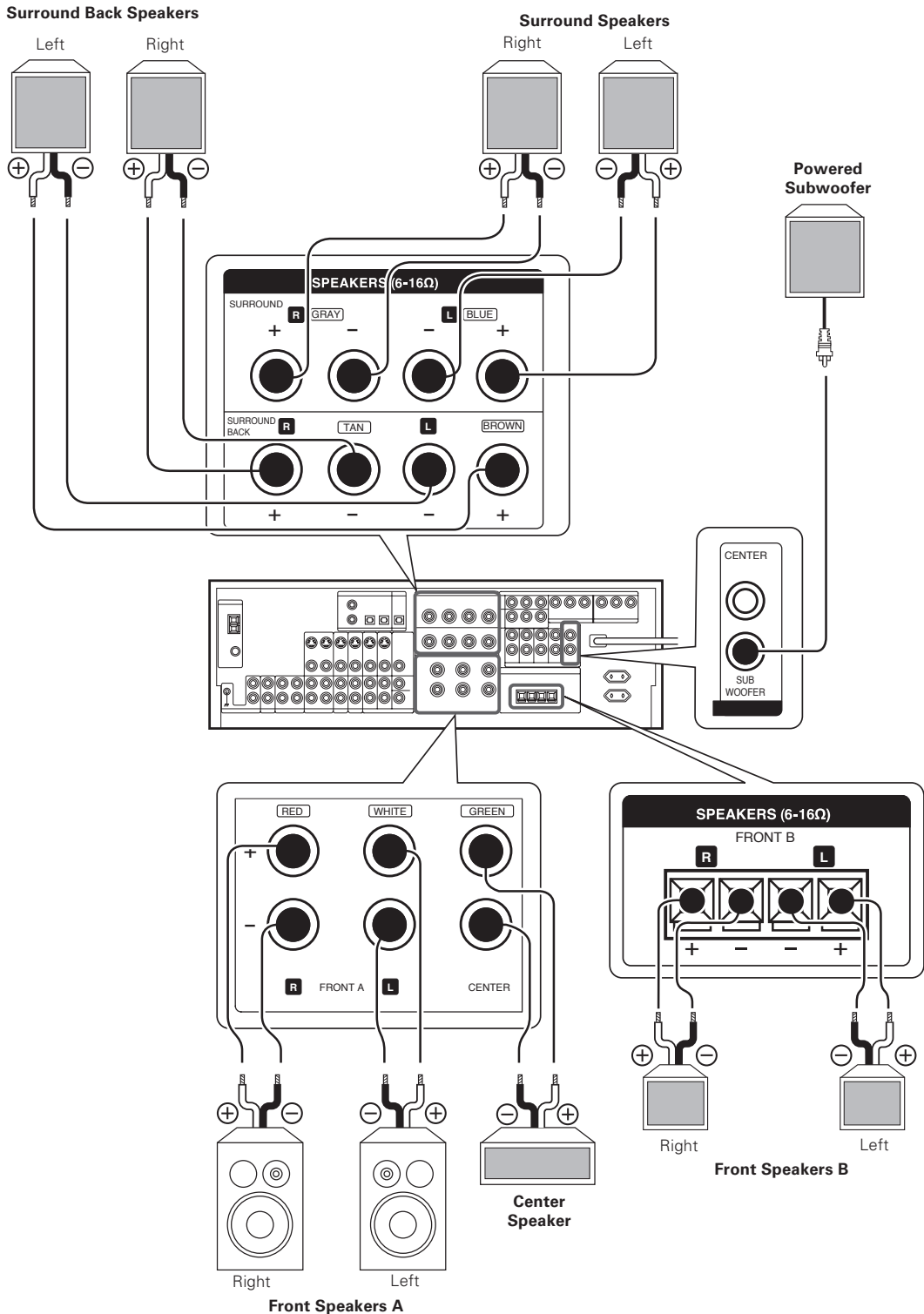

- To make sure that each speaker has been connected properly, pay attention to the test tone from each speaker. Refer to "Adjust the speaker volume level."
- This model is designed on the assumption that a pair of Surround Back Speakers is connected. When use only one Surround Back Speaker, connect it with either speaker terminal of "SURROUND BACK L" or "SURROUND BACK R" and increase the volume level of the test tone by 3 dB for the channel which has been connected.

PRE OUT connections

This receiver has additional **PRE OUT** jacks. These can be used for various purposes, but will need to be connected to an external power amplifier as shown in the example below.

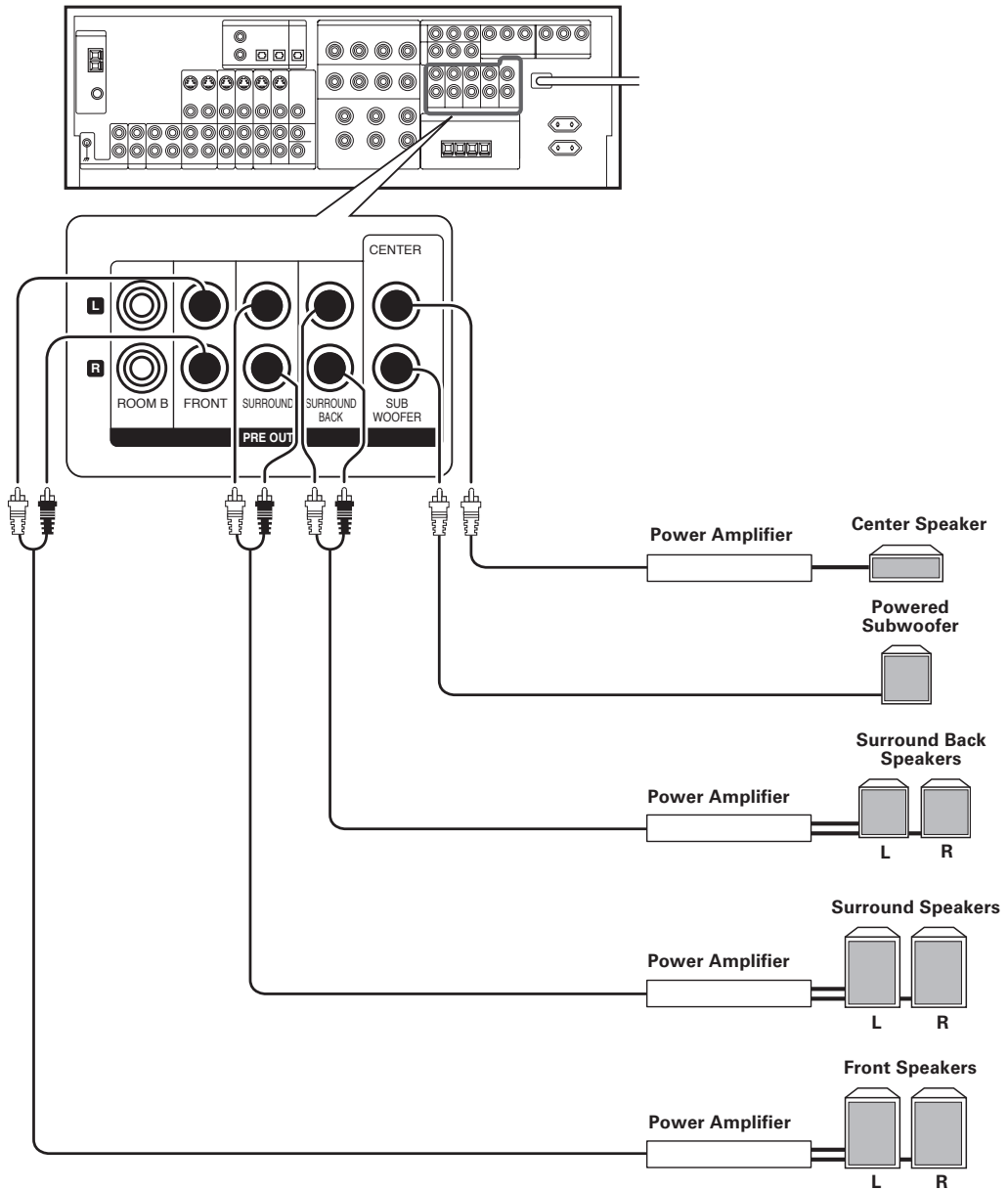

- Connecting a speaker cord directly to a **PRE OUT** jack will not produce any sound from the speaker.
- To use the **PRE OUT** jacks, press only the **SPEAKERS A** key to the ON position.
- This model is designed on the assumption that a pair of Surround Back Speakers is connected.
When use only one Surround Back Speaker, connect it with either speaker terminal of "**SURROUND BACK L**" or "**SURROUND BACK R**" and increase the volume level of the test tone by 3 dB for the channel which has been connected. → [20]
- In this case, when "**Dolby PRO LOGIC IIx**" is selected at **LISTEN MODE**, sound is output at the connected channel only.

Connecting to another room (ROOM B)

This connection allows you to connect your main system to a monitor TV and speaker system located in another area (ROOM B).

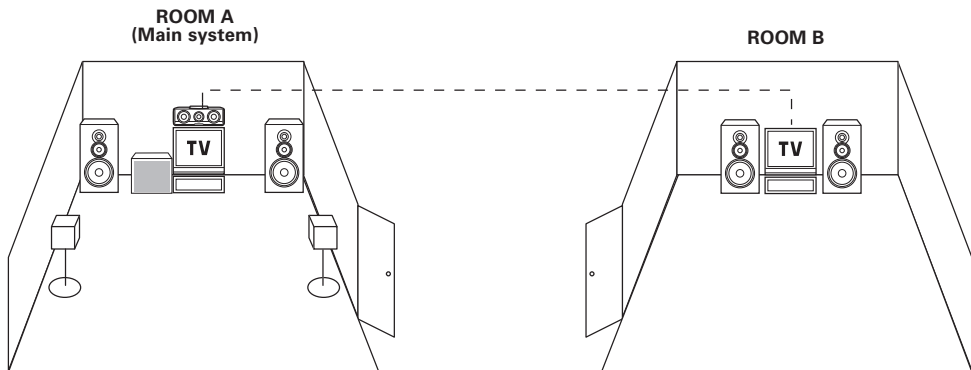
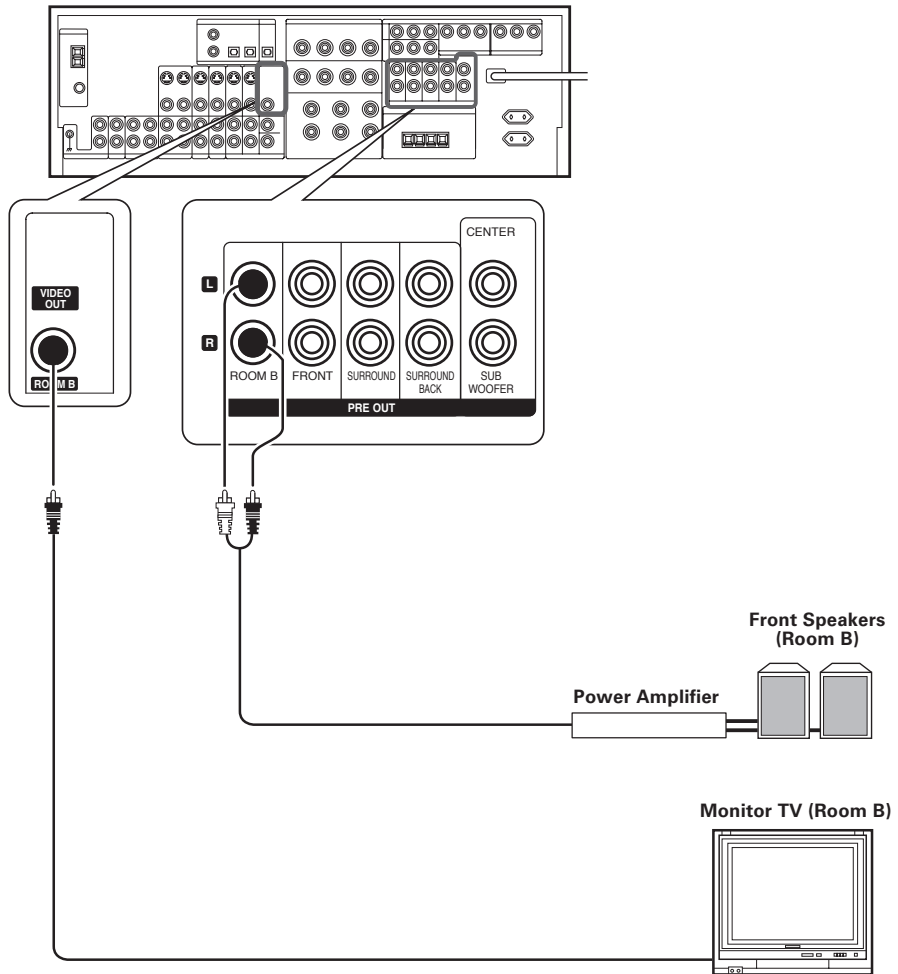

The sound from ROOM B PRE OUT jacks is the same as that of the Front Speakers. When listening in another room (ROOM B), set the LISTEN mode to STEREO. 

Connecting to the AV AUX jacks

The **AV AUX** jacks are convenient for connection of video components such as a camcorder or a video game.

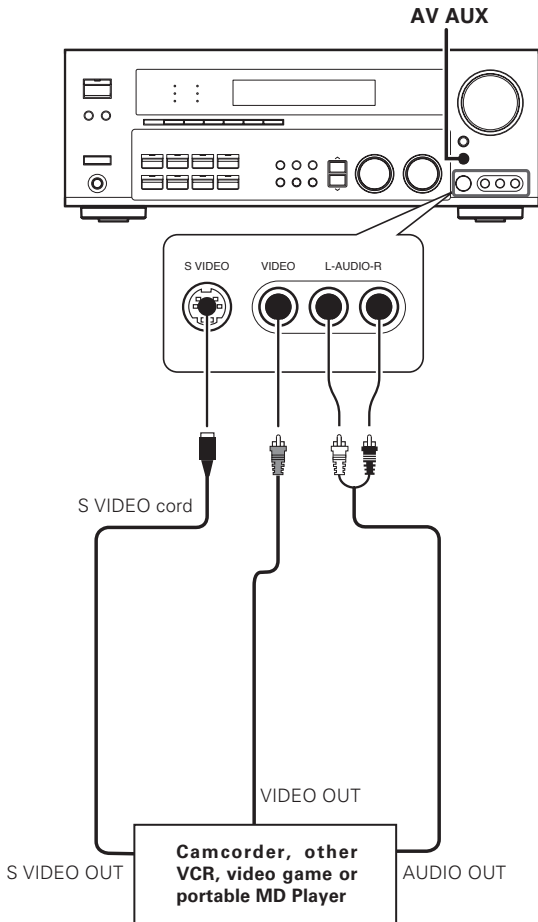

- To select the source connected to the AV AUX jacks press **AV AUX** key.
- When you connect the audio source such as the MD player, you do not need to connect the video cable.
- When you connect the unit and the component with the **S VIDEO** cord, you can enjoy better picture quality.

Connecting the antennas

The broadcast reception cannot be made unless the antennas are connected. Connect the antennas correctly as instructed below.

AM loop antenna

Place the supplied loop antenna as far as possible from the receiver, TV set, speaker cords and power cord, and adjust the direction for best reception.

AM antenna terminal connections

- 1 Push lever.
- 2 Insert cord.
- 3 Release lever.

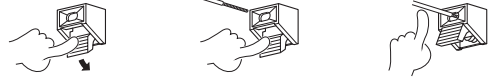

FM indoor antenna

The supplied indoor antenna is for temporary use only. For stable signal reception we recommend using an outdoor antenna. Disconnect the indoor antenna when you connect one outdoors.

FM antenna terminal connections

Insert cord.



FM outdoor antenna

Lead the 75Ω coaxial cable connected to the FM outdoor antenna into the room and connect it to the **FM 75Ω** terminal.

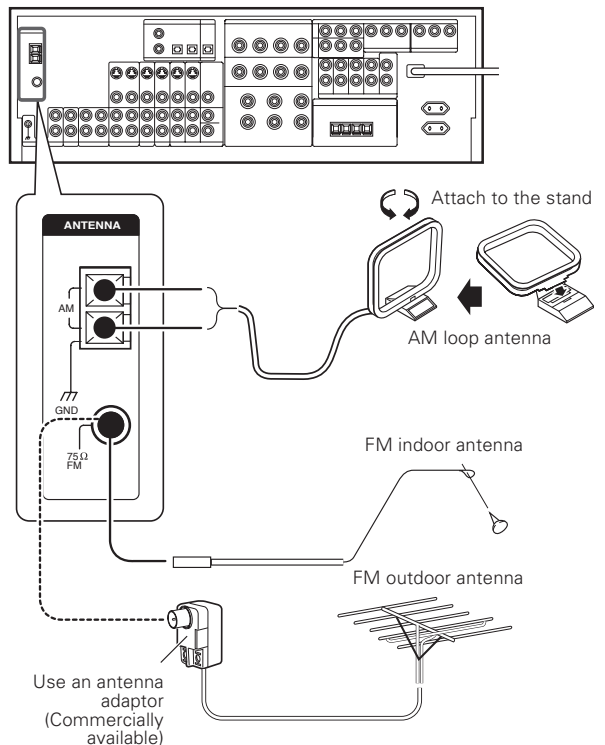

Preparing for surround sound

Speaker settings

To enable you to obtain optimum enjoyment from the receiver's listening modes, make sure to complete the speaker settings (Subwoofer, Front, Center, and Surround Speakers) as described below.

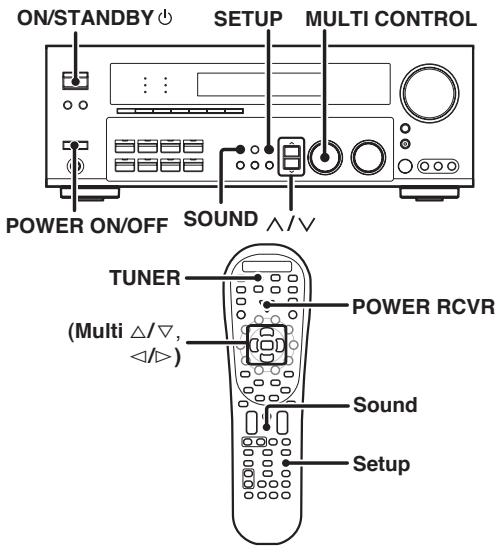

1 Turn on the power to this receiver by pressing the **POWER ON/OFF** and **ON/STANDBY** key or **POWER RCVR** key.

2 For the remote control, press and hold the **TUNER** key for more than 3 seconds to switch to receiver mode.

3 Press the **SETUP** key to enter the **SETUP** mode.

Use Δ/∇ keys or $\triangleleft/\triangleright$ keys for the following displays.

- ① SP SETUP
- ② TEST TONE
- ③ BASS PEAK
- ④ SP DISTANCE
- ⑤ LFE LEVEL
- ⑥ DISP MODE
- ⑦ EXIT

The flow of the SETUP is as follows:

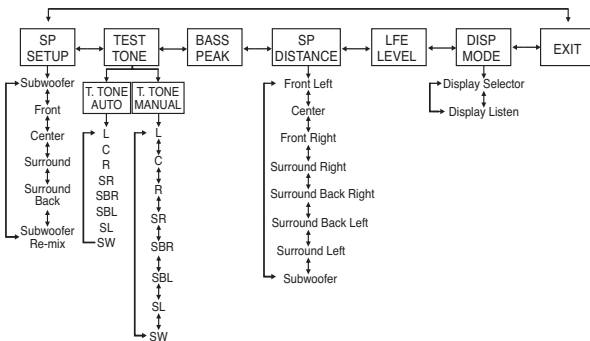

4 Select a speaker system.

If you have THX certified speakers, please set them to NML/THX.

1 Select the **SP SETUP** and press the **SETUP** key again so that the Subwoofer setting indication "SUBW ON" appears.



2 Use the **MULTI CONTROL** knob or **Multi** (Δ/∇) keys to select the appropriate Subwoofer setting.

- ① **SUBW ON** : Subwoofer setting mode to the receiver is ON.
- ② **SUBW OFF** : Subwoofer setting mode to the receiver is OFF.

- The initial setting is "SUBW ON".
- When the setting "SUBW OFF" is selected, the Front Speakers are automatically set to "FRNT LARGE" and the procedure skips to step 4.
- Before step 4, press the **SETUP** key to accept the setting.
- When Subwoofer output sound is required, select "FRNT NML/THX", or select both "FRNT LARGE" and "SW RE-MIX ON".

3 Press the Δ key or \triangleright key to accept the setting.

- The Front Speakers setting indication "FRNT" appears.



4 Use the **MULTI CONTROL** knob or **Multi** (Δ/∇) keys to select the appropriate Front Speakers setting.

- ① **FRNT NML/THX** : Average size Front Speakers are connected to the receiver.
- ② **FRNT LARGE** : Large Front Speakers are connected to the receiver.

- For "FRNT LARGE" selection, no sound will be heard from Subwoofer even when it is set to on. However, if you select "SW RE-MIX ON" when Subwoofer is selected, you will be able to hear sound from the Subwoofer.
- When in STEREO mode, the sound goes directly to Front Speaker.

5 Press the Δ key or \triangleright key to accept the setting.

- The Center Speaker setting indication "CNTR" appears.

6 Use the **MULTI CONTROL** knob or **Multi** (Δ/∇) keys to select the appropriate Center Speaker setting.

- If you selected "LARGE" as the Front Speakers setting,
- ① **CNTR NML/THX** : An average size Center Speaker is connected to the receiver.
 - ② **CNTR LARGE** : A large Center Speaker is connected to the receiver.
 - ③ **CNTR OFF** : Center Speaker setting mode to the receiver is OFF.

- If you selected "NML/THX" as the Front Speakers setting,
- ① **CNTR NML/THX** : An average size Center Speaker is connected to the receiver.
 - ② **CNTR OFF** : Center Speaker setting mode to the receiver is OFF.

Continued to next page.

- 7 Press the **Λ** key or **▷** key again to accept the setting.
 - The Surround Speaker indication "SURR" appears.

- 8 Use the **MULTI CONTROL knob** or **Multi (Δ/▽)** keys to select the appropriate Surround Speaker setting.

If you selected "LARGE" as the Center Speaker setting,

- ① **SURR NML/THX** : Average size Surround Speakers are connected to the receiver.
- ② **SURR LARGE** : Large Surround Speakers are connected to the receiver.
- ③ **SURR OFF** : Surround Speaker setting mode to the receiver is OFF.

If you selected other than "LARGE" as the Center Speaker setting,

- ① **SURR NML/THX** : Average size Surround Speakers are connected to the receiver.
- ② **SURR OFF** : Surround Speaker setting mode to the receiver is OFF.

- When the setting "SURR OFF" is selected, you may skip to step 11.

- 9 Press the **Λ** key or **▷** key again to accept the setting.
 - The Surround Speaker setting indication "SB" appears.

- 10 Use the **MULTI CONTROL knob** or **Multi (Δ/▽)** keys to select appropriate Surround Back Speaker setting.

If you selected "LARGE" as the Surround Speaker setting,

- ① **SB NML/THX** : Average size Surround Back Speaker is connected to the receiver.
- ② **SB LARGE** : Large Surround Back Speaker is connected to the receiver.
- ③ **SB OFF** : Surround Back Speaker setting mode to the receiver is OFF.



If you selected "NML/THX" as the Surround Speaker setting,

- ① **SB NML/THX** : Average size Surround Back Speaker is connected to the receiver.
- ② **SB OFF** : Surround Back Speaker setting mode to the receiver is OFF.

- 11 Press the **Λ** key or **▷** key again to accept the setting.
 - The Subwoofer re-mix setting indication "SW RE-MIX" appears.

- 12 Use the **MULTI CONTROL knob** or **Multi (Δ/▽)** keys to select the appropriate Subwoofer re-mix setting.

- ① **SW RE-MIX ON** : Subwoofer re-mix setting mode to the receiver is ON.
- ② **SW RE-MIX OFF** : Subwoofer re-mix setting mode to the receiver is OFF.

- If subwoofer is turned off, subwoofer re-mix setting is not visible.

- 13 Press the **SETUP** key again to return to the main setup displays.

5 Adjust the speaker volume level.

From your usual listening position, adjust the volume levels. The volume levels from each speaker should be the same.

- The receiver enters the speaker volume level adjustment mode.
- Indicators appear only for the channels of the speakers selected in step 4.

Be aware that the TEST TONE is quite a loud sound (0dB).

- 1 Press the **Λ/v** keys or **◀/▷** keys to select TEST TONE.

- 2 Press the **SETUP** key for the following displays:

- ① **T.TONE AUTO**
- ② **T.TONE MANUAL**

- 3 The selection of AUTO/MANUAL TEST TONE is done by the **MULTI CONTROL knob** or **Multi (Δ/▽)** keys. Press the **SETUP** key again to begin TEST TONE.

Use the **MULTI CONTROL knob** or **Multi (Δ/▽)** keys to adjust the volume level of the test tone output from the speaker channel to be adjusted.

For AUTO selection, the first test tone is heard from the Front Left Speaker for 2.5 seconds. The next test tone is heard from the speakers in the following sequence for 2 seconds each.

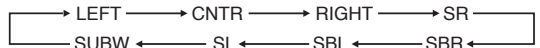

The channel indication blinks while the test tone is being output.



- If you change the volume level settings for the speakers while listening to music, the settings referred to on this page are also changed.
- If the speaker setting selects are OFF, the speaker level settings are reset.

For MANUAL selection, press the **Λ/v** keys or **◀/▷** keys each time to select the speaker channel.

- 4 Press the **SETUP** key again.

- The test tone is turned off and return to the main setup displays.

6 Adjust the bass peak level.

A restriction is put on the low frequency so that the bass peak level will not go higher than the acceptable level when the volume is increased.

If Subwoofer is OFF, the limitation will affect the low frequency of the Front Left and Right Speakers.

- 1 Press the **Λ/v** keys or **◀/▷** keys to select BASS PEAK and press the **SETUP** key.

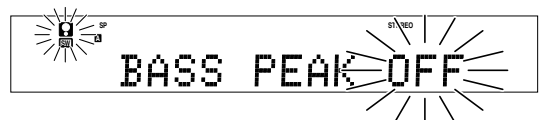

- 2 Use the **MULTI CONTROL knob** or **Multi (Δ/▽)** keys to adjust the bass peak level to -30dB.

- The adjustment range is from -30dB and OFF.

- 6 For optimum bass peak level, keep increasing the bass peak level by using the MULTI CONTROL knob or Multi (Δ/∇) keys while test tone is being output until clip sound is heard from the Subwoofer or Front Speaker.

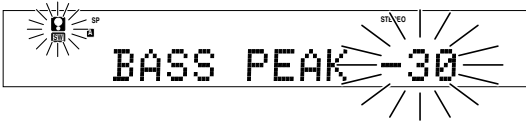

- 4 Press the SETUP key to accept the setting.

7 Input the distance to the speakers.

- Indicators appear only for the channels of the speakers selected in step 4.

- 1 Press the Δ/∇ keys or \leftarrow/\rightarrow keys to select the SP DISTANCE on setup displays and press the SETUP key again.
- 2 Measure the distance from the listening position to each of the speakers.

Not down the distance to each of the speakers.

- Distance to Front Left Speaker (L) : ___ feet (meters)
- Distance to Center Speaker (C) : ___ feet (meters)
- Distance to Front Right Speaker (R) : ___ feet (meters)
- Distance to Surround Right Speaker (SR) : ___ feet (meters)
- Distance to Surround Back Right Speaker(SBR) : ___ feet (meters)
- Distance to Surround Back Left Speaker (SBL) : ___ feet (meters)
- Distance to Surround Left Speaker (SL) : ___ feet (meters)
- Distance to Subwoofer (SW) : ___ feet (meters)

- 3 Use the Δ/∇ keys or \leftarrow/\rightarrow keys to select the speakers and the MULTI CONTROL knob or Multi (Δ/∇) keys to adjust the distance to the Front Speakers.

The speaker indicator to be adjusted blinks.

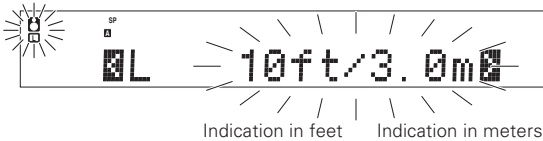

- The allowable setting range is 1 to 30 feet (0.3 to 9.0 m), adjustable in 1 foot (0.3 m) increments.

- 4 Repeat steps 3 to input the distance for each of the speakers.
- 5 Press the SETUP key again to return to main setup displays.
 - The speakers you have selected should appear on the display. Confirm that all the speakers have been correctly selected.

8 Adjust the LFE LEVEL (Low Frequency Effects).

- 1 Press the Δ/∇ keys or \leftarrow/\rightarrow keys to select the LFE LEVEL and press the SETUP key.
- 2 Use the MULTI CONTROL knob or Multi (Δ/∇) keys to adjust the LFE LEVEL.



- 3 Press the SETUP key again to return to main setup displays.

9 Select the display mode.

- 1 Press the Δ/∇ keys or \leftarrow/\rightarrow keys to select the DISP MODE.
- 2 Press the SETUP key for the following displays:
 - 1 DISP SELECTOR : Displays the current input selector.
 - 2 DISP LISTEN : Displays the current listen mode.

- 3 Use the MULTI CONTROL knob or Multi (Δ/∇) keys to select the display mode.



- 4 Press the SETUP key again to accept the setting.

- 5 Use the Δ key or \rightarrow key to select EXIT.



- 6 Press the SETUP key to exit the SETUP mode.

Input level adjustment (analog sources only)

If the input level of an analog source signal is too high, the **CLIP** indicator will light up to indicate the source signal. Adjust the input level.

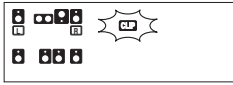

1 Use the Input Selector keys to select the source of which the input level you want to adjust.

- You can store a separate input level for each input source.

2 Press the **SOUND** and **▲/▼** keys or **</>** keys repeatedly until the "INPUT" indication appears.

3 Use the **MULTI CONTROL** knob or **Multi (▲/▼)** keys to adjust the input level.

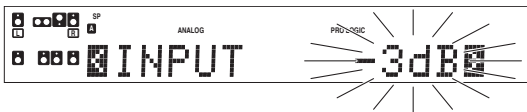

- The adjustment mode is displayed for approximately 20 seconds.
- The input level may be adjusted to any one of three settings: 0dB, -3dB, and -6dB. (The initial setting is 0dB.)

4 Press the **SOUND** key again to return to the input indication.

Normal playback

Preparing for playback

Some preparatory steps are needed before starting playback.

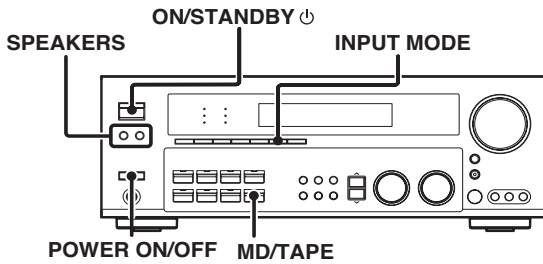

Turning on the receiver

- 1 Turn on the power to the related components.
- 2 Turn on the power to this receiver by pressing the **POWER ON/OFF** and **ON/STANDBY** key.

Selecting the input mode

If you have selected a component connected to the **CD/DVD**, **VIDEO 2**, **VIDEO 3** or **DVD/6CH** jacks, make sure that the input mode setting is correct for the type of audio signal to be used. 

Selecting MD/TAPE

Select the source name corresponding to the component connected to the MD/TAPE jacks. The initial factory setting is "TAPE". To change the source to "MD", follow the steps below:

Hold down the MD/TAPE key for more than 2 seconds.

- The source indication changes to "MD".
- To return to the original indication, repeat the above procedure.

Selecting the speaker system

Press the **SPEAKERS** key to select the speaker system to be used.

- A ON** : Sound from the speakers connected to the **SPEAKERS A** terminals on the rear panel.
- B ON** : Sound from the speakers connected to the **SPEAKERS B** terminals on the rear panel. No sound will be heard from the subwoofer.
- A+B ON** : Sound from both the speakers connected to the **SPEAKERS A** and **B** terminals on the rear panel.
- A+B OFF** : No sound from the speakers. Use this setting when listening with headphones for stereo sound in all playback modes. The display segments are different depending on the type of input signal.

The indicator for the speakers you want to use should be lit.

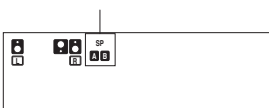

- Selecting "6CH INPUT" by pressing the **INPUT MODE** key, whereby "DVD/6CH" is the input source will cause **SPEAKERS A** to be selected automatically.

Listening to a source component

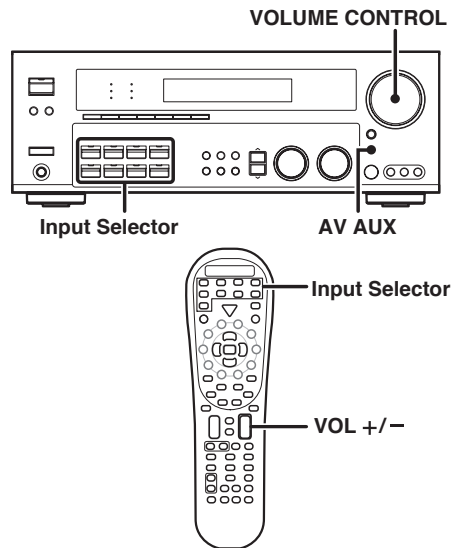

- 1 Use the **Input Selector** and **AV AUX** key to select the source you want to listen to.

Selecting a source using each key.

- 1 "DVD/6CH"
- 2 "CD/DVD"
- 3 "PHONO"
- 4 "TUNER"
- 5 "VIDEO 1"
- 6 "VIDEO 2"
- 7 "VIDEO 3"
- 8 "MD/TAPE"
- 9 "AV AUX"

- 2 Start playback from the selected source.

- 3 Use the **VOLUME CONTROL** knob or **VOL +/-** keys to adjust the volume.

Adjusting the sound

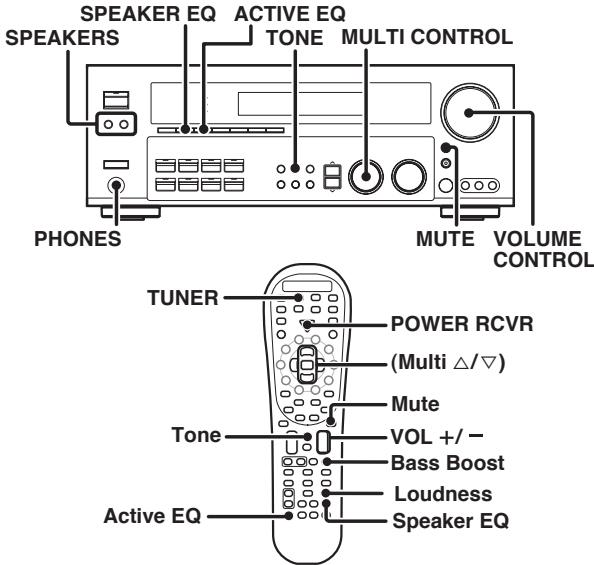

Adjusting the TONE

You can adjust the sound quality when the receiver is in the PCM stereo mode, analog stereo mode and when "THX OFF".

- 1 For the remote control, press and hold the TUNER key for more than 3 seconds to switch to receiver mode.
- 2 Press the TONE key to select the TONE mode.
- 3 Use the MULTI CONTROL knob or Multi (Δ/▽) keys to select TONE ON/OFF.

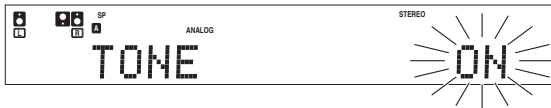

- 4 When in TONE ON selection, press the TONE key for the following displays.

BASS : Select this to adjust the low frequency range.
TREBLE : Select this to adjust the high frequency range.

- 5 Use the MULTI CONTROL knob or Multi (Δ/▽) keys to adjust the sound quality.

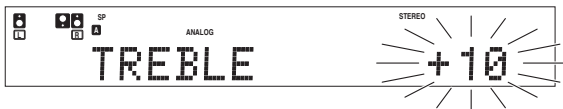

- The bass and treble levels are adjustable from -10 to +10 in 2 step increments.
- The adjustment item is displayed for approximately 20 seconds.
- This function is available only for speakers connected to FRONT A terminals.

Once-touch low frequency emphasis (BASS BOOST) (remote control only)

You can adjust the sound quality when the receiver is in the PCM stereo mode, analog stereo mode and when "THX OFF".

Press the Bass Boost key.

- Press the key once to select the maximum (+10) low frequency emphasis setting.
- This key does not function when the receiver is in the sound quality or ambience effects adjustment mode.
- This function is available only for speakers connected to FRONT A terminals.

Switching back to the previous setting

Press the Bass Boost key again.

Adjusting the LOUDNESS mode (remote control only)

You can adjust the Loudness function which controls the low volume settings to maintain the music's richness. The adjustment can be made when the receiver is in the PCM stereo mode, analog stereo mode and when "THX OFF".

Press the Loudness key to turn the LOUDNESS setting ON.

- This function is available only for speakers connected to FRONT A terminals.

To cancel

Press the Loudness key again so that the "LOUDNESS" indicator goes off.

Muting the sound

The MUTE key lets you mute the sound of the speakers.

Press the MUTE key.

Blinks

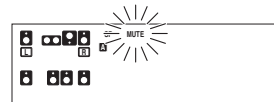

To cancel

Press the MUTE key again so that the "MUTE" indicator goes off.

- MUTE ON can also be deactivated by turning the VOLUME CONTROL knob or pressing VOL +/- keys.

ACTIVE EQ mode

You can enjoy a more impressive sound effect when ACTIVE EQ is turned ON.

Press the ACTIVE EQ key for the following selections;

- 1 **ACTIVE EQ MUSIC** : Effective when listening to music. (The ACTIVE EQ indicator lights up.)
- 2 **ACTIVE EQ CINEMA** : Effective when watching a movie. (The ACTIVE EQ indicator lights up.)
- 3 **ACTIVE EQ TV** : Effective when watching TV. (The ACTIVE EQ indicator lights up.)
- 4 **ACTIVE EQ OFF** : The ACTIVE EQ function is turned OFF. (The ACTIVE EQ indicator goes off.)

- "ACTIVE EQ" will scroll from right to left.
- ACTIVE EQ function will not be available when in REC MODE, or when searching or presetting radio stations.

SPEAKER EQ mode

SPEAKER EQ function is to adjust the receiver's audio output characteristics with the speakers' characteristics which differs depending on the size of the speakers. When activating the SPEAKER EQ function, you will be able to enjoy a more natural and dynamic sound experience even with small size speakers.

Press the SPEAKER EQ key to switch the following setting;

- ➔ ① **SPEAKER EQ SMALL** : To select a small size speaker.
(The SPEAKER EQ indicator lights up.)
- ② **SPEAKER EQ MEDIUM** : To select a medium size speaker.
(The SPEAKER EQ indicator lights up.)
- ③ **SPEAKER EQ OFF** : The SPEAKER EQ function is turned OFF.
(The SPEAKER EQ indicator goes off.)

- "SPEAKER EQ" will scroll from right to left.
- SPEAKER EQ function will not be available when in REC MODE, or when searching or presetting radio stations.
- SPEAKER EQ function will not be available when "LARGE" is selected for Front Speaker at the speaker settings.

Listening with headphones

- ➔ ① Press the A and B Speaker keys so that the speaker indicator goes off.

Make sure the SPEAKERS indicators are turned off.

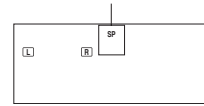

- If you turn off all of the speakers when in surround mode, the surround mode will be cancelled as well, resulting in stereo playback.

- ➔ ② Connect headphones to the PHONES jack.

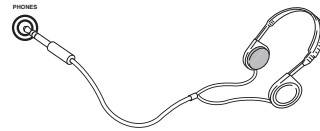

- ➔ ③ Use the VOLUME CONTROL knob or VOL +/- keys to adjust the volume.

Recording

Recording audio (analog sources)

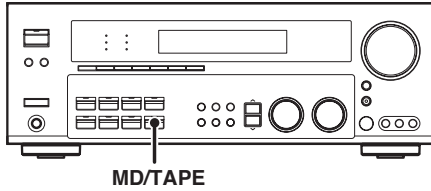

Recording a music source

- 1 Use the Input Selector keys to select the source (other than "MD/TAPE") you want to record.
- 2 Set the MD or TAPE recorder to record.
- 3 Start playback, then start recording.

Recording video

- 1 Use the Input selector keys to select the video source (other than "VIDEO 1") you want to record.
- 2 Set the video deck connected to VIDEO 1 to record.
 - Select the REC mode to record a digital input source.
- 3 Start playback, then start recording.
 - Recording may not be normal for some video software. This is due to the copy guard condition. → 50

Recording audio (digital sources)

Switch on the **REC MODE** to record a digital input source. Usually use the **REC MODE AUTO** to record audio input sources. When the digital mode changes during recording in the **REC MODE AUTO**, the audio input source may be interrupted momentarily.

Recording music in REC MODE AUTO or MANUAL

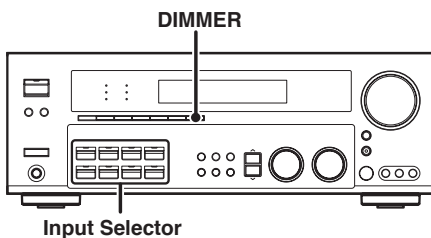

- 1 Use the Input Selector keys to select the source (CD/DVD, DVD/6CH, VIDEO 2, VIDEO 3) you want to record.
- 2 Set the MD or TAPE recorder to record.

- 3 Press and hold the **DIMMER** key for more than 2 seconds to select the **REC MODE AUTO** or **REC MODE MANUAL**.

- 1 **REC MODE off** : The digital input record mode is switched off.
- 2 **REC MODE AUTO** : The digital input signals (DTS, Dolby Digital, or PCM) are identified automatically and converted into stereo signals that are ready for recording.
- 3 **REC MODE MANUAL** : The input signal type at the moment this mode is selected is held throughout this mode.

- When the **REC MODE MANUAL** is selected, the digital input signal is converted to stereo signals (down-mix). But once the digital signal is changed to other signal, no signal is output. When the **REC MODE AUTO** is selected, the digital input signal is converted to stereo signals even if the digital signal is changed.

For **REC MODE AUTO** :

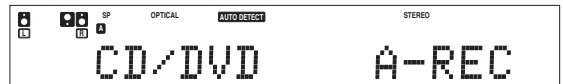

For **REC MODE MANUAL** :



- 4 Start playback, then start recording.
 - If the audio reproduction stops in the middle due to change in the input signals, etc., press the **DIMMER** key.

Listening to radio broadcasts

The receiver can store up to 40 stations in the memory and recall them by one-touch operation.

Radio stations can be classified into RDS (Radio Data System) stations and other stations. To listen to or store RDS stations in the preset memory see "Using RDS (Radio Data System)".

Tuning (non RDS) radio stations

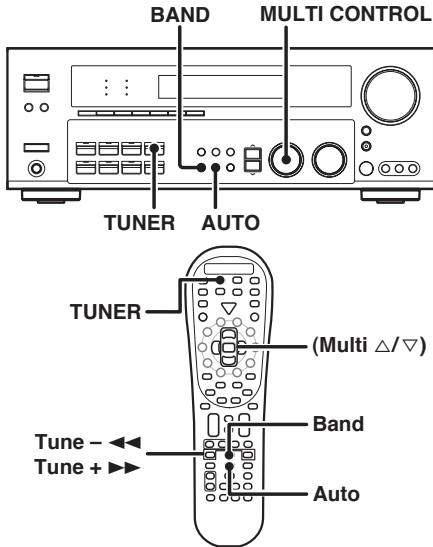

1 Use the **TUNER** key to select the tuner.

2 Use the **BAND** key to select the desired broadcast band.

Each press switches the band.



3 Use the **AUTO** key to select the desired tuning method.

Each press switches the tuning method to either auto or manual tuning.

"AUTO" indicator lights up in the display.

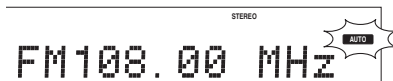

- Normally, set to "AUTO" (auto tuning). If the radio waves are weak and there is a lot of interference, switch to manual tuning. (With manual tuning, stereo broadcasts will be received in monaural.)

4 Use the **MULTI CONTROL knob or Multi (Δ/▽) keys, or Tune - ◀/▶ keys** to select the station.

"STEREO" lights when a broadcast is being received in stereo.

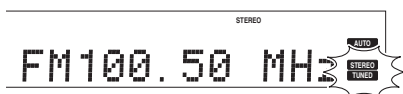

"TUNED" is displayed when a station is received.

Auto tuning : The next station is tuned automatically.

Manual tuning : Turn the knob or use the **Multi (Δ/▽)** keys to select the desired station.

Using RDS (Radio Data System)

RDS is a system that transmits useful information (in the form of digital data) for FM broadcasts along with the broadcast signal. Tuners and receivers designed for RDS reception can extract the information from the broadcast signal for use with various functions, such as automatic display of the station name.

RDS functions:

PTY (Program Type Identification) Search

— 30

Automatically tunes to a station that is currently broadcasting the specified program type (genre).

PS (Program Service Name) Display

Automatically displays the station name transmitted by the RDS station.

RDS AUTO MEMORY function

— 29

Automatically selects and stores up to 40 RDS stations in the preset memory.

If fewer than 40 RDS stations have been stored in the preset memory, regular FM stations will be stored in the remaining places.

Radio Text function

Displays the radio text data transmitted by some RDS stations when you press the **RDS Disp** (display) key. There is "NO RT" if no text data is transmitted.

The "RDS" indicator lights up when an RDS broadcast (signal) is received.

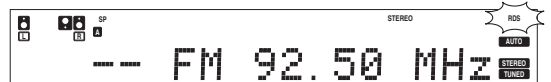

Note

Some functions and function names may differ for certain countries and areas.

Before using a function utilizing the RDS, be sure to perform the RDS Auto Memory operation by referring to the description in "Presetting RDS stations (RDS AUTO MEMORY)".

— 29

Presetting radio stations manually

The RDS auto memory function assigns preset numbers to RDS stations starting from preset number "1". Therefore, be sure to execute the RDS auto memory function before using the following operations to manually store AM stations and other FM stations, and RDS stations. See "Presetting RDS stations (RDS AUTO MEMORY)". → [29]

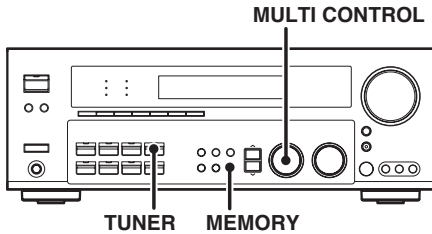

1 Tune to the station you want to store.

2 Press the MEMORY key while receiving the station.

Blinks for 20 seconds

Lights for 20 seconds

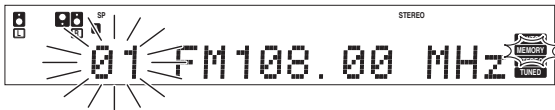

Proceed to step **3** within 20 seconds.
(If more than 20 seconds elapse, press the MEMORY key again).

3 Use the MULTI CONTROL knob or Multi (Δ/▽) keys to select one of the station presets (1 – 40).

4 Press the MEMORY key again to confirm the setting.

- Repeat steps **1**, **2**, **3** and **4** to store as many stations as necessary.
- If you store a station at a previously used preset, the old station will be replaced by the new one.

Receiving preset stations

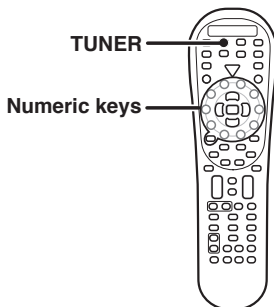

1 Press the TUNER key to select tuner as the source.

2 Enter the number of the preset station you want to receive (up to "40").

Press the numeric keys in the following order:

For "15", press

[+10], [5]

For "20", press

[+10], [+10], [0]

- If you make a mistake entering a two digit number, press the +10 key repeatedly to return to the original display and start again.



Receiving preset stations in order (P.CALL)

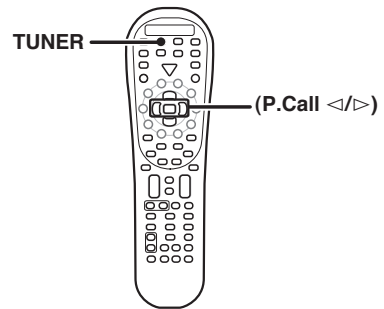

1 Press the TUNER key to select the tuner as the source.

2 Use the P.Call </> keys to select the desired station.

- Each time you press the key, another preset station is received in order.

Pressing the P.Call > does the following:

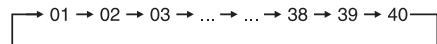

Pressing the P.Call < does the following:

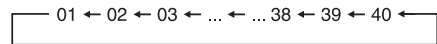

Holding down the > or < key, lets you skip through the presets, receiving each preset station at 0.5 second intervals.

Using the RDS DISP (Display) key

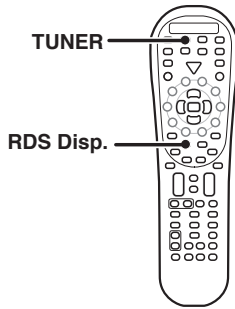

Pressing the RDS Disp. key changes the contents of the display.

Each press switches the display mode as follows :

- ➔ ① PS (Program Service name) display
- ➔ ② RT (Radio Text) display
- ➔ ③ Frequency display

➔ ① **PS (Program Service name) display :**

The station name is displayed automatically when an RDS broadcast is received.

If no PS data was sent, "NO PS" is displayed.



➔ ② **RT (Radio Text) display :**

Text data accompanying the RDS broadcast scrolls across the display. "NO RT" is displayed if the current RDS station does not provide RT data.



➔ ③ **Frequency display :**

Displays the frequency of the current station.

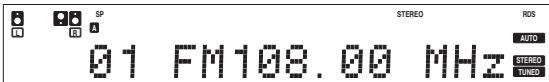

Presetting RDS stations (RDS AUTO MEMORY)

This function automatically stores up to 40 RDS stations in the preset memory. In order to use the PTY function, the RDS stations must be stored in the preset memory using the RDS AUTO MEMORY function.

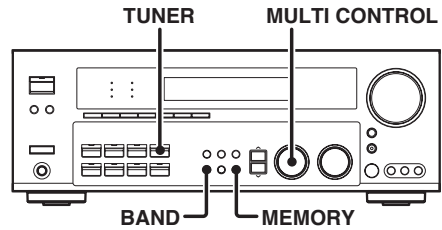

➔ ① Press the **TUNER** key to enter tuner mode.

➔ ② Use the **BAND** key to set the broadcast band to "FM".

➔ ③ Press the **MEMORY** key continuously for more than 2 seconds will start **AUTO MEMORY**.

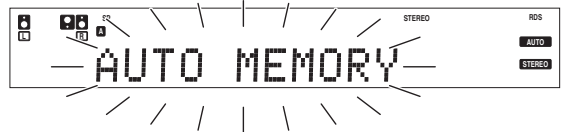

- After a few minutes, up to 40 RDS stations are preset in order from channel "01".
- Stations already stored in the preset memory may be replaced by RDS stations. (i.e., If the RDS AUTO MEMORY function detects 15 RDS stations, the stations currently preset at numbers 01~15 will be replaced by the RDS stations.)

Tuning by Program Type (PTY search)

This function lets you set the tuner to automatically search for stations which are currently broadcasting the type of program (genre) you want to listen to.

Under certain receiving conditions, it may take more than 1 minute to complete the search.

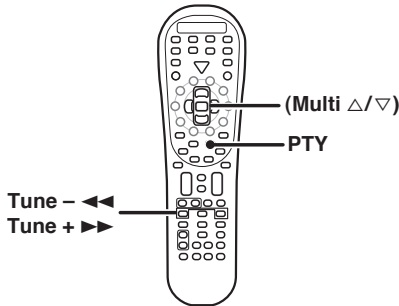

ENGLISH

Preparations

- Execute the RDS auto memory procedure.
- Set the broadcast band to FM.
- Tune to an RDS station.

1 Press the PTY key to activate the PTY search mode.

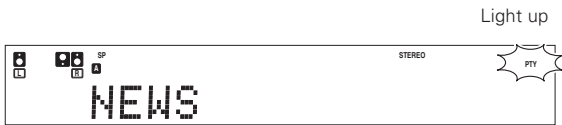

Light up

When an RDS broadcast is received, the program type is shown on the display. If no PTY data is available, or if the station is not an RDS station, "NONE" is displayed.

2 While the "PTY" indicator is lit, use the Multi (Δ/∇) keys or Tune - ◀/▶ keys select the program type of your choice.

Program type table

Program Type Name	Display	Program Type Name	Display
Pop Music	POP M	Weather	WEATHER
Rock Music	ROCK M	Finance	FINANCE
Easy Music	EASY M	Children's Program	CHILDREN
Light Classical Music	LIGHT M	Social Affairs	SOCIAL
Serious Classical Music	CLASSICS	Religion	RELIGION
Other Music	OTHER M	Phone In	PHONE IN
News	NEWS	Travel	TRAVEL
Current Affairs	AFFAIRS	Leisure	LEISURE
Information	INFO	Jazz Music	JAZZ
Sport	SPORT	Country Music	COUNTRY
Education	EDUCATE	National Music	NATION M
Drama	DRAMA	Oldies Music	OLDIES
Culture	CULTURE	Folk Music	FOLK M
Science	SCIENCE	Documentary	DOCUMENT
Varied Speech	VARIED		

"NO PROGRAM" is displayed if this operation is attempted before performing the RDS Auto Memory operation.

3 Press the PTY key to start searching.

EXAMPLE : Searching for a Pop Music broadcast.

Display while searching.

Blinks



Program type name display

Display when a station is received.

Goes out



Station name display

- No sound is heard while "PTY" is blinking.
- If the desired program type cannot be found, "NO PROGRAM" is displayed, then after several seconds the display returns to the original display.

To select another program type.

Repeat steps 1, 2 and 3.

Ambience effects

This receiver is equipped with listening modes that allow you to enjoy an enhanced sonic ambience with a variety of video sources.

In order to obtain the optimum effect from the surround modes, make sure to input the proper speaker settings beforehand.

→ 19

Surround modes

The below speaker placements are for 5.1 channel surround sound system which are;

- Dolby Digital
- THX
- DTS 96/24
- DVD 6-channel
- Dolby Pro Logic II
- DTS
- DSP

The below speaker placements are for 6.1 or 7.1 channel surround sound system which are;

- Dolby Digital EX*
 - THX Surround EX*
 - Dolby Pro Logic IIx
 - DTS-ES*
 - Neo:6*
- (*The same signal comes out from SBL and SBR.)

ENGLISH

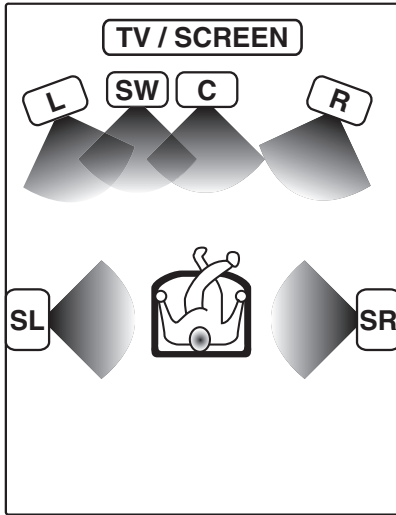

No Surround Back speaker

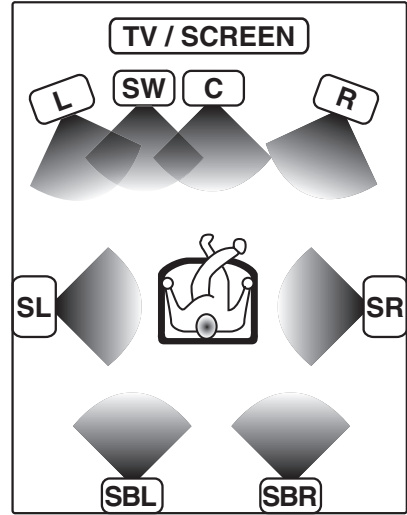

Surround Back Left and Right Speakers

Even if the speaker configuration is different from above, this receiver will let you enjoy Dolby Digital and DTS sources in a suitable condition for every speaker configuration.

Manufactured under license from Dolby Laboratories. "Dolby", "Pro Logic", "Surround EX" and the double-D symbol are trademarks of Dolby Laboratories.

- L** Front Left speaker
- SW** Subwoofer
- C** Center speaker
- R** Front Right speaker
- SL** Surround Left speaker
- SR** Surround Right speaker
- SBL** Surround Back Left speaker
- SBR** Surround Back Right speaker

"DTS", "DTS-ES", "Neo:6" and "DTS 96/24" are trademarks of Digital Theater Systems, Inc.



THX is a trademark or registered trademark of THX Ltd. Surround EX is a jointly developed technology of THX and Dolby Laboratories, Inc. and is a trademark of Dolby Laboratories, Inc. Used under authorization. All rights reserved.

Dolby Digital

The Dolby Digital surround format lets you enjoy up to 5.1 channels of digital surround sound from Dolby Digital program sources (such as Laserdisc or DVD software marked ). Compared with previous Dolby surround, Dolby Digital provides even better sound quality, greater spatial accuracy, and improved dynamic range.

Dolby Digital EX

Dolby Digital EX is an extension of Dolby Digital technology, Dolby Digital EX creates six full-bandwidth output channels from 6.1-channel sources. This is done using a matrix decoder that derives three surround channels from the two in the original recording. This is achieved by using three different surround signals, surround left, surround right, and surround back, each driving its own array of speakers. Think of it as adding a center channel for the rear speakers, which give more diffuse and natural surround effect, even if you wanted the ability to completely encircle the audience with sound, positioning sound effects exactly where they would be heard in real life. For best results, Dolby Digital EX should be used with movie soundtracks recorded with Dolby Digital Surround EX which contain a digital flag that will automatically activate this feature. However, for titles released prior to late 2001, this feature has to be activated manually.

Although only Dolby Digital soundtracks incorporate a separate low frequency channel, connecting a subwoofer will also improve deep bass performance in the other surround modes. The indication "LFE" appears in the display when a signal is being input for this channel.

Dolby PRO LOGIC IIX and Dolby PRO LOGIC II

Dolby Pro Logic II was designed specifically to provide a new sense of spatiality, directionality and articulation of sounds from Dolby Surround encoded sources (such as video and Laserdisc software marked ). This is achieved with an intelligent, built-in feedback logic design, a matrix surround decoding and the decoding of stereo, full bandwidth surround outputs. DOLBY PRO LOGIC IIX enhanced DOLBY PRO LOGIC II's features.

It creates 6.1 channel and 7.1 channel surround sound from stereo or 5.1 channel signals. This feature provides you an astonishing ambience effect which makes you feel you are surrounded by natural sound. Especially 7.1 channel surround sound can produce real back sound from Surround Back speakers.

The PRO LOGIC IIX modes programmed into this model are "MOVIE", "MUSIC" and "GAME". The PRO LOGIC II modes programmed into this model are "MOVIE", "MUSIC", "GAME" and "PRO LOGIC". The "MOVIE" mode has preset characteristics to produce a calibrated, high-level surround sound playback while the "MUSIC" mode has user-adjustable characteristics to offer the three optional controls, like "Dimension", "Center Width" and "Panorama" modes to allow optimization of the soundfields as desired. The "Dimension" control allows the user to gradually adjust the soundfield either towards the front or towards the rear; the "Center Width" control allows various adjustment of the left-center-right speakers' balance; the "Panorama" mode extends the front stereo image to include the surround speakers for an exciting "wraparound" effect with side wall imaging. The "GAME" mode provides surrounded and exciting sound when you enjoy game or TV. Especially in PRO LOGIC IIX "GAME" mode, base sound not only from Front and Center but also from Surround channel is added to Subwoofer. This provides even more dynamic surround effects.

DTS

The DTS multi-channel audio format is available on CD, LD and DVD software. DTS is a strictly digital format and cannot be decoded inside most CD, LD or DVD players. For this reason, if you attempt to listen to DTS encoded software through the analog output of your new CD, LD or DVD player, you will experience digital noise in most cases. This noise can be quite loud if the analog output is connected directly to a high power amplification system. Proper measures for playing the digital output as described below should be taken to avoid this situation. To enjoy DTS Digital Surround playback, an external 5.1 channel DTS Digital Surround decoder system or an amplifier with a built-in DTS Digital Surround decoder must be connected to the digital output (S/P DIF, AES/EBU or TosLink) of a CD, LD or DVD player. All models are incorporated with the DTS decoder.

DTS-ES

DTS-ES (Digital Theater System-Extended Surround) presents 6.1 channels surround system with additional Surround Back channel which evolved from the conventional 5.1 channels surround system. DTS-ES format that was recorded in DVD, CD or LD comprises of two modes. DTS-ES Discrete 6.1 produces the discrete surround back which is completely independent and DTS-ES Matrix 6.1 produces the surround back which synthesised within the left and right surround channels using matrix technology. DTS-ES has perfect compatibility with the conventional 5.1 channels surround system. 6.1 channels surround with an additional surround back presents a more natural presence and surround effects by increasing the impression of the sound image from back. Programs which are recorded using DTS-ES technology consist of information flags which will be able to control the Discrete and Matrix mode. Thus, it can automatically select the best matched mode.

Neo:6

Neo:6 is a new technology which was developed by DTS. It can produce high grade 6 channels surround with an astonishing fidelity from 2 channels content. Neo:6 has 2 modes, "CINEMA" mode is for movie playback and "MUSIC" mode is for music playback.

DTS 96/24

DTS 96/24 made it possible to achieve a wide frequency range of over 40 kHz by increasing the sampling frequency to 96 or 88.2 kHz. Moreover, DTS 96/24's ability of 24 bit resolution offers the same frequency band and dynamic range as 96 kHz/24 bit PCM. DTS 96/24 is, as with conventional DTS Surround, compatible with multi-channels. Therefore, sources recorded using DTS 96/24 technologies can be played in high sampling frequency, multi-channel audio with ordinary DVDs and CDs.

DTS has a ".1" or "LFE" channel.

The indication "LFE" appears in the display when a signal is being input for this channel.

Note

LFE = Low Frequency Effects. This channel delivers separate non-directional bass signals to the subwoofer for more dynamic deep bass sound effects.

THX

Movie soundtracks are mixed in special movie theatres called dubbing stages and are designed to be played back in movie theatres with similar equipment and conditions. This same soundtrack is then transferred directly onto Laserdisc, VHS tape, DVD, etc., and is not changed for playback in a small home theatre environment.

THX engineers developed patented technologies to accurately translate the sound from the movie theatre environment into the home, correcting the tonal and spatial errors that occur. Activate THX whenever watching a movie that was intended for the playback in a Cinema. On this product, when the THX indicator is on, the following THX features are automatically added in movie playback modes (e.g. Dolby Digital+THX, DTS+THX, THX Surround EX, etc):

Re-equalization (Re-EQ)

The tonal balance of a film soundtrack will be excessively bright and harsh when played back over audio equipment in the home because film soundtracks were designed to be played back in large movie theatres using very different professional equipment. Re-Equalization restores the correct tonal balance for watching a movie soundtrack in a small home environment.

Timbre Matching

The human ear changes our perception of a sound depending on the direction from which the sound is coming. In a movie theatre, there is an array of surround speakers so that the surround information is all around you. In a home theatre, you use only two speakers located to the side of your head. The Timbre Matching feature filters the information going to the surround speakers so that they more closely match the tonal characteristics of the sound coming from the front speakers. This ensures seamless panning between the front and surround speakers.

Adaptive Decorrelation

In a movie theatre, a large number of surround speakers help create an enveloping surround sound experience, but in a home theatre there are usually only two speakers. This can make the surround speakers sound like headphones that lack spaciousness and envelopment. The surround sounds will also collapse into the closest speaker as you move away from the middle seating position. Adaptive Decorrelation slightly changes one surround channel's time and phase relationship with respect to the other surround channel. This expands the listening position and creates - with only two speakers - the same spacious surround experience as in a movie theatre.

THX Select

Before any home theatre component can be THX Select certified, it must incorporate all the features above and also pass a rigorous series of quality and performance tests. Only then can a product feature the THX Select logo. Hundreds of parameters in both the digital and analog domain are tested and required to meet very specific high quality standards which is your guarantee that the Home Theatre products you purchase will give you superb performance for many years to come. THX Select requirements cover every aspect of the product including pre-amplifier and power amplifier performance and operation.

THX Surround EX mode

THX Surround EX-Dolby Digital Surround EX is a joint development of Dolby Laboratories and the THX division of Lucasfilm Ltd.

In a movie theatre, film soundtracks that have been encoded with Dolby Digital Surround EX technology are able to reproduce an extra channel which has been added during the mixing of the program. This channel, called Surround Back, places sounds behind the listener in addition to the currently available front left, front center, front right, surround right, surround left and subwoofer channels. This additional channel provides the opportunity for more detailed imaging behind the listener and brings more depth, spacious ambience and sound localization than ever before.

Movies that were created using the Dolby Digital Surround EX technology, when released into the home consumer market may exhibit a Dolby Digital Surround EX logo on the packaging. A list of movies created using this technology can be found on the Dolby web site at <http://www.dolby.com>.

Only receiver and controller product bearing the THX Surround EX logo, when in the THX Surround EX mode, faithfully reproduce this new technology in the home.

This product may also engage the "THX Surround EX" mode during the playback of 5.1 channel material that is not Dolby Digital Surround EX encoded. In such case the information delivered to the Surround Back channel will be program dependent and may or may not be very pleasing depending on the particular soundtrack and the taste of the individual listener.

DSP mode

The DSP mode lets you add the atmosphere of a live concert or hall to almost any type of program source. These modes are particularly effective when used with stereo program sources, like CD, television, and FM radio. You might enjoy trying the ARENA, JAZZ CLUB, THEATER, STADIUM or DISCO mode the next time you watch a concert or sporting event!

What's DSP mode?

DSP stands for Digital Signal Processor.

The way a sound is heard in an actual environment depends on a variety of different factors. One of the most important is reverberation (the act of decaying elements of sound echoing in various places). The DSP modes produce the feeling of presence by using the DSP to create reverberation, without spoiling the sound quality of the original signal.

DVD 6-channel mode

Using a DVD player or the like equipped with six (5.1) output channels and the receiver, you can enjoy multi-channel encoded DVD source material in all its splendor. Since the source signals are digital and each channel is input independently, the resulting sound quality, sense of spaciousness, and dynamic range are superb.

The indication "**6CH INPUT**" appears in the display during DVD 6-channel mode selection.

Surround play

The DTS compatible models can reproduce a CD, DVD, or LD carrying the DTS mark.

DOLBY DIGITAL can be used when playing DVD or LD software bearing the  mark and DOLBY DIGITAL format digital broadcasts (etc.). DOLBY PRO LOGIC can be used when playing video, DVD, or LD software bearing the  mark.

ENGLISH

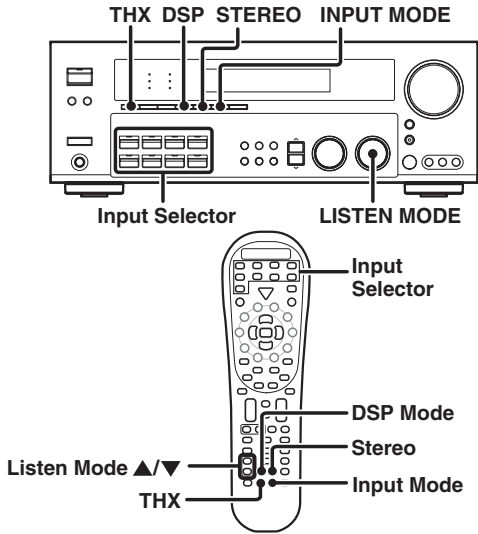

Preparations

- Turn ON related components.
- Complete "Preparing for surround sound" (speaker settings). → [19]
- Use the **Input Selector** keys to select the component you wish to play back with surround sound.
- Use the **INPUT MODE** key to select the input mode (analog or digital) for the source you wish to play back. → [8]
- Noise will be produced when a DTS source is played by selecting the analog input.

1 Start playing the video software.

2 Use the LISTEN MODE knob or Listen Mode ▲/▼ keys to select the listening mode.

The listening mode settings are stored separately for each input. If the input mode is set to full auto ("AUTO DETECT" lights), the receiver selects the optimal listening mode automatically based on the type of input signal and the speaker settings.

Each turn of the LISTEN MODE knob or press of the Listen Mode ▲/▼ keys switches the setting as listed below.



The listening mode settings are different depending on the type of input signal.

Dolby Digital Surround EX compliant disc :

Dolby Digital Surround EX compliant disc contains identification signals. When you choose **FULL AUTO** during "Input mode settings" (→ [8]), this amplifier detects the identification signals and selects an optimum LISTEN mode automatically.

Sometimes we find some discs which are Dolby Digital Surround EX compliant discs but do not contain the identification signals. In this case, select one of the LISTEN modes which are for 6.1 or 7.1 channel surround mode.

When the DOLBY DIGITAL or DOLBY DIGITAL EX signal is input :

- 1 **DOLBY DIGITAL** : DOLBY DIGITAL surround.
(DOLBY DIGITAL indicator lights up.)
- 2 **DOLBY D EX** : DOLBY DIGITAL EX surround.
(DOLBY DIGITAL indicator lights up.)
- 3  **MOVIE** : DOLBY DIGITAL+PRO LOGIC IIx surround MOVIE mode.
(DOLBY DIGITAL and PRO LOGIC indicators light up.)
- 4  **MUSIC** : DOLBY DIGITAL+PRO LOGIC IIx surround MUSIC mode.
(DOLBY DIGITAL and PRO LOGIC indicators light up.)
- 5 **PLIIx MOVIE** : PRO LOGIC IIx surround MOVIE mode.*
(DOLBY DIGITAL and PRO LOGIC indicators light up.)
- 6 **PLIIx MUSIC** : PRO LOGIC IIx surround MUSIC mode.*
(DOLBY DIGITAL and PRO LOGIC indicators light up.)
- 7 **PLIIx GAME** : PRO LOGIC IIx surround GAME mode.*
(DOLBY DIGITAL and PRO LOGIC indicators light up.)
- 8 **PLII MOVIE** : PRO LOGIC II surround MOVIE mode.*
(DOLBY DIGITAL and PRO LOGIC indicators light up.)
- 9 **PLII MUSIC** : PRO LOGIC II surround MUSIC mode.*
(DOLBY DIGITAL and PRO LOGIC indicators light up.)
- 10 **PLII GAME** : PRO LOGIC II surround GAME mode.*
(DOLBY DIGITAL and PRO LOGIC indicators light up.)
- 11 **PRO LOGIC** : PRO LOGIC II surround PRO LOGIC mode.*
(DOLBY DIGITAL and PRO LOGIC indicators light up.)
- 12 **STEREO** : Normal stereo playback.
(DOLBY DIGITAL and STEREO indicators light up.)

(* This mode can be selected only when 2 channel stereo signal comes in.)

When you select DOLBY DIGITAL "DOLBY DIGITAL" will be displayed.



When the DTS or DTS-ES (matrix or discrete) signal is input :

- 1 **DTS-ES Mtrx 6.1** : DTS-ES MATRIX 6.1 channel surround.
(DTS and MATRIX indicators light up.)
- 2 **DTS-ES Dscrt 6.1** : DTS-ES DISCRETE 6.1 channel surround.
(DTS and DISCRETE indicators light up.)
- 3 **DTS** : DTS 5.1 channel surround.
(DTS indicator lights up.)
- 4 **DTS+NEO:6 Cin** : DTS+NEO:6 surround CINEMA mode.
(DTS and NEO:6 indicators light up.)
- 5 **NEO:6 CINEMA** : NEO:6 surround CINEMA mode.*
(DTS and NEO:6 indicators light up.)
- 6 **NEO:6 MUSIC** : NEO:6 surround MUSIC mode.*
(DTS and NEO:6 indicators light up.)
- 7 **DTS 96/24** : DTS 96/24 playback mode.
(DTS indicator lights up.)
- 8 **STEREO** : Normal stereo playback.
(DTS and STEREO indicators light up.)

(* This mode can be selected only when 2 channel stereo signal comes in.)

When the analog signal or the digital signal (except for DOLBY DIGITAL or DTS signal) is input :

- ① **PLIIx MOVIE** : PRO LOGIC IIx surround MOVIE mode. (PRO LOGIC indicator lights up.)
- ② **PLIIx MUSIC** : PRO LOGIC IIx surround MUSIC mode. (PRO LOGIC indicator lights up.)
- ③ **PLIIx GAME** : PRO LOGIC IIx surround GAME mode. (PRO LOGIC indicator lights up.)
- ④ **PLII MOVIE** : PRO LOGIC II surround MOVIE mode. (PRO LOGIC indicator lights up.)
- ⑤ **PLII MUSIC** : PRO LOGIC II surround MUSIC mode. (PRO LOGIC indicator lights up.)
- ⑥ **PLII GAME** : PRO LOGIC II surround GAME mode. (PRO LOGIC indicator lights up.)
- ⑦ **PRO LOGIC** : PRO LOGIC II surround PRO LOGIC mode. (PRO LOGIC indicator lights up.)
- ⑧ **NEO:6 CINEMA** : NEO:6 surround CINEMA mode. (NEO:6 indicator lights up.)
- ⑨ **NEO:6 MUSIC** : NEO:6 surround MUSIC mode. (NEO:6 indicator lights up.)
- ⑩ **STEREO** : Normal stereo playback. (STEREO indicator lights up.)

• Dolby Digital or DTS signal having more channels than the maximum number of playback channels available using this model's current settings is input, downmixing is performed to match the number of available channels.

3 DSP mode (Digital Signal Processor).

DSP can produce these effects without spoiling the sound quality of the original music or video source. This mode can be selected when digital signals other than DOLBY DIGITAL or DTS, or analog signal come in.

- ① **Pressing the DSP key or DSP Mode key will display the current DSP MODE status.**
- ② **Each press of the key will switch to the next status as shown below:**
 - ① **ARENA** : DSP surround ARENA mode.
 - ② **JAZZ CLUB** : DSP surround JAZZ CLUB mode.
 - ③ **THEATER** : DSP surround THEATER mode.
 - ④ **STADIUM** : DSP surround STADIUM mode.
 - ⑤ **DISCO** : DSP surround DISCO mode.

• The DSP mode selection is displayed for approximately 3 seconds.

4 THX mode.

This mode creates a home theater environment which is able to reproduce a cinema surround sound system featuring improved special representation and acoustic imaging of surround channels by translating THX Surround EX technology.

Press the THX key to switch the following setting :

- ① **THX Sur EX AUTO** : THX Surround EX function is turned ON when Dolby Digital Surround EX signal is detected. (THX indicator lights up.)
- ② **THX Sur EX ON** : THX Surround EX function is turned ON when Dolby Digital 5.1ch signal is detected. (THX indicator lights up.)
- ③ **THX ON** : THX mode is turned ON. (THX indicator lights up.)
- ④ **THX OFF** : THX mode is turned OFF. (THX indicator goes off.)

- THX functions when the display segment is turned ON.
- THX Sur EX ON and THX Sur EX AUTO will not be available if surround back speakers are turned OFF.
- The THX setting differs depending on the input selector.
- When PL IIx MUSIC, PL IIx GAME, PL II MUSIC, PL II GAME, NEO:6 MUSIC, ACTIVE EQ or SPEAKER EQ is ON, THX function will not be effective.

5 Adjust the volume.

Switching the LISTEN mode to STEREO temporarily

Pressing the **STEREO** key changes the currently selected LISTEN mode into STEREO. It will be changed back to the original LISTEN mode by pressing the **STEREO** key again.

- If the power is turned off and turned back on, or the input selector is switched to another and switched back, the LISTEN mode will be back to the original one.

Notes

- Depending on the type of the signal or speaker setting, some listening modes cannot be selected.
- When playback is started, the sound may be cut or interrupted before the input source is confirmed as Dolby Digital.
- To enjoy Dolby Digital surround (as well as all the other listening modes) from a single component, be sure to use a Dolby Digital compatible source component.
- Dialogue Normalization (Dial Norm) is a feature of Dolby Digital. It is able to automatically maintain the overall audio output level constant.



When playing some Dolby Digital sources, you may see in the display a message "DIALNORM OFFSET xxdB". This is because some soundtracks may be recorded either louder or quieter than normal. The xx number shows by how much. For example, if the message says "DIALNORM OFFSET +4dB" you know that this particular recording was encoded 4dB louder than normal. If you wish, you can turn down the volume control by 4dB to keep the playback level consistent.

DVD 6-channel playback

Using a DVD player or the like equipped with six (5.1) output channels and the receiver, you can enjoy surround sound playback. Connecting a DVD player which can decode the surround signal itself is also acceptable.

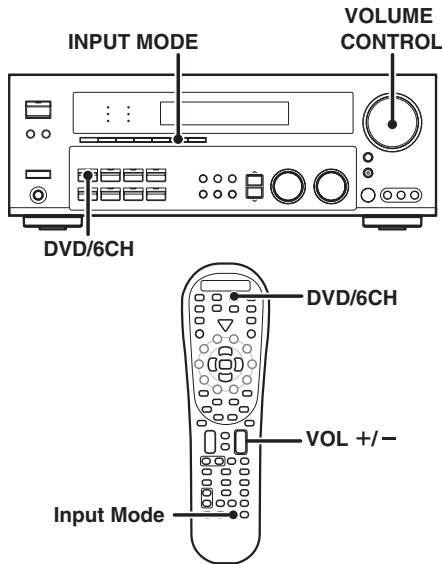

Preparations

- Connect your DVD player to the DVD/6CH jacks of the receiver.
- Turn on all other components that will be used.
- Complete "Preparing for surround sound".

- 19

- 1 Press "DVD/6CH" as the input source.
- 2 Select "6CH INPUT" by pressing the INPUT MODE key.

• If speaker system B is on when "6CH INPUT" is selected as the input source, it switches off and speaker system A turns on automatically.

- 3 Start playback of the DVD software.
- 4 Adjust the volume.

• It is not possible to adjust the volume level or sound quality (**SET UP, SOUND, LISTEN MODE, ACTIVE EQ, SPEAKER EQ, STEREO, DSP, LOUDNESS and TONE key will not be functional**) of the channels separately when the receiver is in the 6CH INPUT mode. Adjust the volume with the controls of the DVD player. For the powered subwoofer, you can adjust the volume of the subwoofer using the subwoofer's own volume control.

Convenient functions

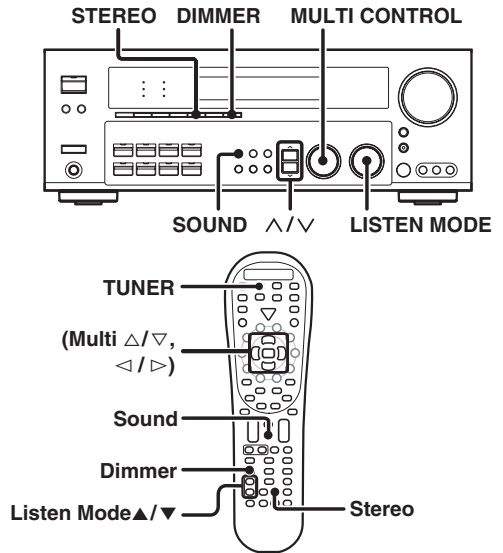

Adjusting the sound

You can make further adjustments to the sound while listening to playback in the surround mode.

- 1 For the remote control, press and hold the TUNER key for more than 3 seconds to switch to receiver mode.
- 2 Press the SOUND key and then use the Δ/∇ keys or $\triangleleft/\triangleright$ keys until the desired item appears in the display.

Each time you press the Δ/∇ keys or $\triangleleft/\triangleright$ keys, the menu changes as follows:
Note that some items are not displayed in certain modes.

- 1 CNTR (Center Speaker level adjustment)*
- 2 SR (Right Surround Speaker level adjustment)*
- 3 SBR (Surround Back Right Speaker level adjustment)*
- 4 SBL (Surround Back Left Speaker level adjustment)*
- 5 SL (Left Surround Speaker level adjustment)*
- 6 SUBW (Subwoofer level adjustment)*
- 7 INPUT (Input level adjustment - analog mode only) - 22
- 8 MIDNIGHT (Midnight mode ON/OFF - Dolby Digital and DTS mode only)
- 9 PANORAMA (Panorama mode ON/OFF)**
- 10 DIMENSION (Dimension adjustment)**
- 11 CENTER WIDTH (Center width adjustment)**
- 12 DUAL MONO (Dual Mono selection - Dolby Digital mode only)

- * The adjustment is only temporary for the current input selection. The value will return automatically to the original setup value when the power is turned on/off or when the input selector is changed.
- ** Pro Logic IIx Music and Pro Logic II Music mode only.

- 3 Use the MULTI CONTROL knob or Multi (Δ/∇) keys to adjust the setting as desired.
 - The adjustment item is displayed for approximately 20 seconds.

Midnight mode (Dolby Digital and DTS mode only)

When watching movies at night, you might not be able to raise the volume as loud as normal. Midnight mode compresses the dynamic range of previously specified heavy sound passage of the Dolby Digital and DTS sound track (like scenes with sudden increases in volume) to minimize the difference in volume between the scenes with heavy sound passage and scenes with normal sound passage. This makes it easy to hear all of the sound track, even when listening at low volumes.

- 1 Press the **SOUND** key, then press the **Λ/V** keys or **◀/▶** keys until **"MIDNIGHT"** appears on the display.
 - This can be selected only if CD/DVD, DVD/6CH, VIDEO 2 or VIDEO3 is selected as the source and the listen mode is set to "DOLBY DIGITAL" or "DTS".

- 2 Use the **MULTI CONTROL** knob or **Multi (Δ/▽)** keys to select the **ON** or **OFF** setting.



- The adjustment item is displayed for approximately 20 seconds.
- Some Dolby Digital or DTS software may not be compatible with the Midnight mode.

Panorama mode (Pro Logic IIx Music and Pro Logic II Music mode only)

When listening to music, you will be able to enjoy the "wraparound" sound effect when you adjust the panorama mode.

- 1 Press the **SOUND** key, then press the **Λ/V** keys or **◀/▶** keys until **"PANORAMA"** appears on the display.
- 2 Use the **MULTI CONTROL** knob or **Multi (Δ/▽)** keys to select **PANORAMA ON** or **OFF**.

- 1 **PANORAMA ON** : PANORAMA mode is ON.
- 2 **PANORAMA OFF** : PANORAMA mode is OFF.

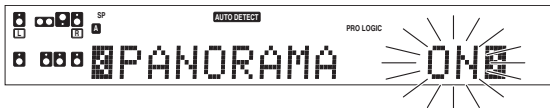

Dimension mode (Pro Logic IIx Music and Pro Logic II Music mode only)

When listening to music with certain recordings, you will also be able to achieve a suitable balance from all the speakers by adjusting the dimension mode.

- 1 Press the **SOUND** key, then press the **Λ/V** keys or **◀/▶** keys until **"DIMENSION"** appears on the display.
- 2 Use the **MULTI CONTROL** knob or **Multi (Δ/▽)** keys to adjust the soundfield towards the rear or the front.

Soundfield is adjusted towards the front.



Soundfield is in neutral position.

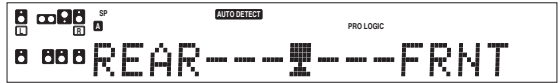

Soundfield is adjusted towards the rear.

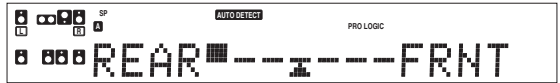

Center Width mode (Pro Logic IIx Music and Pro Logic II Music mode only)

Center width adjustment allows you to enjoy an enhanced sound when listening to music through center image from only Center Speaker, or Left and Right Speakers or various combinations adjustments.

- 1 Press the **SOUND** key, then press the **Λ/V** keys or **◀/▶** keys until **"CENTER WIDTH"** appears on the display.
 - The **CENTER WIDTH** indication scrolls across the display.
 - When the center speaker is switched OFF, this mode will not be effective.
- 2 Use the **MULTI CONTROL** knob or **Multi (Δ/▽)** keys to adjust the **left-center-right** output.

Center image will be heard from Center Speaker only.

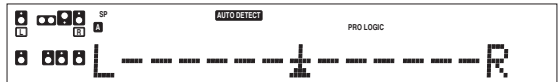

Center image will be heard from Left and Right Speakers only.

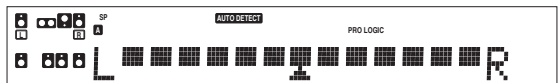

- When in other position, center image from Center Speaker, Left and Right speakers can be heard simultaneously with various combinations.

Dual Mono mode (Dolby Digital mode only)

When the Dolby Digital source have Multiplex sound, you can select Main / Sub sound for Audio output.

➊ Press the **SOUND** key, then press the **Λ/V** keys or **◀/▶** keys until **"DUAL MONO"** appears on the display.

- This can be selected only if CD/DVD, DVD/6CH, VIDEO 2 or VIDEO 3 is selected as the source, and the input signal is set to "Dolby Digital".

➋ Use the **MULTI CONTROL** knob or **Multi (Δ/▽)** keys for the following selection.

- ➊ **Main** : Multiplex Main channel output.
- ➋ **Sub** : Multiplex Sub channel output.
- ➌ **Main + Sub** : Multiplex Main + Sub channel output.
- ➍ **Stereo** : Main channel from the left speaker. / Sub channel from the right speaker.

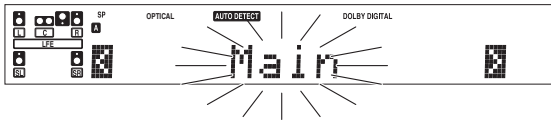

- The adjustment item is displayed for approximately 20 seconds.

Display dimmer adjustment

The dimmer function lets you select the brightness of the receiver's display. You might find this useful if you darken your room to watch movies or listen to music.

Each time you press the DIMMER key, the display brightness changes among the three available settings. Select the brightness level you find most pleasing.

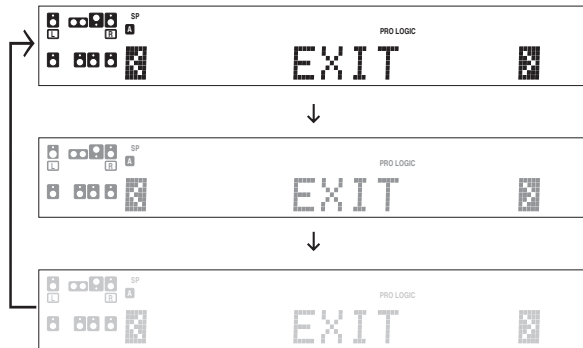

96kHz LPCM playback

The receiver is compatible with the 96kHz LPCM playback. To play a 96kHz DVD, set the listen mode other than DSP mode.

- In **FULL AUTO** input mode and the listen mode is set to DSP mode, the listen mode will automatically be STEREO.
- When in **DIGITAL MANUAL** input mode and the listen mode is set to DSP mode, "96kHz LPCM" will appear in the display and no sound can be heard from the speakers. Use the **LISTEN MODE** knob or **STEREO** key to select STEREO mode to output sound from the speakers.

Basic remote control operations for other components

The remote control supplied with this receiver is also capable of controlling components from a variety of manufacturers once you register the appropriate setup codes into the remote control unit.

Low battery warning

Replace all two batteries with new ones when you notice a shortening of the distance from which the remote control will operate. The remote control is designed to retain setup codes in memory while you change batteries.

Registering setup codes for other components

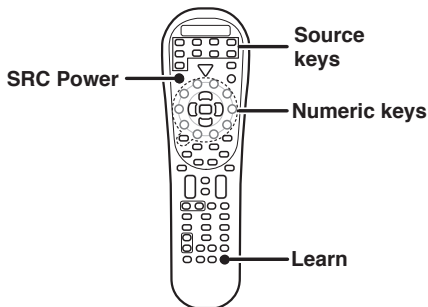

1 Find the setup code of the component to be registered.

- Refer to the setup code lists to find the setup code for the component to be registered. - 42
Example: To register a DVD made by KENWOOD, you would enter "0534".

Input	Component	Maker	Code	Key
DVD/6CH	DVD player	KENWOOD	0534	DVD 6CH

Source key	Other components
DVD/6CH	DVD
CD/DVD	CD and MD (Kenwood)
MD/TAPE	Cassette deck (Kenwood)
VID1 , AV AUX	VCR and PVR
VID2	Cable and DTV decoder
VID3	Satellite
PHONO	Additional key for re-assigning
TV	TV/VCR combo, TV/DVD combo, TV

2 Press the Source keys (DVD/6CH, CD/DVD, VID1, VID2, VID3, TV, MD/TAPE, AV AUX, PHONO).

- PHONO key has to re-assigned to another key before a setup code can be registered. - 42
- While in Tuner mode, setup code function will not be available.

3 Press and hold the Learn key until the blinks twice, then release the Learn key.

4 Press the Numeric keys to enter the four-digit code for the component to be registered.

- If performed correctly,  will blink twice.
- Point the remote control at the component and press **SRC Power** key once. It should turn on/off but if it does not, repeat step 2 to 4
- If the component still does not work, try searching for the code.

5 Repeat steps 2 to 4 to register additional components until all components have been registered.

Note

Although each setup code is designed to work with a number of different models, certain codes may not work with some models. (Also, certain codes may only operate some of the functions available on a given model.)

Searching for your codes

If your component does not respond after trying all the codes listed for your component, or if your component is not listed at all, try searching for your code.

For example, to search for code for your TV:

1 Press the TV key once. Next, press and hold the Learn key until blinks twice, then release the Learn key.

2 Press the numeric key to enter **[9] , [9] , [1]**.

-  will blink twice.

3 Point the remote control at the TV and slowly alternate between pressing the TV Power and TV key.

- Stop when the TV turns on/off.
- In the search mode, the remote control will send IR codes from its library to the selected device, starting with the most popular code first.

4 Press the Learn key once to lock in the code.

5 To search for the codes of your other components, repeat steps 1 through 4, but substitute the appropriate key (i.e., DVD/6CH, CD/DVD, VID1, VID2, VID3, TV, MD/TAPE, AV AUX, PHONO, SRC Power).

- PHONO key has to be re-assigned to another key before a setup code can be programmed.

Checking the codes

If you have setup the remote control using the procedures described in "Searching for your codes", you may need to find out which four-digit code is operating your equipment:

For example, to find out which code is operating your TV:

1 Press the TV key once. Next, press and hold the Learn key until blinks twice, then release the Learn key.

2 Press the numeric key to enter **[9] , [9] , [0]**.

-  will blink twice.

3 To view the code for the first digit, press "1" once. Wait for 3 seconds, counts the number of times blinks (e.g., blinks=3) and write down that number.

- If a code digit is "0", the  will not blink.

4 Repeat step **3** three more times for the remaining digits. Use "2" for the second digit, "3" for the third digit, and "4" for the fourth digit.

5 To check the codes of your other components, repeat steps **1** through **4**, but substitute the appropriate key (i.e., DVD/6CH, CD/DVD, VID1, VID2, VID3, TV, MD/TAPE, AV AUX, PHONO) for the component you are checking.

- As suggested earlier on, write down each of the four-digit code.
- PHONO key has to be re-assigned to another key before a setup code can be programmed.

Re-assigning device keys

The remote control can be setup to control second TV or VCR, or any combination of eight home entertainment components. For example, to control the operation of two different VCR using the remote control, the user need to re-assign the unused VID2 key to operate the second VCR(VID1) as follows:

1 Press and hold the Learn key until  blinks twice, then release the Learn key.

2 Press the Numeric key to enter **9**, **9**, **2**.

-  will blink twice.

3 Press VID1 key once, then press the VID2 key once.

- The user now can operate VID2 as a second VCR along with VID1.
- Refer to the table in the previous page for the combination of source keys and the other components assignment. - [39](#)



4 To re-assign other device keys, repeat steps **1** through **3** by substituting the key sequence from the below chart for the most popular components:

To re-assign key

Sequence	Perform
TV as 2nd VID1 key	Learn 9 9 2 VID1 TV
TV as 2nd VID2 key	Learn 9 9 2 VID2 TV
TV as 2nd CD/DVD key	Learn 9 9 2 CD/DVD TV
TV back to TV key	Learn 9 9 2 TV TV
VID1 as 2nd TV key	Learn 9 9 2 TV VID1
VID1 as 2nd VID2 key	Learn 9 9 2 VID2 VID1
VID1 as 2nd CD/DVD key	Learn 9 9 2 CD/DVD VID1
VID1 back to VID1 key	Learn 9 9 2 VID1 VID1

5 To clear the re-assignment and reset the remote control to its original operation mode:

- 1** Press and hold the Learn key until  blinks twice, then release the Learn key.
- 2** Press the numeric key to enter **9**, **9**, **2**.
- 3** Press VID2 key twice.

- When a re-assignment is done,  will blink twice to confirm your choice. At that time, you will need to program the remote control in order to control the new component.
- If an invalid key sequence is entered,  blink once and return to normal operation.
- When in Tuner mode, re-assignment is not available.

Operating other components

This operation lets you operate the registered components.

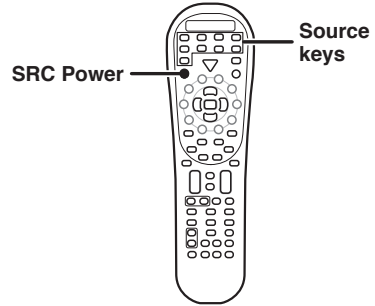

1 Use the Source keys to select the component you desire.

- Pressing the source keys also changes the input selector on the receiver.



2 Press the SRC Power key.

- To return to the receiver operation mode, press the TUNER key for more than 3 seconds.

3 Press the operation keys you desire. - [47](#)

The remote control mode remains at the selected input. If you wish to operate another component, repeat step **2** or **3**.

Resetting the Remote Control

- To initialize the remote control, press the Learn key until the  blinks twice. Then press the Numeric key to enter **9**, **8**, **1**. The  will blink twice.

Storing the remote control code of the other components

The remote control unit can store the remote control code of the other components and you can operate the other components from the remote control unit. The remote control code is stored on the key or memory of the remote control unit.

Storing on the key

You can store the remote control code to the key as shown below:

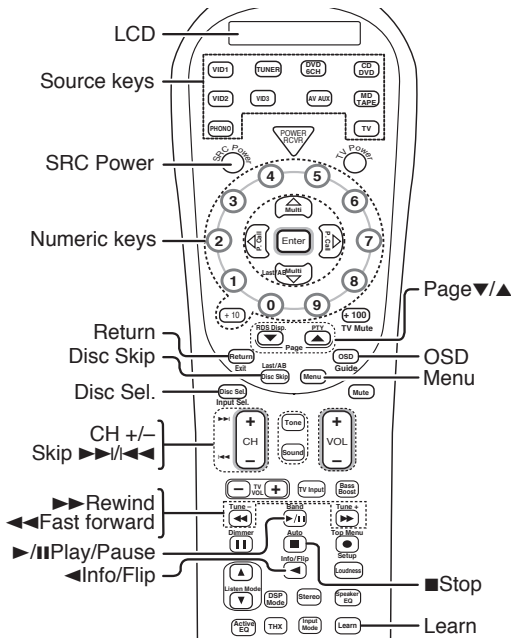

1 From the remote control unit of the other source, press the key that you want to store.

- The remote control code is sent to the remote control unit.
- "OK" appears when finished.
- If the code cannot be stored after a few attempts, "ERROR" will appear. Repeat from step 1 onwards.

2 The remote control code is stored on the key of this remote control unit.

3 Repeat step 1 to 2 to store additional components until all the desired components are stored.

4 To exit the learning mode, press and hold the Learn key for 3 seconds until the LED blinks twice.

5 To clear the stored remote control code of the other sources:

- 1 Press and hold the Learn key for 3 seconds until the LED blinks twice, then release the Learn key.
- 2 Press the numeric key to enter 9, 7, 6.
- 3 Press the Source key, then press the stored key twice until the LED blinks twice.
 - LED blinks twice to indicate that the stored remote control code are deleted.

1 Point the infrared ray system part of another remote control unit to the remote sensor of the remote control unit.

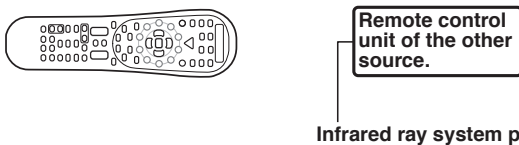

2 Press and hold the Learn key for 3 seconds until the LED blinks twice, then release the Learn key.

3 Press the numeric key to enter 9, 7, 5.

4 Press any of the source keys (PHONO, VID1, VID2, VID3, DVD/6CH, AV AUX, CD/DVD, MD/TAPE, TV) to select the input of the desired remote control unit.

- While in Tuner mode, learning code function will not be available.

5 Press the desired key of the remote control unit.

- "LEARN" appears on the display.

Setup code chart

Cassette deck setup codes

Maker	Setup codes
Kenwood	0070, 0071, 0092, 0183, 0205, 0233, 0234, 0251, 0386

CD and MD player setup codes

Maker	Setup codes
Kenwood	0028, 0036, 0037, 0190, 0338, 0339, 0340, 0523, 0626, 0677, 0681, 0692, 0826, 0858, 0859, 1059, 1490

TV setup codes

Maker	Setup codes
AGB	0516
ASA	0087, 0104, 0802
Acura	0009
Admiral	0087, 0163
Adyson	0217
Aiwa	0701, 0800
Akai	0208, 0361, 0516, 0602, 0708, 1537
Akiba	0803
Akito	0272
Akura	0264, 0218, 0493
Alba	0009, 0036, 0037, 0218, 0211, 0371, 0581, 0668, 0803, 0805,
Allorgan	0294
Amplivision	0217, 0400
Amstrad	0037, 0009, 0177, 0354, 0371, 0412, 0433, 0516, 0800
Anitech	0009, 0803
Arcam	0216, 0217
Asuka	0218, 0802
Atlantic	0206
Audiosonic	0037, 0109
Autovox	0087, 0206, 0336
BPL	0282
BSR	0294
BTC	0218
Baird	0800
Bang & Olufsen	0087, 0565
Barco	0380
Basic Line	0009, 0218, 0803, 0805,
Baur	0010, 0037, 0505, 0512, 0535, 0554
Beaumarck	0178
Beko	0370, 0486, 0714, 0715
Beon	0037
Binatone	0217
Blaupunkt	0195, 0200, 0327, 0328, 0535
Blue Sky	0218, 0668, 1037
Blue Star	0282
Bondstec	0247
Boots	0217
Brandt	0109, 0196, 0198, 0335
Brionvega	0087
Britannia	0216
Bruns	0087
Bush	0009, 0036, 0037, 0211, 0218, 0272, 0282, 0294, 0355, 0371, 0374, 0519, 0581, 0668, 0698, 0805, 0803
CGE	0074, 0084, 0247, 0800
CS Electronics	0216
CTC	0247
Carrefour	0036
Cascade	0009
Cathay	0037
Centurion	0037
Century	0087
Cimline	0009, 0803
Clarivox	0037

Maker	Setup codes
Ciatronic	0247, 0370
Condor	0370
Contec	0009, 0036, 0216
Continental Edison	0196, 0198, 0399
Crosley	0074, 0084, 0087
Crown	0009, 0037, 0370, 0418, 0579, 0803, 0805
Cybertron	0218
Daewoo	0009, 0037, 0374, 0499, 0805
Dainichi	0218
Dansai	0037, 0803
Dayton	0009
De Graaf	0208, 0548
Decca	0037, 0072, 0272, 0516, 0800
Dixi	0009, 0037
Dual	0336, 0519
Dual Tec	0217
Dumont	0070, 0087, 0800
Elbe	0259
Elcotech	0803
Elin	0037, 0548
Elite	0218
Elta	0009
Emerson	0087, 0361
Erres	0037, 0012
ESC	0804, 0805
Europhon	0516
Expert	0206
Ferguson	0037, 0073, 0109, 0190, 0193, 0238, 0335, 0560
Firstline	0009, 0216, 0217, 0247, 0294, 0668, 0802, 0803
Fidelity	0193, 0216, 0361, 0800
Finlandia	0208, 0346
Finlux	0037, 0070, 0072, 0087, 0104, 0105, 0179, 0346, 0411, 0516, 0800
Fisher	0104, 0208, 0217, 0303, 0370
Flint	0455
Forgestone	0193
Formenti	0037, 0087
Frontech	0163, 0247, 0264, 0448
Fujitsu	0072, 0206, 0683
Funai	0264, 0179, 0294, 0303, 0800
GEC	0037, 0043, 0072, 0217, 0516
GPM	0218
Geloso	0009
Genexxa	0163, 0218
GoldStar	0037, 0109, 0178, 0217, 0290, 0377, 0802
Goldhand	0803
Goodmans	0037, 0217, 0036, 0072, 0179, 0371, 0374, 0499, 0634, 0802, 0800, 0805, 0803
Gorenje	0370
Graetz	0163, 0361, 0804
Granada	0037, 0045, 0072, 0208, 0217, 0339, 0516

Setup code chart

TV setup codes (continue)

Maker	Setup codes
Grandin	0282, 0610, 0802, 0800, 0803
Grundig	0070, 0195, 0487, 0535, 0554, 0556, 0587, 0706, 0803, 0901
HCM	0009, 0282, 0412, 0803
Hanseatic	0037, 0361, 0556, 0802
Hantarex	0516
Havermy	0093
Hinari	0009, 0036, 0037, 0179, 0218, 0803, 0804
Hisawa	0282, 0400, 0455
Hitachi	0036, 0043, 0044, 0105, 0109, 0163, 0196, 0198, 0217, 0225, 0548, 0578, 0719, 0730, 0800
Huanyu	0216, 0374
Hypson	0037, 0264, 0282, 0803
ICE	0217, 0264, 0371
ICeS	0218
IR	0074
ITS	0371
ITT	0163, 0361, 0548, 0804
ITV	0802, 0805
Imperial	0074, 0084, 0247, 0370, 0418, 0630, 0800
Indiana	0037
Ingelen	0163
Inno Hit	0072, 0516
Interfunk	0037, 0163, 0247, 0361, 0512
Intervision	0037, 0102, 0217, 0264, 0377
Isukai	0218
JMB	0901
JVC	0036, 0053, 0094, 0190, 0192, 0371, 0606, 0653, 0683
Kaisui	0009, 0216, 0217, 0218, 0282, 0803
Kapsch	0163, 0206
Karcher	0610
Kathrein	0556
Kendo	0037
Kingsley	0216
Kneissel	0259, 0435
Korpel	0037, 0803
Korting	0087
Koyoda	0009
Lenco	0805
Leyco	0037, 0072, 0264, 0294, 0803
Liesenk & Tter	0037
Loewe	0087, 0512, 0802, 0806
Logik	0804
Luma	0206
Luxor	0194, 0361
M Electronic	0009, 0037, 0057, 0104, 0105, 0109, 0163, 0217, 0346, 0374, 0480, 0800
MTC	0512
Magnadyne	0087, 0102, 0247, 0516
Magnafon	0102, 0516
Magnum	0648
Manesth	0217, 0264, 0803

Maker	Setup codes
Marantz	0037, 0556
Marelli	0087
Mark	0037
Matsui	0009, 0011, 0036, 0037, 0072, 0208, 0211, 0217, 0177, 0272, 0294, 0354, 0355, 0371, 0443, 0487, 0516, 0579
McMichael	0043
Mediator	0012, 0037
Medion	0668
Memorex	0009, 0800, 0802, 1037
Memphis	0337, 0803
Metz	0087, 0275, 0367, 0388, 0447, 0535, 0802, 0806
Minerva	0070, 0487, 0535
Minoka	0412
Mitsubishi	0033, 0036, 0087, 0108, 0354, 0512, 0535
Mivar	0216, 0290, 0291, 0292, 0516, 0609
Multitech	0009, 0216, 0800, 0803
Murphy	0800
Myryad	0556
NEC	0170, 0704
NEI	0037, 0337
Neckermann	0037, 0087, 0505, 0556
Nesco	0179, 0803
Nikkai	0037, 0072, 0216, 0218, 0264, 0337
Noblisko	0102
Nokia	0361, 0473, 0480, 0548, 0606, 0631, 0804
Nordmende	0109, 0196, 0198, 0560
Oceanic	0163, 0361, 0800
Onwa	0433
Orion	0037, 0177, 0294, 0355, 0443, 0516, 0655
Osaki	0072, 0217, 0218, 0264, 0412, 0493, 0800, 0802, 0803
Oso	0218
Osume	0072, 0157
Otto Versand	0010, 0036, 0037, 0217, 0505, 0512, 0535, 0556
Palladium	0370, 0418, 0802, 0803
Panama	0217, 0264
Panasonic	0126, 0163, 0226, 0250, 0367, 0650, 0806, 1650
Pathe Cinema	0216, 0238
Pathe Marconi	0196, 0198
Pausa	0009
Perdio	0800
Philco	0074, 0084, 0087, 0247
Philips	0012, 0037, 0043, 0087, 0193, 0374, 0556
Phoenix	0087
Phonola	0012, 0037, 0087
Pioneer	0109, 0163, 0166
Polytron	0697
Prandoni Prince	0516
Profex	0009, 0361
Profitronic	0804
Proline	0800

Maker	Setup codes
Protech	0009, 0037, 0102, 0217, 0247, 0264, 0337, 0418, 0668
Pye	0012
Quelle	0010, 0011, 0037, 0070, 0074, 0084, 0104, 0200, 0327, 0328, 0361, 0505, 0512, 0535
Questa	0036
R-Line	0037
RBM	0070
RFT	0087
Radiola	0012, 0037
Radiomarelli	0087, 0516
Rank Arena	0036
Rediffusion	0361
Revox	0037
Rex	0163, 0206, 0264, 0259
Roadstar	0009, 0218, 0264, 0418, 0802, 0803, 0804, 0805
SBR	0012, 0037, 0043, 0193
SEG	0036, 0217, 0264, 0668, 0804
SEI	0010, 0087, 0102, 0177, 0294, 0516
Saba	0087, 0109, 0163, 0196, 0198, 0335
Saccs	0238
Sagem	0610
Saisho	0009, 0011, 0033, 0177, 0211, 0264, 0354, 0516
Salora	0163, 0194, 0361, 0548
Sambers	0102, 0516
Samsung	0009, 0037, 0217, 0264, 0290, 0370, 0556, 0587, 0618, 0644, 0804
Sandra	0216
Sansui	0655, 0706
Sanyo	0011, 0036, 0045, 0072, 0104, 0157, 0208, 0339
Schaub Lorenz	0361, 0800
Schneider	0037, 0057, 0218, 0247, 0303, 0336, 0371, 0394, 0668, 0800, 0803, 1137
Seleco	0163, 0206, 0259, 0411
Sharp	0036, 0093, 0256, 0901, 1193
Shintom	0803
Shorai	0294
Siarem	0087, 0102, 0516
Siemens	0037, 0157, 0195, 0200, 0327, 0328, 0535, 0802
Silva	0802
Silver	0036
Singer	0087
Sinudyne	0010, 0087, 0102, 0177, 0294, 0516
Skysonic	0696
Solavox	0163
Sonitron	0208
Sontec	0037, 0802
Sonoko	0009, 0037
Sonolar	0163, 0208
Sony	0010, 0011, 0036, 0505, 0651, 1505, 1651

Setup code chart

TV setup codes (continue)

Maker	Setup codes
Soundwave	0037, 0418
Standard	0009, 0217, 0218
Stern	0163, 0206, 0259
Sunkai	0294, 0355
Sunstar	0800
Suntronic	0800
Susumu	0218
Sysline	0037
T + A	0447
Tandy	0072, 0163, 0217, 0218
Tashiko	0036, 0043, 0217, 0800
Tatung	0037, 0072, 0217, 0516, 0800
Teac	0037, 0698, 0712, 1437
Tec	0217, 0247
Technics	0250, 0650
Technol Ace	0179
Telefunken	0074, 0084, 0101, 0109, 0262, 0335, 0625
Teletech	0009
Teleton	0036, 0206, 0217
Tensai	0218, 0294, 0800
Tenosal	0803
Texet	0216, 0218
Thomson	0109, 0196, 0198, 0399, 0625
Thorn	0037, 0072, 0074, 0084, 0104, 0190, 0192, 0193, 0361, 0499, 0512, 0535, 0505
Tomashi	0282
Toshiba	0036, 0070, 0508, 0243, 0718, 1508
Triumph	0177, 0243, 0516
Uher	0206, 0303, 0804
Ultra	0192
Ultravox	0102
Universum	0037, 0074, 0104, 0105, 2064, 0370, 0346, 0492, 0535, 0802, 0800, 0804
Vestel	0037
Videosat	0247
Videotechnic	0217
Videomagic	0802
Villain	0800
Voxson	0087, 0163
Waltham	0217
Watson	0037
Watt Radio	0102
Wega	0036, 0087
White	0037, 0216
Westinghouse	
Yamishi	0803
Yapshe	0250
Yoko	0037, 0217, 0264, 0804
Yokan	0803
Zanussi	0206

VCR setup codes

Maker	Setup codes
Asa	0081
Aiwa	0348, 0352
Akai	0041, 0106, 0315
Alba	0315, 0352
Baird	0041, 0104
Bang & olufsen	0499
Blaupunkt	0162, 0195, 0226
Brandt	0320, 0321, 0493
Brandt Electronic	0041
Bush	0352
Combitech	0352
Cyrus	0081
Daewoo	0637, 0642
De Graaf	0042, 0166
Decca	0081
Denon	0042
Dual	0041
Dumont	0081, 0104
Elbe	0038
Ferguson	0041, 0320, 0321, 0493
Finlandia	0081, 0104
Finlux	0042, 0081, 0104
Firstline	0043, 0045
Fisher	0046, 0104
GEC	0081
Goodmans	0637
Graetz	0041, 0104
Granada	0046, 0081, 0104
Grundig	0081, 0195, 0226, 0347
Hinari	0004, 0352
Hitachi	0004, 0041, 0042, 0166
ITT	0041, 0046, 0104, 0106, 0384
Ingersol	0004
Interfunk	0081
JVC	0041, 0067, 0384
Kendo	0106
Kenwood	0041
Loewe	0004, 0081, 0162, 1562
Logik	0004
Luxor	0043, 0046, 0048, 0106, 0104,
M Electronic	0038
Manesth	0045
Marantz	0081
Matsui	0004, 0348, 0352
Medion	0348
Memorex	0046, 0104
Metz	0162, 0195, 0347, 1562
Minerva	0195
Mitsubishi	0043, 0067, 0081
Myryad	0081
NEC	0038, 0041, 0067
Neckermann	0081
Nokia	0041, 0046, 0104, 0106

Maker	Setup codes
Nordmende	0041, 0320, 0321, 0384, 0494
Oceanic	0041
Okano	0348, 0315
Orion	0004, 0348, 0352
Otto Versand	0081
Palladium	0041
Panasonic	0162, 0226, 0836, 1562, 1662
Pathe Marconi	0041
Pentax	0042
Philco	0038
Philips	0081, 0384
Phonola	0081
Pioneer	0067, 0081
Pye	0081
Quartz	0046
Quelle	0081
Radiola	0081
Rex	0041, 0384
SBR	0081
SEI	0004, 0081
Saba	0041, 0320, 0321, 0384, 0494
Saisho	0004
Salora	0043, 0046, 0106
Samsung	0432
Sansui	0041, 0067
Sanyo	0046, 0104
Saville	0352
Schaub Lorenz	0041, 0104
Schneider	0081
Seleco	0041
Sharp	0048
Shintom	0104
Shorai	0004
Siemens	0081, 0104, 0195
Singer	0045
Sunudyne	0004, 0081
Sonolor	0046
Sony	0032, 0033, 1032
Sunkai	0348
Tatung	0041, 0081
Technics	0162, 0226
Teleavia	0041, 0493
Telefunken	0041, 0320, 0321, 0384, 0493, 0494
Thomson	0041, 0067, 0320, 0321, 0384, 0493, 0494, 0528
Thorn	0041, 0104
Toshiba	0041, 0043, 0045, 0081, 0384
Universum	0081, 0106, 0195
Wharfedale	0615

Setup code chart

Satellite setup codes

Maker	Setup codes
ABSat	0123, 0832
AST	0321, 0351
Akai	0515
Alba	0421, 0455, 0515, 0613
Aldes	0288
Amstrad	0252, 0345, 0501, 0675, 0689, 0847, 1113
Ankaro	0288, 0369, 0519, 0713
Antron	0421
Arcon	0834, 1043, 1205
Armstrong	0243
Aston	0142, 1129
Astra	0108
Astro	0173, 0358, 0501, 0520, 0548
AudioTon	0364
Avalon	0396
Axis	0369, 0530, 0834
BT	0515, 0668, 0710
Best	0369
Blaupunkt	0173
Boca	0243, 0829
British Sky Broadcasting	0847, 1175
CNT	0520
Cambridge	0515
Canal Digital	0853
Canal Satellite	0853
Canal+	0853
CityCom	0115, 0818, 1176
CommLink	0288
Connexions	0396
Conrad	0115, 0607
Crown	0243
Cyrus	0200
D-box	0723
DMT	1075
DNT	0200, 0396
Digenius	0299
Distratel	0084, 0885
Dynasat	0679
EIF	0417
Echostar	0167, 0312, 0396, 0453, 0454, 0511, 0610, 0713, 0853, 0871, 1086, 1169
Elta	0364
Emanon	0421
Engel	1017
Eurostar	0679, 1025, 1026
FTE	0331, 0863
Ferguson	0711
Fidelity	0252, 0675
Finlux	0397, 0414, 0455, 0108
Force NO AS	1101
Fracarro	0871
Freecom	0421
Fuba	0369, 0396, 0414, 0417, 0421
Galaxis	0283, 0288, 0364, 0833, 0834, 0863, 1101, 1111
Galaxisat	0321
Gardiner	0818
Gold Box	0853

Maker	Setup codes
Gooding	0571
Grundig	0139, 0140, 0173, 0571, 0750, 0805, 0847, 1150
HDT	1011, 1159
Hirschmann	0173, 0396, 0397, 0398, 0495, 0501, 0573, 0882, 1085
Hitachi	0455
Houston	0668
Humax	0283, 0863, 1176
Huth	0243, 0288, 0794
IRTE	0609, 0816
Hyundai	1011, 1159
ITT	0108
InVideo	0871
Intervision	0592
JOK	0710
JSR	0364
JVC	0515, 0571
Kathrein	0123, 0173, 0200, 0249, 0331, 0358, 0442, 0480, 0553, 0622, 0658, 1057, 1224
KeyWest	0794
Kosmos	0331
Kreiselmeier	0173
Kyostar	0421
L&S Electronic	1043
La Sat	0520, 0607
Lenco	0421
Lennox	0592
Lifesat	1122
Logix	1017
Lupus	0369
Luxor	0108, 0573
Manhattan	0455, 0520, 0592, 0765, 1017, 1083
Marantz	0200
Maspro	0495, 0750
Matsui	0571
MediaSat	0853
Mediamarkt	0243
Metronic	0084, 0713, 1215
Micronic	1003
Minerva	0571
Morgan's	0132, 0243, 0683, 0829, 1103
Multichoice	0642, 0879
Multistar	0331
Myryad	0200
Neuhaus	0501
Neusat	0692, 0834
NextWave	0732
Nikko	0713
Nokia	0108, 0397, 0455, 0573, 0723, 0751, 0873, 1023, 1127
Orbit	1022
Orbitech	0501
Pace	0241, 0455, 0497, 0720, 0791, 0795, 0847, 0867, 0887, 1175
Palladium	0571
Palsat	0501
Panasat	0879, 0615

Maker	Setup codes
Panasonic	0847, 1104
Panda	0455
Patriot	0515
Philips	0133, 0200, 0292, 0455, 0571, 0710, 0750, 0805, 0853, 0898, 1118
Phonotrend	0288, 0592
Pioneer	0329, 0352, 0853
Praxis	1123
Preisner	0132
Promax	0455
Prosat	0288
Quadral	0519, 0628
RFT	0200, 0288
Radiola	0200
Radix	0396, 0882, 1113
SAT	0321, 0351
SEG	0369, 0421, 0742, 1087
SKY	0856
SM Electronic	0157, 0240, 0713, 1200
STVI	0417
Saba	0520, 0690, 0710, 0885
Sabre	0455
Sagem	0820, 1114, 1253
Salora	0108
Samsung	1017, 1243
SatPartner	0421, 0520, 0692
Satcom	0605
Satplus	1009
Satstation	1083
Schneider	0805
Schwaiger	0552, 1111
Seemann	0396, 0530
Siemens	0173, 0683
Sky Television	1014
Skymaster	0240, 0288, 0519, 0605, 0628, 0713, 0880
Smart	0132
Sony	0278, 0847
Starland	1122
Strong	0132, 0879, 1088, 1105, 1159
Sunstar	0794
Supernova	0887
TPS	0820
Tantec	0455
TechniSat	0501, 0548, 1099, 1100, 1195
Telefunken	0421
Teleka	0243, 0613
Telesat	0605
Telesat	0114, 0157, 0501
Thomson	0455, 0853, 1012, 1046
Tonna	0668
Topfield	1206
Triad	0321, 0351
Triasat	0414, 0501
Triax	0115
Twinner	0136
Universum	0173, 0571
VTech	0351, 0690
Ventana	0200
Visiosat	1042

Setup code chart

Satellite setup codes (continue)

Maker	Setup codes
Vortec	0421
Wvisi	0173, 0321, 0351, 0372, 0396, 0406, 0455, 0638, 0690
XSat	0123
Zehnder	0114, 0321, 0331, 0520, 0552, 0818, 1075
Zenith	0856
Zwergnase	0794

Cable setup codes

Maker	Setup codes
Alcatel	0896, 0897
Birmingham cable Communications	0276
British Telecom	0003, 0105
Cable & Wireless	1068
Cabletime	0448, 0665, 0377, 0271
Cryptovision	0600
Decsat	0423
Director	0476
Filmnet	0443
France Telecom	0896, 0897, 0451
Golden Channel	1110
Grundig	0529
HyperVision	0619
Jerrold	0276, 0003
MNet	0443, 0019
Mr. Zap	1112
Noos	0817
Ono	1068
PVP Stereo	0003
Visual Matrix	
Pace	1068, 1060
Philips	0619
Pioneer	0144
Sagem	0817
Scientific Atlanta	0277, 0008, 0477
Supercable	0276
Tele+1	0443
Thomson	1110
Torx	0003
Tudi	0286
United Cable	0003
Videoway	0250
Visionetics	1064
Westminster	0105, 0716
Zenith	0000

DVD player setup codes

Maker	Setup codes
Afreedy	0698
Aiwa	0641
Akai	0611
Alba	0717
Amoisonic	0764
Amstrad	0713
Apex Digital	0672, 0795
Bush	0516, 0690, 0811
Cat	0786, 0787, 0789
Clatronic	0788
Cyber Home	0714, 0816
Cytron	0716
Daewoo	0770, 0784, 0832, 0833
Dansai	0770
Decca	0770
Denon	0490, 0634
Denver	0778
DiViDo	0705
Enterprise	0591
GoldStar	0741
Goodmans	0790
GPX	0769
Greenhill	0717
Grundig	0539, 0701, 0705, 0775
H & B	0818
Harman/Kardon	0702
Himage	0518
HiMAX	0843
Hitachi	0664
Hiteker	0672
JVC	0558, 0623
Jeutech	0777
Kenwood	0490, 0534, 0737
Konka	0711
LG	0741
Lasonic	0743
Lecson	0696
Lenco	0774
Lenoxx	0819
Limit	0768
Logic	0783
Mediencom	0746, 0773
MiCo	0723, 0751
Minato	0752
Minowa	0712
NAD	0692
Nintaus	0793
Onkyo	0612, 0627, 1612
Optim	0747
Oritron	0651
Panasonic	0490
Philco	0690
Philips	0539, 0646
Pioneer	0525, 0571
REC	0689
Redstar	0748, 0763, 0805
Revoy	0699
Roadstar	0689
Rotel	0623
SM Electronic	0690, 0730
Silm Art	0784
Samsung	0573, 0744
Sanyo	0670
Scheinder	0783

Maker	Setup codes
Scott	0718
Sherwood	0633
Skyworth	0766
Sony	0533, 1533
Tatung	0770, 0771
Teac	0759
Technics	0490
TerraTec	0825
Thomson	0551, 0522
Toshiba	0503
Tredex	0799, 0800, 0803
Umax	0690
Wesder	0699
Wharfedale	0686, 0696
Xoro	0806, 0829
Xwave	0709
Yamakawa	0665, 0710, 0765
Yelo	0780
Zeus	0784

DTV decoder setup codes

Maker	Setup codes
Grundig	0467
Panasonic	1120
Pioneer	1010
Princeton	0113, 0295
Samsung	1190
Sensory Science	1126
Sharp	1010

Cassette deck, CD player & MD recorder operations

Refer to the following for the type of remote control operations available for each component.

- 1 Select the input source.
- 2 Press the keys corresponding to the operations you desire. Refer to the following sections for details.

- When pressing keys in succession, press each key firmly and be sure to wait at least 1 second before pressing the next key.
- Numeric keys function the same as the numeric keys on the original remote.

These keys can be used to perform the basic operations of KENWOOD and other manufacturers' components which the setup code for each component had been entered beforehand.

Cassette deck operations keys

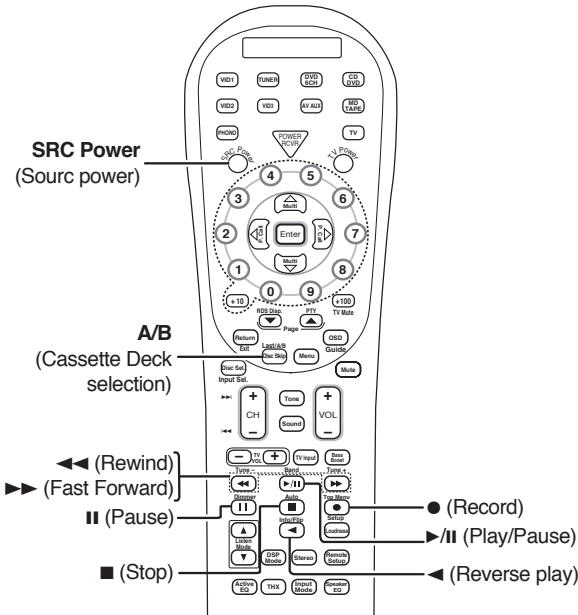

CD player operation keys

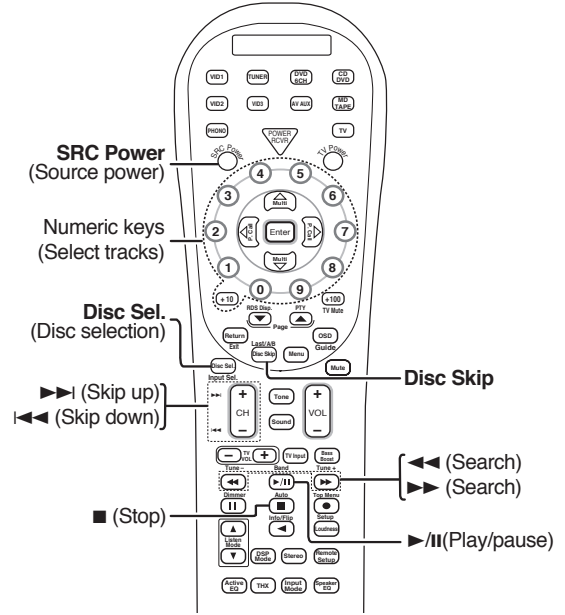

MD recorder operation keys

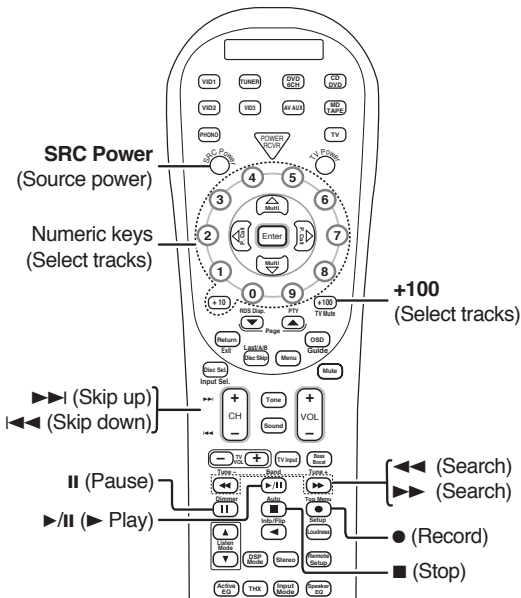

Other components' operations

Refer to the following for the type of remote control operations available for each component.

TV operation keys

VCR operation keys

ENGLISH

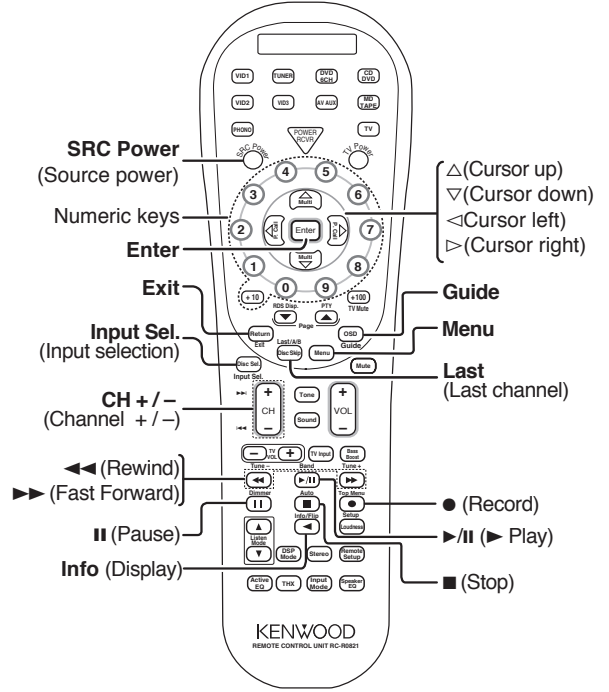
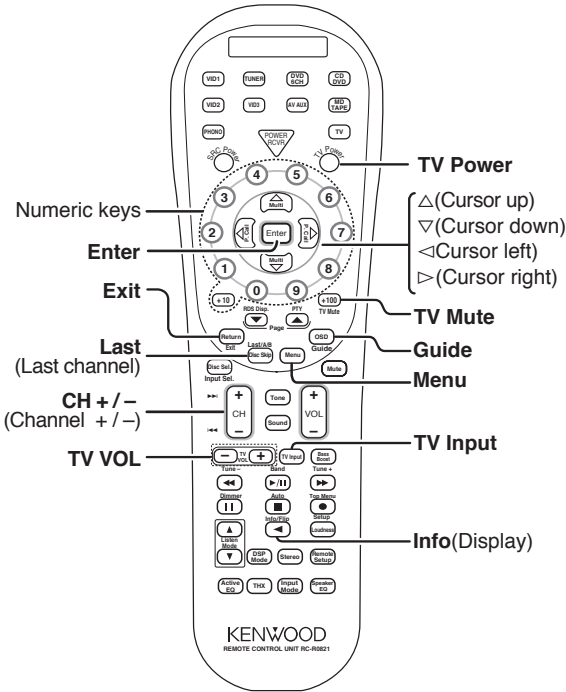

DVD player operation keys

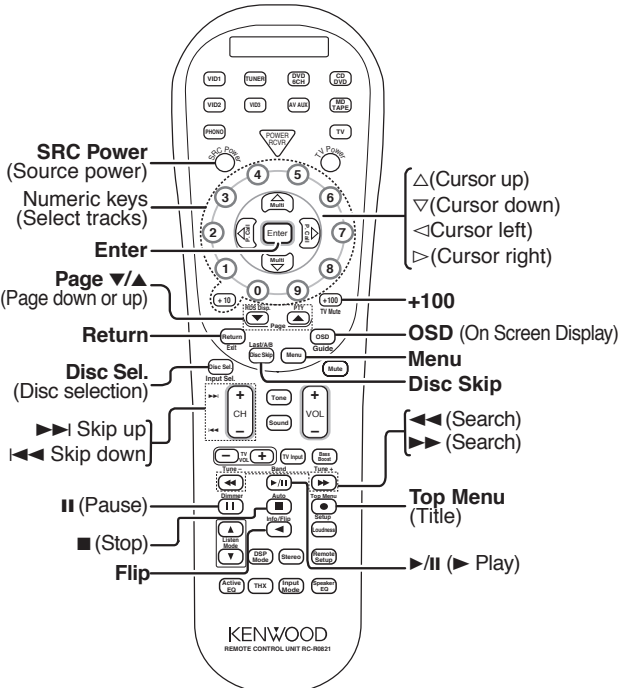

Satellite operation keys

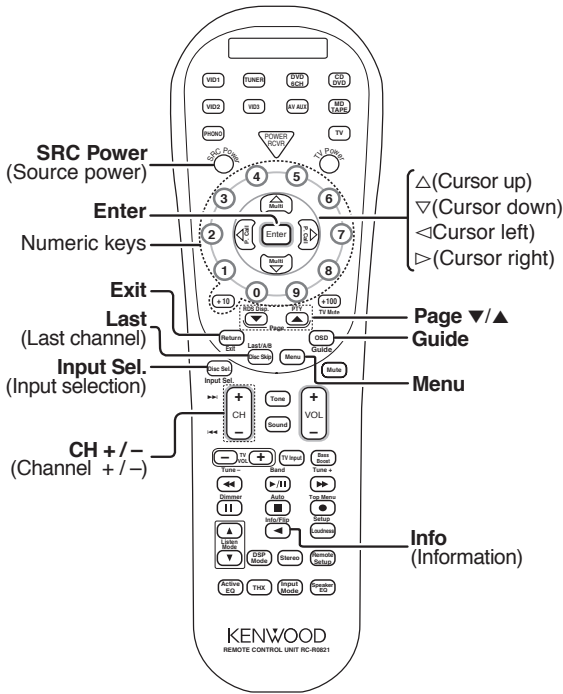

Cable operation keys

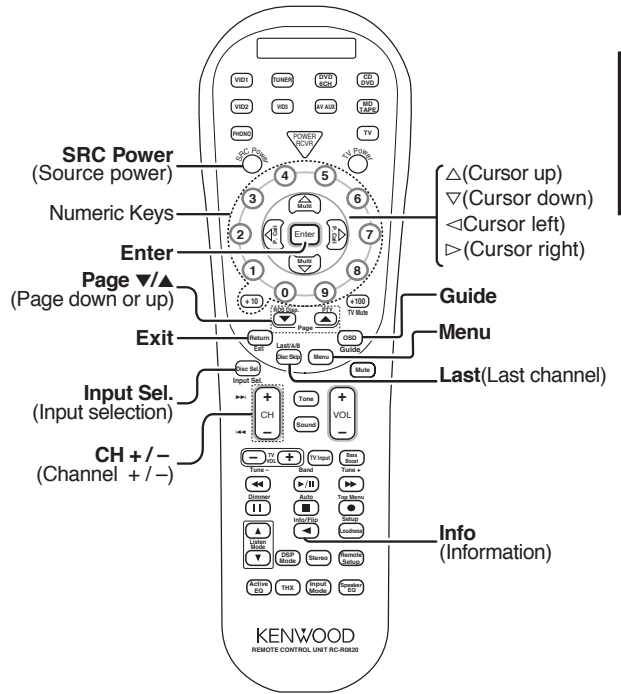

Notes

1. Certain codes may only operate some of the function available on a given model.
2. The above show the typical type functions available for each component. Some manufacturers use different key combinations to perform similar functions. For that reason, we have programmed extra functions on some of the unused number keys to help you control your equipment.

Resetting the Microcomputer

The microcomputer may malfunction (unit cannot be operated, or shows an erroneous display) if the power cord is unplugged while the power is ON, or due to some other external factor. If this happens, execute the following procedure to reset the microcomputer and return the unit to its normal operating condition.

With the power cord plugged in, turn the POWER ON/OFF key OFF. Then, while holding down the ON/STANDBY  key, press POWER ON/OFF.

- Please note that resetting the microcomputer will clear the contents of the memory and returns the unit to the state it was in when it left the factory.

Amplifier

Symptom	Cause	Remedy
No sound from the speakers.	<ul style="list-style-type: none"> • The speaker cords are disconnected. • VOLUME is set to the minimum position. • MUTE is ON. • The SPEAKERS switches are set to OFF. 	<ul style="list-style-type: none"> • Connect them properly referring to "Connecting the speakers" - 15 • Adjust the volume to a proper level. • Turn OFF the MUTE. - 24 • Set the SPEAKERS switches to ON. - 23
The standby indicator blinks and sound is not output.	<ul style="list-style-type: none"> • Speaker cords are short-circuited. 	<ul style="list-style-type: none"> • Turn the power off, eliminate the short-circuiting, then turn on the power again.
Sound is not output from one of the speakers.	<ul style="list-style-type: none"> • The speaker cord is disconnected. • The speaker is not set up correctly. 	<ul style="list-style-type: none"> • Connect it properly referring to "Connecting the speakers". - 15 • Set it up properly referring to "Speaker settings". - 19
Sound is not output from the surround speakers and / or the center speaker, or their sound is very small.	<ul style="list-style-type: none"> • The surround speaker cords and/or the center speaker cord is disconnected. • The speaker is not set up correctly. • A surround mode has not been engaged. • The surround and/or center volume controls are set to the minimum level. 	<ul style="list-style-type: none"> • Connect it properly referring to "Connecting the speakers". - 15 • Set it up properly referring to "Speaker settings". - 19 • Select a surround mode. • Adjust the speaker levels using the test tone. - 20
A humming noise is generated when the PHONO input selector is selected.	<ul style="list-style-type: none"> • The audio cord from the record player is not connected to the PHONO jacks. • The record player is not grounded. 	<ul style="list-style-type: none"> • Insert the audio cord plugs securely into the PHONO jacks. • Connect the grounding wire to the GND terminal on the rear panel.
When playing a Dolby Digital source signal using a DVD player, the sound is cut off soon after it starts.	<ul style="list-style-type: none"> • There are many possible causes for this problem, depending on the type of DVD player used. 	<ul style="list-style-type: none"> • Set the input mode to digital manual before starting playback of the Dolby Digital source. - 8
No sound is produced during playback from a DVD player.	<ul style="list-style-type: none"> • The input mode is set to digital manual. 	<ul style="list-style-type: none"> • Press the INPUT MODE key to select to full auto mode. - 8
A video source cannot be recorded normally.	<ul style="list-style-type: none"> • The software is copy-guarded. 	<ul style="list-style-type: none"> • Copy-guarded video software cannot be recorded.

Tuner

Symptom	Cause	Remedy
Radio stations cannot be received.	<ul style="list-style-type: none"> • No antenna is connected. • The broadcast band is not set properly. • The frequency of the desired station is not tuned. 	<ul style="list-style-type: none"> • Connect an antenna. - 18 • Set the broadcast band properly. • Tune the frequency of the desired station. - 27
Interference.	<ul style="list-style-type: none"> • Noise due to ignition noise from an automobile. • Noise due to interference from an electric appliance. • Noise due to a nearby TV set. 	<ul style="list-style-type: none"> • Install the outdoor antenna away from the road. • Turn off the power to the appliance. • Install the receiver farther away from the TV.
A station which was preset cannot be received by pressing the corresponding numeric key.	<ul style="list-style-type: none"> • The preset station belongs to a frequency that cannot be received. • The preset memory was cleared because the power cord had been unplugged for a long period of time. 	<ul style="list-style-type: none"> • Preset a station with a receivable frequency. • Preset the station again.

Remote control unit

Symptom	Cause	Remedy
Certain inputs cannot be selected using the remote control.	<ul style="list-style-type: none"> No setup codes registered for the respective input(s). 	<ul style="list-style-type: none"> Register a setup code at the respective input(s). → [39]
Remote control operation is not possible.	<ul style="list-style-type: none"> The remote control is set to a different operation mode. Batteries are exhausted. The remote control unit is too far away from the main system, controlling angle is too large, or there is an obstacle between the receiver and the remote. No tape or CD is placed in the source component. An attempt is made to play a tape which is being recorded in the cassette deck. The remote control has not been set to the operation mode for the component you wish to control. 	<ul style="list-style-type: none"> Press any of the Input Selector keys to select the appropriate operation mode. Replace with new batteries. Operate the remote control unit within the controllable range. Place the tape or CD in the source component which you want to play. Wait until recording has completed. Press any of the source keys or SRC Power key to activate the operation mode for the component you want to control before operation. → [40]

AUDIO section

Rated power output during STEREO operation
 DIN/IEC (20 Hz ~ 20kHz, 0.09 % T.H.D. at 6 Ω)..... 100 W + 100 W
 (1 kHz, 10 % T.H.D. at 6 Ω) 150 W + 150 W

Effective power output during SURROUND operation

FRONT
 (20 Hz ~ 20 kHz, 0.09 % T.H.D. at 6 Ω one channel driven)
 100 W + 100 W
 (1 kHz, 10 % T.H.D. at 6 Ω one channel driven) 150 W + 150 W

CENTER
 (20 Hz ~ 20 kHz, 0.09 % T.H.D. at 6 Ω one channel driven)
 100 W
 (1 kHz, 10 % T.H.D. at 6 Ω one channel driven) 150 W

SURROUND
 (20 Hz ~ 20 kHz, 0.7 % T.H.D. at 6 Ω one channel driven)
 100 W + 100 W
 (1 kHz, 10 % T.H.D. at 6 Ω one channel driven) 150 W + 150 W

SURROUND BACK
 (20 Hz ~ 20 kHz, 0.7 % T.H.D. at 6 Ω one channel driven)
 100 W + 100 W
 (1 kHz, 10 % T.H.D. at 6 Ω one channel driven) 150 W + 150 W

Total harmonic distortion 0.009 % (1 kHz, 50 W, 6 Ω)
 Frequency response
 Line (CD/DVD, TAPE, VIDEO 1, VIDEO 2, VIDEO 3, DVD/6CH)
 10 Hz ~ 100 kHz, 0 dB ~ -3.0 dB
 PHONO 'RIAA' response 40 Hz ~ 20 kHz, +1.5 dB ~ -3.0 dB
 Maximum input level
 PHONO (MM) 40 mV, 1 % T.H.D. at 1 kHz
 Signal to noise ratio (IHF'66)
 PHONO (MM) 75 dB
 Line (CD/DVD, TAPE, VIDEO 1, VIDEO 2, VIDEO 3, DVD/6CH)
 95 dB

Loudness control
 VOLUME at -30 dB level +6 dB (100 Hz)

Input sensitivity / impedance
 PHONO (MM) 4 mV / 47 kΩ
 Line (CD/DVD, TAPE, VIDEO 1, VIDEO 2, VIDEO 3, DVD/6CH)
 300 mV / 47 kΩ

Output level / impedance
 TAPE REC 300 mV / 1 kΩ
 PRE OUT (FRONT CHANNEL) 1 V / 500 Ω
 PRE OUT (CENTER CHANNEL) 1 V / 500 Ω
 PRE OUT (SURROUND CHANNEL) 1 V / 500 Ω
 PRE OUT (SURROUND BACK CHANNEL) 1 V / 500 Ω
 PRE OUT (SUBWOOFER) 1 V / 500 Ω

Tone control
 BASS ±10 dB (at 100 Hz)
 TREBLE ±10 dB (at 10 kHz)

DIGITAL AUDIO section

Sampling frequency 32 kHz, 44.1 kHz, 48 kHz, 96 kHz
 Input level / impedance / wave length
 Optical -15 dBm ~ -24 dBm, 660 nm ±30 nm
 Coaxial 0.5 Vp-p / 75 Ω
 Output level / impedance / wave length
 Optical -21 dBm ~ -15 dBm, 660 nm ±30 nm

VIDEO section

VIDEO inputs / outputs
 VIDEO (composite) 1 Vp-p / 75 Ω

S VIDEO inputs / outputs
 S VIDEO (luminance signal) 1 Vp-p / 75 Ω
 S VIDEO (chrominance signal) 0.286 Vp-p / 75 Ω

COMPONENT VIDEO inputs/ outputs
 COMPONENT VIDEO (luminance signal) 1 Vp-p / 75 Ω
 COMPONENT VIDEO (CB/CR-signal) 0.7 Vp-p / 75 Ω

FM tuner section

Tuning frequency range 87.5 MHz ~ 108.0 MHz
 Usable sensitivity
 MONO 1.3 μV (75 Ω)/ 13.2 dBf (40 kHz dev, S/N 26 dB)
 STEREO 45 μV (75 Ω)/ 42.1 dBf (40 + 6 kHz dev, S/N 46 dB)

Total harmonic distortion (DIN at 1 kHz)
 MONO (1 kHz, 40 kHz dev) 0.2% (65.2 dBf input)
 STEREO (1 kHz, 40 + 6 kHz dev) 0.8% (65.2 dBf input)

Signal to noise ratio (DIN weighted at 1 kHz)
 MONO 65 dB (65.2 dBf input)
 STEREO 60 dB (65.2 dBf input)

Stereo separation (1 kHz) 36 dB
 Selectivity (DIN ±300 kHz) 64 dB
 Frequency response (30 Hz ~ 15 kHz) +0.5 dB, -3.0 dB

AM tuner section

Tuning frequency range 531 kHz ~ 1,602 kHz
 Usable sensitivity (30% mod, S/N 20 dB) 16 μV / (600 μV/m)
 Signal to noise ratio (30% mod, 400 Hz) 50 dB (60 dBμV EMF input)

GENERAL

Power consumption 330 W
 Standby Power consumption less than 1.5W
 AC outlet
 SWITCHED (total 90 W max.)

Dimensions W : 440 mm (17-5/16")
 H : 159 mm (6-1/4")
 D : 392 mm (15-7/16")

Weight (Net) 12.0 kg (26.5 lb)

Notes

1. KENWOOD follows a policy of continuous advancements in development. For this reason specifications may be changed without notice.
2. The full performance may not be exhibited in an extremely cold location (under a water-freezing temperature).

KENWOOD

For your records

Record the serial number, found on the back of the unit, in the spaces designated on the warranty card, and in the space provided below. Refer to the model and serial numbers whenever you call upon your dealer for information or service on this product.

Model _____ Serial Number _____

Free Manuals Download Website

<http://myh66.com>

<http://usermanuals.us>

<http://www.somanuals.com>

<http://www.4manuals.cc>

<http://www.manual-lib.com>

<http://www.404manual.com>

<http://www.luxmanual.com>

<http://aubethermostatmanual.com>

Golf course search by state

<http://golfingnear.com>

Email search by domain

<http://emailbydomain.com>

Auto manuals search

<http://auto.somanuals.com>

TV manuals search

<http://tv.somanuals.com>