

KENWOOD

MDX-G3

MINIDISC PERSONAL STEREO SYSTEM

INSTRUCTION MANUAL



MDLP

B60-4854-00 01 (MA) (M) (AP) 0009

Before applying power

⚠ Caution : Read this page carefully to ensure safe operation.

Units are designed for operation as follows.

U.S.A. and Canada AC 120 V only
Australia AC 240 V only
Europe and U.K. AC 230 V only

China and Russia AC 220 V only
Other countries AC 110 - 120 / 220 - 240 V
switchable

For the United Kingdom

Factory fitted moulded mains plug

1. The mains plug contains a fuse. For replacement, use only a 13-Amp ASTA-approved (BS1362) fuse.
2. The fuse cover must be refitted when replacing the fuse in the moulded plug.
3. Do not cut off the mains plug from this equipment. If the plug fitted is not suitable for the power points in your home or the cable is too short to reach a power point, then obtain an appropriate safety approved extension lead or adapter, or consult your dealer.

If nonetheless the mains plug is cut off, remove the fuse and dispose of the plug immediately, to avoid a possible shock hazard by inadvertent connection to the mains supply.

IMPORTANT: The wires in the mains lead are coloured in accordance with the following code:





Blue : Neutral

Brown : Live

Do not connect those leads to the earth terminal of a three-pin plug.

Safety precautions

WARNING : TO PREVENT FIRE OR ELECTRIC SHOCK, DO NOT EXPOSE THIS APPLIANCE TO RAIN OR MOISTURE.

	CAUTION RISK OF ELECTRIC SHOCK DO NOT OPEN		CAUTION: TO REDUCE THE RISK OF ELECTRIC SHOCK, DO NOT REMOVE COVER (OR BACK). NO USER-SERVICEABLE PARTS INSIDE. REFER SERVICING TO QUALIFIED SERVICE PERSONNEL.
	THE LIGHTNING FLASH WITH ARROWHEAD SYMBOL, WITHIN AN EQUILATERAL TRIANGLE, IS INTENDED TO ALERT THE USER TO THE PRESENCE OF UNINSULATED "DANGEROUS VOLTAGE" WITHIN THE PRODUCT'S ENCLOSURE THAT MAY BE OF SUFFICIENT MAGNITUDE TO CONSTITUTE A RISK OF ELECTRIC SHOCK TO PERSONS.		
	THE EXCLAMATION POINT WITHIN AN EQUILATERAL TRIANGLE IS INTENDED TO ALERT THE USER TO THE PRESENCE OF IMPORTANT OPERATING AND MAINTENANCE (SERVICING) INSTRUCTIONS IN THE LITERATURE ACCOMPANYING THE APPLIANCE.		

The marking of products using lasers (Except for some areas)

CLASS 1
LASER PRODUCT

CAUTION
INVISIBLE LASER RADIATION
WHEN OPEN. AVOID EXPOSURE
TO BEAM.

The marking is located on the rear panel and says this product has been classified as Class 1. It means that there is no danger of hazardous radiation outside the product

Inside this laser product, a laser diode classified as Class 3B laser radiation is contained as alerted by the internal caution label shown above. To avoid exposure to laser beams, do not open the cover.

Contents

Caution : Read the pages marked  carefully to ensure safe operation.

 Before applying power	2
 Safety precautions	2

Preparation section

System connection	4-6
Unpacking	4
Loading batteries	
in the remote control unit	4
Connecting the accessories	5
Connecting other components	6
Adjusting the present time	7
Presetting radio stations	8-9
Presetting stations automatically	
(AUTO PRESET)	8
Presetting stations manually	
(MANUAL PRESET)	9

Basic section

Playback of CD	10
Playback of MD	12
Playback of TAPE	14
Receiving broadcast stations	16
Playing audio input from AUX component	18
Recording CD onto MD (MD O.T.E.)	20
Recording CD onto TAPE (TAPE O.T.E.)	22

Application section

Displayed information	26-27
Viewing the CD information	26
Viewing the MD information	27
Adjusting the tone	28
Enhancement of bass and treble	
(EX.BASS / LOUDNESS)	28
Fine adjustment of bass and treble	
(TONE)	28
Adjusting the AUX input level	29
Muting the audio temporarily (MUTE)	29
Playing CD or MD tracks	
in the desired sequence (PGM)	30
Repeating a CD or MD (REPEAT)	31
Playing a CD or MD in a random (RANDOM) ...	31

Stereo LP modes	32
Types of recording modes	32
Setting the recording mode	33
High-speed recording	
of all CD tracks onto an MD	34
Recording onto MD	36
Recording onto TAPE	38
Recording CD tracks onto MD or TAPE	
in desired sequence	39
Recording MD tracks onto TAPE	
in desired sequence	40
Recording only the first track of CD	
(BEST HITS)	41
Editing the MD titles	42-46
Assigning a title to a disc or track	42
Registering titles	44
Copying titles	45
Title editing character list	46
Moving one track	47
Moving several tracks at a time	48
Combining tracks	49
Dividing a track	50
Erasing a track	51
Erasing several tracks at a time	52
Canceling editing	53
Waking up to the timer playback (O.T.T.)	54
Program timer (PROG.1, PROG.2)	56-59
Timer playback using program timer	56
Timer recording using program timer	58
Sleep timer (SLEEP)	60
Auto power save (A.P.S.)	60

Knowledge section

Important items	61
In case of difficulty	65
Display message list	68
Specifications	70
Controls and indicators	71

System connection

Unpacking

Unpack the unit carefully and make sure that all the accessories are present.

POWER cord (1)

AM loop antenna (1)

Remote control unit (1)

Batteries(R6/AA)
for remote (2)

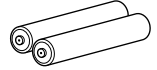
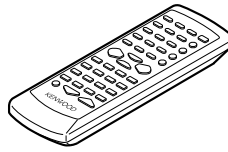
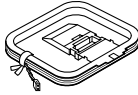

If any accessories are missing, or if the unit is damaged or fails to operate, notify your dealer immediately. If the unit was shipped to you directly, notify your shipper immediately. Kenwood recommends that you retain the original carton and packing materials in case you need to move or ship the unit in the future.

Keep this manual handy for future reference.

Loading batteries in the remote control unit

(1) Remove the battery compartment cover of the remote.

(2) Insert two R6("AA"-size) batteries following the polarity indications.

(3) Attach the battery compartment cover.

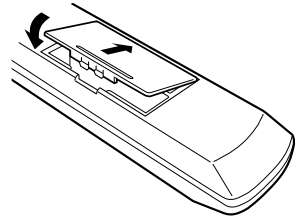
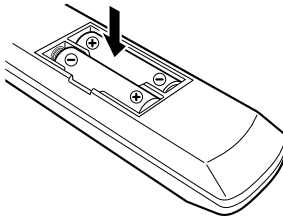
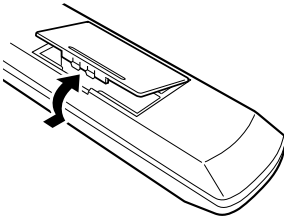

- The provided batteries are intended for use in operation checking, and their service life may be short.
- When the remote-controllable distance becomes short, replace both of the batteries with new ones.
- If direct sunlight or the light of a high-frequency fluorescent lamp (inverter type, etc.) is incident to the remote sensor on the main unit front panel, malfunction may occur. In such a case, change the installation position to avoid malfunction.
- When pressing more than one remote control keys successively, press each key securely by leaving an interval of 1 second or more between keys.
- The standard remote-control range is within about 6 meters from the main unit front panel. Be sure to point the remote to remote sensor on the front panel.

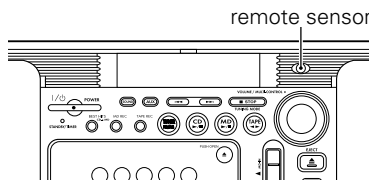

Connecting the accessories

FM rod antenna

Extend the FM antenna and orient it to obtain the best receiving condition possible.

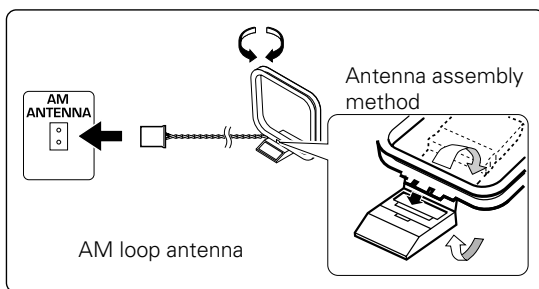
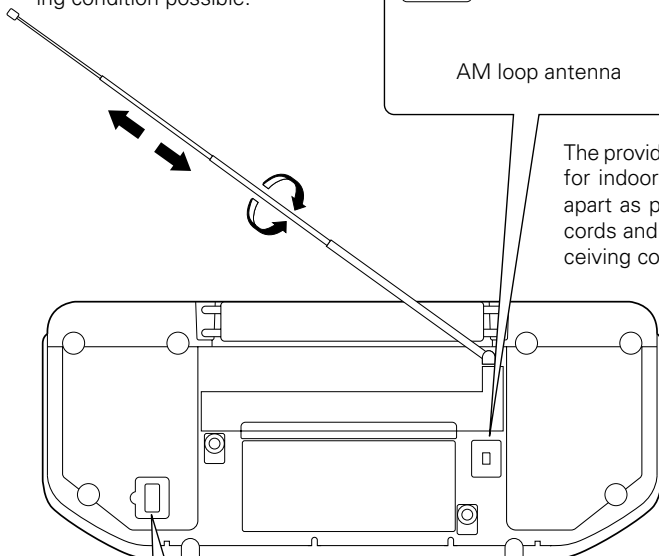

AM loop antenna

The provided antenna has been designed for indoor use. Place it in a position as apart as possible from a TV and power cords and orient it to obtain the best receiving condition.

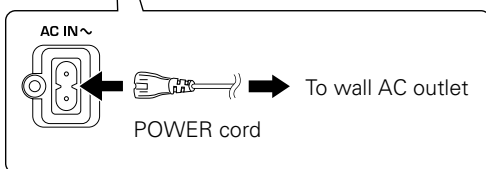

- When removing the power cord connection, unplug the power plug of the wall outlet first.

POINT

- Be sure to insert each connection cord securely. If a cord is plugged in incompletely, audio may not be output or noise may be generated.
- Before connecting or disconnecting any connection cord, be sure to first unplug the power cord from the wall power outlet.
- Do not install the speakers near a TV set. Otherwise, color irregularities due to magnetism may be observed on the TV screen.
- Be sure to put the unit to the STANDBY mode (page 71) before plugging or unplugging the power cord.

Continued on next page →

Connecting other components

headphones

Plug the optional headphones equipped with stereo mini-plugs.

- When listening audio through speakers, unplug the headphones from the PHONES jack.

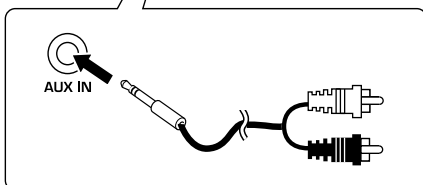
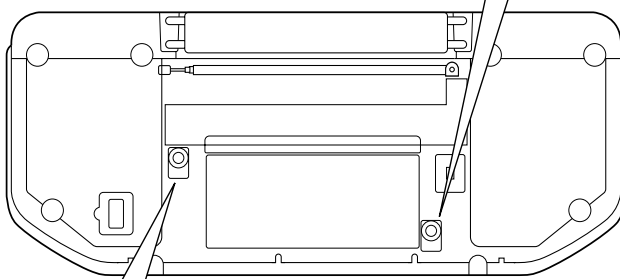
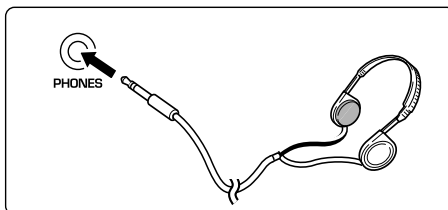

AUX (auxiliary) component

An additional MD player, cassette tape or analog turntable with built-in equalizer (such as the P-110) which are available separately can optionally be connected to the system using an audio cable with stereo mini-plugs (option).

- The AUX IN terminals are input jacks. An AUX component for use in recording cannot be connected to the system.
- When recording an AUX component, also read the instruction manual of the component.
- When an analog turntable is connected and located in proximity of the system, howling noise may interfere with the system when the listening volume is increased. In this case, install the analog turntable farther apart from the system.
- The input level from the AUX component can be adjusted on this system. (page 29)

In regard to demonstration

This unit incorporates a demonstration mode (display only). The demonstration shows the display conditions of various operation modes by switching them sequentially, but the audio does not vary during it.

When the power supply fails and restores or the power cord is unplugged and plugged during operation, the unit automatically enters the demonstration mode ("DEMO ON").

To cancel demonstration mode : Press the SET/(DEMO) key while "DEMO ON" is displayed.

To enter demonstration mode : Keep on pressing the SET/(DEMO) key for more than 2 seconds while the unit is ON.

Adjusting the present time

To use the timer function, it is required to set the built-in clock of the unit to the correct time. The clock shows the time of day in 12-hour system.

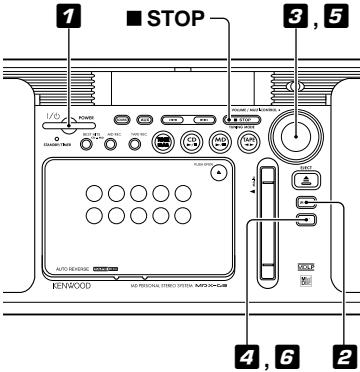

Main unit only

1 Press the **POWER** | /  key to turn power on.

2 Press and hold the **MENU** key for more than 2 seconds.



3 Rotate the **VOLUME/MULTI-CONTROL** knob to select the figure of hour.

Example : Adjustment to AM 8:07



12 o'clock of day is displayed as "PM 12:00" and 12 o'clock of night is displayed as "AM 12:00".

4 Press the **SET** key.



5 Rotate the **VOLUME/MULTI-CONTROL** knob to input the figure of minute.



6 Press the **SET** key.

To check the time of day :

Press the  STOP key while the unit is in the STANDBY mode (page 71).

POINT

- After a power failure, when the power cord is unplugged and plugged again or when the STANDBY/TIMER indicator blinks in green, the present time should be adjusted again.
- In step **6**, accurate time adjustment is possible by pressing the SET key at the same time as a time announcement indicating the 00 second of the minute.

Presetting radio stations

A total of 30 desired stations can be stored in the auto and manual preset memory.

Presetting stations automatically (AUTO PRESET)

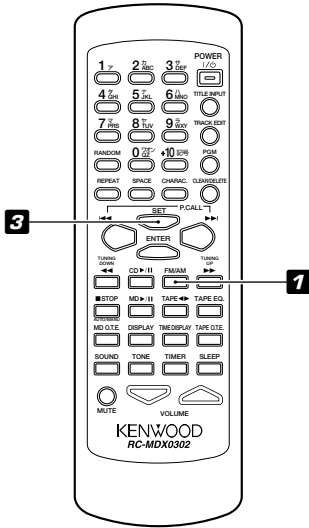

- 1 Press the **TUNER FM/AM** key (or the **FM/AM** key on the remote) so that the "FM" or "AM" band is selected.

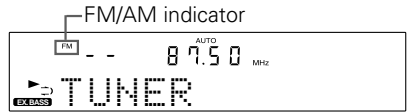

- 2 Press the **MENU** key.
- 3 Rotate the **VOLUME/MULTI-CONTROL** knob so that "AUTO PRESET" is displayed, then press the **SET** key.



The AUTO PRESET operation starts and blinking "AUTO PRESET" is displayed. FM stations are preset first, after which the AM stations are preset.

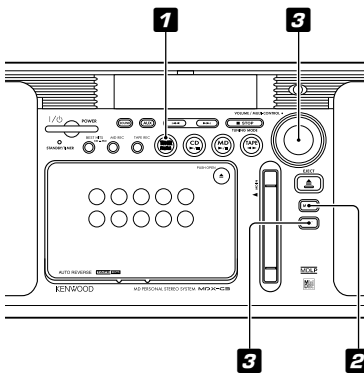

POINT

- When AUTO PRESET is performed, the stations previously preset will be replaced by the newly preset stations.
- In certain regions, the automatically tuned and preset stations may not be receivable in a favorable condition.

If a desired station cannot be preset by AUTO PRESET, use MANUAL PRESET to preset it. (page 9)

Presetting stations manually (MANUAL PRESET)

Among the receivable stations, only the desired stations can be received and preset individually.

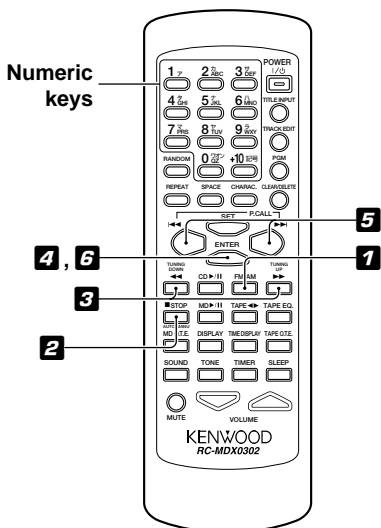

4 Press the **ENTER** key during reception.

5 While " - - " is blinking, press the **◀◀P.CALL** or **▶▶P.CALL** key repeatedly to select the desired preset number.

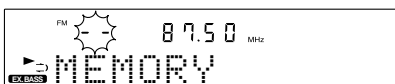

Press and hold the **◀◀P.CALL** or **▶▶P.CALL** key to skip preset numbers. The preset number can also be selected by pressing numeric keys.

Examples

To select preset No. 13 : +10, 3

To select preset No. 20 : +10, +10, 0

6 Press the **ENTER** key.

Remote control unit only

1 Press the **FM/AM** key so that the "FM" or "AM" band is selected.

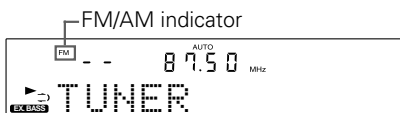

2 Press the **AUTO/MANU** key so that "AUTO" is lit.



3 Press the **◀◀TUNING DOWN** or **▶▶TUNING UP** key to tune in the desired station.

To preset another station :

Repeat steps **1** to **6**.

To preset a station with weak radio wave :

In step **2**, select the manual tuning mode by pressing the **AUTO/MANU** key so that "AUTO" turns off.



- When a station is preset in a preset number which stores a previously preset station, the newly preset information overwrites the previously preset information.

Playback of CD

To play a CD.

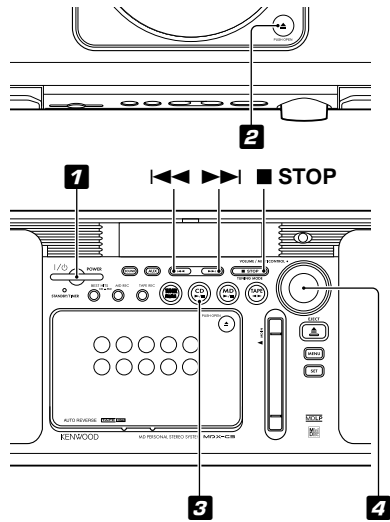
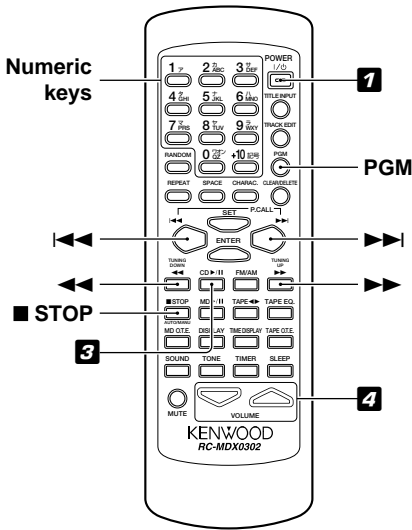

1 Press the **POWER** | $\text{\textcircled{P}}$ key to turn power on.

2 Insert a CD.

The CD should be placed horizontally on the tray. To prevent malfunction, do not place it obliquely.

- (1) Open the CD door by pressing the area marked \blacktriangle PUSH OPEN of the CD door.
- (2) Place a CD.
- (3) Close the CD door by pressing the area marked \blacktriangle PUSH OPEN of the CD door.

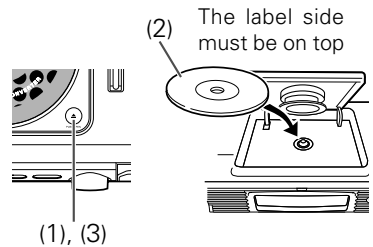

3 Press the **CD** \blacktriangleright / \parallel key.

Play indicator Track No. Elapsed play time of track being played

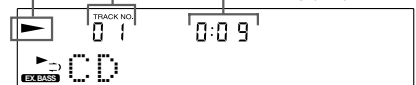

4 Rotate the **VOLUME/MULTI-CONTROL** knob to adjust the listening volume. The volume can also be adjusted using the **VOLUME** keys on the remote.

Operation of keys

Purpose	Operation
To stop playback	Press the ■STOP key.
To let playback pause	Press the CD ►/ key. Press it again to resume playback.
To skip a track	Press the ►► key to skip to the next track. Press the ◀◀ key quickly twice to skip to the previous track.
To fast forward audio	Press and hold the ►► key on the remote during playback, and release the key at the position you want to restart normal playback.
To fast reverse audio	Press and hold the ◀◀ key on the remote during playback, and release the key at the position you want to restart normal playback.
To start playback from the desired track	Specify the desired track number using the numeric keys on the remote. Examples Track No 10 : +10, 0 Track No 23 : +10,+10, 3 If "PGM" is lit, turn it off by pressing the PGM key on the remote.

To take out the CD :

Stop playback by pressing the ■STOP key, then press the area marked ▲PUSH OPEN on the CD door to open it.

POINT

- Do not force open or close the CD door, for this will lead to malfunction.
- When a CD has been inserted while the power is OFF, simply pressing the CD ►/|| key in the STANDBY mode (page 71) turns the power ON and starts playback. (One-touch operation)
- When a CD-TEXT compatible disc is played on this system, it automatically displays the disc title and track titles in the disc provided that these titles are input in alphanumeric characters. The system may sometimes be unable to play certain characters even when a CD-TEXT disc is played.
- For the types of CDs that can be played on this unit, see "Discs which can be played with this unit" (page 61).

Playback of MD

To play an MD.

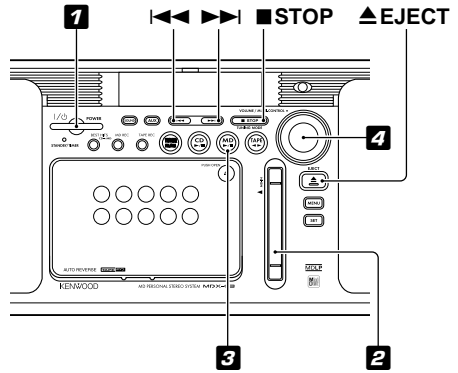
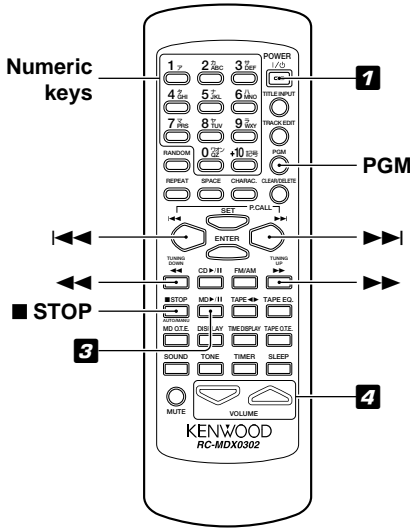

1 Press the **POWER** | / $\text{\textcircled{P}}$ key to turn power on.

2 Insert an MD.

Insert an MD into the insertion slot of the main unit.

Insert with the shutter facing upward

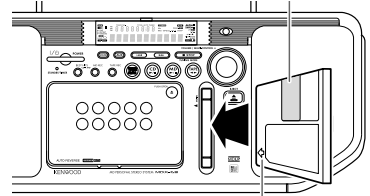

In the direction of the arrow

3 Press the **MD** \blacktriangleright / \parallel key.

Play indicator Track No. Elapsed play time of track being played



Track title

4 Rotate the **VOLUME/MULTI-CONTROL** knob to adjust the listening volume. The volume can also be adjusted using the **VOLUME** keys on the remote.

Operation of keys

Purpose	Operation
To stop playback	Press the ■STOP key.
To let playback pause	Press the MD ►/ key. Press it again to resume playback.
To skip a track	Press the ►► key to skip to the next track. Press the ◀◀ key quickly twice to skip to the previous track.
To fast forward audio	Press and hold the ►► key on the remote during playback, and release the key at the position you want to restart normal playback.
To fast reverse audio	Press and hold the ◀◀ key on the remote during playback, and release the key at the position you want to restart normal playback.
To start playback from the desired track	Specify the desired track number using the numeric keys on the remote. Examples Track No 10 : +10, 0 Track No 23 : +10,+10, 3 Track No 102 : +10 x 10 times, 2 If "PGM" is lit, turn it off by pressing the PGM key on the remote.

To take out the MD :

Stop playback by pressing the ■STOP key, then press the ▲EJECT key.

MD play mode indicators :

Each track in MD is played back in the mode used when it was recorded. When an MD starts to be played, the current play mode is indicated by one of the play mode indicators.

Off : Track recorded in standard stereo mode (using an MD recorder without the MDLP* mode compatibility).

MONO : Track recorded in the monaural LP (long play) mode.

LP2 : Track recorded in the stereo LP2 mode.

LP4 : Track recorded in the stereo LP4 mode.

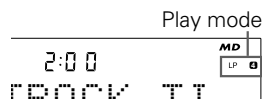

* Marking "MDLP" is indicated on an MD recorder or player compatible with the stereo LP2(LP4) mode based on ATRAC3 which is a new audio compression system in compliance with the MD standard or on an MD medium recorded using ATRAC3 (with a playback-only MD).

POINT

- The MD cannot be inserted or ejected in the STANDBY mode. Do not force insert an MD in the STANDBY mode (page 71), for this will lead to malfunction.
- When an MD has been inserted while the power is OFF, simply pressing the MD ►/|| key in the STANDBY mode turns the power ON and starts playback. (One-touch operation)
- When the MD contains recording of title information, the titles of the disc or tracks recorded in the MD are displayed.

Playback of TAPE

To play a tape.

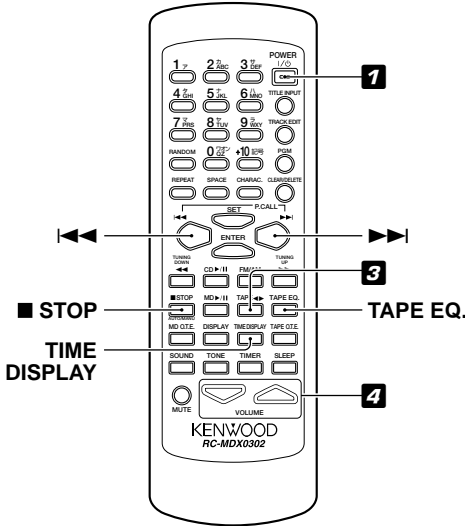

Do not use a cassette with more than 90-minute recording time, for the tape used with such a cassette is very thin and tends to cause troubles such as entanglement around the pinch roller or cutting of tape.

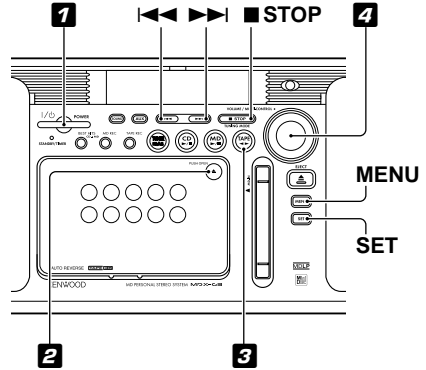

1 Press the **POWER** / ⏻ key to turn power on.

2 Load a tape.

- (1) Press the area marked ▲PUSH OPEN on the cassette holder to open it, and insert a cassette tape.
- (2) Press the area marked ▲PUSH OPEN to close the cassette holder.

Insert with the side to be played facing the front.

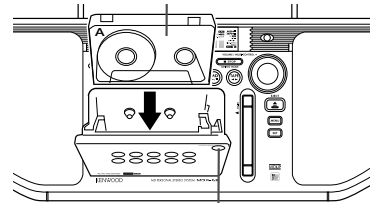

(1), (2)

3 Press the **TAPE** ◀▶ key.

Each press of the key alternates the tape transport direction.

"▶" : Playback of side A.

"◀" : Playback of side B.

Tape transport direction Tape counter



Reverse mode

4 Rotate the **VOLUME/MULTI-CONTROL** knob to adjust the listening volume. The volume can also be adjusted using the **VOLUME** keys on the remote.

Operation of keys

Purpose	Operation
To stop playback	Press the ■STOP key.
To fast forward tape	In stop mode, press the ►► if the current tape transport direction is "►" (or the ◀◀ key if it is "◀").
To rewind tape	In stop mode, press the ◀◀ if the current tape transport direction is "►" (or the ►► key if it is "◀").

To take out the TAPE :

Stop playback by pressing the ■STOP key, then press the ▲PUSH OPEN.

Playing a Dolby-encoded tape (TAPE EQ.) :

The TAPE EQ. (tape equalizer) key is used only when playing a tape which has been recorded with Dolby NR. It makes it possible to reduce noise in high frequencies.

Press the TAPE EQ. key on the remote so that the "TAPE EQ." indicator is lit.

- When playing a tape recorded without Dolby NR, the audio will not be played normally if the TAPE EQ. key is pressed. Be sure to turn the "TAPE EQ." indicator off by pressing the TAPE EQ. key on the remote.

Setting the reverse mode of tape (TAPE RVS.) :

- (1) Press the MENU key.
- (2) Rotate the VOLUME/MULTI-CONTROL knob so that "TAPE RVS.?" is displayed, then press the SET key.
- (3) Rotate the VOLUME/MULTI-CONTROL knob so that the desired reverse mode is displayed, then press the SET key.
 - "1" : ONE-WAY Tape will stop after a single side has been played.
 - "2" : REVERSE Tape will stop after both sides have been played.
 - "∞" : ENDLESS Tape playback continues by repeating both sides.

POINT

- By loading a tape beforehand, simply pressing the TAPE ◀► key in the STANDBY mode (page 71) turns the power ON and starts playback of the tape. (One-touch operation)
- Each press of the TIME DISPLAY key on the remote alternates the displayed information between tape counter and time display.
- The tape counter is reset to "0000" every time the cassette holder is opened and closed.
- The cassette deck of the system is capable of playing only the normal (TYPE I) tapes.
- Do not open the cassette holder in the middle of playback. Otherwise, malfunction may occur.

Receiving broadcast stations

Previously stored (preset) radio stations can be tuned in with a one-touch operation. For the preset procedure, see "Presetting radio stations" (page 8 to 9).

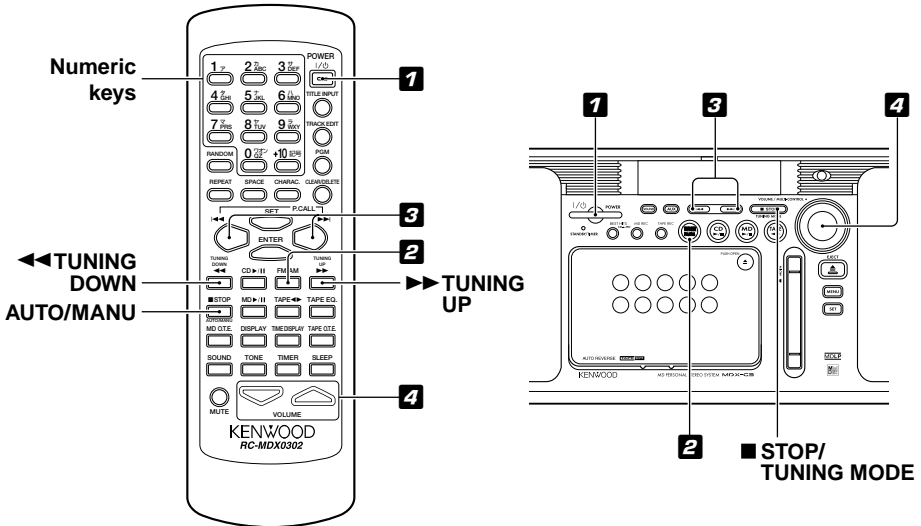

1 Press the **POWER** | / $\text{\textcircled{P}}$ key to turn power on.

2 Press the **TUNER FM/AM** key (or the **FM/AM** key on the remote).

3 Press the **◀◀** or **▶▶** key on the main unit (or the **◀◀ P.CALL** or **▶▶ P.CALL** key on the remote) to select a preset station.

Each press of the key switches the preset station in sequence.

4 Rotate the **VOLUME/MULTI-CONTROL** knob to adjust the listening volume. The volume can also be adjusted using the **VOLUME** keys on the remote.

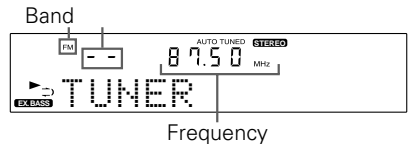

To tune a radio station using numeric keys :

Input the preset number of the desired station using the numeric keys on the remote.

Examples

Preset No. 23 : +10, +10, 3

Preset No. 40 : +10, +10, +10, +10, 0

Receiving non-preset broadcast stations

A radio station can be tuned either by auto tuning or manual tuning according to the current reception condition.

(1) Press the **■STOP/TUNING MODE** key on the main unit (or the **AUTO/MANU** key on the remote) to select "AUTO" or "MANUAL".

"AUTO" : Select this mode when the reception of radio stations is in a good condition.

"MANUAL" : Select this mode when the reception of radio stations is interfered with noise.

● Usually leave "AUTO" lit (auto tuning mode, stereo reception).

(2) While "AUTO" or "MANUAL" indicator is lit, press the **◀◀** or **▶▶** key on the main unit (or the **◀◀ TUNING DOWN** or **▶▶ TUNING UP** key on the remote) to receive the desired station.

Auto tuning : Each press of the key tunes the next station automatically.

Manual tuning : Press and hold the key until the next station is tuned.

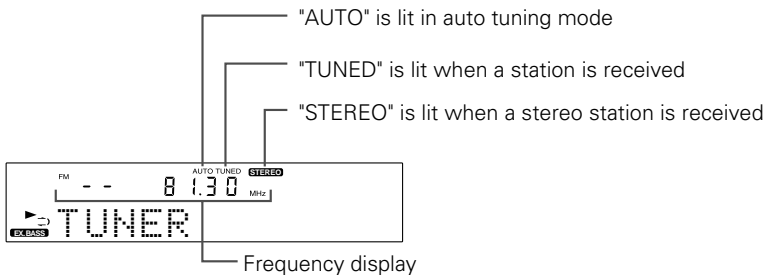

POINT

- When the unit is in the STANDBY mode (page 71), simply pressing the TUNER FM/AM key (or the FM/AM key on the remote) turns the power ON and starts radio play. (One-touch operation)
- During tuning, pressing and holding the **◀◀** or **▶▶** key on the main unit (or the **◀◀ TUNING DOWN** or **▶▶ TUNING UP** key on the remote) makes it possible to skip undesired stations that may be received before the target station.

Playing audio input from AUX component

The audio from the AUX component can be monitored as follows.

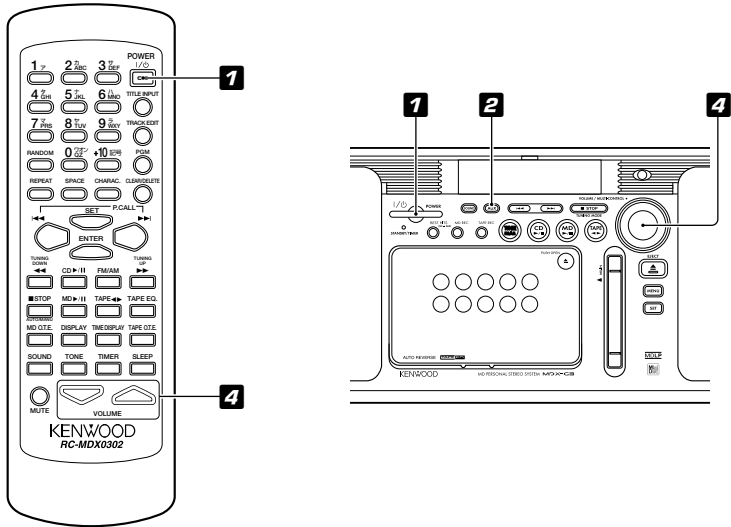

1 Press the **POWER** | / $\text{\textcircled{P}}$ key to turn power on.

2 Press the **AUX** key.

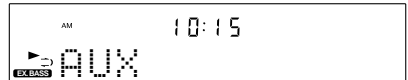

3 Play the component connected to the **AUX** input jacks.

4 Rotate the **VOLUME/MULTI-CONTROL** knob to adjust the listening volume. The volume can also be adjusted using the **VOLUME** keys on the remote.

Recording CD onto MD (MD O.T.E.)

The MD O.T.E. (One-Touch Edit) function makes it possible to record all tracks in a CD on an MD with a one-touch operation (All-track recording). It is also capable of recording the currently played CD track on an MD with a one-touch operation (Single-track recording).

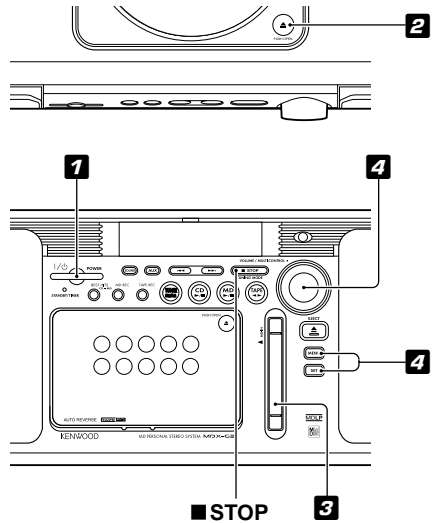
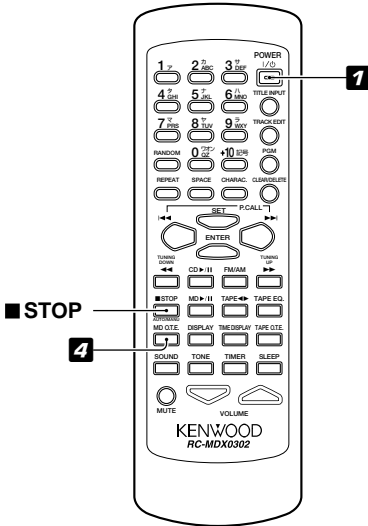

1 Press the **POWER** | / $\text{\textcircled{P}}$ key to turn power on.

2 Insert a CD.

The CD should be placed horizontally on the tray. To prevent malfunction, do not place it obliquely.

- (1) Open the CD door by pressing the area marked \blacktriangle PUSH OPEN of the CD door.
- (2) Place a CD.
- (3) Close the CD door by pressing the area marked \blacktriangle PUSH OPEN of the CD door.

If the CD is already playing, press the \blacksquare STOP key to stop playback.

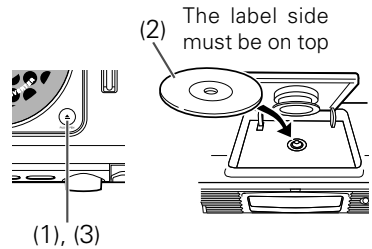

3 Insert a recordable MD.

Insert an MD into the insertion slot of the main unit.

Insert with the shutter facing upward

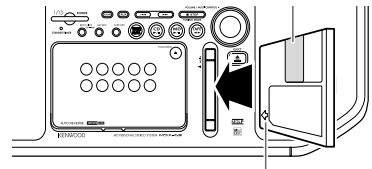

In the direction of the arrow

4 Press the MD O.T.E. key on the remote.

If you are operating the main unit :

- (1) Press the MENU key.
- (2) Rotate the VOLUME/MULTI-CONTROL knob so that "REC OPTIONS" is displayed, then press the SET key.
- (3) Rotate the VOLUME/MULTI-CONTROL knob so that "CD→MD" is displayed, then press the SET key.

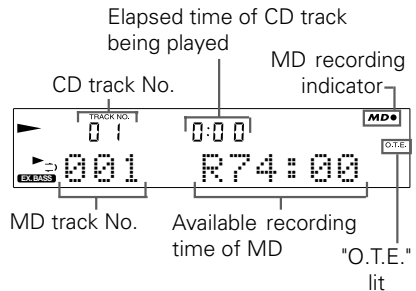

Recording the CD track being played (Single-track recording)

- (1) Play the CD track to be recorded.
- (2) Press the MD O.T.E. key on the remote.

When you are operating the main unit, see step 4.

Recording starts after returning to the beginning of the current track.

To stop recording in the middle :

Press the ■STOP key.

POINT

- Be careful not to turn power off or apply shock or vibrations to the system while "MD WRITING" is displayed.
- For the types of MDs that can be recorded on this unit, see "Handling of MD" (page 62).
- It is also possible to record a CD onto an MD at a double speed. (page 34 to 35)
- The CD audio is recorded following the settings made with MD REC MODE. (page 33)
- The MD O.T.E. recording is not available if the CD is played in the random mode. Cancel the random mode before proceeding to recording. (page 31)

Recording CD onto TAPE (TAPE O.T.E.)

The TAPE O.T.E. (One-Touch Edit) function makes it possible to record all tracks in a CD on a tape with a one-touch operation (All-track recording). It is also capable of recording the currently played CD track on a tape with a one-touch operation (Single-track recording).

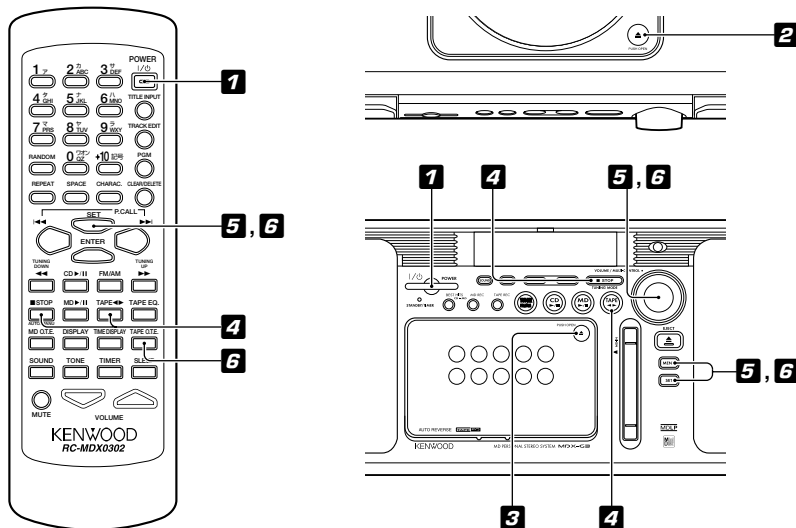

1 Press the **POWER** | key to turn power on.

2 Insert a CD.

The CD should be placed horizontally on the tray. To prevent malfunction, do not place it obliquely.

(1) Open the CD door by pressing the area marked PUSH OPEN of the CD door.

(2) Place a CD.

(3) Close the CD door by pressing the area marked PUSH OPEN of the CD door.

If the CD is already playing, press the STOP key to stop playback.

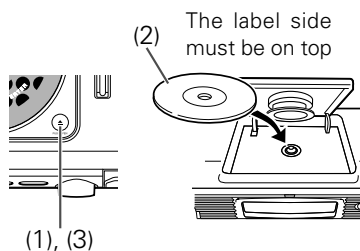

3 Insert a recordable tape so that the side where you want to start recording faces the front.

(1) Press the area marked PUSH OPEN on the cassette holder to open it, and insert a cassette tape.

(2) Press the area marked PUSH OPEN to close the cassette holder.

Insert with the side to be recorded facing the front.

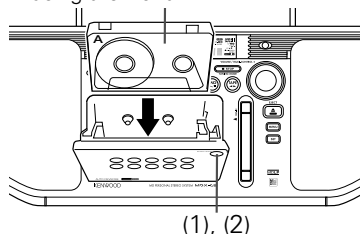

4 Press the TAPE ◀▶ key so that "▶" is lit, then press the ■STOP key.

If "▶" is lit, recording will start with the side which is not facing the front.

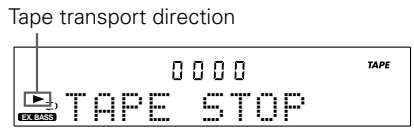

5 Select the desired tape reverse mode.

- (1) Press the MENU key.
- (2) Rotate the VOLUME/MULTI-CONTROL knob so that "TAPE RVS.?" is displayed, then press the SET key.
- (3) Rotate the VOLUME/MULTI-CONTROL knob so that the desired reverse mode is displayed.

- "↔" : ONE-WAY Tape will stop after a single side has been recorded.
- "↶" : REVERSE Tape will stop after both sides have been recorded.
- "↷" : ENDLESS Tape will stop after both sides have been recorded.

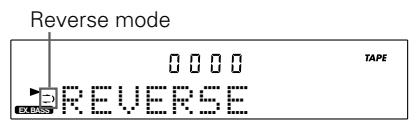

6 Press the TAPE O.T.E. key on the remote.

- If you are operating the main unit :**
- (1) Press the MENU key.
 - (2) Rotate the VOLUME/MULTI-CONTROL knob so that "REC OPTIONS" is displayed, then press the SET key.
 - (3) Rotate the VOLUME/MULTI-CONTROL knob so that "CD→TAPE" is displayed, then press the SET key.

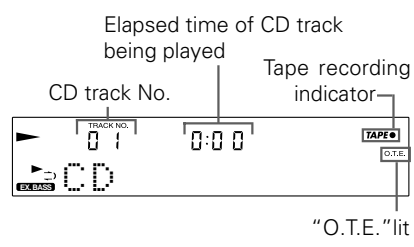

Continued on next page →

Recording the CD track being played (Single-track recording)

- (1) Play the CD track to be recorded.
- (2) Press the TAPE O.T.E. key on the remote.
When you are operating the main unit, see step **6** (page 23).
Recording starts after returning to the beginning of the current track.

To stop recording in the middle :

Press the ■STOP key.

POINT.

- The cassette deck of the system is capable of recording only the normal (TYPE I) tapes. High (TYPE II) and metal (TYPE IV) position tapes cannot be used.
- For the recordable tape types, see "Notes on cassette tape" (page 63).
- Do not open the cassette holder during recording. Otherwise, malfunction may occur. Be sure to stop tape before taking it out.
- The TAPE O.T.E. recording is not available if the CD is played in the random mode. Cancel the random mode before proceeding to recording. (page 31)

Displayed information

Viewing the CD information

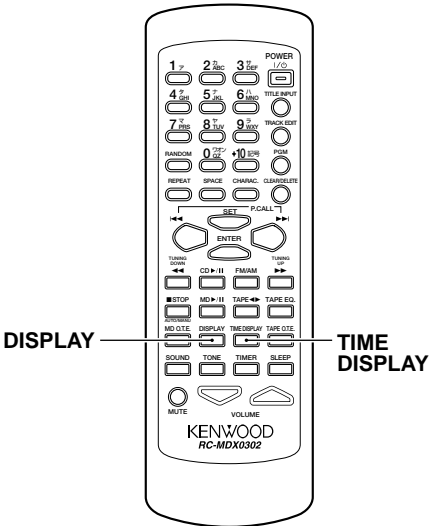

POINT

- Only the information of 1 and 2 is displayed during 1-track repeat or random playback.
- When the displayed time reaches 256 minutes or more, the display shows "-- : --".

Viewing the text data (CD-TEXT)

When a CD compatible with CD-TEXT is played, the system automatically shows the text data in the CD-TEXT data (disc title or track titles).

If a text data item contains too many characters to be shown at once in the display, press the DISPLAY key on the remote to scroll the display and see the characters which are not displayed in the beginning.

The displayed information switches each time the TIME DISPLAY key on the remote is pressed.

1. Elapsed play time of the track being played

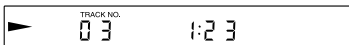

2. Remaining play time of the track being played

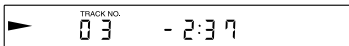

3. Elapsed play time of the disc



4. Remaining play time of the disc



Viewing the MD information

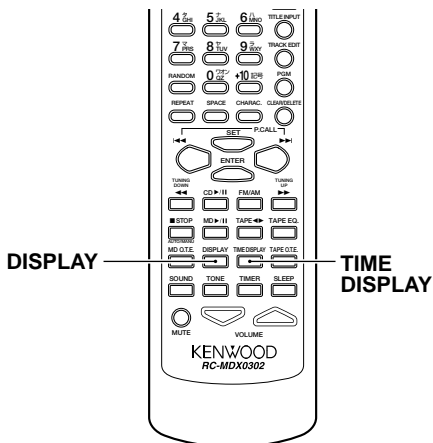

Display in recording

The displayed information switches each time the DISPLAY key on the remote is pressed.

1. Remaining recordable time of the disc



2. Music source being recorded



With display 2, if the recorded music source is a CD-TEXT CD, the title data contained in it will be displayed.

Display in playback

The displayed information switches each time the TIME DISPLAY key on the remote is pressed.

1. Elapsed play time of the track being played

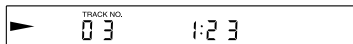

2. Remaining play time of the track being played

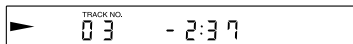

3. Elapsed play time of the disc



4. Remaining play time of the disc



To view the disc title or track titles :

When the MD contains the recording of the disc title, this unit displays it automatically in stop mode.

When the MD contains track title information, this unit displays them automatically in playback.

If a title is too long to be shown in a display page, press the DISPLAY key on the remote to scroll the display and see the characters which are not displayed in the beginning.

POINT.

- ". NO TITLE ." is displayed when the MD does not contain the recording of title data.
- "BLANK DISC" is displayed when the MD does not contain any recording.

POINT.

- Only the information of 1 and 2 is displayed during 1-track repeat or random playback.
- When the displayed time reaches 1000 minutes or more, the display shows " - - : - - ".

Adjusting the tone

Enhancement of bass and treble (EX.BASS / LOUDNESS)

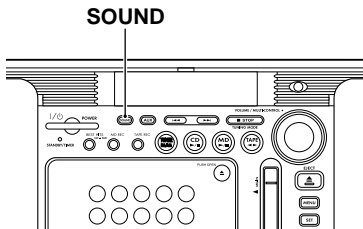
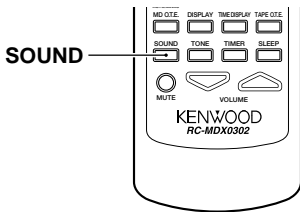

Press the SOUND key repeatedly until the desired tone enhancement is lit.

"EX. BASS" is lit : Enhances the bass tone regardless of the current volume.

"LOUD"(LOUDNESS) is lit : Enhances both the bass and treble tones according to the current volume.

(Effective during low-volume listening)

Both "EX. BASS" and "LOUD" are off (SOUND MODE OFF) : Bass and treble set using the TONE function.

Display when EX. BASS is selected



Display when LOUDNESS is selected



Fine adjustment of bass and treble (TONE)

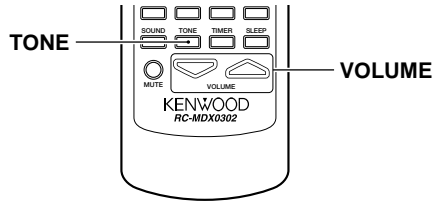

Remote control unit only

1 Press the TONE key on the remote repeatedly until "BASS" or "TREBLE" is displayed.

"BASS" : Low frequency level adjustment.

"TREBLE" : High frequency level adjustment.

Display when BASS is selected



2 Adjust the VOLUME keys to the desired level.

The high or low frequency level can be adjusted in the range between -8 and +8.

3 Press the SET key.

If the remote is left without pressing the SET key for about 8 seconds after adjustment, the adjusted setting is entered in memory and the display returns to the previous information.

POINT

- The EX. BASS or LOUDNESS mode is canceled if the bass or treble level is adjusted while "EX. BASS" or "LOUD" is lit.
- The effects of EX.BASS and LOUDNESS are not reflected in the recorded audio.

Adjusting the AUX input level

The input level from an AUX component connected to the AUX IN jacks (MD player, analog turntable, VCR, etc.) can be adjusted. It is recommended to adjust it so that the AUX input sounds at a similar volume to the built-in CD and MD.

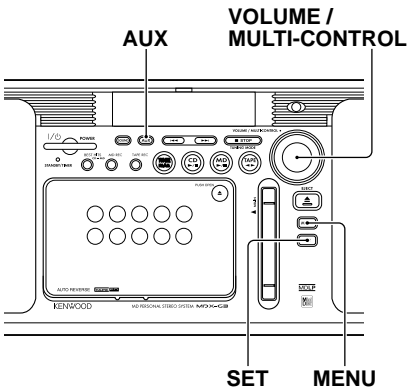

Main unit only

- 1** Press the **AUX** key to select the **AUX** input.
- 2** Play the connected **AUX** component to check the volume.
- 3** Press the **MENU** key.
- 4** Rotate the **VOLUME/MULTI-CONTROL** knob so that "AUX INPUT?" is displayed, then press the **SET** key.



- 5** Rotate the **VOLUME/MULTI-CONTROL** knob to fine adjust the input level, then press the **SET** key.

The input level can be adjusted in the range between -5 and +2.

Muting the audio temporarily (MUTE)

The audio being played can be muted temporarily.

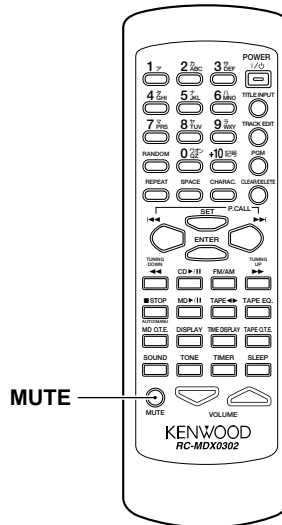

Remote control unit only

Press the **MUTE** key to switch muting on or off.

Display when MUTE is switched ON



The display blinks.



- The **MUTE** function is canceled when the volume is controlled while MUTE is ON.

Playing CD or MD tracks in the desired sequence (PGM)

Use the following procedure to program up to 32 desired tracks in a desired order.

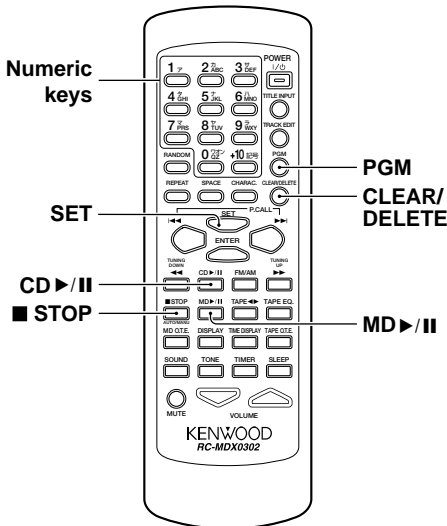

Remote control unit only

1 *CD* : Press the **CD >||** key.
MD : Press the **MD >||** key.

2 Press the **■ STOP** key.

3 Press the **PGM** key.

"PGM" lit

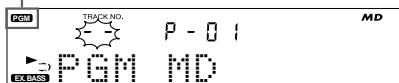

4 Press the numeric keys to compose the desired track number.

Examples

Track No. 23 : +10, +10, 3

Track No. 40 : +10, +10, +10, +10, 0

5 Press the **SET** key.

To select other tracks, repeat steps **4** and **5** for each.

If you commit a mistake, press the CLEAR / DELETE key to clear the track number and restart selection.

6 *CD* : Press the **CD >||** key.
MD : Press the **MD >||** key.

To stop program playback :

Press the **■ STOP** key in playback.

To clear a programmed track :

Press the CLEAR/DELETE key in stop mode. Each press clears the currently last programmed track.

To clear all programmed tracks, press the PGM key.

To cancel program playback :

Press the PGM key so that "PGM" turns off.



- When "PGM FULL" is displayed, no more track can be programmed.

Repeating a CD or MD (REPEAT)

Use the following procedure to play the desired track(s) repeatedly. Repeat playback can be combined with program playback or random playback.

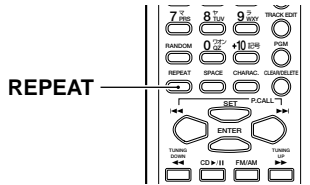

Remote control unit only

During playback, press the REPEAT key repeatedly so that "ONE" and "REPEAT" or only "REPEAT" is lit.

Both "ONE" and "REPEAT" are lit : Only one track will be played repeatedly.

Only "REPEAT" is lit : The tracks in the entire disc will be played repeatedly.

Display when both "ONE" and "REPEAT" are lit

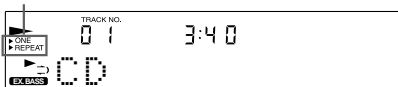

To cancel repeat playback :

Press the REPEAT key repeatedly until both "ONE" and "REPEAT" are off.

POINT.

- When the repeat mode is activated in the program play mode, both "PGM" and "REPEAT" are lit. When it is activated in the random play mode, both "RANDOM" and "REPEAT" are lit. In both cases, all tracks in the program or disc will be played repeatedly.

Playing a CD or MD in a random (RANDOM)

Use the following procedure to play tracks in a random. This will renew the enjoyment of the same disc that you have already played many times.

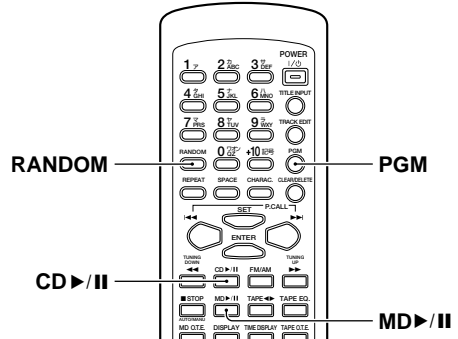

Remote control unit only

- CD** : Press the CD >|| key.
MD : Press the MD >|| key.

If the "PGM" indicator is lit, press the ■STOP key to stop playback and press the PGM key on the remote so that the indicator turns off.

- 2** Press the RANDOM key so that "RANDOM" is lit.

"RANDOM" lit



To cancel random playback :

Press the RANDOM key so that "RANDOM" turns off.

POINT.

- Random playback stops after having all of the tracks on the disc.

Stereo LP modes

The MD recorder of the system is compatible with stereo long play of MD (MDLP compatible equipment).

The available recording modes include the stereo, monaural LP, stereo LP2 and stereo LP4 modes, and they can be used with any of the music sources which can be recorded with the MD recorder of the system. It is also possible to accommodate tracks recorded in different recording modes in a single MD.

Be sure to select the recording mode before starting MD recording.

Types of recording modes

Stereo (STEREO) :

The available recording time is equal to the figure indicated on each MD cartridge.

Stereo LP2 (LP2) :

The recording time, available in stereo, becomes twice the figure indicated on each MD cartridge.

Stereo LP4 (LP4) :

The recording time, available in stereo, becomes four times the figure indicated on each MD cartridge.

Monaural LP (MONO) :

The recording time, available only in monaural, becomes about twice the figure indicated on each MD cartridge.

Stamping (STAMP)

This system has the stamping function, which attaches stamp "LP:" at the beginning of each track title to facilitate identification of tracks recorded in the LP2 or LP4 mode. "LP:" is displayed as a part of title only when a track recorded in stereo LP mode is played on a MDLP-incompatible MD recorder/player.



- A track recorded in the LP2 or LP4 mode using the MD recorder of this system can be played back on any MDLP-compatible MD recorder/player. However, if such a track is played on an MDLP-incompatible MD recorder/player, the track is played back without audio. If it is recorded using the stamping function, "LP:" is displayed at the beginning of the displayed track title.
- In stereo recording of MD, the recorded audio quality is degraded as the recording time per disc is increased. If you want to record audio by putting priority on the quality, it is recommended to use the STEREO mode.

Setting the recording mode

The MD recording mode can be set only in stop mode.

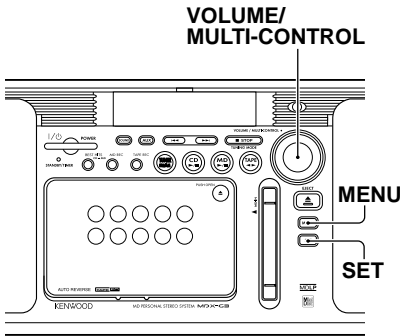

Main unit only

1 Press the **MENU** key.

2 Rotate the **VOLUME/MULTI-CONTROL** knob so that **"MD REC MODE"** is displayed, then press the **SET** key.

The currently set recording mode is indicated.



3 Rotate the **VOLUME/MULTI-CONTROL** knob so that the desired recording mode is displayed.

Display when LP2 is selected



- "STEREO" : Stereo recording mode (no indicator lit)
- "LP2" : Stereo LP2 mode ("LP2" lit)
- "LP4" : Stereo LP4 mode ("LP4" lit)
- "MONO" : Monaural LP mode ("MONO" lit)

4 Press the **SET** key.

The setting operation is complete if you selected "STEREO" or "MONO" in the above.

If you selected "LP2" or "LP4", the stamping setting screen will be displayed. In this case, go to step **5**.

5 Rotate the **VOLUME/MULTI-CONTROL** knob to select **"LP:STAMP on"** or **"LP:STAMP off"**, then press the **SET** key.

Select "on" when you want to display "LP:" at the beginning of the track title. Select "off" if you do not want to display it.

Display when "LP:STAMP on" is selected



High-speed recording of all CD tracks onto an MD

All of the tracks in a CD can be recorded in half the usual period of time. If the program play or random play mode is activated, cancel it before proceeding.

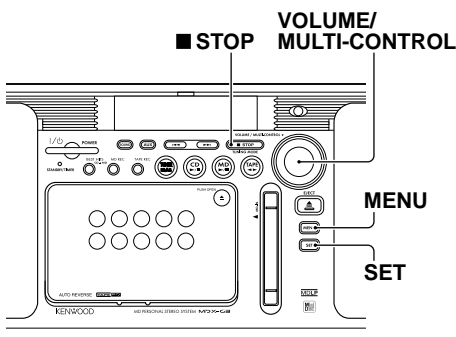
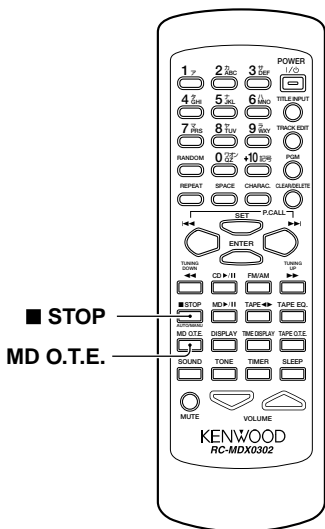

1 Make preparation for recording.

See steps **1** to **3** in "Recording CD onto MD" (page 20).

2 Press the MENU key.

3 Rotate the VOLUME/MULTI-CONTROL knob so that "REC SPEED ?" is displayed, then press the SET key.



4 Rotate the VOLUME/MULTI-CONTROL knob so that "CD→MD HIGH" is displayed, then press the SET key.



Select "CD→MD NORM" if you want to record CD in the normal speed.

5 Press the MD O.T.E. key on the remote.

When you are operating the main unit, see step **4** of "Recording CD onto MD" (page 21).

The CD and MD stop automatically when all of the CD tracks have been recorded onto the MD.

High-speed recording the CD track being played (Single-track recording)

- (1) Perform the operations in steps 1 to 4 (page 34).
- (2) Play the CD track to be recorded.
- (3) Press the MD O.T.E. key on the remote.

When you are operating the main unit, see step 4 of "Recording CD onto MD" (page 21).

Recording starts after returning to the beginning of the current track.

To stop recording in the middle :

Press the ■STOP key.

POINT

- Be careful not to turn power off or apply shock or vibrations to the system while "MD WRITING" is displayed.
- Once high-speed recording of "CD→MD HIGH" is started, it is not permitted to record the same CD by high-speed recording within 74 minutes after the start of previous high-speed recording. In case this restriction is applied, the display shows the time until the next high-speed recording becomes possible.



Time until re-recording is available

It is also prohibited to continue high-speed of more than 100 tracks within 74 minutes.

- If you want to record the same CD again in less than 74 minutes, set "REC SPEED" to "CD→MD NORM" and perform the MD O.T.E. recording (pages 20 & 21).

Recording onto MD

Desired music source can be recorded onto MDs.

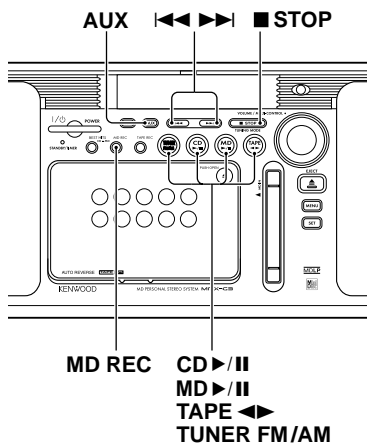

Main unit only

1 Insert a recordable MD.

2 Select the music source to be recorded.

CD : Press the CD ►/|| key.

Tape : Press the TAPE ◀ key.

Radio : Press the TUNER FM/AM key.

AUX component : Press the AUX key.

If a CD or tape has already been loaded in advance, it starts to be played automatically now. press the ■STOP key to stop it.

3 Press the MD REC key.

The unit enters record-pause mode.

Display in MD record-pause mode



4 When the recording source is ready for playback, press the MD REC key again.

5 Play the recording source.

To stop recording :

Press the ■STOP key.

To let recording pause :

Press the MD ►/|| key during recording. Press the MD ►/|| or MD REC key to resume recording from the pause.

In case a message is displayed and recording will not start :

See "Display message list" (pages 68&69).

Tips for recording CD onto MD

When the MD recorder in record-pause mode, the recording can be started automatically at the same time as the playback of CD is started. (Sync recording)

- (1) Put the CD player in play-pause mode.
- (2) Select the track to be recorded first by pressing the I◀◀ or ▶▶I key. The CD player enters pause (play-pause) mode at the beginning of the selected track.
- (3) Press the MD REC key to put the MD recorder in record-pause mode.
- (4) Press the CD ►/|| key to start playing the CD.

POINT

- Be careful not to turn power off or apply shock or vibrations to the system while "MD WRITING" is displayed.
- The MD cannot be inserted or ejected in the STANDBY mode of power (page 71). Forcing an MD to be inserted or ejected may result in damage.
- When the CD output is recorded onto MD, the digital signal is recorded automatically. When the radio or tape output is recorded onto MD, the analog signal is recorded automatically.

In regard to track numbers at the time of recording

MD track numbers are used to search the beginning of a track or programming tracks.

- When recording audio from the radio, tape or AUX source, track numbers are assigned automatically in any of the following cases.
 - When audio is input after a no-sound period of more than about 3 seconds. (However, the track number may not be incremented in case the music source recorded contain noise, etc.)
 - When pianissimo, or low-level sections have continued during recording of classic music, etc.
 - When the MD ►/|| or MD REC key is pressed in record-pause mode to resume recording.
 - When the TRACK EDIT key on the remote is pressed during recording.
- When recording the digital output from CD, track numbers are assigned automatically in any of the following cases.
 - When the CD track changes.
 - When the MD ►/|| or MD REC key is pressed in record-pause mode to resume recording.
 - When the TRACK EDIT key on the remote is pressed during recording.

Recording onto TAPE

The tape deck of the system can record any music source including CD and radio.

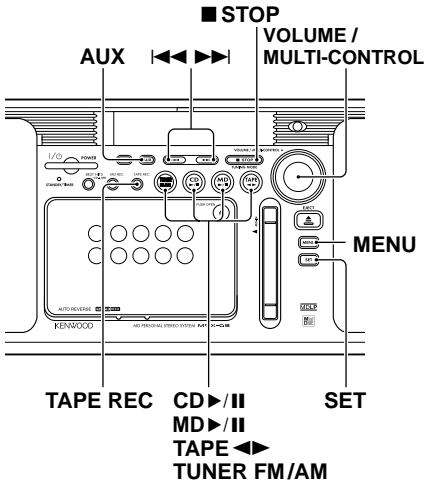

Main unit only

1 Make preparation for recording.

See steps 1 and 2 to 5 of "Recording CD onto TAPE" (pages 22 & 23).

2 Select the source to be recorded.

CD : Press the CD ►/|| key.

MD : Press the MD ►/|| key.

Radio : Press the TUNER FM/AM key.

AUX component : Press the AUX key.

If a CD or MD has already been loaded in advance, it starts to be played automatically now. Press the ■STOP key to stop it.

3 When the source to be recorded is ready, press the TAPE REC key.

Example : Recording CD onto TAPE



Tape recording indicator

4 Start playing the source to be recorded.

To stop recording :

Press the ■STOP key.

To let recording pause :

When the TAPE REC key is pressed during recording, recording pauses after leaving a no-sound section of 4 seconds. To resume recording from record-pause mode, press the TAPE REC key again.

Tip for recording CD or MD onto tape

When the cassette deck is put to record-pause mode, the start of tape recording can be started in synchronism with the start of playback of the CD or MD source. (Sync recording)

- (1) Put the CD player or MD recorder of the system to pause (play-pause) mode.
- (2) Select the track to be recorded first by pressing the ◀◀ or ▶▶ key. The CD player or MD recorder enters pause (play-pause) mode at the beginning of the selected track.
- (3) Press the TAPE REC key twice. The cassette deck enters record-pause mode after leaving a no-sound section of 4 seconds.
- (4) Start playback of the CD or MD.

POINT

- The cassette deck of the system is capable of recording only the normal (TYPE I) tapes. High (TYPE II) and metal (TYPE IV) position tapes cannot be used.

Recording CD tracks onto MD or TAPE in desired sequence

The tracks in a CD can be recorded by reordering them in the desired sequence when the recording speed is "CD→MD NORM". Note that this function is not available when the recording speed is "CD→MD HIGH".

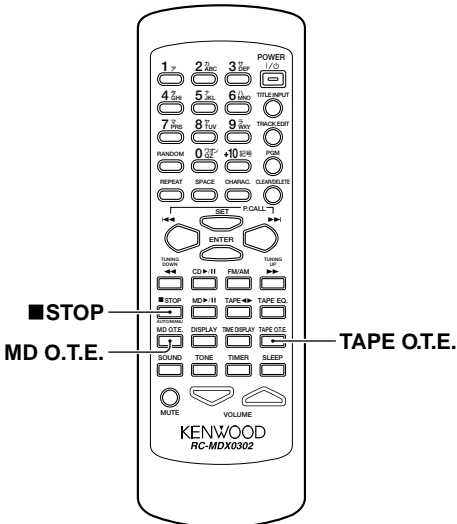

3 Start recording.

Recording onto MD : Press the MD O.T.E. key.

Recording onto tape : Press the TAPE O.T.E. key.

When recording onto tape completes, the tape deck stops after leaving a no-sound section of 4 seconds automatically.

To stop recording in the middle :

Press the ■STOP key.

POINT.

- Be careful not to turn power off or apply shock or vibrations to the system while "MD WRITING" is displayed.

Remote control unit only

1 Make preparation for recording.

MD : See steps 1 to 3 of "Recording CD onto MD" (page 20).

Tape : See steps 1 to 5 of "Recording CD onto TAPE" (pages 22 & 23).

Make sure that the MD recorder and tape deck are in stop mode.

2 Program the CD tracks in the desired sequence.

See steps 1 to 5 of "Playing CD or MD tracks in the desired sequence" (page 30).

Recording MD tracks onto TAPE in desired sequence

A tape containing only the favorite tracks in an MD can be created by reordering them in the desired sequence.

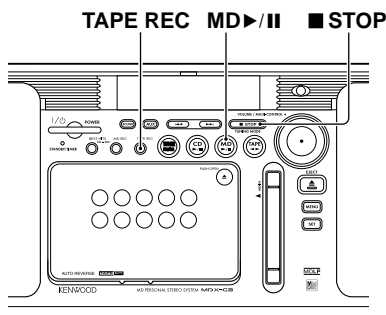

5 Press the MD >/|| key.

When recording of MD tracks completes, the tape deck stops automatically after leaving a no-sound section of 4 seconds.

To stop recording in the middle :

Press the ■STOP key.

Main unit only

1 Make preparation for recording.

See steps **1** and **3** to **5** of "Recording CD onto TAPE" (pages 22 & 23).

2 Program the MD tracks in the desired sequence.

See steps **1** to **5** of "Playing CD or MD tracks in the desired sequence" (page 30).

3 Press the MD >/|| key successively twice to put the MD recorder in pause mode.

4 Press the TAPE REC key successively twice to put the tape deck in record-pause mode.

The tape deck enters record-pause mode after leaving a no-sound section of 4 seconds.

Recording only the first track of CD (BEST HITS)

Only the first track of each CD can be recorded. This function is convenient for recording the first tracks of multiple single CDs onto a single MD.

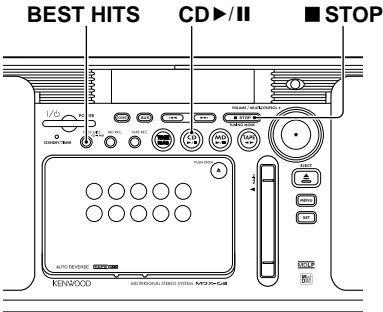

To stop recording in the middle :

Press the ■STOP key.



- Be careful not to turn power off or apply shock or vibrations to the system while "MD WRITING" is displayed.

Main unit only

1 Make preparation for recording.

See steps 1 to 3 in "Recording CD onto MD" (page 20).

2 Press the CD >|| key.

3 Press the ■STOP key.

If "PGM" is lit, turn it off by pressing the PGM key on the remote.

4 Press the BEST HITS key.



"BEST HITS" lit

When the first track of the CD has been recorded, both the CD and MD stop automatically.

5 Replace the CD and press the BEST HITS key.

Record the first tracks of other CDs by repeating this step.

Editing the MD titles

Assigning a title to a disc or track

When titles are assigned to a disc and its tracks, the titles can be displayed during playback.

If the program play mode is activated, cancel it before proceeding.

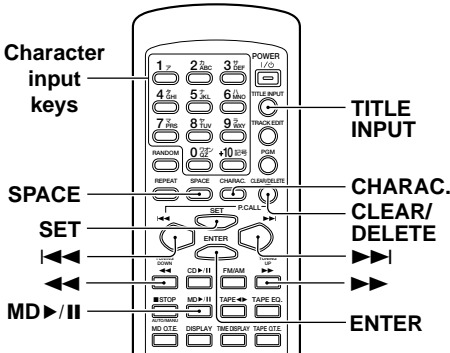

Remote control unit only

- 1** Select the MD input and load a prerecorded MD.
- 2** Press the **TITLE INPUT** key.
- 3** Press the **◀◀** or **▶▶** key repeatedly until "DISC" or the track number to be titled ("001", etc.) is displayed.

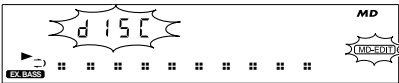

- 4** Press the **SET** key.
- 5** Press the **CHARAC.** key repeatedly to select the desired character group.

"Aa" : Alphabet group
 "12" : Numeral group

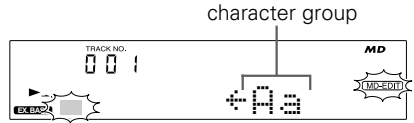

- 6** Press the character input key repeatedly until the desired character is displayed.

For the characters that can be used in titles, see "Title editing character list" (page 46).

Press the **CLEAR/DELETE** key to clear the character which is blinking.

Press the **SPACE** key to input a space character.



- 7** Press the **SET** key to enter the selected character in memory.

Compose the desired title by repeating steps **6** to **7** for each character.

Pressing the **CLEAR/DELETE** key clears the character located immediately before the cursor.

- 8** After composing the title, press the **ENTER** key.

The input title is displayed by scrolling. To assign other track titles, repeat steps **3** to **8** for each.

- 9** Press the **TITLE INPUT** key.

- 10** Press the **EJECT** key on the main unit to eject the MD.

"MD WRITING" is displayed.

Editing the MD titles (continued)

Registering titles

Frequently used title characters can be registered in the title memo and recalled any time later. Three title memo banks are provided for use in registration.

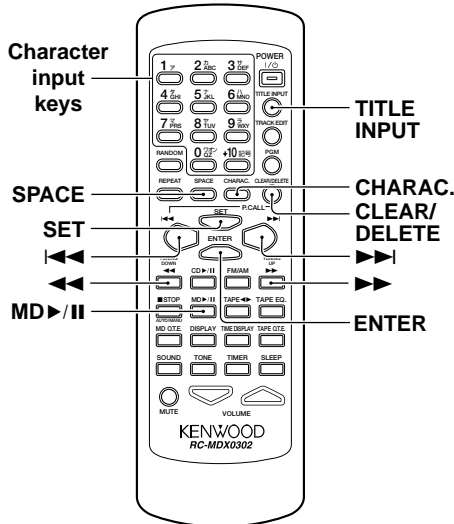

Remote control unit only

- 1** Select the MD input and load a prerecorded MD.
- 2** Press the **TITLE INPUT** key.
- 3** Press the **◀◀** or **▶▶** key repeatedly to select one of "[1]" to "[3]", then press the **SET** key.



- 4** Input the title.

Perform steps **5** to **7** of "Assigning a title to a disc or track" (page 42).

- 5** After composing the title, press the **ENTER** key.

The title is registered in the MD and scrolled on the display.

To assign other track titles, repeat steps **3** to **5** for each.

- 6** Press the **TITLE INPUT** key.

To cancel title input in the middle :

Press the **TITLE INPUT** key any time before the end of step **4**.

Copying titles

A disc or track title in a previously recorded MD or title characters registered in the title memo (page 44) can be copied and used in input of another title.

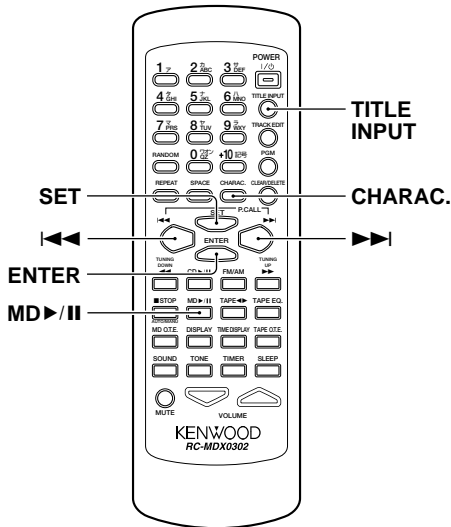

Remote control unit only

1 Perform steps 1 to 4 of "Assigning a title to a disc or track" (page 42).

2 Press the **◀◀** or **▶▶** key.

3 Press the **CHARAC.** key repeatedly until "[123]" is displayed.

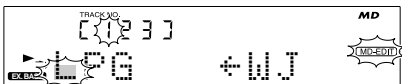

4 Press the **◀◀** or **▶▶** key repeatedly to select the title to be copied.

"[123]" : One of titles stored in title memo 1, 2 and 3 (page 44) can be copied.

"[dISC]" : Disc title can be copied.

"[001]"... : Track title can be copied.

5 Press the **SET** key.

The title is copied.
Additional characters can be input after the copied title.

6 Press the **ENTER** key.

The title is displayed by scrolling.

7 Press the **TITLE INPUT** key.

8 Press the **▲EJECT** key on the main unit to eject the MD.

"MD WRITING" is displayed.

To cancel title copy in the middle :

Press the TITLE INPUT key any time before the end of step 5.

Editing can be canceled provided that it is attempted before "MD WRITING" is displayed. For the procedure, see "Canceling editing" (page 53).

POINT.

- Be careful not to turn power off or apply shock or vibrations to the system while "MD WRITING" is displayed.

Continued on next page →

Editing the MD titles (continued)

Title editing character list

The following characters including uppercase and lowercase alphabets, numerals and symbols.

Available characters in title input using the character input keys on the remote

Key \ Group	"Aa"	"12"
1 ア	space[1] [2] [3]	1
2 カABC	ABCabc	2
3 サDEF	DEFdef	3
4 タGHI	GHIghi	4
5 ナJKL	JKLjkl	5
6 ハMNO	MNOmno	6
7 マPRS	PRSprs	7
8 ヤTUV	TUVtuv	8
9 ラWXY	WXYwxy	9
0 ワランQZ	QZqz	0
+10 記号	' , : ? ! ; . " _ ` \$ space & () - / + * = < > # % @	

POINT

- The titles to be copied by title copy cannot be selected with the character input keys.
- Press the SPACE key on the remote to input a space character.

Available characters in title input using the ◀◀ and ▶▶ keys on the remote

Uppercase alphabet group	ABCDEFGHIJKLMN OPQRSTUVWXYZ space
Lowercase alphabet group	abcdefghijklmnopqrstu vwxyz space
Numeral and symbol group	0123456789 space ! " # \$ % & ' () * + , - . / : ; < = > ` ? @ space_
Title memo/title copy group	[1 2 3] [dISC] ([001]...)

Moving one track

Use the following procedure to select a track and move and insert it to the position of the desired track number. Multiple tracks can be moved and reordered by repeating the procedure for each track. The track numbers before and after the moved track are adjusted automatically.

Image of moving one track

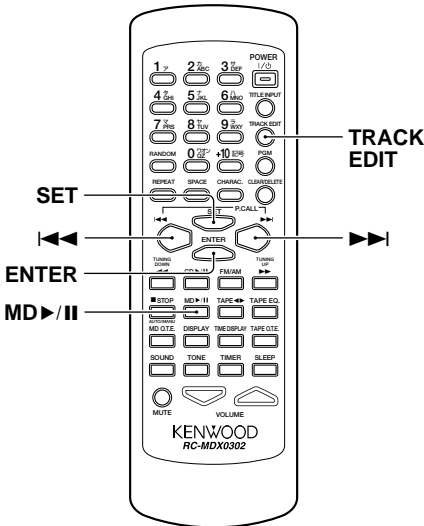
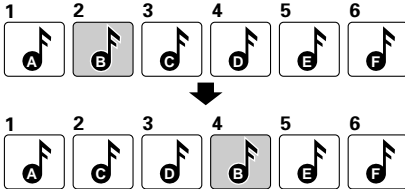

Remote control unit only

- 1** Select the MD input and load a prerecorded MD.
- 2** Press the **◀◀** or **▶▶** key repeatedly to select the track number to be moved.

The track will be played back.

- 3** Press the **TRACK EDIT** key repeatedly until "**▶ MOVE?**" is displayed, then press the **SET** key.

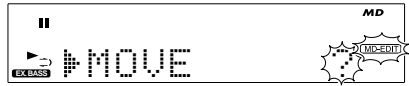

- 4** Press the **◀◀** or **▶▶** key repeatedly to select the move destination position where you want to insert the moved track, and press the **SET** key.

Display when a track has been moved after track No.6.

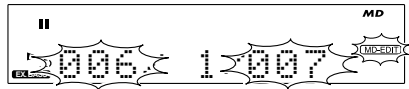

- 5** Press the **ENTER** key.

- 6** Press the **▲ EJECT** key on the main unit to eject the MD.

"MD WRITING" is displayed.

To cancel the MOVE operation in the middle :

Press the **TRACK EDIT** key any time before the end of step **4**.

Editing can be canceled provided that it is attempted before "MD WRITING" is displayed. For the procedure, see "Canceling editing" (page 53).

POINT

- Be careful not to turn power off or apply shock or vibrations to the system while "MD WRITING" is displayed.

Moving several tracks at a time

Use the following procedure to select up to 32 tracks you want to move in the desired sequence and move them together. The track numbers are adjusted automatically.

Image of moving several tracks

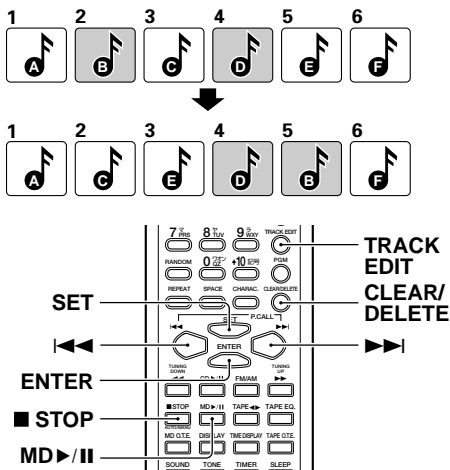

Remote control unit only

1 Select the MD input and load a prerecorded MD.

If the MD is already playing, press the ■STOP key to stop playback.

2 Press the TRACK EDIT key repeatedly until "► Q. MOVE?" is displayed, then press the SET key.



3 Press the ◀◀ or ▶▶ key repeatedly to select one of the track numbers to be moved, then press the SET key.

Select other track numbers in the desired sequence by repeating this step for each track.

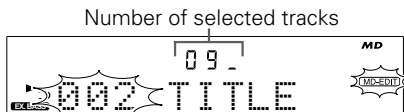

If you commit a mistake, press the CLEAR/DELETE key to clear the track number and restart selection.

4 After selecting the desired tracks in the desired sequence, press the ENTER key.

5 Press the ◀◀ or ▶▶ key repeatedly to select the move destination position where you want to insert the moved tracks, then press the SET key.

Display when 9 tracks are inserted between tracks 33 and 34



6 Press the ENTER key.

7 Press the ▲EJECT key on the main unit to eject the MD.

"MD WRITING" is displayed.

To cancel the Q. MOVE operation in the middle :

Press the TRACK EDIT key any time before the end of step 5.

Editing can be canceled provided that it is attempted before "MD WRITING" is displayed. For the procedure, see "Canceling editing" (page 53).

POINT

- Be careful not to turn power off or apply shock or vibrations to the system while "MD WRITING" is displayed.

Combining tracks

Use the following procedure to combine two track into a single track. The track numbers after the combined tracks are adjusted automatically.

Image of combining tracks

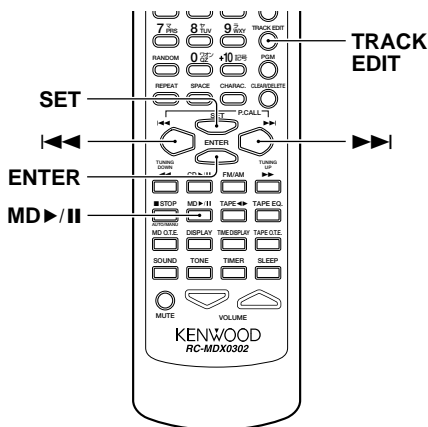
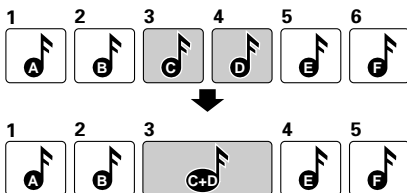

Remote control unit only

1 Select the MD input and load a prerecorded MD.

2 Press the **◀◀** or **▶▶** key repeatedly to select the earlier track number to be combined.

The track will be played back.

3 Press the **TRACK EDIT** key repeatedly until "**▶ COMBINE?**" is displayed, then press the **SET** key.



4 Press the **◀◀** or **▶▶** key repeatedly to select the latter track number that you want to combine with the track selected above, and press the **SET** key.

Display when combining track Nos. 4 and 5



Track No. selected in step **2**

5 Press the **ENTER** key.

6 Press the **▲ EJECT** key on the main unit to eject the MD.

"MD WRITING" is displayed.

To cancel the COMBINE operation in the middle :

Press the **TRACK EDIT** key any time before the end of step **4**.

Editing can be canceled provided that it is attempted before "MD WRITING" is displayed. For the procedure, see "Canceling editing" (page 53).

POINT

- Be careful not to turn power off or apply shock or vibrations to the system while "MD WRITING" is displayed.
- Tracks recorded using different recording modes (pages 32&33) cannot be combined. Combination of tracks may also be inhibited by certain restrictions imposed by the MD standard.
- When the tracks are combined, the MD recorder enters pause mode at the beginning of the track created by combining.

Dividing a track

Use the following procedure to divide a track into two. The track numbers are adjusted automatically.

Image of dividing a track

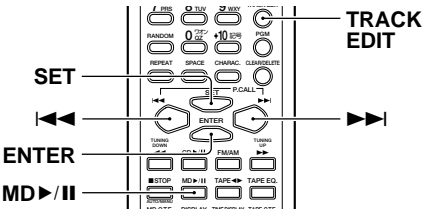
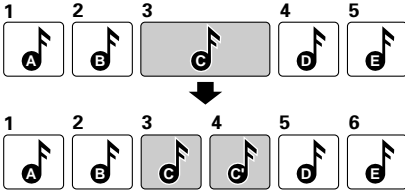

Remote control unit only

1 Select the MD input and load a prerecorded MD.

2 Press the **◀◀** or **▶▶** key repeatedly to select the track number to be divided.

The track will be played back.

3 Find divided point, press the TRACK EDIT key repeatedly until "▶ DIVIDE?" is displayed, then press the SET key.



4 Press the SET key again.

5 Press the **◀◀** or **▶▶** key repeatedly to adjust the point where you want to divide the track, then press the SET key.

The audio of the 2 seconds around it will be played repeatedly.

Adjust while listening to the repeated audio.

The dividing point can be adjusted in the range between -31 and +31.

The dividing point



Point display

If you want to divide the track at another point, cancel the DIVIDE operation then restart the procedure from step **1**.

6 Press the ENTER key.

7 Press the **▲EJECT** key on the main unit to eject the MD.

"MD WRITING" is displayed.

To cancel the DIVIDE operation in the middle :

Press the TRACK EDIT key any time before the end of step **5**.

Editing can be canceled provided that it is attempted before "MD WRITING" is displayed. For the procedure, see "Canceling editing" (page 53).

POINT

- Be careful not to turn power off or apply shock or vibrations to the system while "MD WRITING" is displayed.
- The track created by division does not contain no-sound section between them.
- Division of a track may be inhibited by certain restrictions imposed by the MD standard.
- When the track is divided, the MD recorder enters pause mode at the beginning of the track with the earlier track number.

Erasing a track

Use the following procedure to erase the track being played. The track numbers will be adjusted automatically.

Image of erasing a track

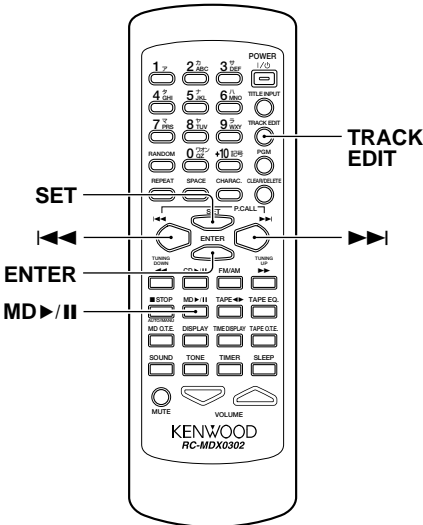
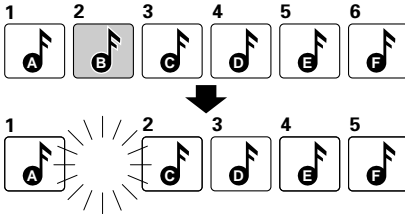

Remote control unit only

1 Select the MD input and load a prerecorded MD.

2 Press the **◀◀** or **▶▶** key repeatedly to select the track to be erased.

The track will be played back.

3 Press the **TRACK EDIT** key repeatedly until "**▶ ERASE?**" is displayed, then press the **SET** key.

Display when erasing track No. 3

Track No. erased



4 Press the **SET** key again.

5 Press the **ENTER** key.

6 Press the **▲EJECT** key on the main unit to eject the MD.

"MD WRITING" is displayed.

To cancel the ERASE operation in the middle :

Press the **TRACK EDIT** key any time before the end of step **4**.

Editing can be canceled provided that it is attempted before "MD WRITING" is displayed. For the procedure, see "Canceling editing" (page 53).

POINT.

- Be careful not to turn power off or apply shock or vibrations to the system while "MD WRITING" is displayed.

Erasing several tracks at a time

Use the following procedure to select up to 32 tracks you want to erase and erase them together. The track numbers are adjusted automatically.

Image of erasing several tracks

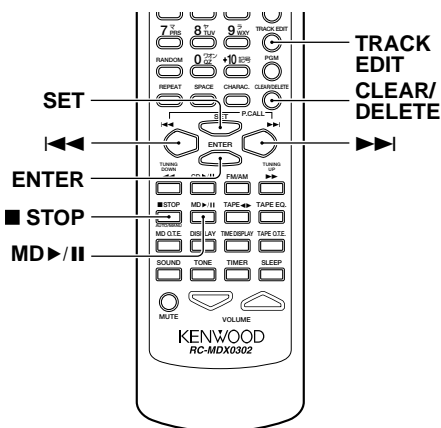
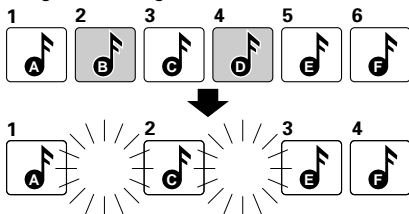

Remote control unit only

- 1** Select the MD input and load a prerecorded MD.

If the MD is already playing, press the ■STOP key to stop playback.

- 2** Press the TRACK EDIT key repeatedly until "▶ Q. ERASE?" is displayed, then press the SET key.



- 3** Press the ◀◀◀ or ▶▶▶ key repeatedly to select the track number to be erased, and press the SET key.

Select other tracks to be erased by repeating this step for each.

Select "ALL ERASE" if you want to erase all tracks in an MD.

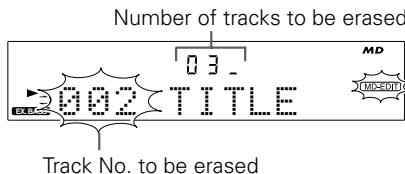

If you commit a mistake, press the CLEAR/DELETE key to clear the track number and restart selection.

- 4** After selecting all of the tracks to be erased, press the ENTER key.

- 5** Press the ENTER key again.

- 6** Press the ▲EJECT key on the main unit to eject the MD.

"MD WRITING" is displayed.

To cancel the Q. ERASE operation in the middle :

Press the TRACK EDIT key any time before the end of step 4.

Editing can be canceled provided that it is attempted before "MD WRITING" is displayed. For the procedure, see "Canceling editing" (page 53).

POINT

- Be careful not to turn power off or apply shock or vibrations to the system while "MD WRITING" is displayed.

Canceling editing

Editing can be canceled provided that it is attempted before "MD WRITING" is displayed.

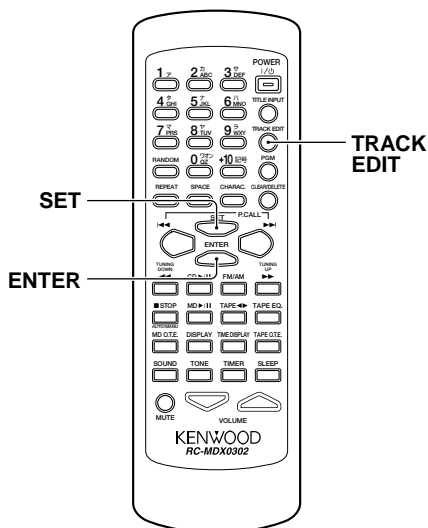

Remote control unit only

- 1** While the MD is in stop mode, press the TRACK EDIT key repeatedly until "▶ CANCEL?" is displayed, then press the SET key.



- 2** Press the ENTER key.

To cancel the CANCEL operation in the middle :

Press the TRACK EDIT key any time before the end of step **1**.

Waking up to the timer playback (O.T.T.)

The O.T.T. makes timer-activate playback possible by simply setting the desired time of the day. The system is automatically turned off in 1 hour after the start of timer playback. The O.T.T. timer works only once after it has been set.

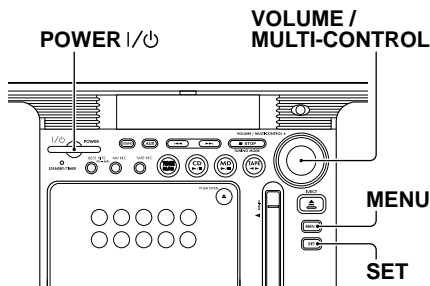
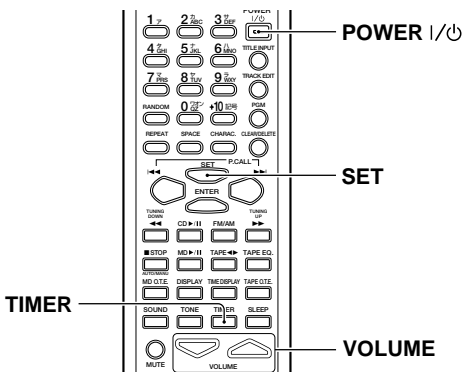

Setting

1 Make preparations according to the source to be played.

CD : Load a CD.

MD : Load an MD.

Tape : Load a cassette tape.

Radio : Receive the station to be played.

AUX component : Make the required preparation for playback by connecting an AUX component.

2 Rotate the VOLUME/MULTI-CONTROL knob to adjust the listening volume.

The source will be played at the adjusted volume.

3 Press the MENU key.

4 Rotate the VOLUME/MULTI-CONTROL knob so that "TIMER SET?" is displayed, then press the SET key.

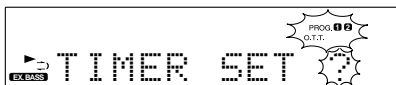

5 Rotate the VOLUME/MULTI-CONTROL knob so that "O.T.T. SET?" is displayed, then press the SET key.



6 Rotate the VOLUME/MULTI-CONTROL knob to select the time at which the timer is activated (ON time)

The ON time can be set in 5-minute steps.

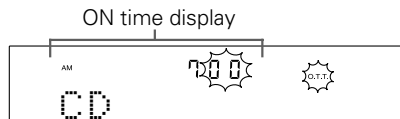

7 Press the SET key.

■ Execution

8 Press the **TIMER** key on the remote repeatedly until "O.T.T." is lit.



9 Press the **POWER** | / **⏻** key to switch the power off to the **STANDBY mode**.

The STANDBY/TIMER indicator lights green.

The O.T.T. timer is activated and playback will start when the set ON time comes.

To cancel O.T.T. timer :

Press the TIMER key on the remote repeatedly until "O.T.T." turns off.

To re-execute O.T.T. timer with the same setting as before :

- (1) After preparing the source to be played, press the TIMER key on the remote repeatedly until "O.T.T." is lit.
- (2) Press the POWER | / **⏻** key to switch the power off to the STANDBY mode.

To check or change the timer setting :

Restart the procedure from step **7** again.

POINT

- Be sure to adjust the time of the day (page 7) before using the timer functions.
- When the STANDBY/TIMER indicator is blinking in green, the timer setting or clock setting is erroneous. Check and correct them as required (pages 7 & 54).
- The O.T.T. timer cannot be used for program playback of CD or MD.
- Even when the O.T.T. timer is canceled, previously made setting is stored in memory and remains until new timer information is set the next time.

Continued on next page →

Program timer (PROG.1, PROG.2)

The program timer can store the timer operating hours and its contents so the timer operation can be activated or deactivated as required any time. The program timer can be activated on any time.

Timer playback using program timer

Use the following procedure to play the selected source at the selected time period.

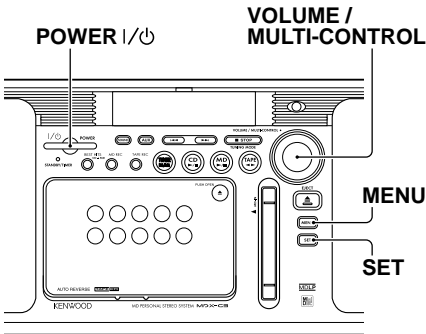
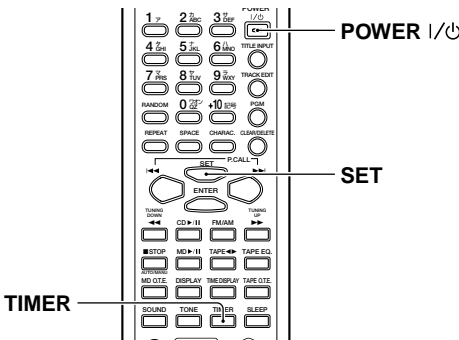

■ Setting

1 Make preparations according to the source to be played.

- CD : Load a CD.
- MD : Load an MD.
- Tape : Load a cassette tape.
- Radio : Preset stations (Page 8).

AUX component : Make the required preparation for playback by connecting an AUX component.
Be also sure to set the timer for the AUX source component connected to the AUX IN jacks.

- 2 Press the MENU key.
- 3 Rotate the VOLUME/MULTI-CONTROL knob so that "TIMER SET?" is displayed, then press the SET key.
- 4 Rotate the VOLUME/MULTI-CONTROL knob so that "PROG.1 SET?" or "PROG.2 SET?" is displayed, then press the SET key.

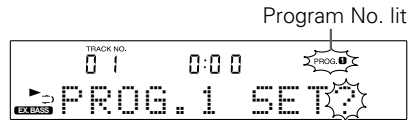

5 Select the time to start timer playback (ON time).

Rotate the VOLUME/MULTI-CONTROL knob to select the figure of hour, then press the SET key.

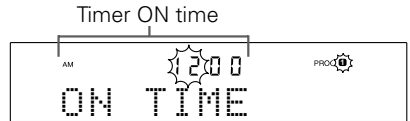

Also select the figure of minute in the same way as above.

6 Select the time to stop timer playback (OFF time).

Set in the same way as the ON time.

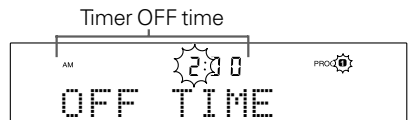

■ Execution

7 Rotate the **VOLUME/MULTI-CONTROL** knob to select "PLAY" or "AI PLAY", then press the **SET** key.

"PLAY" : The source will played at the adjusted volume before entering the STANDBY mode.

"AI PLAY" : The listening volume increases gradually from the start of timer playback until it reaches a certain level.

Display when "PLAY" is selected

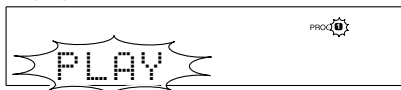

8 Rotate the **VOLUME/MULTI-CONTROL** knob to select the music source to be input, then press the **SET** key.

The input source can be selected from "CD", "MD", "TAPE", "TUNER" (radio) and "AUX"(AUX component).

9 To listen to radio broadcasting, Rotate the **VOLUME/MULTI-CONTROL** knob to select the preset number of the desired station, then press the **SET** key.

This operation is not required when an input source other than "TUNER" is selected.

10 Rotate the **VOLUME/MULTI-CONTROL** knob to adjust the listening volume.

The source will be played at the adjusted volume.

This step is not required when "AI PLAY" is selected.

11 Press the **TIMER** key on the remote repeatedly until the program number to be executed ("PROG. 1" or "PROG. 2" or "PROG. 1 2") is lit.

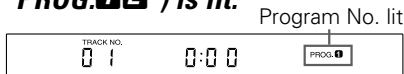

12 Press the **POWER** I/O key to switch the power off to the **STANDBY** mode.

The STANDBY/TIMER indicator lights in green.

The program timer is activated and playback will start when the set ON time comes.

To cancel program timer :

Press the **TIMER** key on the remote repeatedly until "PROG. 1" or "PROG. 2" or "PROG. 1 2" turns off.

To check or change the timer setting :

Restart the procedure from step 7 again.

POINT.

- Be sure to adjust the time of the day (page 7) before using the timer functions.
- The program timer cannot be used for program playback of CD or MD.
- PROG.1 and PROG.2 should be set so that their operating periods do not overlap. Leave at least 1 minute of interval between the two programs.
- Even when the program timer is canceled, previously made setting is stored in memory and remains until new timer information is set the next time.
- When the STANDBY/TIMER indicator is blinking in green, the timer setting or clock setting is erroneous. Check and correct them as required (pages 7 & 56 to 57).

Timer recording using program timer

The audio of TUNER (radio) or AUX (AUX component) started by the timer playback at the set time can be recorded onto an MD or tape during timer playback.

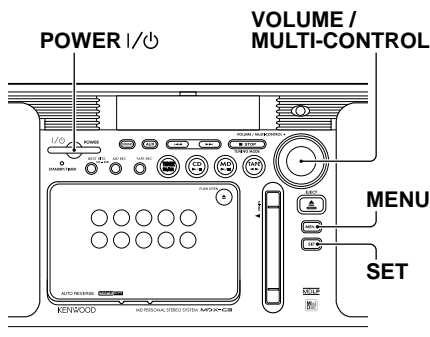
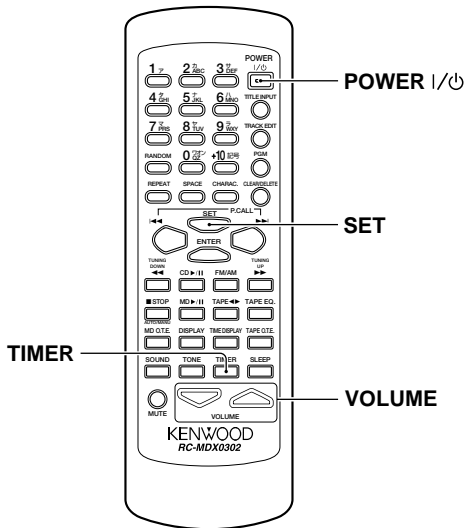

■ Setting

1 Make preparation for recording.

MD : See steps 1 and 3 in "Recording CD onto MD" (page 20).

Tape : See steps 1, 3 to 5 of "Recording CD onto TAPE" (pages 22 & 23)

2 Perform steps 2 to 6 of "Timer playback using program timer" (page 56).

3 Rotate the VOLUME/MULTI-CONTROL knob to select "REC", then press the SET key.

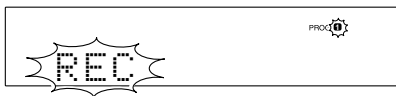

4 Rotate the VOLUME/MULTI-CONTROL knob to select "TUNER" or "AUX", then press the SET key.

"TUNER": Radio

"AUX" : AUX input source

5 To record a radio station, rotate the VOLUME/MULTI-CONTROL knob to select preset station to be recorded, then press the SET key.

If "AUX" is selected, this operation is not necessary.

6 Rotate the VOLUME/MULTI-CONTROL knob to select "MD REC" or "TAPE REC", then press the SET key.

"MD REC" : The input audio is recorded onto an MD

"TAPE REC" : The input audio is recorded onto a tape.

Display when "MD REC" is selected



■ Execution

- 7** Press the **TIMER** key on the remote repeatedly until the program number to be executed ("PROG.1" or "PROG.2" or "PROG.12") is lit.



- 8** Press the **POWER** | / **⏻** key to switch the power off to the **STANDBY mode**.

The STANDBY/TIMER indicator lights in green.

The program timer is activated and recording will start when the set ON time comes.

To cancel program timer :

Press the **TIMER** key on the remote repeatedly until "PROG.1" or "PROG.2" or "PROG.12" turns off.

To check or change the timer setting :

Restart the procedure from step **7** again.

POINT.

- Be sure to adjust the time of the day (page 7) before using the timer functions.
- PROG.1 and PROG.2 should be set so that their operating periods do not overlap. Leave at least 1 minute of interval between the two programs.
- The speakers do not output audio during timer recording.
- Even when the program timer is canceled, previously made setting is stored in memory and remains until new timer information is set the next time.
- When the STANDBY/TIMER indicator is blinking in green, the timer setting or clock setting is erroneous. Check and correct them as required (pages 7 & 58).

Sleep timer (SLEEP)

When the time set for the SLEEP time has elapsed, the system is turned off automatically. The time until the system is turned off can be selected in 10-minute steps up to 90 minutes.

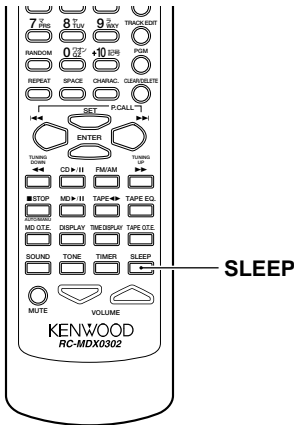

Remote control unit only

Press the SLEEP key repeatedly until the desired OFF time.

Each press increments the period by 10 minutes.

10 → 20 ... 80 → 90 → cancel → 10 ...

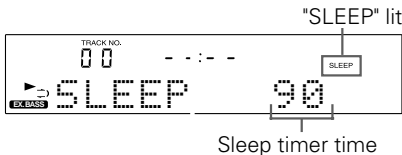

To check the remaining sleep timer :

Press the SLEEP key during execution of the sleep timer.

To cancel sleep timer :

Press the SLEEP key repeatedly until "SLEEP" turns off.

Auto power save (A.P.S.)

The system can be set up so that it turns off automatically when it has been left for more than 30 minutes with all of its CD player, MD recorder and tape deck in stop mode or with its volume set to "0" while the selected input is "TUNER" or "AUX". This facility is convenient for preventing accidentally leaving the system power ON.

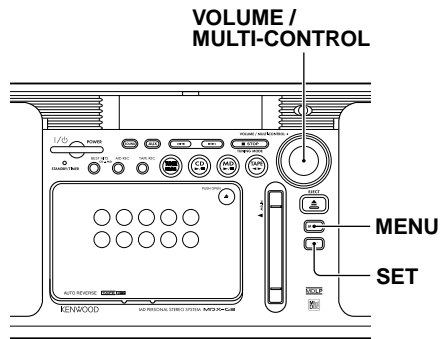

Main unit only

- 1 Press the MENU key.**
- 2 Rotate the VOLUME/MULTI-CONTROL knob so that "A.P.S. SET ?" is displayed, then press the SET key.**

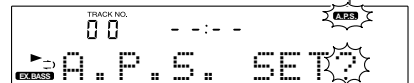

- 3 Rotate the VOLUME/MULTI-CONTROL knob to select "ON" (activated) or "OFF" (deactivated), then press the SET key.**

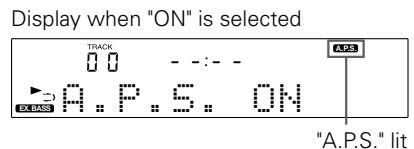

Important items

Caution on condensation

Condensation (of dew) may occur inside the unit when there is a great difference in temperature between this unit and the outside. This unit may not function properly if condensation occurs. In this case, leave the unit for a few hours and restart the operation after the condensation has dried up.

Be specially cautious against condensation in a following circumstance:

When this unit is carried from a place to another across a large difference in temperature, when the humidity in the room where this unit is installed increases, etc.

Note related to transportation and movement

Before transporting or moving this unit, carry out the following operations.

- (1) Remove the CD or MD from the unit.
- (2) Press the MD ►/|| key.
- (3) Wait for some time and verify that the display becomes as shown in the figure.



MD NO DISC

- (4) Press the CD ►/|| key.
- (5) Wait for some time and verify that the display becomes as shown in the figure.



CD NO DISC

- (6) Wait a few seconds and turn the unit off.

Disc handling precautions

Handling

Hold the discs so that you do not touch the playing surface.

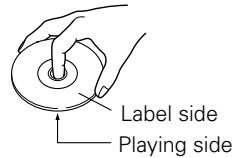

Do not attach paper or tape to either the playing side or the label side of the discs.

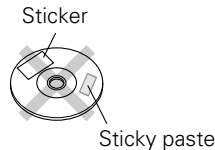

Cleaning

If fingerprints or foreign matter become attached to the disc, lightly wipe the disc with a soft cotton cloth (or similar) from the center of the disc outwards in a radial manner.

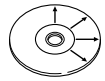

Storage

When a disc is not to be played for a long period of time, remove it from the player and store it in its case.

Discs which can be played with this unit

CD (12 cm, 8 cm), the audio part of CDV, CD-G and CD-EXTRA. Use discs that comply with the IEC standard, for example a disc carrying the  marking on the label surface.

Continued on next page →

Important items (continued)

Never play a cracked or warped disc

During playback, the disc rotates at high speed in the player. Therefore, to avoid danger, never use a cracked or deformed disc or a disc repaired with tape or adhesive agent. Please do not use discs which are not round because they may cause a malfunction.

Disc accessories

The disc accessories (stabilizer, protection sheet, protection ring, etc.) which are marketed for improving the sound quality or protecting discs as well as the disc cleaner should not be used with this system because they may cause malfunction.

Handling of MD

As the MD is accommodated inside a cartridge, it can be handled without caring about dust or fingerprint. However, stained or soiled cartridge may cause malfunction. To enjoy beautiful sound for extended period of time, take care on the following points.

Do not touch the disc directly.

Do not touch the disc by opening the shutter with your hand. The cartridge will be damaged if it is forced open.

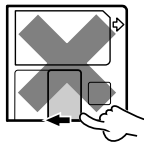

Storage position

Do not leave MDs in place where the temperature and/or humidity are extremely high (for example, in a place subject to direct sunlight).

Dust countermeasure

The shutter of the disc cartridge is permanently open while the disc is loaded in the set. Therefore, to prevent dust from penetrating inside the disc, take the disc out of the unit immediately after completion of recording or playback.

Care

Wipe periodically dust and dirt attached on the cartridge with a dry cloth.

Note on disc accessories

Do not use the lens cleaner for this may lead to malfunction of the unit.

Write protect tab

To protect recorded contents against accidental erasure, set the write protect tab of the disc open. Return the tab to the original position when you want to record signals on the disc.

Disc back side

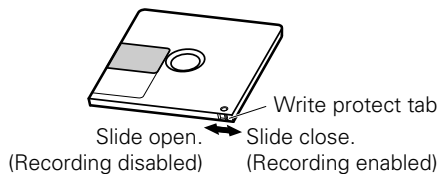

Note on the cartridge labels

Apply each label firmly to every corner so that it will not be peeled off.

Caution on MD-Clip data

Do not attempt to record or edit a disc in which MD-Clip data (still images, etc.) have been recorded. Otherwise, the Clip data may be lost.

Notes on cassette tape

Safety tab (accidental erasure prevention tab)

After an important recording has been finished, break the safety tab, to prevent the recorded contents from being erased or recorded on accidentally.

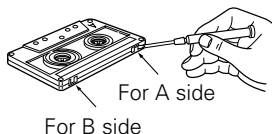

To re-record

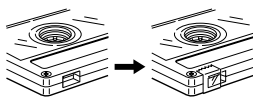

Apply tape only to the position where the tab has been removed.

To store cassette tapes

Do not store the tapes in a place which is subject to direct sunlight, or near equipment that generates heat. Keep the cassette tapes away from any magnetic field.

When there is slack in the tape

In such a case, insert a pencil into the reel hole and wind the reel hub to remove the slack.

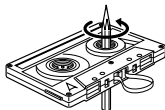

Maintenance

Cleaning the heads and peripheral components

For maintaining the best condition of the deck and for longer service life, always keep the heads, capstan and pinch roller clean.

To clean them, perform the following:

- (1) Open the cassette holder.
- (2) Using a cotton swab dipped in alcohol, clean the head, capstan and pinch roller carefully.

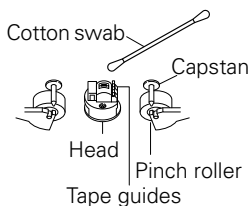

Demagnetizing the head

When the recording / playback head is magnetized, the sound quality will deteriorate. In such a case, demagnetize the head using a commercially available demagnetizer (head eraser).

POINT.

- There are precisely aligned parts around the heads, including the tape guides. When cleaning, pay special attention so as not to apply shock to them.

POINT.

- Do not use an endless tape, as this could damage the mechanism of the unit.

Do not use a cassette with more than 90-minute recording time, for the tape used with such a cassette is very thin and tends to cause troubles such as entanglement around the pinch roller or cutting of tape.

Continued on next page →

Important items (continued)

Maintenance of the unit

When the front panel or case becomes dirty, wipe with a soft, dry cloth. Do not use thinner, benzine, alcohol, etc. for these agents may cause discoloration.

In regard to contact cleaner

Do not use contact cleaners because it could cause a malfunction. Be specially careful not to use contact cleaners containing oil, for they may deform the plastic component.

Memory backup function

Stored contents which are cleared immediately when power plug is unplugged from power outlet.

- Clock display(Backed up for 3 min.)

Stored contents which are cleared in at least a day after power plug is unplugged from power outlet.

- **Amplifier section**

- Input selection
- Volume control value
- AUX input level
- Tone control levels
- Timer setting contents

- **Tuner section**

- Receiving band
- Frequency
- Preset stations
- Auto tuning setting

- **Cassette deck**

- Tape transport direction
- Tape equalizer
- Tape reverse mode

- **MD recorder**

- Recording mode
- Recording speed

WARNING NOTICE:

In most cases it is an infringement of copyright to make copies of tapes or discs without the permission of the copyright owners. Anyone wishing to copy commercially available tapes or disc should contact the mechanical copyright protection society limited or the performing rights society limited.

US and foreign patents licensed from Dolby Laboratories.

In case of difficulty

What seems to be a malfunction is not always so. Before calling for service, check the following table according to the symptom of your trouble.

Operation to reset

The microcomputer may fall into malfunction when a cord is unplugged and plugged again while the unit is ON or due to an external cause. In such a case, the microcomputer should be reset as described below:

Unplug the power cord from the wall outlet and, while holding the POWER | / ⏻ key depressed, plug the power cord again. This initializes the microcomputer. Note that this clears the previously stored memory.

Common section

Sound is not produced.

- ➔ Increase the volume level. (page 10)
- ➔ Unplug the headphones if they are connected. (page 6)

No sound from the headphones.

- ➔ Check if the headphone plug is inserted properly into the jack. (page 6)

Noise interferes.

- ➔ Turn nearby electrical appliances off.
- ➔ Install the audio system more apart from the TV set.

Amplifier / Speaker section

The clock display blinks without changing the figures.

- ➔ Adjust the present time again. (page 7)

Timer operation is not possible.

- ➔ If the present time has not been adjusted or there was a power failure, adjust the present time. (page 7)
- ➔ Set the timer ON time and OFF time. (pages 54 to 60)
- ➔ Press the TIMER key on the remote to activate the timer. (pages 55, 57 and 59)

Radio stations cannot be received.

- ➔ Connect the provided AM loop antenna to the AM ANTENNA jack. (page 5)
- ➔ Extend the FM rod antenna and orient it to the direction in which best reception is obtained. (page 5)
- ➔ Select the correct broadcast band. (pages 8 to 9)
- ➔ Tune to the frequency of the desired station. (page 9)

After a radio station is preset, it cannot be received by pressing the ◀◀ P.CALL or ▶▶ P.CALL key.

- ➔ Preset stations with tunable frequencies. (pages 8 to 9)
- ➔ If the preset memory has been cleared because the power cord has been unplugged for a long period, preset the stations again. (pages 8 to 9)

Continued on next page ➔

In case of difficulty (continued)

Remote control unit

Remote control operation is not possible.

- ➔ Replace batteries with new ones. (page 4)
 - ➔ If the remote is too far away from the system or there is an obstacle in between, point the remote to the remote sensor on the main unit. (page 4)
-

MD recorder section (Symptoms related to the MD standard)

The recordable time of the disc does not increase even when a short track is erased.

- ➔ The remaining recording time does not increase when the total time of the erased track(s) is short.
 - ➔ When the disc has been edited several times, the remaining recordable time may not increase.
-

Tracks cannot be combined.

- ➔ When the disc has been edited several times, the tracks may be unable to be combined.
-

The total of the recorded time and remaining recordable time does not coincide with the recording time specified for the MD.

- ➔ As the minimum unit of disc recording is 2 seconds, the displayed time information may differ from the actual usage of the disc area.
-

Sound is interrupted after forward or reverse search.

- ➔ When the disc has been edited several times, the sound may be intermittent.
-

"READING" is displayed for an abnormally long time.

- ➔ When a new recordable MD (with nothing recorded) is inserted, "READING" is displayed longer than usual.
-

MD recorder section

Sound is not output even when the play key is pressed.

- ➔ Use a recorded MD.
-

Recording is not possible.

- ➔ Restore the position of the write protect tab to the write enabled position. (page 62)
 - ➔ Select the input source to be recorded. (page 36)
-

Recording level is too low (with the AUX input).

- ➔ Adjust the AUX INPUT level. (page 29)
-

Sound is distorted.

- ➔ The recording input level (AUX input) is not adjusted correctly.
Adjust the AUX INPUT level. (page 29)
-

CD player section

Sound it not produced even when the play key is pressed.

- ➔ Insert the CD properly. (page 10)
 - ➔ Clean the disc as described in "Disc handling precautions". (pages 61 and 62)
 - ➔ Remove condensation as described in "Caution on condensation". (page 61)
-

Sound skips.

- ➔ Clean the disc as described in "Disc handling precautions". (pages 61 and 62)
 - ➔ Check that the disc is not scratched.
 - ➔ Install the unit in a place not subject to vibrations.
-

Cassette deck section

Audio is not reproduced when the play key is pressed.

- ➔ Clean the heads as described in "Cleaning the heads and peripheral components". (page 63)
 - ➔ The tape is wound too tight due to irregular winding. (page 63)
 - ➔ Use a prerecorded tape.
-

The tape operation does not occur when a control key is pressed.

- ➔ Close the cassette holder completely. (page 14)
-

The cassette holder will not open.

- ➔ Press the area marked "▲PUSH OPEN" on the cassette holder in stop mode.
 - ➔ Reset the microcomputer. (page 65)
-

Sound is faded or high-frequencies are not reproduced.

- ➔ Clean the heads as described in "Cleaning the heads and peripheral components". (page 63)
 - ➔ The tape is stretched.
-

Sound is abnormal.

- ➔ The recording input level (AUX input) is not adjusted correctly.
Adjust the AUX INPUT level. (page 29)
 - ➔ An attempt is made to play back a Dolby-encoded tape without switching the tape equalizer on. Switch the tape equalizer on. (page 15)
-

Recording is impossible.

- ➔ Demagnetize the head by referring to "Demagnetizing the head". (page 63)
 - ➔ Use a tape the accidental erasure protect tab of which is not broken or stop the hole made by breaking the tab. (page 63)
 - ➔ Close the cassette holder completely. (page 22)
 - ➔ Select the input from the source to be recorded.
 - ➔ Change the tape transport direction or re-insert the tape so that the different side faces the front. (page 23)
-

Display message list

BLANK DISC	→ The disc does not contain any recordings.
BUFFER OVER	→ An attempt is made to perform high-speed recording of more than 100 tracks within 74 minutes.
CAN'T EDIT	→ An attempt is made to edit a track which is too short.
CD LID OPEN	→ The CD door is open.
CD NO DISC	→ A CD is not inserted.
DISC ERROR	→ The contents of UTOC* are abnormal. In this case, perform "ALL ERASE" operation (page 52). If this is not possible, use another disc.
DISC FULL	→ There is no recordable area on the disc or an attempt is made to record a 256th track. In this case, use another recordable disc. Note that more than 255 tracks cannot be recorded on a disc.
FULL	→ An attempt is made to select a 33rd track when setting the Q.ERASE or Q.MOVE operation.
MD NO DISC	→ An MD is not inserted.
MD WRITING	→ The data related to editing or recording is being written in the disc.
NO TRACKS	→ The MD disc does not contain any track but has a disc title.
PGM FULL	→ An attempt is made to select a 33rd track when programming CD or MD tracks.
PGM Mode	→ An attempt is made to perform random playback, high-speed recording (CD→MD) or MD title input while the system is in the program mode. The program mode should be canceled before starting these operations. (pages 31, 34 and 42)
PLAY ONLY	→ The inserted MD is a playback only disc. Insert a recordable MD.
PROTECTED	→ The inserted MD is write-protected. In this case, enable the recording. (page 62) The erasure protect tab of the cassette is broken. Apply tape only to the position where the tab has been removed. (page 63)
RANDOM Mode	→ An attempt is made to perform MD O.T.E. recording or TAPE O.T.E. recording while the system is in the CD random play mode. The random mode should be canceled before starting these operations. (page 31)

READING	→ The TOC* information in the disc is being read.
SCMS	→ An attempt is made to record digital signal from a source while its digital copy has been prohibited by SCMS. This unit cannot record this kind of signal.
TEXT FULL	→ An attempt is made to display the text information of a CD TEXT disc containing more than 1 kB of text information.
TITLE FULL	→ An attempt is made to assign a title with more characters than usable. The number of characters that can be input is 1792 characters per disc or 80 characters per track title (including "LP:").

* All minidisks contain a Table of Contents (TOC) in addition to sound signals. The TOC is similar to the table of contents in a book and contains information, such as track numbers, track length, and character information, that cannot be rewritten.

In addition to the TOC, minidisks also contain a special User's Table of Contents (UTO) that contains track number, track length, and character information, that can be rewritten.

Specifications

Amplifier section

Rated output power during STEREO operation
1 kHz, 10%, 4Ω 4 W + 4 W

Tuner section

FM tuner
Tuning frequency range
..... 87.5 MHz ~ 108 MHz
AM tuner
Tuning frequency range
..... 531 kHz ~ 1,602 kHz

MD Recorder section

Laser wave length 765 to 805 nm
Laser power class Class 3B
Laser Semiconductor laser
Recording method
..... Field modulating overwriting
Audio compression
..... AT-RAC, AT-RAC3
D/A conversion 1 Bit
Wow & flutter Unmeasurable limit

CD Player section

Laser wave length 760 to 800 nm
Laser power class Class 1
Laser Semiconductor laser
D/A conversion 1 Bit
Over sampling frequency 8 fs (352.8 kHz)
Frequency response 20 Hz to 20 kHz
Wow & flutter Unmeasurable limit

Cassette Deck section

Track 4-track, 2-channel stereo
Recording system
..... AC bias (Frequency: 105 kHz)
Heads
Playback/recording head x 1
Erasing head x 1
Fast winding time
..... Approx. 110 sec. (C-60 tape)

Speakers

Enclosures Bass-reflex type
Speaker units 80 mm, cone type

General

Power consumption 35 W
Dimensions W : 409 mm (16-1/8")
H : 172 mm (6-3/4")
D : 225 mm (8-7/8")
Weight (net) 5.6 kg (12.3 lb)



- KENWOOD follows a policy of continuous advancements in development. For this reason specifications may be changed without notice.
- The full performance may not be exhibited in an extremely cold location (under a water-freezing temperature).

Controls and indicators

Main Unit

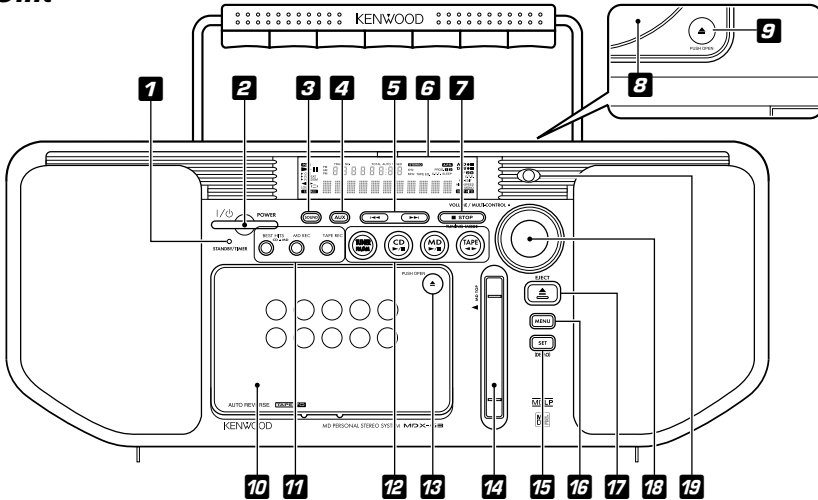

- | | | |
|---------------------------------------|----------------------------------|-------------------------------------|
| 1 STANDBY/TIMER indicator (71) | 11 BEST HITS (41) | 15 SET/(DEMO) (6, 7) |
| 2 POWER I/⏻ | MD REC (36) | 16 MENU (7) |
| 3 SOUND (28) | TAPE REC (38) | 17 ▲EJECT (MD ejection) (13) |
| 4 AUX (18) | 12 TUNER FM/AM (8) | 18 VOLUME/MULTI-CONTROL |
| 5 ◀◀, ▶▶ (Skip) | CD ▶/ (Play/ Pause) (10) | 19 REMOTE (Remote sensor) |
| 6 Display | MD ▶/ (Play/ Pause) (12) | (4) |
| 7 ■STOP/TUNING MODE (17) | TAPE ◀▶ (Play) (14) | |
| 8 CD door (10) | 13 ▲PUSH OPEN | |
| 9 ▲PUSH OPEN(CD ejection)(10) | (Tape ejection) (14) | |
| 10 Cassette holder (14) | 14 MD insertion slot (12) | |

Figures inside parentheses are reference pages.

Standby mode

While the standby indicator of the unit is lit, a small amount of current is flowing into the unit's internal circuitry to back up the memory. This condition is referred to as the standby mode of the unit. While the unit is in the standby mode, it can be turned ON from the remote control unit.

Relationship between the STANDBY/TIMER indicator and the status of unit

Indicator condition	Unit status
Off	Power is ON.
Red lighting	The power cord is plugged into a wall outlet and the power is in the STANDBY mode
Green lighting	Timer has been activated.
Green blinking	Timer setting is erroneous, an attempt is made to set the timer without setting the time of the day, or the timer was not activated correctly due to a power failure, etc.
Red blinking	Failure in the power circuitry. Have your dealer service the unit.

Remote control unit

The keys on the remote control unit with the same names as on the main unit have the same function as the keys on the main unit.

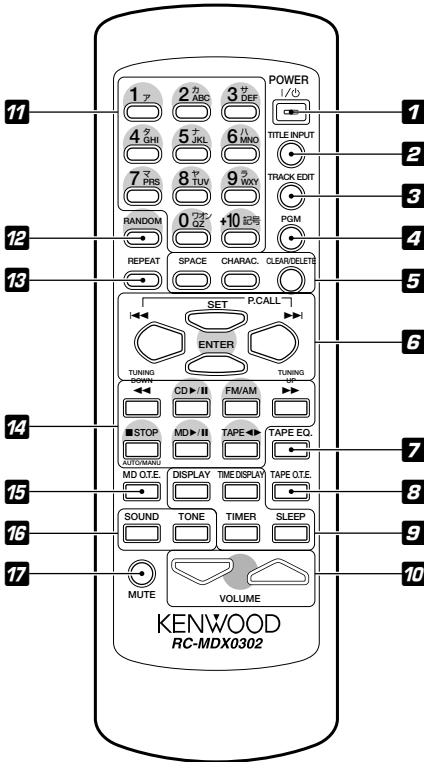

- 1** POWER I/⏻
- 2** TITLE INPUT (42)
- 3** TRACK EDIT (47)
- 4** PGM (30)
- 5** SPACE (42)
CHARAC. (42)
CLEAR/DELETE (30, 42)
- 6** ◀◀ P. CALL ▶▶ (Skip)
SET (7)
ENTER (9)
- 7** TAPE EQ. (15)
- 8** TAPE O.T.E. (23)
- 9** DISPLAY (26)
TIME DISPLAY (26)
TIMER (55)
SLEEP (60)
- 10** VOLUME (10)
- 11** Numeric keys (9) / Character input keys (42)
- 12** RANDOM (31)
- 13** REPEAT (31)
- 14** ◀◀ TUNING DOWN
▶▶ TUNING UP
CD ▶|| (Play/ Pause) (10)
FM/AM (8)
MD ▶|| (Play/ Pause) (12)
TAPE ◀ (Play) (14)
■ STOP (Pause), AUTO/MANU (17)
- 15** MD O.T.E. (21)
- 16** SOUND (28)
TONE (28)
- 17** MUTE (29)

Figures inside parentheses are reference pages.

KENWOOD

For your records

Record the serial number, found on the back of the unit, in the spaces designated on the warranty card, and in the space provided below. Refer to the model and serial numbers whenever you call upon your dealer for information or service on this product.

Model _____ Serial Number _____

Free Manuals Download Website

<http://myh66.com>

<http://usermanuals.us>

<http://www.somanuals.com>

<http://www.4manuals.cc>

<http://www.manual-lib.com>

<http://www.404manual.com>

<http://www.luxmanual.com>

<http://aubethermostatmanual.com>

Golf course search by state

<http://golfingnear.com>

Email search by domain

<http://emailbydomain.com>

Auto manuals search

<http://auto.somanuals.com>

TV manuals search

<http://tv.somanuals.com>