

# KENWOOD

## INSTRUCTION MANUAL



UHF FM TRANSCEIVER

# TK-3230

## ProTalk<sup>XLS</sup>

Kenwood Corporation

© B62-1976-20 (K)  
09 08 07 06 05 04 03 02

# THANK YOU

We are grateful for your purchase of this **Kenwood** product and welcome you to the Business Radio Service (BRS). Your **Kenwood** 2-way Business Radio is called a “transceiver”, meaning “transmitter & receiver”. We believe this easy-to-use transceiver will provide you with dependable and reliable communications. This **Kenwood** transceiver is a precision device. Treat it with care, and you will enjoy years of reliable operation.

## FEATURES

- Lightweight and compact design using a lithium-ion battery pack, with a sturdy, polycarbonate body and a spring-loaded belt clip.
- 122 tone/code settings for each channel, allowing you to ignore unwanted calls.
- Privacy Talk scrambles all your voice messages, giving you complete privacy for your conversations.
- FleetSync operation, allowing a variety of call types.
- Automatic battery power saver, providing you with longer battery usage.
- Battery power level indicator with low battery power warning.
- Key lock and Super Lock prevent you from accidentally changing your transceiver settings.
- Ten different calling alert tones allows you to identify yourself to your group before you begin speaking.
- Hands free operation when using an optional headset.

## OPERATING CONDITIONS

Open locations (no obstructions)	Up to 5 miles (8 km)
Residential areas (near buildings)	Up to 1.5 miles (2.4 km)
In steel/ concrete reinforced buildings	Up to 225,000 ft <sup>2</sup> (20,900 m <sup>2</sup> )
In high rises	Up to 17 floors

**Note:** The listed ranges are based on field testing and may vary with your operating conditions.

## FCC LICENSE INFORMATION

Your **Kenwood** radio operates on communications frequencies which are subject to FCC (Federal Communications Commission) Rules & Regulations. FCC Rules require that all operators using Private Land Mobile radio frequencies obtain a radio license before operating their equipment. Application for license must be made on FCC form 601.

**FAX:** Forms can be obtained by fax from the FCC Fax-On-Demand system. Call 1-202-418-0177 from your fax machine to request the documents.

**MAIL:** Forms can be ordered by telephone, and will be sent to you by first class mail. Call the FCC Forms Hotline at 1-800-418-FORM (1-800-418-3676).

**INTERNET:** Form 601 and instructions can be downloaded from the FCC Forms website at:  
<http://www.fcc.gov/formpage.html>

Before filling out your Form 601 application Technical Data section, you must decide which frequency (or frequencies) you will operate on. Refer to the frequency chart on page 54.

**Questions?** Call the FCC for license application questions at 1-888-CALL-FCC (1-888-225-5322).

## CHANNEL SPACING

The ProTalkXLS uses 12.5 kHz channel spacing, as per the regulations of the FCC. Transceivers using 12.5 kHz channel spacing may not have optimal sound quality when used with transceivers using 25 kHz channel spacing.

## NOTICES TO THE USER

This device complies with Part 15 of the FCC Rules. Operation is subject to the following two conditions:

- (1) this device may not cause harmful interference, and
- (2) this device must accept any interference received, including interference that may cause undesired operation.

One or more of the following statements may be applicable:

### FCC WARNING

This equipment generates or uses radio frequency energy. Changes or modifications to this equipment may cause harmful interference unless the modifications are expressly approved in the instruction manual. The user could lose the authority to operate this equipment if an unauthorized change or modification is made.

### INFORMATION TO THE DIGITAL DEVICE USER REQUIRED BY THE FCC

This equipment has been tested and found to comply with the limits for a Class B digital device, pursuant to Part 15 of the FCC Rules. These limits are designed to provide reasonable protection against harmful interference in a residential installation.

This equipment generates, uses and can generate radio frequency energy and, if not installed and used in accordance with the instructions, may cause harmful interference to radio communications. However, there is no guarantee that the interference will not occur in a particular installation. If this equipment does cause harmful interference to radio or television reception, which can be determined by turning the equipment off and on, the user is encouraged to try to correct the interference by one or more of the following measures:

- Reorient or relocate the receiving antenna.
- Increase the separation between the equipment and receiver.
- Connect the equipment to an outlet on a circuit different from that to which the receiver is connected.
- Consult the dealer for technical assistance.

## SAFETY INFORMATION:

Your wireless hand-held portable transceiver has been designed using a low power transmitter.

When the **PTT** switch is pressed, the transceiver generates radio frequency (RF) electromagnetic energy (EME).

This transceiver is designed to comply with the FCC Report and Order FCC 96-326 (August, 1996).



CAUTION

- Do not transmit for more than 50% of the total operating time. Transmitting for over 50% of the operating time may exceed the FCC RF exposure compliance requirements. Transmission occurs while you are pressing the PTT switch and is confirmed by the LED that lights red while transmitting.
- To transmit, speak into the speaker area in your normal voice while holding the transceiver upright and keep the antenna at least 2 inches (5 cm) from your head and body.
- When using a headset, ensure that the antenna is at least 2 inches (5 cm) away from your body whenever you are transmitting.
- Use only **Kenwood** genuine accessories. Unauthorized modifications, or attachments may damage the transceiver and violate FCC rules and regulations.



### ATTENTION (U.S.A. Only):

The RBRC Recycle seal found on **Kenwood** lithium-ion (Li-ion) battery packs indicates **Kenwood's** voluntary participation in an industry program to collect and recycle Li-ion batteries after their operating life has expired. The RBRC program is an alternative to disposing Li-ion batteries with your regular refuse or in municipal waste streams, which is illegal in some areas.

For information on Li-ion battery recycling in your area, call (toll free) 1-800-8-BATTERY (1-800-822-8837).

**Kenwood's** involvement in this program is part of our commitment to preserve our environment and conserve our natural resources.

Download from [Www.Somanuals.com](http://www.Somanuals.com). All Manuals Search And Download.

- Government law prohibits the operation of unlicensed radio transmitters within the territories under government control.
- Illegal operation is punishable by fine and/or imprisonment.
- Refer service to qualified technicians only.

**Safety:** It is important that the operator is aware of and understands hazards common to the operation of any transceiver.

## PRECAUTIONS

- Do not charge the transceiver and battery pack when they are wet.
- Ensure that there are no metallic items located between the transceiver and the battery pack.
- Do not use options not specified by **Kenwood**.
- If the die-cast chassis or other transceiver part is damaged, do not touch the damaged part.
- If a headset or headphone is connected to the transceiver, reduce the transceiver volume. Pay attention to the volume level when turning the squelch off.
- Do not place the microphone cable around your neck while near machinery that may catch the cable.
- Do not place the transceiver on unstable surfaces.
- Ensure that the end of the antenna does not touch your eyes.
- When the transceiver is used for transmission for many hours, the radiator and chassis will become hot. Do not touch these locations when replacing the battery pack.
- Do not immerse the transceiver in water.
- Always switch the transceiver power off when installing optional accessories.

**WARNING**

Turn the transceiver power off in the following locations:

- In explosive atmospheres (inflammable gas, dust particles, metallic powders, grain powders, etc.).
- While taking on fuel or while parked at gasoline service stations.
- Near explosives or blasting sites.
- In aircrafts. (Any use of the transceiver must follow the instructions and regulations provided by the airline crew.)
- Where restrictions or warnings are posted regarding the use of radio devices, including but not limited to medical facilities.
- Near persons using pacemakers.

**CAUTION**

- Do not disassemble or modify the transceiver for any reason.
- Do not place the transceiver on or near airbag equipment while the vehicle is running. When the airbag inflates, the transceiver may be ejected and strike the driver or passengers.
- Do not transmit while touching the antenna terminal or if any metallic parts are exposed from the antenna covering. Transmitting at such a time may result in a high-frequency burn.
- If an abnormal odor or smoke is detected coming from the transceiver, switch the transceiver power off immediately, remove the battery pack from the transceiver, and contact your **Kenwood** dealer.
- Use of the transceiver while you are driving may be against traffic laws. Please check and observe the vehicle regulations in your area.
- Do not expose the transceiver to extremely hot or cold conditions.
- Do not carry the battery pack (or battery case) with metal objects, as they may short the battery terminals.
- When operating the transceiver in areas where the air is dry, it is easy to build up an electric charge (static electricity). When using an earphone accessory in such conditions, it is possible for the transceiver to send an electric shock through the earphone and to your ear. We recommend you use only a speaker/microphone in these conditions, to avoid electric shocks.

# CONTENTS

UNPACKING AND CHECKING EQUIPMENT .....	1
SUPPLIED ACCESSORIES .....	1
PREPARATION .....	2
BATTERY PACK PRECAUTIONS .....	2
INSTALLING/ REMOVING THE BATTERY PACK .....	7
CHARGING THE BATTERY PACK .....	8
INSTALLING/ REMOVING THE BELT CLIP .....	9
INSTALLING/ REMOVING OPTIONAL ACCESSORIES .....	10
ORIENTATION .....	11
DISPLAY .....	12
GETTING STARTED .....	13
CHANNEL FREQUENCY SETUP .....	15
QUIET TALK/ DIGITAL QUIET TALK .....	16
SCANNING THE CHANNELS .....	17
REVERT CHANNEL .....	18
MONITORING A CHANNEL .....	19
SQUELCH LEVEL .....	19
VOICE OPERATED TRANSMISSION (VOX) .....	20
VOX OPERATION .....	20
VOX GAIN LEVEL .....	20
VOX DELAY TIME .....	21
TRANSMIT INHIBIT WHILE RECEIVING .....	22
VOX PROCEED TONE .....	23
PRIVACY TALK .....	24
FleetSync: ALPHANUMERIC 2-WAY PAGING FUNCTION .....	25
CALL KEY SETUP .....	25
CALL ALERT TONE .....	26
SELCALL (SELECTIVE CALLING) .....	28
OPERATING FEATURES .....	37
TRANSMIT POWER .....	37
COMPANDER .....	38



KEY LOCK.....	38
SUPER LOCK.....	39
DISPLAY BACKLIGHT.....	40
MIC SENSE.....	41
TIME-OUT TIMER.....	41
BATTERY SAVER.....	42
BATTERY LEVEL INDICATOR.....	43
INCOMING CALL NOTIFICATION.....	45
BUSY CHANNEL LOCKOUT (BCL).....	46
BEEP TONE.....	46
MODE RESET TIMER.....	47
RESETTING THE TRANSCEIVER.....	48
OPTIONAL ACCESSORIES.....	49
MENUS.....	50
QT TONES/ DQT CODES.....	52
CHANNEL FREQUENCIES.....	54
SPECIFICATIONS.....	55
TROUBLESHOOTING GUIDE.....	56

---

---

# UNPACKING AND CHECKING EQUIPMENT

---

---

Carefully unpack the transceiver. We recommend you identify the items listed in the following table before discarding the packing material. If any items are missing or have been damaged during shipment, file a claim with the carrier immediately.

## SUPPLIED ACCESSORIES

Item	Part Number	Quantity
KBH-14 Belt clip	J29-0736-XX	1
Screw set	N99-2063-XX	1
KNB-46L battery pack	W09-1038-XX	1
KSC-37 rapid charger	W08-0995-XX	1
Warranty card	—	1
Instruction manual	B62-1976-XX	1

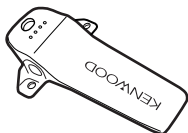

KBH-14 Belt clip



Screw set



KNB-46L battery pack

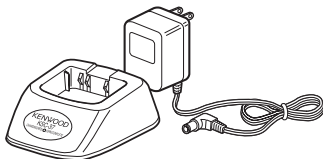

KSC-37 rapid charger

---

---

# PREPARATION

---

---

## BATTERY PACK PRECAUTIONS

Do not use battery packs or battery chargers not recommended by **Kenwood**.



### CAUTION

- ◆ Do not recharge the battery pack if it is already fully charged. Doing so may cause the lifespan of the battery pack to shorten or the battery pack may be damaged.
- ◆ After charging the battery pack, disconnect it from the charger. If the charger power is reset (turned ON after being turned OFF), recharging will start again and the battery pack will become overcharged.
- ◆ Do not use the transceiver while charging the battery pack. We recommend you switch the transceiver power OFF while charging is taking place.
- ◆ Do not charge the battery pack when the battery pack or transceiver is wet, so as to avoid the risk of fire or damage. Wipe the water from the battery pack or transceiver using a dry cloth before charging.
- ◆ Do not short the battery terminals or dispose of the battery by fire.
- ◆ Never attempt to remove the casing from the battery pack.

## Information concerning the Li-ion battery pack:

The battery pack includes flammable objects such as organic solvent. Mishandling may cause the battery to rupture producing flames or extreme heat, deteriorate, or cause other forms of damage to the battery. Please observe the following prohibitive matters.



**DANGER**

- **Do not disassemble or reconstruct battery!**  
The battery pack has a safety function and protection circuit to avoid danger. If they suffer serious damage, the battery may generate heat or smoke, rupture, or burst into flame.
- **Do not short-circuit the battery!**  
Do not join the + and – terminals using any form of metal (such as a paper clip or wire). Do not carry or store the battery pack in containers holding metal objects (such as wires, chain-necklaces or hairpins). If the battery pack is short-circuited, excessive current will flow and the battery may generate heat or smoke, rupture, or burst into flame. It will also cause metal objects to heat up.
- **Do not incinerate or apply heat to the battery!**  
If the insulator is melted, the gas release vent or safety function is damaged, or the electrolyte is ignited, the battery may generate heat or smoke, rupture, or burst into flame.
- **Do not use or leave the battery near fires, stoves, or other heat generators (areas reaching over 80°C/ 176°F)!**  
If the polymer separator is melted due to high temperature, an internal short-circuit may occur in the individual cells and the battery may generate heat or smoke, rupture, or burst into flame.
- **Avoid immersing the battery in water or getting it wet by other means!**  
If the battery becomes wet, wipe it off with a dry towel before use. If the battery's protection circuit is damaged, the battery may charge at extreme current (or voltage) and an abnormal chemical reaction may occur. The battery may generate heat or smoke, rupture, or burst into flame.

**DANGER**

- **Do not charge the battery near fires or under direct sunlight!**

If the battery's protection circuit is damaged, the battery may charge at extreme current (or voltage) and an abnormal chemical reaction may occur. The battery may generate heat or smoke, rupture, or burst into flame.

- **Use only the specified charger and observe charging requirements!**

If the battery is charged in unspecified conditions (under high temperature over the regulated value, excessive high voltage or current over regulated value, or with a remodelled charger), it may overcharge or an abnormal chemical reaction may occur. The battery may generate heat or smoke, rupture, or burst into flame.

- **Do not pierce the battery with any object, strike it with an instrument, or step on it!**

This may break or deform the battery, causing a short-circuit. The battery may generate heat or smoke, rupture, or burst into flame.

- **Do not jar or throw the battery!**

An impact may cause the battery to leak, generate heat or smoke, rupture, and/or burst into flame. If the battery's protection circuit is damaged, the battery may charge at an abnormal current (or voltage), and an abnormal chemical reaction may occur.

- **Do not use the battery pack if it is damaged in any way!**

The battery may generate heat or smoke, rupture, or burst into flame.

- **Do not solder directly onto the battery!**

If the insulator is melted or the gas release vent or safety function is damaged, the battery may generate heat or smoke, rupture, or burst into flame.

- **Do not reverse the battery polarity (and terminals)!**

When charging a reversed battery, an abnormal chemical reaction may occur. In some cases, an unexpected large amount of current may flow upon discharging. The battery may generate heat or smoke, rupture, or burst into flame.



**DANGER**

- **Do not reverse-charge or reverse-connect the battery!**  
The battery pack has positive and negative poles. If the battery pack does not smoothly connect with a charger or operating equipment, do not force it; check the polarity of the battery. If the battery pack is reverse-connected to the charger, it will be reverse-charged and an abnormal chemical reaction may occur. The battery may generate heat or smoke, rupture, or burst into flame.
- **Do not touch a ruptured and leaking battery!**  
If the electrolyte liquid from the battery gets into your eyes, wash your eyes out with fresh water as soon as possible, without rubbing your eyes. Go to the hospital immediately. If left untreated, it may cause eye-problems.



**DANGER**

- **Do not place the battery pack into a microwave or high pressure container!**  
The battery may generate heat or smoke, rupture, or burst into flame.
- **Keep ruptured and leaking battery packs away from fire!**  
If the battery pack is leaking (or the battery emits a bad odor), immediately remove it from flammable areas. Electrolyte leaking from battery can easily catch on fire and may cause the battery to generate smoke or burst into flame.
- **Do not use an abnormal battery!**  
If the battery pack emits a bad odor, appears to have different coloring, is deformed, or seems abnormal for any other reason, remove it from the charger or operating equipment and do not use it. The battery may generate heat or smoke, rupture, or burst into flame.

## ■ Using the Li-ion Battery Pack

- Charge the battery pack before using it.
- To keep the battery discharge at a minimum, remove the battery pack from the equipment when it is not in use. Store the battery pack in a cool and dry location.
- When storing the battery pack for a long period:
  - 1 Remove the battery pack from the equipment.
  - 2 Discharge the battery pack, if possible.
  - 3 Store the battery pack in a cool (below 25°C/ 77°F) and dry location.

## ■ Characteristics of the Li-ion Battery Pack

- As the battery pack is charged and discharged repeatedly, the battery capacity decreases.
- Even if the battery pack is unused, the battery pack degrades.
- It takes a longer time to charge the battery pack in cooler areas.
- The life of battery pack is shortened when it is charged and discharged in hotter areas. When the battery pack is stored in a hot location, the battery pack degrades quicker. Do not leave the battery pack in vehicles or near heating appliances.
- When the battery pack operating time becomes short, even if it is fully charged, replace the battery pack. Continuing to charge and discharge the battery pack may result in electrolyte leakage.

## INSTALLING/ REMOVING THE BATTERY PACK

The battery pack is not charged at the factory; charge it before use {page 8}.

Average battery pack life using low power :

18 hours (Battery Saver : off)

Average battery pack life using high power :

14 hours (Battery Saver : off)

- Average times are calculated using 5% transmit time, 5% receive time, and 90% standby time.



CAUTION

- ◆ Do not short the battery terminals or dispose of the battery by fire.
- ◆ Never attempt to remove the casing from the battery pack.

- 1 Match the guides of the battery pack with the corresponding grooves on the upper rear of the transceiver, then firmly press the battery pack to lock it in place.

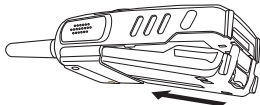

- 2 To remove the battery pack, lift the safety catch, press the release latch, then pull the battery pack away from the transceiver.

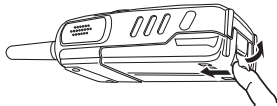



## CHARGING THE BATTERY PACK

Initial charging of the battery pack after purchase or extended storage (greater than 2 months) will not bring the battery pack to its normal operating capacity. After repeating the charge/discharge cycle two or three times, the operating capacity will increase to normal.



### CAUTION

- ◆ Do not recharge the battery pack if it is already fully charged. Doing so may cause the life of the battery pack to shorten or the battery pack may be damaged.
- ◆ After recharging the battery pack, disconnect it from the charger. Charging the battery pack for more than 5 days may reduce the battery pack life due to overcharging.

---

### Note:

- ◆ The ambient temperature should be between 41°F and 104°F (5°C and 40°C) while charging is in progress. Charging outside this range may not fully charge the battery.
  - ◆ Always switch OFF the transceiver equipped with a battery pack before charging. Using the transceiver while charging its battery pack will interfere with correct charging.
  - ◆ The battery pack life is over when its operating time decreases even though it is fully and correctly charged. Replace the battery pack.
- 

- 1 Plug the AC adapter cable into the adapter jack located on the rear of the charger.
- 2 Plug the AC adapter into an AC outlet.

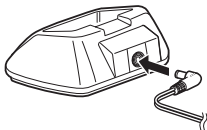

**3** Slide a battery pack or a transceiver equipped with a battery pack into the battery pack slot.

- Make sure the metal contacts of the battery pack mate securely with the charger terminals.
- The indicator lights red and charging starts.

**4** When charging is completed, the indicator lights green. Remove the battery pack or the transceiver from the battery pack slot.

- It takes approximately 2.5 hours to charge the battery pack.
- When the charger will not be used for a long time, unplug the AC adapter from the AC outlet.

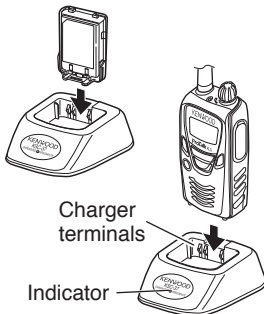

## INSTALLING/ REMOVING THE BELT CLIP

If desired, attach the belt clip to the rear of the transceiver using the 2 supplied screws.

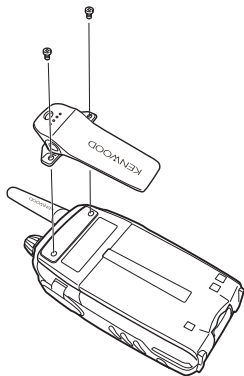

## INSTALLING/ REMOVING OPTIONAL ACCESSORIES

---

**Note:** Always switch OFF the transceiver power when installing or removing optional accessories.

---

The following accessories can be used with this transceiver:

- KMC-17 Speaker-Microphone
- KMC-21 Speaker-Microphone
- KHS-22 Headset
- EMC-3 Clip Microphone with Earphone
- KBH-14 Belt clip

To install these accessories:

- 1 Open the **SP/MIC** tabs on the side of the transceiver.
- 2 Insert the accessory's plugs into the **SP/MIC** jacks.
- 3 When you remove the accessory from the transceiver, be sure to cover the **SP/MIC** jacks with the attached tabs, in order to keep dust and dirt away from the contacts.

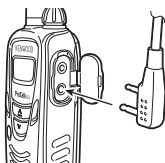

---

**Note:** Refer to the accessory instruction manuals for detailed instructions on each of these accessories.





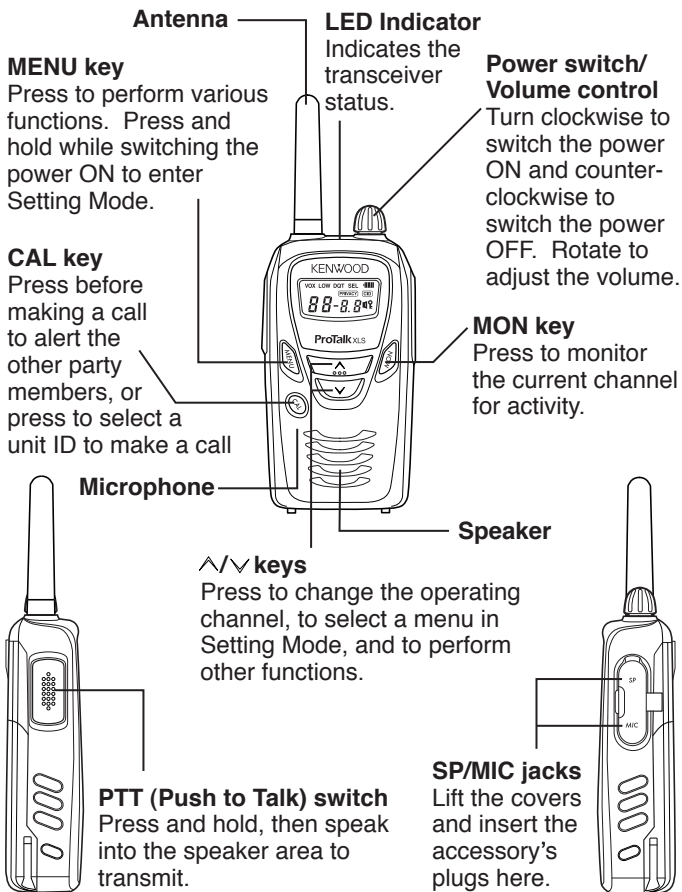

---

# ORIENTATION



## DISPLAY



Icon	Description
VOX	Appears when VOX is activated.
LOW	Appears when using low transmit power.
DQT	Appears when the channel is set up with a DQT code.
SEL	Appears when making or receiving a selcall.
	Displays the approximate battery power remaining. Blinks when the battery power is low, while transmitting.
	Appears when Privacy Talk is activated.
	Appears when the Caller's ID is displayed.
	Displays the channel number along with its QT/DQT setting (if any). Also displays various menus and menu settings.
.	Appears when compander is activated.
	Appears while monitoring a channel.
	Appears when the transceiver keys have been locked.

---

---

# GETTING STARTED

---

---

## ① Switch the Power ON.

Switch the transceiver power ON by turning the **Power** switch/ **Volume** control clockwise.

- A confirmation tone sounds, the LCD lights up momentarily, then the current channel number is displayed.

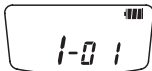

To switch the transceiver power OFF, turn the **Power** switch/ **Volume** control fully counterclockwise, until a click sounds.

## ② Adjust the Volume.

Set your desired volume level by rotating the **Power** switch/ **Volume** control.

- Clockwise increases the volume and counterclockwise decreases the volume.



---

**Note:** To adjust the volume using background noise as a reference, use the Monitor function {page 19}.

---

## ③ Select a Channel.

Select a channel by pressing the  $\wedge$  or  $\vee$  keys.

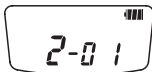

- A confirmation tone sounds each time you press the  $\wedge$  or  $\vee$  key.

- When you receive a call on your selected channel, you will hear audio from the speaker and the LED will light green.
- To use a signaling code, refer to “QUIET TALK/ DIGITAL QUIET TALK” {page 16}.

#### ④ Make a Call.

- 1 Press the **MON** key to make sure the channel is not in use {page 19}.



- 2 Press and release the **CAL** key to alert the other parties that you are beginning a call.
  - A call alert tone will sound on the other party's transceiver.



- 3 Press and hold the **PTT** switch, then speak into the speaker area to transmit.
  - The LED lights red while transmitting.
  - For best sound quality, speak into the speaker area in your normal speaking voice while holding the transceiver approximately 1.5 inches (3 to 4 cm) from your lips.



- 4 Release the **PTT** switch when you have finished speaking.



---

---

# CHANNEL FREQUENCY SETUP

---

---

You can change the default frequency of each channel:

- 1 With the transceiver power OFF, press and hold the **MENU** key (for approximately 1 second) while turning the transceiver ON.
- 2 Press the  $\wedge$  or  $\vee$  key to select a channel.
  - The current frequency list number appears beside the channel number.

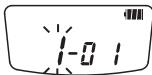

- 3 Press the **MENU** key then press  $\wedge$  or  $\vee$  to select the frequency list number for the channel.

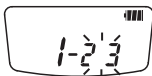

- Refer to page 54 for the frequencies available for each channel.
- 4 Press the **MENU** key to exit the selection, then repeat steps 2 and 3 to set additional channels.
  - 5 Press the **PTT**, **MON**, or **CAL** key to exit Setting Mode.



---

---

# QUIET TALK/ DIGITAL QUIET TALK

---

---

QT (Quiet Talk) and DQT (Digital Quiet Talk) are functions that reject signals from undesired parties that are using the same channel as you. You will hear audio from the speaker only when you receive a signal that contains a tone or code matching the one set up on the channel you are using. Likewise, when you transmit on a channel set up with QT or DQT, the receiving station must have a matching tone or code in order to hear your signal.

You can select a tone or code for each channel. There are 39 QT tones and 83 DQT codes. After changing the QT/ DQT setting, confirm that the other members in your group have selected the same tone or code.

**1** Press the **MENU** key.

- The current setting blinks.

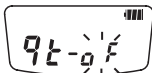

**2** Press the  $\wedge$  or  $\vee$  key to select your desired value.

- The values range from 01 to 39 for QT tones, then proceed to 01 to 83 for DQT codes. When selecting a DQT code, the **DQT** icon appears on the display.

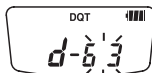
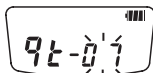

- Select “0 F” to turn off both QT and DQT.
  - Refer to pages 52 and 53 for the tones/codes corresponding to the QT/DQT numbers.
- 3** Press the **MENU** key 4 times, or press the **PTT**, **MON**, or **CAL** key or after mode reset time has elapsed {page 47} to confirm the selection and return to operating mode.

---

---

## SCANNING THE CHANNELS

---

---

You can scan the transceiver channels to search for a signal. When the transceiver verifies a signal on a channel, it proceeds to check whether or not its QT/ DQT setting matches that which is set up on your transceiver (if you have set a channel with QT/ DQT). If the QT/ DQT matches, the transceiver stops at the channel and opens the squelch so you can listen to the call. If the QT/ DQT does not match, the call is ignored and scanning continues.

Before you can use the scan function, ensure that it is activated. You can turn the scan function (the ability to perform scan) ON or OFF in Setting mode.

- 1 With the transceiver power OFF, press and hold the **MENU** key while turning the transceiver power ON (for 1 second).
- 2 Press the  $\wedge$  or  $\vee$  key to select “5 $\bar{L}$ ”.

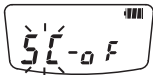

- 3 Press the **MENU** key then press  $\wedge$  or  $\vee$  to select “5 $\bar{L}$ -o F” (scan function disabled) or “5 $\bar{L}$ -o n” (scan function enabled).

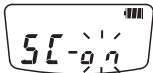

- If you select “5 $\bar{L}$ -o F”, you will no longer be able to perform scan by pressing and holding the  $\wedge$  key {page 18}.

- 4 Press the **MENU** key to exit the selection.
- 5 Press the **PTT**, **MON**, or **CAL** key to exit Setting Mode.

To begin scanning:

1 Press and hold the  $\wedge$  key for 1 second.

- “5C R n” appears on the display.

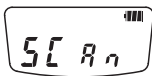

2 When a signal is detected and the QT/ DQT matches, the channel number appears on the display and blinks.

3 When the signal is no longer present, the transceiver waits for 5 seconds before scanning continues.

- If a new signal appears before the 5 seconds elapse, the transceiver will remain on the channel until the new signal is no longer present, at which time it will again wait for 5 seconds before continuing.

4 To end the scan at any time, press and hold the  $\wedge$  key for 1 second.

- The transceiver returns to the channel you were using before you started scanning.

## REVERT CHANNEL

The revert channel is the channel from which you start scanning. So, for example, if you are on channel 1 when you begin to scan, your revert channel is channel 1.

During scan, pressing the **PTT** switch will automatically select the transceiver's revert channel (in the above example, channel 1) and you will begin transmitting. However, if you are currently paused on another channel after having received a signal (for example, channel 2), pressing the **PTT** switch will allow you to transmit on that channel, rather than returning to the revert channel. Scanning will resume after 5 seconds, unless a signal is present on the channel.

---

---

# MONITORING A CHANNEL

---

---

When no signals are present, the squelch on the transceiver automatically mutes the speaker so you will not hear background noise. Using the **MON** key, you can open the squelch to unmute the speaker. This allows you to:

- confirm the channel activity so you don't make a call while another party is using the same channel
- adjust the volume level without having to wait for a call
- listen to an intermittent call (due to a weak signal) without it continuously cutting out



To manually open the squelch, press and hold the **MON** key.

- When squelch is open, the  icon appears on the display and the LED lights green.



To return to normal operation, release the **MON** key.

## SQUELCH LEVEL

You can adjust the default squelch level of the transceiver.

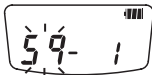
- 1 With the transceiver power OFF, press and hold the **MENU** key while turning the transceiver power ON (for 1 second).
- 2 Press the  or  key to select "59".



- 3 Press the **MENU** key then press  or  to select "59- 0" (open), "59- 1" (default setting), or "59- 2" (tight).

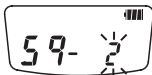

- 4 Press the **MENU** key to exit the selection.
- 5 Press the **PTT**, **MON**, or **CAL** key to exit Setting Mode.

---

---

# VOICE OPERATED TRANSMISSION (VOX)

---

---

Using the VOX feature, you can operate the transceiver hands-free. In order to use this feature, however, you must use an optional headset; VOX will not function with the built-in microphone. For best operation conditions, we recommend you use an optional headset with both an ear piece and a microphone on a boom that rests in front of your mouth.

## VOX OPERATION

- 1 Set up a VOX gain level from 1 to 5 {below}.
- 2 To transmit, speak into the headset microphone.
  - You do not need to press the **PTT** switch; the transceiver automatically detects your voice and begins transmitting. The LED lights red.
- 3 To stop transmitting, stop speaking.
  - Transmission will continue momentarily after you stop speaking. You can select the delay time as described on page 21.
- 4 To exit VOX mode, set the VOX gain level {below} to “ $\text{L} \text{L} \text{-} \text{o} \text{F}$ ” (VOX function off).

## VOX GAIN LEVEL

With VOX activated, your voice level will determine when you transmit. Due to the automatic switching between transmission and reception, we recommend you set the VOX gain level such that it will not activate when in an area with excessive ambient noise.

- 1 With the transceiver power OFF, press and hold the **MENU** key while turning the transceiver power ON (for 1 second).
- 2 Press the  $\wedge$  or  $\vee$  key to select “ $\text{L} \text{L}$ ”.

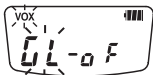

- 3 Press the **MENU** key then press  $\wedge$  or  $\vee$  to select “GL-0F” (VOX function off) or “GL-1” (VOX gain level 1) to “GL-5” (VOX gain level 5).

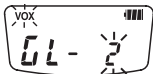

- While adjusting the VOX Gain level, speak into the microphone. When an appropriate level is reached, the LED lights orange.
  - Setting the VOX gain level to OFF deactivates VOX. In order to transmit with VOX turned off, you must use the **PTT** switch.
- 4 Press the **MENU** key to exit the selection.
- 5 Press the **PTT**, **MON**, or **CAL** key to exit Setting Mode.

## VOX DELAY TIME

If the transceiver returns to receive mode too quickly after you stop speaking, the end of your message may not be transmitted. To avoid this, select an appropriate delay time that allows your entire message to be transmitted. However, do not make the delay overly long.

- 1 With the transceiver power OFF, press and hold the **MENU** key while turning the transceiver power ON (for 1 second).
- 2 Press the  $\wedge$  or  $\vee$  key to select “dY”.

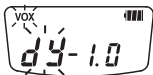

- 3 Press the **MENU** key then press  $\wedge$  or  $\vee$  to select “dY-0.1” (0.1 seconds), “dY-0.3” (0.3 seconds), “dY-0.5” (0.5 seconds), “dY-1.0” (1 second), “dY-1.5” (1.5 seconds), or “dY-3.0” (3 seconds).

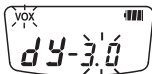

- While adjusting the VOX Delay Time, speak into the microphone to simulate transmitting. The LED lights orange while speaking, but no signal is transmitted at this time.

- 4 Press the **MENU** key to exit the selection.
- 5 Press the **PTT**, **MON**, or **CAL** key to exit Setting Mode.

## TRANSMIT INHIBIT WHILE RECEIVING

While using VOX, you can set the transceiver to detect when the channel is in use (in place of using the Monitor function). With this function turned on, VOX will not allow you to transmit while the channel is being used. You can transmit only when the channel is free. Setting up the proceed tone function {page 23} will notify you when the channel is free.

- 1 With the transceiver power OFF, press and hold the **MENU** key while turning the transceiver power ON (for 1 second).
- 2 Press the  $\wedge$  or  $\vee$  key to select “t i”.

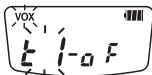

- 3 Press the **MENU** key then press  $\wedge$  or  $\vee$  to select “t i-o n” (transmit inhibit while receiving on) or “t i-o f” (transmit inhibit while receiving off).

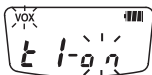

- 4 Press the **MENU** key to exit the selection.
- 5 Press the **PTT**, **MON**, or **CAL** key to exit Setting Mode.

## VOX PROCEED TONE

You can set the transceiver to sound an alert tone when you are able to transmit (transmission is no longer inhibited).

- 1 With the transceiver power OFF, press and hold the **MENU** key while turning the transceiver power ON (for 1 second).
- 2 Press the  $\wedge$  or  $\vee$  key to select “P<sub>d</sub>”.

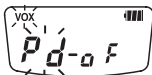

- 3 Press the **MENU** key then press  $\wedge$  or  $\vee$  to select “P<sub>d-o n</sub>” (VOX proceed tone on) or “P<sub>d-o f</sub>” (VOX proceed tone off).

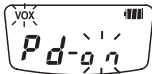

- You can speak into the microphone at this time to simulate transmitting. The LED lights orange while speaking if your voice is at an appropriate level, but no signal is transmitted at this time.
- 4 Press the **MENU** key to exit the selection.
  - 5 Press the **PTT**, **MON**, or **CAL** key to exit Setting Mode.



---

---

# PRIVACY TALK

---

---

Whereas the Quiet Talk and Digital Quiet Talk functions {page 16} allow you to ignore unwanted calls, Privacy Talk allows you to hold a conversation in complete privacy. When activated, the transceiver scrambles your voice so that anybody listening to your conversation will not be able to understand what you are saying.

In order for members of your own group to understand your call while you are using Privacy Talk, all other members must also activate Privacy Talk on their transceivers. This scrambles everybody's voice while transmitting and descrambles the voice message on your own transceiver when you receive the message.

- 1 Press the **MENU** key 2 times.
  - The **PRIVACY** icon appears on the display and blinks.



- 2 Press the  $\wedge$  or  $\vee$  key to select “o n” (privacy on) or “o F” (privacy off).

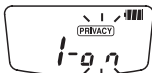

- 3 Press the **MENU** key 3 times, or press the **PTT**, **MON**, or **CAL** key or after mode reset time has elapsed {page 47} to confirm the selection and return to operating mode.

---

---

## FleetSync: ALPHANUMERIC 2-WAY PAGING FUNCTION

---

---

FleetSync is an Alphanumeric 2-way Paging Function, and is a protocol owned by **Kenwood** Corporation. Each transceiver has a unique ID which is used to decode signals from other callers.

### CALL KEY SETUP

You can set up the transceiver **CAL** key to perform 1 of 2 functions, or you can turn the **CAL** key off (unused):

**Call Alert:** Press the **CAL** key before making a call will send your call alert tone to your party members, identifying yourself before speaking.

**Selcall:** Press the **CAL** key then select from a list of IDs to make calls to specific transceivers.

To set up the **CAL** key:

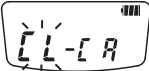
- 1 With the transceiver power OFF, press and hold the **MENU** key while turning the transceiver power ON (for 1 second).
- 2 Press the  $\wedge$  or  $\vee$  key to select “ $\llcorner$ ”.  

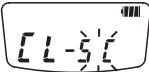
- 3 Press the **MENU** key then press  $\wedge$  or  $\vee$  to select “ $\llcorner$ ” (call alert), “ $\llcorner$ -5” (selcall), or “ $\llcorner$ -0” (off).  

- 4 Press the **MENU** key to exit the selection.
- 5 Press the **PTT**, **MON**, or **CAL** key to exit Setting Mode.

## CALL ALERT TONE

Call alert tones are used to identify yourself to your party members. You can set up a call alert tone to one of 10 types. If each party member uses a different call alert tone, it is easy to know who is making the call. Pressing the **CAL** key before making a call will send your call alert tone to your party members.

To set up your own call alert tone:

- 1 With the transceiver power OFF, press and hold the **MENU** key while turning the transceiver power ON (for 1 second).
- 2 Press the  $\wedge$  or  $\vee$  key to select “[R-”.

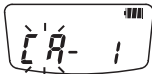

- 3 Press the **MENU** key then press  $\wedge$  or  $\vee$  to select “[R- 1” (call alert tone 1) to “[R- 10” (call alert tone 10).

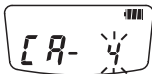

- Each time you press  $\wedge$  or  $\vee$  to select a call alert tone, the new tone sounds.
- 4 Press the **MENU** key to exit the selection.
  - 5 Press the **PTT**, **MON**, or **CAL** key to exit Setting Mode.

## ■ CALL ALERT SIDE TONE

When the **CAL** key is pressed, the call alert tone will sound through your own speaker as well.

To turn the Call Alert Side Tone on or off, on your own transceiver:

- 1 With the transceiver power OFF, press and hold the **MENU** key while turning the transceiver power ON (for 1 second).
- 2 Press the  $\wedge$  or  $\vee$  key to select “[ 5”.

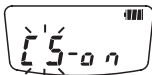

- 3 Press the **MENU** key then press  $\wedge$  or  $\vee$  to select “[ 5-0 7” (Call Alert Side Tone is on) or “[ 5-0 F” (Call Alert Side Tone is off).

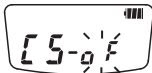

- 4 Press the **MENU** key to exit the selection.
- 5 Press the **PTT**, **MON**, or **CAL** key to exit Setting Mode.

## SELCALL (SELECTIVE CALLING)

A Selcall is a voice call to a particular station or group of stations. Each transceiver is set up with an individual ID number for use with selcalls.

There are several types of Selcalls available: Individual, Group, and Broadcast.

- Individual Calls are calls made to individual parties.
- Group Calls are calls made to all parties within a group.
- Broadcast Calls are calls made to all parties in all groups.

The default status of the transceiver does not allow you to make a Selcall. Use the following procedures to set up your transceiver to allow Selcalls:

### Step 1: Activate the FleetSync Optional Signaling

- 1 With the transceiver power OFF, press and hold the **MENU** key while turning the transceiver ON (for 1 second).
- 2 Press the  $\wedge$  or  $\vee$  key to select “ $\square P$ ” (Optional Signaling).
- 3 Press the **MENU** key then press  $\wedge$  or  $\vee$  to select “ $F 5$ ” (FleetSync).
  - After setting the Optional Signaling to FleetSync, you will no longer be able to receive calls except selcalls.
- 4 Press the **MENU** key to confirm the selection.
- 5 Press the **PTT**, **MON**, or **CAL** key to exit Setting Mode.

### Step 2: Set up the CAL key

- 1 With the transceiver power OFF, press and hold the **MENU** key while turning the transceiver power ON (for 1 second).
- 2 Press the  $\wedge$  or  $\vee$  key to select “ $[\ ]$ ”.

- 3 Press the **MENU** key then press  $\wedge$  or  $\vee$  to select “ $\llcorner$ -5 $\llcorner$ ” (selcall).
- 4 Press the **MENU** key to confirm the selection.
- 5 Press the **PTT**, **MON**, or **CAL** key to exit Setting Mode.

**Step 3:** Set up your own ID (ID List setting mode for Selcall)

- 1 With the transceiver power OFF, press and hold the **CAL** key while turning the transceiver power ON (for 1 second).
  - A beep will sound and the transceiver will enter ID List Setting mode.

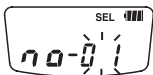

- 2 Press the  $\wedge$  or  $\vee$  key to select a list ID number.

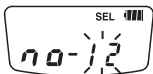

- 3 Press the **MENU** key then press  $\wedge$  or  $\vee$  to select “ $\circ d$ ” (own ID).

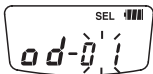

- The default own ID setting is 01.
- When setting up your own ID, make sure that each member within your group sets up a unique ID number for their own ID. If an own ID number is duplicated, that transceiver cannot perform selcalls.
- “ $\imath d$ ” represents an Individual Call ID.  
 “ $\llcorner P$ ” represents a Group Call ID.  
 “ $R L$ ” represents a Broadcast Call ID.  
 “ $\circ d$ ” represents your own ID number.  
 “ - - ” clears the selected ID data.

- 4 Press the **MENU** key to confirm the selection.

- 5 Press the **PTT**, **MON**, or **CAL** key to return to normal operation.
- 6 Set up your group ID number by repeating steps 1 to 5, above. In step 3, select “**LP**” (group ID) instead of “**od**”.
  - Ensure that all of your group members set up the same group ID.
- 7 You can also set up a broadcast ID number (“**RL**”) which is used to make calls to all members of several groups.
  - Ensure that all members of all groups set up the same broadcast ID.

## ■ MAKING A SELCALL

Following are details on how to make individual, group, and broadcast calls. Refer to the diagram below for the examples provided herein.

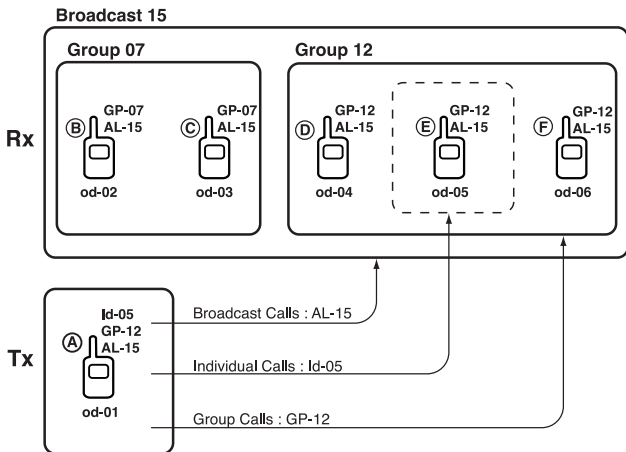

### Note:

- ◆ When QT/DQT is set to the receiving side, the call side QT/DQT settings must be set up the same as the receiving side settings.
- ◆ During Scan the **CAL** key does not operate.

### Individual Calls:

For example, transceiver A is calling transceiver E.

- 1 Press the **CAL** key.
- 2 Press the  $\wedge$  or  $\vee$  key to select an individual ID number (Id-05 in this example).
  - “*Id*” (individual call) represents a single station.
- 3 Press the **PTT** switch to transmit the selected ID.
  - When a call is received, “*Id*” appears on the display, along with the caller’s ID number.

### Group Calls:

For example, transceiver A is calling transceivers D, E, and F.

- 1 Press the **CAL** key.
- 2 Press the  $\wedge$  or  $\vee$  key to select a group ID number (GP-12 in this example).
  - “*GP*” (group call) represents a group of stations.
- 3 Press the **PTT** switch to transmit the selected group ID.
  - When a call is received, “*GP*” appears on the display, along with the caller’s ID number.

### Broadcast Calls:

For example, transceiver A is calling transceivers B ~ F.

- 1 Press the **CAL** key.
- 2 Press the  $\wedge$  or  $\vee$  key to select a broadcast ID number (AL-15 in this example).
  - “*AL*” (broadcast call) represents all stations.
- 3 Press the **PTT** switch to transmit the selected broadcast ID.
  - When a call is received, “*AL*” appears on the display, along with the caller’s ID number.



---

**Note:** If Optional Signaling (menu “OP”) has been set to “FS” (FleetSync), you can also set up an Individual Selcall Alert type (menu “IR”) and Group Selcall Alert type (menu “GR”). Individual and Group Selcall Alert types range from “OF” (off) and “1” (type 1) to “10” (type 10). Refer to the menu list on page 50.

---

## ■ RECEIVING A SELCALL

When a selcall is received, the **SEL** icon and “ID”, “GP” or “RL” appears on the display along with the caller's ID number.

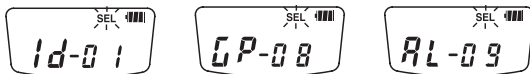

Press the **PTT** switch and speak into the speaker area to respond to the call, then continue the call as normal. When the call is finished, press the **CAL** key to return to operating mode.

## ■ DATA TRANSMIT MODULATION DELAY TIME

This function normally operates fine using the default setting, so it is not necessary to adjust the value. However, there are certain operating environments that will not allow the use of FleetSync (Selcall) functions, such as Scan mode. When you encounter such an environment, readjust the delay time to a longer time by following the procedures.

To set up a data transmit modulation delay time:

- 1 With the transceiver power OFF, press and hold the **MENU** key while turning the transceiver power ON (for 1 second).
- 2 Press the **^** or **v** key to select “dt”.

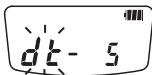

- 3 Press the **MENU** key then press  $\wedge$  or  $\vee$  to select “dt-0” (0 ms), “dt-5” (500 ms), “dt-10” (1000 ms), “dt-15” (1500 ms), or “dt-20” (2000 ms).

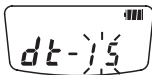

- 4 Press the **MENU** key to exit the selection.
- 5 Press the **PTT**, **MON**, or **CAL** key to exit Setting Mode.

## ■ PTT ID

The transceiver can send a PTT ID signal when pressing the **PTT** switch (beginning of transmission) or when pressing and releasing (beginning of transmission and end of transmission) the **PTT** switch.

- 1 With the transceiver power OFF, press and hold the **MENU** key while turning the transceiver power ON (for 1 second).
- 2 Press the  $\wedge$  or  $\vee$  key to select “Pt”.

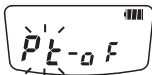

- 3 Press the **MENU** key then press  $\wedge$  or  $\vee$  to select “Pt-0 F” (PTT ID is off), “Pt-b 0” (send your own PTT ID at the beginning of transmission), or “Pt-0 1” to “Pt-3 2” (send selected list ID number PTT ID at the beginning and end of transmission).

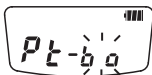

- 4 Press the **MENU** key to exit the selection.
- 5 Press the **PTT**, **MON**, or **CAL** key to exit Setting Mode.

---

**Note:** Transceiver's individual ID number is not available for selection as PTT ID.

---

## ■ PTT ID SIDE TONE

When the **PTT** switch is pressed and/or released, a tone will sound through your own speaker when the PTT ID is transmitted.

To turn the PTT ID Side Tone on or off:

- 1 With the transceiver power OFF, press and hold the **MENU** key while turning the transceiver power ON (for 1 second).
- 2 Press the  $\wedge$  or  $\vee$  key to select "5t".

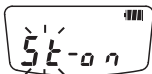

- 3 Press the **MENU** key then press  $\wedge$  or  $\vee$  to select "5t-07" (PTT ID Side Tone is on) or "5t-0F" (PTT ID Side Tone is off).

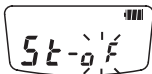

- 4 Press the **MENU** key to exit the selection.
- 5 Press the **PTT**, **MON**, or **CAL** key to exit Setting Mode.

## ■ MUTE HOLD TIME

Mute Hold Time keeps the speaker muted for a brief moment, after a signal has been received. This prevents interference with the PTT ID signal.

To set the hold time:

- 1 With the transceiver power OFF, press and hold the **MENU** key while turning the transceiver power ON (for 1 second).
- 2 Press the  $\wedge$  or  $\vee$  key to select “Hd”.

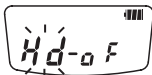

- 3 Press the **MENU** key then press  $\wedge$  or  $\vee$  to select “Hd-0F” (hold time is off), “Hd-5” (500 ms), “Hd-10” (1000 ms), “Hd-15” (1500 ms), “Hd-20” (2000 ms), or “Hd-25” (2500 ms).

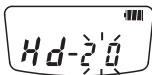

- 4 Press the **MENU** key to exit the selection.
- 5 Press the **PTT**, **MON**, or **CAL** key to exit Setting Mode.

## ■ CALLER ID DISPLAY

When the transceiver receives a PTT ID signal, the caller ID of that signal appears on the display, along with the **CID** icon, so you know who is making the call.

To turn Caller ID Display on or off:

- 1 With the transceiver power OFF, press and hold the **MENU** key while turning the transceiver power ON (for 1 second).
- 2 Press the  $\wedge$  or  $\vee$  key to select “ $\llcorner$  I”.

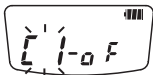

- 3 Press the **MENU** key then press  $\wedge$  or  $\vee$  to select “ $\llcorner$  I-ON” (Caller ID Display is on) or “ $\llcorner$  I-OFF” (Caller ID Display is off).

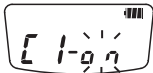

- 4 Press the **MENU** key to exit the selection.
- 5 Press the **PTT**, **MON**, or **CAL** key to exit Setting Mode.

---

---

# OPERATING FEATURES

---

---

## TRANSMIT POWER

You can adjust the transmit power on all channels. Selecting low power will allow longer use of the battery pack. Selecting high power will allow you to transmit further, in case the other party is too far away for low power usage.

To change the transmit power:

- 1 Press the **MENU** key 3 times.



- 2 Press the  $\wedge$  or  $\vee$  key to select “L” (low power) or “H” (high power).

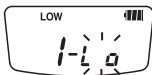

- The **LOW** icon appears on the display when low power is selected.
- 3 Press the **MENU** key 2 times, or press the **PTT**, **MON**, or **CAL** key or after mode reset time has elapsed {page 47} to confirm the selection and return to operating mode.

## COMPANDER

The compander (compressor/expander) allows higher clarity of signals, avoiding excessive noise and interference. When activated, transmitted signals are compressed before being sent and received signals are expanded when they arrive.

- 1 Press the **MENU** key 4 times.

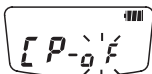

- 2 Press the  $\wedge$  or  $\vee$  key to select “COMP” (compander off) or “COMP” (compander on).

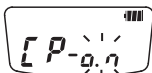

- 3 Press the **MENU** key 1 time, or press the **PTT**, **MON**, or **CAL** key or after mode reset time has elapsed {page 47} to confirm the selection and return to operating mode.

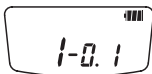

## KEY LOCK

You can lock the **MENU**,  $\wedge$ , and  $\vee$  keys to prevent accidentally changing the operating mode and channel settings. The **Power** switch/ **Volume** control and **PTT**, **CAL**\*, and **MON** still function normally.

\* The **CAL** key functions normally only if it has been set up as Call Alert {page 25}.

Press and hold the **MENU** key for 3 seconds to lock or unlock the transceiver keys.

- The  icon appears on the display when the transceiver keys are locked. No icon appears when they are unlocked.



## SUPER LOCK





You can lock the **MENU**, **CAL\***, , and/or  keys, and disable the Setting Mode. **PTT** and **MON** still function normally.

- \* The **CAL** key will not be locked only if it has been set up as Selcall {page 25}.

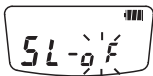
To select the super lock setting:

- 1 With the transceiver power OFF, press and hold the **PTT** switch and the **CAL** key while turning the transceiver power ON (for 1 second).



- 2 Press the  or  key to select "SL- P" (**MENU**, **CAL**, , and  keys locked), "SL- L" (**MENU** and **CAL** keys locked), or "SL-0 F" (super lock off).

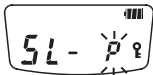

- 3 Press the **MENU**, **PTT**, **MON**, or **CAL** key to exit Super Lock Setting Mode.

- The  icon appears on the display when the transceiver keys are locked. No icon appears when they are unlocked.



## DISPLAY BACKLIGHT

You can set the display backlight to remain off, remain on, or turn on when you press any key other than the **PTT** switch (auto). When set to auto, the backlight remains on for 5 seconds after pressing a key, before turning off again.

To select the backlight setting:

- 1 With the transceiver power OFF, press and hold the **MENU** (for approximately 1 second) key while turning the transceiver power ON.
- 2 Press the  $\wedge$  or  $\vee$  key to select “ $L E$ ”.

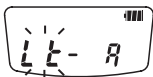

- 3 Press the **MENU** key then press  $\wedge$  or  $\vee$  to select “ $L E - o f$ ” (backlight off), “ $L E - o n$ ” (backlight on), or “ $L E - A$ ” (backlight auto).

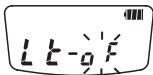

- 4 Press the **MENU** key to exit the selection.
- 5 Press the **PTT**, **MON**, or **CAL** key to exit Setting Mode.

## MIC SENSE

You can adjust the sensitivity level of the transceiver microphone.

To select the mic sense:

- 1 With the transceiver power OFF, press and hold the **MENU** key while turning the transceiver power ON (for 1 second).
- 2 Press the  $\wedge$  or  $\vee$  key to select “SE”.

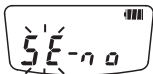

- 3 Press the **MENU** key then press  $\wedge$  or  $\vee$  to select “SE-n 0” (normal) or “SE-H i” (high).

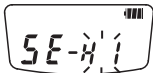

- 4 Press the **MENU** key to exit the selection.
- 5 Press the **PTT**, **MON**, or **CAL** key to exit Setting Mode.

## TIME-OUT TIMER

The Time-out Timer prevents you from using a channel for an extended duration. This function is useful, for example, when you accidentally keep the **PTT** switch pressed. Additionally, by limiting the amount of time you can continuously transmit, this feature helps you save on battery power consumption.

If you continuously transmit for 3 minutes (default value), the transceiver will stop transmitting and a tone will sound. To stop the tone, release the **PTT** switch. You can press the **PTT** switch again to resume transmitting.

To change the default value of 3 minutes:

- 1 With the transceiver power OFF, press and hold the **MENU**

key while turning the transceiver power ON (for 1 second).

- 2 Press the  $\wedge$  or  $\vee$  key to select “t o”.

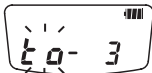

- 3 Press the **MENU** key then press  $\wedge$  or  $\vee$  to select “t o- 3” (3 minutes) or “t o- 10” (10 minutes).

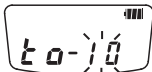

- 4 Press the **MENU** key to exit the selection.
- 5 Press the **PTT**, **MON**, or **CAL** key to exit Setting Mode.

This transceiver is also equipped with a pre-alert tone which sounds 10 seconds before the Time-out Timer expires. This will allow you time to finish your message before the transceiver automatically stops transmitting.

## BATTERY SAVER

This transceiver has been designed to give you the most out of your battery power. The battery saver function decreases the amount of power used when a signal is not being received and no operations are being performed.

While using the transceiver, battery saver will automatically switch ON after 5 seconds have elapsed with no operations or received calls. Operating the transceiver or receiving a call will switch this feature OFF until 5 seconds of non-operation occurs again.

To turn this function on or off:

- 1 With the transceiver power OFF, press and hold the **MENU** key while turning the transceiver power ON (for 1 second).
- 2 Press the  $\wedge$  or  $\vee$  key to select “b 5”.

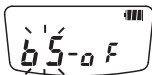

- 3 Press the **MENU** key then press  $\wedge$  or  $\vee$  to select “b5-o n” (battery saver on) or “b5-o F” (battery saver off).

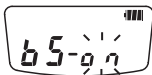

- 4 Press the **MENU** key to exit the selection.
- 5 Press the **PTT**, **MON**, or **CAL** key to exit Setting Mode.

---





**Note:** While the Battery Saver is operating, the LED may flash green when receiving a QT/DQT signal which does not match the QT/DQT tone/code set up in your transceiver.

---

## BATTERY LEVEL INDICATOR

When turned ON, the battery level indicator on the display lets you know approximately how much battery life is remaining. When turned OFF, the battery level indicator will appear and blink only when the battery voltage level is low.

When the battery voltage becomes too low while transmitting, the transceiver stops transmitting, a tone sounds, and the LED blinks red until you release the **PTT** switch. Recharge or replace the battery pack at this time.

-  High battery power
-  Medium battery power
-  Low battery power
-  Recharge the battery pack

To turn this function on or off:

- 1 With the transceiver power OFF, press and hold the **MENU**

key while turning the transceiver power ON (for 1 second).

- 2 Press the  $\wedge$  or  $\vee$  key to select “bt”.

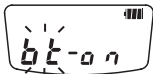

- 3 Press the **MENU** key then press  $\wedge$  or  $\vee$  to select “bt-on” (battery level indicator on) or “bt-off” (battery level indicator off).

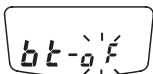

- 4 Press the **MENU** key to exit the selection.
- 5 Press the **PTT**, **MON**, or **CAL** key to exit Setting Mode.

## INCOMING CALL NOTIFICATION

**Note:** To use Incoming Call Notification, you must set up a QT tone or a DQT code (page 16).

Incoming Call Notification is used to inform you of when a call is being received. When activated, a tone is emitted when a busy signal is received and the QT/ DQT signaling matches.

- The tone will sound for 15 seconds before turning off.
- While the tone sounds, you will not hear any audio from the speaker. Press any key to turn the tone off and listen to the received call.

After the call is finished, the transceiver will wait for 10 seconds before resetting. If you receive a new call within those 10 seconds, the tone will not sound. If no call is received within 10 seconds, Incoming Call Notification will reset so that the next time a call is received, the tone will sound again.

To turn Incoming Call Notification on or off:

- 1 With the transceiver power OFF, press and hold the **MENU** key while turning the transceiver power ON (for 1 second).
- 2 Press the  $\wedge$  or  $\vee$  key to select “[t-”.

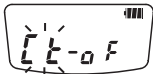

- 3 Press the **MENU** key then press  $\wedge$  or  $\vee$  to select “[t-” (incoming call notification off), or “[t-” (incoming call notification on).

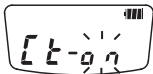

- 4 Press the **MENU** key to exit the selection.
- 5 Press the **PTT**, **MON**, or **CAL** key to exit Setting Mode.

## BUSY CHANNEL LOCKOUT (BCL)

This function is used in order to prevent transmitting on a channel that somebody else is currently using. When turned ON, a beep sounds when you press the **PTT** switch while another party is using the channel, and you cannot transmit.

To turn BCL on or off:

- 1 With the transceiver power OFF, press and hold the **MENU** key while turning the transceiver power ON (for 1 second).
- 2 Press the  $\wedge$  or  $\vee$  key to select “bL”.

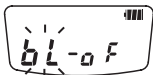

- 3 Press the **MENU** key then press  $\wedge$  or  $\vee$  to select “bL-o n” (BCL on) or “bL-o F” (BCL off).

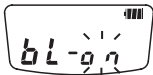

- 4 Press the **MENU** key to exit the selection.
- 5 Press the **PTT**, **MON**, or **CAL** key to exit Setting Mode.

## BEEP TONE

When you turn the transceiver power ON or press a key, a beep will emit from the transceiver.

To turn the beep tone on or off:

- 1 With the transceiver power OFF, press and hold the **MENU** key while turning the transceiver power ON (for 1 second).
- 2 Press the  $\wedge$  or  $\vee$  key to select “bP”.

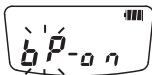

- 3 Press the **MENU** key then press  $\wedge$  or  $\vee$  to select “bP-o n” (beep tone on) or “bP-o f” (beep tone off).

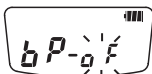

- 4 Press the **MENU** key to exit the selection.
- 5 Press the **PTT**, **MON**, or **CAL** key to exit Setting Mode.

## MODE RESET TIMER

This function returns the transceiver to the channel display after a preset timer expires while in Menu mode or ID List mode.

To set the mode reset timer:

- 1 With the transceiver power OFF, press and hold the **MENU** key while turning the transceiver power ON (for 1 second).
- 2 Press the  $\wedge$  or  $\vee$  key to select “r t”.

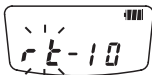

- 3 Press the **MENU** key then press  $\wedge$  or  $\vee$  to select “r t-o f” (timer off), “r t-10” (10 seconds), “r t-30” (30 seconds).

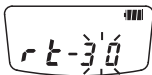

- 4 Press the **MENU** key to exit the selection.
- 5 Press the **PTT**, **MON**, or **CAL** key to exit Setting Mode.



---

---

## RESETTING THE TRANSCEIVER

---

---

At some point in time, you may desire to reset the transceiver settings to their default values. (Default values are listed on pages 50 ~ 51.)

To reset the transceiver:

- 1 With the transceiver power OFF, press and hold the  $\wedge$ ,  $\vee$ , and **MON** keys while turning the transceiver power ON.
  - “r E 5 t” (reset) will appear on the display.

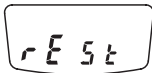

- 2 Release the  $\wedge$ ,  $\vee$ , and **MON** keys.
  - The confirmation message “5 U r E” (sure) will appear on the display.

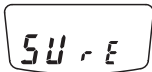

- 3 Press the **PTT** switch to reset the transceiver.
  - Press any other key to cancel the reset.

---

**Note:** Reset will function even if Super Lock has been activated.

---

---

---

# OPTIONAL ACCESSORIES

---

---

KNB-46L (Li-ion battery pack)



KSC-37 (Rapid charger)

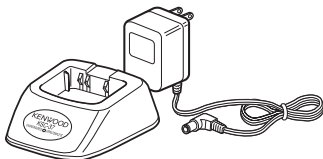

KMC-17 (Speaker-microphone)

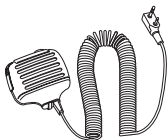

KMC-21 (Speaker-microphone)



EMC-3 (Clip mic with earphone)

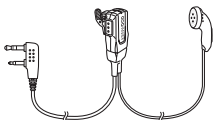

KBH-14 (Belt clip)

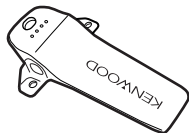

KHS-22 (Headset)

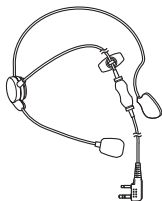

# MENUS

Display	Name	Settings	Default	Ref. Pg
<i>1</i>	Channel 1 Frequency Setting	01 ~ 56	02	15
<i>2</i>	Channel 2 Frequency Setting	01 ~ 56	08	15
<i>oP</i>	Optional Signaling	OFF/ FS (FleetSync)	OFF	28
<i>IR<sup>1</sup></i>	Individual Selcall Alert	OFF/ 1 ~ 10	9	32
<i>LR<sup>1</sup></i>	Group Selcall Alert	OFF/ 1 ~ 10	10	32
<i>LR<sup>2</sup></i>	Incoming Call Notification	OFF/ ON (Tone)	OFF	45
<i>LR</i>	Call Key	CA (Call Alert)/ SC (Selcall)/ OFF	CA	25
<i>LR<sup>3</sup></i>	Call Alert Tone	Type 1 ~ 10	1	26
<i>LR<sup>5</sup></i>	Call Alert Side Tone	OFF/ ON	ON	27
<i>PT</i>	PTT ID	OFF/ bo (BOT)/ 01-32 (List 1-32)	OFF	33
<i>ST</i>	PTT ID Side Tone	OFF/ ON	ON	34
<i>dt</i>	Data Transmit Modulation Delay Time	0/ 5 (500)/ 10 (1000)/ 15 (1500)/ 20 (2000 ms)	500 ms	32

Display	Name	Settings	Default	Ref. Pg
<i>Hd</i>	Mute Hold Time	OFF/ 5 (500)/ 10 (1000)/ 15 (1500)/ 20 (2000)/ 25 (2500 ms)	OFF	35
<i>LI</i>	Caller ID Display	OFF/ ON	OFF	36
<i>rt</i>	Mode Reset Timer	OFF/ 10/ 30 sec	10 sec	47
<i>to</i>	Time-out Timer	3/ 10 min	3 min	41
<i>bL</i>	Busy Channel Lockout	OFF/ ON	OFF	46
<i>lt</i>	Backlight	OFF/ ON/ A (Auto)	Auto	40
<i>bt</i>	Battery Level Indicator	OFF/ ON	ON	43
<i>bS</i>	Battery Saver	OFF/ ON	OFF	42
<i>bP</i>	Beep Tone	OFF/ ON	ON	46
<i>SL</i>	Scan Function	OFF/ ON	OFF	17
<i>SQ</i>	Squelch Level	0 ~ 2	1	19
<i>SE</i>	Mic Sense	no (Normal)/ HI (high)	Normal	41
<i>GL</i>	VOX Gain Level	OFF/ 1 ~ 5	OFF	20
<i>dY<sup>4</sup></i>	VOX Delay Time	0.1/ 0.3/ 0.5/ 1.0/ 1.5/ 3.0 sec	1.0 sec	21
<i>ti<sup>4</sup></i>	Transmit Inhibit while Receiving	OFF/ ON	OFF	22
<i>Pd<sup>4</sup></i>	VOX Proceed Tone	OFF/ ON	OFF	23

<sup>1</sup> Menus *IR* and *LR* are not available if the *oP* menu is set to OFF.

<sup>2</sup> Menu *LI* is not available if the *oP* menu is set to FleetSync.

<sup>3</sup> Menu *LR* is not available if the *LI* menu is set to OFF or Selcall.

<sup>4</sup> Menus *dY*, *ti*, and *Pd* are not available if the *GL* menu is set to OFF.

---

---

## QT TONES/ DQT CODES

---

---

Display	QT Freq.	Display	QT Freq.	Display	QT Freq.
01	67.0 Hz	14	107.2 Hz	27	167.9 Hz
02	71.9 Hz	15	110.9 Hz	28	173.8 Hz
03	74.4 Hz	16	114.8 Hz	29	179.9 Hz
04	77.0 Hz	17	118.8 Hz	30	186.2 Hz
05	79.7 Hz	18	123.0 Hz	31	192.8 Hz
06	82.5 Hz	19	127.3 Hz	32	203.5 Hz
07	85.4 Hz	20	131.8 Hz	33	210.7 Hz
08	88.5 Hz	21	136.5 Hz	34	218.1 Hz
09	91.5 Hz	22	141.3 Hz	35	225.7 Hz
10	94.8 Hz	23	146.2 Hz	36	233.6 Hz
11	97.4 Hz	24	151.4 Hz	37	241.8 Hz
12	100.0 Hz	25	156.7 Hz	38	250.3 Hz
13	103.5 Hz	26	162.2 Hz	39	69.3 Hz

Display	DQT Code	Display	DQT Code	Display	DQT Code
DQT 01	023N	DQT 29	174N	DQT 57	445N
DQT 02	025N	DQT 30	205N	DQT 58	464N
DQT 03	026N	DQT 31	223N	DQT 59	465N
DQT 04	031N	DQT 32	226N	DQT 60	466N
DQT 05	032N	DQT 33	243N	DQT 61	503N
DQT 06	043N	DQT 34	244N	DQT 62	506N
DQT 07	047N	DQT 35	245N	DQT 63	516N
DQT 08	051N	DQT 36	251N	DQT 64	532N
DQT 09	054N	DQT 37	261N	DQT 65	546N
DQT 10	065N	DQT 38	263N	DQT 66	565N
DQT 11	071N	DQT 39	265N	DQT 67	606N
DQT 12	072N	DQT 40	271N	DQT 68	612N
DQT 13	073N	DQT 41	306N	DQT 69	624N
DQT 14	074N	DQT 42	311N	DQT 70	627N
DQT 15	114N	DQT 43	315N	DQT 71	631N
DQT 16	115N	DQT 44	331N	DQT 72	632N
DQT 17	116N	DQT 45	343N	DQT 73	654N
DQT 18	125N	DQT 46	346N	DQT 74	662N
DQT 19	131N	DQT 47	351N	DQT 75	664N
DQT 20	132N	DQT 48	364N	DQT 76	703N
DQT 21	134N	DQT 49	365N	DQT 77	712N
DQT 22	143N	DQT 50	371N	DQT 78	723N
DQT 23	152N	DQT 51	411N	DQT 79	731N
DQT 24	155N	DQT 52	412N	DQT 80	732N
DQT 25	156N	DQT 53	413N	DQT 81	734N
DQT 26	162N	DQT 54	423N	DQT 82	743N
DQT 27	165N	DQT 55	431N	DQT 83	754N
DQT 28	172N	DQT 56	432N	oF	OFF

---

---

## CHANNEL FREQUENCIES

---

---

Setup Number	Frequency (MHz)	Setup Number	Frequency (MHz)	Setup Number	Frequency (MHz)
01	464.5000	20	461.3125	39	466.1625
02 (CH 1)	464.5500	21	461.3375	40	466.1875
03	467.7625	22	461.3625	41	466.2125
04	467.8125	23	462.7625	42	466.2375
05	467.8500	24	462.7875	43	466.2625
06	467.8750	25	462.8125	44	466.2875
07	467.9000	26	462.8375	45	466.3125
08 (CH 2)	467.9250	27	462.8625	46	466.3375
09	461.0375	28	462.8875	47	466.3625
10	461.0625	29	462.9125	48	467.7875
11	461.0875	30	464.4875	49	467.8375
12	461.1125	31	464.5125	50	467.8625
13	461.1375	32	464.5375	51	467.8875
14	461.1625	33	464.5625	52	467.9125
15	461.1875	34	466.0375	53	469.4875
16	461.2125	35	466.0625	54	469.5125
17	461.2375	36	466.0875	55	469.5375
18	461.2625	37	466.1125	56	469.5625
19	461.2875	38	466.1375		

---

**Note:** The marked CH numbers are the default channel settings.

---

---

---

## SPECIFICATIONS

---

---

RF output power	Low	500 mW
	High	1.5 W
Audio output power		100 mW
Frequency stability		$\pm 2.5$ ppm
Operating voltage		3.7 V
Dimensions (projections not included)		52 x 28.7 x 103.5 mm (2.05 x 1.13 x 4.07 inches)
Weight (with KNB-46L)		155 g (5.5 oz)



---

---

# TROUBLESHOOTING GUIDE

---

---

Problem	Solution
Cannot turn the transceiver power ON.	<ul style="list-style-type: none"><li>• The battery pack may be dead. Recharge or replace the battery pack.</li><li>• The battery pack may not be installed correctly. Remove the battery pack and install it again.</li></ul>
Battery power dies shortly after charging.	<ul style="list-style-type: none"><li>• The battery pack life is finished. Replace the battery pack with a new one.</li></ul>
Cannot talk to or hear other members in your group.	<ul style="list-style-type: none"><li>• Make sure you are using the same frequency and QT/DQT setting as the other group members.</li><li>• Other group members may be using Privacy Talk. Turn on your transceiver's Privacy Talk.</li><li>• Other group members may be too far away. Make sure you are within range of the other transceivers.</li></ul>
Other voices (besides group members) are present on the channel.	<ul style="list-style-type: none"><li>• Change the QT/DQT settings. Make sure all group members change the settings on their transceivers to match the new QT/DQT setting.</li></ul>

Problem	Solution
You cannot make a selcall.	<ul style="list-style-type: none"> <li>• Verify and set your transceiver ID (Own, Group, All).</li> </ul>
<p>You cannot receive calls except selcalls.</p> <p>You cannot transmit even by pressing the PTT switch.</p>	<ul style="list-style-type: none"> <li>• Optional Signaling is set to "FS (FleetSync)". Change the setting to "oF (OFF)".</li> </ul>
The transceiver is malfunctioning for no apparent reason.	<ul style="list-style-type: none"> <li>• Reset the transceiver as described on page 48</li> </ul>

## Free Manuals Download Website

<http://myh66.com>

<http://usermanuals.us>

<http://www.somanuals.com>

<http://www.4manuals.cc>

<http://www.manual-lib.com>

<http://www.404manual.com>

<http://www.luxmanual.com>

<http://aubethermostatmanual.com>

Golf course search by state

<http://golfingnear.com>

Email search by domain

<http://emailbydomain.com>

Auto manuals search

<http://auto.somanuals.com>

TV manuals search

<http://tv.somanuals.com>