

KENWOOD

UD COMPONENT SYSTEM/COMPACT HI-FI SYSTEM

UD-553

INSTRUCTION MANUAL

KENWOOD CORPORATION

For your records

Record the serial number, found on the back of the unit, in the spaces designated on the warranty card, and in the space provided below. Refer to the model and serial numbers whenever you call upon your dealer for information or service on the product.





Model _____ Serial Number _____

Unpacking

Unpack the unit carefully and make sure that all accessories are put aside so they will not be lost. Examine the unit for any possibility of shipping damage. If your unit is damaged or fails to operate, notify your dealer immediately. If your unit was shipped to you directly, notify the shipping company without delay. Only the consignee (the person or company receiving the unit) can file a claim against the carrier for shipping damage.

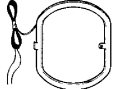
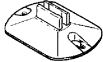
We recommend that you retain the original carton and packing materials for use should you transport or ship the unit in the future.

Accessories

FM indoor antenna (1) 	AM loop antenna(1) 	Loop antenna stand ..(1) 
Speaker cord(2) 	Remote control unit ..(1) 	Batteries (R6/AA)(2) 
Parallel cord(1) 		

COMPACT
disc
DIGITAL AUDIO

NOTE
Do not transport the system with a CD left in it.

B60-2059-00 (SI) (K, P, R) (MC)

Before applying power

⚠ Caution : Read this page carefully to ensure safe operation.





UD-553 (En)

Units are designed for operation as follows.

2	U.S.A. and Canada	AC 120 V only	Europe and U.K.	AC 230 V only
	Australia	AC 240 V only	Other countries	AC 110-120 / 220 / 230-240 V switchable

Safety precautions

WARNING : TO PREVENT FIRE OR ELECTRIC SHOCK, DO NOT EXPOSE THIS APPLIANCE TO RAIN OR MOISTURE.

	<p>CAUTION RISK OF ELECTRIC SHOCK DO NOT OPEN</p>		<p>CAUTION: TO REDUCE THE RISK OF ELECTRIC SHOCK, DO NOT REMOVE COVER (OR BACK). NO USER-SERVICEABLE PARTS INSIDE, REFER SERVICING TO QUALIFIED SERVICE PERSONNEL.</p>
	<p>THE LIGHTNING FLASH WITH ARROWHEAD SYMBOL, WITHIN AN EQUILATERAL TRIANGLE, IS INTENDED TO ALERT THE USER TO THE PRESENCE OF UNINSULATED "DANGEROUS VOLTAGE" WITHIN THE PRODUCT'S ENCLOSURE THAT MAY BE OF SUFFICIENT MAGNITUDE TO CONSTITUTE A RISK OF ELECTRIC SHOCK TO PERSONS.</p>		
	<p>THE EXCLAMATION POINT WITHIN AN EQUILATERAL TRIANGLE IS INTENDED TO ALERT THE USER TO THE PRESENCE OF IMPORTANT OPERATING AND MAINTENANCE (SERVICING) INSTRUCTIONS IN THE LITERATURE ACCOMPANYING THE APPLIANCE.</p>		

The marking of products using lasers (Except for some areas)

**CLASS 1
LASER PRODUCT**

The label is attached to the rear panel and says that the component uses laser beams that have been classified as Class 1. It means that the unit is utilizing laser beams that are of a weaker class. There is no danger of hazardous radiation outside the unit.



L.L.C. (Low Level Control) - 16

When you want to listen at a low volume, for example in the night time, the sound level can be reduced with a one-touch operation. While the level is low, the insufficiency in the bass and treble levels felt by human hearing are automatically compensated. The volume can be varied freely even while the listening at a low level.



SOURCE DIRECT - 17

The reproduced sound can be enjoyed with absolute purity as unnecessary circuitry is by-passed.



Dynamic rotary volume control - 17

When adjusting the volume, the amount of volume variation is variable according to the speed of rotating the VOLUME CONTROL. Rotating the control slowly decreases the variable effect so a finer adjustment is possible.



Convenient DPSS - 20

The DPSS (Direct Program Search System) allows you to play a cassette tape with a variety of playback functions similar to CD.

- Playing tunes by skipping some.
- Playing a single tune repeatedly.
- Rewinding a tape and playing from the beginning.
- Playing a tape by skipping blanks between tunes.



Simplified CD recording - 30

Various CD editing & recording features are available for selection according to the tape you want.

- **Fade edit recording:** Recording CD tracks sequentially from No. 1.
- **Program edit recording:** Recording desired CD tracks in desired order.
- **Timed edit recording:** Recording CD tracks within the specified tape length so that no track is interrupted in the middle.
- **AI edit recording:** Recording all CD tracks even in case the total playing time exceeds the total recording time of tape.
- **X.FADE (Cross-fade) edit recording:** Recording by overlapping the beginnings and endings of the CD tracks.



Versatile tone and sound field adjustment - 45

The tone can be selected according to the genre of the music played: POP, ROCK, JAZZ, CLASSIC.

The sound field can also be selected as desired: ARENA, JAZZ CLUB, STADIUM, HIT MASTER.



Convenient timer functions - 48

In addition to the possibility of storing up to 2 timer programs in memory, the following functions are available.

- **AI timer:** When the power is turned ON by the timer, the sound level increases gradually.
- **Sleep timer:** Useful when you want to go asleep while listening to music.

System connections	4
Controls and indicators	9
Operation of remote control unit	14
Clock adjustment	15
Sound adjustment functions	16
CD playback	18
Loading a disc	18
Playing tracks in order from track No.1	19
Playback from desired track	20
Programming tracks in desired order	21
Repeated playback	23
Playback in a random order (Random playback)	25
Playback of tape	26
Tape playback	26
Relay playback	27
Skip search	28
Dash & play, One-program repeat playback, Rewind playback	29
Broadcast reception	30
Receiving a broadcast station	30
Storing radio stations in memory (Station preset)	31
Receiving a preset station	31
Recording (Deck B only)	32
Preparation for recording	32
Recording (Deck B only)	33
Copying tape (Tape dubbing)	35
CD edit recording	36
Select the type of edit recording	36
Program edit recording	38
Cross-fade edit recording	39
Timed edit recording	40
AI edit recording	41
Fade edit recording	42
Tone adjustment	44
Demonstration	44
Playing music with the desired tone	45
Enjoying music with the presence effect (presence modes)	45
Easy Karaoke singing (HIT MASTER)	46
Timer operation	48
Timer programming	48
Sleep timer	51
Maintenance	52
In case of difficulty	54
Specifications	57

System connections

UD-553 (En)

Do not plug the power cord into the power outlet until all of the required connections have been made.

- When arranging the system units in a vertical, stacked configuration, observe the stacking order indicated in the system connection diagram below.
- In the case of an associated system component being connected, also read the instruction manual of the component.
- Align the front panels of the unit flush.

Malfunction of microcomputer



If operation is not possible or erroneous display appears even though all connections have been made properly, reset the microcomputer referring to "In case of difficulty".

→ [54]

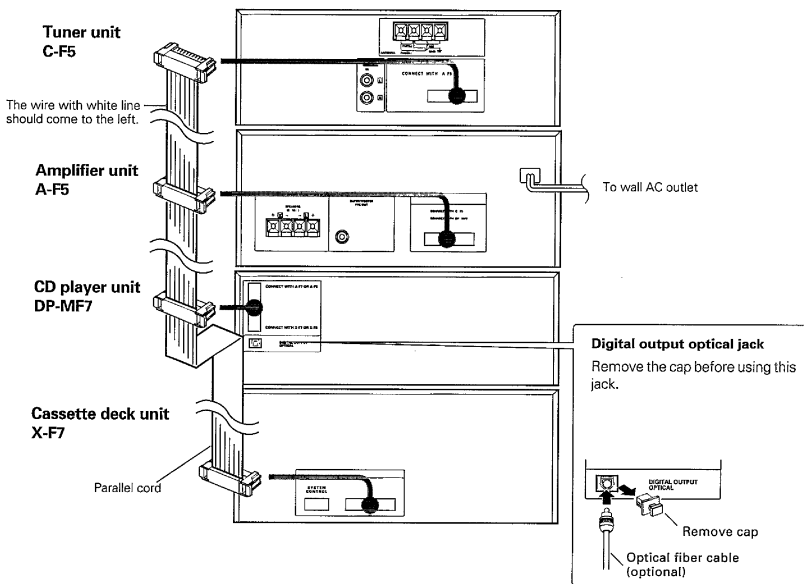
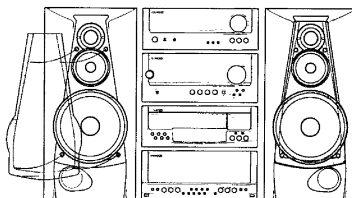

Optical fiber cable connection

The digital OPTICAL output is designed for use in the connection with an MD recorder (optionally available). The digital signal transmission allows you to record the CD sound on MD without spoiling the high sound quality. This jack can also be connected to an amplifier equipped with a digital optical input (optical fiber).

- When using an optical fiber cable to connect this unit to a MD recorder or digital amplifier, insert the plug straight into the jack until a click sound is heard.
- Be careful not to bend, coil or bundle the optical fiber cable.
- Optical fiber cables available in audio accessory stores may not always be able to be used with this unit. If your cable cannot be used with this unit, consult the store from which you purchased the cable or your nearest dealer.

Notes



1. Be sure to insert all connection cords securely. If their connections are imperfect, the sound may not produced or noise may interfere.
2. Before plugging or unplugging a connection cord, be sure to unplug the power cord from the wall AC outlet. If connection cords are plugged or unplugged with the power cord left plugged in, malfunction or damage may result.
3. Do not connect up a power source which is larger than that indicated on the socket at rear of the unit.

Connection of the front speakers

UD-553 (En)

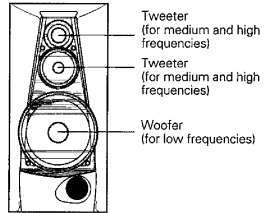

LS-F5

Speaker rear panels

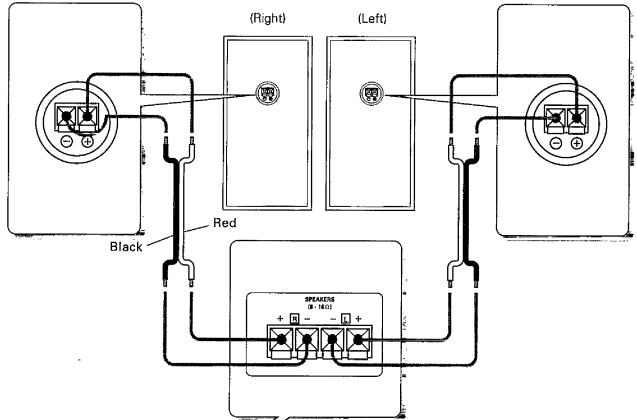
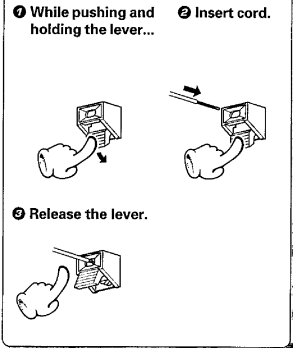

Amplifier rear panel

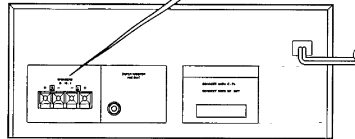
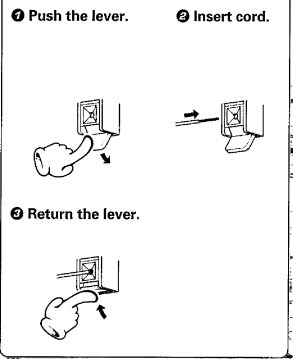

Amplifier unit A-F5

- Never short-circuit the + and - speaker cords.
- If the left and right speaker connections or the + and - polarity are inverted, the sound will be unnatural with unclear positioning of musical instruments, etc. Be sure to connect them without mistake.

Connection of parallel cord

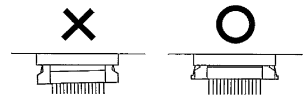
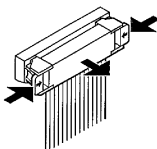

- When connecting the parallel cord, insert the plug straight into the connector until it clicks to lock them securely.
- When connecting the parallel cord, the wire with white line should come to the left side end.
- When disconnecting the parallel cord, push in the two sides of the plug and pull it straight out.

Connection method

6

- ① Push the lever.
- ② Insert cord.
- ③ Return the lever.

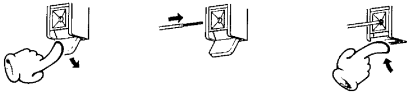

Tuner unit C-F5

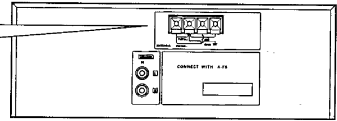

Connection of AM antenna

Connection of AM loop antenna

The provided antenna is for indoor use. Place it in a position as far as possible from this system, TV, speaker cords and power cord and set to the orientation which provides the best reception condition.

Connection of AM outdoor antenna

If the reception condition is poor with the loop antenna alone, connect a vinyl coated wire of more than 6 m (20 ft) and extend it outdoors while leaving the loop antenna connected.

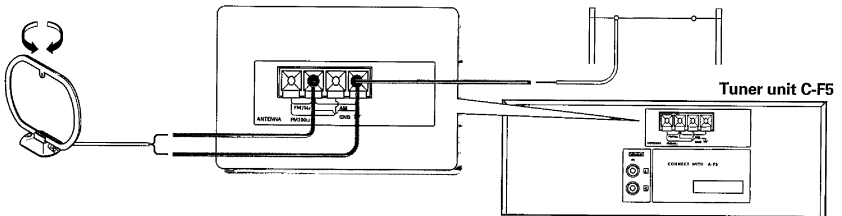

Connection of FM antenna

Connection of FM simplified antenna

The accessory antenna is for temporary indoor use only. For stable signal reception we recommend using an outdoor antenna. Remove the indoor antenna if you connect one outdoors.

Connection of FM outdoor antenna

Lead the antenna wire indoors using a 75 Ω coaxial cable and connect it to the FM 75 Ω connector.

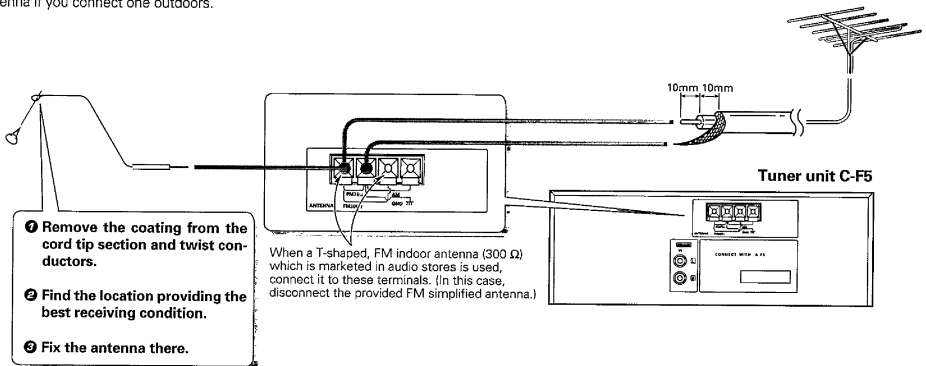

Connection of optional speakers

UD-553 (En)

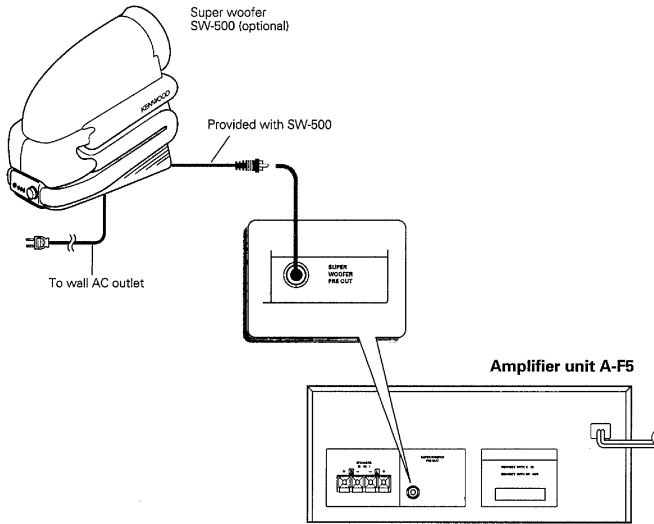

Connection of Audio / Visual components (optional)

UD-553 (En)

- Connection cords are not supplied with this system.
- Any of the following components can be connected in place of the MD recorder.
 - DBS tuner
 - Video camera
 - Video recorder
 - DAT recorder

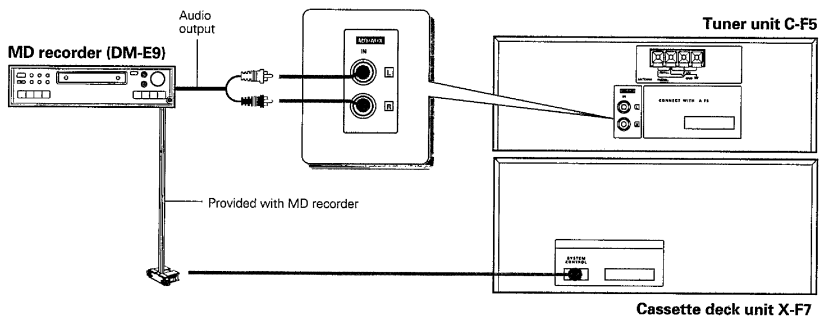

Amplifier unit

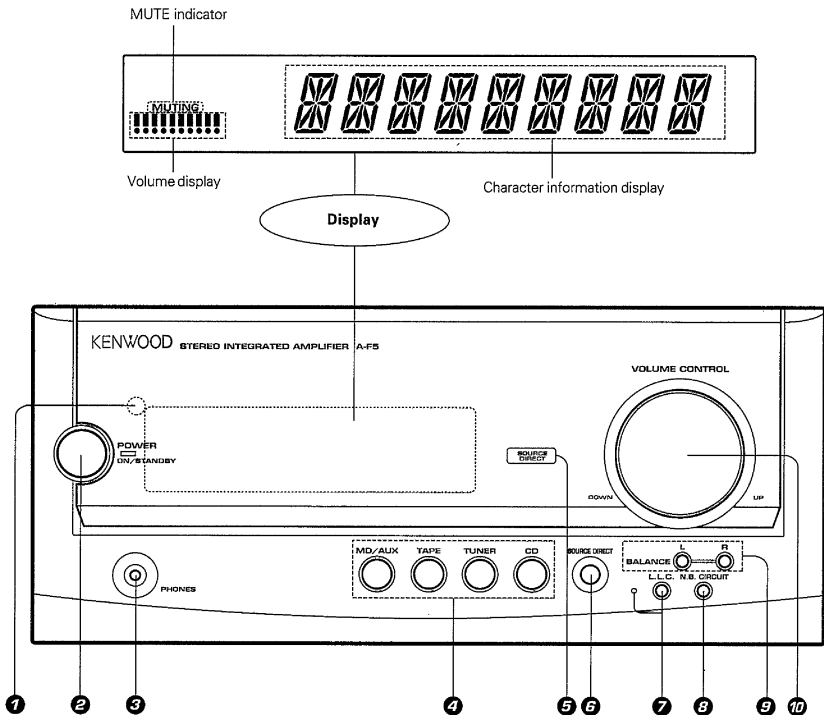

- ➊ Remote sensor
- ➋ POWER key
Press to turn the power ON/OFF.
- ➌ PHONES jack
Connect headphones for listening through them.
- ➍ Input selector keys
Press to select the component to be played.
- ➎ SOURCE DIRECT indicator
Lights when the SOURCE DIRECT function is ON.

- 14
- 15
- 16
- 19
- 17

- ➏ SOURCE DIRECT key
Press to enjoy music with a purer sound.
- ➐ L.L.C. key
Press to listen to sound at a low level.
- ➑ N.B.CIRCUIT key
Press to ON to activate automatic control of bass tone.
- ➒ BALANCE (LEFT, RIGHT) keys
Press to adjust the volume balance between the left and right speakers.
- ➓ VOLUME CONTROL knob

- 17
- 16
- 17
- 17
- 17

10 Tuner unit

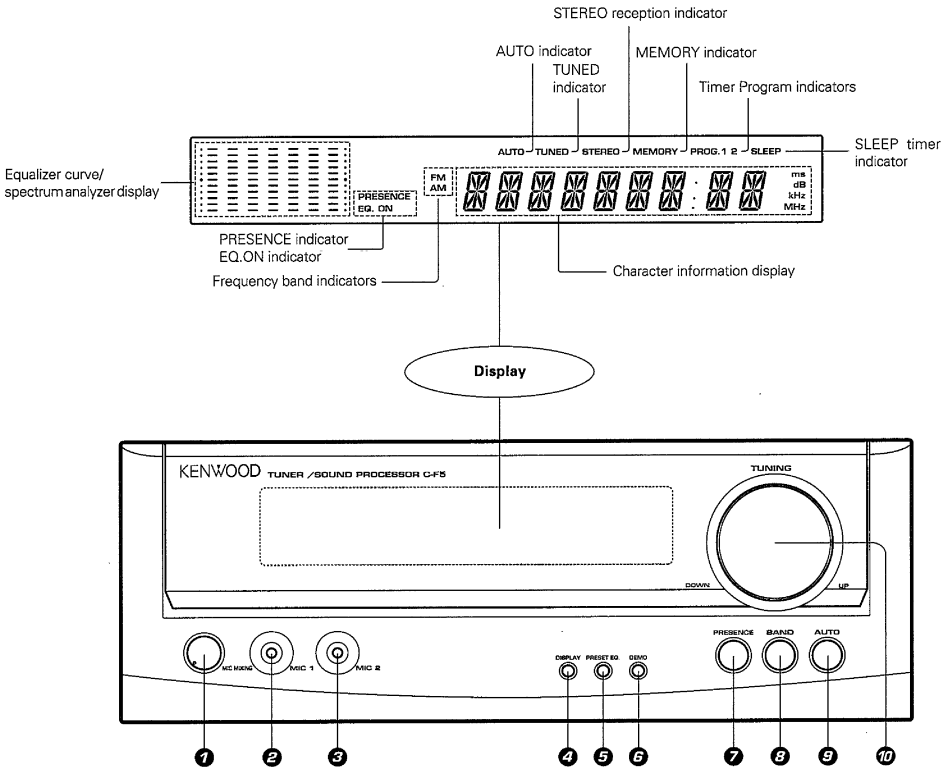

1 MIC MIXING control

Turn to adjust the microphone input volume.

- 4A

2 MIC 1 jack

- 4B

3 MIC 2 jack

- 4C

4 DISPLAY key

Press to change over the display contents.

- 30

5 PRESET EQ. key

Press to apply an equalizer pattern matching the category of the music being played.

- 4E

6 DEMO key

Press to start demonstration.

- 44

7 PRESENCE key

Press for presence play.

- 45

8 BAND key

Press to select the required frequency band.

- 30

9 AUTO key

Press to receive stations in auto tuning mode.

- 30

10 TUNING knob

Press to select the station to be received.

- 30

CD player unit

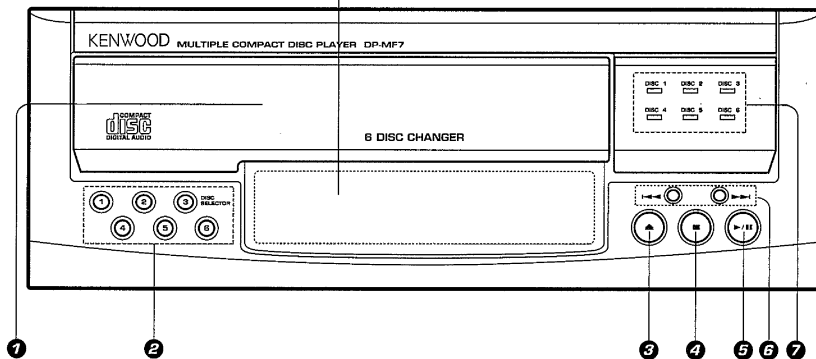
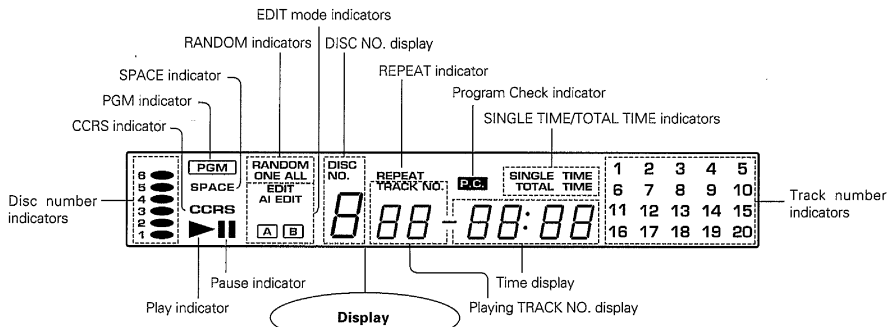

- 1 Disc tray
- 2 Disc selector keys
- 3 Open/close key
- 4 Stop key

- 5
- 6
- 7
- 8

- 5 Play/pause key
- 6 Skip keys
Press to skip to the beginning of another track.
- 7 Disc selector buttons

- 8
- 9
- 10
- 11

12 Cassette deck unit

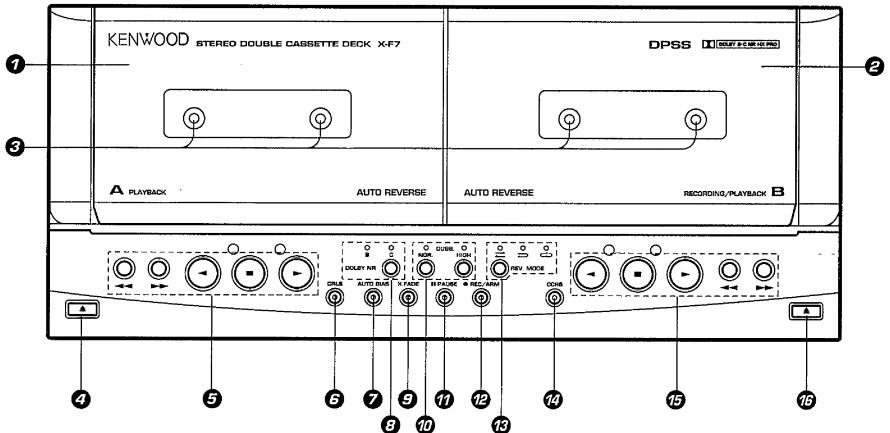

1 Deck A cassette holder

2 Deck B cassette holder

3 Tape running indicators

4 Deck A eject key

5 Deck A operation keys

- ◀◀◀ Rewind key
- ▶▶▶ Fast Forward key
- ▶▶▶ Play keys/indicators
- Stop key

6 CRLS key/indicator

Press to set the optimum recording level automatically.

7 AUTO BIAS key/indicator

Press to set the tape recording bias automatically.

8 DOLBY NR key/indicator

9 X.FADE (Cross-fade) key/indicator

Press to create a tape with continuous music by fading in the beginning and fading out the end of every tune.

10 DUBB. keys (HIGH, NOR.)/indicators

Press for dubbing between tapes.

11 Pause key/indicator

12 REC. MODE key / indicator

Press to switch over the play modes.

13 CCRS key/indicator

Press to start recording after having set the optimum recording level for the CD and the optimum recording bias for the tape automatically.

14 Deck B operation keys

- ◀▶ Play keys/indicators
- Stop key
- ▶▶▶ Fast Forward key
- ◀◀◀ Rewind key

15 Deck B eject key

Remote control unit

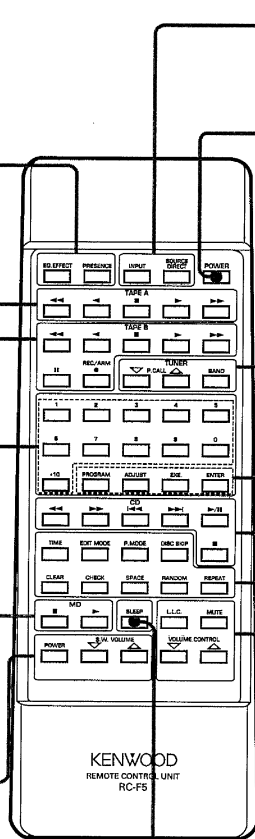

Graphic equalizer operation keys
EQ.EFFECT: Press to select a graphic equalizer effect.
PRESENCE: Press to select a presence effect.

TAPE operation keys
 These keys perform the same operations as the corresponding keys on the cassette deck. However, operations requiring simultaneous pressing of two keys are not possible.

Numeric keys
 Function as the numeric keys of the CD player when the CD input is selected.
 Function as the numeric keys of the tuner when the TUNER input is selected.

MD operation keys
 For use when operating the MD (optional).
 ■ key and ► key

Super woofer keys
 Use these keys to operate a super woofer (optional).
S.W. VOLUME
 :Press to adjust the volume of the super woofer (optional).
POWER
 :Press to switch the power of the super woofer (optional).

Input selector key
INPUT key: Press to select the component to be played.
SOURCE DIRECT key

POWER key

Tuner operation keys
 BAND key, P.CALL keys (Δ, ∇)

TIMER OPERATION keys
 PROGRAM key, ADJUST key, EXE. key, ENTER key

CD player basic operation keys
 ◀◀ and ▶▶ keys, ◀ and ▶ keys, ■ key, ►/II key
TIME :Press to switch the time display mode.
EDIT MODE :Press to select the edit recording mode.
P.MODE :Press for program playback.
DISC SKIP :Press to choose a disc.
CLEAR :Press to clear the contents of a program.
CHECK :Press to display the programmed contents in order.
SPACE :Press to leave non-recorded spaces of a few seconds between the programmed tracks.
RANDOM :Press to start random playback.
REPEAT :Press to start repeated playback.

L.L.C. key
 Press to set the volume at a level appropriate for quiet listening.
VOLUME CONTROL keys
 Press to adjust the overall volume. When these keys are pressed, the current volume level is displayed on the amplifier unit.
MUTE key
 Press to mute the sound temporarily.

Model: RC-F5
Infrared ray system

Operation of remote control unit

UD-553 (En)

14 Loading batteries

1 Remove the cover.

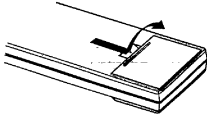

2 Insert batteries.

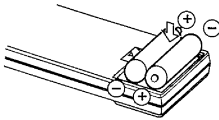

● Insert two R6 ("AA"-size) batteries following the polarity indications.

3 Close the cover.

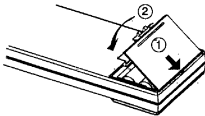

Operation

After plugging the power cord of the amplifier, press the **POWER** key of the remote control unit to turn the power of the system **ON**. When the power is turned **ON**, press the key of the function to be operated.

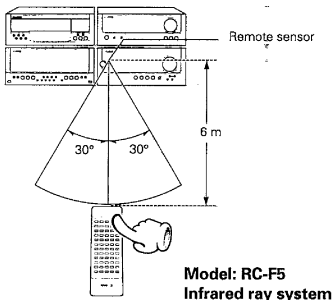

Model: RC-F5
Infrared ray system

Operating range (approx.)

● When pressing more than one remote control keys successively, press the keys securely by leaving an interval of 1 second or more between keys.

Notes



1. The provided batteries are intended for use in operation checking, and their service life may be short.
2. When the remote controllable distance becomes short, replace both of the batteries with new ones.
3. If direct sunlight or the light of a high-frequency fluorescent lamp (inverter type, etc.) is incident to the remote sensor, malfunction may occur. In such a case, change the installation position to avoid malfunction.

Clock adjustment

UD-553 (En)

This unit incorporates a clock function. Be sure to adjust the correct time before using the timer function.

Preparation

Ensure that the power is OFF.

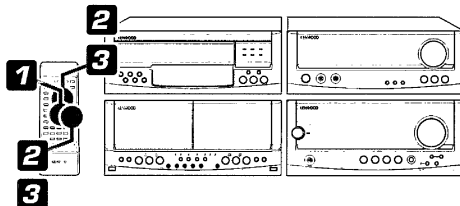
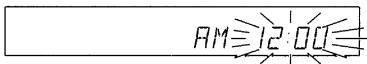

1 Activate the clock adjustment mode.

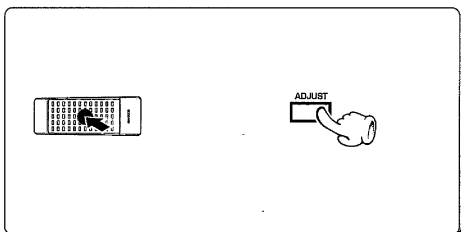

Example: Adjustment to 8:45AM

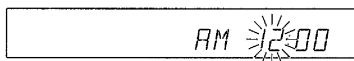

• The time display starts to blink.

2 Enter the figure of hour.

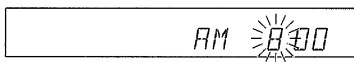
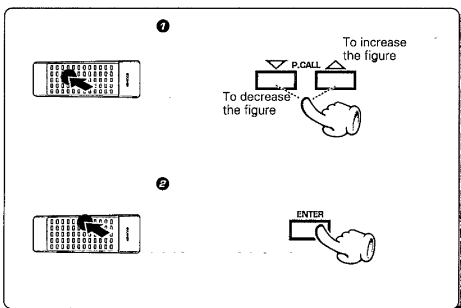

• The time of the day is represented in 12-hour AM/PM method.
• Press the **ENTER** key. The hour is entered and the minute display starts to blink.

3 Enter the figure of minute.

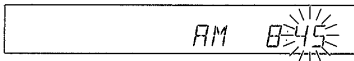
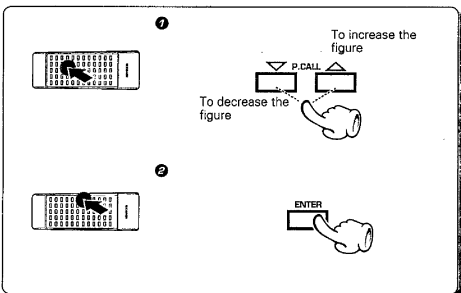

• If you make a mistake, restart from the beginning.
• To adjust correct time, press the **ENTER** key at the same moment as a time announcement.
• The time display blinks after a power failure or when the power cord has been unplugged from the AC outlet and plugged again. In such a case, adjust the clock again.

Power ON/OFF

Press the **POWER** key of the amplifier unit.

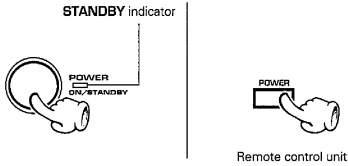

- The power of the overall system can be turned ON/OFF by pressing the **POWER** key of amplifier unit.

Listening at a low volume (L.L.C.: Low Level Control)

The volume set for quiet listening (L.L.C. volume) can be recalled with a one-touch operation.

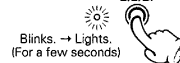

- The volume is decreased and the bass and treble tones are compensated.
- When L.L.C. is ON, amount of volume varied by rotating the **VOLUME CONTROL** becomes constant regardless of the rotating speed of the control.
- If the L.L.C. volume which has been stored in memory is higher than the current listening volume, the volume will not be changed by pressing this key.
- The volume does not return to the original level even after L.L.C. has been switched OFF. Adjust the volume as desired.

Enhanced bass entertainment with super woofer (optional)

- Press the **S.WOOFER POWER** key.

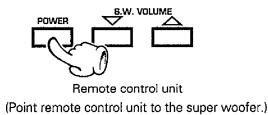

- Adjust the super woofer volume.

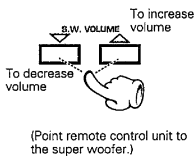

It can also be adjusted with the volume control provided on the super woofer.

- Once the super woofer volume has been set, it will increase or decrease according to the **VOLUME CONTROL** adjustment.

Listening through headphones

- Insert the headphone plug into the **PHONES** jack.

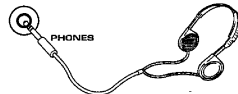

- The sounds from all speakers are cut off.
- **Adjust the volume.**
- Minimize the volume before plugging or unplugging the plug.

STANDBY mode of POWER switch

When the power cord is plugged into an AC outlet, the **STANDBY** indicator lights regardless of the power ON/OFF setting. This is because, even when the power is set to OFF, a small amount of power is supplied to the system to back up the memory. This status is called the standby mode of the system. While the **STANDBY** indicator is lit, the power can also be turned ON/OFF from the remote control unit.



To change the setting in memory

- Switch L.L.C. ON.
- While the L.L.C. indicator is blinking, set the L.L.C. volume with the VOLUME CONTROL or from the remote control unit.
- Press the L.L.C. key again while the L.L.C. indicator is blinking.

- When the key is pressed again after the L.L.C. indicator has finished to flash, this function is cancelled.
- If a larger L.L.C. volume than 29 is set, the bass and treble tones will not be compensated.

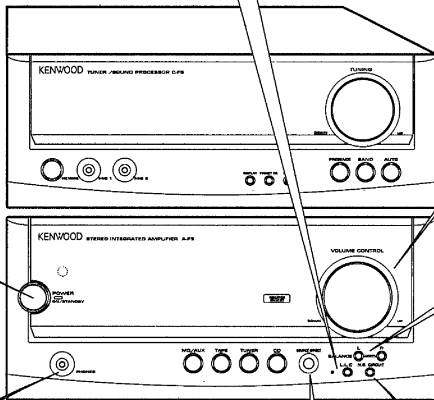

Volume adjustment

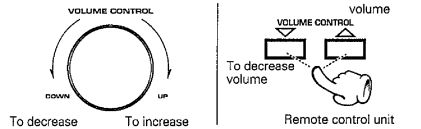

- When the L.L.C. key is pressed to ON, these controls function as the L.L.C. volume control.

Muting the sound temporarily

Remote control unit only

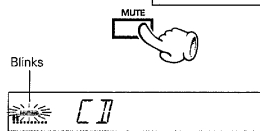

- Press again to resume the original volume.

Adjusting the left/right volume balance

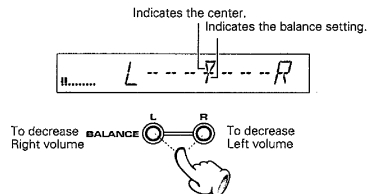

Compensation of bass sound

N.B. CIRCUIT: Natural Bass CIRCUIT

Press to ON to activate automatic adjustment of bass tone.

N.B. CIRCUIT



- Press the key again to cancel the N.B. CIRCUIT.

Playing sound with higher purity

Switching SOURCE DIRECT ON simplifies the signal path and thereby improves the purity of sound.

SOURCE DIRECT



- When the SOURCE DIRECT is ON, the SOURCE DIRECT indicators on the front panel lights.
- Press the key again to cancel the SOURCE DIRECT.

Input selection on the amplifier unit and easy operation function

With the easy operation function, simply selecting an input source with the input selector keys (TAPE, TUNER, CD, MD, etc.) of the amplifier unit start playback of the selected source component. On the contrary, starting playing a component switches the input selectors automatically to that input source. The same operation is also possible with the INPUT key of the remote control unit. When the power is switched ON, the source which has been input before the power was switched OFF last time (TUNER, CD, etc.) will be played.

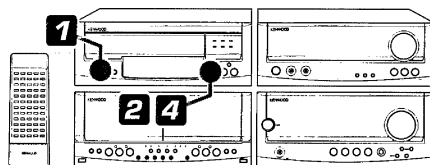

Loading a disc

1 Select a disc (bank).

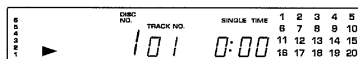
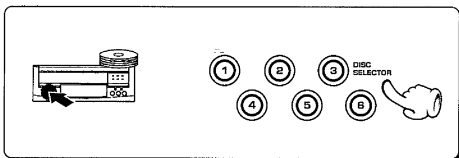

- If the CD player is left untouched for a few seconds after the disc bank number has been selected, the CD player will enter the disc search mode (or play mode). To prevent this, press the **▲** key immediately after selecting the disc bank.

2 Open the tray.

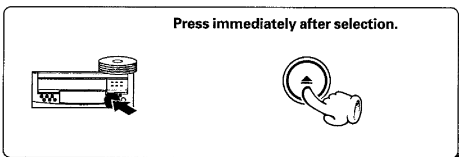

3 Place (or take out) a disc.

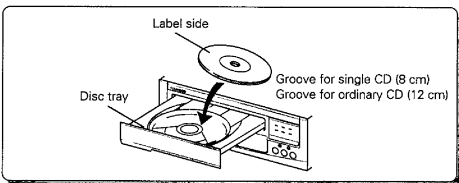

4 Close the tray.

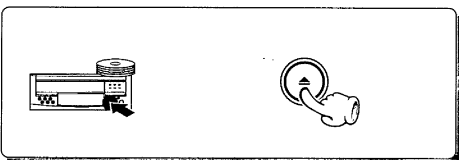

- Do not touch the played side of disc.
- Inserting 2 disks stacked on top of one another will cause a malfunction.

- A single CD (8 cm disc) can also be played.
- Place the disc properly along the groove on the tray. (If the disc is not placed horizontally, malfunction will result.)
- Ordinary CD single (8 cm) disc adapter sold in audio stores cannot be used with this unit.

- Then the disc which has been placed on the tray is stored in the disc bank selected in step **1**.

Lights when the tray is closed after loading a disc.

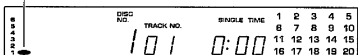

To load (or eject) more than one disc, repeat steps **1** to **4** for each disc.

Playing tracks in order from track No. 1



UD-553 (En)

Use the following procedure to play CDs in the original order of tracks from track No. 1.

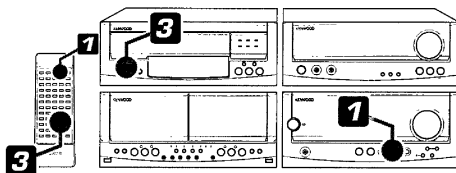

1 Select the "CD" input.

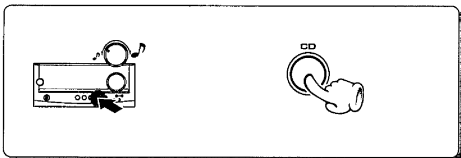

"CD" should be displayed.

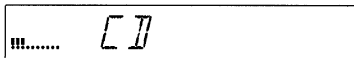

2 Load a disc.

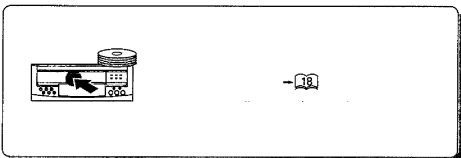

3 Start playback.

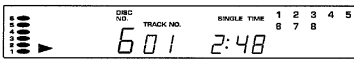
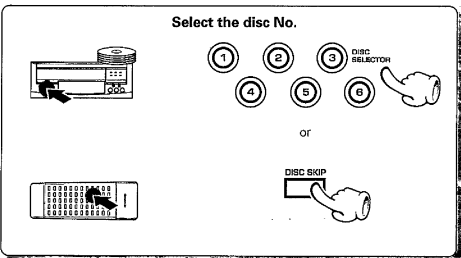

- Playback starts from the selected disc and continues in order of disc Nos.
- If the ►|| key is pressed without selecting a disc, discs will be played automatically in the following order: 1 → 2 → 3 → 4 → 5 → 6.

To stop playback

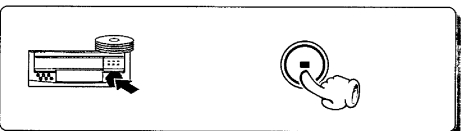

To pause playback

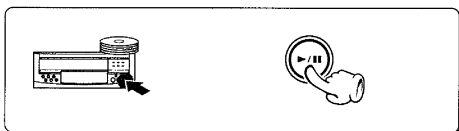

- Each press pauses and plays the CD alternately.



Playback from desired track

UD-553 (En)

Preparation

- Select the "CD" input.
- Load discs in the CD player.

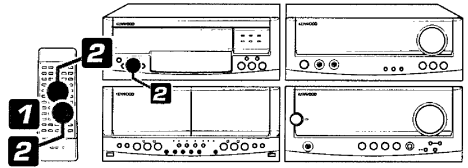

1 Press so that "PGM" indicator goes off.

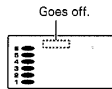
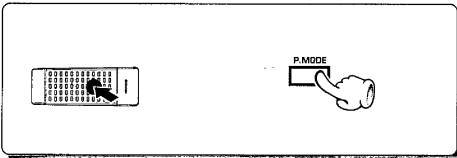

2 Select the desired track No.

① Select the disc.



- The disc can also be selected with the **DISC SELECTOR** key.

② Select the desired track No.

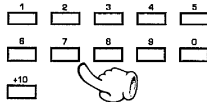

Press the numeric keys as shown below....

To enter track No. 23 : **+10 +10 3**

To select track No. 40 : **+10 +10 +10 +10 0**

- Playback starts from the selected track and continues on the subsequent tracks.
- If a track No. which does not exist on the disc is selected while the disc tray is open, the last track on the disc will be played.

Skipping tracks

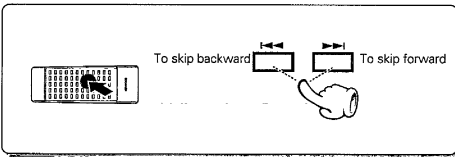

- The track in the direction of the button pressed is skipped, and the selected track will be played from the beginning.
- When the **⏮** key is pressed once during playback, the track being played will be played from the beginning.

Searching

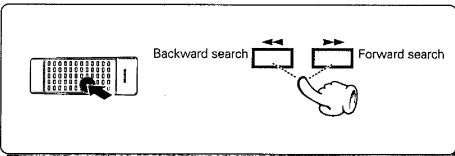

- Playback starts from the position where the key is released.

Programming tracks in desired order



UD-553 (En)

Use the following procedure to select desired tracks (up to 32 tracks) from up to 6 discs and program them in the desired order.

Preparation

- Select the "CD" input.
- Load discs in the CD player.

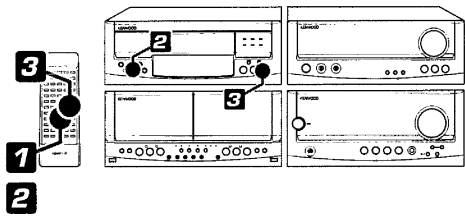

1 Press so that the "PGM" indicator lights.

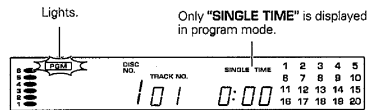

2 Enter track Nos. in the order you want to play them.

① Select the disc No.

Within 8 seconds!

② Select the track No.

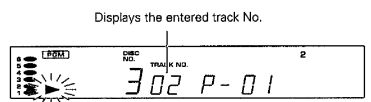

To select tracks from more than one CD, repeat steps ① and ② above.

3 Start playback

- Up to 32 tracks can be programmed. When "FULL" is displayed, no more tracks can be programmed.
 - If you make a mistake, press the CLEAR key and enter the track No. from the beginning.
 - If the track No. is not selected within 8 seconds after having selected the disc No., all of the tracks on the disc will be programmed.
 - If a disc No. which is not present in the magazine is entered, it is programmed temporarily but canceled at the time of playback.
-
- Tracks will be played in the order they were programmed (in order of P Nos.).
 - When the < or > key is pressed during playback, the track will be skipped in the direction of the pressed button.

To stop playback

To return to playback in order of track Nos.

● Playback in the original order of tracks starts with the track being played.



Auto space function

When the **SPACE** key is pressed during programming of tracks, a non-recorded space of a few seconds will be created between tracks. By recording tracks with these spaces on tape, the search and repeat play operations of tape using the DPSS function (which works by searching the non-recorded spaces) can be performed reliably.

- Even when the performances of two tracks are continuous (which occurs with classical or live recording music), the spaces will be created if they have different track Nos.
- To cancel auto space function, press the **P.MODE** key or the **SPACE** key again.

To check the programmed tracks

Remote control unit only

P.C. lights.

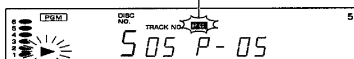
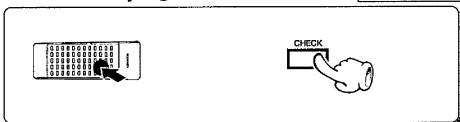

- Each time the key is pressed, the program No. (P-NO) and the disc No. are displayed.
- The previous display resumes in a few seconds.

To add a track to the program

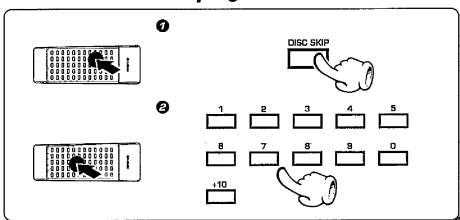

- When a track No. is entered, the track will be added to the end of the existing program.

To change a track in the program

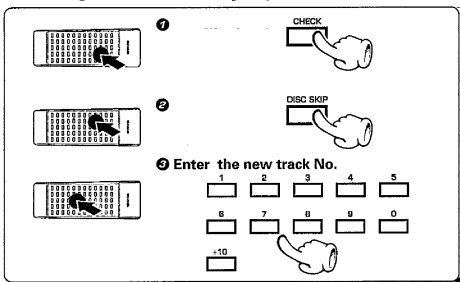

P.C. lights.



- Press the **CHECK** key repeatedly until the track No. to be changed is displayed.

- Press while the **P.C.** indicator is lit.
- The track being played cannot be changed.

To clear tracks from the program

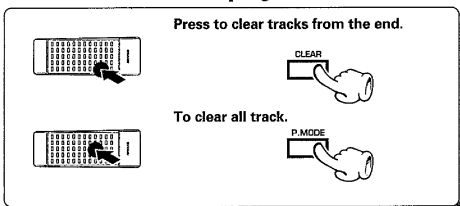

Press to clear tracks from the end.

To clear all track.

- Each time the key is pressed, the last track in the program is cleared.
- The track being played cannot be cleared.

- The entire programmed contents are also cleared when the **▲** key is pressed.

Preparation

- Select the "CD" input.
- Load discs in the CD player.

Time display on CD player

Each press of the **TIME** key changes the displayed contents.

- | | | |
|---|--------|--|
| ① | 1:23 | : Elapsed time of track being played |
| ② | -2:37 | : Remaining time of track being played |
| ③ | 23:45 | : Elapsed time of entire disc |
| ④ | -36:15 | : Remaining time on entire disc |

- Only the **SINGLE TIME** displays are shown in the PGM, EDIT and RANDOM modes.

To repeat all discs

All tracks on all of the discs loaded on the disc tray will be played repeatedly.

- 1 Press so that the "PGM" indicator goes off.



- 2 Press to select REPEAT.



- 3 Select the disc to be played first.



Press so that the "PGM" indicator goes off.

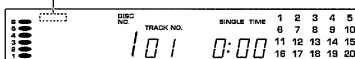

Each press switches the repeat mode.

- 1 REPEAT
- 2 Repeat OFF

Lights.



To cancel repeated playback

Press the REPEAT key again.



To repeat only the programmed tracks

① Press so that the "PGM" indicator lights.



② Select the disc.



Within 8 seconds!

③ Select the track No.

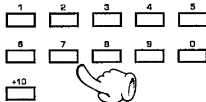

④ Press to select REPEAT.



⑤ Start playback.



Lights.

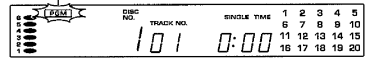

- If the track No. is not selected within 8 seconds after having selected the disc No., all of the tracks on the disc will be programmed.
- All of the programmed tracks will be played repeatedly.
- Up to 32 tracks can be programmed by repeating steps ② and ③. When "FULL" is displayed, no more tracks can be programmed.

Lights.

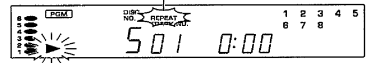

To cancel repeated playback

Press the REPEAT key again.

Playback in a random order (Random playback)

UID-553 (En)

As Tracks are selected at random, you can enjoy listening to for a long time.

Preparation

- Select the "CD" input.
- Load discs in the CD player.

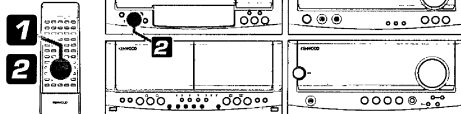

1 Press so that the "PGM" indicator goes off.

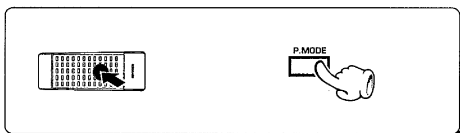

Press so that the "PGM" indicator goes off.



2 Select discs.

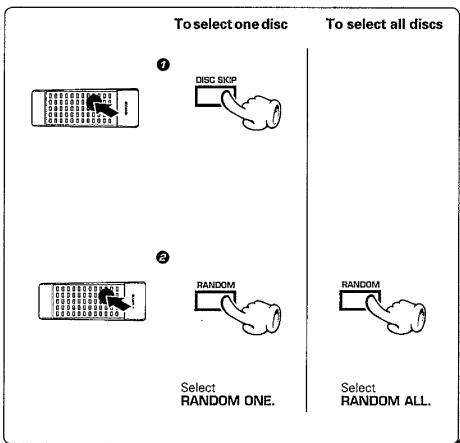

Each press of the **RANDOM** key changes the random playback modes.

- ① **RANDOM ONE** : Random playback from a single disc.
- ② **RANDOM ALL** : Random playback from all discs.
- ③ **Display OFF** : Random playback is OFF.

Example: when track No. 7 of disc No. 3 is selected first

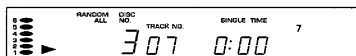

- After every track, the track number display blinks and the next selected track will be played.

Example: when track No. 3 of disc No. 5 is selected next



"RANDOM ONE" or "RANDOM ALL" indicator

- Random playback ends when all of the tracks on the disc or the discs have been played once.
- Random playback can be repeated by pressing the **REPEAT** key.

To select another track in the middle of playing one

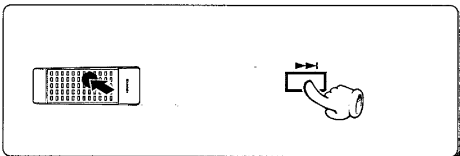

- Pressing the **◀** key once returns to the beginning of the track being played.

To cancel random playback

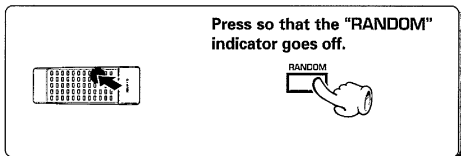

- Press the **RANDOM** key to start normal playback.

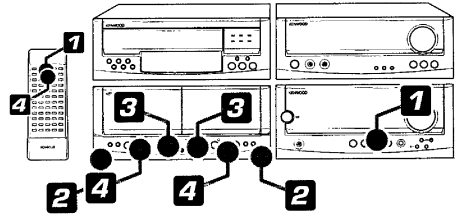

Tape playback

1 Select the "TAPE" input.

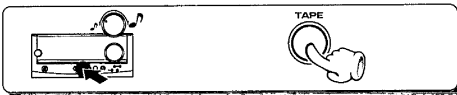

Press so that "TAPE" is displayed.

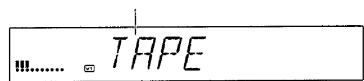

2 Load a cassette tape.

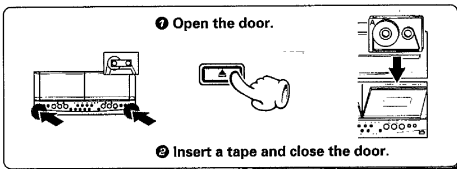

- The type of tape, that is, Normal, Chrome or Metal, is set automatically.
- Remove tape slack before loading.
- Close the door securely.

3 Determine the playback modes.

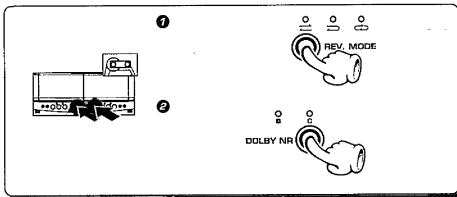

Each press switches the modes as follows.

- ① "⏮" Endless playback occurs.
 - ② "⏪" Playback stops after having played a side.
 - ③ "⏩" Playback stops after having played the two sides.
(If the ◀ key is pressed, only tape side B will be played and tape will stop after it.)
 - ① DOLBY NR "B" General NR.
 - ② DOLBY NR "C" NR with higher performance.
 - ③ DOLBY NR "OFF"
(no indication) Dolby NR is not used.
- Select the Dolby NR mode according to the recording condition of the tape.

4 Start playback.

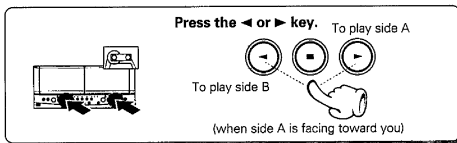

To stop playback

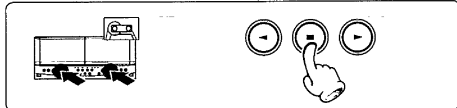

- Do not press the eject key until the tape has stopped completely.

To wind tape at high speed

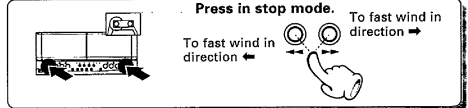

- Press the ■ key to stop fast winding.

Relay playback



UD-553 (En)

Use the following procedure to play tapes in decks A and B alternately.

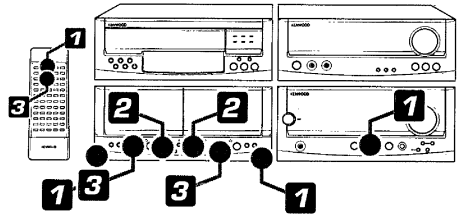

1 Load tapes.

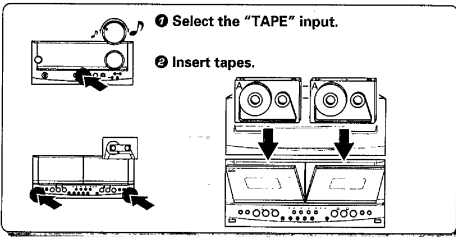

2 Select the playback modes.

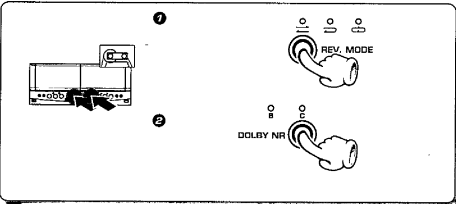

3 Start playback.

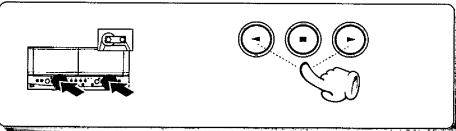

- The tape sides indicated by the tape transport direction indicators will be played.

Each press switches the modes as follows.

- ① "↔" Relay playback does not occur with this position.
 - ② "→" Playback stops after having played one side on each of tapes in decks A and B.
 - ③ "↔" The two sides of tapes in decks A and B will be played repeatedly.
- ① DOLBY NR "B" General NR.
 - ② DOLBY NR "C" NR with higher performance.
 - ③ DOLBY NR "OFF" (no indication) Dolby NR is not used.

- Select the Dolby NR mode according to the recording condition of the tape.

- Relay playback starts with the deck corresponding to the pressed key.

Dolby Noise Reduction (NR)

The Dolby NR system is used to minimize the hiss noise heard when playing tape. The system has the B type and C type, and the same type should be used in recording and playback to obtain the noise reduction effect.

When you record a tape, it is recommended to write the type used, "B" or "C", on the cassette label.

Dolby B NR: Generally-used Dolby NR.

Dolby C NR: Features a higher noise reduction effect than the B type.

The use of Dolby C NR is recommended if you record tapes to be played on this unit.

Transport direction indicators

The ◀ and ▶ indicators indicate the current direction in which the tape advances when playback or recording is started automatically by the easy operation function, etc. This direction is the direction stored in memory when the tape was last stopped.

(To change the direction, press the ▶ key for the opposite direction then press the ■ key.)



Transport direction indicators



DPSS (Direct Program Search System)

The DPSS is capable of detecting non-recorded spaces of more than 4 seconds as "blanks between programs". It can be used in four ways as described below.

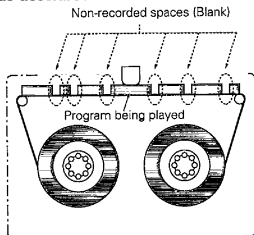

1. **Skip search** : Plays the desired music program from the beginning by skipping programs until there.
Up to 16 programs can be skipped.
2. **Dash & play** : Plays music programs repeatedly by skipping non-recorded spaces of more than 10 seconds.
3. **One-program repeat playback** : Plays a single music program repeatedly up to 16 times.
4. **Rewind playback** : Rewinds tape to the beginning and restarts playback from there.

Skip search

(Playback in the ► direction)

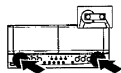

To play the next program : Press once.
To play the 4th program
after the current program : Press 4 times.



To return to the beginning
of the current program : Press once.
To play the 4th program
before the current program: Press 5 times.

(Playback in the ◀ direction)

To return to the beginning
of the current program : Press once.
To play the 4th program
before the current program: Press 5 times.



To play the next program : Press once.
To play the 4th program
after the current program : Press 4 times.

Notes



1. The DPSS cannot be used on decks A and B simultaneously.
2. The DPSS may not function normally with the following kinds of tape.
 - Tapes containing several no-sound intervals of more than 4 seconds, such as conversation and talk tapes.
 - Tapes containing pianissimo sections, such as classical music tape.
 - Tapes in which large noise is recorded in blanks between programs.
 - Tapes containing blanks between programs that are shorter than 4 seconds.
 - Tapes recorded at low level.
 - Tapes recorded by cross-fade recording (in which the beginning of next program is overlapped on the end of previous program).

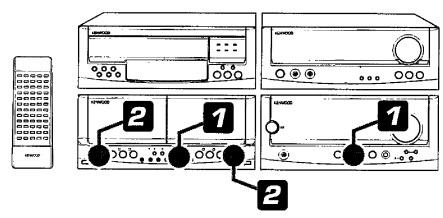

Dash & play

1 Select the playback modes.

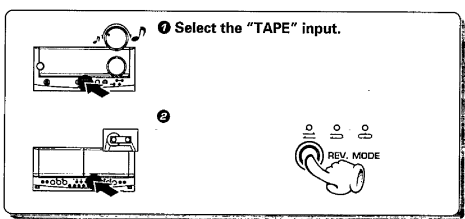

When a non-recorded space of more than 10 seconds is detected during playback, that space is automatically skipped by fast winding to play only the tape sections where sound is recorded.

Each press of the key switches the modes as follows.

- ① "↔" The two tape sides are played 8 times, after which playback stops.
- ② "≡" A tape side is played 8 times, after which playback stops.
- ③ "→" The two tape sides are played once, after which playback stops.

● If "↔" is selected while tapes are present in both decks A and B, Dash & Play of the second deck starts after Dash & Play of the first selected deck has completed. This is repeated 16 times, after which the playback stops.

2 Start dash & play.

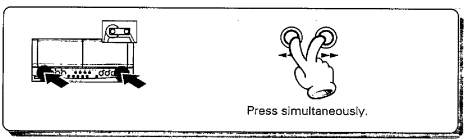

Main unit only

● When the ■ key is pressed, playback stops and the dash & play is canceled.

One-program repeat playback

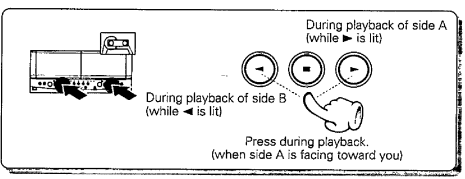

- The program being played will be repeated 16 times, after which normal playback resumes.
- When the ■ key is pressed, playback stops and the one-program repeat is canceled.

Rewind playback

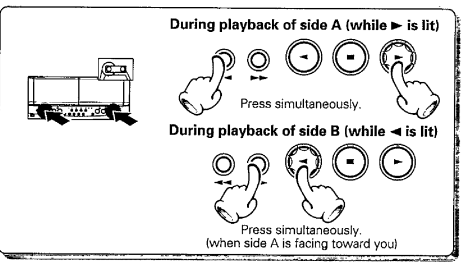

Main unit only

● Tape is rewound until the beginning of the program being played, then its playback starts.



Broadcast reception

UD-553 (En)

It is possible to receive broadcasts by one-touch operations by storing up to 40 stations in the preset memory.

Preparation

- Select the "TUNER" input.

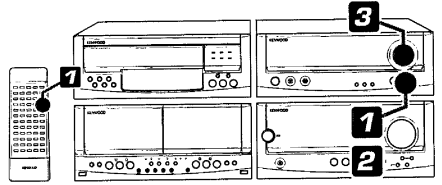

Receiving a broadcast station

1 Select the broadcast band.

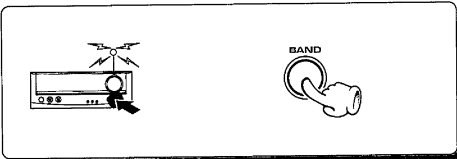

Each press alternates the band.

- ① FM
- ② AM

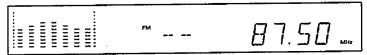

2 Select the tuning mode.

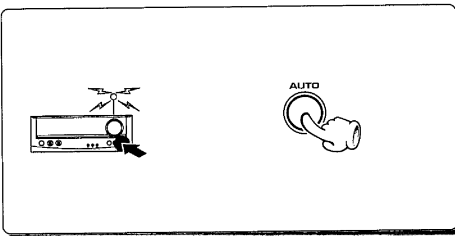

Each press alternates the mode.

- ① AUTO lit (Auto tuning)
- ② AUTO not lit (Manual tuning)

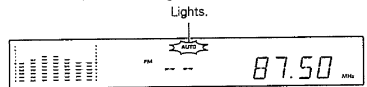

- Normally, use the **AUTO** (Auto tuning) mode.



Use the manual tuning mode when reception is noisy due to weak reception. (In the manual mode, stereo broadcasts are received in monaural.)

3 Select a station.

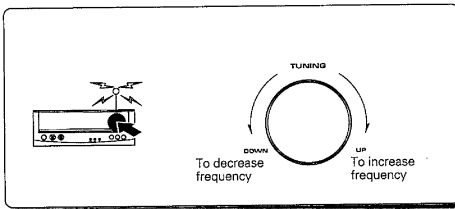

The "TUNED" indicator lights when a station is received.

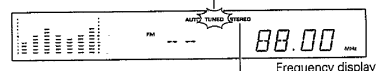

Lights during stereo reception.



- Auto tuning : Every time the control is rotated, a next station will be received.
- Manual tuning : Frequencies vary continuously while the control is kept rotated.

DISPLAY key

Every time the DISPLAY key is pressed, the display contents change.

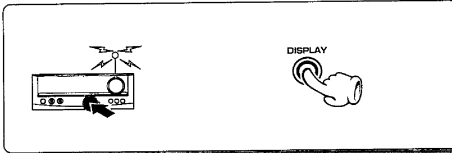

Each press changes the display as follows.

- ① Frequency display: The frequency being received is displayed.
- ② Clock display : When an operation related to tuning is done, it changes to the frequency display for a few seconds.

- While the power is OFF, the display shows time of the day.

Storing radio stations in memory (Station preset)



UD-553 (En)

Preparation

- Receive a station to be stored in preset memory.

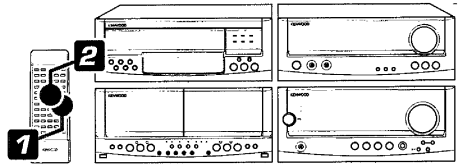

1 Press the ENTER key during reception.

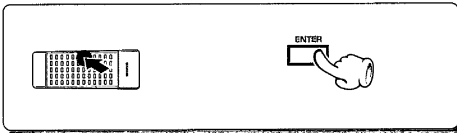

Go to step 2 within 5 seconds.

If more than 5 seconds have elapsed, press the ENTER key again.

2 Select one of the preset numbers from 1 to 40.

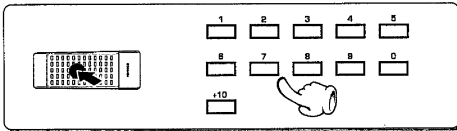

MEMORY lights (for approx. 5 sec.).

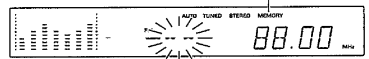

- The station being received will be stored in preset memory.

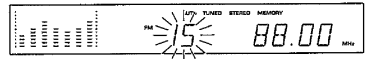

Press the numeric keys as follows



- To store the station in preset "15": $+10$ 5
- To store the station in preset "40": $+10$ $+10$ $+10$ $+10$ 0

In a few seconds later

Goes off.

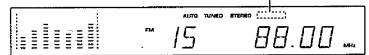

- Repeat steps 1 2 to preset other stations.
- If several stations are preset under the same number, the previous memory is replaced with the latest memory contents.

Receiving a preset station

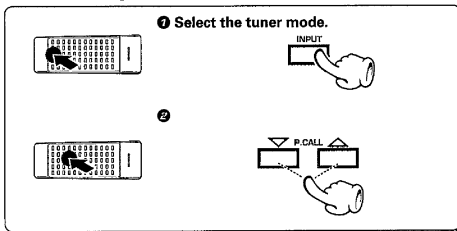

- Every time the key is pressed, the preset stations are switched over as follows.

Press Δ for the order of 1→2→3 ... 38→39→40→1...
Press ∇ for the order of 40→39→38 ... 3→2→1→40...

- When a key is held depressed, preset stations will be skipped at an interval of about 0.5 second.

Press the numeric keys as follows



- To call "15": $+10$ 5
- To call "40": $+10$ $+10$ $+10$ $+10$ 0



Recording (Deck B only)

UD-553 (En)

This unit incorporates the CRLS (Computer Recording Level System), automatic recording level setting and Dolby HX Pro headroom extension to allow excellent sound recording with simple operation.

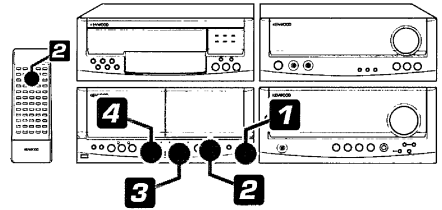

Preparation for recording

1 Load a tape in deck B.

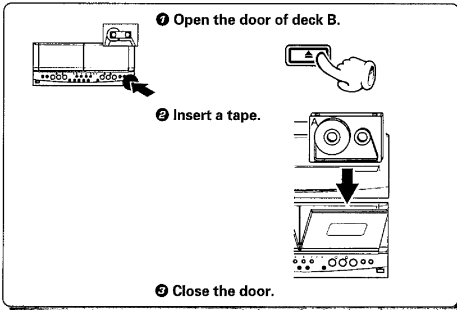

2 Select the tape transport direction.

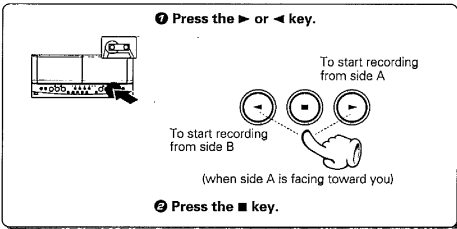

3 Select the recording mode.

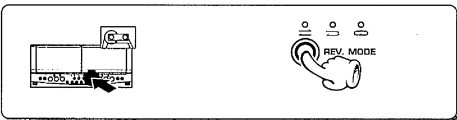

4 Select the Dolby NR mode.

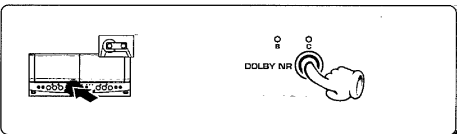

- The type of tape, that is, Normal, Chrome or Metal, is set automatically.
- Remove tape slack before loading.
- When the microphone is not used, set the **MIC MIXING** control fully counterclockwise to the minimum position.

- When recording is started, the tape is transported in the direction selected in this step.
- Wind the tape to the position where recording is to be started.

Each press of the key switches the modes as follows.

- ① "↔" (In this case, too, the two tape sides are recorded, after which recording stops.)
- ② "←" A tape side is recorded, after which recording stops.
- ③ "→" The two tape sides are recorded, after which recording stops.

Each press of the key switches the modes as follows.

- ① **DOLBY NR "B"** B type (general type).
- ② **DOLBY NR "C"** C type (with higher performance).
- ③ **DOLBY NR "OFF"** (no indication) Dolby NR is not used.

Preparation



- Load a cassette tape in the deck.
- Select the tape transport direction (◀ or ▶).
- Select "⊕", "⊖" (two-side recording) or "⊔" (one-side recording).
- Select the Dolby NR mode.
- (Insert a disc in the CD player.)

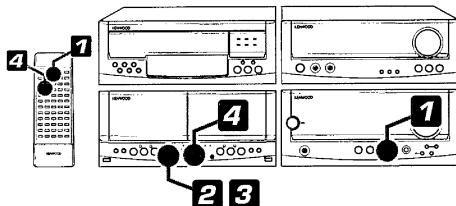

Recording (Deck B only)

1 Select the source to be recorded.

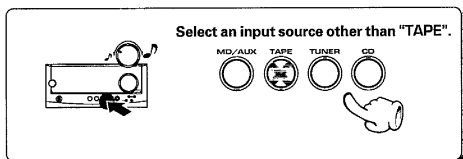

2 Start auto-bias adjustment.

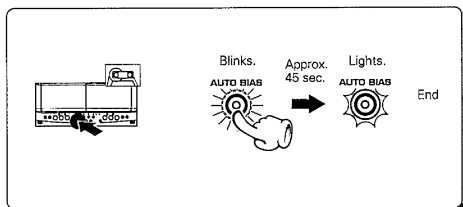

3 Start auto recording level adjustment.

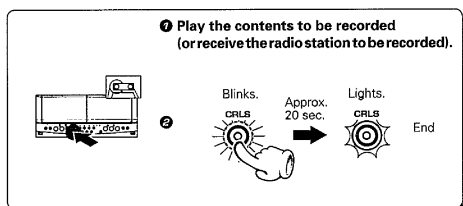

4 Start recording.

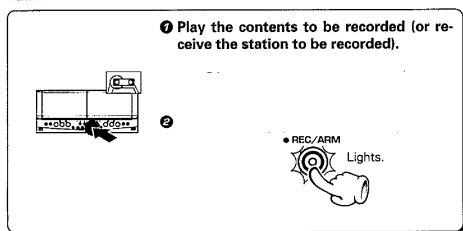

The source component to be recorded should be displayed.

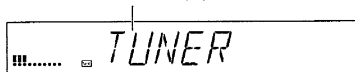

- When the CD input is selected and if a disc has been set in the CD player, its playback starts immediately.

- The bias adjustment consists of checking the characteristics of the loaded tape and adjusting the deck to allow best-balanced recording. The adjustment data are held in memory unless the power is turned OFF or the door of deck B is opened, so it is not required to re-adjust the bias in case of re-recording.
- The bias adjustment completes in approx. 45 seconds, after which the deck enters the stop mode.
- To abort bias adjustment in the middle, press the ■ key.
- Even if the bias adjustment is not performed, there will be no trouble in recording because a general bias has been set depending on the Normal, Chrome or Metal type of tape.

- The recording level setting completes in approx. 20 seconds, after which the deck enters the record-pause mode.
- If recording is started during the setting (while the CRLS indicator is blinking), distorted sound may be recorded.
- If the CRLS key is pressed during the setting (while the indicator is blinking), the setting is interrupted and the deck enters the record-pause mode.
- If a non-recorded space of more than 3 seconds is detected after the CRLS key is pressed, the recording level setting is aborted.

If the CD track to be recorded is selected without pressing the ■ key, recording on the cassette deck starts automatically.

- Recording starts.
- Recording stops automatically when the tape side(s) to be recorded have been recorded.



Function of CRLS key

The CRLS sets the recording level automatically in 20 seconds by analyzing the sound to be recorded.

If the key has never been pressed

The sound is recorded with the basic level set with the unit.

If the key is pressed

The recording level is set automatically and stored in memory as the recording level to be used with the current input being selected (CD, TUNER, AUX, etc.). From the next time on, this recording level is set automatically for that input even if the key is not pressed.

To return to the level used in previous recording

Press the key while the CRLS indicator is blinking.

To return to the basic level

Hold the key depressed until the indicator goes off (for approx. 3 seconds).

Re-recording

① **Rewind tape without stopping recording.**

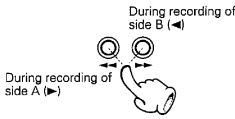
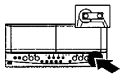

(when side A is facing toward you)

② **Press the ● REC/ARM key twice.**

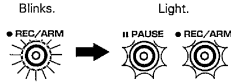

③ **Press the ● REC/ARM key once.**

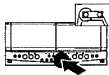

● In case there is a non-recorded blank of more than 4 seconds immediately before the recording start position, recording is aborted and tape is rewound as shown below.

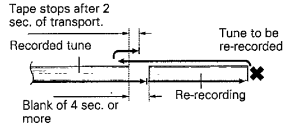

● If there is no recorded tune before, the tape will be rewound then stopped.

- After leaving a non-recorded blank of about 4 seconds, the deck enters the record-pause mode.
- When re-recording from the beginning of tape, feed the leader tape (the first portion of tape that cannot be recorded) before starting re-recording.

● Recording will start.

To pause recording temporarily

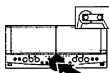

● Press the ● REC/ARM key to restart recording.

To end recording in the middle

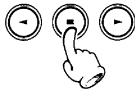
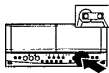

Dolby HX Pro

The Dolby HX Pro headroom extension system records high frequencies such as the cymbal sound clearly by controlling the bias current during recording according to the frequency composition of the sound being recorded. This system is activated automatically during recording with this unit.

Copying tape (Tape dubbing)



UD 553 (En)

Preparation

- Select the tape transport direction (◀ or ▶).
- Select "DUB. NR" (two-side recording) or "DUB. HIGH" (one-side recording).

- 32 -

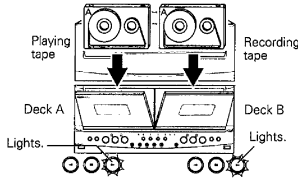

The contents of the tape in deck A can be copied onto the tape in deck B.

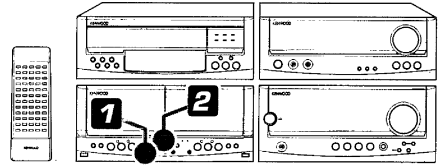

1 Start auto-bias adjustment.

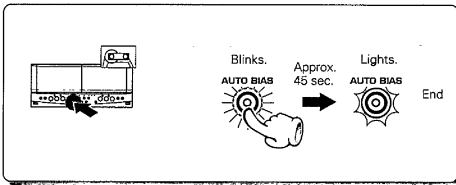

- The bias adjustment consists of checking the characteristics of the loaded tape and adjusting the deck to allow best-balanced recording. The adjustment data are held in memory unless the power is turned OFF or the door of deck B is opened.
- The bias adjustment completes in approx. 45 seconds, after which the deck enters the stop mode.
- To abort bias adjustment in the middle, press the ■ key.
- Even if the bias adjustment is not performed, there will be no trouble in recording because a general bias has been set depending on the Normal, Chrome or Metal type of tape.

2 Start dubbing.

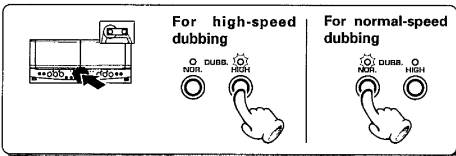

- Dubbing starts.
- Dubbing ends automatically when the side(s) to be dubbed has been completed.

To stop dubbing

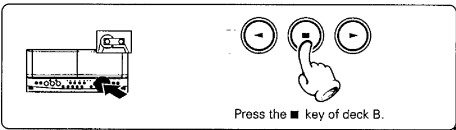

- Both decks A and B stop.

To pause dubbing

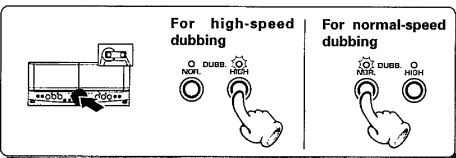

- Only deck B enters the record-pause mode after leaving a non-recorded space of approx. 4 seconds in case of normal-speed dubbing or approx. 6 seconds in case of high-speed dubbing.
- To skip a tune which need not to be dubbed, press the ►► key of deck A.
- To restart dubbing, press the DUBB. NOR., or DUBB. HIGH key which was pressed to pause dubbing.

Notes

1. The recording level adjustment is not necessary in dubbing.
2. The DOLBY NR key is not active in dubbing mode. The tape recorded on deck B is given the same Dolby NR condition as the tape played on deck A.
3. To prevent interference of noise, the unit should be separated at a distance from a TV during high-speed dubbing.
4. To avoid sound quality degradation, use the normal-speed dubbing when dubbing from a tape recorded with a high recording level.





The following procedures allow edit recording of CDs by simply setting the length (recording time) of the tape. All of other operations will be assumed by the UD system, from the recording level and bias settings to the complicated processing at the end of two sides of tape. (CCRS)

Desired CD tracks of more than one CD can be edited in the desired order. In this case, use the "program edit recording" procedure.

Select the type of edit recording

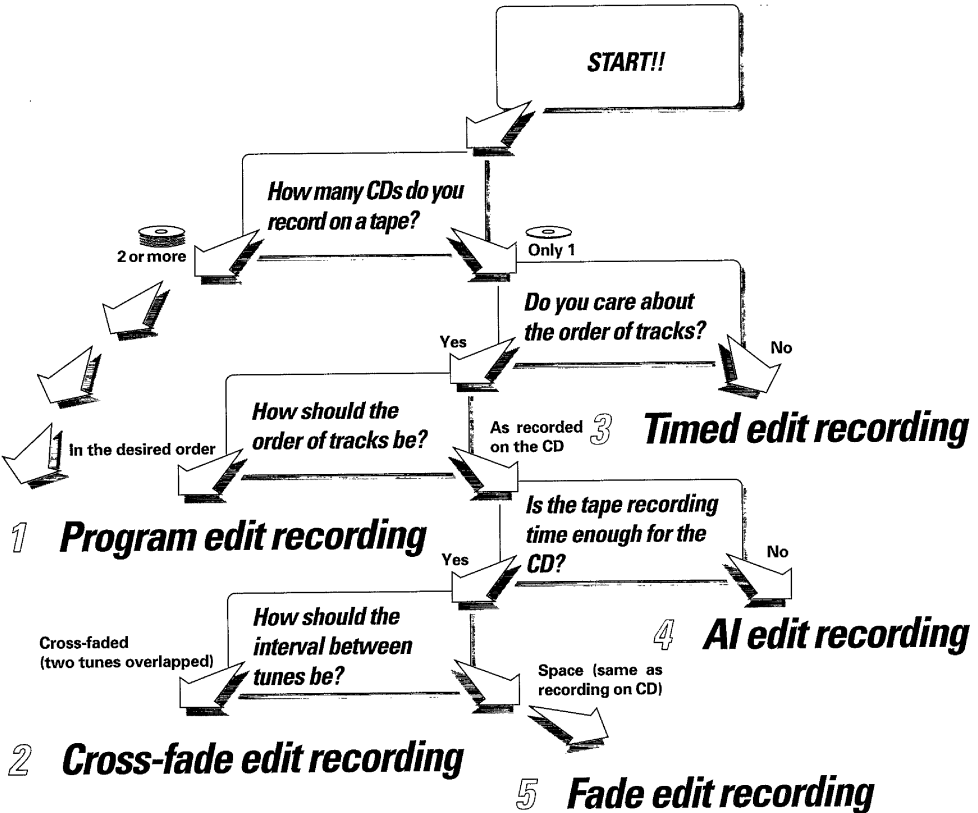

CCRS (Computer Controlled Recording System)

The CCRS allows to record CD on tape with a one-touch operation.

When the CCRS key is pressed, the contents of CD and the characteristics of the tape used are checked in approx. 90 seconds (variable depending on CD contents), the recording level and bias are automatically set accordingly and recording starts. After the recording, it is also stopped automatically.

The auto bias setting is cleared when the power is turned OFF or the door of deck B is opened. (The "AUTO BIAS" indicator is lit while the auto bias data is held in memory.)

The edited data is cleared when the power is turned OFF or when the CD is stopped.



Fade-in/fade-out

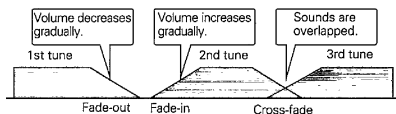

Fade-out : Ending a tune by gradually decreasing the volume.

Fade-in : Starting a tune by gradually increasing the volume.

Cross-fade : Combination of fade-out and fade-in so that the sounds of two tunes are overlapped.

1 Program edit recording

- [39]

From one CD

CD tracks are recorded in the order they are programmed. The tune interrupted at the end of tape side A is erased and side B starts from the beginning of that tune. (up to 32)

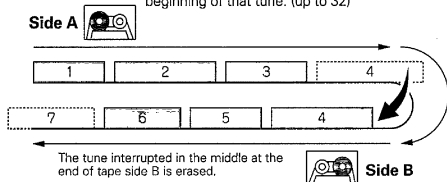

From more than one CD

CD tracks of several CDs are recorded in the order they are programmed. The tune interrupted in the middle at the end of tape side A is erased and side B starts from the beginning of that tune. (up to 32)

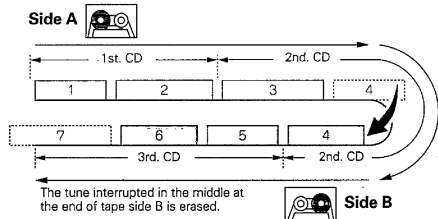

2 Cross-fade edit recording

- [39]

Tunes are connected by fade-out and fade-in, and the tune interrupted at the end of tape side A is re-recorded at the beginning of tape side B.

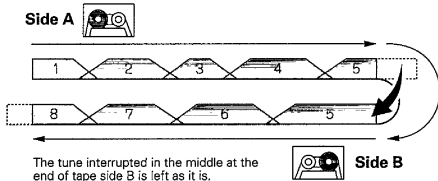

The cross-fade edit recording can be combined with a desired edit recording function (except for AI edit recording).

3 Timed edit recording

- [40]

The order of CD tracks is changed automatically so that no tune is interrupted at the end of tape sides A and B. (up to 32)

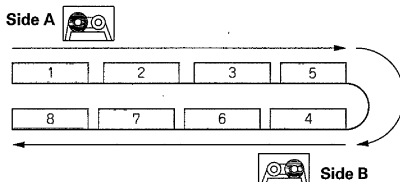

4 AI edit recording

- [41]

In case the recording time of tape is shorter than the playing time of CD, all of CD tracks (up to 32) are accommodated by fading out the ending parts.

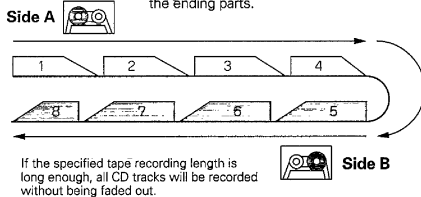

5 Fade edit recording

- [42]

CD tracks are recorded in the order they are recorded. The tune interrupted at the end of tape side A is faded out and side B starts with fading in from the middle of that tune. (up to 32)

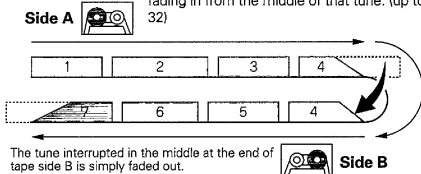



Program edit recording

Use the following procedure to record CD tracks in the order programmed by yourself so that no tune is interrupted in the middle at the ends of tape sides.

The tune interrupted at the end of tape side A is erased and side B starts from the beginning of that tune.

Preparation

- 32

- Load a cassette tape in deck B.
- Select the tape transport direction (◀ or ▶).
- Select "◀", "▶" (two-side recording).
- Select the Dolby NR mode.
- Select the "CD" input.
- Insert disc(s) in the CD player.

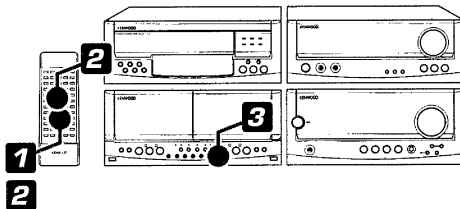

1 Press so that the "PGM" indicator lights.

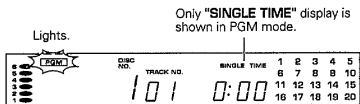
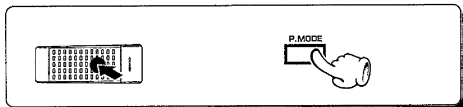

2 Enter disc Nos. and track Nos. in the order you want to record them. (Editing)

① Enter the disc No.

DISC SKIP

Within 8 seconds!

② Enter the track No.

1	2	3	4	5
6	7	8	9	0
+10				

To edit tracks from more than one CD, repeat ① and ② for each CD.

Press the numeric keys as shown below....

To enter track Nos. 2, 5 and 25:

2 5 +10 +10 5

Displays the entered track No.

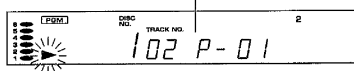

To check the edited contents
To clear the edited contents

- 43

3 Start edit recording.

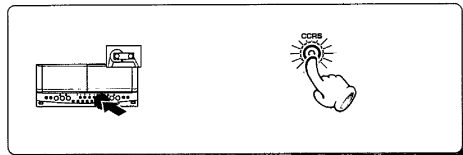

- Select CD tracks so that their total playing time does not exceed the recording time of the tape.
- Up to 32 tracks can be programmed. When "FULL" is displayed, no more tracks can be programmed.
- If you make a mistake, press the CLEAR key and enter the track No. from the beginning.
- The CCRS setting will not occur if the track No. is not selected within 8 seconds after having selected the disc No.
- The REPEAT key is invalid.

- The recording level and bias will be adjusted automatically in approx. 90 seconds (variable depending on CD contents), after which recording starts.
- In editing from more than one CD, the CCRS setting operation is performed after every disc change. In this case, the deck stops automatically and restart recording after having completed the CCRS operation.

Notes



1. When the CCRS key is pressed during playback of CD, the playback stops and the CCRS setting (preparation for edited recording) starts.
2. The automatic recording level setting operation in the edit recording utilizes a section suitable for this purpose in the CD present in the CD player.
3. Edit recording is not possible with CDs containing a track that is longer than one tape side, which may occur with classical music, etc.
4. If the deck is set for one-side recording (▶), the processing at the tape end is applied only on side A.



The cross-fade editing may be easier to understand by saying that it is a function for cross-fading tunes than saying that it edits the order of tunes. This function can be used in combination with the desired editing method as well as in simple recording of CD tracks in the order they are recorded on the CD.

Preparation

- [32]

- Load a cassette tape in deck B.
- Select the tape transport direction (◀ or ▶).
- Select "←→", "→→" (two-side recording).
- Select the Dolby NR mode.
- Select the "CD" input.
- Insert disc(s) in the CD player.

In case the order of tracks on CD is to be edited

- 1 Perform the editing steps of program or timed edit recording.

Program editing
Timed editing

- [38]
- [40]

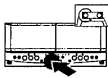

- 2 Start edit recording.



- After the editing operation, do not press the CCRS key, but return to this page and go to step 2. If the CCRS key is pressed after editing, the corresponding edit recording will start in place of cross-fade recording.

- The recording level and bias will be adjusted automatically in approx. 90 seconds (variable depending on CD contents), after which recording starts.

In case the CD tracks are to be recorded in the order they are recorded on CDs

- 1 Select the disc to be recorded.

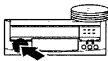

- 2 Start edit recording.

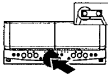

- The recording level and bias will be adjusted automatically in approx. 90 seconds (variable depending on CD contents), after which recording starts.

Notes



1. If a CD track which has already been faded in or out is recorded by cross-fade recording, the space between the adjacent tune may become very long.
2. When the timed edit and cross-fade edit recording are combined, the spaces at the two extremities of A and B increase for the amount the space is increased due to cross-fading.



Timed edit recording

By specifying the recording time of the tape used, CD tracks can be recorded with their order automatically changed so that no tune is interrupted at the end of tape sides A and B.

Preparation

- Load a cassette tape in deck B.
- Select the tape transport direction (◀ or ▶).
- Select "↔", "↔" (two-side recording).
- Select the Dolby NR mode.
- Select the "CD" input.
- Insert disc(s) in the CD player.

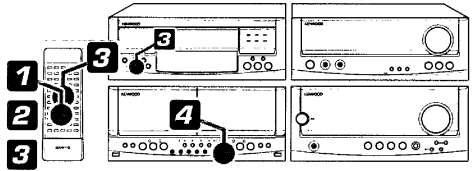

1 Press so that the "PGM" indicator goes off.



Should be OFF.

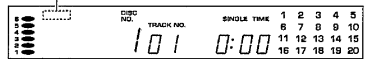

2 Light the "EDIT" indicator.

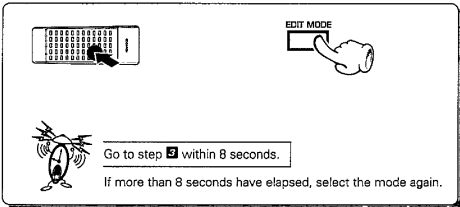

Each press switches the edit modes as follows.

- ① EDIT
 - ② AI EDIT
- Lights. Press so that the "EDIT" indicator lights.

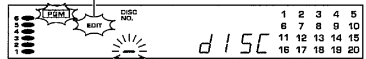

- To use the auto-space function, press the **SPACE** key after having pressed the **EDIT MODE** key and go to step 3. To cancel the auto-space function, press the **P.MODE** key and restart the recording procedure from the beginning.

3 Enter the disc and tape conditions.

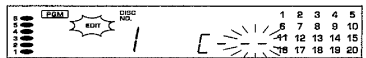
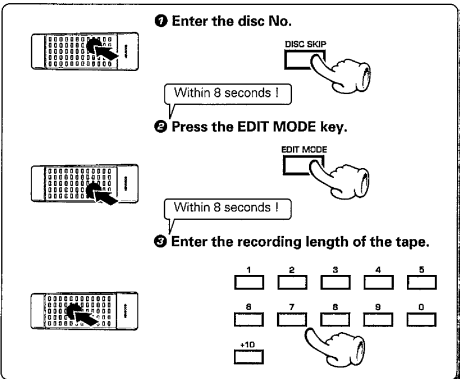

Press the numeric keys as shown below.

- 30-minute tape : **+10 +10 +10 0**
- 46-minute tape : **+10 +10 +10 +10 +10 6**

46-, 54-, 60- or 90-minute tapes can be selected simply by pressing the **TIME** key for the required number of times. (The recording time can be adjusted in 1-minute steps with the ◀ and ▶ keys.) After entry, press the **EDIT MODE** key then proceed to step 4.

- Up to 32 tracks can be edited.
- CD tracks will be edited automatically onto tape sides A and B. After editing, the "EDIT" indicator stops blinking and starts to light steadily.

4 Start edit recording.

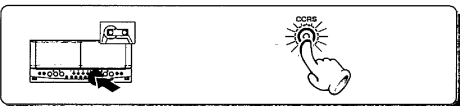

- The recording level and bias will be adjusted automatically in approx. 90 seconds (variable depending on CD contents), after which recording starts.
- The tape and CD stop automatically when recording has completed.

In case the recording time of tape is shorter than the playing time of the CD to be recorded, all of CD tracks can be accommodated by fading out the ending parts.

Preparation



- Load a cassette tape in deck B.
- Select the tape transport direction (◀ or ▶).
- Select "C", "D" (two-side recording).
- Select the Dolby NR mode.
- Select the "CD" input.
- Insert disc(s) in the CD player.

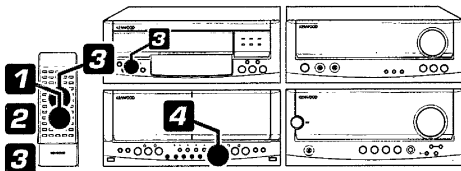

1 Press so that the "PGM" indicator goes off.

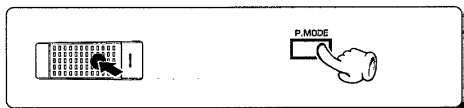

2 Light the "AI EDIT" indicator.

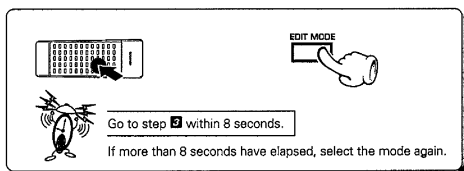

3 Enter the disc and tape conditions.

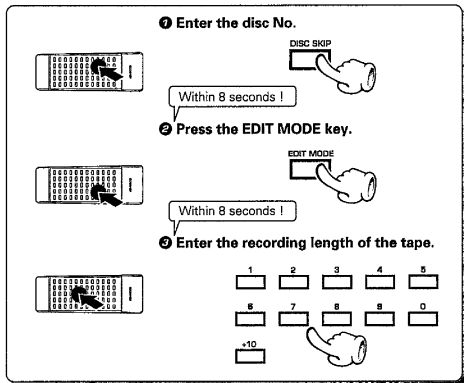

4 Start edit recording.

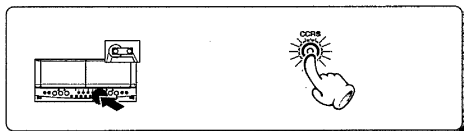

When you repeat AI edit recording (CCRS), be sure to start from step 1.

Should be OFF.

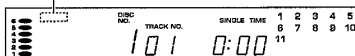

Each press switches the edit modes as follows.

- 1 EDIT
- 2 AI EDIT

Press so that the "AI EDIT" indicator lights.

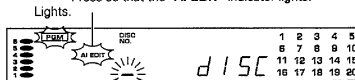

- The SPACE key and REPEAT key are invalid.

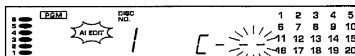

Press the numeric keys as shown below...

- 30-minute tape: **+10 +10 +10 0**
 46-minute tape: **+10 +10 +10 +10 6**



46-, 54-, 60- or 90-minute tapes can be selected simply by pressing the TIME key for the required number of times. (The recording time can be adjusted in 1-minute steps with the ◀ and ▶ keys.)

After entry, press the EDIT MODE key then proceed to step 4.

- CD tracks will be edited automatically onto tape sides A and B. After editing, the "AI EDIT" indicator stops blinking and starts to light steadily.
- If an extremely short time is specified, editing may not occur or the CD tracks programmed for AI priority editing may be faded out.

- The recording level and bias will be adjusted automatically in approx. 90 seconds (variable depending on CD contents), after which recording starts.
- The tape and CD stop automatically when recording has completed.



Fade edit recording

The tune interrupted at the end of tape side A is faded out and side B starts with fading in from the middle of that tune. The tune interrupted at the end of tape side B is simply faded out.

Preparation

- Load a cassette tape in the deck B.
- Select the tape transport direction (◀ or ▶).
- Select "◀", "▶" (two-side recording).
- Select the Dolby NR mode.
- Select the "CD" input.
- Insert a disc(s) in the CD player.

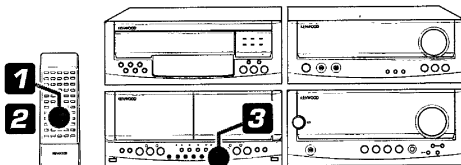

1 Press so that the "PGM" indicator goes off.

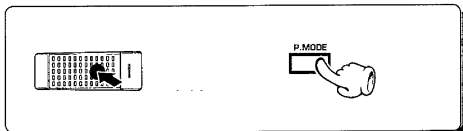

Should be OFF.

DISC NO.	TRACK NO.	SINGLE TIME	1	2	3	4	5
101		0:00	6	7	8	9	10
			11	12	13	14	15
			16	17	18	19	20

2 Select the disc.

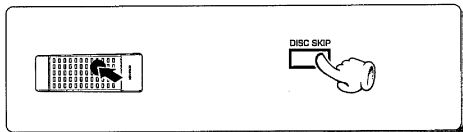

Selected disc No.

DISC NO.	TRACK NO.	SINGLE TIME	1	2	3	4	5
101		0:00	6	7	8	9	10

3 Start edit recording.

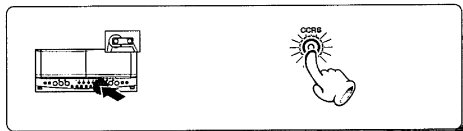

- The recording level and bias will be adjusted automatically in approx. 90 seconds (variable depending on CD contents), after which recording starts.
- The CD tracks are recorded in the order they are recorded on the CD.
- The tape and CD stop automatically when recording has completed.

Notes



1. When the **CCRS** key is pressed during playback of CD, the playback stops and the CCRS setting (preparing edited recording) starts.
2. The automatic recording level setting operation in the edit recording utilizes a section suitable for this purpose in the CD present in the CD player.
3. Edit recording is not possible with CDs containing a track that is longer than one tape side, which may occur with classical music, etc.
4. If the deck is set for one-side recording (◀), the processing at the tape end is applied only on side A.
5. When the last tune of tape side B is faded out, the ending part of the last but one tune may sometimes be faded out if the space between it and the last tune is short.

To check the edited contents Remote control unit only

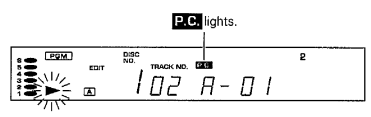
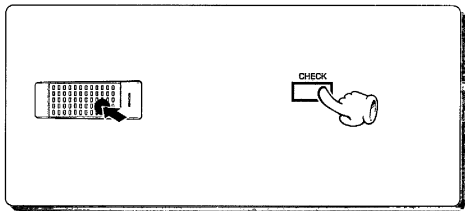

- Each time the key is pressed, the edited CD track Nos. are displayed in order.
- The "P.C." indicator goes off in a few seconds.

To clear the edited contents

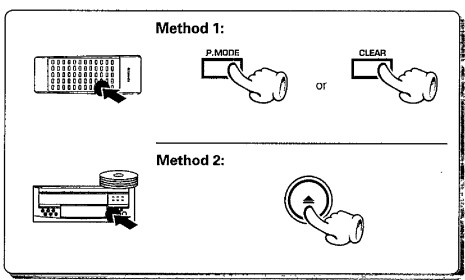

- The edited data is cleared entirely.



Tone adjustment



The system allows you to select 4 kinds of graphic equalizer patterns and 4 kinds of presence (sound field) modes. Select graphic equalizer patterns according to the genre of music and select the presence modes according to the acoustic ambience required. - 46

Demonstration

This feature applies various tone adjustment effects of the graphic equalizer and presence sound fields in sequence with the sound. The display also changes as the applied effects change. Check out the tone adjustment effects both visually and aurally.

The graphic equalizer and presence effects are demonstrated audibly.

① Play some music.

② Select DEMO.

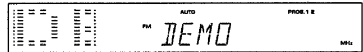

Display characters scroll from the right to the left.

Each press of the key switches the demonstration modes as follows.

- ① DEMO
- ② OFF Frequency display (demonstration OFF)

Note Demonstration also starts automatically when the power plug is unplugged then plugged while the power is ON or when the power supply has recovered from a failure.



Playing music with the desired tone

The graphic equalizer patterns can be selected according to the genre of music played.

1 Play the desired music.

2 Select the music category.

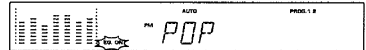
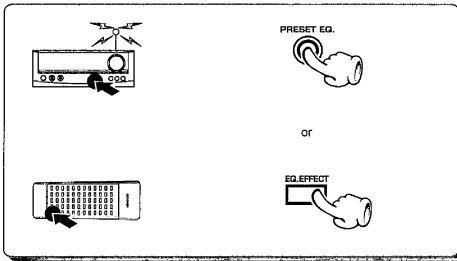

Lights. Display characters scroll from the right to the left.

- Select the category according to the genre or contents of the music played.

Select by pressing repeatedly.

- ① *POP* (Popular)
- ② *ROCK* (Rock)
- ③ *JAZZ* (Jazz)
- ④ *CLASSIC* (Classic)
- ⑤ *EQ OFF* (Equalizer OFF)

Enjoying music with the presence effect (presence modes)

The presence (sound field) mode can be selected according to the music played and to your liking.

1 Play a desired music.

2 Select a presence sound field.

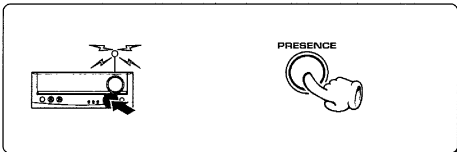

Lights.

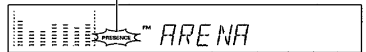

- Select the category according to the genre or contents of the music played.

Select by pressing repeatedly.

- ① *ARENA*
 Reproduction of a live feeling as if the listener is in the first row of the arena seat.
- ② *JAZZ CLUB*
 Reproduction of a jazz live house where cymbals resound.
- ③ *STADIUM*
 Reproduction of an open atmosphere with little reverberations which are usually reflected from the ceiling.
- ④ *HIT MASTER* (Vocal canceller)
 For use in Karaoke singing.
- ⑤ *PRESENCE OFF* (Presence OFF)

Easy Karaoke singing (HIT MASTER)

UD-553 (En)

46

To apply echo to the microphone

(Except for U.S.A., Canada, Europe, U.K., and Australia)

DIGITAL ECHO



- ① ECHO 1 : Light echo effect.
- ② ECHO 2 : Strong echo effect.
- ③ ECHO OFF

Lights.

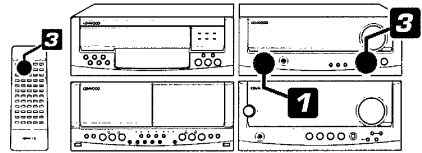
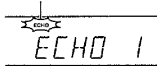

1 Connect a microphone.

- ① Turn the MIC MIXING control fully counterclockwise.

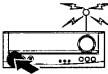

- ② Plug the microphone into the MIC jack.

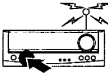

- ③ Adjust the volume balance between the music input and microphone input.

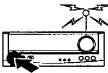

To decrease microphone volume



To increase microphone volume

- Use a microphone equipped with a mini-plug.

- Set the MIC MIXING control to the fully counterclockwise position when the microphone is not used.

2 Play the music.

3 Select HIT MASTER.

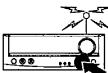

PRESENCE



Select by pressing repeatedly.

- ① ARENA
- ② JAZZ CLUB
- ③ STADIUM
- ④ HIT MASTER
- ⑤ PRESENCE OFF (Presence OFF)

Lights.

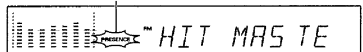

Display characters flow from the right to the left.

- The volume of the vocal parts of the song decreases. However, this effect may not be clear with some songs and discs.

4 Sing along with the accompaniment.

- ① Perform the procedure above until step 3.

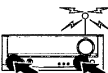

- ② Start recording.



During Karaoke singing using the song recorded on a tape, the Karaoke sound cannot be recorded.



A Karaoke tape can be created by recording the performance while the MIC MIXING control is in the fully counterclockwise position.





Timer operation

Adjust the clock before setting the timer.

UD-553 (En)

48

Two 24-hour timer systems (PROG.1, PROG.2) (which can be used every day) and a sleep timer system (which works only once) are available.

In each of PROG.1 and PROG.2, the timer data including the operating period and played contents can be set and selected to be activated or not as required.



Timer reservation is possible for the two types PROG.1 and PROG.2 at the same time.

- Please make reservations with an interval of at least one minute, so that the operation times of PROG.1 and PROG.2 do not overlap.

Timer playback, timer recording (PROG.1, PROG.2)

With each of the two timer programs, a selected source can be played (or radio broadcast can be recorded) in the previously set time period.

AI timer playback (PROG.1, PROG.2)

When timer playback starts, the volume increases gradually.

Sleep timer

The power is turned OFF automatically after the specified period has elapsed. - [31]

Timer programming

1 Make preparations for the play (recording).

● To listen to radio

The station should be preset before timer programming. - [31]

● To listen to CD

Insert a disc.
(Program playback is not possible.)

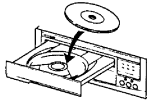

The CD must be loaded in disc bank No. 1; otherwise timer playback will not be possible.

● To listen to tape

Insert a tape.



If tapes are inserted in both decks A and B, playback starts with the tape in deck B.

● Playing the auxiliary input source

Set the timer for the component connected to the input jacks such as MD.

● For broadcast recordings

Make preparations for recording. - [32]

2 Adjust the listening volume.

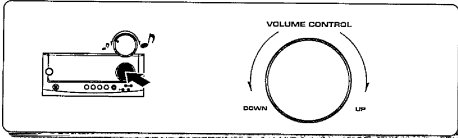

- When recording a broadcast, the listening volume is automatically set to the minimum at the moment the power is turned ON by the timer.

3 Set the POWER switch to OFF (STANDBY) position.

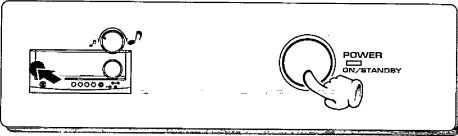

4 Select a program No.

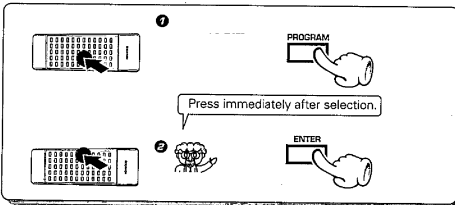

- The selected program No. lights.
- If a program No. under which a timer program has already been reserved, it is replaced by the new timer program.

Each press of the key switches the program numbers as follows.

- ① PROG.1 (Program 1)
- ② PROG.2 (Program 2)
- ③ Normal operation



5 Enter the ON time.

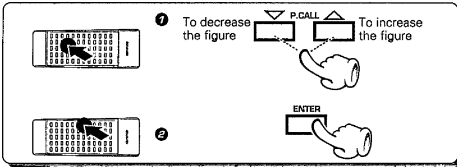

- After entering the figure of "hour" with the procedure in 1 and 2, enter the figure of "minute" using the same procedure.

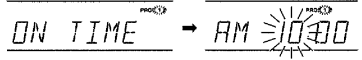

- If you make a mistake, restart from step 1.

6 Enter the OFF time.

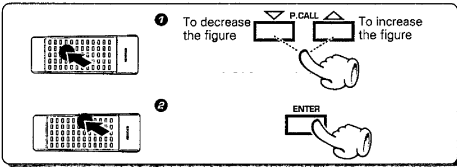

- After entering the figure of "hour" with the procedure in 1 and 2, enter the figure of "minute" using the same procedure.

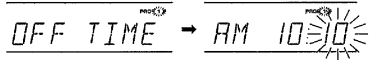

- If you make a mistake, restart from step 1.

7 Make the desired reservation.

For timer playback or AI timer playback

1 Select the mode.

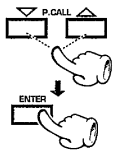

Select "PLAY" or "AI PLAY".
(Each press alternates them.)

PLAY : At the ON time, playback starts.
AI PLAY : At the ON time, playback starts and its volume increases gradually.

REC
Enter it.

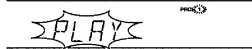

2 Select the input source.

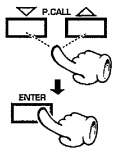

Select the source to be played.
(Each press switches the following).

TUNER
TAPE
MD/AUX
CI

Enter it.

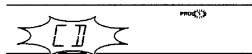

3 Select the broadcast station (only when TUNER is selected above).

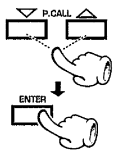

Select the preset station No.

Enter it.

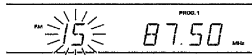

- The station to be received with timer must be preset beforehand.

Timer recording of broadcasts

1 Select the mode.

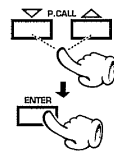

Select "REC".

PLAY
AI PLAY
REC
(Each press alternates them.)

Enter it.

2 Select the broadcast station (only when TUNER is selected above).

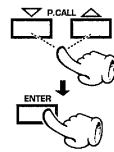

Select the preset station No.

Enter it.

8 Select the timer program No. to be used.

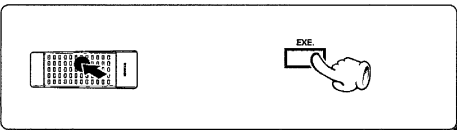

Each press of the key switches the program numbers as follows.

- PROG. 1** Execution of program 1 only.
- PROG. 2** Execution of program 2 only.
- PROG. 1 2** Execution of programs 1 and 2.
- Timer OFF

- The selected program No. lights.
- The timer will not function unless a program No. is selected.



Ensure that the power is OFF

Check the reservation content.

Select the program number to be checked.



Each press of the key switches the program numbers as follows.

- **PROG. 1** (Contents of the program 1 are displayed.)
- **PROG. 2** (Contents of the program 2 are displayed.)
- Normal mode

• The reserved contents will be displayed for 3 seconds per item. After this, the previous display content appears again.

To change the reserved contents

Restart the procedure of "Timer programming" from the beginning. - 49

When timer operation is not required

Press so that all PROG. indicators are OFF.



Each press of the key switches the program numbers as follows.

- **PROG. 1** (Only the program 1 is carried out.)
- **PROG. 2** (Only the program 2 is carried out.)
- **PROG. 1 2** (Both programs 1 and 2 are carried out.)
- Timer OFF (No timer operation is carried out.)

• The reservation contents are held in memory.

To set the same timer program again

Press so that the desired PROG. indicators lights.



Each press of the key switches the program numbers as follows.

- **PROG. 1** (Only the program 1 is carried out.)
- **PROG. 2** (Only the program 2 is carried out.)
- **PROG. 1 2** (Both programs 1 and 2 are carried out.)
- Timer OFF (No timer operation is carried out.)

• Also prepare the disc or tape and adjust the listening volume.

Note The reservation contents cannot be cleared. The contents are cleared only when they are changed.





Set the number of minutes after which the power is to be turned OFF.

❶ Turn the power ON.



❷ Set the time.



- The power is turned OFF automatically after the set time has elapsed.
- Each press decreases the time by 10 minutes. The maximum time that can be set is 90 minutes.

90→80→70...30→20→10→Cancel→90→80...

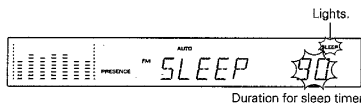

To cancel

Turn the power OFF or press the SLEEP key until the sleep time is cancelled.

Notes on cassette tape

Safety tab (accidental erasure prevention tab)

After an important recording has been finished, break the safety tab, to prevent the recorded contents from being erased or recorded on accidentally.

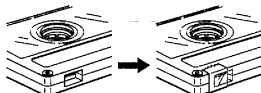
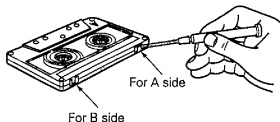

To re-record Apply tape only to the position where the tab has been removed.

To store cassette tapes

Do not store the tapes in a place which is subject to direct sunlight, or near equipment that generates heat. Keep the cassette tapes away from any magnetic field.

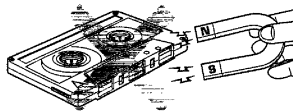

When there is slack in the tape

In such a case, insert a pencil into the reel hole and wind the reel hub to remove the slack.

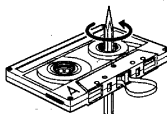

Notes



1. 120-minute cassette tape

Since a 120-minute cassette tape is very thin, the tape could adhere to the pinch roller or be easily broken. It is recommended that these tapes not be used with this unit to prevent possible damage.

2. Endless tapes

Do not use an endless tape, as this could damage the mechanism of the unit.

Cleaning the head section

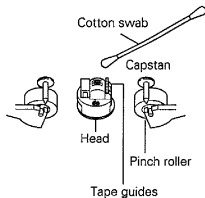

Cleaning the heads and peripheral components

For maintaining the best condition of the deck and for longer service life, always keep the heads (recording / playback / erase), capstan and pinch roller clean. To clean them, perform the following:

1. Open the cassette holder.
2. Using a cotton swab dipped in alcohol, clean the head (recording / playback / erase), capstan and pinch roller carefully.

Demagnetizing the head

When the recording / playback head is magnetized, the sound quality will deteriorate. In such a case, demagnetize the head using a commercially available demagnetizer (head eraser).

Note



There are precisely aligned parts around the heads, including the tape guides. When cleaning, pay special attention so as not to apply shock to them.

Beware of condensation

When water vapor comes into contact with the surface of a cold material, condensation is produced.

If condensation occurs, correct operation may not be possible, or the unit may not function correctly.

This is not a malfunction, however, and the unit should be dried-out. (To do this, turn the POWER switch ON and leave the unit as it is for several hours.)

Be especially careful in the following conditions:

- When the unit is brought from a cold place to a warm place, and there is a large temperature difference.
- When a heater starts operating.
- When the unit is brought from an air-conditioned place to a place of high temperature with high humidity.
- When there is a large difference between the internal temperature of the unit and the ambient temperature, or in conditions where condensation occurs easily.

Disc handling precautions

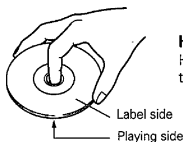

Handling

Hold compact discs so that you do not touch the playing surface.

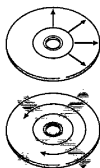

Cleaning

If fingerprints or foreign matter become attached to the disc, lightly wipe the disc with a soft cotton cloth (or similar) from the center of the disc outwards in a radial manner.

Caution on disc used



Storage

When a disc is not to be played for a long period of time, remove it from the CD player and store it in its case.

Never play cracked or warped disc.

During playback, the disc rotates at high speed in the player. Therefore, to avoid malfunction, never use a cracked or deformed disc or a disc repaired with tape or adhesive agent.

Discs which can be played with this unit

CD (12 cm, 8 cm), CDV (only the audio part)

- With CD-G (CD Graphics) discs, this unit can play only the audio.

Dolby noise reduction and HX Pro headroom extension manufactured under license form Dolby Laboratories Licensing Corporation. HX Pro originated by Bang & Olufsen.

"DOLBY" and the double-D symbol and "HX PRO" are trademarks of Dolby Laboratories Licensing Corporation.

WARNING NOTICE:

IN MOST CASES IT IS AN INFRINGEMENT OF COPYRIGHT TO MAKE COPIES OF TAPES OR DISCS WITHOUT THE PERMISSION OF THE COPYRIGHT OWNERS. ANYONE WISHING TO COPY COMMERCIALY AVAILABLE TAPES OR DISC SHOULD CONTACT THE MECHANICAL COPYRIGHT PROTECTION SOCIETY LIMITED OR THE PERFORMING RIGHTS SOCIETY LIMITED.

When your unit needs to be repaired, bring the entire set (Speakers excluded) to your dealer.

Manufactured under license from Dolby Laboratories Licensing Corporation. Additionally licensed under one or more of the following patents: U.S. numbers 3,959,590; Canadian numbers 1,004,603 and 1,037,877. "DOLBY", "Pro Logic" and the double-D symbol are trademarks of Dolby Laboratories Licensing Corporation.

Memory backup function

Stored contents which are cleared immediately when power plug is unplugged from power outlet

Clock display
POWER status (ON or OFF)

Stored contents which are cleared in at least 1 day after power plug is unplugged from power outlet

Tuner unit
Receiving band
Frequency
Preset stations
Program settings
Cassette deck unit
Transport direction
DOLBY NR
Reverse mode

Note related to transportation and movement (CD player)

Before transporting or moving this unit, carry out the following operations.

1. Turn the power ON but do not load a disc.
• Press the ►/II key to check that no disc is present on the tray.
2. Wait a few seconds and verify that the display shown appears.

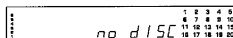

3. Turn the power OFF.

54

Operation to reset

The microcomputer may fall into malfunction (impossibility to operate erroneous display, etc.) when the power cord is unplugged while power is ON or due to an external factor. In this case, execute the following procedure to reset the microcomputer and return it to normal condition.

Amplifier unit : Unplug the power cord from the power socket and, while holding the **POWER** key, plug the power cord into the socket again.

Tuner unit : Unplug the power cord from the power socket and, while holding the **AUTO** key, plug the power cord into the socket again.

● Please note that resetting the microcomputer clears the contents stored in it returns it to the condition when it left the factory.

Amplifier unit, speakers

Symptom	Cause	Remedy
Sound is not produced.	<ul style="list-style-type: none"> ● The speaker cords are disconnected. ● The volume control is set to the minimum position. ● The MUTE switch of remote control unit is switched ON. ● The headphone plug is inserted into the jack. ● The system connection cord is disconnected. 	<ul style="list-style-type: none"> ● Connect properly referring to "System connections". ● Adjust to an required volume. - [16] ● Switch MUTE OFF. ● Unplug the headphone plug. ● Check the connection of the system connection cord. - [2]
The character display blinks and sound is not produced.	<ul style="list-style-type: none"> ● The speaker cords are short-circuited. 	<ul style="list-style-type: none"> ● Turn the power OFF, remove the short-circuit and turn the power ON again.
Sound is not produced through headphones.	<ul style="list-style-type: none"> ● The headphone plug is not inserted fully. 	<ul style="list-style-type: none"> ● Insert it into the plug. - [16]
Sound is not produced from the left or right speakers.	<ul style="list-style-type: none"> ● The speaker cords are disconnected. ● The BALANCE is set completely to the left or right channel. 	<ul style="list-style-type: none"> ● Connect properly referring to "Connections". ● Adjust the optimum left and right balance. - [17]

Tuner unit

Symptom	Cause	Remedy
The clock display blinks without changing the figures.	<ul style="list-style-type: none"> ● There was a power failure. ● The power cord was unplugged from the outlet. 	<ul style="list-style-type: none"> ● Adjust the present time again. - [15] ● Adjust the present time again.
Timer operation is not possible.	<ul style="list-style-type: none"> ● The present time has not been adjusted or there was a power failure. ● The timer ON time and OFF time have not been set. ● The timer execution was not set up. 	<ul style="list-style-type: none"> ● Adjust the present time referring to "Clock adjustment". ● Set the timer ON time and OFF time. ● Press the EXE. key to set up the execution. - [49]
Radio stations cannot be received.	<ul style="list-style-type: none"> ● The antennas have not been connected. ● A proper broadcasting band has not been selected. ● The frequency of the station to be received is not tuned. 	<ul style="list-style-type: none"> ● Connect antennas. - [6] ● Select a band. - [32] ● Tune to the frequency of the desired station.
Noise interferes.	<ul style="list-style-type: none"> ● Car ignition noise. ● Influence of an electric appliance. ● A TV set is installed near the system. 	<ul style="list-style-type: none"> ● Install the outdoor antenna in an apart position from the road. ● Switch the suspected electric appliance OFF. ● Install the TV or the system at an increased distance between them.
A station has been preset but it cannot be received by pressing the P.CALL key.	<ul style="list-style-type: none"> ● The frequency of the preset station is not tunable. ● The preset memory has been cleared because the power cord has been unplugged for a long period. 	<ul style="list-style-type: none"> ● Preset stations with tunable frequencies. ● Preset stations again. - [31]
Demonstration starts suddenly.	<ul style="list-style-type: none"> ● The power plug was unplugged from the outlet while the power switch was ON, or there was a power failure. 	<ul style="list-style-type: none"> ● This is not malfunction. Press the DEMO key to cancel the demonstration. - [44]

Cassette deck unit

Symptom	Cause	Remedy
Sound cannot be produced by pressing the play key or no operation occurs even when an operation key is pressed.	<ul style="list-style-type: none"> ● The connections cords are wrong. ● The head is dirty. ● The tape is wound too tight due to irregular winding. ● A nonrecorded tape is played. 	<ul style="list-style-type: none"> ● Connect properly referring to "System Connections". ● Clean the head referring to "Maintenance". - [52] ● Try another tape. ● Play a recorded tape.
No operation occurs even when an operation key is pressed.	<ul style="list-style-type: none"> ● The cassette holder is not closed completely. ● The operation key is pressed immediately after closing the cassette holder. ● The operation key is pressed in less than 4 seconds after turning the power ON. ● A tape is not inserted in the unit. ● The tape is wound too tight due to irregular winding. ● The tape is fully wound to one of the reels. 	<ul style="list-style-type: none"> ● Close the holder completely. ● Press operations keys in more than a few seconds after closing the holder. ● Press operation keys after waiting for more than 4 seconds. ● Insert a tape. ● Try another tape. ● Change the tape transport direction or reverse the tape insertion orientation.
The DPSS malfunctions.	<ul style="list-style-type: none"> ● The tape used is not suitable for DPSS, for example the spaces between tunes may be too short. 	<ul style="list-style-type: none"> ● Refer to "Skip search". - [28]
The CCRS does not function.	<ul style="list-style-type: none"> ● A recordable tape is not present in deck B. ● A disc is not present in the CD player. ● The disc is dirty. 	<ul style="list-style-type: none"> ● Insert a recordable tape in deck B and retry operation. ● Place a disc in the CD player and retry operation. ● Clean the disc, place it in the CD player and try the operation again. - [53]
In dubbing, the tape stops at different moments in decks A and B.	<ul style="list-style-type: none"> ● This is due to the difference in the tape length or characteristics of the mechanisms of two cassette decks. 	<ul style="list-style-type: none"> ● Small time difference does not mean a malfunction.
The cassette holder cannot be opened by pressing the eject key.	<ul style="list-style-type: none"> ● The key is pressed during recording or playback. ● The microcomputer is malfunctioning due to external noise. 	<ul style="list-style-type: none"> ● Press in stop mode. ● Unplug the power cord and plug it again.
Sound is harsh or high frequencies are not reproduced.	<ul style="list-style-type: none"> ● The head is dirty. ● The tape is stretched or shrunk. 	<ul style="list-style-type: none"> ● Clean the head referring to "Maintenance". - [52] ● Try another tape.
Sound is distorted.	<ul style="list-style-type: none"> ● The tape being played was recorded with distorted sound. 	<ul style="list-style-type: none"> ● Try another tape.
Noise is noticeable.	<ul style="list-style-type: none"> ● The tape head is magnetized. ● External noise is induced. ● A tape recorded with Dolby NR ON is played with Dolby NR OFF. 	<ul style="list-style-type: none"> ● Demagnetize the head referring to "Maintenance". ● Install the system at a distance from other electric appliances and TV. ● Set the Dolby NR to on. - [26]
Sound vibrates.	<ul style="list-style-type: none"> ● The capstans or pinch rollers are dirty. ● The tape is wound irregularly. 	<ul style="list-style-type: none"> ● Clean the head referring to "Head maintenance". - [52] ● Wind the tape again by fast forwarding, re-winding or playing from an end to the other.
Recording cannot be started by pressing the record key.	<ul style="list-style-type: none"> ● The recording protect tab of the cassette has been broken. ● The cassette holder is not closed completely. ● The TAPE input is selected. ● The tape is fully wound to one of the reels. 	<ul style="list-style-type: none"> ● Use a cassette with an unbroken recording protect tab or block the hole. ● Close the holder completely. ● Select the source to be recorded with the input selector key. ● Change the tape transport direction of deck B or reverse the tape insertion orientation.
Volume of the recorded track changed.	<ul style="list-style-type: none"> ● MIC MIXING control knob is moved during recording. 	<ul style="list-style-type: none"> ● Fully turn the MIC MIXING control knob to the left.

56 CD player unit

Symptom	Cause	Remedy
A CD is placed in the player but it cannot be played.	<ul style="list-style-type: none"> ● The disc is placed upside down. ● The disc position is displaced. ● The disc is extremely dirty. ● The disc is scratched. ● Dew is condensed on the optics lens. 	<ul style="list-style-type: none"> ● Place the disc properly, with the label side facing upward. ● Place the disc properly. ● Clean the disc referring to "Disc handling precautions". - [52] ● Try another disc. ● Refer to "Beware of condensation" and remove the condensation by evaporation. - [52]
Sound is not produced.	<ul style="list-style-type: none"> ● The disc has not been placed. ● The player is not put to the play mode. ● The disc is extremely dirty. ● The disc is scratched. ● The connection cords are not inserted securely. 	<ul style="list-style-type: none"> ● Place a disc in the CD player. ● Press the ►/II key. ● Clean the disc referring to "Disc handling precautions". - [53] ● Try another disc. ● Connect securely.
Sound skips.	<ul style="list-style-type: none"> ● The disc is dirty. ● The disc is scratched. ● The player is subject to vibration. 	<ul style="list-style-type: none"> ● Clean the disc referring to "Disc handling precautions". - [53] ● Try another disc. ● Install the unit in a place not subject to vibrations.

Remote control unit

Symptom	Cause	Remedy
Remote control operation is not possible.	<ul style="list-style-type: none"> ● Batteries are exhausted. ● The remote control is too far away from the system, the controlling angle is deviated or there is an obstacle in between. ● There is no tape or CD set in the component to be played. ● An attempt is made to play the cassette deck which is recording something. 	<ul style="list-style-type: none"> ● Replace with new batteries. - [14] ● Operate the unit inside the remote controllable range. - [14] ● Set a tape or CD in the component to be played. ● Wait until the recording ends.

Notes



1. Do not use 120-minute tapes, for the tape is too thin and gets easily tangled.
2. Do not use contact cleaners because it could cause a malfunction. Be specially careful not to use contact cleaners containing oil, for they may deform the plastic component.
3. With some tapes, a squeaky noise is produced when the tape is stopped automatically. This is due to the tape protection function, and not a malfunction.

Specifications

UD 553 (En)

Tuner / Amplifier unit (C-F5 / A-F5)

FM Tuner section

Tuning frequency range	87.5 MHz ~ 108 MHz
Sensitivity (IHF)	13.2 dBf (1.2 μ V at 75 Ω)
Signal to noise ratio at 1 kHz	
MONO	75 dB (65 dBf input)
STEREO	68 dB (65 dBf input)
Selectivity (IHF \pm 400 kHz)	50 dB
Stereo separation (IHF at 1 kHz)	40 dB
Frequency response	30 Hz ~ 15 kHz + 0.5 dB, - 3 dB

AM Tuner section

Tuning frequency range	530 kHz ~ 1,700 kHz
Usable sensitivity	12 μ V / (500 μ V / m)
Signal to noise ratio	48 dB

[General]

Dimensions	W : 270 mm (10-5 / 8")
	H : 104 mm (4-1 / 8")
	D : 334 mm (13-1 / 8")
Weight (net)	2.0 kg (4.4 lb)

Amplifier section

Rated power output

60 watts per channel minimum RMS, both channels driven, at 8 Ω from 40 Hz to 20 kHz with no more than 0.4 % total harmonic distortion.

Signal to noise ratio

..... 87 dB (IHF'66)

Input sensitivity / Impedance

MD / AUX

MIC

Output level / Impedance

SUPER WOOFER PRE OUT

[General]

Power consumption	150 W
Dimensions	W : 270 mm (10-5 / 8")
	H : 124 mm (4-7 / 8")
	D : 336 mm (13-1 / 4")
Weight (net)	6.0 kg (13.2 lb)

Note

KENWOOD follows a policy of continuous advancements in development. For this reason specifications may be changed without notice.



Specifications

UD-553 (En)

Cassette deck / CD player unit (X-F7 / DP-MF7)

58

Cassette deck section

Track 4-track, 2-channel stereo
Recording system AC bias system
(Frequency: 105 kHz)

Heads

A deck Playback head 1
B deck Playback / recording head 1
Erasing head 1

Motors

A deck 1
B deck 1

Fast winding time Approx. 110 seconds
(C-60 tape)

Frequency response

Normal tape 80 Hz to 17,000 Hz, ± 3 dB
CrO₂ tape 80 Hz to 18,000 Hz, ± 3 dB
Metal tape 80 Hz to 18,000 Hz, ± 3 dB

Signal to noise ratio

Dolby C NR ON 73 dB (Metal tape)
Dolby B NR ON 66 dB (Metal tape)
Dolby NR OFF 58 dB (Metal tape)

Harmonic distortion Less than 3.2 %
(1 kHz, 3rd H.D., 250 nWb / m, Metal tape)

Wow and flutter 0.09 % (W.R.M.S.)

[General]

Dimensions W: 270 mm (10-5 / 8")
H : 124 mm (4-7 / 8")
D : 305 mm (12")

Weight (net) 2.7 kg (6 lb)

CD player section

Laser Semiconductor laser

Playing rotation 200 rpm ~ 500 rpm (CLV)

Frequency response 8 Hz ~ 20 kHz, ± 1.0 dB

Signal to noise ratio More than 95 dB

Total harmonic distortion
..... Less than 0.007 % (at 1 kHz)

Channel separation More than 88 dB (at 1 kHz)

Wow & Flutter Unmeasurable Limit

[General]

Dimensions W: 270 mm (10-5 / 8")
H : 104 mm (4-1 / 8")
D : 320 mm (12-5 / 8")

Weight (net) 4.0 kg (8.8 lb)

Speakers (LS-F5)

Enclosure Bass-reflex type
Speaker configuration 3-Way system
Woofer 150 mm, cone type
Tweeter 65 mm, cone type
Tweeter 25 mm, Piezo-Electric dome type
Impedance 8 Ω
Maximum input level 100 W
Frequency response 45 Hz ~ 20,000 Hz

[General]

Dimensions W: 215 mm (8-7 / 16")
H : 456 mm (17-15 / 16")
D : 278 mm (10-15 / 16")
Weight (net) 5.9 kg (13 lb) (1 piece)

Note

KENWOOD follows a policy of continuous advancements in development. For this reason specifications may be changed without notice.





For the U.S.A.

Note to CATV system installer:

This reminder is provided to call the CATV system installer's attention to Article 820-40 of the NEC that provides guidelines for proper grounding and, in particular, specifies that the cable ground shall be connected to the grounding system of the building, as close to the point of cable entry as practical.

For the U.S.A.

CAUTION:

Use of controls or adjustments or performance of procedures other than those specified herein may result in hazardous radiation exposure.

In compliance with Federal Regulations, following are reproductions of labels on, or inside the product relating to laser product safety.

**KENWOOD CORPORATION
2967-3, ISHIKAWA-CHO,
HACHIOJI-SHI,
TOKYO, JAPAN**

**KENWOOD CORP. CERTIFIES THIS EQUIPMENT
CONFORMS TO DHHS REGULATIONS NO. 21 CFR
1040. 10, CHAPTER I, SUBCHAPTER J.**

Location: Back Panel

For the U.S.A.

FCC WARNING

This equipment may generate or use radio frequency energy. Changes or modifications to this equipment may cause harmful interference unless the modifications are expressly approved in the instruction manual. The user could lose the authority to operate this equipment if an unauthorized change or modification is made.

NOTE:

This equipment has been tested and found to comply with the limits for a Class B digital device, pursuant to Part 15 of the FCC Rules. These limits are designed to provide reasonable protection against harmful interference in a residential installation. This equipment may cause harmful interference to radio communications, if it is not installed and used in accordance with the instructions. However, there is no guarantee that interference will not occur in a particular installation. If this equipment does cause harmful interference to radio or television reception, which can be determined by turning the equipment off and on, the user is encouraged to try to correct the interference by one or more of the following measures:

- Reorient or relocate the receiving antenna.
- Increase the separation between the equipment and receiver.
- Connect the equipment into an outlet on a circuit different from that to which the receiver is connected.
- Consult the dealer or an experienced radio / TV technician for help.

KENWOOD

Free Manuals Download Website

<http://myh66.com>

<http://usermanuals.us>

<http://www.somanuals.com>

<http://www.4manuals.cc>

<http://www.manual-lib.com>

<http://www.404manual.com>

<http://www.luxmanual.com>

<http://aubethermostatmanual.com>

Golf course search by state

<http://golfingnear.com>

Email search by domain

<http://emailbydomain.com>

Auto manuals search

<http://auto.somanuals.com>

TV manuals search

<http://tv.somanuals.com>