

KENWOOD

UD COMPONENT SYSTEM/COMPACT HI-FI SYSTEM

UD-90

INSTRUCTION MANUAL

KENWOOD CORPORATION



B60-0508-10 (JA) (SD) (K, E, T, M, X, Y) II  
95/12 11 10 9 8 7 6 5 4 3 2 1 94/12

# Introduction

Your choice of this product indicates that you are a devotee to excellence in sound reproduction.

We appreciate your patronage and take pride in the long tradition of quality components that our company represents.

So that you can get the most out of your unit, we suggest that you take the time to read through this manual before you hook up and operate your system. This will acquaint you with operating features and system-connection considerations so that your listening pleasure will be enhanced right from the start. You will notice that in all aspects of planning, engineering, styling, operating convenience and adaptability we have sought to anticipate your needs and desires.

**Keep this manual handy for future reference.**

## For your records

Record the serial number, found on the back of the unit, in the spaces designated on the warranty card, and in the space provided below. Refer to the model and serial numbers whenever you call upon your dealer for information or service on this product.

Model \_\_\_\_\_ Serial Number \_\_\_\_\_

## Unpacking

Unpack the unit carefully and make sure that all accessories are put aside so they will not be lost.

Examine the unit for any possibility of shipping damage. If your unit is damaged or fails to operate, notify your dealer immediately. If your unit was shipped to you directly, notify the shipping company without delay. Only the consignee (the person or company receiving the unit) can file a claim against the carrier for shipping damage.

We recommend that you retain the original carton and packing materials for use should you transport or ship the unit in the future.

### The marking of products using lasers (Except for some areas.)

**CLASS 1  
LASER PRODUCT**

The label is attached to the rear panel and says that the component uses laser beams that have been classified as Class 1. It means that the unit is utilizing laser beams that are of a weaker class. There is no danger of hazardous radiation outside the unit.

## WARNING NOTICE:

IN MOST CASES IT IS AN INFRINGEMENT OF COPYRIGHT TO MAKE COPIES OF TAPES OR DISCS WITHOUT THE PERMISSION OF THE COPYRIGHT OWNERS. ANYONE WISHING TO COPY COMMERCIALY AVAILABLE TAPES OR DISCS SHOULD CONTACT THE MECHANICAL COPYRIGHT PROTECTION SOCIETY LIMITED OR THE PERFORMING RIGHTS SOCIETY LIMITED.

### For the U.S.A.

#### Note to CATV system installer:

This reminder is provided to call the CATV system installer's attention to Article 820 - 40 of the NEC that provides guidelines for proper grounding and, in particular, specifies that the cable ground shall be connected to the grounding system of the building, as close to the point of cable entry as practical.

## Accessories

- AM loop antenna ..... 1
  - FM indoor antenna ..... 1
  - Loop antenna stand .... 1
  - Antenna adaptor (75 Ω/300 Ω) ..... 1 (Except for some areas)
  - Batteries (R06/AA) ..... 2
  - Remote control unit .... 1
  - AC plug adaptor ..... 1 (Except for some areas)
  - Speaker cords ..... Red/Black x 2, Blue/Black x 2
- For the unit with a European AC plug in areas other than Europe.

## Contents

Caution: Read the pages marked  carefully to ensure safe operation.

Introduction.....	2	Operation of graphic equalizer .....	26
▲ Before applying power .....	3	Operation of CD player.....	33
▲ Safety precautions.....	3	Playback operation of cassette decks.....	38
▲ IMPORTANT SAFEGUARDS .....	4	DPSS operation .....	40
Before operation .....	6	Recording operation on cassette deck (Deck B only).....	42
FM DE-EMPHASIS/CHANNEL SPACE switch .....	7	Recording of CD playback (CCRS).....	45
System connections.....	8	Tape dubbing .....	52
Antenna connections.....	9	Simple Karaoke singing entertainment .....	53
Controls and indicators.....	13	Presence effect.....	54
Operation of remote control unit .....	16	Operation with video components .....	61
Listening to sound.....	18	Operation of timer.....	62
Time adjustment.....	19	In case of difficulty.....	70
Audio adjustment.....	20	▲ Specifications .....	74
Reception of radio broadcast.....	22		

**⚠ Caution: Read this page carefully to ensure safe operation.**

## Before applying power

### For the U.S.A. and Canada

#### Important!

Units shipped to the U.S.A. and Canada are designed for operation on 120 volts AC only.

**CAUTION:** TO PREVENT ELECTRIC SHOCK DO NOT USE THE AC PLUG WITH AN EXTENSION CORD, RECEPTACLE OR OTHER OUTLET UNLESS THE BLADES CAN BE FULLY INSERTED TO PREVENT BLADE EXPOSURE.

### For the United Kingdom

#### Important!

Units shipped to the U.K. are designed for operation on 240 volts AC only.

The mains plug must be removed from the wall socket prior to any internal examination.

The wires in this mains lead are coloured in accordance with the following code:

Blue ..... Neutral  
Brown ..... Live

The wires in this mains lead must be connected to the terminals in the plug as follows:

Wire colour	Plug terminal marking
Blue	N or Black
Brown	L or Red

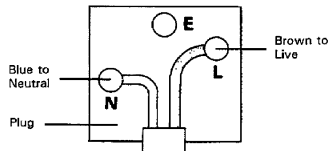

#### Notes:

1. If a 13-amp plug is used, this must be fitted with a 5-amp fuse.
2. If a 3-pin plug with earthing contact is used, no wire must be connected to the E terminal.

### For Australia and Europe

#### Important!

Units shipped to Australia are designed for operation on 240 V AC only.

Units shipped to Europe are designed for operation on 230 V AC only.

### For other countries

#### Important!

Units shipped to countries other than the above countries are equipped with an AC voltage selector switch on the rear panel. Refer to the following paragraph for the proper setting of this switch.

#### AC voltage selection

This unit operates on 110-120 or 220-240 volts AC. The AC voltage selector switch Type A or Type B on the rear panel is set to the voltage that prevails in the area to which the unit is shipped. Before connecting the power cord to your AC outlet, make sure that the setting position of this switch matches your line voltage. If not, it must be set to your voltage in accordance with the following direction.

#### Note:

Our warranty does not cover damage caused by excessive line voltage due to improper setting of the AC voltage selector switch.

#### AC voltage selector switch

##### Type A

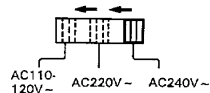

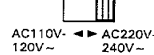

##### Type B



Move switch lever to match your line voltage with a small screwdriver or other pointed tool.

## Safety precautions

**WARNING:** TO PREVENT FIRE OR ELECTRIC SHOCK, DO NOT EXPOSE THIS APPLIANCE TO RAIN OR MOISTURE.

	
	THE LIGHTNING FLASH WITH ARROWHEAD SYMBOL, WITHIN AN EQUILATERAL TRIANGLE, IS INTENDED TO ALERT THE USER TO THE PRESENCE OF UNINSULATED "DANGEROUS VOLTAGE" WITHIN THE PRODUCT'S ENCLOSURE THAT MAY BE OF SUFFICIENT MAGNITUDE TO CONSTITUTE A RISK OF ELECTRIC SHOCK TO PERSONS.
	THE EXCLAMATION POINT WITHIN AN EQUILATERAL TRIANGLE IS INTENDED TO ALERT THE USER TO THE PRESENCE OF IMPORTANT OPERATING AND MAINTENANCE (SERVICING) INSTRUCTIONS IN THE LITERATURE ACCOMPANYING THE APPLIANCE.

## IMPORTANT SAFEGUARDS

**⚠ Caution : Read this page carefully to ensure safe operation.**

Please read all of the safety and operating instructions before operating this unit. For best results, follow all warnings placed on the unit and adhere to the operating and use instructions. These safety and operating instructions should be retained for future reference.

**1. Power sources** — The unit should be connected to a power supply only of the type described in the operating instructions or as marked on the appliance.

**2. Power-cord protection** — Power-supply cords should be routed so that they are not likely to be walked on or pinched by items placed upon or against them, pay particular attention to cords at plugs, convenience receptacles, and the point where they exit from the unit.

Never pull or stretch the cord.



**3. Grounding or polarization** — The precautions should be taken so that the grounding or polarization means of this unit is not defeated.

**4. Ventilation** — The unit should be situated so that its location or position does not interfere with its proper ventilation.

To maintain good ventilation, do not put records or a table-cloth on the unit. Place the unit at least 10 cm away from the walls.

Do not use the unit on a bed, sofa, rug or similar surface that may block the ventilation openings.

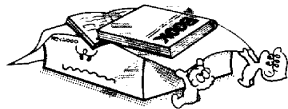

**5. Water and moisture** — The unit should not be used near water — for example, near a bathtub, washbowl, kitchen sink, laundry tub, in a wet basement, or near a swimming pool, etc.

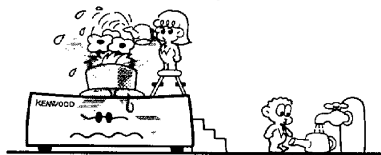

**6. Temperature** — The unit may not function properly if used at extremely low, or freezing temperatures. The ideal ambient temperature is above +5°C (41°F).

**7. Heat** — The unit should be situated away from heat sources such as radiators, heat registers, stoves, or other units (including amplifiers) that produce heat.

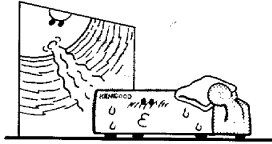

**8. Electric shock** — Care should be taken so that objects do not fall and liquid is not spilled into the enclosure through openings. If a metal object, such as a hair pin or a needle, comes into contact with the inside of this unit, a dangerous electric shock may result. For families with children, never permit children to put anything, especially metal, inside this unit.

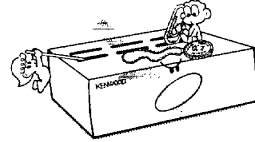

**9. Enclosure removal** — Never remove the enclosure. If the internal parts are touched accidentally, a serious electric shock might occur.

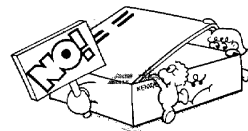

**10. Magnetic fields** — Keep the unit away from sources of magnetic fields such as TV sets, speaker systems, radios, motorized toys or magnetized objects.

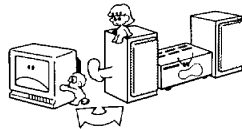

**11. Cleaning** — Do not use volatile solvents such as alcohol, paint thinner, gasoline, or benzene, etc. to clean the cabinet. Use a clean dry cloth.

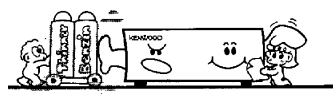

**⚠ Caution : Read this page carefully to ensure safe operation.**

**12. Carts and stands** — An appliance and cart combination should be moved with care. Quick stops, excessive force, and uneven surfaces may cause the appliance and cart combination to overturn.



**13. Nonuse periods** — The power cord of the unit should be unplugged from the outlet when left unused for a long period of time.

**14. Abnormal smell** — If an abnormal smell or smoke is detected, immediately turn the power OFF and pull out the power cord. Contact your dealer or nearest service center.

**POWER OFF!**

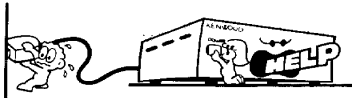

**15. Damage requiring service** — The unit should be serviced by qualified service personnel when:

- A. The power-supply cord or the plug has been damaged; or
- B. Objects have fallen, or liquid has been spilled into the unit; or
- C. The unit has been exposed to rain; or
- D. The unit does not appear to operate normally or exhibits a marked change in performance; or
- E. The unit has been dropped, or the enclosure damaged.

**16. Servicing** — The user should not attempt to service the unit beyond that described in the operating instructions. All other servicing should be referred to qualified service personnel.

**17. Outdoor antenna grounding** — If an outside antenna is connected to the receiver, be sure the antenna system is grounded so as to provide some protection against voltage surges and built up static charges. Section 810 of the National Electrical Code, ANSI/ NFPA No. 70—1984, provides information with respect to proper grounding of the mast and supporting structure, grounding of the lead-in wire to an antenna discharge unit, size of grounding con-

ductors, location of antenna-discharge unit, connection to grounding electrodes, and requirements for the grounding electrode. See Figure.

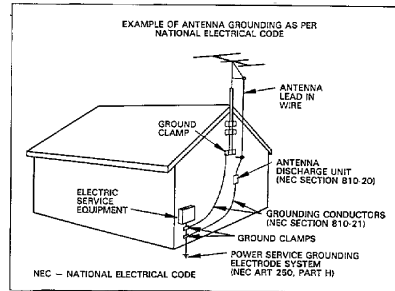

**18. Power lines** — An outdoor antenna should be located away from power lines.

**For the U.S.A.**

**CAUTION:**

Use of controls or adjustments or performance of procedures other than those specified herein may result in hazardous radiation exposure.

In compliance with Federal Regulations, following are reproductions of labels on, or inside the product relating to laser product safety.

KENWOOD CORPORATION  
SHIONOGI SHIBUYA BUILDING 17-5,  
2-CHOME, SHIBUYA, SHIBUYA-KU,  
TOKYO, JAPAN

KENWOOD CORP. CERTIFIES THIS EQUIPMENT  
CONFORMS TO DHHS REGULATIONS NO. 21 CFR  
1040.10, CHAPTER I, SUBCHAPTER J.

Location: Back Panel

**Notes:**

- 1. Item 3 is not required except for grounded or polarized equipment.
- 2. Item 17 and 18 are not required except for units provided with antenna terminals.
- 3. Item 17 complies with UL in the U.S.A.

## Before operation

### ■ Notes on cassette tape

#### ● Safety tab (accidental erasure prevention tab):

After an important recording has been finished, break the safety tab, to prevent the recorded contents from being erased or recorded on accidentally.

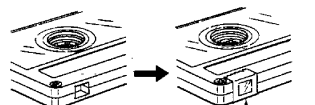
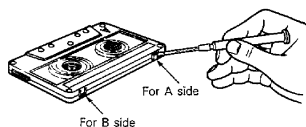

To re-record

Cover with adhesive tape.

#### ● To store cassette tapes:

Do not store the tapes in a place which is subject to direct sunlight, or near equipment that generates heat. Keep the cassette tapes away from any magnetic field.

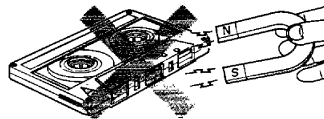

#### ● When there is slack in the tape:

In such a case, insert a pencil into the reel hole and wind the reel hub to remove the slack.

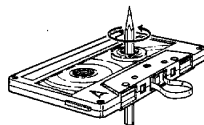

#### Notes:

##### 1. 120-minute cassette tape:

Since a 120-minute cassette tape is very thin, the tape could adhere to the pinch roller or be easily cut. It is recommended that these tapes not be used with this unit to prevent possible damage.

##### 2. Endless tapes:

Do not use an endless tape, as this could damage the mechanism of the unit.

### ■ Cleaning the head section

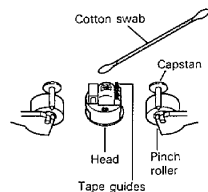

#### Cleaning the heads and peripheral components:

For maintaining the best condition of the deck and for longer service life, always keep the head (recording/playback/erase), capstan and pinch roller clean. To clean them, perform the following:

1. Open the cassette holder.
2. Using a cotton swab dipped in alcohol, clean the head (recording/playback/erase), capstan and pinch roller carefully.

#### Demagnetizing the head

When the recording/playback head is magnetized, the sound quality will be deteriorated. In such a case, demagnetize the head using a commercially available demagnetizer (head eraser).

#### Note:

There are precisely aligned parts around the heads, including the tape guides. When cleaning, pay special attention so as not to apply shock to them.

### ■ Beware of condensation

When water vapor comes into contact with the surface of cold material, water drops are produced.

If condensation occurs, correct operation may not be possible, or the unit may not function correctly.

This is not a malfunction, however, and the unit should be dried. (To do this, turn the POWER switch ON and leave the unit as it is for several hours.)

Be especially careful in the following conditions:

- When the unit is brought from a cold place to a warm place, and there is a large temperature difference.
- When a heater starts operating.
- When the unit is brought from an air-conditioned place to a place of high temperature with high humidity.
- When there is a large difference between the internal temperature of the unit and the ambient temperature, or in conditions where condensation occurs easily.

Dolby noise reduction manufactured under license from Dolby Laboratories Licensing Corporation.  
"DOLBY" and the double-D symbol  are trademarks of Dolby Laboratories Licensing Corporation.

Manufactured under license from Dolby Laboratories Licensing Corporation. Additionally licensed under one or more of the following patents: U.S. numbers 3,632,886, 3,746,792 and 3,959,590; Canadian numbers 1,004,603 and 1,037,877.  
"Dolby" and the double-D symbol  are trademarks of Dolby Laboratories Licensing Corporation.

## ■ Disc handling precautions

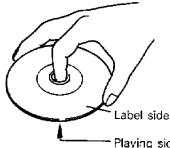

**Handling**  
Hold compact discs so that you do not touch the playing surface.

Do not attach paper or tape to either the playing side or the label side of compact discs.

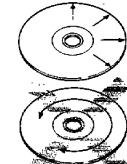

**Cleaning**  
If fingerprints or foreign matter become attached to the disc, lightly wipe the disc with a soft cotton cloth (or similar) from the center of the disc outwards in a radial manner.

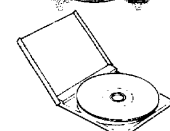

**Storage**  
When a disc is not to be played for a long period of time, remove it from the CD player and store it in its case.

## ■ FM DE-EMPHASIS/CHANNEL SPACE switch (Except for some areas)

The FM DE-EMPHASIS/CHANNEL SPACE switch on the rear panel is set to the correct setting that prevails in the area to which the unit is shipped. However, if the FM DE-EMPHASIS/CHANNEL SPACE setting is not matched to the area where the unit is to be used: for instance, when you moved from area 1 to area 2 or vice versa, desired reception of AM/FM broadcasts is not expected. In this case, change the FM DE-EMPHASIS/CHANNEL SPACE setting in accordance with the area corresponding to the table shown below. The FM DE-EMPHASIS is switched over at the same time.

Area	CHANNEL SPACE freq.	FM DE-EMPHASIS
1. U.S.A, Canada, Hawaii, South american countries	FM: 100 kHz AM: 10 kHz	75 $\mu$ s
2. Other countries	FM: 50 kHz AM: 9 kHz	50 $\mu$ s

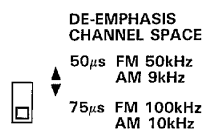

### Note:

When changing the setting of the FM DE-EMPHASIS/CHANNEL SPACE switch, first disconnect the power cord, then reset the channel space switch, connect the power cord again, and turn the power on.

## ■ Memory backup function

Stored contents cleared at least 3 days after the last power OFF (STANDBY mode)	Graphic equalizer (Stored patterns) Cassette deck (Direction and recording level)
Stored contents cleared immediately when power plug is unplugged from power outlet	Clock of receiver
Stored contents cleared in at least 3 days after power plug is unplugged from power outlet	Preset stations of receiver

## ■ Note related to transportation and movement (CD player)

Before transporting or moving this unit, carry out the following operations.

- ① Turn the power ON but do not load a disc.
- ② Wait a few seconds and verify that the display shown appears.
- ③ Turn the power OFF.

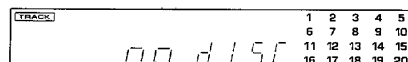

## System connections

Make connection as shown below. When connecting the related system components, refer also to the instruction manuals of the related components.

When connecting the parallel cord, be sure to match the colors of the sockets.

Do not plug in the power lead until all connections are completed.

For details on antenna and speaker connections, see pages 9, 10 and 11, respectively.

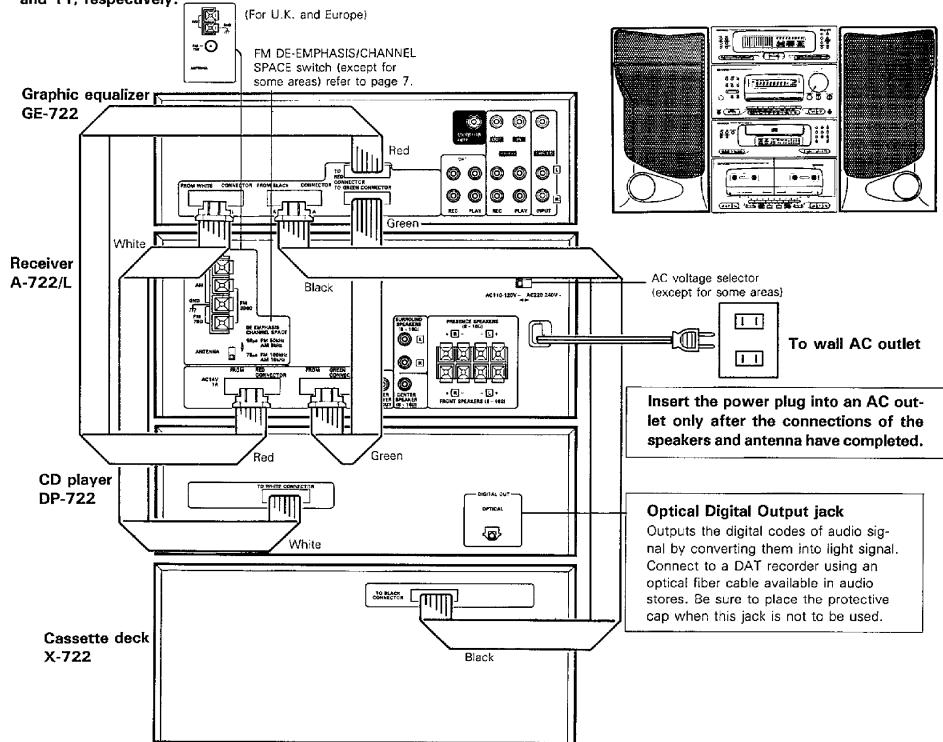

### ■ Connection of parallel cord

- Hold the connector of the parallel cord in parallel with the socket on the rear panel, and insert securely until it clicks.
- Connect the parallel cord by matching the colors of the connector and socket.
- When unplugging the parallel cord, push and hold the two ends of the connector and pull the connector straight from the rear panel socket.

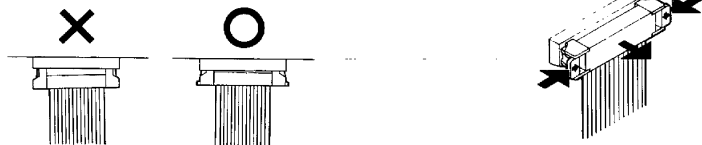

#### Notes:

1. Connect all cords firmly. If connections are loose there could be loss of sound or noise produced.
2. When plugging and unplugging connection cords without removal of the power cord can cause malfunctions or damage to the unit.



## Antenna connections

### Connection method to each antenna terminal

- ① Push lever down.
- ② Insert conductor.
- ③ Return lever up.

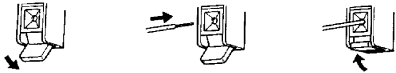

### ■ AM loop antenna connection

The supplied antenna is for indoor use. Place it as far as possible from the main system, TV set, speaker cords and power cord, and set it to a direction which provides the best reception.

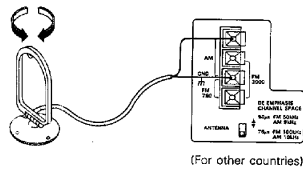
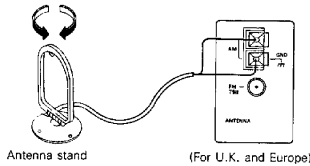

### ■ AM outdoor antenna connection

If the reception is poor when the AM loop antenna is used, distribute a vinyl-coated wire of more than 6 meters outdoors, without disconnecting the loop antenna.

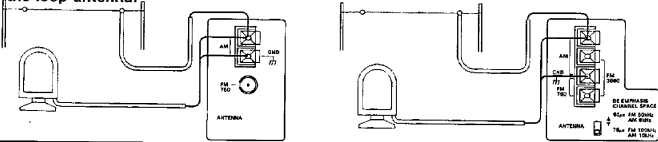

### ■ FM indoor antenna connection

The supplied antenna is for indoor use. For stable reception, remove the indoor antenna after installing an outdoor antenna as soon as possible.

- ① Find the position that provides best reception.
- ② Fix two ends.

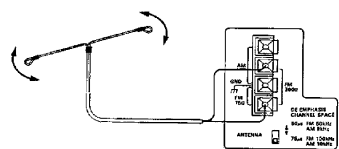
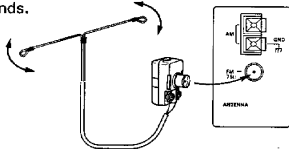

### ■ FM outdoor antenna connection

It is recommended to install an exclusive FM outdoor antenna to capture FM broadcasts with high sound quality. Use a coaxial cable for the connection between the outdoor antenna and FM ANTENNA terminal on the rear panel. For the connection between the coaxial cable and FM ANTENNA terminal, please refer to the illustration.

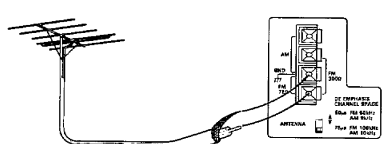
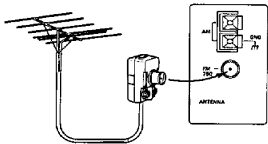

■ 75 Ω coaxial cable connection (Except for some areas)

<p>① Arrange the coaxial cable as illustrated.</p>	<p>② Open the 75 Ω/300 Ω antenna adaptor. Press the claws in the direction of the arrows with the fingers to release the lock and pull out the cover.</p>	<p>③ Detach the ring from the antenna adaptor. Then put the ring on the pole in the cover.</p>
<p>④ Remove the band and insert the inner conductor to the slit.</p>	<p>⑤ Fasten the band with screws, using the screwdriver. Close the cover.</p>	<p>⑥ Connect the adaptor to the antenna terminal.</p>

Note:  
To connect the 300 Ω feeder, attach the ring shown in the figure. If the ring is not attached, the sensitivity decreases.

# Connection of speakers

## ■ Connection of front speakers

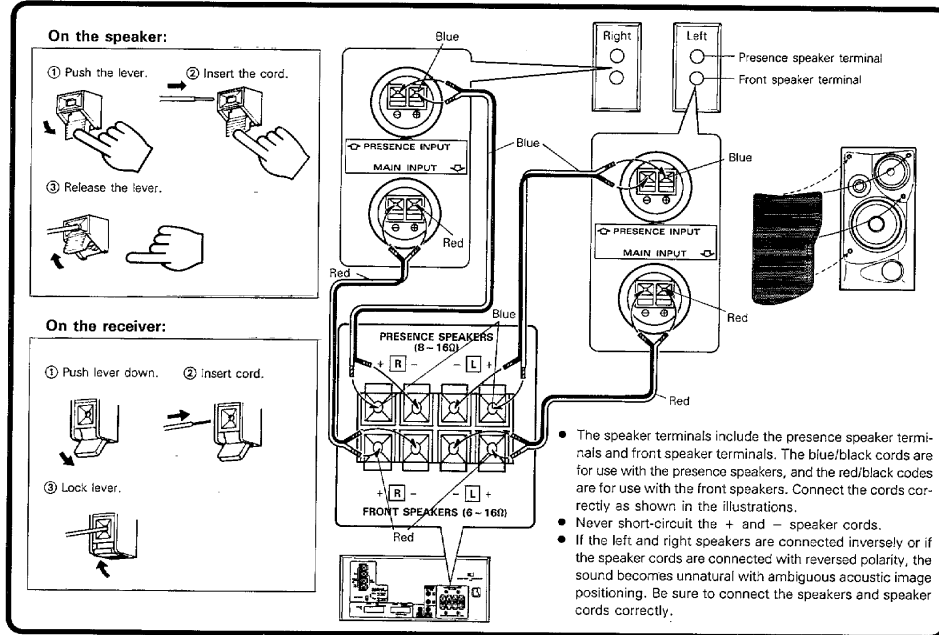

## ■ Connection of surround rear and center speakers

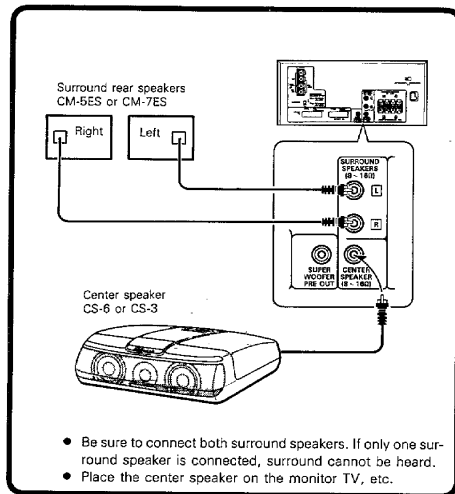

## ■ Connection of super woofer

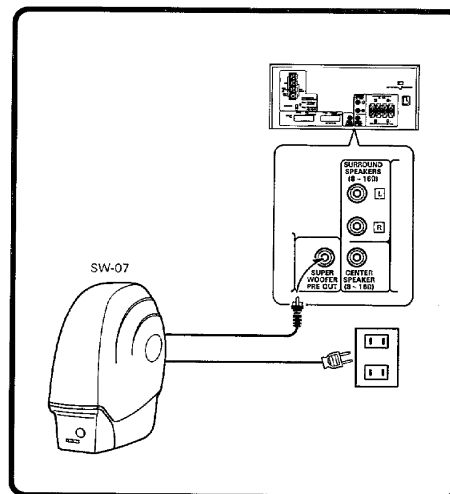

## Connection of Audio/Visual components (optional)

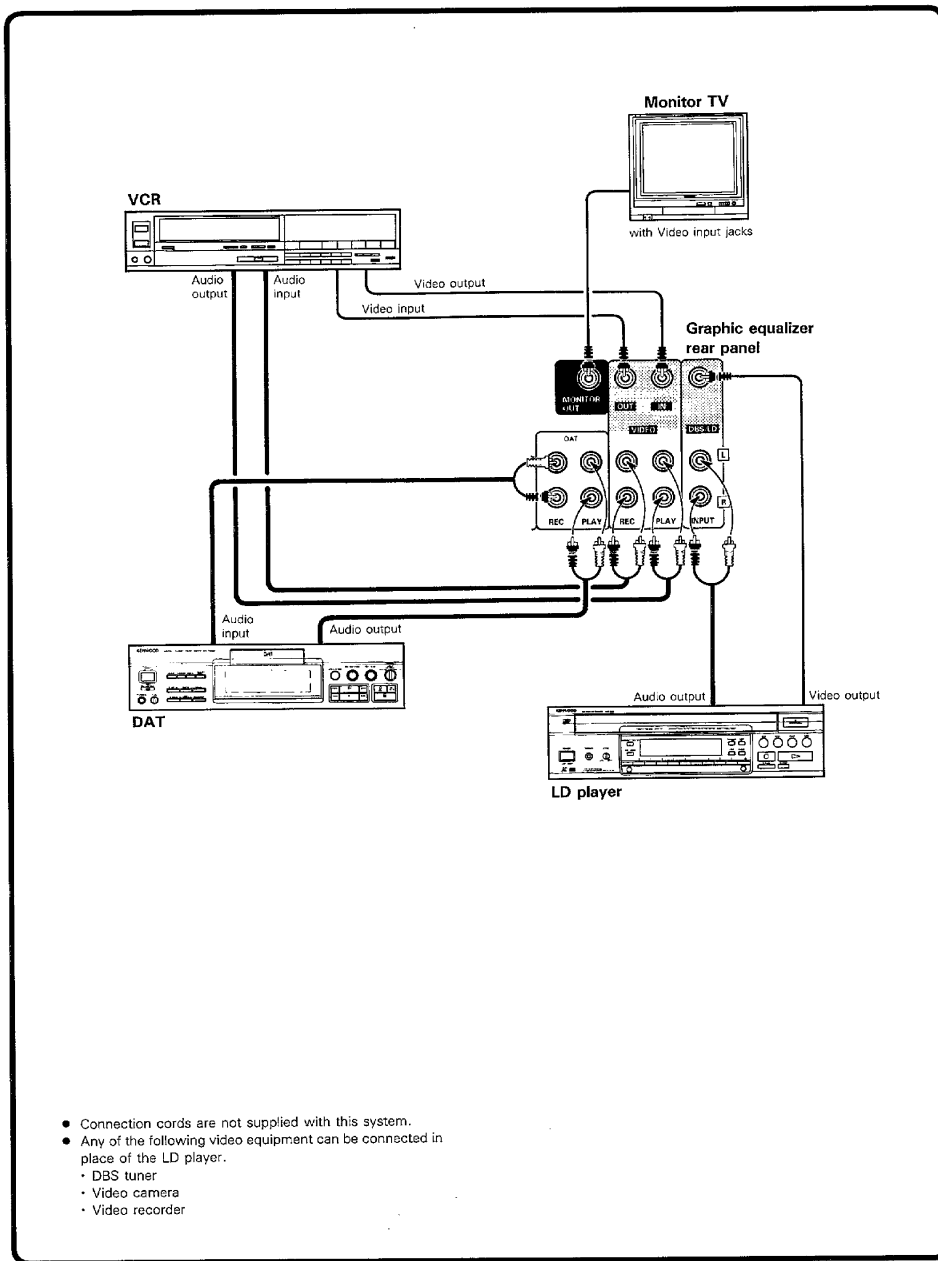

# Controls and indicators

## Receiver

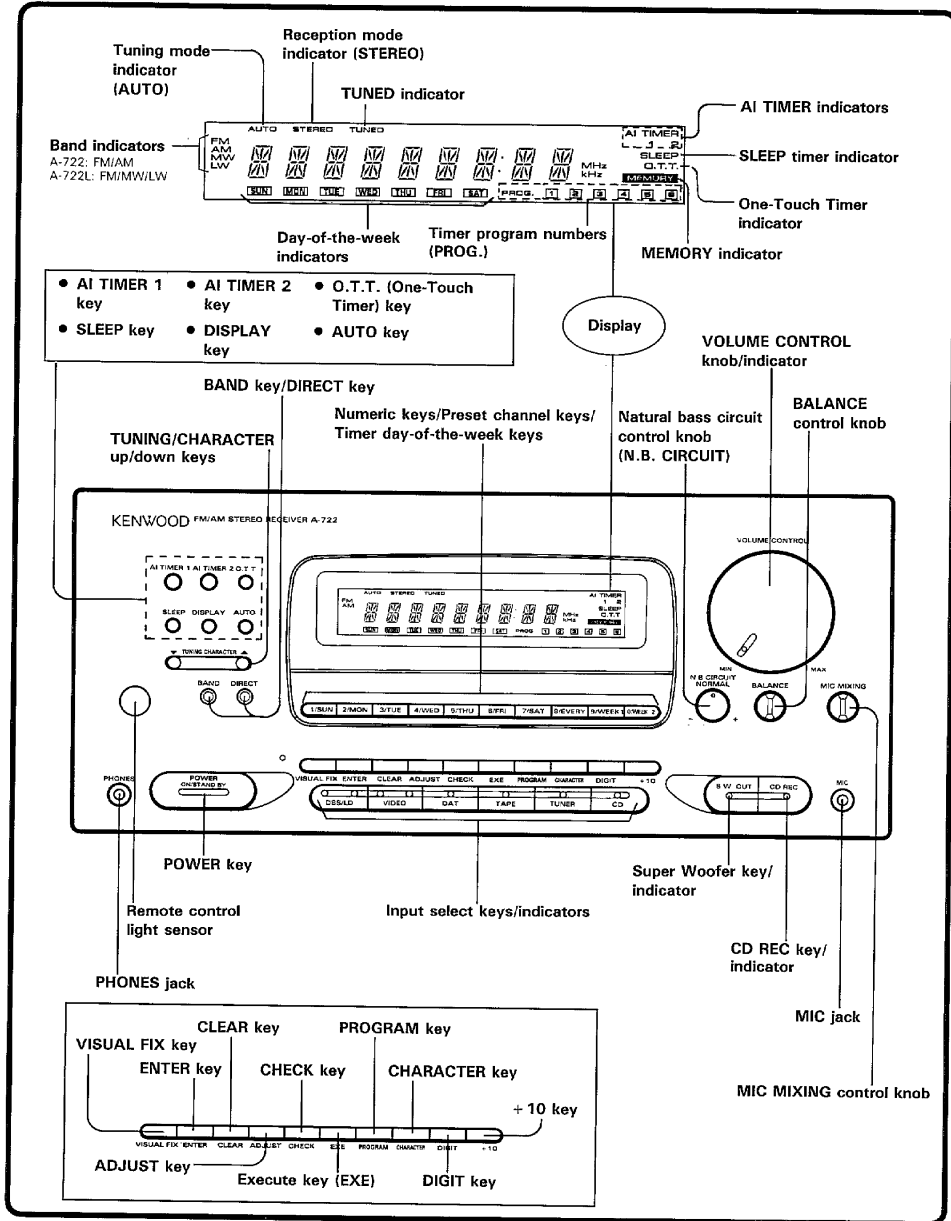

■ Graphic equalizer

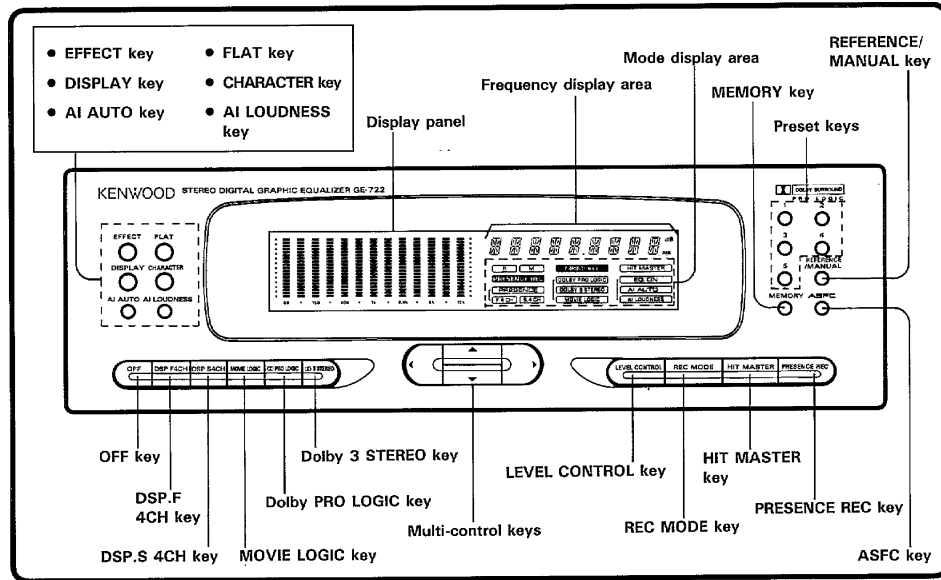

■ CD player

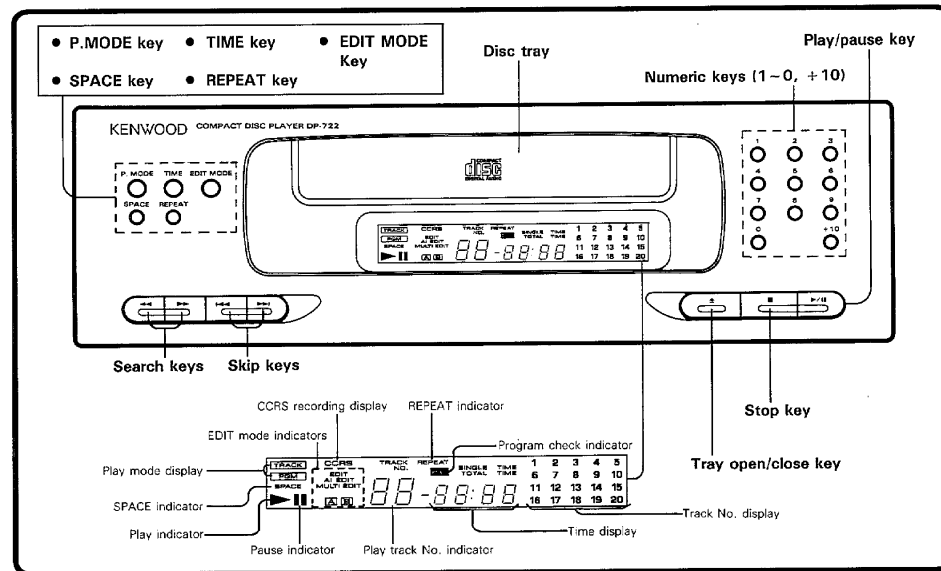

## ■ Cassette deck

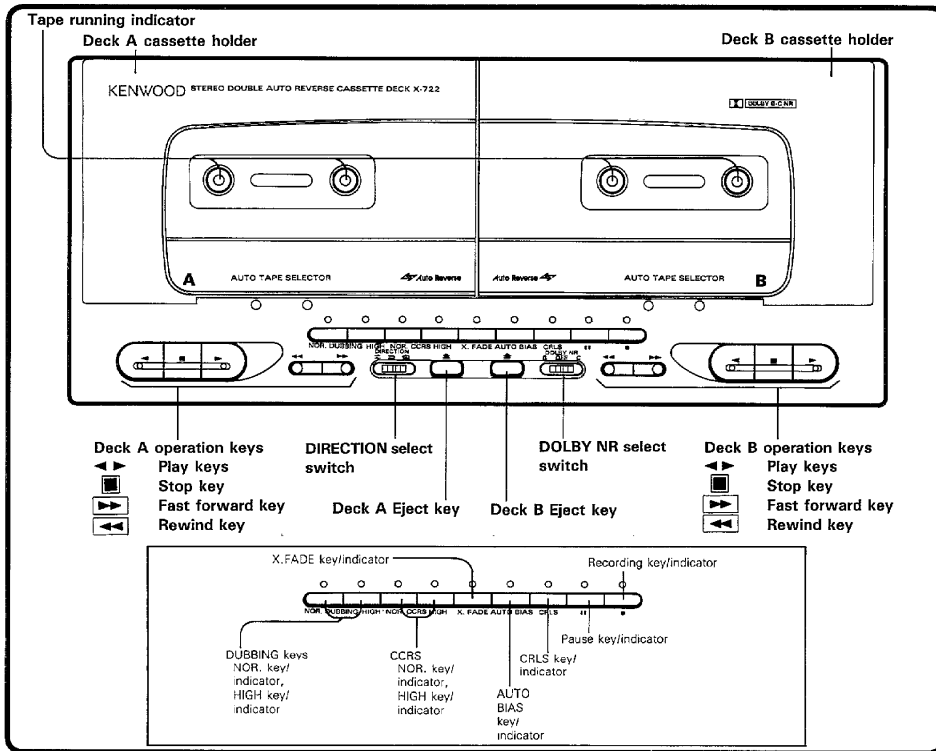

## ■ Speaker

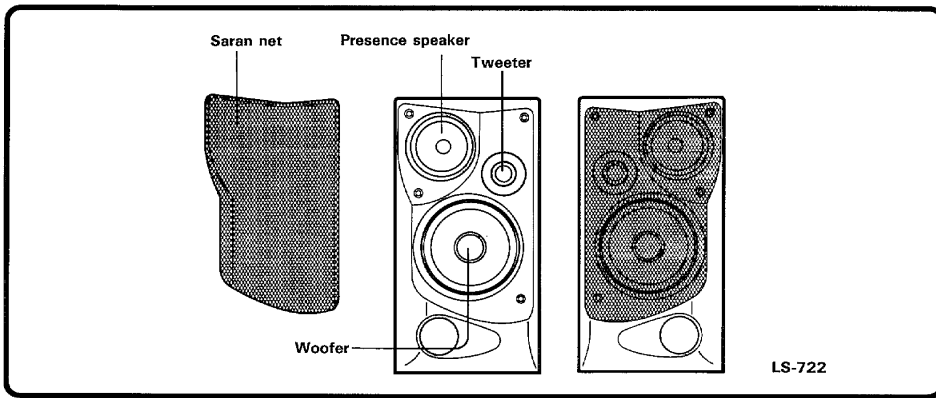

## Operation of remote control unit

### ■ Loading batteries

1 Remove the cover.

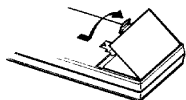

2 Insert batteries.

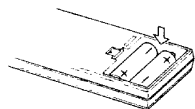

Insert two AA-size (R6/ SUM-3) batteries as indicated by the polarity marking.

3 Close the cover.

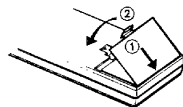

### ■ Operation procedure

Plug the power cord of the system into an AC wall outlet, and press the **[POWER]** key on the remote control unit to turn the power on. When the power is turned on, press the key of the source component to be operated.

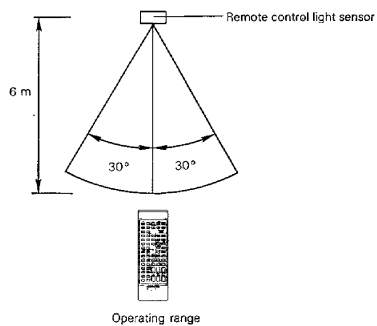

- When two operation keys on the remote control unit are pressed successively, press each key securely reserving an interval of more than 1 second for each press.

#### Notes:

1. The supplied batteries are intended for use in operation checks. Therefore, their lives may be shorter than ordinary batteries.
2. When the remote-controllable distance gets shorter than before, replace both batteries with new ones.
3. Malfunction may occur if direct sunlight or the light of a high-frequency lighting fluorescent lamp enters the remote control light sensor. In such a case, change the system installation position to prevent the malfunction.



### TAPE deck A/B operation keys

Set the A/B switch to "A" when operating deck A. (The functions are indicated in golden letters.)  
 The  key is invalid.)  
 Set the A/B switch to "B" when operating deck B. (The functions are indicated in white letters.)

### CD/TUNER numeric keys

Can be used as the numeric keys for the CD player when the CD input is selected.  
 Can be used as the numeric keys for the TUNER when the TUNER input is selected.

How to enter numbers:

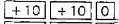
To enter 20 ... 

To enter 23 ... 

### Graphic Equalizer/SUPER WOOFER operation keys

Set the A/B switch to "B" to operate the graphic equalizer. (The functions are indicated in white letters.)

**EFFECT:** Turns the graphic equalizer effect on/off.

**M.CALL (Memory Call):** Recalls a stored pattern from memory.

 : Equalizer adjustment keys



**DISPLAY:** Switches the display contents in sequence.

**CHARACTER:** Switches the display modes in sequence.

**AI AUTO:** Sets a proper equalizer curve for each type of disc.

**AI LOUDNESS:** Automatically compensates for the insufficiencies of lowest and highest frequencies.

Set the A/B switch to "A" to operate the Super woofer. (The functions are indicated in golden letters.)

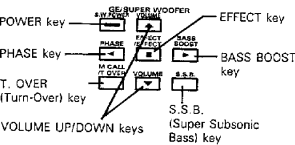

### TUNER operation keys

**P.SCAN (Preset Scan):** Selects preset stations.  
**BAND:** Switches the broadcasting bands.  
**SLEEP:** Sets the sleep timer.  
**O.T.T. (One-Touch Timer):** Sets the One-Touch Timer.

### Remote control function A/B switch

Some remote control keys have two functions, which can be switched over according to purposes

### CD player operation keys

Can be used as the CHECK key and CLEAR key for the CD player operation when the A/B switch is set to "A". (The functions are indicated in golden letters.)

### Presence operation keys

### Input select keys

### MUTE key

Reduces the volume temporarily. The indicator on the VOLUME CONTROL knob blinks while muting is active.

### MASTER VOL. (Volume) control keys

Adjusts the volume. While these keys are operated, the VOLUME CONTROL knob on the main unit rotates and the indicator on it blinks at high speed.

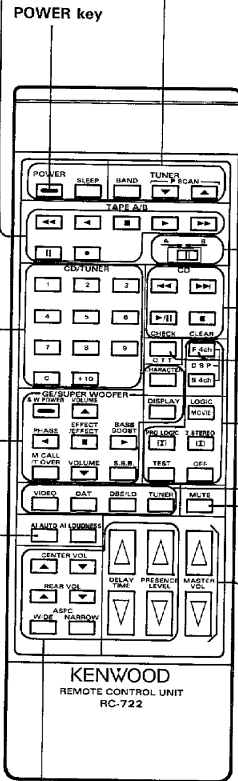



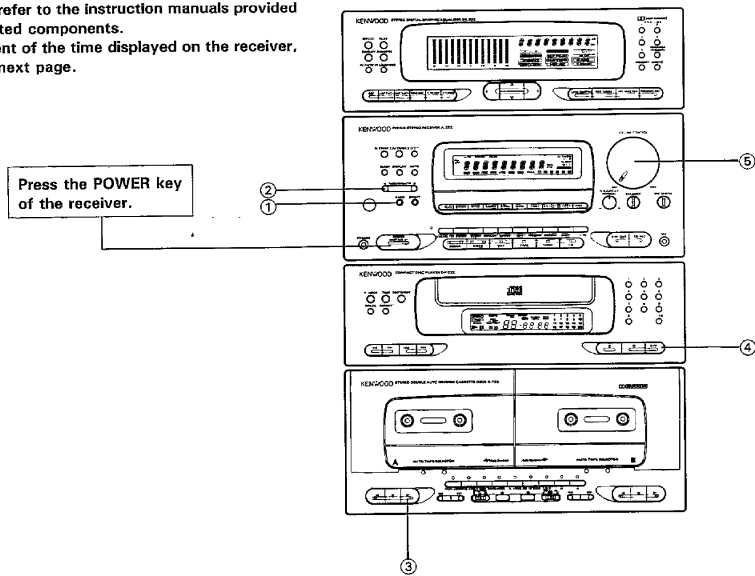

**Presence level operation keys**  
 CENTER VOL. (Volume)  
 REAR VOL. (Volume)  
 ASFC  
 DELAY TIME  
 PRESENCE LEVEL

# Listening to sound

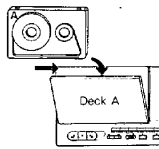
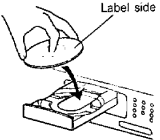
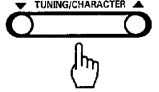
For details, also refer to the instruction manuals provided with the connected components.  
For the adjustment of the time displayed on the receiver, please read the next page.

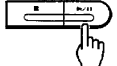

	To listen to a radio broadcast	To listen to a tape	To listen to a CD
<b>1</b>	<p>Select the tuner input. Select a broadcasting band by pressing the BAND key ①.</p> 	<p>Insert a tape in Deck A.</p> 	<p>Place a CD on the tray.</p> 
<b>2</b>	<p>Select a station. Press the TUNING/CHARACTER key ②.</p> 	<p>Play the tape. Press the play key ③.</p> 	<p>Play the CD. Press the play/pause key ④.</p> 
<b>3</b>	<p>Adjust the volume.</p>  <p>• Turn the VOLUME CONTROL ⑤ for an optimum volume.</p>		

Note:  
If sound is not output, check the connections described from page 8 again.

# Time adjustment

The receiver incorporates the clock function. Adjust the clock to the exact time, especially when the timer function is to be used.

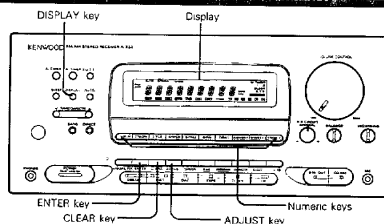

**1** Press the ADJUST key.

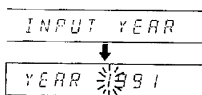

**2** Input the year using the numeric keys, and press the ENTER key.

To input 1992: press **1**, **9**, **9**, **2**.



- If you commit a mistake in the input of numeric keys, press the **CLEAR** key, and re-start the input from the beginning.

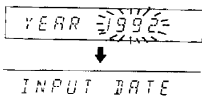

**3** Input the month then the day, and press the ENTER key.

To input March 7: press **0**, **3**, **0**, **7**.

To input December 30: press **1**, **2**, **3**, **0**.



- If you commit a mistake in the input of numeric keys, press the **CLEAR** key, and re-start the input from the beginning.

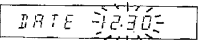
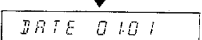

**4** Input the time of the day.

To input 9:05AM: press **0**, **9**, **0**, **5**.

To input 4:50PM: press **1**, **6**, **5**, **0**.

- If you commit a mistake in the input of numeric keys, press the **CLEAR** key, and re-start the input from the beginning.

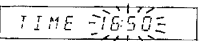
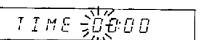

**5** Press the ENTER key.

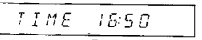

- For correct time adjustment, it is recommended to press the ENTER key at the same time as a time announcement.

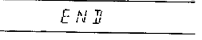

Clock starts to work.

**Note:**

The time display blinks after a power failure or when the power cord was unplugged from the power outlet. In this case, adjust the time again.

**Displayed contents and DISPLAY key**

Every time the DISPLAY key is pressed while a radio station is received, the displayed content is switched to the frequency to the station name, present time, and date (month and day). When a key associated with tuning is pressed while the date or time is being displayed, it is switched to the frequency display, and returns to the previous content in a few seconds. When the DISPLAY key is pressed while the power is OFF, the displayed content is switched alternately between the date and time.

## Audio adjustment

### Press the POWER key of the receiver.



- The POWER key on the receiver can switch on/off the powers of main system.

POWER



Remote control unit

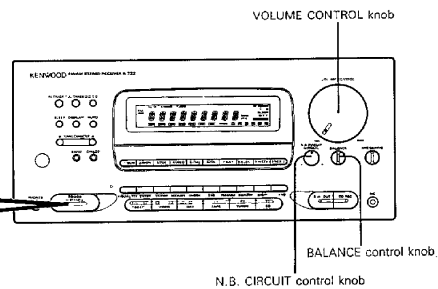

### ■ Adjusting the volume

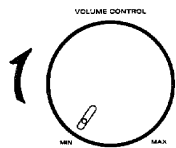

Remote control unit

- When the volume is adjusted from the remote control unit, the point indicator on the VOLUME CONTROL knob blinks and rotates together with the control knob.
- The REAR VOL. and CENTER VOL. controls are used only in surround playback. Refer to "Presence effect" on pages 54 to 60.

### To mute sound temporarily Remote control only



- The VOLUME CONTROL indicator blinks. Pressing the key again resumes the previous volume.

### ■ Adjusting the left and right volume balance



### ■ Compensation of bass sound

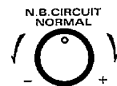

#### N.B.CIRCUIT: Natural Bass Circuit

- Usually set the switch to the NORMAL position.
- Adjust to obtain a more natural bass sound.

### STAND BY mode of POWER key

When the power cord of this system is plugged into an AC power outlet, the display lights up regardless of the ON/OFF setting of the POWER key. This indicates that a small amount of current is being supplied to the unit to back up the memory contents and support the timer function. This mode is referred to as the Stand By mode. While the display is lit, the power of the system can be switched ON/OFF from the remote control unit.

### Automatic play operation function associated with input select keys of receiver

The automatic play operation allows to start playing the selected input source by simply pressing the input select key (TAPE, TUNER, CD). It also allows to select a correct input select key on the receiver by simply starting playback on the desired input source component. The same operation is also possible with the input select keys on the remote control unit.

The input source selected at the moment the power is switched ON is the last source (TUNER, CD, etc.) selected before switching the power OFF.

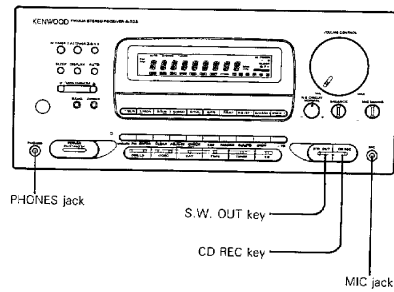

### ■ Listening through headphones

- 1 Insert the headphone stereo mini plug into the headphones jack.

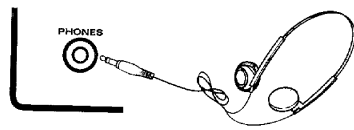

- Sound from all speakers is turned off.

- 2 Adjust the volume.

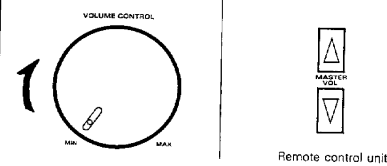

- Be sure to minimize the volume before unplugging the headphone plug.

### ■ Operation of super woofer key

The connection of super woofer, described on page 11, must be completed before proceeding to the following.

- 1 Press the S.W. OUT key.

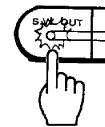

- 2 Adjust the super woofer volume.

Adjust the VOLUME control on the remote control unit or the super woofer.

- Once the super woofer volume is set, it is varied with the same balance with respect to the master volume by varying the VOLUME CONTROL.

#### CD REC key

Refer to "Operation of CD REC key" on page 51.

- The CD REC key cannot be used at the same time as the PRESENCE REC key.

#### Connection of microphone

Please refer to "Simple Karaoke singing entertainment" on page 53.

# Reception of radio broadcast

## ■ Receiving broadcast stations and storing them in memory (preset operation)

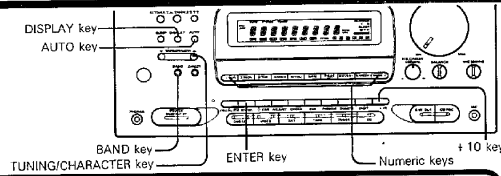

### 1 Display the frequency display.

- Every time the DISPLAY key is pressed, the displayed contents are switched in order of Frequency → Broadcast station name → Present time → Date (month & day).



### 2 Select the broadcast band.

- The frequency is displayed for a few seconds when a key associated with tuning is pressed.

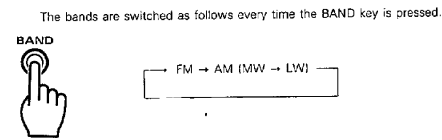

### 3 Select the tuning mode.

- Normally, select the auto mode (with AUTO lighted).

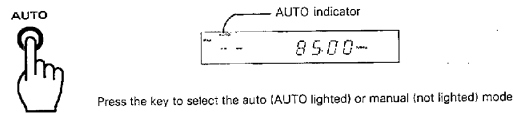

### 4 Tune the desired station.

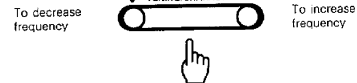

- The TUNED indicator lights up when a station is received.
- Use manual tuning mode when the radio wave is weak and noisy.
- At this time, the stereo FM broadcast is received in monaural mode.

Auto tuning mode	Manual tuning mode
Press once. (Tuning stops automatically when a station is received.)	Press repeatedly, or press and hold, until the desired station is received.

### 5 Store the station in preset memory.

#### ① Press the ENTER key.

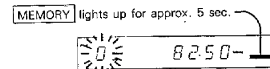
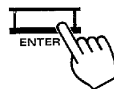

- Up to 20 broadcast stations can be preset regardless of the broadcasting bands.
- Proceed to step ② before MEMORY stops lighting.

#### ② Press the desired numeric key.

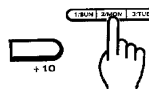

Examples of input  
 To select preset No. 15: [+10] 5  
 To select preset No. 20: [+10] +10] 0

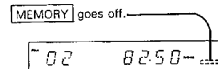

- When a station has previously been preset under the numeric key pressed, the newly preset station replaces the previous station.

## ■ Receiving a preset station

### Select the desired station.

Press the numeric key under which the station is preset.

TUNE | SCAN | STUE | SWEEP | STNU | SPTU | TBAI | SEVEN | POWER | DOWN



- The frequency of the station received will be displayed.

## ■ Listening to all preset stations in sequence (PRESET SCAN)

### Remote control only

Press the P.SCAN key.



- Every time ▲ (UP) is pressed, the preset stations are received in order of 1→2.....19→20→1.....
- Every time ▼ (DOWN) is pressed, the preset stations are received in order of 20→19.....2→1→20.....
- When a key is held depressed, the preset stations are received in sequence at 0.5-second intervals. The station being received when the key is released will continue to be received.

## ■ Direct tuning of radio stations

If you know the frequency of the desired station, it can be received directly by inputting the frequency using the numeric keys.

### 1 Select the broadcast band.

- One of FM or AM (MW/LW).



### 2 Press the DIRECT key.



### 3 Input the frequency of the desired station by pressing the numeric keys.

TUNE | SCAN | STUE | SWEEP | STNU | SPTU | TBAI | SEVEN | POWER | DOWN



#### Example of input

Desired station	Order of pressing numeric keys
FM 90 MHz	9, 0, 0 (100 kHz space)
	9, 0, 0, 0 (50 kHz space)
FM 102.5 MHz	1, 0, 2, 5 (100 kHz space)
	1, 0, 2, 5, 0 (50 kHz space)
AM (MW) 810 kHz	8, 1, 0
AM (MW) 1240 kHz	1, 2, 4, 0

- If you commit a mistake in the input of numeric keys, press the [CLEAR] key, and re-start the input from the beginning.

## Reception of radio broadcast

### ■ Displaying station names

Station names composed of up to four digits of characters and/or symbols can be displayed on the receiver display. Example: To receive FM 93.4 MHz, input its name with characters "CBE", and preset them under numeric key [3].

#### 1 Receive FM 93.4 MHz, and enter the character input mode.

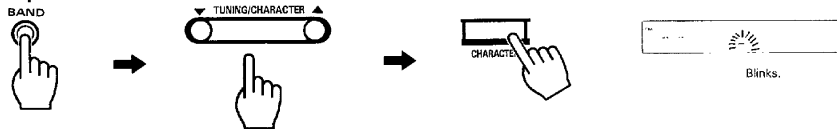

#### 2 Select the characters to be displayed with that station.

##### ① Display the desired character.

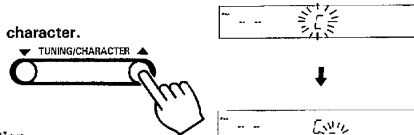

##### ② Establish the selection.

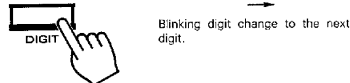

##### ③ Repeat steps ① and ② until all of the required characters have been input.

- To select "C", press the UP segment three times.
- To insert a space, simply press the DIGIT key.

#### Types of characters that can be input

After having pressed the CHARACTER key, press the TUNING/CHARACTER key to display the characters available.

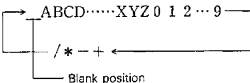

#### 3 End the character input.

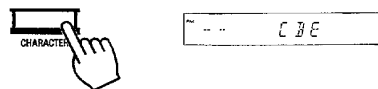

- The character input also terminates automatically when fourth character has been input.
- Press the CHARACTER key to terminate character input with three characters or less.



In case you commit an input mistake, press the CLEAR key and re-start from the first digit.

#### 4 Preset them under key [3].

##### ① Press the ENTER key.



##### ③ Press numeric key [3].



Press while MEMORY is lighted.

(End of preset)



## ■ Changing a station name

Example: To change station name "FHN8" preset with AM (MW) 810 kHz frequency under key [2] numeric keys to "FEN".

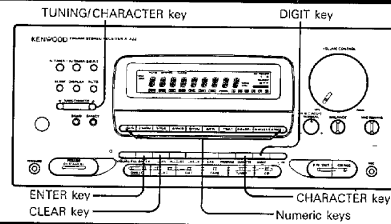

**1** Receive preset station of [2] by preset tuning, and enter the character input stand-by mode.

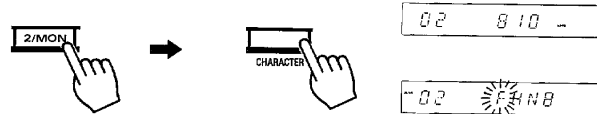

**2** Move the blinking digit to the second digit.



**3** Select "E" with the TUNING/CHARACTER key.



**4** Move the blinking digit by two digits.



**5** Select the blank with the TUNING/CHARACTER key.



- The character input terminates automatically when fourth character has been input.

**6** Preset the new name under numeric key [2].

① Press the ENTER key.

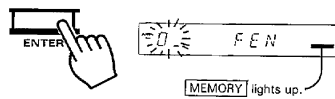

MEMORY lights up.

② Press numeric key [2].

Press while MEMORY is lighted.

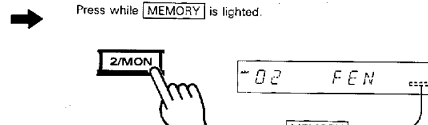

MEMORY goes off.  
(End of change)

## Operation of graphic equalizer

This system features a sophisticated graphic equalizer which allows fine adjustment of frequency bands. It is possible to compensate for the acoustics of the listening room, as well as to enjoy music with optimum sound thanks to the AI (Artificial Intelligence) features as described below.

### 1. DEMO (Demonstration)

Various equalization patterns are displayed in order, and the sound is also varied accordingly.

### 2. AI AUTO (available only for CD play)

Checks and analyzes the frequency, contents recorded on a CD automatically, and sets the optimum equalizer pattern for the CD.

### 3. AI LOUDNESS

The lowest and highest frequencies are enhanced according to the current volume setting. This function is effective when listening at low volume.

### 4. REC MODE (Curves for use in recording)

A "CAR" curve is provided for recording tapes to be played on a car stereo, and a "HEADPHONE" curve is provided for recording tapes to be played on a headphone stereo.

### 5. REFERENCE/MANUAL modes

**REFERENCE:** Five exemplary patterns have been preset at the factory.

**MANUAL:** Five preset patterns are stored in this mode as well, but this mode allows you to freely store (memorize) your own original equalizer patterns. You can easily recall and store equalizer patterns using the preset keys.

### 6. CHARACTER

In the spectrum analyzer display mode, the level of the music being played and changes of frequency distribution with four different patterns are displayed.

SPE.ANA	1 (NORMAL)	Normal spectrum analyzer display.
	2 (SHOWER)	Reversed normal spectrum analyzer display with the normal peak hold levels display.
	3 (HORIZONTAL)	Displays right and left levels with the frequency band in horizontal axis and level in vertical axis.
	4 (SEE THROUGH)	Displays peak hold levels only.

#### Dolby surround and DSP presence keys

Refer to "Presence effect" on page 54.

#### HIT MASTER key

Please refer to "Simple Karaoke singing entertainment" on page 53.

**AI: Artificial Intelligence.** The AI is capable of adjusting the tone automatically according to the source and music categories.

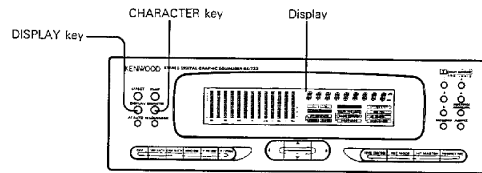

### Contents of display

#### DISPLAY



The display mode changes every time the DISPLAY key is pressed.

- When recording with a cassette deck, the display can be changed between graphic equalizer and spectrum analyzer.

#### Spectrum analyzer display

Displays the frequency distribution of the source being played to allow understanding at a glance. The peak value of the varying level of each frequency range is held and displayed in near real time.

#### Graphic equalizer display

Shows how each frequency range is compensated. The graphic equalizer display also appears for about 5 seconds, even while the unit is in the spectrum analyzer display mode, when one of the following operations is performed.

1. Switching power ON.
2. An operation key associated with an equalizer operation is pressed.

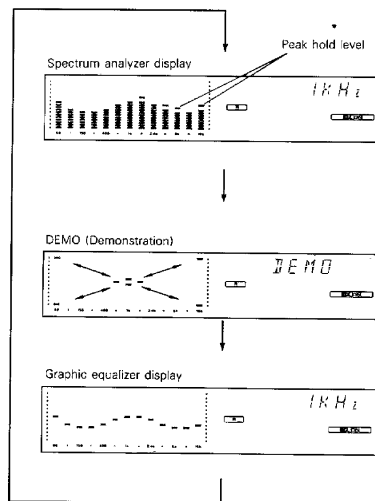

### Character display

Press the CHARACTER key in the spectrum analyzer display.

#### CHARACTER



Every time the CHARACTER key is pressed, the display modes are switched in the order shown below.

#### NORMAL

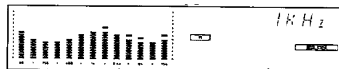

#### SHOWER

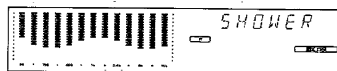

#### SEE THROUGH

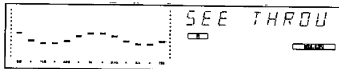

#### HORIZONTAL

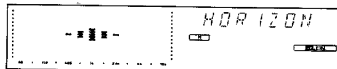

## Operation of graphic equalizer

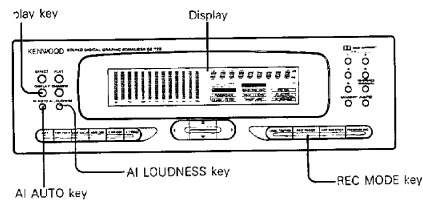

### ■ Demonstration procedure

The effect of each equalizer pattern can be verified with your ears as well as your eyes.

- ① Play a source.
  - ② Press the DISPLAY key to select DEMO.
- The demonstration is repeated in the cycle shown below.

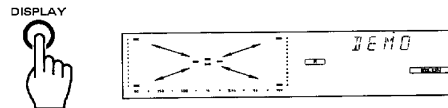

DEMO → REFERENCE 1-5 → MANUAL 1-5 → DSP.F4CH "ARENA" → "JAZZ CLUB" → "STADIUM" → "DISCOTHEQUE"  
 ↓  
 DEMO END ← REC MODE "HEADPHONE" ← REC MODE "CAR" ← AI AUTO ← "MOVIE" ← "CHURCH"

- To stop the demonstration, press the DISPLAY key.
- During demonstration, do not change the input selection on the receiver.

### ■ Operation of AI AUTO (available only for CD play)

By pressing the AI AUTO key only, the optimum equalizer pattern for a CD is selected automatically.

#### 1 Place a disc in the CD player.



#### 2 Press the AI AUTO key.

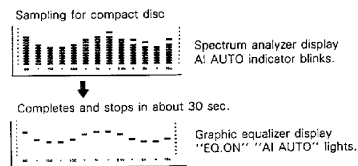

- Wait about 30 seconds for "EQ.ON" and "AI AUTO" to light up.

The playback starts automatically.

Note:  
 In step 2, the other keys than the AI AUTO and the POWER key do not operate.

#### To cancel AI AUTO

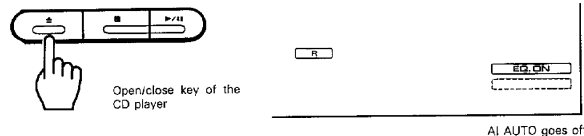

- If it is canceled during AI AUTO setting operation, the last pattern selected before is displayed

## ■ Operation of AI LOUDNESS control

This feature compensates automatically the lack of low and high frequencies felt when listening at a low volume.

### To activate the AI LOUDNESS effect

AI LOUDNESS

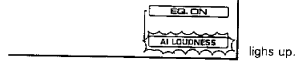

lights up.

- The equalizer pattern being selected will be combined with the loudness compensation pattern which corresponds to the sound volume.
- When the CAR or HEADPHONE mode is selected with the REC MODE key, the AI LOUDNESS cannot be operated.
- To record with optional equipment, be sure to cancel the AI LOUDNESS function.

### To cancel AI LOUDNESS

AI LOUDNESS

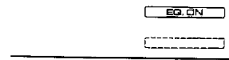

goes off.

Press the key again.

- The previous equalizer pattern resumes.

## ■ How to use the REC MODE key

Use the following function when recording tapes to be played on a car stereo or headphone stereo.

### 1 Play a music source and press the EFFECT key.

EFFECT

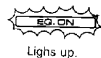

Lights up.

### 2 Select a desired curve.

Use the AI AUTO curve or select a desired curve from patterns R1 to R5 and M1 to M5. Also refer to page 31.

### 3 Select a REC MODE.

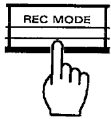

Each press switches the modes.

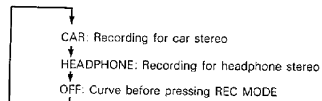

- The combination synthesizing the current equalizer curve being selected and the recording curve for car stereo or headphone stereo is applied to the music.
- AI LOUDNESS is canceled automatically when a REC MODE is selected.

### 4 Start recording.

Refer to page 42.

### To cancel the REC MODE

Press the key until the mode is turned off.

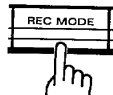

- The display shows the curve before synthesis again.

## Operation of graphic equalizer

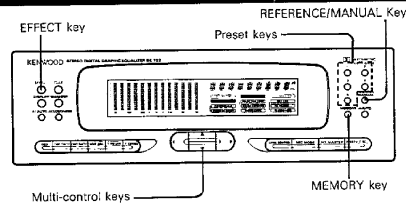

### ■ Operation of REFERENCE/MANUAL feature

This feature allows to recall one of ten preset equalizer patterns in a simple manner. The equalizer pattern curves of the REFERENCE mode are capable of modifying automatically in case of double-speed recording. The equalizer patterns of the MANUAL mode are mainly for use in playback with DSP effect.

**1** Play a music source.

**2** Press the EFFECT key.



**3** Select an equalizer pattern.

① Set to MANUAL or REFERENCE.

② Press the key for the desired pattern.  
(Refer to the equalizer pattern list on page 31.)

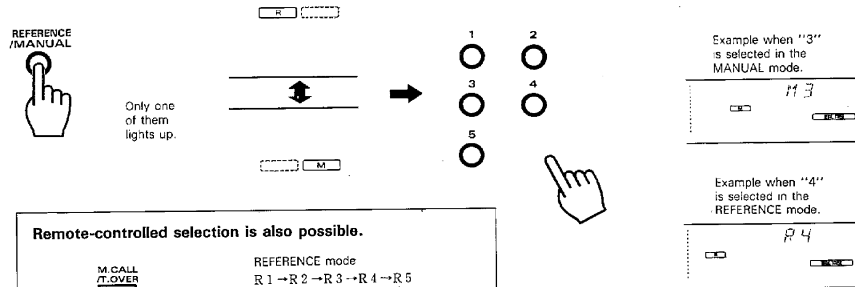

Remote-controlled selection is also possible.



REFERENCE mode  
R 1 → R 2 → R 3 → R 4 → R 5

MANUAL mode  
M 1 → M 2 → M 3 → M 4 → M 5

Patterns are switched every time the M.CALL key is pressed.

To cancel the equalizer effect



- The pattern being displayed remains the same.

How to use the FLAT key.

FLAT

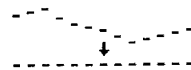

- Pressing the FLAT key makes the displayed curve flat.
- As the loudness is operated in the ALL LOUDNESS mode, the display does not become flat.

## ■ Equalizer pattern list

Preset equalizer patterns (REFERENCE) (R1-R5) The patterns in this mode adapt automatically to double-speed CCRS.	Preset equalizer patterns (MANUAL) (M1-M5) It is possible to store in preset memory in this mode.
<b>R1 [Soft]:</b> For listening a soft sound comfortable for ears, like background music.	<b>M1</b> (For use when graphic equalizer DSP mode is ARENA): For listening to popular or rock music with intensified bass or vocal.
<b>R2 [Clear]:</b> For listening a brilliant sound with attenuated low frequencies.	<b>M2</b> (For use when graphic equalizer DSP mode is STADIUM): For listening to popular or rock music with intensified bass, vocal, or treble.
<b>R3 [Heavy]:</b> For listening music like rock and fusion with more powerful sound.	<b>M3</b> (For use when graphic equalizer DSP mode is STADIUM or ARENA): For listening to orchestral music with intensified bass, vocal, or treble.
<b>R4 [Scale]:</b> For listening more exciting sound.	<b>M4</b> (For use when graphic equalizer DSP mode is MOVIE): Makes words in movies clearer.
<b>R5 [Noise reduction for use in double-speed recording]:</b> Cut off stimulating medium and high frequencies and enables soft sound recording. (This selection provides two curves, that used in double-speed recording and that used in double-speed playback, which have opposite characteristics between each other. The use of these curves in recording and playback allows to obtain a noise reduction effect.)	<b>M5</b> (For use when graphic equalizer DSP mode is MOVIE): Enhances effects sounds in movies.

## ■ How to store desired pattern (M1 ~ M5)

### 1 Creation of equalizer patterns

① Play a music source and press the EFFECT key.



② Select the frequency band to be adjusted.

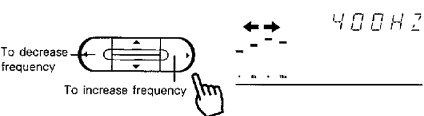

③ Adjust its level.



④ For each frequency band to be adjusted, repeat steps ② and ③ above.

### 2 Create a desired equalizer pattern.

① Press the MEMORY key.



② Press one of the preset keys.

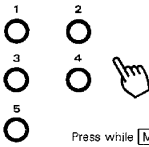

Press while **MEMORY** is lighted up.

- Pattern is preset under the number of the numeric key pressed.
- Up to five patterns can be preset in the same manner.
- If you press a preset key which contains a previously stored pattern, the previous pattern is replaced by the new pattern.

**To return to the initial pattern (factory-preset patterns M1 to M5) by clearing the user-preset pattern**  
Press the preset key where the pattern to be cleared is preset for more than 5 seconds.

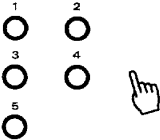

### ■ Functions of graphic equalizer

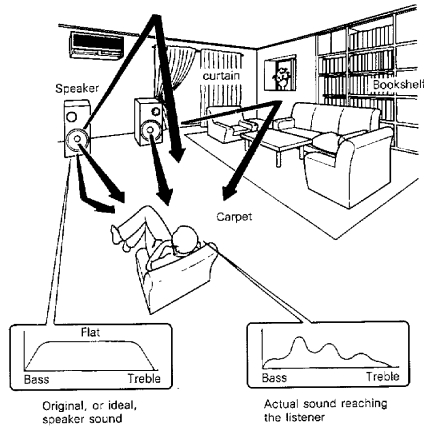

#### Compensation for the audio characteristics of listening room

The listening room may contain several objects. Some of them reflect sound and some absorb sound, thus the sound reaching your ears is considerably affected by these objects. In such cases, the graphic equalizer can be used to adjust the frequency response of the room for a flat response from low to high frequencies.

- Low frequencies are absorbed by beds, chairs, etc.
- High frequencies are absorbed by curtains, screens, etc.
- The room structure can cause the low frequencies to be unclear, or the sound level to increase or decrease depending on the frequency.

#### Adjustment of sound to your individual taste

When the reproduced sound contains several musical instruments and voices, the graphic equalizer allows you to enhance or attenuate the sound of specific instruments or voices.

#### Sound equalization

##### Super bass range (60 Hz)

When this control is moved up, the bass instrument (double bass, bass drums, or pipe organ, etc.) sound is increased. When the super bass sound is boomy, move this control down.

##### Bass range (150 Hz)

Usually, the listening room resonance frequency is in this range. To eliminate bass resonance, move this control down.

##### Mid-bass range (400 Hz)

This range is the basis of music. Whether the sound is rich or not, depends on this range. When the playback sound is not so good, move this control up.

##### Mid range (1 kHz)

When this control is moved up or down, the baritone or soprano voice is emphasized/de-emphasized. This range is related to the "presence" of music.

##### Mid-high range (2.4 kHz)

This range is related to stimulus and metallic sound. When this range is well compensated, vivid sound can be obtained.

##### High range (6 kHz)

This frequency range is related to the hardness of the sound. When this control is moved up, strings or brass instruments, such as flutes or piccolos, are emphasized. When the control is moved down, the sound will be more soothing.

##### Super high range (15 kHz)

This frequency range is related to the details of the music. When this control is moved up, super high frequency instruments, such as triangles or cymbals, are emphasized, resulting in wide sound and echoes.



# Operation of CD player

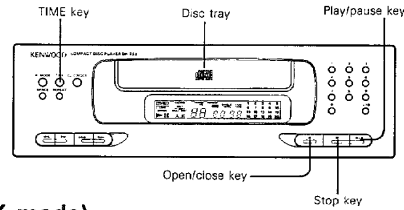

## ■ Playing a CD from the beginning (TRACK mode)

**1** Select the CD source with the input selector of the receiver.

**2** Insert a CD.

① Open the disc tray.

② Place a CD on the tray.

③ Close the tray.

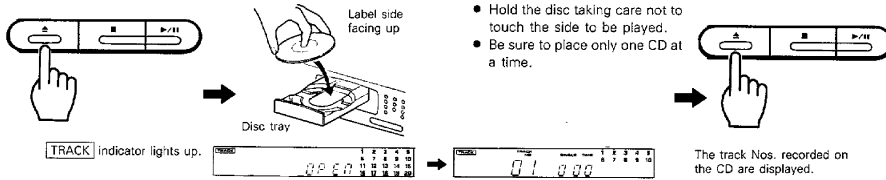

**3** Start playback.

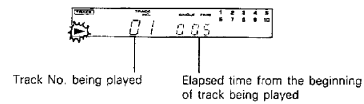
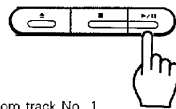

• In a few seconds, playback starts from track No. 1.

**To pause CD play**

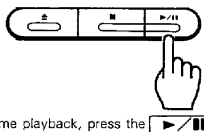

• To resume playback, press the play/pause key again.

**To stop CD play**

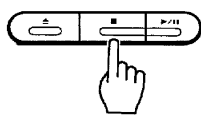

### TIME key

Press the **TIME** key when you want to check the elapsed time and remaining time of the track being played. Every time the **TIME** key is pressed, the displayed time is switched as shown below.

The time information display may not appear when playing a CD containing 44 or more tracks. In such a case, the display (SINGLE TIME) will show " - - : - - ".

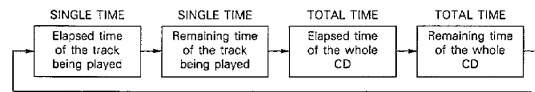
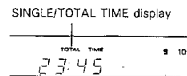

Example ..... 1:23      -2:37      23:46      -36:15

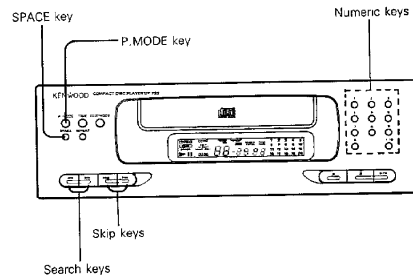

■ Starting play from a desired track

Selection using the skip keys

Press one of the skip keys according to which direction to skip.

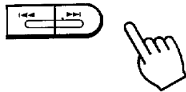

- Tracks are skipped in the direction of the pressed key, and playback resumes from the selected track.
- When the [←] key is pressed once during play, the track starts again from the beginning.

Selection using the search keys

Press the forward or reverse search key according to the direction to move.

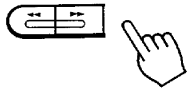

- The disc is fast-forwarded or fast-reversed while the corresponding side of the key is held pressed.
- Playback resumes from the position where the key is released.

Selection using the numeric keys

1 Ensure that the CD player is in the TRACK mode.

- If the [PGM] indicators is lighted, press the [P.MODE] key.

2 Select the desired track.

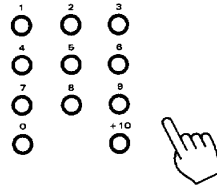

Examples of input

Track No. 23 : [+10] [+10] 3

Track No. 40 : [+10] [+10] +10] +10] 0

- The selected track and also the tracks located after it will be played back.

Notes:

1. If a track No. which is not present on the CD is selected while the tray is open, the last track on the CD will be played.
2. Such a selection is not accepted after the tray has been closed or playback has started.

## ■ Playing desired tracks in desired order (PGM mode)

### 1 Enter the PGM mode.

Press the **P.MODE** key.

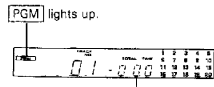

The SINGLE TIME (elapsed time) display changes to TOTAL TIME (remaining time) display.

### 2 Program desired tracks in desired order.

**Example**

To program track Nos. 2, 5 and 25: Press numeric keys **[2]**, **[5]**, **[+10]**, **[+10]** and **[5]** in this order.

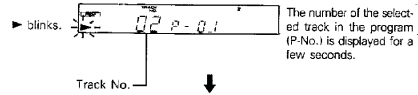

Track No. ↓



- Up to 20 tunes can be selected. When the 21 or more tunes are selected, FULL is displayed.
- If you made a mistake, press the CLEAR key (Remote control only) and select the correct track.
- Tracks can also be programmed by reading the disc label while the disc tray is open.
- The TOTAL TIME is not displayed in case a track No. of 44 or more is programmed.

### 3 Start playback.

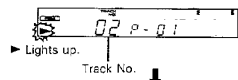
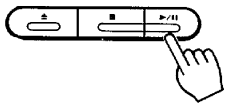

Track No. ↓

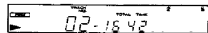

- Tracks are played in the order they are programmed (P.No.).
- Pressing one of the skip keys (**[▶▶]**, **[◀◀]**) during playback skips tracks in the corresponding direction.

### To check the programmed order

**Remote control only**

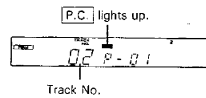
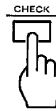

- Every time the key is pressed, the track No. and the order it was programmed (P.No.) are displayed in the order of programming.
- The previous display will resume in a few seconds.

### To resume normal playback



- The playback in the order of the track Nos. on CD will start after the track being played.

### To stop program play

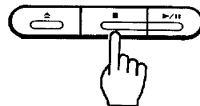

### To check the time of each track on the disc.

In the program mode, when the disc is stopped, the time of each track on the disc can be checked by pressing the skip keys **[▶▶]**.

- The previous display will resume in a few seconds.

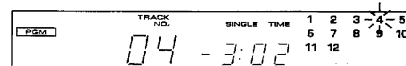

## Operation of CD player

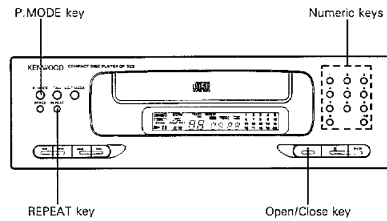
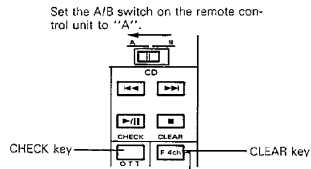

### ■ To add a track to the program

Press the key(s) for the track No. to be added.

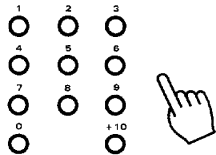

### ■ To clear tracks from the program

Clearing from the last track

Remote control only

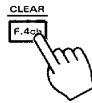

- Every time the key is pressed, tracks are cleared from the last track in order.

### ■ To change a track in the program

1 Press the CHECK key. Remote control only

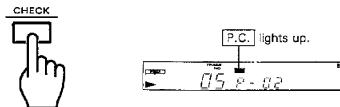

Press repeatedly until the program No. to be changed is displayed.

2 Press the keys for the track No. to replace the previous one.

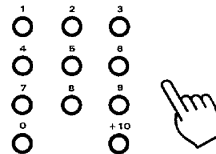

Press while the [P.C.] indicator is lighted.

- When 20 tunes are programmed, the program contents cannot be changed.
- The track being played cannot be changed.

Clearing the whole of program

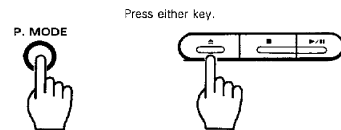

### Auto-Space function

During playback in the program mode, when the SPACE key is pressed, a space of about 4 seconds is reserved automatically between the programmed tracks. This function is provided to facilitate the DPSS function of the cassette deck. However, such a space could also be reserved in case the sound of two tracks are continued, for example with some classic music and live recordings.



- The total time is displayed including the time of the space.
- To cancel Auto-space function, press the [SPACE] key again.
- This function does not operate in TRACK mode.

## ■ Repeat play (How to use the REPEAT key)

### Repeating a program

#### 1 Enter the PGM mode.

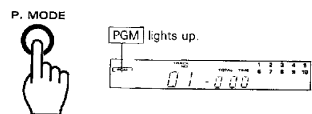

#### 2 Select desired tracks.

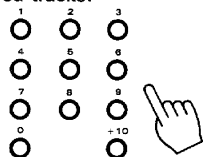

- The whole of the program made up of the selected tracks will be played repeatedly.
- If only one track is selected, that track will be played repeatedly.

#### 3 Press the REPEAT key.

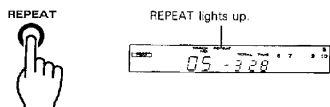

#### 4 Start playback.

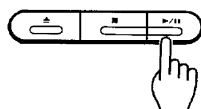

### Repeating a disc

#### 1 Enter the TRACK mode.

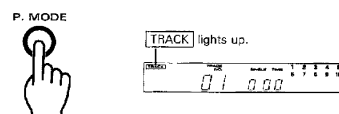

#### 2 Press the REPEAT key.

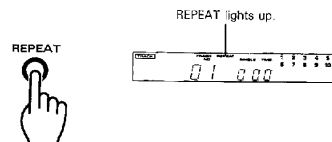

#### 3 Start playback.

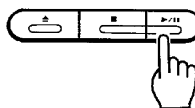

### To resume normal playback

Press the **REPEAT** key again.

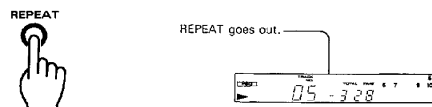

- The playback will be resumed under the CD player mode set before the repeat.
- The REPEAT key does not function after the EDIT mode has been selected.

# Playback operation of cassette decks

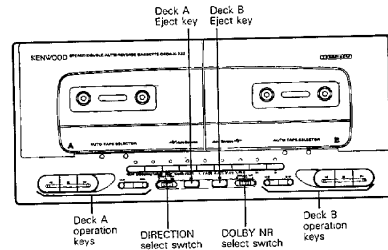

## ■ To playback a tape

### 1 Insert a cassette tape.

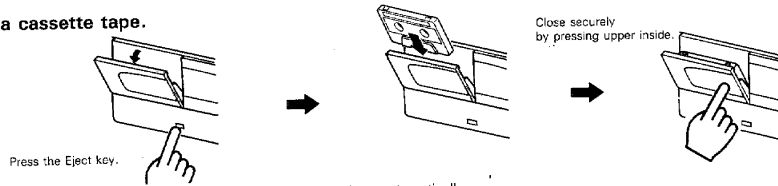

- The type of tape, Normal, Chrome or Metal, is detected and set automatically.
- Be sure to remove tape slack before insertion.

### 2 Determine the playback conditions.

#### ① Select the playback mode.



- ∞ ..... To play both sides endlessly.
- B ..... To stop after playing both sides of tape.
- A ..... To stop after playing one side of tape.

#### ② Select the Dolby NR mode.



Select according to the tape to be played.

### 3 Start playback.

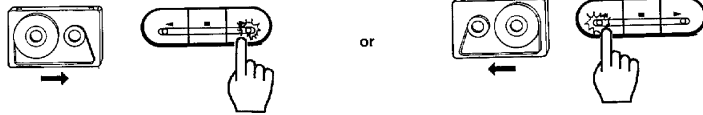

To stop playback, press the  key.

- Do not press the Eject key until the tape has stopped completely.

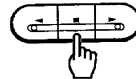

### Dolby noise reduction system

The Dolby noise reduction system was developed to reduce the tape hiss noise generated during play back. The optimum effect of the Dolby NR system is obtained when the same type NR system is used for both recording and playback. If a different type NR system is used, playback is not performed correctly. Make sure that the same type noise reduction system is used for both recording and playback.

#### Dolby B NR:

The most popular noise reduction system used in home audio components. Usually, Dolby NR system corresponds to B NR.

#### Dolby C NR:

Dolby C NR offers improved noise reduction performance over that of the Dolby B NR. It features a superior noise reduction effect. Use Dolby C NR to record or playback with this unit.

It is recommended that tapes recorded with the Dolby NR system be marked "B" or "C", so that they can easily be distinguished.

## ■ To wind the tape at high speed

### 1 Stop playback.

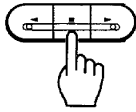

### 2 Press the ◀◀ key or ▶▶ key.

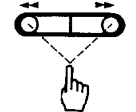

◀◀: Fast tape winding in the ← direction      ▶▶: Fast tape winding in the → direction

### To stop fast tape winding

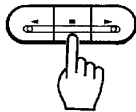

## ■ Relay playback

The relay playback allows to play two tapes in decks A and B alternately and repeatedly.

### 1 Insert tapes.

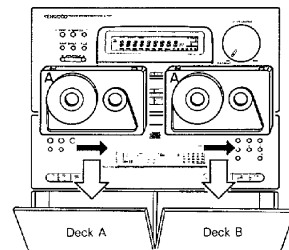

- The tapes are played in the directions indicated by their respective indicators.

### 2 Select the playback mode.

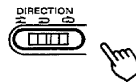

- ◁ ▷ ... Relay playback of both sides of tapes in decks A and B is repeated.
- ≡ ... Relay playback of only one side of tapes in decks A and B is repeated.
- Relay playback cannot be performed if the DIRECTION select switch is set to "C".

### 3 Start playback.

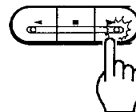

- The playback starts with the deck the play key of which is pressed.

### Tape direction indicators

The direction in which tape is transported during playback or recording is indicated by the lighting of one of the indicators ◀ and ▶. The direction used before the last time the tape is stopped is held in memory even after the power is turned OFF, so the same direction is recalled the next time the power is turned ON. To change the tape direction, press the Play key of the opposite direction after having inserted the cassette. If the unit has been OFF (STANDBY status) for a few days, the directions of both decks A and B become ▶ when power is turned ON.



## DPSS operation

The DPSS stands for Direct Program Search System, which enables the following convenient operations (these operations are, however, not available on both decks simultaneously). The DPSS functions are based on the detection of non-recorded spaces of 4 seconds or more between tunes.

- Skip play:** By specifying a tune located several tunes beyond (or behind) the tune being played, skips tunes between the current tune and the desired tune and starts playback from the beginning of the selected tune. Up to 16 tunes can be skipped in Skip Search.
- Rewind & Play:** Rewinds the tape to the beginning and starts playback from there.
- Single-tune repeated playback:** One single tune is played back repeatedly up to 16 times.
- Dash & Play:** If a non-recorded space of more than 10 seconds is detected during playback, that space will be skipped by fast tape winding.

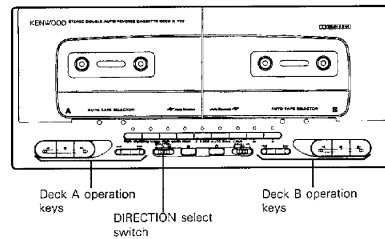
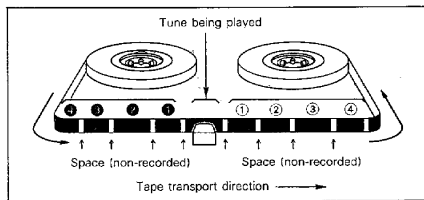

### ■ Skip play operation

If the direction indicated by the tape direction indicator is ◀, always press the keys for the opposite directions to those shown in the illustrations below.

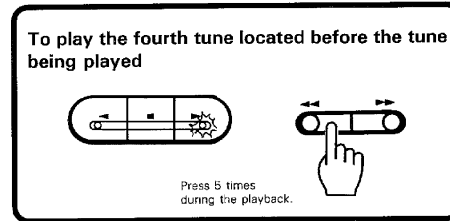
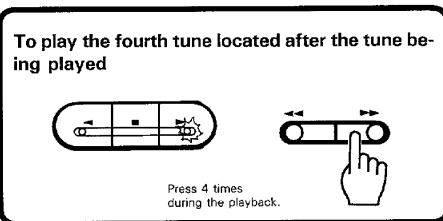
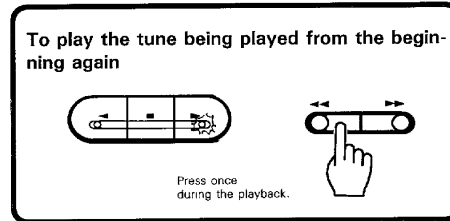
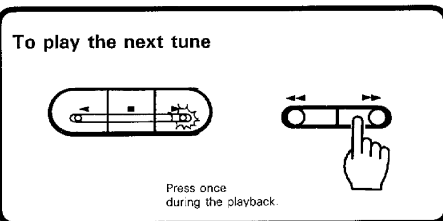

### The DPSS will not function properly with the following types of tapes.

- Tapes containing spaces of 4 seconds or more, such as conversations and speeches.
- Tapes containing extremely low levels or non-recorded blanks in the middle of tunes, such as classical music.
- Tapes containing recording or large noise between tunes.
- Tapes containing spaces of less than 4 seconds between tunes.
- Tapes recorded with low recording level.
- Tapes recorded using Cross-fade recording.



## ■ Rewind & Play operation

This operation is not available from the remote control unit.

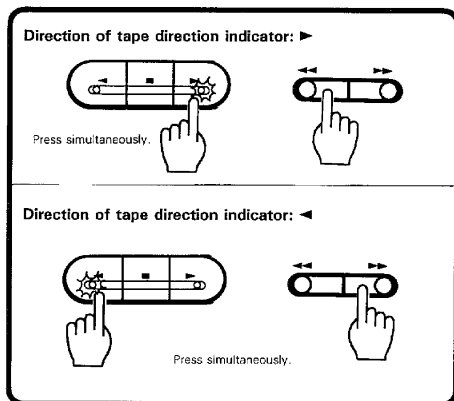

## ■ Single-tune repeated playback operation

1 Play the tune to be repeated.

2 Press the play key of the same direction as the current tape transport direction.

Direction of tape direction indicator: ►

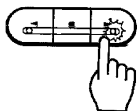

- Normal playback resumes after repeating the same tune for 16 times.

## ■ Dash & Play operation

The Dash & Play skips long non-recorded spaces automatically as the tape is played.

This operation is not available from the remote control unit.

1 Determine the playback mode (conditions).

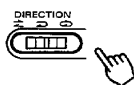

“◁” .... Two sides are repeated 8 times, after which playback stops.

“▷” .... Two sides are repeated only once, after which playback stops.

“≡” .... One side is repeated 8 times, after which playback stops.

- In case the DIRECTION select switch is set to “▷” and tapes are inserted in both of the decks, when a deck finishes Dash & Play, the other deck starts Dash & Play for 16 times, after which it stops.

2 Press the ◀ and ▶ keys simultaneously.

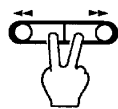

To cancel the playback above in the middle

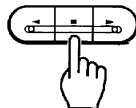

- Playback stops.

## Recording operation on cassette deck (Deck B only)

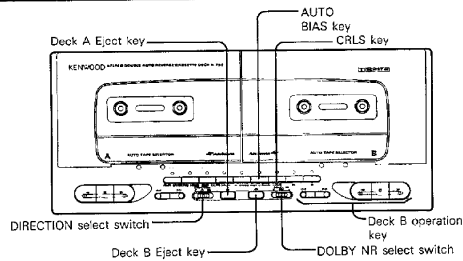

### ■ Ordinary recording

#### 1 Set up the cassette deck.

① Insert a tape in deck B.

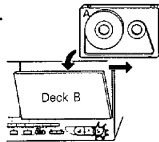

② Set the tape transport direction.

③ Select one-side or two-side recording.

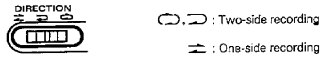

④ Select the Dolby NR mode.



#### 2 Select the source to be recorded.

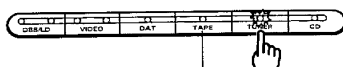

Select a music source other than TAPE.

#### 3 Apply the equalizer effect.

Press the EFFECT key to ON.



- Extinguish the EQ.ON indicator if it is required to record the source as it is, without processing sound with the equalizer.
- To record with the present effect, refer to page 59.
- To record with a suitable equalizer effect for playback on car stereo or headphone stereo, use the REC MODE key (refer to page 29).

#### 4 Set the auto bias adjustment function.



- The optimum bias value is set in about 45 seconds, after which the deck stops the auto bias operation.
- To cancel the auto bias adjustment operation in the middle, press the Stop key.
- It is also possible to start recording without performing the auto bias adjustment.

#### 5 Adjust the recording level.

① Play the musical source and output its sound.

② Press the CRLS key.



Level adjustment completes in about 20 seconds. Wait until the indicator lights steadily.

- The deck enters the record-pause mode.
- When the CRLS key is pressed after the indicator has lighted up and level adjustment has completed, the search operation of CRLS restarts from that moment for 20 seconds.
- If you press the Record key while the indicator is blinking, the recorded sound may distort.
- When the CRLS key is pressed while the indicator is blinking, the level adjustment is terminated at that moment and the deck enters the record-pause mode.
- The recording level setting is suspended if the sound of source is not input within about 5 second after the CRLS key has been pressed.

#### 6 Start recording.

① Play the music source from the beginning.

② Press the key.

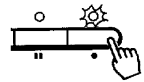

Press once.

- The deck enters the stop mode automatically when the tape has been recorded till the end.

#### Auto bias adjustment function

Normal tapes are available in wide ranges, from popular products to high-class products, and their characteristics vary largely. The cassette deck incorporates the auto bias adjustment function enabling optimum recording for normal tapes. It is recommended to use the auto bias adjustment function when recording using a Normal tape.

- During auto bias adjustment operation, operation keys are not effective except for the Fast forward, Rewind and Stop keys of deck A and the Stop key of deck B.
- If the remaining amount of tape is small, the auto bias adjustment may be canceled in the middle and tape may stop there.
- The setting of auto bias adjustment is canceled when the Eject key is pressed.

### ■ To pause recording temporarily

• The indicator lights up.

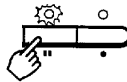

**To resume recording**

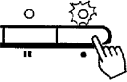

### ■ To stop recording

**1**

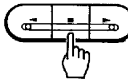

Press once.

**2 Stop playing the source component.**

Note:  
Do not press the MUTING key in the remote control unit.

### ■ To re-start recording after mistake

A non-recorded space of 4 seconds or more should be reserved before the position where recording was started.

**1 Stop recording and rewind tape.**

During recording in the ► direction:

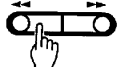

During recording in the ◀ direction:

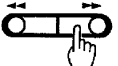

• The recording is aborted, the tape is rewound to the position where the recording was started, and the deck enters the stop mode after leaving a non-recorded space of about 2 seconds from the end of the previous tune.

**2 Re-start recording.**

① Press the ◻ key twice.

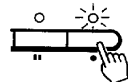

• A non-recorded space of 4 seconds is reserved on tape, then the tape transport stops.

② Press the ◻ key once.

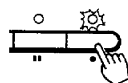

• Recording starts.

### CRLS

#### CRLS (Computer-controlled Recording Level System):

This function sets the optimum recording level automatically based on the sampling of the levels of a musical source for about 20 seconds.

- Even when you do not press the CRLS key..... Recording is performed with the basic recording level. The basic recording level common for all input select keys has been set at the factory.
- The level is stored in memory once it has been set..... The level determined by the CRLS key for each input source (DBS/LD, VIDEO, DAT, TUNER, CD) is stored in memory. From the next time, the same level is recalled for the same source and applied for recording even when the CRLS key is not pressed.
- To re-use the previous level after having pressed the CRLS key ..... Press the Stop key while the CRLS indicator is blinking to re-use the previously-set level.
- When the CRLS key is held depressed for more than 3 seconds ..... The indicator blinks at low speed then goes out. At this time, the CRLS level which has been stored for the input source being indicated returns to the basic recording level.

## Recording operation on cassette deck (Deck B only)

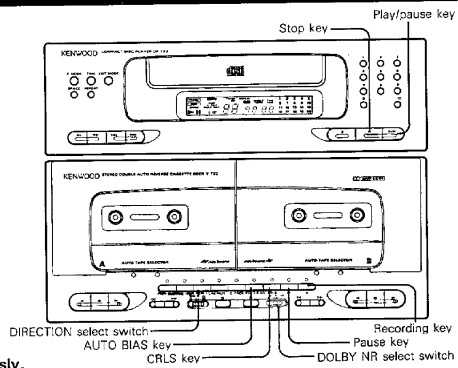

### ■ Synchro recording of CD playback

The cassette deck and the CD player can be started simultaneously.

#### 1 Set up the cassette deck.

① Insert a tape in deck B.

② Set the tape transport direction.

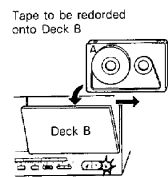

③ Select one-side or two-side recording.

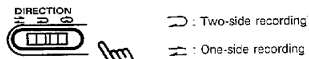

④ Select the Dolby NR mode.

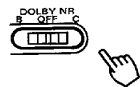

#### 2 Activate the auto-bias setting.



- The optimum bias is set in about 45 seconds, after which the deck enters the stop mode.

#### 3 Adjust the recording level.

① Start playing the CD.

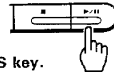

② Press the CRLS key.

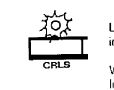

Level adjustment completes in about 20 seconds.

Wait until the indicator lights steadily.

- The deck enters the record-pause mode.

③ To pause CD play

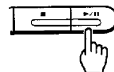

#### 4 Start playing the CD.

① Select the desired tracks with the numeric key.  
② Start playback.

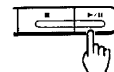

- Tape recording starts at the same time.
- When the CD player has completed playback, the cassette deck also stops recording and enters the stop mode.

#### To pause

Press the [play/pause] key of the CD player.

#### To resume recording

Press the [play/pause] key of the CD player.

#### To stop recording

Press the [stop] key of the CD player.

- When the [stop] key on the cassette deck is pressed, the cassette deck enters the stop mode, but the playback of CD does not stop.

## Recording of CD playback (CCRS)

The CCRS (Computer-controlled CD Recording System) makes the following convenient recordings possible by setting the optimum tape recording level and recording bias for the specific CD to be recorded and starting recording automatically. (CCRS recording is available only with Deck B.)

**Recording of TRACK mode playback:** CCRS starts recording the CD tracks from the first track in order. When the end of one tape side is reached during recording, fade-out occurs there, and recording is continued on the other side of tape, which starts with fade-in.

**Recording of PGM mode playback:** CCRS starts recording the programmed CD tracks in the programmed order. When the end of one tape side is reached during recording, the track which should end in the middle is erased, and the recording on the other side of tape is started from that track.

**Normal EDIT recording:** When the recording time of the tape is specified first, the order of the CD tracks are edited so that no track is interrupted at the end of each side of tape. The maximum number of tracks that can be edited is 20.

**AI EDIT recording:** When the total playing time of a CD exceeds the recording time of tape, all tracks can still be accommodated in the tape by fading out the end of each track.

**MULTI EDIT recording:** Tracks on multiple CDs can be edited and accommodated in a single tape.

**X.FADE (Cross-fade) recording:** The beginning and end of each track is faded in/out to create a music tape without interruption between tunes.

**CCRS double-speed recording:** Records CD at twice the normal speed. The graphic equalizer provides patterns for use in double-speed recording.

Also, refer to "Operation of CD player".

### CCRS (Computer-controlled CD Recording System)

When the CCRS key is pressed, the following operations occur automatically and recording of CD starts after them.

1. The CD is played and its peak level is sampled from the level used when the disc was recorded.
2. The optimum recording level for that disc is determined from the sampled peak level and the cassette deck is set accordingly.
3. The cassette deck sets automatically the optimum bias for the tape used in recording.
4. The recording preparations detailed above are completed in about 90<sup>+</sup> seconds, after which actual recording starts.
5. When the recording is completed (when the CD player ends playback or when the tape has been recorded), both the cassette deck and CD player enter the stop mode.

- The set recording level and auto bias level are maintained while the CCRS and AUTO BIAS indicators are lighted.
- The recording level is canceled when the open/close key of the CD player is pressed, the auto bias level is canceled when the Eject key of Deck B is pressed, and both are canceled if the power is turned off.

### Indications on the cassette decks during CCRS operation

Indicator	Lighting ○    Blinking ☀    OFF ●			
	CCRS	AUTO BIAS	Pause	Recording
During recording level setting	☀ Quick blinking	●	○	○
During auto bias adjustment	☀	☀	●	○
	☀	☀	●	●
During recording	☀ Slow blinking	○	●	○
During record-pause	○ *1	○ *2	●	○

- \* 1. To cancel CCRS setting: Press the Tray open/close key of the CD player.
- \* 2. To cancel auto bias setting: Press the Eject key of the cassette deck.
- \* 3. The time varies according to the number of the tunes to be recorded.

### Fade-in and fade-out

Fade-in refers to a gradual increase of volume from the minimum to normal level when starting to play music. Inversely, fade-out refers to a gradual decrease of volume from the normal to minimum level at the end of music.

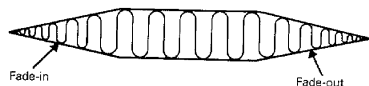

### CCRS double-speed recording

CD and cassette deck are both played at twice the normal speed and recorded, making it possible to half the time required for recording. Since the CD is played in double speed in this case, the recorded content cannot be enjoyable as music even though it can be monitored from the speakers.

In double-speed recording, tunes are recorded onto the tape without DOLBY NR effect. So playback the tape without DOLBY NR effect.

## Recording of CD playback (CCRS)

### ■ Recording of CD playback in TRACK mode

Fade-out and fade-in occur at the end of tape where it is reversed.

**1** Select CD with the input selector, and place a CD in the tray.

**2** Perform "Ordinary recording" until step 4.

- Refer to page 42.

**3** Check that the CD player is in the TRACK mode.

- If the [PGM] indicator is lighted up, press the [P. MODE] key.

**4** Start recording.

Normal-speed recording

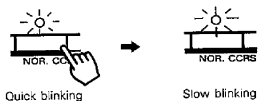

Double-speed recording

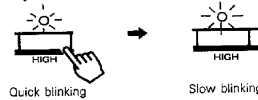

- The CCRS is activated so the recording will start in about 90 seconds.
- The tracks on the disc are recorded in the order of the track Nos.
- The operations as shown below occur at the end of tape where it is reversed.

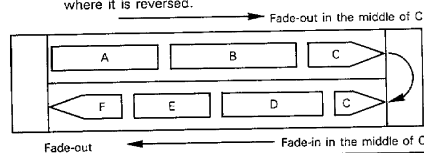

### ■ Recording of CD playback in PGM mode

Tracks are recorded so that they do not end in the middle at the end of tape.

**1** Select CD with the input selector, and place a CD on the tray.

**2** Perform "Ordinary recording" until step 4.

- Refer to page 42.

**3** In the PGM mode, select the order of tracks to be played.

- Refer to page 35.

**4** Start recording.

Normal-speed recording

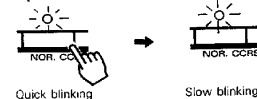

Double-speed recording

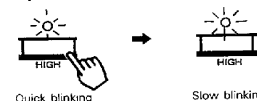

- The CCRS is activated so the recording will start in about 90 seconds.
- The tracks on the disc are recorded in the programmed order.
- The operations as shown below occur at the end of tape where it is reversed.

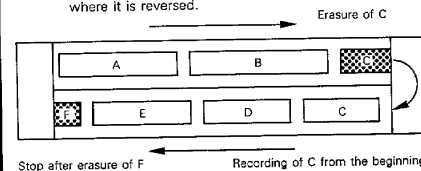

#### Notes:

- When the CCRS key is pressed during CD playback, the playback is stopped and CCRS setting operation starts.
- Once the recording level has been set by the CCRS, it cannot be adjusted as long as the CCRS operation continues.
- The CCRS searches the peak level on a CD in a limited period of about 90 seconds. Therefore, it could happen that the optimum level cannot be adjusted, though it is a very rare case.
- The recording level set by the CCRS is canceled when the Tray open/close key of the CD player is pressed or the power is turned off.
- If the length of a track on the CD is extremely long such as with a classical music, the CCRS cannot be used because the music cannot be fit in one side of tape.
- If a tune beginning and ending with fade-in and fade-out is recorded by X.FADE recording, spaces between recorded tunes may become very long.
- When the DIRECTION select switch of the cassette deck is "A" the tape end processing occurs only on the A side of tape.
- The CCRS and auto bias adjustment functions may not work properly near the end of tape.
- During CCRS operation, operation keys are not effective except for the Stop and Eject keys of cassette decks and the Stop and Tray open/close key of CD player.

## Normal EDIT recording

This function allows to edit, base on the recording time of the tape specified, the order of the CD tracks so that no track is interrupted at the end of each side of tape.

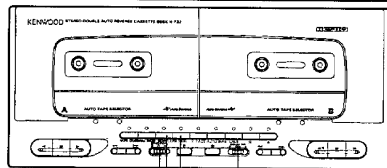

### 1 Set up Deck B ready for recording.

- ① Insert the cassette tape.

- ② Check the tape transport direction.

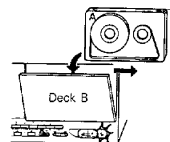

- ③ Select the tape sides to be recorded.

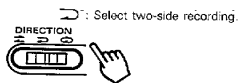

- ④ Select the Dolby NR mode.



### 2 Select the equalizer mode.

- If the EFFECT key is pressed after pressing the CCRS key, correct recording level cannot be obtained.

### 3 Select the CD input.

### 4 Insert the disc in the CD player.

- When you wish to program tunes, carry out the programming before step 5.
- To use the auto space function (page 36), press the SPACE key.

### 5 Select the EDIT mode with the EDIT MODE key of the CD player.

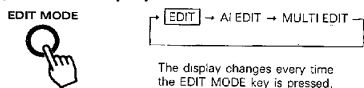

The display changes every time the EDIT MODE key is pressed.

- Proceed to the next step within 8 seconds after setting EDIT. If 8 seconds have elapsed, select the EDIT mode again.
- The CD playback mode is set automatically to [PGM].

### 6 Input the two-way recording time of the tape.

Use the numeric keys of the CD player.

C-30 tape: +10 +10 +10 0

C-46 tape: +10 +10 +10 +10 6

- 46, 54, 60 or 90 can also be selected every time the TIME key is pressed. In this case, press the EDIT MODE key again to establish the input.
- Tracks are edited automatically to fit sides A and B, and the end of editing is indicated when the [EDIT] indicator changes from blinking to continuous lighting.
- If a program containing a few tracks has been programmed previously, these tracks can be recorded in priority.
- When the EDIT MODE key is pressed again while [EDIT] is lighted, "SHUFFLE" appears on the display and re-editing of tracks is performed.

### 7 Press the CCRS key.

Normal-speed recording

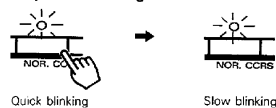

Double-speed recording

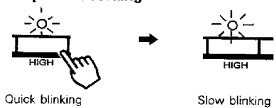

Recording occurs as shown below.

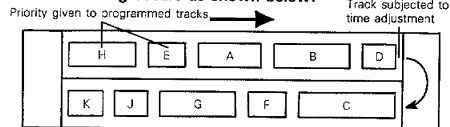

Tracks are recorded basically according to their numbers, but some tracks are replaced with tracks subjected to time adjustment.

- The CD player and cassette deck enter the stop mode automatically after the completion of recording.

#### Notes:

- Edit operation does not occur if a track No. 44 or more has been programmed.
- Repeat playback is not available.
- To cancel the auto-spacing, press the P.MODE key and re-start the procedure from step 5.

■ AI EDIT recording

When the total playing time of a CD exceeds the recording time of tape, this function allows to accommodate all tracks in a tape by cutting the end of each track by means of fade-out. It is also possible to specify the important tracks that must not be cut.

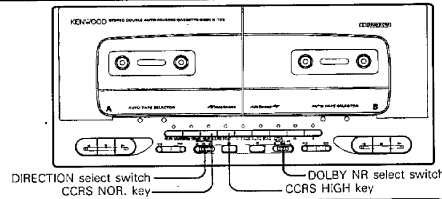

1 Set up Deck B ready for recording.

① Insert the cassette tape.

② Check the tape transport direction.

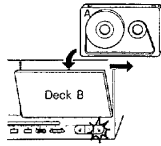

③ Select the tape sides to be recorded.

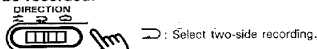

④ Select the Dolby NR mode.



2 Select the equalizer mode.

- If the EFFECT key is pressed after pressing the CCRS key, correct recording level cannot be obtained.

3 Select the CD input.

4 Insert the disc in the CD player.

5 Select the tracks which must not be cut in recording.

① Press the P.MODE key.

- [PGM] lights up.
- ② Input the track Nos. using the numeric keys.
- Input several numbers in a desired order.
- For details, refer to "Playing desired tracks in desired order" on page 35.

6 Select the AI EDIT mode with the EDIT MODE key of the CD player.

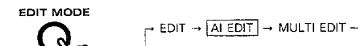

The display changes every time the EDIT MODE key is pressed.

- Proceed to the next step within 8 seconds after setting AI EDIT. If 8 seconds have elapsed, select the AI EDIT mode again.

7 Input the two-way recording time of the tape.

Use the numeric keys of the CD player.

C-30 tape: +10 +10 +10 0  
 C-46 tape: +10 +10 +10 +10 6

- 46, 54, 60 or 90 can also be selected every time the TIME key is pressed. In this case, press the EDIT MODE key again to establish the input.
- Tracks are edited automatically to fit sides A and B, and the end of editing is indicated when the [AI EDIT] indicator change from blinking to continuous lighting.

8 Press the CCRS key.

Normal-speed recording

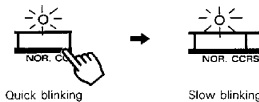

Double-speed recording



Recording occurs as shown below.

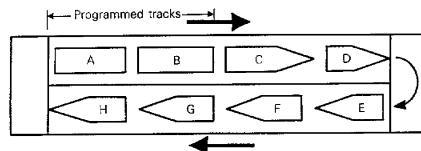

- First, the programmed tracks are recorded without any cutting, the other tracks are recorded with the end of every track cut by fade-out.
- If the tape has enough recording time, all tracks are recorded until the end.
- The CD player and cassette deck enter the stop mode automatically after the completion of recording.

Notes:

1. If an extremely-short tape recording time is set, automatic editing may not occur, or the tracks that must not be cut may cut.
2. The SPACE key and REPEAT key functions are inoperative.
3. Edit operation does not occur if a track No. 44 or more has been programmed.
4. X. FADE recording is not possible.



## ■ MULTI EDIT (Multiple disc edit) recording

This function allows to edit desired tracks on multiple CDs, each of which containing no more than 20 tracks, and record them on a single tape while replacing discs.

### 1 Set up Deck B ready for recording.

- ① Insert the cassette tape.
- ② Check the tape transport direction.
- ③ Select the tape sides to be recorded.  
→: Select two-side recording.
- ④ Select the Dolby NR mode.

### 2 Select the equalizer mode.

- If the EFFECT key is pressed after pressing the CCRS key, correct recording level cannot be obtained.

### 3 Select the CD input.

### 4 Insert the disc in the CD player.

### 5 Select the MULTI EDIT mode with the EDIT MODE key of the CD player.

EDIT MODE



EDIT → [EDIT] → MULTI EDIT

The display changes every time the EDIT MODE mode key is pressed.

- Proceed to the next step within 8 seconds after setting MULTI EDIT. If 8 seconds have elapsed, select the MULTI EDIT mode again.
- The CD playback mode is set automatically to [PCM].

### 6 Input the two-way recording time of the tape.

Use the numeric keys of the CD player.

C-30 tape: +10 +10 +10 0  
C-46 tape: +10 +10 +10 +10 6

- 46, 54, 60 or 90 can also be selected every time the TIME key is pressed. In this case, press the EDIT MODE key again to establish the input.
- [MULTI EDIT] changes from blinking to continuous lighting, indicating the program input stand-by, and the recordable time of side A is displayed.

### 7 Select the tracks to be recorded.

Using the numeric keys of the CD player, input the track Nos. in the order they are to be recorded.

- The TOTAL TIME display shows the remaining time on tape side A or B.
- When "FULL" appears on the display, this indicates that tracks cannot be recorded any more.

### 8 Press the CCRS key.

Normal-speed recording

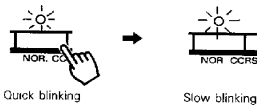

Quick blinking

Slow blinking

Double-speed recording

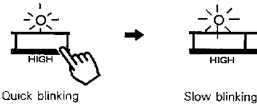

Quick blinking

Slow blinking

Recording occurs as shown below (example when three CDs are to be recorded).

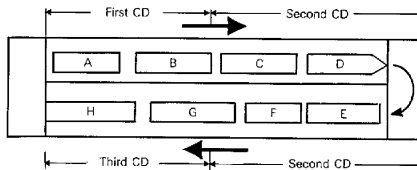

- When the first CD has been recorded, both the CD player and cassette deck enter the stop mode, and the tray of the CD player opens automatically.
- To record the second and third CDs, repeat steps 7 and 8 after changing the CDs and closing the tray of the CD player.

Notes:

1. In step 7, the display of the CD player shows FADE and the end of the selected tune which is longer than the preset time is faded out.
2. Track No. 44 or more cannot be input.
3. The SPACE key and REPEAT key functions are inoperative.
4. X. FADE recording is not possible.

## Recording of CD playback (CCRS)

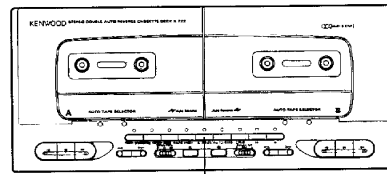
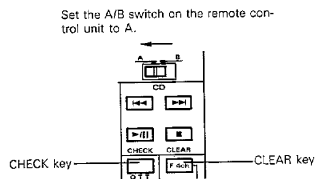

X. FADE Key

### ■ To check the edited contents

Remote control only

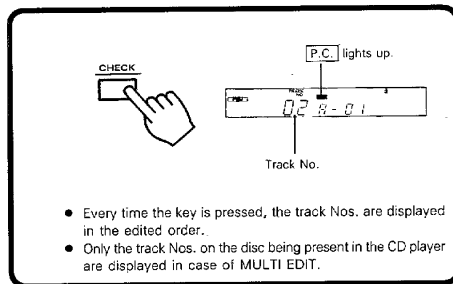

### ■ To clear the edited contents

Clearing individual tracks from the last track (MULTI EDIT only)

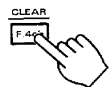

- Every time the key is pressed, the last track in the edited sequence of tracks is cleared.
- Only the track on the disc being present in the CD player can be cleared.

Clearing all edited contents

Press either of the following keys of the CD player.



- Only the track on the disc being present in the CD player can be cleared in case of MULTI EDIT.

### ■ X.FADE recording of CD playback

Not available with double-speed recording

1 Select CD with the input selector, and place a CD on the tray.

2 Perform "Ordinary recording" until step 4.

- Refer to page 42.

3 Start recording.

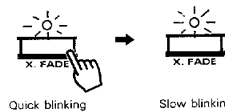

- The CCRS is activated so the recording will start in about 90 seconds.
- The recording operation according to the mode of the CD player starts.

In case of TRACK or PGM mode

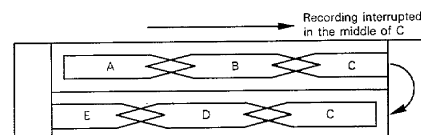

Stop in the middle of E      Recording of C from the beginning

In case editing (Normal EDIT) is executed before recording

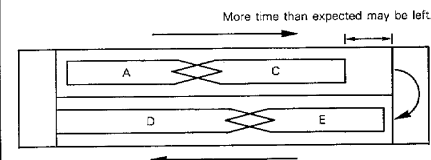

## ■ Operation of CD REC key

The CD REC key allows to listen to another music source while recording a CD.

### 1 Press the CD REC key of the receiver.

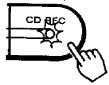

### 2 Start recording the CD.

Refer to "Synchro recording of CD playback" and "Recording of CD playback (CCRS)".

### 3 Select the music source to be listened to.

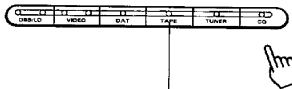

Select a music source other than TAPE.

### To cancel CD REC operation

Press the key again.

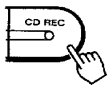

- This key is not accepted while the record indicator is lighted or blinking.

#### Notes:

1. When the CD REC key is set to ON, the CD sound cannot be recorded with the equalizer effect.  
In addition, the displayed equalizer pattern is locked and cannot be changed.
2. After CD REC recording, be sure to press the CD REC key to turn CD REC OFF.

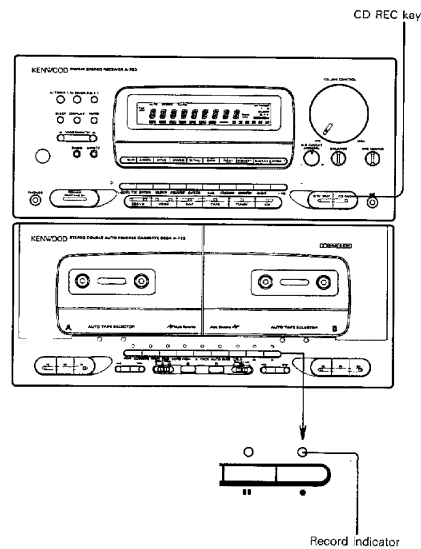

# Tape dubbing

The dubbing refers to the copy of the recorded contents of a tape to another tape (tape in Deck A → tape in Deck B).

Normal-speed dubbing: Copy at normal tape speed.  
High-speed dubbing: Copy at double the normal speed.

## 1 Insert tapes in the cassette decks.

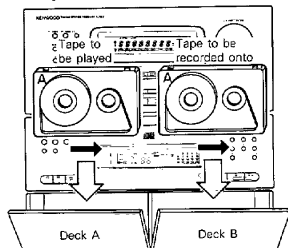

## 2 Set the same tape transport direction for both tapes.

- Refer to page 39.



## 3 Select one-way or two-way dubbing mode.

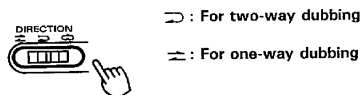

## 4 Press the AUTO BIAS key.

- The optimum bias is set in about 45 seconds, after which the cassette decks enter the stop mode.

## 5 Start dubbing.

For normal-speed dubbing

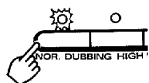

For high-speed dubbing

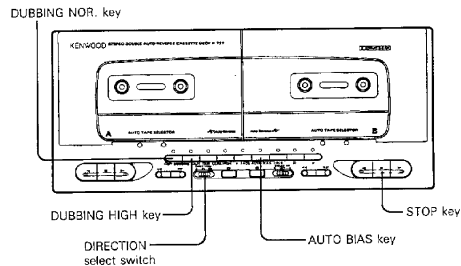
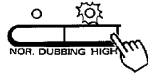

### To stop dubbing

Press the Stop key of Deck B

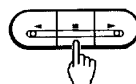

- Both Decks A and B enter the stop mode.

### To pause dubbing

Normal-speed dubbing: Press the NOR. key.

High-speed dubbing: Press the HIGH key.

- Only deck B enters the record-pause mode after leaving a non-recorded space of about 4 seconds in case of normal-speed dubbing, or about 6 seconds in case of high-speed dubbing.
- To skip tunes you do not want to dub on another tape during dubbing, press the [▶▶] key of Deck A.
- To resume dubbing after pause, press the same DUBBING key as above ([NOR.] or [HIGH]) again.

### Notes:

- The recording level cannot be adjusted for dubbing.
- The DOLBY NR key does not function during dubbing.
  - \* The tape recorded by dubbing features the same NR system as the original tape in Deck A.
- Noise from TV may interfere with dubbed sound if high-speed dubbing is executed near a TV set. To prevent this, install the system farther from the TV set.
- If the original tape was recorded at a high level, the sound quality may be degraded if high-speed dubbing is used. In such a case, use normal-speed dubbing.

## Simple Karaoke singing entertainment

**HIT MASTER:** This key allows to reduce the vocal level of songs played on CD, etc., so that you can sing along with only the accompaniment just like in "Karaoke" singing. This feature is convenient when you want to master a latest song the "Karaoke" backing of which is not available.

### ■ Connecting a microphone

- 1 Turn the MIC MIXING control fully counter-clockwise.



- 2 Insert the microphone plug into the MIC jack.



- 3 Adjust the volume.



### ■ Singing "Karaoke"

- 1 Play the music source.

- 2 Ensure that the CD REC is OFF.

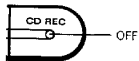

- 3 Press the HIT MASTER key.

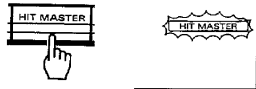

- Only the vocal part level is reduced from the music source.
- Presence effect can be applied to "Karaoke" singing by using the DSP.F4CH key (See page. 58).

- 4 Sing along with the music.

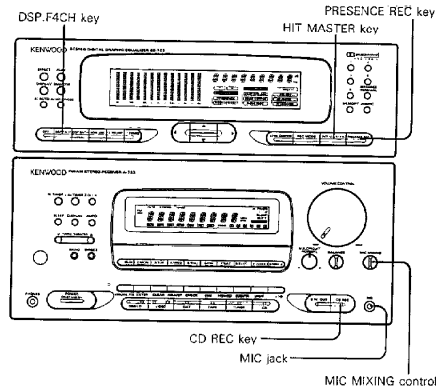

### ■ Recording "Karaoke"

- 1 Connect a microphone.

- 2 Ensure that the CD REC is OFF.

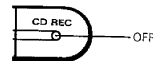

- 3 Press the HIT MASTER key.

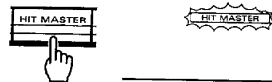

- 4 Perform the "Ordinary recording" procedure until step 5.

- Refer to page 42.

- 5 Start recording.

- 1 Play a music source.
- 2 Press the record key.
- 3 Sing along with the music.

- A "Karaoke" accompaniment tape can also be created by recording music with the MIC MIXING control set fully counter-clockwise.

- 6 Stop recording.

#### Notes:

1. When the microphone is not to be used, be sure to set the MIC MIXING control fully counter-clockwise.
2. The mixture of microphone sound and tape playback sound cannot be recorded.

## Presence effect

This unit incorporate features the following which can provide the feeling of presence which surrounds us in concert halls and theaters, and the powerfulness of movies played in movie theaters equipped with Dolby Surround system. For details, please refer to operating procedures described on the subsequent pages.

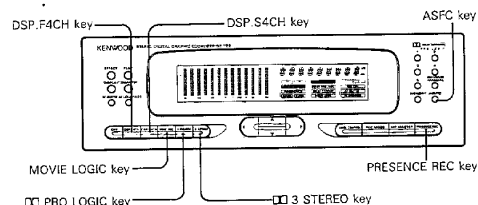

### Types of DSP modes

#### DSP.F4CH

The built-in presence speakers function to reproduce six kinds of presence effects (disc, movie theater, arena, church, jazz club, stadium) from the front speakers only. It is also possible to create desired sound fields by fine adjustment. (See Figure-4.)

#### DSP.S4CH

Select this mode when the center speaker and surround rear speakers are connected. Six kinds of presence effects can be reproduced similarly to DSP.F4CH. (See Figure-1.)

#### AI LINK equalizer effect

When DSP.F4CH or DSP.S4CH is selected, equalizer curves are automatically created according to the six kinds of presence sound fields to enhance them.

#### MOVIE LOGIC

Allows to enjoy a sound field like in a movie theater without using the center speaker and surround rear speakers. (See Figure-4.)

#### PRO LOGIC

When video software tape or LD software disc marked  DOLBY SURROUND is played, a Dolby Surround effect similar to movie theaters can be enjoyed. (See Figures-1 and 3.)

#### 3 STEREO

Select this when the surround rear speakers are not used. This improves the positioning of the center sound. (See Figure-2.)

#### ASFC (Acoustic Surround Field Control)

Adjust the sound expansion to improve the presence effect when the center speaker and surround rear speakers are not used. (For DSP.F4CH only.)

#### PRESENCE REC

Applies DSP presence sound field effect to the recording of music on the cassette deck. This allows to enjoy the DSP sound on headphone stereo and car stereo. (For DSP.F4CH only.)

### DSP (Digital Signal Processor)

The DSP system converts the reverberation components which enhance the presence effects into digital signals, and provides various presence effects without spoiling the quality of music sources.

## ■ Speaker layout

### Standard layout

DOLBY PRO LOGIC mode, (NORMAL, WIDE)  
DSP.S4CH mode

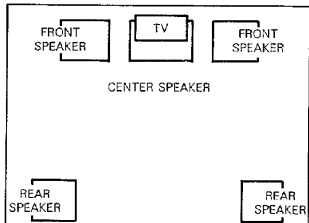

Figure-1

### When the surround rear speakers are not used

DOLBY 3 STEREO mode

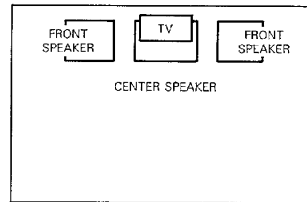

Figure-2

### When the center speaker is not used

DOLBY PRO LOGIC mode (PHANTOM)

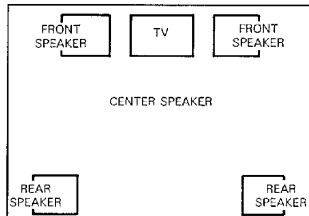

Figure-3

### When only two speakers are used

MOVIE LOGIC mode  
DSP.F4CH mode

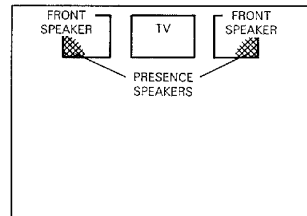

Figure-4

Note:

The built-in presence speakers function only in MOVIE LOGIC and DSP F4CH modes.

### How to set the delay time **DOLBY PRO LOGIC only**

The delay time should be adjusted according to the difference between the distances from the listening position to the front speakers and that from the listening position to the surround rear speakers. Refer to the following formula for the delay time adjustment.

Relationship between the surround rear speaker positions and the delay time at listening position:

$$\text{Delay time} = 20 \text{ ms} + 3 \text{ ms} \times (A \text{ m} - B \text{ m})$$

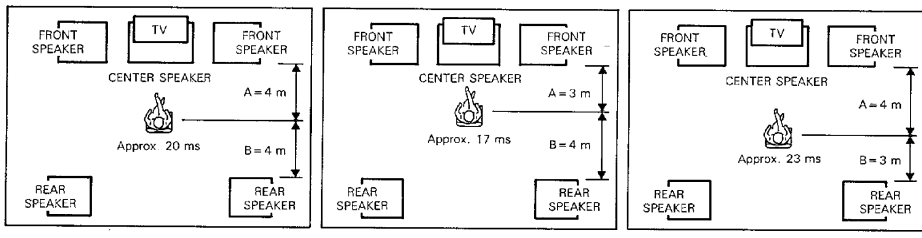

■ Dolby Pro Logic and Dolby 3 Stereo adjustments

**1 Activate the Dolby Pro Logic or 3 Stereo mode.**

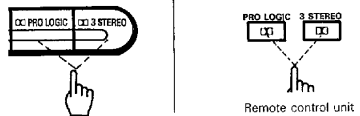

**2 Select the center mode.**  
Press the **PRO LOGIC** or **DOLBY 3 STEREO** key again.

**In Pro Logic mode:**  
Each press switches the center mode as shown below:  
NORMAL → WIDE → PHANTOM

**In 3 Stereo mode:**  
Each press switches the center mode as shown below:  
NORMAL ↔ WIDE

- Select the NORMAL mode when the center speaker is of a compact size, and the WIDE mode when it is of a medium or larger size.
- Select the PHANTOM mode when the center speaker is not used.

**3 Generate the test tone. Remote control only**

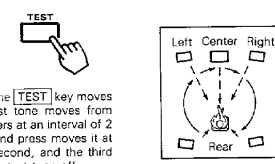

The first press of the **TEST** key moves the noise-like test tone moves from speakers to speakers at an interval of 2 seconds, the second press moves it at an interval of 1 second, and the third press switches the test tone off.

**In NORMAL or WIDE mode:**  
The test tone moves in order of Left → Center → Right → Rear.

**In PHANTOM mode:**  
The test tone moves in order of Left → Right → Rear.

**4 Adjust the speaker volumes so that the levels from all speakers are identical.**

**① Adjust the center level.**

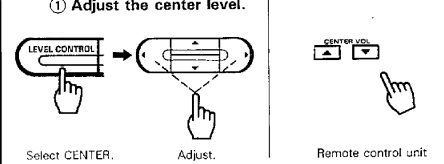

Select CENTER. Adjust. Remote control unit

**② Adjust the rear level.**

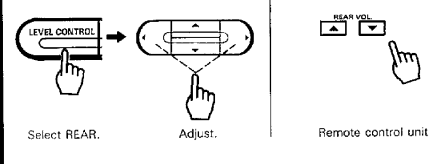

Select REAR. Adjust. Remote control unit

- In the 3 Stereo mode which does not use the rear speakers, adjust so that the volumes from the three front speakers are identical.

**5 Switch the test tone off. Remote control only**

Press the **TEST** key again.



**6 Adjust the delay time.**

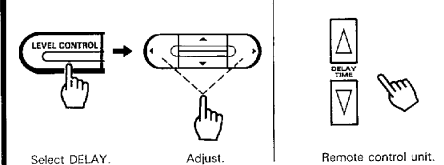

Select DELAY. Adjust. Remote control unit.

- The delay time is not set in the 3 Stereo mode.
- Refer to the formula shown on page 55.

To adjust the rear level, center level and delay time on the main unit front panel keys, select REAR, CENTER or DELAY with the **LEVEL CONTROL** key and adjust with the multi-control keys.

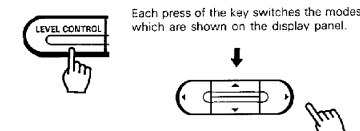

Each press of the key switches the modes, which are shown on the display panel.



## ■ Dolby Pro Logic and 3 Stereo playback

### 1 Activate the Dolby Pro Logic or 3 Stereo mode.



Remote control unit

### 2 Select the center mode.

Press the **PRO LOGIC** or **3 STEREO** key again.

#### In Pro Logic mode:

Each press switches the center mode as shown below:

NORMAL → WIDE → PHANTOM

#### In 3 Stereo mode:

Each press switches the center mode as shown below:

NORMAL → WIDE

### 3 Play Dolby Surround software tape or disc.

- With this unit, the input balance is adjusted automatically.

### 4 Adjust the volume.

The overall volume can be varied.



Remote control unit

- Once the adjustments of "Dolby Pro Logic and Dolby 3 Stereo adjustments" have been made, do not vary the settings of the **REAR VOL.**, **CENTER VO.**, and **DELAY TIME** keys.

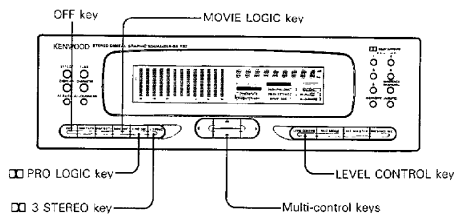

## ■ Operation of MOVIE LOGIC key

The built-in presence speakers allow to enjoy similar sound fields to movie theaters from the front speakers only.

### 1 Play a music source.

### 2 Activate MOVIE LOGIC.



Remote control unit

### 3 Adjust the volume.

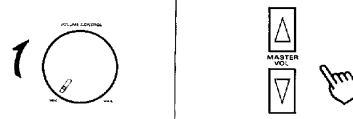

Remote control unit

To cancel

DISP OFF



Remote control unit

To cancel

DISP OFF

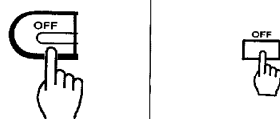

Remote control unit

# DSP presence

The DSP (Digital Signal Processor) allows to enjoy the ambiances of various places where music is played. The DSP has six basic presence parameters (four with DSP.F4CH) which can be set individually.

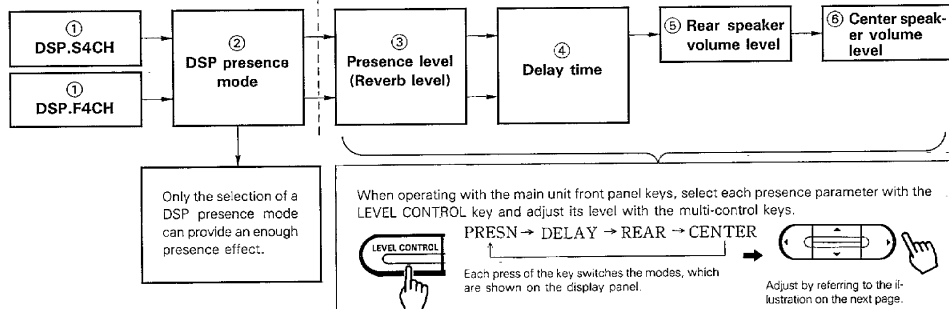

## ■ Creating the desired DSP sound field

### 1 Play a music source.

### 2 Select the DSP mode.

Remote control unit

### 3 Select the presence mode.

Press the **DSP.F4CH** or **DSP.S4CH** key again.

Each press switches the modes as shown below.

ARENA → JAZZ CLUB → STADIUM → DISCOTHEQUE →  
MOVIE ← CHURCH ←

- For the types and effects of the DSP presence modes, please refer to page 60.

### 5 Adjust the delay time.

① Select DELAY.

Remote control unit

② Adjust with multi-control keys.

### 4 Adjust the presence level.

① Select PRESN.

Remote control unit

② Adjust with multi-control keys.

### 6 Adjust the rear speaker volume.

**DSP.S4CH only**

① Select REAR.

Remote control unit

② Adjust with multi-control keys.

### 7 Adjust the center speaker volume.

**DSP.S4CH only**

① Select CENTER.

Remote control unit

② Adjust with multi-control keys.

## ■ To cancel the presence effect

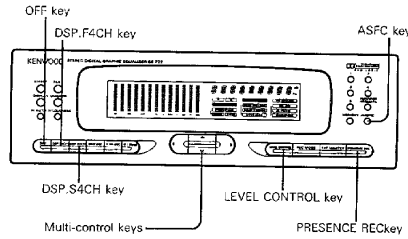
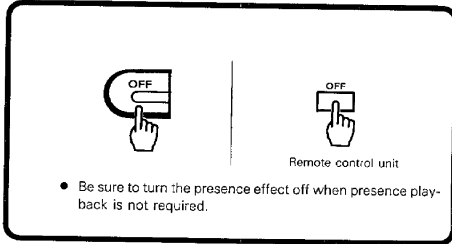

## ■ Operation of the ASFC key

Used to adjust the sound expansion when the surround rear speakers and center speaker are not used. **[DSP.F4CH only]**

### 1 Play a music source.

Refer to steps 1 to 5 of "Creating the desired DSP sound field" on page 58.

### 2 Adjust the sound expansion.

(Refer to page 60.)

① Press the ASFC key.



② Adjust the level.

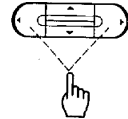

Remote control unit

## ■ To record the presence effect

**[DSP.F4CH only]**

### 1 Select a presence sound field.

### 2 Press the PRESENCE REC key.



• This function is incompatible with the CD REC function.

### 3 Play a music source and record it.

## Level display of each presence parameter

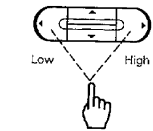

Adjust with multi-control keys.

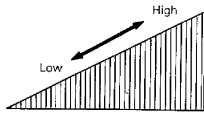

**PRESN**  
(Presence level)

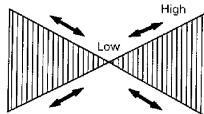

**REAR**  
(Rear speaker level)

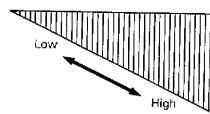

**DELAY**  
(Delay time)

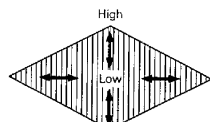

**CENTER**  
(Center speaker volume)

Note:  
The presence level and delay time level return to the standard values when the DSP mode or presence mode is changed.

## DSP presence

### Type and effect of DSP presence mode

<b>ARENA</b>	Reproduces the effects of a hall, with long reverberation and much reflection of high-frequency sound.
<b>JAZZ CLUB</b>	Reproduces the feeling of a live jazz house with sounding cymbals.
<b>STADIUM</b>	Reproduces the reflected sound characteristic to stadiums as PA speaker sound to create an excitement-charged atmosphere.
<b>DISCOTHEQUE</b>	Reproduces the feeling of a disco with exciting middle- and high-frequency sounds through the use of moderate reverberation and a graphic equalizer.
<b>CHURCH</b>	Reproduces the rich echoing of a solemn church.
<b>MOVIE</b>	Suppresses reflected sound from the center and reproduces mild echoing from the others.

### ASFC level parameter list **DSP.F4CH only**

The ASFC levels can be adjusted in five steps; the larger the value, the wider the sound expansion. Increasing the ASFC level increases the delay time and presence level and decreases the center level, providing the sound field with a wider image. Decreasing the ASFC level decreases the delay time and presence level and increases the center level, providing the sound field with a narrower image. The following table shows the changes of the presence levels and delay time levels in each presence mode.

		MODE	ARENA	JAZZ CLUB	STADIUM	DISCOTHEQUE	CHURCH	MOVIE
NARROW ↑	1	PRESENCE	-10 dB	-10 dB	-10 dB	-8 dB	-12 dB	-20 dB
		DELAY	50msec	10msec	60msec	10msec	60msec	25msec
	2	PRESENCE	-8 dB	-8 dB	-8 dB	-6 dB	-10 dB	-16 dB
		DELAY	60msec	15msec	65msec	20msec	70msec	40msec
NORMAL ↓	3	PRESENCE	-6 dB	-6 dB	-6 dB	-4 dB	-8 dB	-12 dB
		DELAY	70msec	20msec	70msec	30msec	80msec	55msec
	4	PRESENCE	-4 dB	-4 dB	-4 dB	-2 dB	-6 dB	-8 dB
		DELAY	80msec	25msec	75msec	40msec	90msec	70msec
WIDE	5	PRESENCE	-2 dB	-2 dB	-2 dB	0 dB	-4 dB	-4 dB
		DELAY	90msec	30msec	80msec	50msec	100msec	85msec

- When the modes are switched, the levels return to those listed in the table above.

### Delay time **DSP.F4CH, DSP.S4CH**

As shown in the example of illustration, the sound of piano played on the stage attains the ears of listener as a synthesis of the direct sound from piano, the indirect sounds which are reflected once or twice by the reflectors, ceiling and side and back walls, and the reverberation sounds which repeat infinite reflections until they fade out completely.

The indirect sounds always pass through longer routes compared to the direct sound. The delay between the direct and indirect sounds is called the DELAY TIME, and the level of the indirect or reverberated sounds is called the PRESENCE LEVEL. The indirect sounds accompanied with delay play a very important role in providing better sound effects and the feeling of presence of concert halls, etc. The acoustic field also varies depending on the speaker arrangement. It is recommended to try various delay time setting to obtain the best sound field possible.

#### Example of a concert hall

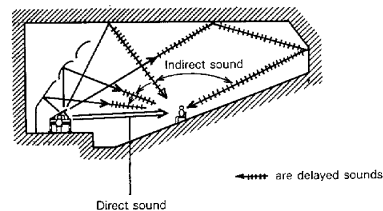

## Operation with video components

Please refer to page 12 for the connection of Audio/Visual components.

For the connections and operations, also read carefully the instruction manuals supplied with the video components to be connected.

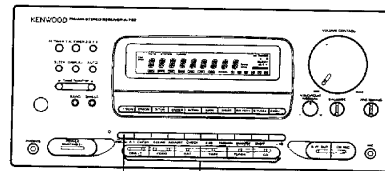

VISUAL FIX Key  
Input select keys

### ■ Playback of videotape

- 1 Switch the power of the monitor TV ON.
- 2 Press the VIDEO input select key of the receiver.

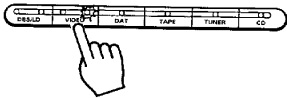

- 3 Play the VCR.

### ■ Recording of video source

- 1 Connect the video component to be recorded.

- A video player deck, video camera, LD player, DBS tuner, etc., can be connected.

- 2 Select the corresponding input source.

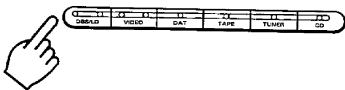

- 3 Play the video source component.

- 4 Put the VCR in the record mode.

### ■ Listening to CD or tape sound while watching video

- 1 Select the video component the image of which is to be viewed.

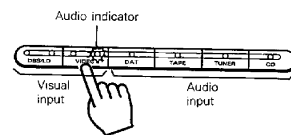

- 2 Select the audio source to be listened to.

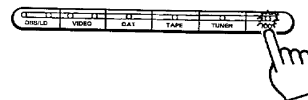

- Only the audio source is switched over while the image being displayed remains the same.

- 3 Play the selected video and audio components.

#### VISUAL FIX key

You can use this function to lock in a selected video input (DBS/LD, VIDEO). Once a video input is selected and VISUAL FIX is ON, the video signal will not change even if the input selector is switched to another video input.

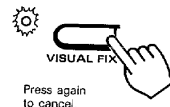

# Operation of timer

Be sure to adjust the present time before proceeding the following.

The timer of the system can be used for the following functions.

- Program timer** : Receives broadcast, records broadcast or plays tape or CD at the specified ON time, and switches power OFF at the specified OFF time.  
Up to six timer programs can be set. The AI TIMER functions can be added to the program timer function.
- AI TIMER 1** : When the power is switched ON at the timer ON time, the volume will increase in three steps, providing a wake-up effect like an alarm clock.
- AI TIMER 2** : When the power is switched ON at the timer ON time, two tracks of a CD is played first, then the input is switched automatically to the tuner.
- Sleep timer** : Switches power OFF after a set time period has elapsed. If set before you go to bed, power can be switched OFF automatically even after you fell in sleep.
- One-touch timer** : Switches power ON after a specified time period, set in the unit of 30 minutes up to 12 hours, from the moment it is activated. The AI TIMER functions can be added to the one-touch timer function.
- Calendar check** : When the year, month and day are input in this order, the day of the week of that date is displayed by means of an indicator.

- For the timer setting procedures, read description on the next page and after.
- The contents of timer programs can be modified as required.
- Even when a timer program has been input, the timer will not be activated unless its execution has been activated.
- Turn the AI TIMER functions OFF when they are not required; otherwise, they will be added to all of the programs executed on that day.
- Once set, the contents of a program cannot be cleared at once. The previous contents can only be cleared when they are replaced by modification.
- The programs must be set so that their time ranges do not overlap.

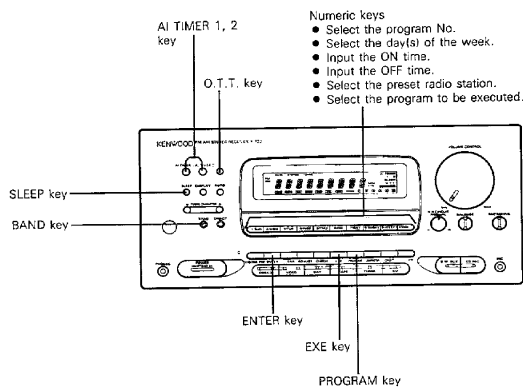

## Types of days of the weeks which can be selected by numeric keys

1. To execute a program only once on the specified day of the week after its execution has been activated.

### Numeric keys

Sunday	1/SUN
Monday	2/MON
Tuesday	3/TUE
Wednesday	4/WED
Thursday	5/THU
Friday	6/FRI
Saturday	7/SAT

- If it is required to activate the timer in the same time period of the next week, activate the execution again.

2. To execute a program repeatedly on every week after its execution has been activated.

### Numeric keys

Every day from Monday to Sunday	8/EVERY
Every day from Monday to Saturday	9/WEEK 1
Every day from Monday to Friday	0/WEEK 2

- If timer operation is not required, cancel the program execution.

Be sure to adjust the present time before proceeding the following.

## ■ Timer reception of radio broadcast

### 1 Switch the power ON.

Press the POWER key of the receiver.



### 2 Press the PROGRAM key.



SELECT PROGRAM

PN0

- The program No. indicators (1 to 6) blink.

### 3 Select the program No. to be used.

Press within 8 seconds.

1 2 3 4 5 6

Select from 1 to 6.

- The selected program No. indicator blinks.

### 4 Specify the day(s) of the week with the numeric keys.

1 2 3 4 5 6 7

Day(s) of the week

### 5 Input the ON time with the numeric keys.

6:30AM : 0, 6, 3, 0



INPUT ON TIME

ON 06:30

### 6 Input the OFF time with the numeric keys.

7:00AM : 0, 7, 0, 0



INPUT OFF TIME

OFF 07:00

### 7 Select the PLAY mode.



SELECT MODE

MODE PLAY

The timer modes are switched between PLAY and REC every time the BAND key is pressed.

### 8 Select the TUNER source.

BAND



SELECT SOURCE

TUNER

TUNER CD TAPE

The sources are switched every time the BAND key is pressed.

### 9 Select the preset key under which the station to be received has been preset.

1 2 3 4 5 6 7 8 9 0

SELECT PRESET



11 82.50

END

- The stations should be stored in the preset memory with a number of 20 or less.

### 10 Activate the execution of the program.

①



SELECT PROGRAM

- ② Select the program No. to be executed by pressing the numeric key under which it is set.

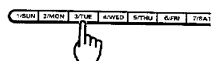

11 82.50

lights up

- The selected program No. indicator lights up.

### 11 Adjust the volume and tone.

### 12 Switch the power OFF.

Press the POWER key of the receiver.



To continue the reception of radio station which as been started to be received by timer ON:

- Press the CLEAR key before the OFF time comes.
  - Press the numeric key for the program No. being executed.
- When the program No. indicator goes off, it means that the program will be received continuously.

#### Notes:

- If you commit a mistake in the timer programming, press the CLEAR key and re-start from the beginning.
- If it is required to modify a program which has already been set, set a new program from the beginning.
- When a program has previously been set in the program No. selected in step 3, the newly-set program replaces the previous program.
- Do not operate the CLEAR key or POWER key while the timer program execution has been activated; otherwise malfunction will occur.

Be sure to adjust the present time before proceeding the following.

■ Timer playback of CD

**1 Switch the power ON.**  
Press the POWER key of the receiver.



**2 Press the PROGRAM key.**





SELECT PROGRAM

PNO

- The program No. indicators (1 to 6) blink.



**3 Select the program No. to be used.**  
Press within 8 seconds.

Select from 1 to 6.



- The selected program No. indicator blinks.

**4 Specify the day(s) of the week with the numeric keys.**

SELECT DAY



**5 Input the ON time with the numeric keys.**  
6:30AM : 0, 6, 3, 0

INPUT ON TIME

ON 06:30



**6 Input the OFF time with the numeric keys.**  
7:00AM : 0, 7, 0, 0

INPUT OFF TIME

OFF 07:00

**7 Select the PLAY mode.**





SELECT MODE

MODE PLAY

The timer modes are switched between PLAY and REC every time the BAND key is pressed.

**8 Select the CD source.**

SELECT SOURCE

CD

END

TUNER → CD → TAPE

The sources are switched every time the BAND key is pressed.

**9 Place a disc in the CD player.**

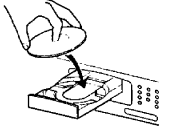

- It is not possible to preset a CD playback programs.

**10 Activate the execution of the program.**

①



SELECT PROGRAM

② Select the program No. to be executed by pressing the numeric key under which it is set.



11 02:50

- The selected program No. indicator lights up.

**11 Adjust the volume and tone.**

**12 Switch the power OFF.**  
Press the POWER key of the receiver.



Notes:

- If you commit a mistake in the timer programming, press the CLEAR key and re-start from the beginning.
- If it is required to modify a program which has already been set, set a new program from the beginning.
- When a program has previously been set in the program No. selected in step 3, the newly-set program replaces the previous program.
- Do not operate the CLEAR key or POWER key while the timer program execution has been activated; otherwise malfunction will occur.



Be sure to adjust the present time before proceeding the following.

## ■ Timer playback of tape

### 1 Switch the power ON.

Press the POWER key of the receiver.



### 2 Press the PROGRAM key.



SELECT PROGRAM  
PNO

- The program No. indicators (1 to 6) blink.

### 3 Select the program No. to be used.

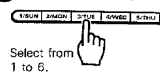

Press within 8 seconds.



- The selected program No. indicator blinks.

### 4 Specify the day(s) of the week with the numeric keys.



SELECT DAY  
-----

### 5 Input the ON time with the numeric keys.

6:30AM : 0, 6, 3, 0



INPUT ON TIME  
ON 06:30

### 6 Input the OFF time with the numeric keys.

7:00AM : 0, 7, 0, 0



INPUT OFF TIME  
OFF 07:00

### 7 Select the PLAY mode.



SELECT MODE  
MODE PLAY

The timer modes are switched between PLAY and REC every time the BAND key is pressed.

### 8 Select the TAPE source.

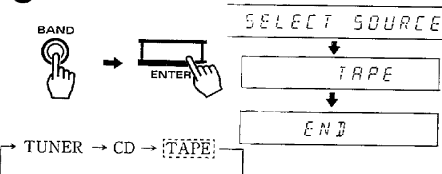

The sources are switched every time the BAND key is pressed.

### 9 Insert a tape and determine the playback condition.

Select the side(s) to be played and the Dolby NR mode.

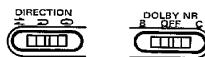

- Timer playback is possible with either Deck A or Deck B. However, if tapes are placed in decks, playback will begin from Deck B.

### 10 Activate the execution of the program.

①



SELECT PROGRAM

② Select the program No. to be executed by pressing the numeric key under which it is set.

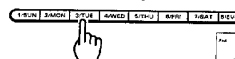

11 06:50

- The selected program No. indicator lights up.

### 11 Adjust the volume and tone.

### 12 Switch the power OFF.

Press the POWER key of the receiver.



#### Notes:

1. If you commit a mistake in the timer programming, press the CLEAR key and re-start from the beginning.
2. If it is required to modify a program which has already been set, set a new program from the beginning.
3. When a program has previously been set in the program No. selected in step 3, the newly-set program replaces the previous program.
4. Do not operate the CLEAR key or POWER key while the timer program execution has been activated; otherwise malfunction will occur.

Be sure to adjust the present time before proceeding the following.

■ Timer recording of radio broadcast

**1** Switch the power ON and receive a station to be recorded.



**2** Press the PROGRAM key.



- The program No. indicators (1 to 6) blink.

**3** Select the program No. to be used.

Press within 8 seconds.

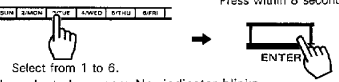

Select from 1 to 6.

- The selected program No. indicator blinks.

**4** Specify the day(s) of the week with the numeric keys.



**5** Input the ON time with the numeric keys.

0:00AM : 0, 0, 0, 0



INPUT ON TIME

ON 00:00

**6** Input the OFF time with the numeric keys.

0:30AM : 0, 0, 3, 0

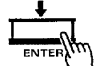

INPUT OFF TIME

OFF 00:30

**7** Select the REC mode.

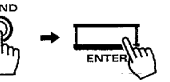

SELECT MODE

MODE REC

The timer modes are switched between PLAY and REC every time the BAND key is pressed.

**8** Select the preset key under which the station to be received has been preset.

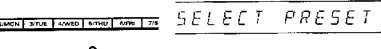
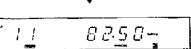
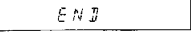
- The station should be preset to the preset memory of 20 or less.

**9** Set up the cassette deck ready for recording.

- Insert a tape in Deck B.
- Set the tape transport direction.
- Select the side(s) to be recorded onto.
- Select the Dolby NR mode.

- The auto-bias adjustment cannot be used.

**10** Adjust the recording level.

Press the CRLS key.



- It is not necessary to adjust the volume and tone.

**11** Activate the execution of the program.

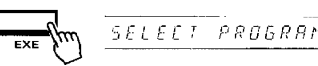
- 
- Select the program No. to be executed by pressing the numeric key under which it is set.

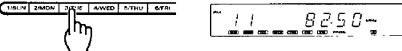

- The selected program No. indicator lights up.

**12** Switch the power OFF.

Press the POWER key of the receiver.



- Notes:
- If you commit a mistake in the timer programming, press the CLEAR key and re-start from the beginning.
  - If it is required to modify a program which has already been set, set a new program from the beginning.
  - When a program has previously been set in the program No. selected in step 3, the newly-set program replaces the previous program.
  - When the power is turned ON by the timer, the volume level is automatically set to the lowest level.
  - Do not operate the CLEAR key or POWER key while the timer program execution has been activated; otherwise malfunction will occur.

Be sure to adjust the present time before proceeding the following.

## ■ To check timer program contents

### 1 Press the PROGRAM key.



### 2 Press the numeric key corresponding to the program to be checked.



- If no program is selected while the program No. indicators are blinking, the previous display condition resumes.
- When a program is selected, its contents will be displayed for about 3 seconds, and the previous display resumes after it.

## ■ To cancel timer program execution

### 1 Press the CLEAR key.

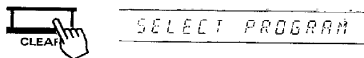

### 2 Press the numeric key corresponding to the program the execution of which is to be cleared.

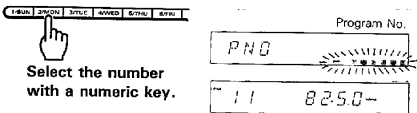

Select the number with a numeric key.

- The program contents are not cleared even when its execution is canceled.

## Re-activation of timer execution after canceling it

Since the program itself is retained in memory, check its contents and perform the operation from the step "Activate the execution of the program" as follows.

- 1 Press EXE key.
- 2 Select the program No. to be executed by pressing the numeric key under which it is set.
- 3 Adjust the volume and tone in case of timer reception of broadcast or timer playback of CD or tape.
- 4 Switch the power OFF.

## ■ Operation of one-touch timer

Press the O.T.T. key allows to switch power ON after a specified time period, set in the unit of 30 minutes, from the moment it is activated.

### 1 Set the timer ON time.

Press the O.T.T. key.



O.T.T. lights up.

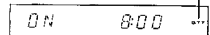

The ON time of the timer is displayed.

The displayed time is incremented by 30 minutes every time the key is pressed.

- When the key is pressed once, a time that can be divided by 30 minutes and within 30 minutes from the present time is displayed as the ON time. (Example: When pressed at 7:40, "8:00" will be displayed.)
- The ON time is incremented in 30-minute steps, for example from 0:00 to 0:30, 1:00, 1:30, and so on.
- The ON time can be set up to 12 hours later.
- The one-touch timer can be set even when the power is OFF.

### 2 Switch the power OFF.

Press the POWER key of the receiver.



- The ON time can be checked by pressing the O.T.T. key once.
- When the power is switched ON, the sleep timer will automatically be set to 60 minutes.
- When the power is switched ON, the last program source (CD, TAPE) will be played.

## To cancel one-touch timer activated

Switch the power ON,  
or  
Press the O.T.T. key until the O.T.T. indicator goes off.

### Notes:

1. If disc is not present while the CD input is selected or cassette tape is not present while the TAPE input is selected, the last broadcasting station received will be received again. The last broadcasting station received will also be received if an input other than CD and TAPE is selected.
2. Please note that pressing the ADJUST key cancels the one-touch timer.

## Operation of timer

When the AI TIMER 1 or 2 key is pressed after the program timer setting has completed, the functions as shown below can be added to the program timer function. The AI TIMER 1 and AI TIMER 2 do not function in the timer recording mode.

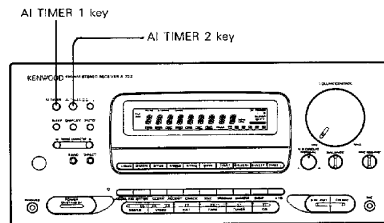

### ■ Operation of AI TIMER 1

With this function, when the power is switched ON by the program timer, the volume increases in three steps.

#### 1 Complete the program timer setting.

- Turn the power of the receiver OFF.

#### 2 Select the maximum volume. AI TIMER 1

Press the AI TIMER 1 key.

- The AI TIMER 1 indicator lights up.



VOL 1 (Small) → VOL 2 (Medium) → VOL 3 (Large) → OFF (Goes off)

- The maximum volume setting varies every time the key is pressed. When the key is released, the indicator goes out and the maximum volume setting set at that moment is stored in memory.

#### To cancel the execution of AI TIMER 1

Press the AI TIMER 1 key to select OFF.

- The AI TIMER 1 indicator goes off.

AI TIMER 1



#### Reference for volume selection

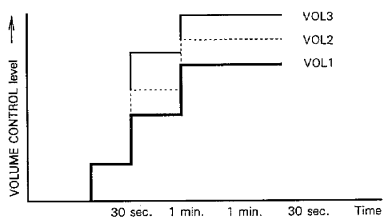

- The VOLUME CONTROL rotates as the volume changes.
- The graphic equalizer curve also varies accordingly.

### ■ Operation of AI TIMER 2

With this function, when the power is turned ON by the program timer, two tracks on a CD are played first, then radio broadcast is received automatically.

This function is given precedence to other program timer functions.

#### 1 Place a CD in the CD player.

#### 2 Perform steps of "Timer reception of radio broadcast".

- Refer to page 63.

#### 3 Press the AI TIMER 2 key.

- The AI TIMER 2 indicator lights up.

AI TIMER 2



- Also press the AI TIMER 1 key if you want to increase the volume in three steps.

#### To cancel the execution of AI TIMER 2

Press the key again.

- The AI TIMER 2 indicator goes off.

AI TIMER 2



#### Notes:

1. When the MASTER VOL. key or MUTE key on the remote control unit is operated while the AI TIMER 1 is operated, the volume level is locked.
2. When the select key other than CD is pressed during CD play of AI TIMER 2, the CD stops to play and AI TIMER 2 is canceled.
3. When one of the operation keys of the CD player is pressed during CD play of AI TIMER 2, the two tracks of the CD are played, but AI TIMER 2 is suspended after it.
4. In case no disc has been placed in the CD player, radio broadcast is received without playing a CD.
5. The AI TIMER 1 and AI TIMER 2 indicators will remain lighted after the operation of the program timer has been completed. Be sure that the AI TIMER indicators are not lighted when not using the AI TIMER function.
6. If the graphic equalizer control key is operated during AI TIMER 1 operation, the AI TIMER does not operate correctly.

## ■ Operation of sleep timer

The sleep timer allows to turn the system power off after the specified period has elapsed. This function may be most convenient when you like to fall in sleep while listening to music.

The period can be set up to 90 minutes in 10-minute steps. The sleep timer is applied in priority over other timer programs.

### 1 Switch the power ON.



Press the POWER key of the receiver.

### 2 Specify the period after which the power is to be switched OFF.

Press the SLEEP key.

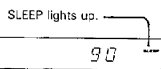

90 → 80 → 70 → ..... → 20 → 10 → canceled

- Each press decreases the period by 10 minutes.

### To cancel sleep timer

Press the SLEEP key until the sleep timer is canceled, or  
Switch the power OFF.

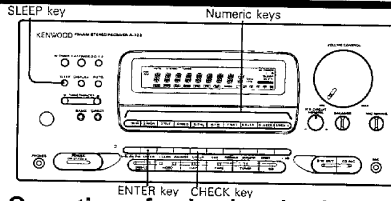

## ■ Operation of calendar check

The calendar check allows to display the day of the week of the specified date input by the user in the order of year, month and day. This function covers the range from January 1, 1900 to December 31, 2099.

### 1 Press the CHECK key.



INPUT YEAR

### 2 Input the year with the numeric keys.

Year 1992: 1, 9, 9, 2



YEAR 1992



INPUT DATE

### 3 Input the month then the day with the numeric keys.

March 30: 0, 3, 3, 0



DATE 0330



1992 3-30

Day of the week

- The day-of-the-week indicator of the date input above lights up. The previous display resumes in a few seconds.

## In case of difficulty

What appears to be a malfunction may not always be serious. If your unit should not perform as expected, consult the table below to see if the problem can be corrected before seeking help from your dealer or service representative.

### Remote control unit

Symptom	Cause	Remedy
Remote control operation is not possible.	<ul style="list-style-type: none"> <li>Batteries are exhausted.</li> <li>The parallel cord is not connected properly.</li> <li>The remote control unit is too far away from the main system, controlling angle is too large, or there is an obstacle in between.</li> <li>The source component to be operated does not contain the tape(s) or CD.</li> <li>An attempt is made to play a tape which is being recorded in the cassette deck.</li> </ul>	<ul style="list-style-type: none"> <li>Replace with new batteries.</li> <li>Connect properly referring to "System connections".</li> <li>Operate the remote control unit within the controllable range.</li> <li>Place the tape(s) or CD in the source component to be played.</li> <li>Wait until the recording is completed.</li> </ul>

### Receiver, speakers

Symptom	Cause	Remedy
Sound is not output.	<ul style="list-style-type: none"> <li>The speaker cords are disconnected.</li> <li>The volume is set to the minimum position.</li> <li>The MUTE key of the remote control unit is set to ON and the point indicator is blinking.</li> <li>The parallel cord is not connected properly.</li> <li>The headphones plug is left inserted in the PHONES jack.</li> </ul>	<ul style="list-style-type: none"> <li>Connect them properly referring to "System connections".</li> <li>Adjust the volume to a proper level.</li> <li>Press the MUTE key to OFF.</li> <li>Connect properly referring to "System connections."</li> <li>Remove the plug.</li> </ul>
No sound comes out, and "PROTECT" is shown on the display.	<ul style="list-style-type: none"> <li>Speaker cords are short-circuited.</li> </ul>	<ul style="list-style-type: none"> <li>Turn the power off, eliminate the short-circuiting, then turn on the power again.</li> </ul>
Sound is not output from one of the speakers.	<ul style="list-style-type: none"> <li>The speaker cord is disconnected.</li> <li>The BALANCE control is set to an extreme position.</li> </ul>	<ul style="list-style-type: none"> <li>Connect it properly referring to "System connections".</li> <li>Adjust the Left/Right balance.</li> </ul>
Sound is not output from the Surround rear speaker and/or center speaker, or their sound is very small.	<ul style="list-style-type: none"> <li>The rear-speaker cords and/or center speaker cord are disconnected.</li> <li>The Surround play mode has not been engaged.</li> <li>The REAR VOL. and/or CENTER VOL. controls are set to the minimum level.</li> </ul>	<ul style="list-style-type: none"> <li>Connect them properly referring to "System connections".</li> <li>Set the Dolby Surround or DSP presence mode.</li> <li>Adjust the REAR VOL. and CENTER VOL. controls.</li> </ul>
The clock display is blinking without changing from a certain time.	<ul style="list-style-type: none"> <li>There was a power failure.</li> <li>The power cord was unplugged.</li> </ul>	<ul style="list-style-type: none"> <li>Set the current time again.</li> <li>Set the current time again.</li> </ul>
The timer does not work.	<ul style="list-style-type: none"> <li>The current time is not set, or there was a power failure.</li> <li>The timer ON time and OFF time have not been set.</li> <li>The timer execution has not been specified.</li> </ul>	<ul style="list-style-type: none"> <li>Set the current time referring to "Time adjustment".</li> <li>Set the timer ON time and OFF time.</li> <li>Specify execution by pressing the [EXE] key.</li> </ul>
Radio stations cannot be received.	<ul style="list-style-type: none"> <li>No antenna is connected.</li> <li>The broadcast band is not set properly.</li> <li>The frequency of the desired station is not tuned.</li> </ul>	<ul style="list-style-type: none"> <li>Connect an antenna.</li> <li>Set the broadcast band properly.</li> <li>Tune the frequency of the desired station.</li> </ul>
A station which was preset cannot be received by pressing the corresponding numeric key.	<ul style="list-style-type: none"> <li>The preset station belongs to a frequency that cannot be received.</li> <li>The preset memory was cleared because the power cord had been unplugged for a long period of time.</li> </ul>	<ul style="list-style-type: none"> <li>Preset a station with a receivable frequency.</li> <li>Preset the station again.</li> </ul>
Interference.	<ul style="list-style-type: none"> <li>Noise due to ignition noise of an automobile.</li> <li>Noise due to an influence from an electric appliance.</li> <li>Noise due to a nearby TV set.</li> </ul>	<ul style="list-style-type: none"> <li>Install the outdoor antenna apart from the road.</li> <li>Turn off the power of the appliance.</li> <li>Install the system more apart from the TV set.</li> </ul>

## Cassette decks

Symptom	Cause	Remedy
Sounds is not produced when the Play key is pressed.	<ul style="list-style-type: none"> <li>The parallel cord is not connected properly.</li> <li>The head is dirty.</li> <li>Tape is irregularly wound and hard to take up.</li> <li>A non-recorded tape is being played.</li> </ul>	<ul style="list-style-type: none"> <li>Connect properly referring to "System connections".</li> <li>Clean the head referring to "Cleaning the head section".</li> <li>Replace the tape.</li> <li>Play a recorded tape.</li> </ul>
The deck does not work when an operation key is pressed.	<ul style="list-style-type: none"> <li>The cassette holder is not closed completely.</li> <li>The operation key was pressed immediately after closing the cassette holder.</li> <li>The operation key was pressed within less than 3 seconds after the power was turned on.</li> <li>Tape is not inserted.</li> <li>Tape is irregularly wound and hard to take up.</li> <li>Tape has been fully wound to reel.</li> </ul>	<ul style="list-style-type: none"> <li>Close the cassette holder completely.</li> <li>Press the desired operation key in a few seconds after closing the cassette holder.</li> <li>Press the desired operation key in more than 3 seconds after turning the power on.</li> <li>Insert a tape.</li> <li>Replace the tape.</li> <li>Change the tape transport direction or insert the tape inversely.</li> </ul>
DPSS malfunctions.	<ul style="list-style-type: none"> <li>The tape is not suitable for DPSS operation, for example the spaces between tunes are too short.</li> </ul>	<ul style="list-style-type: none"> <li>Read "DPSS operation".</li> </ul>
CCRS does not work.	<ul style="list-style-type: none"> <li>A recordable tape is not inserted in Deck B.</li> <li>A disc is not placed in the CD player.</li> <li>The disc is dirty.</li> </ul>	<ul style="list-style-type: none"> <li>Insert a recordable tape in Deck B and press the CCRS key.</li> <li>Place a disc in the CD player and press the CCRS key.</li> <li>Clean the disc, place it in the CD player, and press the [CCRS] key.</li> </ul>
The dubbing on Deck A and Deck B ends at different timing.	<ul style="list-style-type: none"> <li>This is due to the difference in tape length or to the characteristics of the cassette deck mechanisms.</li> </ul>	<ul style="list-style-type: none"> <li>A small time difference is not regarded as a failure.</li> </ul>
The cassette holder does not open when the Eject key is pressed.	<ul style="list-style-type: none"> <li>The key is pressed during recording or playback.</li> </ul>	<ul style="list-style-type: none"> <li>Press in the Stop mode.</li> </ul>
Sound is hoarse, or high frequencies are not audible.	<ul style="list-style-type: none"> <li>The head is dirty.</li> <li>The tape is stretched or wrinkled.</li> </ul>	<ul style="list-style-type: none"> <li>Clean the head referring to "Cleaning the head section".</li> <li>Replace the tape.</li> </ul>
Sound is distorted.	<ul style="list-style-type: none"> <li>The recording level has not been set by the CRLS key.</li> <li>A tape recorded with distorted sound is being played.</li> </ul>	<ul style="list-style-type: none"> <li>Adjust the recording level referring to "Recording operation on cassette deck".</li> <li>Replace the tape.</li> </ul>
Recording is not initiated when the Recording key is pressed.	<ul style="list-style-type: none"> <li>The protection tab on the cassette has been broken.</li> <li>The cassette holder is not closed completely.</li> <li>The TAPE input selector is selected on the receiver.</li> <li>Tape has been fully wound to a reel.</li> </ul>	<ul style="list-style-type: none"> <li>Use a cassette with unbroken tab, or close the hole.</li> <li>Close the cassette holder completely.</li> <li>Press the input select key of the source to be recorded.</li> <li>Change the tape transport direction of Deck B or insert the tape inversely.</li> </ul>
Noise level is high.	<ul style="list-style-type: none"> <li>The head is magnetized.</li> <li>External noise is induced.</li> <li>A tape recorded with Dolby NR ON is being played with Dolby NR OFF.</li> </ul>	<ul style="list-style-type: none"> <li>Demagnetize the head referring to "Cleaning the head section".</li> <li>Install the system apart from other electrical appliances and TV set.</li> <li>Press the [DOLBY NR] key to B or C.</li> </ul>
Sound is vibrating.	<ul style="list-style-type: none"> <li>The capstans or pinch rollers are dirty.</li> <li>Tape is irregularly wound.</li> </ul>	<ul style="list-style-type: none"> <li>Clean the head referring to "Cleaning the head section".</li> <li>Wind the tape regularly by fast forwarding, rewinding or playing it fully from one reel to another.</li> </ul>

## In case of difficulty

### Graphic equalizer

Symptom	Cause	Remedy
Volume is too low.	<ul style="list-style-type: none"><li>The equalizer levels are set too low at all frequency ranges.</li></ul>	<ul style="list-style-type: none"><li>Increase the levels of the multi-control keys.</li></ul>

### CD player

Symptom	Cause	Remedy
Disc has been placed but it cannot be played.	<ul style="list-style-type: none"><li>The disc is placed upside down.</li><li>The disc is very dirty.</li><li>The disc is scratched or damaged.</li><li>Dew is condensed on the optics lenses.</li></ul>	<ul style="list-style-type: none"><li>Place the disc properly, with the labeled side up.</li><li>Clean the disc then play it again.</li><li>Replace the disc.</li><li>Remove condensed dew by referring to "Beware of condensation".</li></ul>
Sound is not produced.	<ul style="list-style-type: none"><li>Disc is not placed.</li><li>The CD player is not set in the play mode.</li><li>The parallel cord is not connected properly.</li></ul>	<ul style="list-style-type: none"><li>Place a disc and play it.</li><li>Press the play/pause key.</li><li>Connect properly referring to "System connections".</li></ul>
Sound skips.	<ul style="list-style-type: none"><li>The disc is dirty.</li><li>The disc is scratched or damaged.</li><li>Vibrations are applied to the CD player.</li></ul>	<ul style="list-style-type: none"><li>Clean the disc then play it again.</li><li>Replace the disc.</li><li>Install the system in a place which is not subject to vibrations.</li></ul>

#### Notes:

- With some tapes, a squeaky noise is produced when the tape is stopped automatically. This is due to the tape protection function, and not a malfunction.
- Do not use 120-minute tapes, for the tape is too thin and gets easily tangled.
- This system is microprocessor-controlled, so malfunction may occur due to external noise or interference noise. In such a case, unplug the power cord, plug it and turn power on again.
- Do not use contact cleaners because it could cause a malfunction. Be specially careful against contact cleaners containing oil, for they may deform the plastic components.



When your unit needs to be repaired, bring the entire set (Speakers excluded) to your dealer.

#### For the U.S.A. FCC WARNING

This equipment may generate or use radio frequency energy. Changes or modifications to this equipment may cause harmful interference unless the modifications are expressly approved in the instruction manual. The user could lose the authority to operate this equipment if an unauthorized change or modification is made.

#### NOTE:

This equipment has been tested and found to comply with the limits for a Class B digital device, pursuant to Part 15 of the FCC Rules. These limits are designed to provide reasonable protection against harmful interference in a residential installation. This equipment may cause harmful interference to radio communications, if it is not installed and used in accordance with the instructions. However, there is no guarantee that interference will not occur in a particular installation. If this equipment does cause harmful interference to radio or television reception, which can be determined by turning the equipment off and on, the user is encouraged to try to correct the interference by one or more of the following measures:

- Reorient or relocate the receiving antenna.
- Increase the separation between the equipment and receiver.
- Connect the equipment into an outlet on a circuit different from that to which the receiver is connected.
- Consult the dealer or an experienced radio/TV technician for help.

#### Strömbrytarens POWER beredskapsläge

Indikatorn STAND BY tänds efter nätkabelns anslutning till ett vägguttag, oavsett strömbrytarens POWER till/frånslag. Detta anger att en liten mängd ström leds till komponenten som stöd för minnesinnehållet.

Detta läge kallas för beredskapsläget. Strömbrytaren på fjärrkontrollen kan användas för att slå på och av strömmen så länge indikatorn STAND BY lyser.

#### Virtanäppäimen (POWER) valmiustila (STAND BY)

Kun laitteen verkkojohto on liitetty pistorasiaan, valmiustilan merkkivalo syytty riippumatta virtanäppäimen (POWER) asennosta (ON/OFF). Merkkivalo osoittaa, että laitteessa on hieman virtaa muistin sisältöjen ylläpitoa varten. Tätä tilää kutsutaan valmiustilaksi. Kun valmiustilan merkkivalo (STAND BY) palaa, laitteen virta voidaan kytkeä ja katkaista kaukosäätimellä.

#### Afbrydertastens (POWER) STAND BY funktion

Når apparatets strømledning er tilsluttet en stikkontakt, lyser STAND BY indikatoren, uanset om der er tændt ved afbryderen på apparatet eller ej. Det angiver, at apparatet bliver forsynet med en ganske lille mængde strøm til opret-holdelse af hukommelsens indhold.

Denne funktion kaldes STAND BY. Når STAND BY indikatoren er tændt, kan strømmen til apparatet slås til og fra med fjernstyringsenheden.

#### PÅ/AV-knappens Stand-by funksjon

Når strømledningen til dette anlegget er satt i en vekselstrømskontakt, vil STAND-BY indikatorlampen lyse enten PÅ/AV-knappen er på- eller avslått. Dette betyr at en viss mengde strøm tilføres anlegget slik at innholdet i minnet ikke går tapt.

Denne funksjonen kalles Stand-by. Når indikatorlampen for STAND-BY er tent, kan strømmen slås PÅ/AV fra fjernkontrollen.

## Receiver unit (A-722L)

(For U.K. and Europe)

### Amplifier section

Rated power output  
(IHF'66) From 40 Hz to 20 kHz, 0.09% T.H.D.  
at 6 Ω ..... 35 W + 35 W  
(IEC/NF) From 63 Hz to 12,500 Hz, 0.7% T.H.D.  
at 6 Ω ..... 35 W + 35 W  
at 8 Ω ..... 30 W + 30 W  
(DIN) 1 kHz, at 6 Ω ..... 40 W + 40 W  
1 kHz, at 8 Ω ..... 35 W + 35 W  
Total harmonic distortion ..... 0.06% (at 1 kHz, 18 W, 6 Ω)  
Frequency response  
MAIN IN ..... 40 Hz - 70 kHz, +0 dB, -3.0 dB  
Signal to noise ratio (IHF'66)  
MAIN IN ..... 100 dB  
Input sensitivity/Impedance  
MAIN IN ..... 150 mV/47 kΩ  
MIC ..... 1.2 mV/47 kΩ  
N.B.circuit (-30 dB VOLUME level) ..... +16 dB (at 60 Hz)  
Output level/Impedance  
SUPER WOOFER OUT ..... 1.5 V/3.6 kΩ

### FM tuner section

Tuning frequency range ..... 87.5 MHz - 108 MHz  
Usable sensitivity (DIN at 75 Ω)  
MONO ..... 0.7 μV  
Total harmonic distortion (DIN at 1 kHz)  
MONO ..... 0.6% (65.2 dBf input)  
STEREO ..... 0.8% (65.2 dBf input)  
Signal to noise ratio (DIN weighted at 1 kHz)  
MONO ..... 70 dB (65.2 dBf input)  
STEREO ..... 64 dB (65.2 dBf input)  
Selectivity (DIN ±300 kHz) ..... 60 dB  
Stereo separation (DIN)  
1 kHz ..... 45 dB  
Frequency response ..... 30 Hz - 15 kHz, +0.5 dB, -3.0 dB

### MW tuner section

Tuning frequency range ..... 531 kHz - 1,602 kHz  
Usable sensitivity ..... 20 μV/(500 μV/m)  
Signal to noise ratio  
(at 30% mod. 1 mV input) ..... 48 dB

### LW tuner section

Tuning frequency range ..... 153 kHz - 281 kHz  
Usable sensitivity ..... 22 μV  
Signal to noise ratio  
(at 30% mod. 1 mV input) ..... 45 dB  
Power consumption ..... 130 W  
Dimensions ..... W: 270 mm (10-5/8")  
H: 120 mm (4-3/4")  
D: 300 mm (11-13/16")  
Weight (Net) ..... 6.5 kg (14.3 lb)

## Receiver unit (A-722)

(For other countries)

### Amplifier section

Rated power output  
For the U.S.A.

35 watts per channel minimum RMS, both channels driven,  
at 6 Ω from 40 Hz to 20,000 Hz with no more than 0.09%  
total harmonic distortion (FTC)

For other countries

(IHF'66) From 40 Hz to 20 kHz, 0.09% T.H.D.  
at 6 Ω ..... 35 W + 35 W  
(IEC/NF) From 63 Hz to 12,500 Hz, 0.7% T.H.D.  
at 6 Ω ..... 35 W + 35 W  
at 8 Ω ..... 30 W + 30 W  
Total harmonic distortion ..... 0.06% (at 1 kHz, 18 W, 6 Ω)  
Frequency response  
MAIN IN ..... 40 Hz - 70 kHz, +0 dB, -3.0 dB  
Signal to noise ratio (IHF'66)  
MAIN IN ..... 100 dB  
Input sensitivity/Impedance  
MAIN IN ..... 150 mV/47 kΩ  
MIC ..... 1.2 mV/47 kΩ  
N.B.circuit (-30 dB VOLUME level) ..... +16 dB (at 60 Hz)  
Output level/Impedance  
SUPER WOOFER OUT ..... 1.5 V/3.6 kΩ

### FM tuner section

Tuning frequency range ..... 87.5 MHz - 108 MHz  
Usable sensitivity (MONO at 75 Ω) ..... 1.2 μV/12.8 dBf  
Total harmonic distortion (at 1 kHz)  
MONO ..... 0.5% (65 dBf input)  
STEREO ..... 0.6% (65 dBf input)  
Signal to noise ratio (at 1 kHz)  
MONO ..... 80 dB (85 dBf input)  
STEREO ..... 74 dB (85 dBf input)  
Selectivity (±400 kHz) ..... 50 dB  
Stereo separation 1 kHz ..... 38 dB  
Frequency response ..... 30 Hz - 15 kHz, +0.5 dB, -3.0 dB

### AM tuner section

Tuning frequency range  
9 kHz step ..... 531 kHz - 1,602 kHz  
10 kHz step ..... 530 kHz - 1,610 kHz  
Usable sensitivity ..... 20 μV/(500 μV/m)  
Signal to noise ratio  
(at 30% mod. 1 mV input) ..... 48 dB  
Power consumption ..... 1.5 A (for the U.S.A.)  
180 W (for other countries)  
Dimensions ..... W: 270 mm (10-5/8")  
H: 120 mm (4-3/4")  
D: 300 mm (11-13/16")  
Weight (Net) ..... 6.5 kg (14.3 lb)

**⚠ Caution : Read this page carefully to ensure safe operation.**

### Graphic equalizer unit (GE-722)

Equalizer characteristics variable range..... ± 10 dB  
Individual channel adjust:  
60 Hz, 150 Hz, 400 Hz, 1 kHz, 2.4 kHz, 6 kHz, 15 kHz  
AI LOUDNESS control..... + 5 dB (max.) (100 Hz)  
+ 4 dB (max.) (10 kHz)  
Signal to noise ratio (IHF' 66) ..... 100 dB  
Power consumption ..... AC 17.5 V, 1.6 A  
Dimensions..... W: 270 mm (10-5/8")  
H: 85 mm (3-3/8")  
D: 255 mm (10-1/16")  
Weight (Net) ..... 2.6 kg (5.73 lb)

### CD player unit (DP-722)

Laser..... Semiconductor laser  
Playing rotation ..... 200 rpm - 500 rpm (CLV)  
Frequency response ..... 20 Hz - 20 kHz, ± 1.0 dB  
Signal to noise ratio ..... More than 93 dB  
Wow & Flutter ..... Unmeasurable Limit  
Total harmonic distortion ..... Less than 0.015% (at 1 kHz)  
Channel separation..... More than 85 dB (at 1 kHz)  
Optical output (Wave length 660 nm).... - 15 dBm - - 21 dBm  
Power consumption ..... AC 9 V, 0.9 A  
Dimensions..... W: 270 mm (10-5/8")  
H: 85 mm (3-3/8")  
D: 255 mm (10-1/16")  
Weight (Net) ..... 2.0 kg (4.4 lb)

### Cassette deck unit (X-722)

Recording system ..... AC bias (Frequency: 105 kHz)  
Heads A Deck Playback head ..... 1  
B Deck Playback/recording head..... 1  
Erasing head ..... 1  
Motor A Deck..... 1  
B Deck..... 1  
Fast winding time..... Approx. 105 seconds (C-60 tape)  
Frequency response  
Normal tape ..... 35 Hz - 17,000 Hz ± 3 dB  
CrO<sub>2</sub> tape ..... 35 Hz - 18,000 Hz ± 3 dB  
Metal tape ..... 35 Hz - 18,000 Hz ± 3 dB  
Signal to noise ratio  
Dolby NR OFF ..... 58 dB (Metal tape)  
Dolby B NR ON ..... 66 dB (Metal tape)  
Dolby C NR ON ..... 74 dB (Metal tape)  
Wow & flutter..... 0.08% (W.R.M.S.)  
± 0.18% (DIN)  
Harmonic distortion  
(at 1 kHz, 3rd H.D., metal tape)..... Less than 0.9%  
Input sensitivity/Impedance..... Line × 77.5 mV/50 kΩ  
Output level/Impedance ..... Line × 387.5 mV/2.2 kΩ  
Power consumption ..... AC 14 V, 1 A  
Dimensions..... W: 270 mm (10-5/8")  
H: 120 mm (4-3/4")  
D: 259 mm (10-3/16")  
Weight (Net) ..... 2.8 kg (6.17 lb)

### Speakers (LS-722)

Enclosure ..... Bass-reflex type  
Speaker configuration..... 2-Way system  
Woofer ..... 150 mm, cone type  
Tweeter ..... 25 mm, soft dome type  
Presence speaker ..... 100 mm, cone type  
Impedance  
Front speaker..... 6 Ω  
Presence speaker ..... 8 Ω  
Maximum input level  
Front speaker ..... 70 W  
Presence speaker ..... 30 W  
Output sound pressure  
Front speaker ..... 88 dB/W, 1 m  
Presence speaker ..... 87 dB/W, 1 m  
Frequency response  
Front speaker ..... 43 Hz ~ 20 kHz  
Presence speaker ..... 150 Hz ~ 15 kHz  
Dimensions..... W: 205 mm (8-1/16")  
H: 410 mm (16-1/8")  
D: 285 mm (11-1/4")  
Weight (Net) ..... 6.0 kg (13.2 lb)

Note: KENWOOD follows a policy of continuous advancements in development. For this reason specifications may be changed without notice.

KENWOOD

## Free Manuals Download Website

<http://myh66.com>

<http://usermanuals.us>

<http://www.somanuals.com>

<http://www.4manuals.cc>

<http://www.manual-lib.com>

<http://www.404manual.com>

<http://www.luxmanual.com>

<http://aubethermostatmanual.com>

Golf course search by state

<http://golfingnear.com>

Email search by domain

<http://emailbydomain.com>

Auto manuals search

<http://auto.somanuals.com>

TV manuals search

<http://tv.somanuals.com>