

KENWOOD

UD COMPONENT SYSTEM / COMPACT HI-FI SYSTEM

UD-900 UD-900M

INSTRUCTION MANUAL

KENWOOD CORPORATION

This manual contains instructions for two models.
Model availability and features (functions) may differ
depending on the country and sales area.

COMPACT
disc
DIGITAL AUDIO

B60-0841-50(K, P, E, T, M, X, Y) (JA) (MG)
94/12 11 10 9 8 7

Introduction

Your choice of this product indicates that you are a devotee to excellence in sound reproduction.

We appreciate your patronage and take pride in the long tradition of quality components that our company represents.

So that you can get the most out of your unit, we suggest that you take the time to read through this manual before you hook up and operate your system. This will acquaint you with operating features and system-connection considerations so that your listening pleasure will be enhanced right from the start. You will notice that in all aspects of planning, engineering, styling, operating convenience and adaptability we have sought to anticipate your needs and desires.

Keep this manual handy for future reference.

For your records

Record the serial number, found on the back of the unit, in the spaces designated on the warranty card, and in the space provided below. Refer to the model and serial numbers whenever you call upon your dealer for information or service on this product.

Model _____ Serial Number _____

Unpacking

Unpack the unit carefully and make sure that all accessories are put aside so they will not be lost.

Examine the unit for any possibility of shipping damage. If your unit is damaged or fails to operate, notify your dealer immediately. If your unit was shipped to you directly, notify the shipping company without delay. Only the consignee (the person or company receiving the unit) can file a claim against the carrier for shipping damage.

We recommend that you retain the original carton and packing materials for use should you transport or ship the unit in the future.

The marking of products using lasers (Except for some areas.)

**CLASS 1
LASER PRODUCT**

The label is attached to the rear panel and says that the component uses laser beams that have been classified as Class 1. It means that the unit is utilizing laser beams that are of a weaker class. There is no danger of hazardous radiation outside the unit.

WARNING NOTICE:

IN MOST CASES IT IS AN INFRINGEMENT OF COPYRIGHT TO MAKE COPIES OF TAPES OR DISCS WITHOUT THE PERMISSION OF THE COPYRIGHT OWNERS. ANYONE WISHING TO COPY COMMERCIALY AVAILABLE TAPES OR DISCS SHOULD CONTACT THE MECHANICAL COPYRIGHT PROTECTION SOCIETY LIMITED OR THE PERFORMING RIGHTS SOCIETY LIMITED.

When your unit needs to be repaired, bring the entire set (Speakers excluded) to your dealer.

Accessories

- AM loop antenna 1
- FM indoor antenna 1

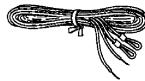
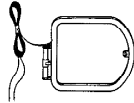

- Loop antenna stand 1
- Antenna adaptor (75Ω / 300Ω) 1 (For U.K. and Europe)



- Batteries (R03 / AAA) 2
- Remote control unit 1

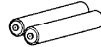

- AC plug adaptor 1 (Except for some areas)
- Speaker cords Red / Black 2 Blue / Black 2

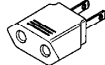

For the unit with a European AC plug in areas other than Europe.

Speaker cords are packed with the speakers. All other accessories are packed with the power amplifier unit.

- Magazine 1 (UD-900M only)



This accessory is packed with the CD player.

Contents

Caution : Read the pages marked carefully to ensure safe operation.

Introduction	2
△Before applying power	3
△Safety precautions	3
△IMPORTANT SAFEGUARDS	4
Before operation	6
FM DE-EMPHASIS / CHANNEL SPACE switch	7
System connections	8
Connection of Audio / Visual components (optional)	12
Controls and indicators	13
Operation of remote control unit	17
Listening to sound	19
Time adjustment	20
Audio adjustment	21
Sound fields	23
DOLBY 3 STEREO	25
DOLBY SURROUND	26

Acoustic Sound	28
Presence	30
Reception of radio broadcast	32
Operation of graphic equalizer	36
Playing CDs (UD-900M)	40
Playing CDs (UD-900)	48
Playback operation of cassette decks	53
DPSS operation	55
Recording operation on cassette deck (Deck B only)	57
Recording of CD playback (CCRS)	61
Tape dubbing	67
Operation with video components	68
Simple Karaoke singing entertainment	69
Operation of timer	70
In case of difficulty	78
Specifications	81

⚠ Caution : Read this page carefully to ensure safe operation.

Before applying power

For the U.S.A. and Canada

Important!

Units shipped to the U.S.A. and Canada are designed for operation on 120 volts AC only.

CAUTION: TO PREVENT ELECTRIC SHOCK DO NOT USE THE AC PLUG WITH AN EXTENSION CORD, RECEPTACLE OR OTHER OUTLET UNLESS THE BLADES CAN BE FULLY INSERTED TO PREVENT BLADE EXPOSURE.

For the United Kingdom

Important!

Units shipped to the U.K. are designed for operation on 240 volts AC only.

The mains plug must be removed from the wall socket prior to any internal examination.

The wires in this mains lead are coloured in accordance with the following code:

Blue Neutral
Brown Live

The wires in this mains lead must be connected to the terminals in the plug as follows:

Wire colour	Plug terminal marking
Blue	N or Black
Brown	L or Red

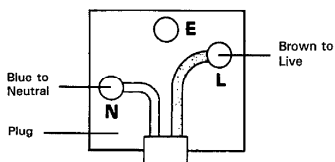

Notes:

1. If a 13-amp plug is used, this must be fitted with a 13-amp fuse.
2. If a 3-pin plug with earthing contact is used, no wire must be connected to the E terminal.

For Australia and Europe

Important!

Units shipped to Australia are designed for operation on 240 V AC only.

Units shipped to Europe are designed for operation on 230 V AC only.

For other countries

Important!

Units shipped to countries other than the above countries are equipped with an AC voltage selector switch on the rear panel. Refer to the following paragraph for the proper setting of this switch.

AC voltage selection

This unit operates on 110-120 or 220-240 volts AC. The AC voltage selector switch Type A or Type B on the rear panel is set to the voltage that prevails in the area to which the unit is shipped. Before connecting the power cord to your AC outlet, make sure that the setting position of this switch matches your line voltage. If not, it must be set to your voltage in accordance with the following direction.

Note:

Our warranty does not cover damage caused by excessive line voltage due to improper setting of the AC voltage selector switch.

AC voltage selector switch

Type A

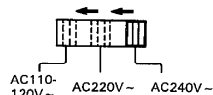



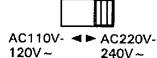

Type B



Move switch lever to match your line voltage with a small screwdriver or other pointed tool.

Safety precautions

WARNING: TO PREVENT FIRE OR ELECTRIC SHOCK, DO NOT EXPOSE THIS APPLIANCE TO RAIN OR MOISTURE.

	CAUTION RISK OF ELECTRIC SHOCK DO NOT OPEN		CAUTION: TO REDUCE THE RISK OF ELECTRIC SHOCK, DO NOT REMOVE COVER (OR BACK). NO USER-SERVICEABLE PARTS INSIDE, REFER SERVICING TO QUALIFIED SERVICE PERSONNEL.
	THE LIGHTNING FLASH WITH ARROWHEAD SYMBOL, WITHIN AN EQUILATERAL TRIANGLE, IS INTENDED TO ALERT THE USER TO THE PRESENCE OF UNINSULATED "DANGEROUS VOLTAGE" WITHIN THE PRODUCT'S ENCLOSURE THAT MAY BE OF SUFFICIENT MAGNITUDE TO CONSTITUTE A RISK OF ELECTRIC SHOCK TO PERSONS.		
	THE EXCLAMATION POINT WITHIN AN EQUILATERAL TRIANGLE IS INTENDED TO ALERT THE USER TO THE PRESENCE OF IMPORTANT OPERATING AND MAINTENANCE (SERVICING) INSTRUCTIONS IN THE LITERATURE ACCOMPANYING THE APPLIANCE.		

IMPORTANT SAFEGUARDS

⚠ Caution : Read this page carefully to ensure safe operation.

Please read all of the safety and operating instructions before operating this unit. For best results, follow all warnings placed on the unit and adhere to the operating and use instructions. These safety and operating instructions should be retained for future reference.

1. Power sources — The unit should be connected to a power supply only of the type described in the operating instructions or as marked on the appliance.

2. Power-cord protection — Power-supply cords should be routed so that they are not likely to be walked on or pinched by items placed upon or against them, pay particular attention to cords at plugs, convenience receptacles, and the point where they exit from the unit.

Never pull or stretch the cord.



3. Grounding or polarization — The precautions should be taken so that the grounding or polarization means of this unit is not defeated.

4. Ventilation — The unit should be situated so that its location or position does not interfere with its proper ventilation.

To maintain good ventilation, do not put records or a table-cloth on the unit. Place the unit at least 10 cm away from the walls.

Do not use the unit on a bed, sofa, rug or similar surface that may block the ventilation openings.

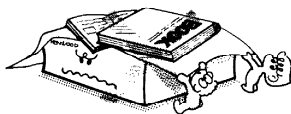

5. Water and moisture — The unit should not be used near water — for example, near a bathtub, washbowl, kitchen sink, laundry tub, in a wet basement, or near a swimming pool, etc.



6. Temperature — The unit may not function properly if used at extremely low, or freezing temperatures. The ideal ambient temperature is above +5°C (41°F).

7. Heat — The unit should be situated away from heat sources such as radiators, heat registers, stoves, or other units (including amplifiers) that produce heat.

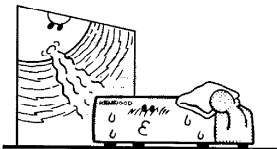

8. Electric shock — Care should be taken so that objects do not fall and liquid is not spilled into the enclosure through openings. If a metal object, such as a hair pin or a needle, comes into contact with the inside of this unit, a dangerous electric shock may result. For families with children, never permit children to put anything, especially metal, inside this unit.

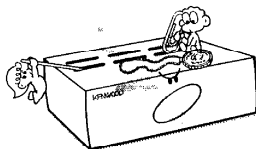

9. Enclosure removal — Never remove the enclosure. If the internal parts are touched accidentally, a serious electric shock might occur.

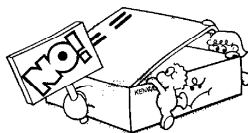

10. Magnetic fields — Keep the unit away from sources of magnetic fields such as TV sets, speaker systems, radios, motorized toys or magnetized objects.

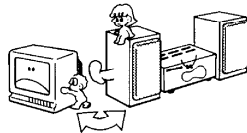

11. Cleaning — Do not use volatile solvents such as alcohol, paint thinner, gasoline, or benzene, etc. to clean the cabinet. Use a clean dry cloth.

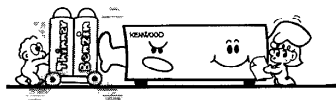

⚠ Caution : Read this page carefully to ensure safe operation.

12. Carts and stands — An appliance and cart combination should be moved with care. Quick stops, excessive force, and uneven surfaces may cause the appliance and cart combination to overturn.



13. Nonuse periods — The power cord of the unit should be unplugged from the outlet when left unused for a long period of time.

14. Abnormal smell — If an abnormal smell or smoke is detected, immediately turn the power OFF and pull out the power cord. Contact your dealer or nearest service center.

POWER OFF!



15. Damage requiring service — The unit should be serviced by qualified service personnel when:

- A. The power-supply cord or the plug has been damaged; or
- B. Objects have fallen, or liquid has been spilled into the unit; or
- C. The unit has been exposed to rain; or
- D. The unit does not appear to operate normally or exhibits a marked change in performance; or
- E. The unit has been dropped, or the enclosure damaged.

16. Servicing — The user should not attempt to service the unit beyond that described in the operating instructions. All other servicing should be referred to qualified service personnel.

17. Outdoor antenna grounding — If an outside antenna is connected to the receiver, be sure the antenna system is grounded so as to provide some protection against voltage surges and built up static charges. Section 810 of the National Electrical Code, ANSI/NFPA 70, provides information with respect to proper grounding of the mast and supporting structure, grounding of the lead-in wire to an antenna discharge unit, size of grounding con-

ductors, location of antenna-discharge unit, connection to grounding electrodes, and requirements for the grounding electrode. See Figure.

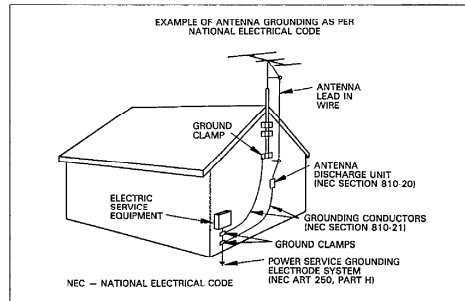

18. Power lines — An outdoor antenna should be located away from power lines.

19. AC outlets — Do not connect other audio equipment with a power consumption larger than that specified to the AC outlet on the rear panel. Never connect other electrical units, such as an iron or toaster, to it to prevent fire or electric shock.

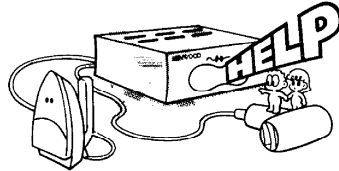

For the U.S.A.

CAUTION:

Use of controls or adjustments or performance of procedures other than those specified herein may result in hazardous radiation exposure.

In compliance with Federal Regulations, following are reproductions of labels on, or inside the product relating to laser product safety.

KENWOOD CORPORATION
SHIONOGI SHIBUYA BUILDING 17-5
2-CHOME, SHIBUYA, SHIBUYA-KU,
TOKYO, JAPAN

KENWOOD CORP. CERTIFIES THIS EQUIPMENT
CONFORMS TO DHHS REGULATIONS NO. 21 CFR
1040.10, CHAPTER I, SUBCHAPTER J.

Location: Back Panel

Notes:

- 1. Item 3 is not required except for grounded or polarized equipment.
- 2. Item 17 and 18 are not required except for units provided with antenna terminals.
- 3. Item 17 complies with UL in the U.S.A.

Before operation

Notes on cassette tape

Safety tab (accidental erasure prevention tab)

After an important recording has been finished, break the safety tab, to prevent the recorded contents from being erased or re-recorded on accidentally.

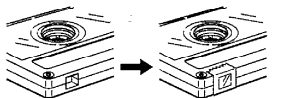
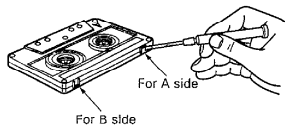

To re-record Apply tape only to the position where the tab has been removed.

To store cassette tapes

Do not store the tapes in a place which is subject to direct sunlight, or near equipment that generates heat. Keep the cassette tapes away from any magnetic field.

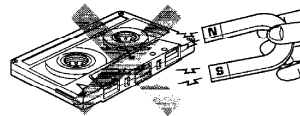

When there is slack in the tape

In such a case, insert a pencil into the reel hole and wind the reel hub to remove the slack.

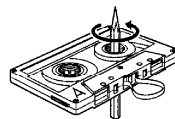

Notes: _____

1. 120-minute cassette tape

Since a 120-minute cassette tape is very thin, the tape could adhere to the pinch roller or be easily cut. It is recommended that these tapes not be used with this unit to prevent possible damage.

2. Endless tapes

Do not use an endless tape, as this could damage the mechanism of the unit.

Cleaning the head section

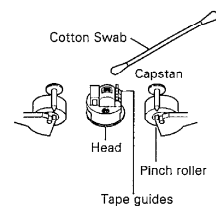

Cleaning the heads and peripheral components

For maintaining the best condition of the deck and for longer service life, always keep the heads (recording / playback / erase), capstan and pinch roller clean. To clean them, perform the following:

1. Open the cassette holder.
2. Using a cotton swab dipped in alcohol, clean the head (recording / playback / erase), capstan and pinch roller carefully.

Demagnetizing the head

When the recording / playback head is magnetized, the sound quality will be deteriorated. In such a case, demagnetize the head using a commercially available demagnetizer (head eraser).

Note: _____

There are precisely aligned parts around the heads, including the tape guides. When cleaning, pay special attention so as not to apply shock to them.

Beware of condensation

When water vapor comes into contact with the surface of cold material, water drops are produced.

If condensation occurs, correct operation may not be possible, or the unit may not function correctly.

This is not a malfunction, however, and the unit should be dried. (To do this, turn the POWER switch ON and leave the unit as it is for several hours.)

Be especially careful in the following conditions:

- When the unit is brought from a cold place to a warm place, and there is a large temperature difference.
- When a heater starts operating.
- When the unit is brought from an air-conditioned place to a place of high temperature with high humidity.
- When there is a large difference between the internal temperature of the unit and the ambient temperature, or in conditions where condensation occurs easily.

Disc handling precautions

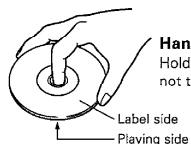

Handling
Hold compact discs so that you do not touch the playing surface.



Do not attach paper or tape to either the playing side or the label side of compact discs.

Caution on disc used

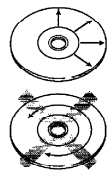
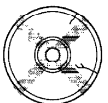

Cleaning

If fingerprints or foreign matter become attached to the disc, lightly wipe the disc with a soft cotton cloth (or similar) from the center of the disc outwards in a radial manner.

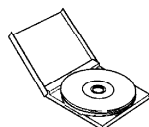

Storage

When a disc is not to be played for a long period of time, remove it from the CD player and store it in its case.

Never play cracked or warped disc.

During playback, the disc rotates at high speed in the player.

Therefore, to avoid danger, never use a cracked or deformed disc or a disc repaired with tape or adhesive agent.

FM DE-EMPHASIS / CHANNEL SPACE switch (Except for some areas)

The FM DE-EMPHASIS / CHANNEL SPACE switch on the rear panel is set to the correct setting that prevails in the area to which the unit is shipped. However, if the FM DE-EMPHASIS / CHANNEL SPACE setting is not matched to the area where the unit is to be used; for instance, when you move from area 1 to area 2 or vice versa, desired reception of AM / FM broadcasts is not expected. In this case, change the FM DE-EMPHASIS / CHANNEL SPACE setting in accordance with the area corresponding to the table. The FM DE-EMPHASIS is switched over at the same time.

- When changing the setting of the FM DE-EMPHASIS / CHANNEL SPACE switch, first disconnect the power cord, then reset the channel space switch, connect the power cord again, and turn the power on.

Area	CHANNEL SPACE freq.	FM DE-EMPHASIS
1. U.S.A., Canada, and South American countries	FM: 100kHz AM: 10kHz	75μs
2. Other countries	FM: 50kHz AM: 9kHz	50μs

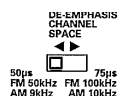

Dolby noise reduction and HX Pro headroom extension manufactured under license from Dolby Laboratories Licensing Corporation. HX Pro originated by Bang & Olufsen. "DOLBY", the double-D symbol and "HX PRO" are trademarks of Dolby Laboratories Licensing Corporation.

Manufactured under license from Dolby Laboratories Licensing Corporation. Additionally licensed under one or more of the following patents: U.S. numbers 3,632,886, 3,746,792 and 3,959,590; Canadian numbers 1,004,603 and 1,037,877. "Dolby" and the double-D symbol are trademarks of Dolby Laboratories Licensing Corporation.

Memory backup function

Stored contents cleared at least 3 days after the last power OFF (STAND BY mode)	Cassette deck (Direction and recording level)
Stored contents cleared immediately when power plug in unplugged from power outlet	Clock of preamplifier / tuner unit
Stored connects cleared in at least 3 days after power plug is unplugged from power outlet	Preset stations of preamplifier / tuner unit

Note related to transportation and movement (CD player)

Before transporting or moving this unit, carry out the following operations.

- Turn the power ON but do not load a disc.
- Wait a few seconds and verify that the display shown appears.

UD-900 display **UD-900M display**
Without magazine, press the key.

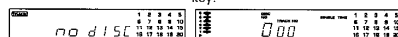

- Turn the power OFF.

System connections

Do not plug in the power cord until all connections are completed.

- When stacking components, follow the indicated order in the connections diagram.
- When connecting the parallel cord, be sure to match the colors of the sockets.
- When connecting the related system components, refer also to the instruction manuals of the related components.

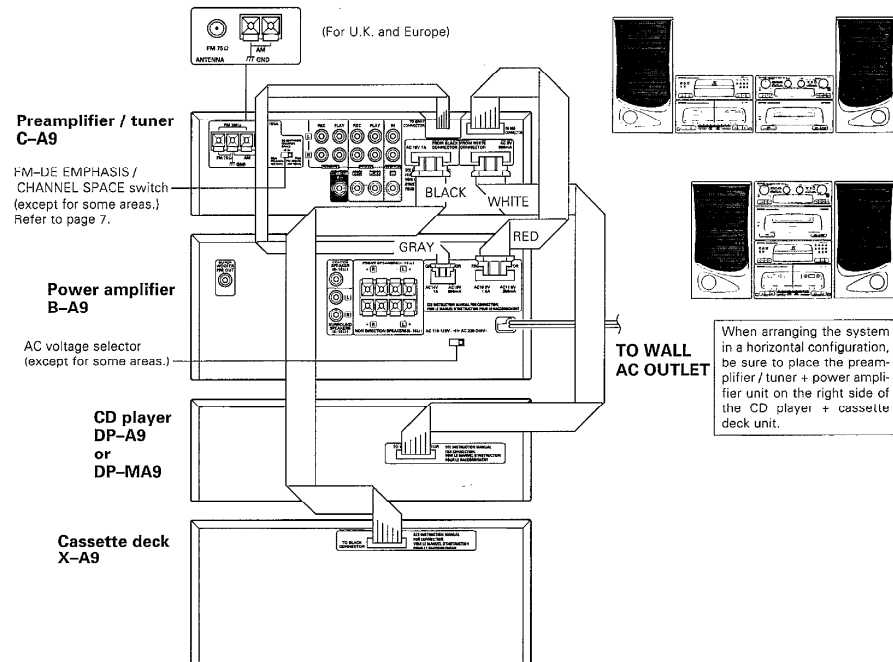

■ Connection of parallel cord

- Fold the connector of the parallel cord in parallel with the socket on the rear panel, and insert securely until it clicks.
- Connect the parallel cord by matching the colors of the connector and socket.
- When unplugging the parallel cord, push and hold the two ends of the connector and pull the connector straight from the rear panel socket.

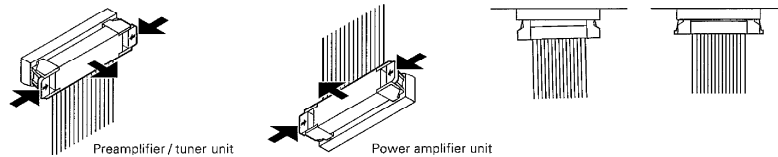

Notes:

- 1 Connect all cords firmly. If connections are loose, there could be loss of sound or noise produced.
- 2 When plugging and unplugging connection cords, be sure to first remove the power cord from the AC outlet. Plugging / unplugging connection cords without removal of the power cord can cause malfunctions or damage to the unit.

Connection method to each antenna terminal

- ① Push lever.
- ② Insert cord.
- ③ Return lever.

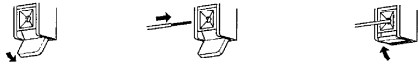

■ AM loop antenna connection

The supplied antenna is for indoor use. Place it as far as possible from the main system, TV set, speaker cords and power cord, and set it to a direction which provides the best reception.

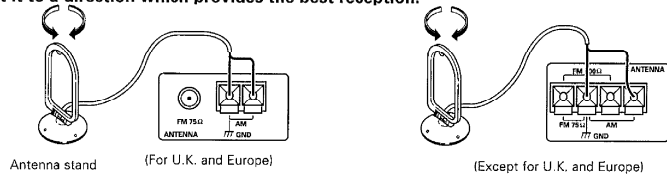

■ AM outdoor antenna connection

If the reception is poor when the AM loop antenna is used, distribute a vinyl-coated wire of more than 6 meters outdoors, without disconnecting the loop antenna.

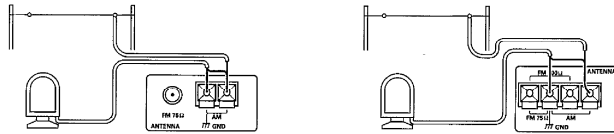

■ FM indoor antenna connection

The supplied antenna is for indoor use. For stable reception, remove the indoor antenna after installing an outdoor antenna as soon as possible.

- ① Find the position that provides best reception.
- ② Fix two ends.

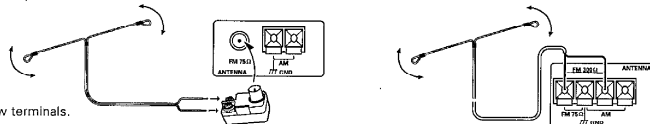

■ FM outdoor antenna connection

It is recommended to install an exclusive FM outdoor antenna to capture FM broadcast with high sound quality. Use a coaxial cable for the connection between the outdoor antenna and FM ANTENNA terminal on the rear panel. For the connection between the coaxial cable and FM ANTENNA terminal, please refer to the illustration.

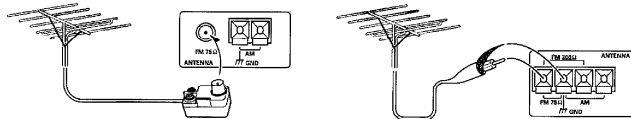

System connections

■ 75 Ω coaxial cable connection (Europe and U.K. only)

① Arrange the coaxial cable as illustrated.

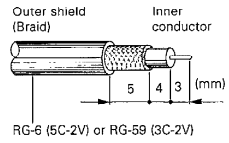

② Open the antenna adaptor.
Open the claws with the fingers to release the lock and pull out the cover.

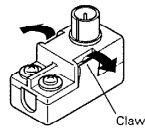

③ Remove the inner conductor from the groove of pole ④ and insert it in the groove of pole ⑤.

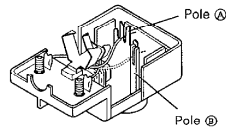

④ Insert into the slit on the clip. Fasten the bands A and B, using a pair of pliers.

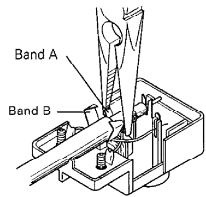

⑤ Close the cover.

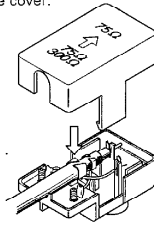

⑥ Connect the adaptor to the antenna terminal.

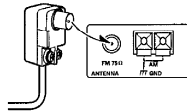

Note:
When using a 300Ω feeder cable, insert its cores into the groove of pole A.

■ Connection of front speakers

On the speaker:

- ① While pressing lever (holding it)
- ② Insert cord.

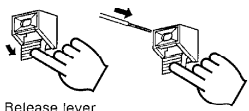

- ③ Release lever.



On the power amplifier:

- ① Push lever.
- ② Insert cord.



- ③ Return lever.

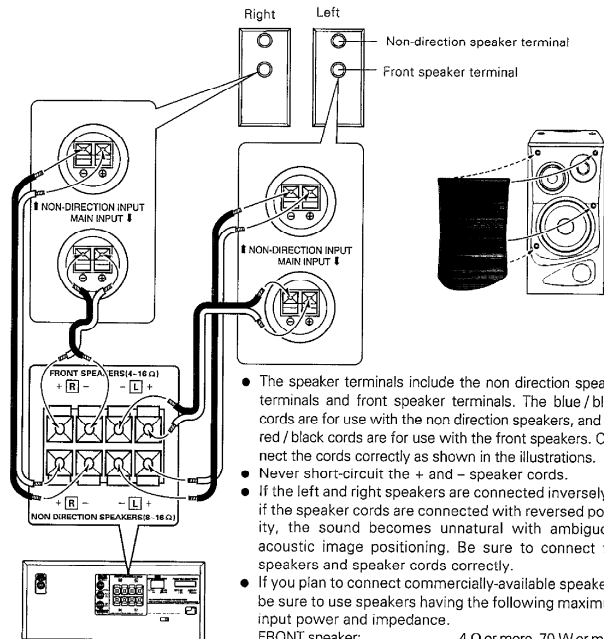

- The speaker terminals include the non direction speaker terminals and front speaker terminals. The blue / black cords are for use with the non direction speakers, and the red / black cords are for use with the front speakers. Connect the cords correctly as shown in the illustrations.
- Never short-circuit the + and - speaker cords.
- If the left and right speakers are connected inversely or if the speaker cords are connected with reversed polarity, the sound becomes unnatural with ambiguous acoustic image positioning. Be sure to connect the speakers and speaker cords correctly.
- If you plan to connect commercially-available speakers, be sure to use speakers having the following maximum input power and impedance.
FRONT speaker: 4 Ω or more, 70 W or more
NON DIRECTION speaker: 8 Ω or more, 45 W or more

■ Connection of surround (rear) and center speakers (optional)

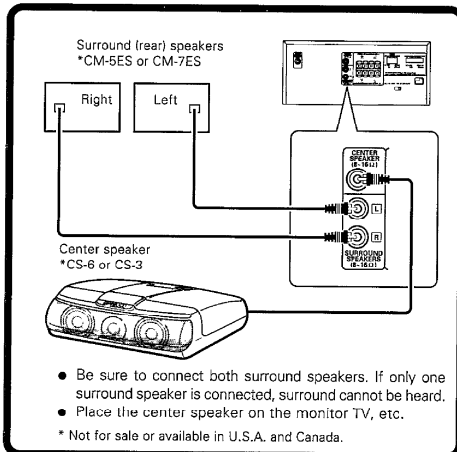

- Be sure to connect both surround speakers. If only one surround speaker is connected, surround cannot be heard.
- Place the center speaker on the monitor TV, etc.

* Not for sale or available in U.S.A. and Canada.

■ Connection of super woofer (optional)

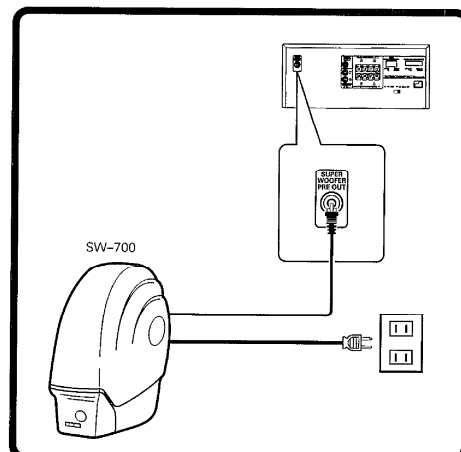

Connection of Audio / Visual components (optional)

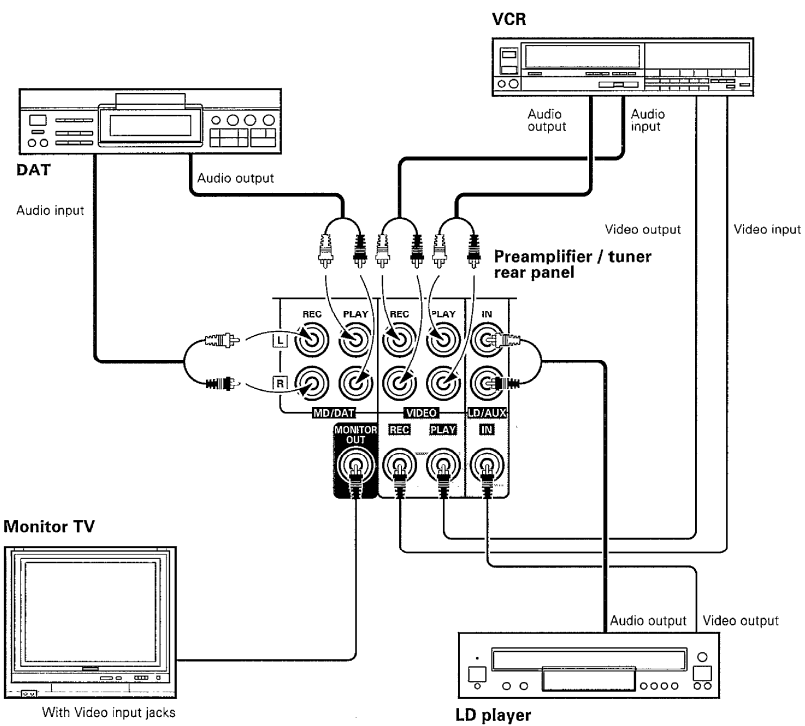

- Connection cords are not supplied with this system.
- Any of the following video equipment can be connected in place of the LD player.
 - DBS tuner
 - Video camera
 - Video recorder
- The DAT input jacks also accept the connection of a MD (mini-disc) player.

Controls and indicators

■ Preamplifier / Tuner Unit

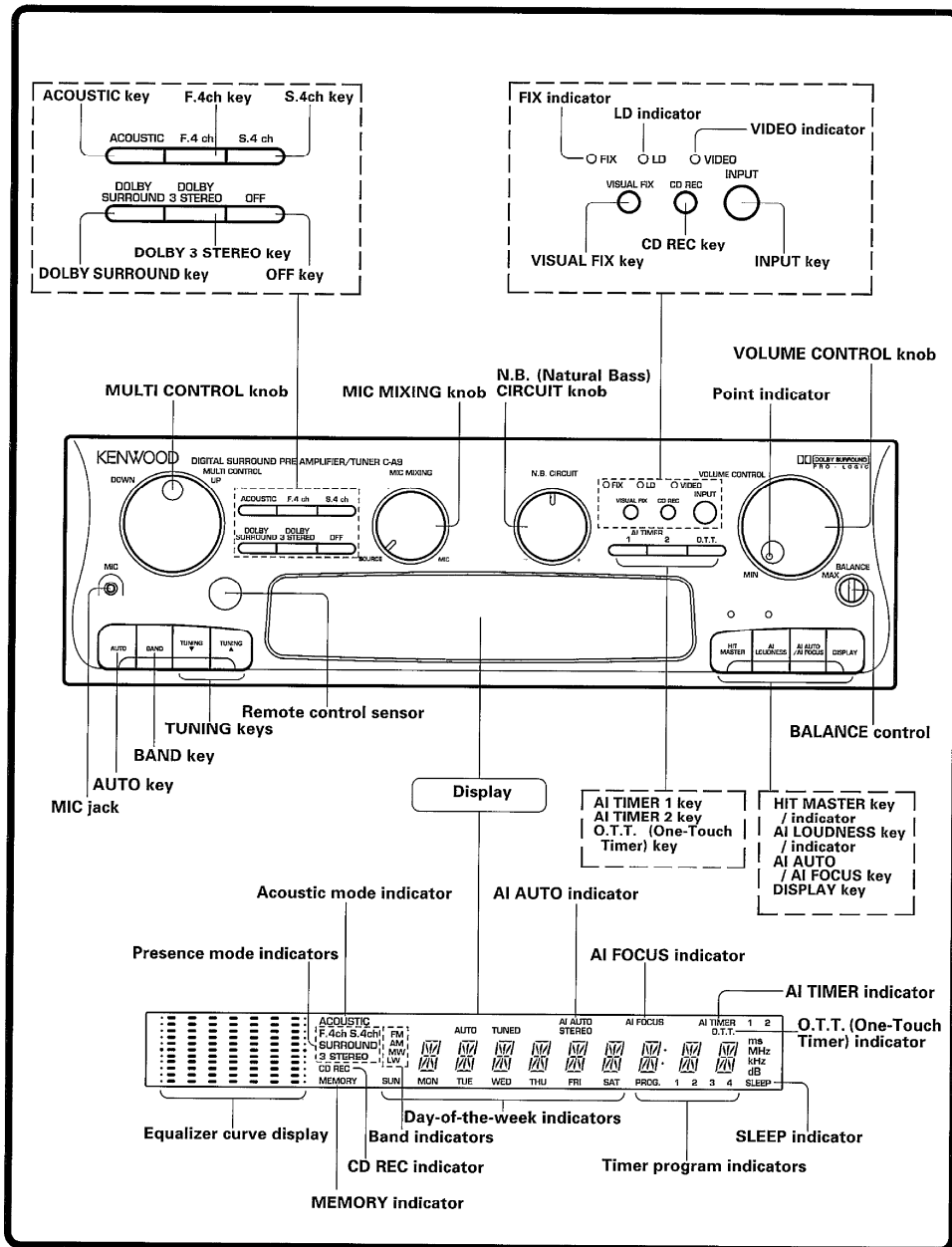

Controls and indicators

■ CD Player Unit

UD-900: DP-A9

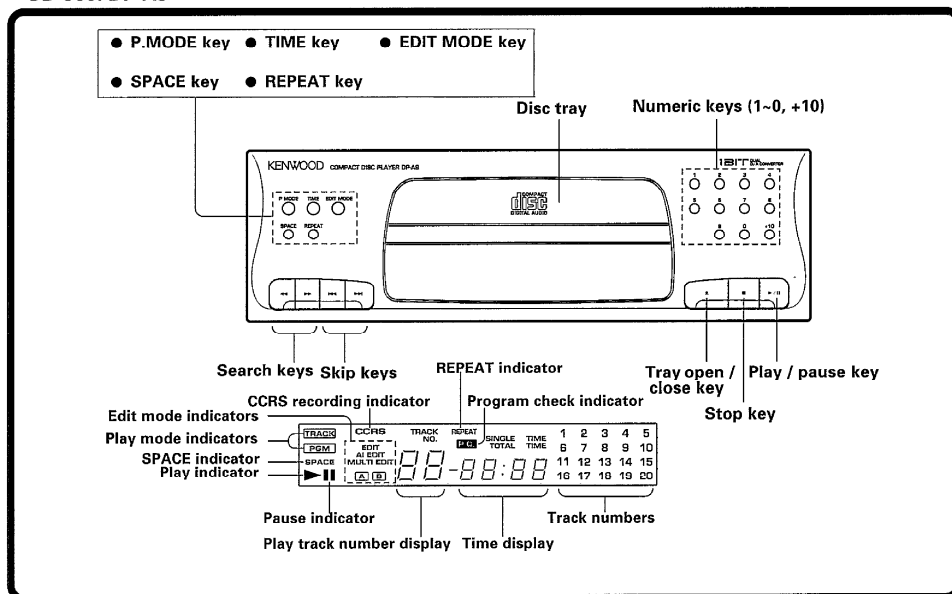

UD-900M: DP-MA9

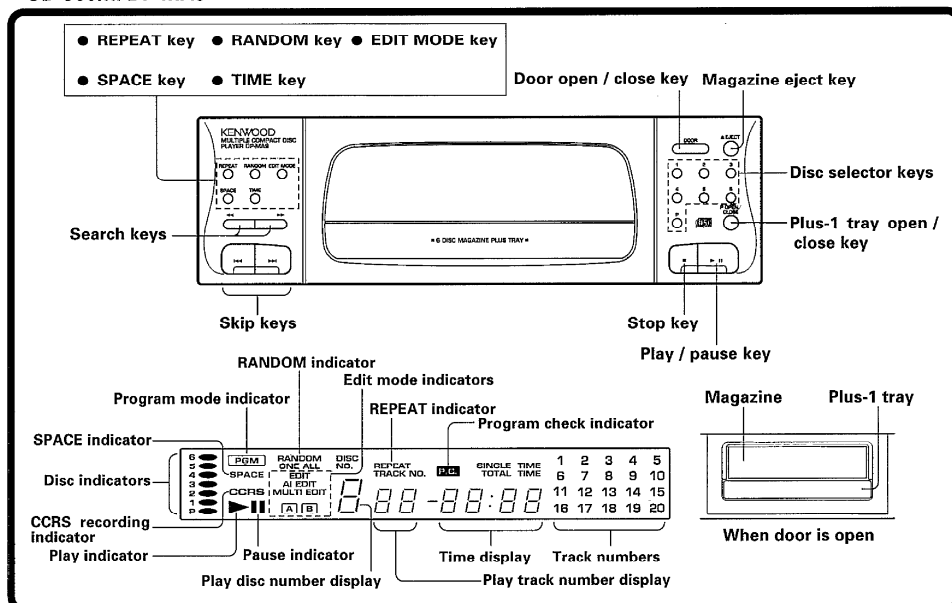

■ Cassette Deck Unit

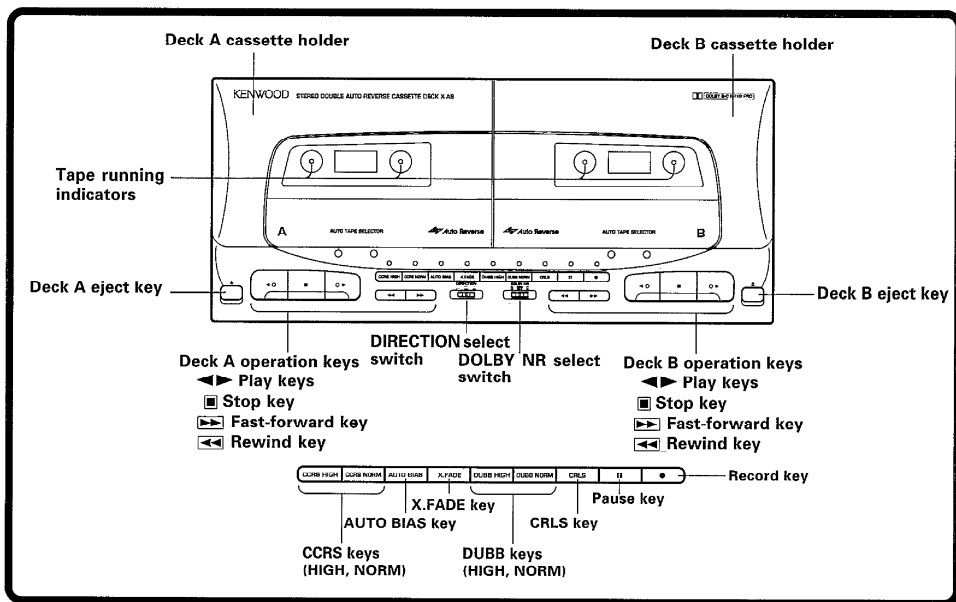

■ Power Amplifier Unit

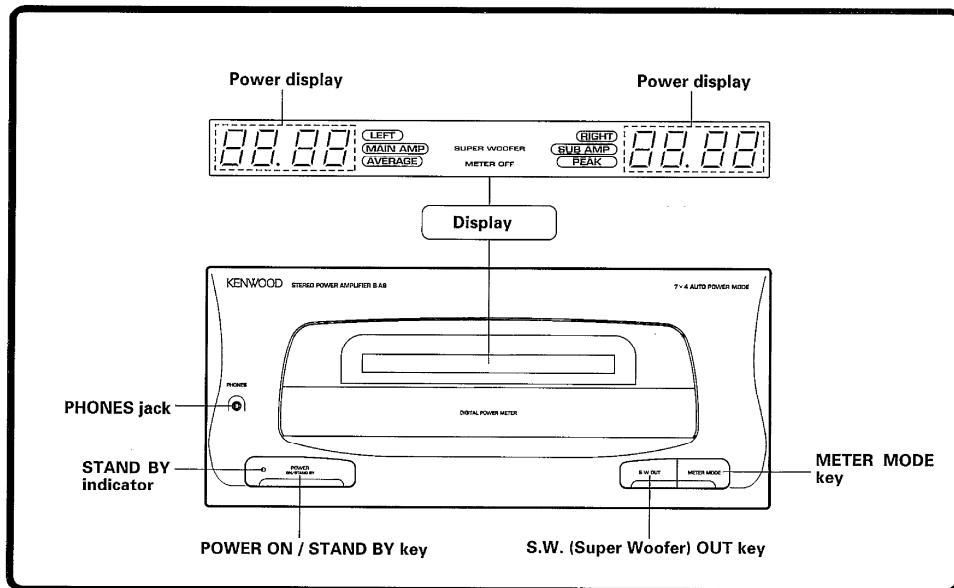

■ Speaker Unit

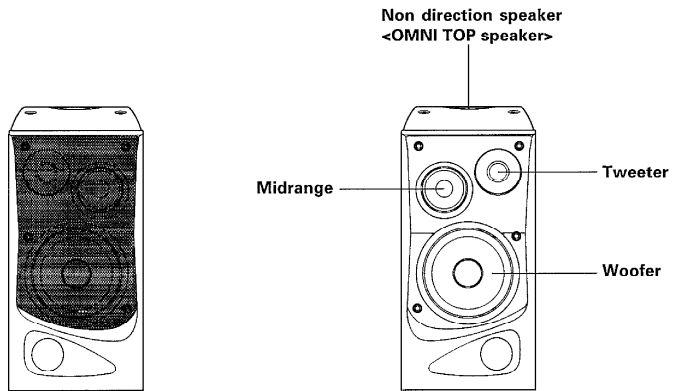

Two completely separate speaker systems are housed in each speaker cabinet. This design allows the creation of new and exciting sound fields. See page 23 for details.

Operation of remote control unit

■ Loading batteries

1 Remove the cover.

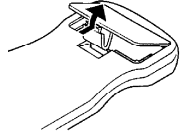

2 Insert batteries.

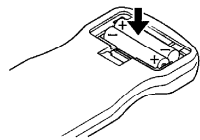

Insert two AAA-size (R03) batteries as indicated by the polarity marking.

3 Close the cover.

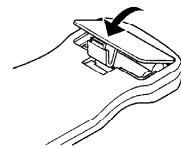

■ Operation procedure

Plug the power cord of the system into an AC wall outlet, and press the **[POWER]** key on the remote control unit to turn the power on. When the power is turned on, press the key of the source component to be operated.

- When two operation keys on the remote control unit are pressed successively, press each key securely reserving an interval of more than 1 second for each press.

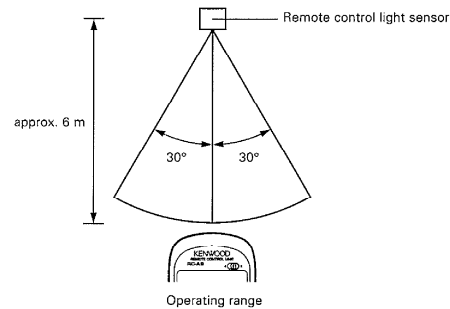

Notes:

- 1 The supplied batteries are intended for use in operation checks. Therefore, their lives may be shorter than ordinary batteries.
- 2 When the remote-controllable distance gets shorter than before, replace both batteries with new ones.
- 3 Malfunction may occur if direct sunlight or the light of a high-frequency lighting fluorescent lamp enters the remote control light sensor. In such a case, change the system installation position to prevent the malfunction.

Operation of remote control unit

■ Key Names and Functions

CD changer (DP-MA9) operation keys

Disc selector keys (1~6, P).
(When A / B switch is set to A).

SUPER WOOFER operation key

Set the A / B switch to "B" to operate the super woofer.
S.W.POWER key, S.W.EFFECT key,
S.W.VOL key

Numeric keys / day-of-the-week keys

Can be used as the numeric keys for the CD player when the CD input is selected.
Can be used as the numeric keys of the TUNER when the TUNER input is selected.
Can be used as the day-of-the-week keys in timer setting mode.

TAPE deck operation keys

Set the A / B switch to "A" when operating deck A (The  key is invalid.)
Set the A / B switch to "B" when operating deck B.

Input select keys

Display key

Every time this key is pressed, the display of the preamplifier / tuner changes.

METER MODE key

Every time this key is pressed, the display of the power amplifier changes.

HIT MASTER key

POWER key

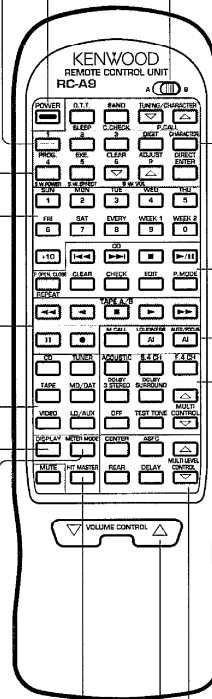

Model Name: RC - A9
Infrared ray system

Remote control function A / B switch

Some remote control keys have two functions, which can be switched over according to purposes.

Keys marked with characters alone can be regardless of the A and B settings.

Some keys are marked with white and brown characters. When this switch is set to A, the keys function as described with brown characters. In the B setting the keys function as described with white characters.





TUNER operation keys

When A / B switch is set to A:
TUNING / CHARACTER key, BAND key,
DIGIT key, CHARACTER key, ENTER key
When A / B switch is set to B:
P. CALL key, DIRECT key

Clock / timer operation keys

When A / B switch is set to A:
O. T. T. key, ENTER key
When A / B switch is set to B:
SLEEP key, C. CHECK key, PROG. key,
EXE. key, CLEAR key, ADJUST key



CD player operation keys

 key,  key,  key,  key,
CLEAR key, CHECK key, EDIT key,
P. MODE key,
When A / B switch is set to A:
P. OPEN / CLOSE key
When A / B switch is set to B:
REPEAT key

Equalizer operation keys

Ai AUTO / FOCUS key, Ai LOUDNESS key,
M. CALL key

Presence keys

ACOUSTIC key, S. 4CH key, F. 4CH key,
DOLBY 3 STEREO key,
DOLBY SURROUND key,
MULTI CONTROL key (, ) , OFF key,
TEST TONE key

Presence control keys

CENTER key, ASFC key,
REAR key, DELAY key,
MULTI LEVEL CONTROL key (, )

VOLUME CONTROL key

Adjust the volume. While these keys are operated, the VOLUME CONTROL knob on the main unit rotates and the indicator on it blinks at high speed.

Listening to sound

For details, also refer to corresponding pages for each player operations.

For the adjustment of the time displayed on the pre-amplifier / tuner, please read the next page.

The power amplifier is equipped with a cooling fan to protect the internal circuits from overheating. Be careful not to place any object close to the fan on the amplifier's rear panel.

Press the POWER key of the power amplifier.

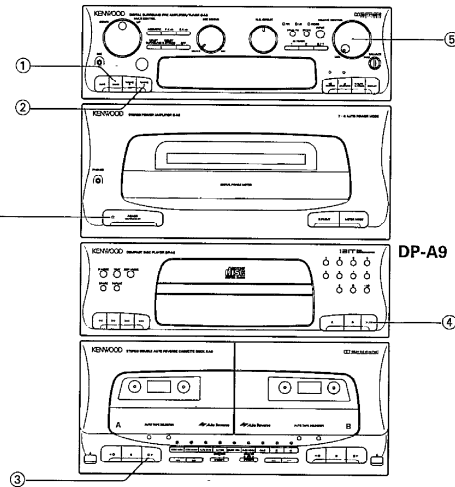
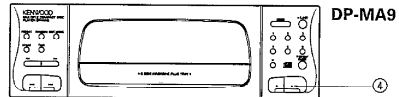

	To listen to a radio broadcast	To listen to a tape	To listen to a CD
1	<p>Select the tuner input. Select a broadcasting band by pressing the BAND key ①.</p>	<p>Insert a tape in Deck A.</p>	<p>Place a CD on the tray.</p>
2	<p>Select a station. Press the TUNING key ②.</p>	<p>Play the tape. Press the play key ③.</p>	<p>Play the CD. Press the play key ④.</p>
3	<p>Adjust the volume.</p> <p>● Turn the VOLUME CONTROL ⑤ for an optimum volume.</p>		

Note:
If sound is not output, check the connections described from page 8 again.

Time adjustment

The preamplifier / tuner incorporates the clock function. Adjust the clock to the exact time, especially when the program timer function is to be used.

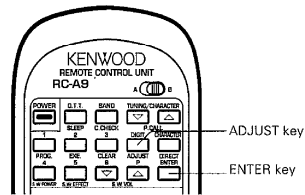

1 Press the ADJUST key.

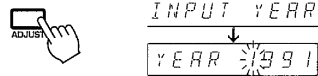

2 Input the year using the numeric keys, and press the ENTER key.

To input 1992: press [1], [9], [9], [2].

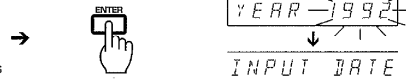

- If you commit a mistake in the input of numeric keys, press the [CLEAR] key, and re-start the input from the beginning.

3 Input the month then the day, and press the ENTER key.

To input March 7: press [0], [3], [0], [7].

To input December 30: press [1], [2], [3], [0].

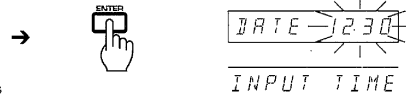

- If you commit a mistake in the input of numeric keys, press the [CLEAR] key, and re-start the input from the beginning.

4 Input the time of the day.

To input 9:05AM: press [0], [9], [0], [5].

To input 4:50PM: press [1], [6], [5], [0].

Use the 24-hour system.

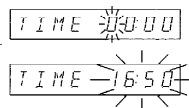

- If you commit a mistake in the input of numeric keys, press the [CLEAR] key, and re-start the input from the beginning.

5 Press the ENTER key.

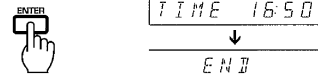

- For correct time adjustment, it is recommended to press the [ENTER] key at the same time as a time announcement.

Clock starts to work.

Note:

The time display blinks after a power failure or when the power cord was unplugged from the power outlet. In this case, adjust the time again.

Displayed contents and DISPLAY key

Every time the [DISPLAY] key is pressed while a radio station is received, the displayed contents is switched to the frequency to the station name, presence display, present time, and date (month and day). When a key associated with tuning is pressed while the date or time is being displayed, it is switched to the frequency display, and returns to previous content in a few seconds. When the [DISPLAY] key is pressed while the power is OFF, the displayed content is switched alternately between the date and time.

Audio adjustment

Press the POWER key of the power amplifier.

Stand by indicator

- The POWER key on the power amplifier can switch on / off the powers of main system.

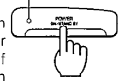

Remote control unit

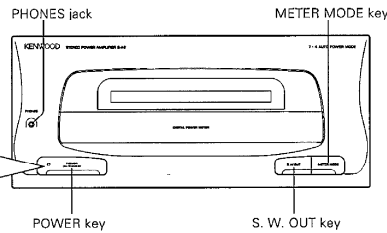

Adjusting the volume

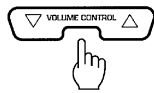
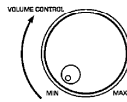

Remote control unit

- When the volume is adjusted from the remote control unit, the point indicator on the VOLUME CONTROL knob blinks and rotates together with the control knob.

To mute sound temporarily

Remote control unit only

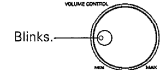

Blinks.

- Pressing the key again resumes the previous volume.

Selecting the input source

Main unit



Press repeatedly, or press and hold.

The input source changes in the following sequence:



Remote control unit



Adjusting the left and right volume balance



To decrease right speaker volume

To decrease left speaker volume

Compensation of bass sound



N.B. CIRCUIT: Natural Bass Circuit

- Usually set the switch to the center position.
- Adjust to obtain a more natural bass sound.

STAND BY mode of POWER switch

When the power cord of this system is plugged into an AC outlet, the preamplifier / tuner display and power amplifier stand by indicator light up regardless of the ON / OFF setting of the POWER switch. This indicates that a small amount of current is being supplied to the unit to back up the memory contents. This mode is referred to as the Stand By mode. While the display is lit, the power of the system can be switched ON / OFF from the remote control unit.

Automatic play operation function associated with input selector key of preamplifier / tuner

The selected input source starts playing automatically when the input source by simply pressing the input selector key (TAPE, TUNER, CD) is selected. It also allows to select a correct input selector key on the amplifier by simply starting playback on the desired input source component.

The same operation is also possible with the input selector keys on the remote control unit.

The input source selected at the moment the power is switched ON is the last source (TUNER, CD, etc.) selected before switching the power OFF.

Audio adjustment

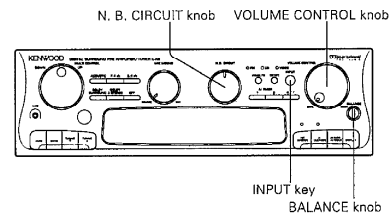

■ Listening through headphones

- 1 Insert the headphone plug into the headphones jack.

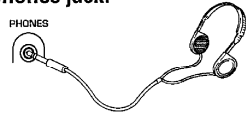

- Sound from all speakers is turned off.
- If the unit is set to the NON DIRECTION 1 acoustic mode, no sound will be heard from the headphones.

- 2 Adjust the volume.

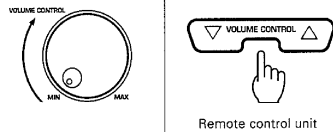

- Be sure to minimize the volume before unplugging the headphone plug.

■ Operation of super woofer key

The connection of super woofer, described on page 11, must be completed before proceeding to the following.

- 1 Press the S.W. OUT key.

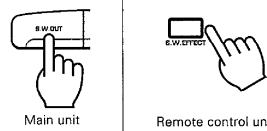

- The power amplifier's "SUPER WOOFER" indicator lights.

- 2 Adjust the super woofer volume.

Adjust the VOLUME control on the remote control unit or the super woofer.

- Once the super woofer volume is set, it is varied with respect to the master volume by varying the VOLUME CONTROL.

Using the power amplifier's meter mode

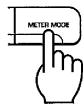

This system's power amplifier unit converts the current power level (sound volume) into a digital signal and displays it as a numerical value. Each press of the **METER MODE** key changes the display in the sequence shown below.

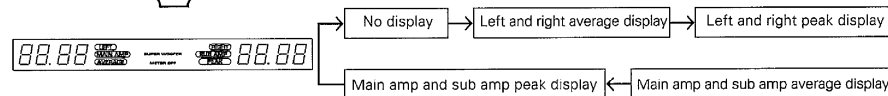

	Left side display area	Right side display area
Left and right average display	Average level of (Front Lch + Presence Lch)	Average level of (Front Rch + Presence Rch)
Left and right peak display (1 second hold)	Peak level of (Front Lch + Presence Lch)	Peak level of (Front Rch + Presence Rch)
Main amp and sub amp average display	Average value of Front (Lch + Rch)	Average value of Presence (Lch + Rch)
Main amp and sub amp peak display (1 second hold)	Peak value of Front (Lch + Rch)	Peak value of Presence (Lch + Rch)

Sound fields

The speakers provided with this system feature two different speaker systems in each cabinet. One is a conventional 3-way speaker system, and the other is an omni-directional (non-directional) speaker system housed in the top of the speaker cabinet.

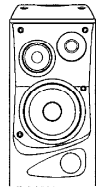

3-way speaker system

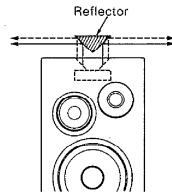

Cross section of top half of speaker system



Top view of sound transmission pattern

As shown in the diagrams above, these OMNI TOP speakers incorporate non-directional sound transmission technology using a reflector to radiate the sound in all directions. This component system utilizes the special characteristics of these speakers to create new, exciting sound fields.

One way it does this is with Acoustic modes, which create a natural sound field without electronically altering the audio signal. Another is with Presence modes, which use a DSP (digital signal processor) to reproduce the atmosphere of a live concert or theater performance that totally surrounds the listener.

Moreover, this system features a built-in Dolby decoder which allows you to experience the force and energy of a theater movie with Dolby Surround Sound.

Make optimum use of these modes by selecting the sound field which best matches the input source as well as your taste.

Mode Features and Characteristics

Acoustic modes

Acoustic modes create sound fields by making maximum use of the special characteristics of the OMNI TOP speakers provided with this system. Three acoustic modes are available, NON DIRECTION 1, NON DIRECTION 2 and BGM. (See Fig. 4.)

Presence modes

F. 4ch

The built-in presence speakers function to reproduce seven kinds of presence effects (disco, movie theater, arena, church, jazz club, stadium, game) from the front speakers only. It is also possible to create desired sound fields by fine adjustment. (See Fig. 4.)

S. 4ch

Select this mode when the center speaker and surround rear speakers are connected. Seven kind of presence effects can be reproduced similarly to F. 4ch. (See Fig. 1.)

AI LINK equalizer effect

When F. 4ch or S. 4ch is selected, equalizer curves are automatically created according to the seven kinds of presence sound fields to enhance them.

DOLBY SURROUND PRO LOGIC

When video software tape or LD software disc marked  is played, a Dolby Surround effect similar to movie theaters can be enjoyed. (See Fig. 1 and 3.)

DOLBY 3 STEREO

Select this when the surround rear speakers are not used. This improves the positioning of the center sound. (See Fig. 2.)

When the input selector is set to TUNER, only the acoustic mode functions and other modes do not function.

■ Speaker layout

Standard layout

**DOLBY SURROUND PRO LOGIC mode. (NORMAL, WIDE)
S. 4ch mode**

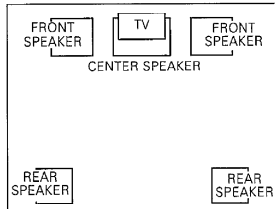

Fig. 1

When the surround rear speakers are not used

DOLBY 3 STEREO mode.

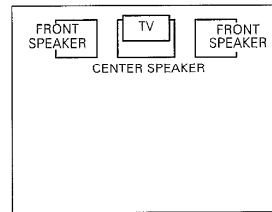

Fig. 2

When the center speaker is not used

DOLBY SURROUND PRO LOGIC mode. (PHANTOM)

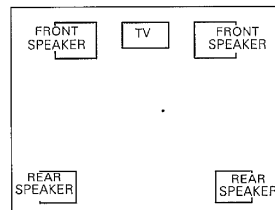

Fig. 3

When only two speakers are used

**F. 4ch mode
ACOUSTIC mode**

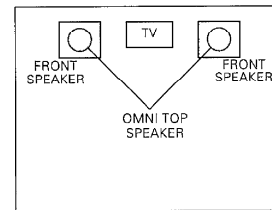
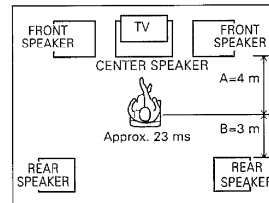
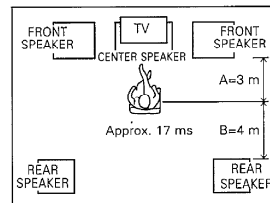
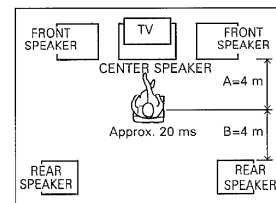

Fig. 4

Note:
The built-in OMNI TOP speakers function only in ACOUSTIC and F 4. ch modes.

Setting the Delay time DOLBY SURROUND PRO LOGIC only

The delay time should be adjusted according to the difference between the distance from the listening position to the front speakers and the distance to the rear (surround) speakers. Determine the appropriate delay time using the formula shown below.
Relationship between the positioning of the rear (surround) speakers and the delay time at the listening position:
Delay time = 20 ms + 3 ms × (A - B) m



DOLBY 3 STEREO

The Dolby 3 STEREO provides a active center channel to produce a better, stable center image. This mode can be used when listening to stereo video program and music or when surround listening or surround system set-up is not possible.

■ Dolby 3 STEREO adjustment

Remote control unit only

1 Set the Dolby 3 STEREO mode.

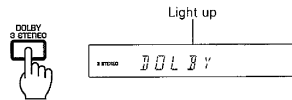

2 Select the center mode.

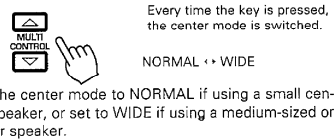

3 Turn on the test tone.



4 Adjust the center speaker volume.

① Press the TEST TONE key.



Pressing the TEST TONE key once moves the noise-like test tone between speakers every two seconds (for use in adjustment), and pressing the key twice moves it every second (for use in checking). The test tone is turned off by the third press.

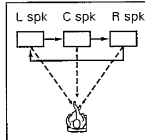

② Adjust the volume. Adjust the center level.



Select CENTER



Adjust

- Adjust so that the level of the center speaker is equal to that of the left and right speakers.

5 Stop generating the test tone.

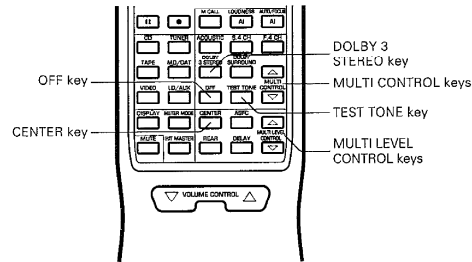

■ Dolby 3 STEREO playback

1 Set the Dolby 3 STEREO mode.

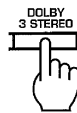

- This function cannot be activated in TUNER mode.

2 Check the center mode.

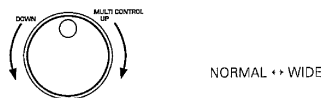

- Set the center mode to NORMAL if using a small center speaker, or set to WIDE if using a medium-sized or larger speaker.

3 Play a stereo software program or a Dolby surround program.

4 Adjust the volume and tone.

To return to normal stereo playback

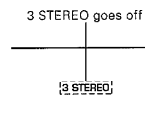

DOLBY SURROUND

When video software carrying  mark is played, this mode provides the similar Dolby Surround effect to movie theaters.

■ Dolby Surround field adjustment

Remote control unit only

1 Set the Dolby Surround mode.

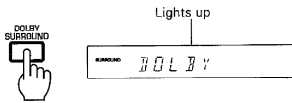

2 Select the center mode.

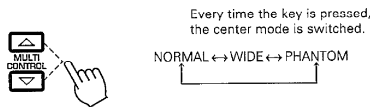

- Refer to column "Center mode" below.

3 Turn on the test tone.



4 Adjust the volume balance.

- 1 Press the TEST TONE key.

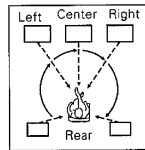

Pressing the **TEST TONE** key once moves the noise-like test tone between speakers every two seconds (for use in adjustment), and pressing the key twice moves it every second (for use in checking). The test tone is turned off by the third press.

In NORMAL or WIDE mode:

→ Left → Center → Right → Rear →

In PHANTOM mode:

→ Left → Right → Rear →

2 Adjust the volume balance.

Adjust the center level.

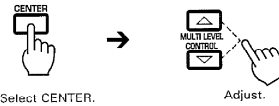

Select CENTER.

Adjust.

Adjust the rear level.



Select REAR.

Adjust.

- Adjust so that the test tone volumes are the same on all speakers.
- The level being adjusted is displayed.

5 Stop generating the test tone.



6 Set the delay time.

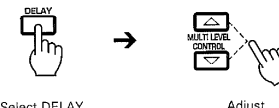

Select DELAY.

Adjust.

- Refer to the formula shown on page 24.
- The delay time can be adjusted in the range from 15 to 30 ms.
- When one of the **MULTI LEVEL CONTROL** key is pressed, the delay time is displayed and varied in 1.0 ms steps per press the key.
- Once a delay time is set, it is automatically held in memory so the same delay time is displayed whenever Dolby Surround is switched ON later.

Center mode

Select one of the following center modes according to the type of the presence speakers in your system.

NORMAL: Use this mode with a center speaker of a compact size.

WIDE: Use this mode with a center speaker of a medium or larger size.

PHANTOM: Use this mode when the center speaker is not used.

- If you cannot identify whether your center speaker is of the medium or compact size, try both the NORMAL and WIDE mode and use the one that can provide better sound positioning.

- Even without the center speaker, the signal is processed in a simulated manner to ensure proper center image positioning and provide the enjoyment of Dolby Surround.

■ Operation of Dolby Surround playback

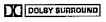
When video software carrying  mark is played, this mode provides the similar Dolby Surround effect to movie theaters.

Before using the Dolby Surround mode, be sure to perform the "Dolby Surround field adjustment" procedure.

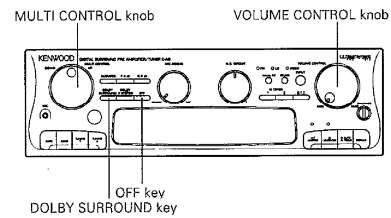

1 Set Dolby Surround mode.

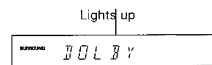
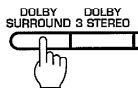

- This function cannot be activated in TUNER mode.

2 Check the center mode.

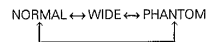
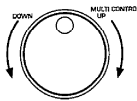

- Normally, the last mode used is held in memory. If it is different from the required mode, select the mode which was used in step 2 of the "Dolby Surround field adjustment" (page 26).

3 Play a software program encoded with Dolby Surround.

- When this unit, input balance is adjusted automatically.

4 Adjust the volume.

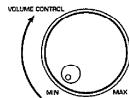

Adjusts the overall volume.

- When the level balance of center and rear speakers is not good, perform the "Dolby Surround field adjustment" procedure again.

To return to normal stereo playback

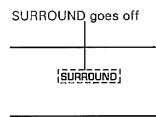
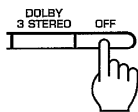

Acoustic Sound

As described previously on page 23, the speakers provided with this system incorporate an omni-directional (non-directional) speaker in the top section of each speaker cabinet. The sound from this non-directional speaker is added to the directional sound of the conventional 3-way speaker system to create new types of sound fields. Using only these speakers without the addition of any other speakers, you can enjoy the three types of sound fields described below.

Acoustic modes

NON DIRECTION 1

Sound is emitted only from the OMNI TOP speaker in the top of each speaker cabinet.

The OMNI TOP speaker adds specially the wide and deep acoustics to the sound in the entire room. Set this mode when you want to listen to music in a casual, relaxed mood.

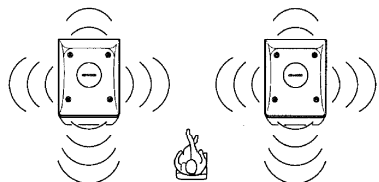

NON DIRECTION 2

This mode adds rich bass sound from the woofers of 3-way speakers to the NON DIRECTION 1 sound.

When you require more powerful sound than NON DIRECTION 1, select this mode.

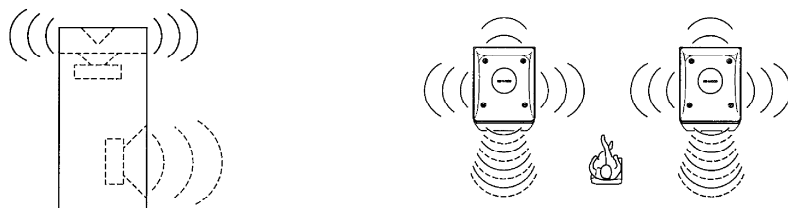

BGM

The 3-way speaker system functions normally and the sound from the OMNI TOP speakers is reversed between the left and right channels.

The stereo sound is heard from one speaker so that the stereo sound field is widened.

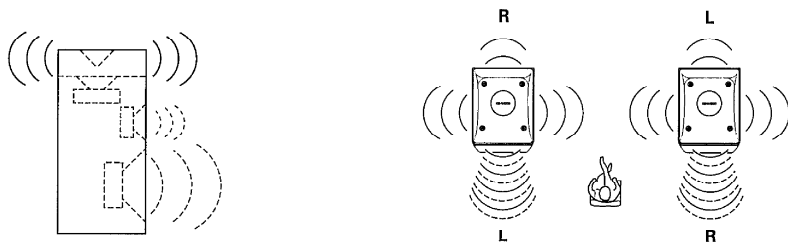

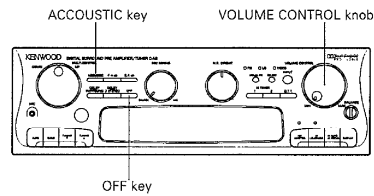

■ Acoustic sound playback

1 Set the system to acoustic mode.

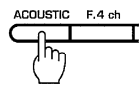

"ACOUSTIC" lights.

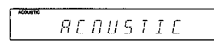

2 Select the play mode.

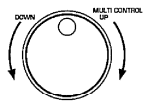

NON DIRECTION 1 ↔ NON DIRECTION 2 ↔ BGM

3 Play the music source.

- Select a desired preset equalizer pattern. (See p.37)

4 Adjust the sound volume.

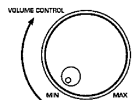

Turning this control adjusts the overall sound volume.

To return to normal stereo playback

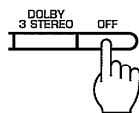

"ACOUSTIC" goes off.

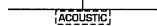

Presence

The DSP (Digital Signal Processor) allows to enjoy the ambiances of various places where music is played. The DSP has five basic presence parameters which can be set individually

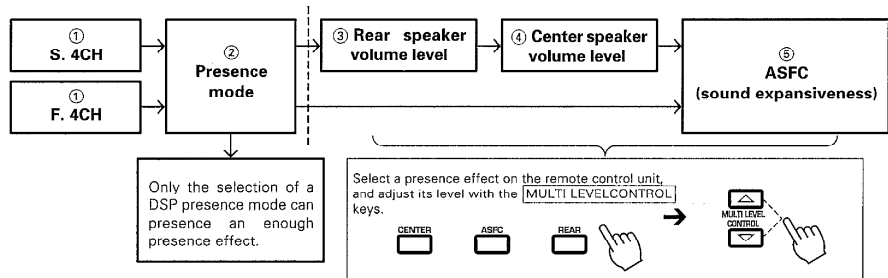

■ Presence playback

Play a music source.

1 Select the Surround mode.

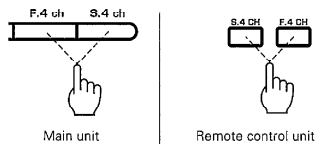

- This function cannot be activated in TUNER mode.

2 Select the presence mode.

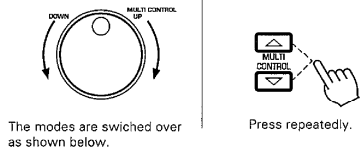

The modes are switched over as shown below.

ARENA ↔ JAZZ CLUB ↔ STADIUM
↓
GAME ↔ MOVIE ↔ CHURCH ↔ DISCO

- For the types and effects of the presence mode, please refer to page 31.

3 Adjust the rear speaker volume.

Adjust the S. 4ch mode.

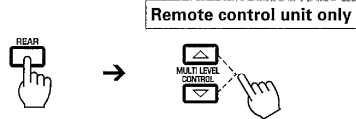

4 Adjust the center speaker volume.

Adjust the S. 4ch mode.

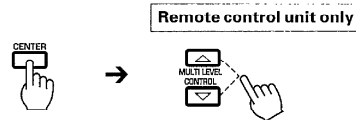

Adjust the sound expansiveness.

Remote control unit only

Adjust to create a desired sound field.

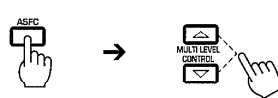

- The level is variable in the range from 1 to 7.

To cancel the presence effect

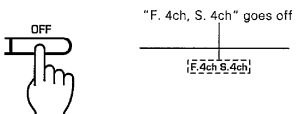

- Be sure to turn the presence effect off when presence playback is not required.

To record the presence effect

① Set the F. 4ch mode.

② Select the presence mode.



③ Play a music source and record it.

- Set the recording level using the CRLS or CCRS function.

ASFC (Acoustic surround Field Control)

Adjust the sound expansion to the presence effect.(F. 4ch, S.4ch only).

DSP (Digital Signal Processor)

The DSP system converts the reverberation components which enhance the presence effects into digital signals, and provides various presence effects without spoiling the quality of music sources.

Kinds of presence sound and their effects

ARENA	Reproduces the effects of a hall, with long reverberation and much reflection of high-frequency sound.
JAZZ CLUB	Reproduces the feeling of a live jazz house with sounding cymbals.
STADIUM	Reproduces the reflected sound characteristic to stadiums as PA speaker sounds to create an excitement-charged atmosphere.
DISCOTHEQUE	Reproduces the feeling of a disco with exciting middle-and high-frequency sounds through the use of moderate reverberation and a graphic equalizer.
CHURCH	Reproduces the rich echoing of solemn church.
MOVE	Suppresses reflected from the center and reproduces mild echoing from the others.
GAME	Enhances the effects sound of video games to reproduce powerful sound with an atmosphere of presence.

Sound expansiveness [F. 4CH, S. 4CH]

As shown in the example of illustration, the sound of piano played on the stage attains the ears of listener as a synthesis of the direct sound from piano, the indirect sounds which are reflected once or twice by the reflectors, ceiling and side and back walls, and the reverberation sounds which repeat infinite reflections until they fade out completely.

The indirect sounds always pass through longer routes compared to the direct sound. The delay between the direct and indirect sounds is called the DELAY TIME, and the level of the indirect or reverberated sounds is called the PRESENCE LEVEL.

The indirect sounds accompanied with delay play a very important role in providing better sound effects and the feeling of presence of concert halls, etc. The acoustic field also varies depending on the speaker arrangement.

ASFC simultaneously changes both the delay time and reverb sound level. Select the ASFC value which sounds best to you.

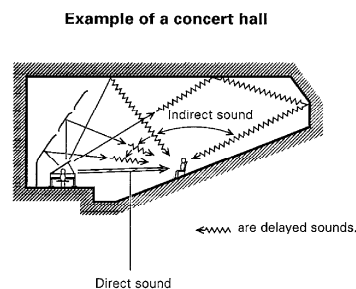

Reception of radio broadcast

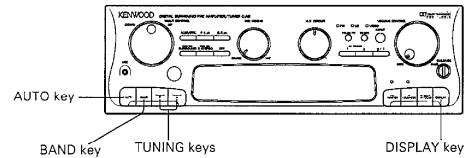

■ Receiving broadcast stations and storing them in memory (preset operation)

1 Display the frequency display.

- Every time the [DISPLAY] key is pressed, the displayed contents are switched in order or Frequency → Broadcast station name → Presence display → Present time → Date (month & day).

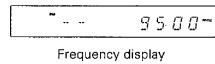

2 Select the broadcast band.

- The frequency is displayed for a few seconds when a key associated with tuning is pressed.



The bands are switched as follows every time the [BAND] key is pressed.

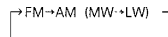

3 Select the tuning mode.

- Normally, select the auto mode (with AUTO lighted).

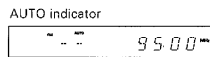

Press the key to select the auto (AUTO lighted) or manual (not lighted) mode.

4 Tune the desired station.

To decrease frequency



To increase frequency

- The TUNED indicator lights up when a station is received.
- Use manual tuning mode when the radio wave is weak and noisy. At this time, the stereo FM broadcast is received in monaural mode.

Auto tuning mode	Manual tuning mode
Press once. (Tuning stops automatically when a station is received.)	Press repeatedly, or press and hold, until the desired station is received.

5 Store the station in preset memory.

Remote Control unit only

- 1 Press the ENTER key.



- Proceed to step 2 before "MEMORY" stops lighting.

- 2 Press the desired numeric key.

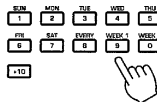

"MEMORY" lights up for approx. 5 sec.

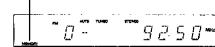

"MEMORY" goes off.

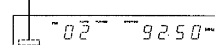

Examples of input

To select preset No. 15: [+10] 5

To select preset No. 20: [+10] [+10] 0

- When a station has previously been preset under the numeric key pressed, the newly preset station replaces the previous station.
- When preset is to be continued, repeat steps 2 to 5.
- Up to 20 broadcast stations can be preset regardless of the broadcasting bands.

■ Receiving a preset station

Remote Control unit only

Select the desired station.

Press the numeric key.



- The frequency of the station received will be displayed.

■ Listening to all preset stations in sequence (PRESET CALL)

Remote Control unit only

Press the P.CALL key.

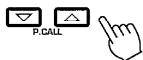

- Every time [UP] is pressed, the preset stations are received in order of 1 → 2... 19 → 20 → 1.....
- Every time [DOWN] is pressed, the preset stations are received in order of 20 → 19... 2 → 1 → 20.....
- When a key is held depressed, the preset station are received in sequence at 0.5-second intervals. The station being received when the key is released will continue to be received.

■ Direct tuning of radio stations

If you know the frequency of the desired station, it can be received directly by inputting the frequency using the numeric keys.

Remote Control unit only

1 Select the broadcast band.

One of FM or AM (MW / LW).

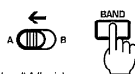

Set the A / B switch to the "A" side.

2 Press the DIRECT key.



Set the A / B switch to the "B" side.

3 Input the frequency of the desired station by pressing the numeric keys.

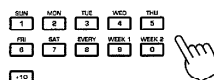

Example of input

Desired station	Order of pressing numeric keys
FM 90 MHz	[9], [0], [0] (100 kHz space) [9], [0], [0], [0] (50 kHz space)
FM 102.5 MHz	[1], [0], [2], [5] (100 kHz space) [1], [0], [2], [5], [0] (50 kHz space)
AM (MW) 810 kHz	[8], [1] (10 kHz space) [8], [1], [0] (9 kHz space)
AM (MW) 1260 kHz	[1], [2], [6] (10 kHz space) [1], [2], [6], [0] (9 kHz space)

- If you commit a mistake in the input of numeric keys, press the [CLEAR] key, and re-start the input from the beginning.
- The display blinks if you mistakenly enter the wrong frequency. Re-enter the correct frequency.

Reception of radio broadcast

■ Displaying station names **Remote control unit only**

Station names composed of up to four digits of characters and / or symbols can be displayed on the preamplifier / tuner display.

Example: To receive FM 93.4 MHz, input its name with characters "CBE", and preset them under numeric key [3].

1 Receive FM 93.4MHz, and enter the character input mode.



2 Select the characters to be displayed with that station.

① Display the desired character.

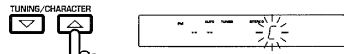

② Establish the selection.

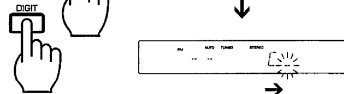

③ Repeat steps ① and ② until all of the required characters have been input.

- To select "C", press the UP segment three times.
- To insert a space, simply press the [DIGIT] key.

Blinking digit change to the next digit.

Types of characters that can be input

After having pressed the [CHARACTER] key, press the [TUNING / CHARACTER] key to display the characters available.

ABCD.....XYZ012...9
/* + ←
Blank position

3 End the character input.

The character input also terminates automatically when fourth character has been input.

Press the [CLEAR] key to terminate character input with three characters or less.

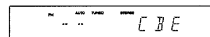

In case you commit an input mistake, press the [CLEAR] key and re-start from the previous digit.

4 Preset them under key [3].

① Press the ENTER key.



"MEMORY" lights up.

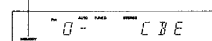

② Press numeric key [3].



Press while "MEMORY" is lighted.

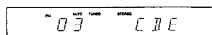

Example: When a station name is displayed with the [DISPLAY] key.

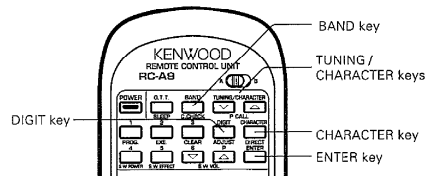

■ Changing a station name Remote control unit only

Example: To change station name "FHN8" preset with AM (MW)
810 kHz frequency under numeric key [2] to "FEN".

1 Receive preset station of [2] by preset tuning, and enter the character input stand-by mode.

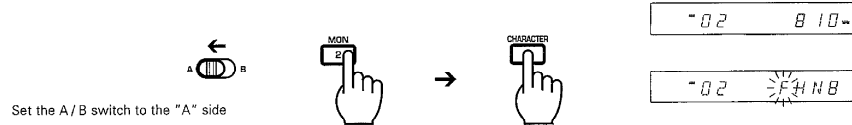

2 Move the blinking digit to the second digit.



3 Select "E" with TUNING / CHARACTER key.

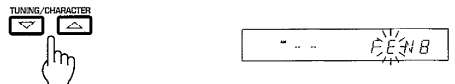

4 Move the blinking digit by two digits.



5 Select the blank with the TUNING / CHARACTER key.



- The character input terminates automatically when fourth character has been input.

6 Preset the new name under numeric key [2].

① Press the ENTER key.

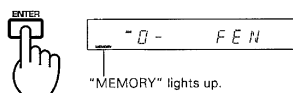

② Press numeric key [2].

Press while "MEMORY" is lighted.

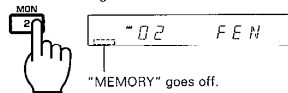

Example: When a station name is displayed with the [DISPLAY] key.

Operation of graphic equalizer

This unit provides seven factory-preset equalizer curves to allow compensation for the reproduce sound. In addition it also provides the AI (Artificial intelligence) function as described below to allow listening to different music sources with optimum tones.

1. AI-AUTO (available only for CD play)

Checks the contents recorded on a CD automatically, and steps the optimum equalizer pattern according to the CD.

2. AI-FOCUS (available only for CD play)

In presence mode: An ASFC value (1-7) and equalizer curve suited to the recorded contents of the disc are set automatically, creating a live concert atmosphere.

In acoustic mode: An equalizer curve suited to the recorded contents of the disc is set automatically, producing a natural, expansive sound.

3. AI-LOUDNESS

The low frequencies are enhanced according to the current volume setting. The function is effective when listening at low volume.

4. Preset pattern mode

Five preset patterns plus "CAR AUDIO" for recording tapes to be played in a car stereo and "HP STEREO" for recording tapes to be played in a portable headphone player are contained in the system memory.

5. AI-LINK

When a presence mode is selected, optimum equalizer curve for this mode is selected automatically to enhance the presence effect.

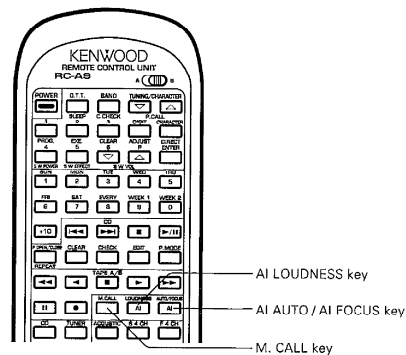

DOLBY SURROUND and PRESENCE keys

Refer to pages 23 ~ 31.

HIT MASTER key

Refer to "Simple Karaoke singing entertainment" on page 69.

AI: Artificial Intelligence.

The AI is capable of adjusting the tone automatically according to the source and music categories.

■ How to use the preset equalizer patterns

You can easily recall any of seven preset equalizer patterns.

Remote control unit only

1 Play a music source.

2 Select the desired equalizer pattern.

Each press changes the equalizer pattern according to the sequence below.

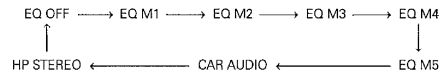

To cancel the equalizer effect.

Select "EQ. OFF".

Each press changes the equalizer pattern according to the sequence below.

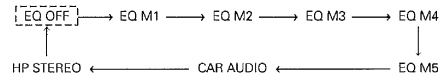

■ List of equalizer patterns

M 1 (Soft 1)		: For listening to background music, etc., with comfortable sound to ears.
M 2 (Clear)		: For listening with brilliant sound with attenuated bass.
M 3 (Scale 1)		: For listening with more exciting sound.
M4 (Soft 2)		: For listening to orchestral sound with soft tone to the ear.
M5 (Scale 2)		: For listening to orchestral sound with feeling of expansion.
CAR AUDIO		: For recording sound with tone adjusted for playback on car stereo.
HP STEREO		: For recording sound with tone adjusted for playback on headphone stereo.

Operation of graphic equalizer

■ Operation of AI LOUDNESS control

This feature compensates automatically the lack of low frequencies felt when listening at low volume.

To activate the AI LOUDNESS effect

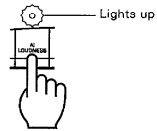

To cancel AI LOUDNESS

Press the key again.

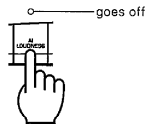

■ Operation of AI AUTO (for CD play only)

By pressing the AI AUTO / AI FOCUS key while the presence mode are OFF, the equalizer curve suited to the contents of the CD is set automatically.

1 Place a disc in the CD player.

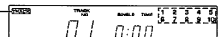
TRACK lights up.  Track Nos. in disc are indicated.

- With the UD-900M system, select the desired disc.

Verify that the presence indicators (F.4ch, S.4ch) are extinguished.

 Goes off.

2 Press the AI AUTO / AI FOCUS key.

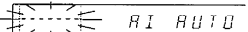

During sampling of CD  "AI AUTO" lights up.

Completes sampling in approx. 30 seconds and stops.  Graphic equalizer display.

- Wait for about 30 seconds until "AI AUTO" lights up.

The playback starts automatically.

Note:

During the AI AUTO setting process, keys other than the [AI AUTO / AI FOCUS] key do not function.

To cancel AI AUTO

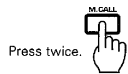

Press twice.

Remote control unit

or

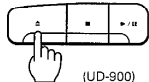

(UD-900)

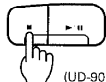

(UD-900M)

CD player

AI AUTO goes off

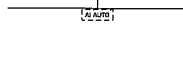

- If AI AUTO is canceled during the AI AUTO setting process, the pattern last recalled using the [M.CALL] key is displayed.

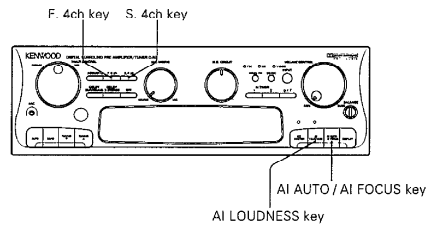

■ AI FOCUS operation (for CD play only)

The optimum ASFC value (when in presence mode) and equalizer curve for the contents of the CD are set automatically by simply pressing the AI AUTO / AI FOCUS key after selecting the presence mode or acoustic mode.

1 Place a disc in the CD player.

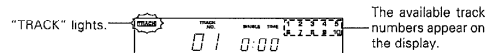

- With the UD-900M system, select the desired disc.

2 Select the desired presence mode or acoustic mode.

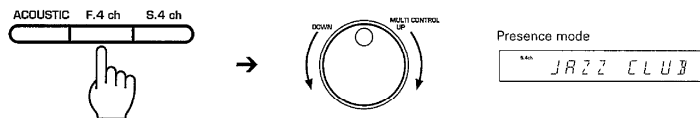

- For details regarding presence and acoustic modes, see pages 28–31.

3 Press the AI AUTO / AI FOCUS key.

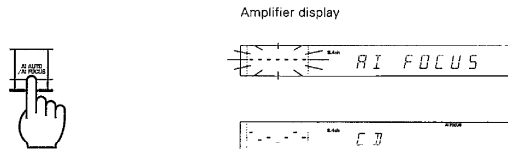

- Wait for about 30 seconds until "AI FOCUS" lights up.
- The ASFC value and equalizer curve are set according to the selected presence mode.
- The CD player starts playing automatically.

Note:
During the AI FOCUS setting process, keys other than the **AI AUTO / AI FOCUS** key do not function.

To cancel AI FOCUS

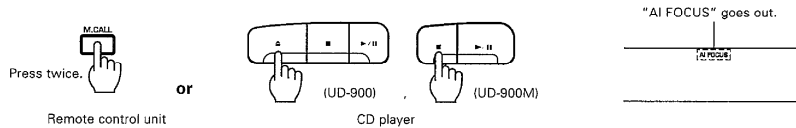

- If AI FOCUS is canceled during the AI FOCUS setting process, the pattern last recalled using the **M.CALL** key is displayed.
- If AI FOCUS is canceled after the AI FOCUS setting process is completed, the AI LINK curve or the curve last recalled using the **M.CALL** key is set.

Playing CDs (UD-900M)

CD operations for only UD-900M (CD changer) are given on pages 40 to 47. For operations of UD-900, refer to pages 48 to 52.

■ Loading a disc into the magazine

1 Pull out the disc tray.

① While pressing in on the lock button.

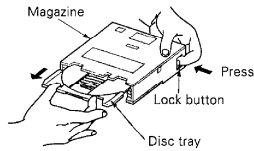

② Pull out the disc tray.

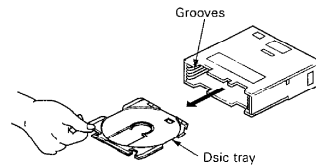

2 Place a disc on the disc tray.

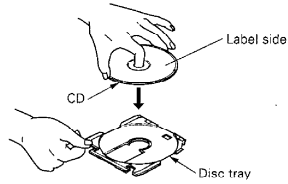

- Commercially-available CD single (8 cm) disc adapters cannot be used in this system. To play CD single (8 cm) discs, use the optional CDM-608 CD single magazine.

3 Insert the disc tray into the magazine.

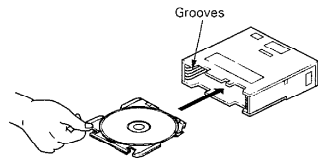

Align the tray with the corresponding left and right grooves and insert horizontally into the magazine.

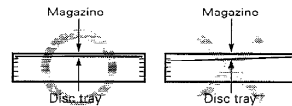

- Be sure to place each disc on a disc tray before inserting into the magazine.
- Even when loading fewer than six discs, make sure there are six disc trays inserted in the magazine during use.
- Always hold the magazine level when carrying.

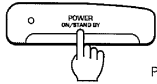

Power amplifier

Be sure to turn on the power amplifier before performing the following operations.

■ Loading a magazine

1 Open the door.



2 Insert the magazine.

①

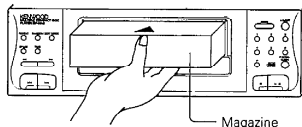

②

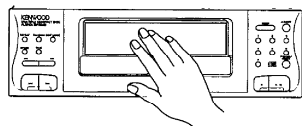

Press in until it locks in place with a click.

3 Close the door.



■ Loading a disc in the plus-1 tray

① Open the plus-1 tray.



② Place a disc on the tray.

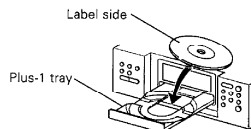

③ Close the plus-1 tray.



• The door opens and the plus-1 tray comes out.

• The plus-1 tray retracts into the unit and the door closes.

■ Removing a magazine

1 Open the door.



- By pressing the eject key, the door can also be opened and the magazine ejected.

2 Remove the magazine.

① Press the eject key.

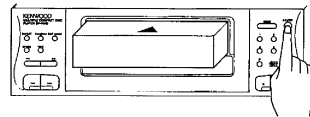

② Pull out the magazine.

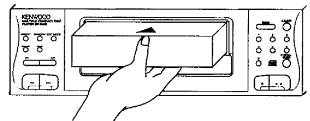

Hold the magazine in the center.

3 Close the door.



Playing CDs (UD-900M)

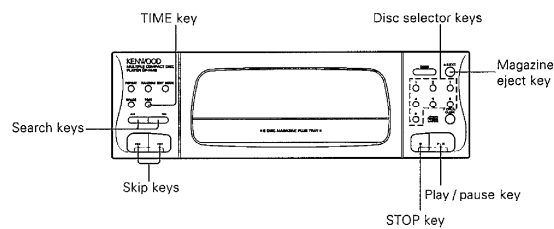

■ Playing a CD from the beginning

1 Place a disc in the magazine or on the plus-1 tray.

Refer to pages 40, 41 for disc loading.

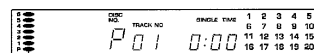

All disc indicators light regardless of how many discs are in the magazine.

2 Start playback.

Select the desired disc.

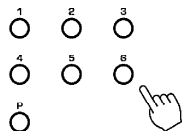

If there is no disc in the selected disc tray, the corresponding indicator goes out.

- Playback starts from the selected disc. If more than two discs are loaded, the discs are played in order of their disc numbers.
- If the play (▶) key is pressed without selecting a disc, the discs will be played automatically in the following order: P → 1 → 2 → 3 → 4 → 5 → 6. (P: Plus-1 tray)
- To play a single disc only, remove the magazine and place a disc only in the plus-1 tray.

To pause playback

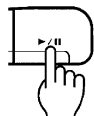

To resume playback, press the (▶) key again.

To stop playback



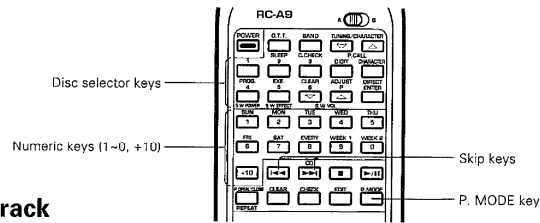

■ Listening from the desired track

Preparation: Set the INPUT key on the preamplifier / tuner to CD.

1 Make sure the PGM indicator is extinguished.
If the PGM indicator is lighted, press the P-MODE key. (Remote control unit only)

2 Select the desired disc.

3 Select the desired track.

Numeric keys of remote control unit

Example: To select track number 11, press the [11] key once and then the [1] key once.
To select track number 20, press the [10] key twice and then the [0] key once.

- Play starts from the selected tune and after.

To skip tracks

- The tunes are skipped in the direction of the key and the play starts at the beginning of the selected tune.
- When the [SKIP] key is pressed once during play, the track starts again from the beginning.

To fast forward and backward

- The track will start to play from where you release the key.

TIME key

Press the TIME key when you want to check the elapsed time and remaining time of the track being played. Every time the TIME key is pressed, the displayed time changes as shown below.
The time information display may not appear when playing a CD containing 21 or more tracks.
In such a case, the display (remaining SINGLE TIME) will show "--:--". (In PGM mode, only the SINGLE TIME displays can be selected.)

Time display examples 1:23 -2:37 23:45 -36:15

Playing CDs (UD-900M)

The program mode allows you to play desired tracks in the order you want to hear them. A maximum of 32 selections can be entered in memory.

Preparation: Set the INPUT key on the preamplifier / tuner to CD.

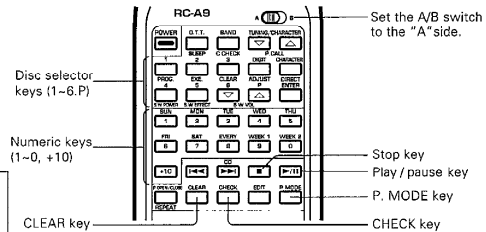

■ Playing desired tracks in desired order (PGM mode) Remote control unit only

1 Enter the PGM mode.

Press the P. MODE key.

PGM indicator lights up.



2 Program desired tracks in desired order.

Example

To select track no. 5 on disc 4:

① Select the disc.

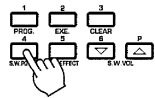

- If more than eight seconds elapse before proceeding to step ②, all tracks on the selected disc will be programmed. (1-DISC program)

② Select the track.



- Repeat steps ① and ② to program up to 32 tracks. When 32 tracks have been programmed, "FULL" appears on the display.

If you make a mistake during entry:
Press the CLEAR key and re-enter the correct number.

3 Start playback.



- Tracks are played in the order they are programmed (P-No.).
- If one of the skip keys (▶▶ or ◀◀) is pressed during programmed playback, the track being played is skipped in the forward or reverse direction.

To check the programmed order



- Every time the [CHECK] key is pressed, the track No. and the order it was programmed (P-No.) are displayed in the order of programming.
- The previous display will resume in a few seconds.

To resume normal playback



- The playback in the order of the track Nos. on CD will start after the track being played.

To stop programmed playback



Main unit



Remote control unit

■ To add a track to the program

Remote control unit only

Press the key(s) for the track No. to be added.

① Select the disc.

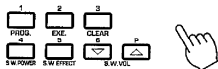

② Select the track number.



■ To change a track in the program

Remote control unit only

1 Press the CHECK key.

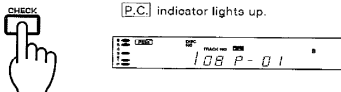

Press until the P-No. to be changed is displayed.

2 Select the track No. to replace the previous one.

① Select the disc.

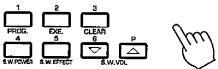

② Select the track number.

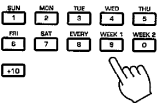

Press while the [P.C.] indicator is lighted.

- The track being played cannot be changed.

■ To clear tracks from the program

Clearing from the last track



- Every time the key is pressed, tracks are cleared from the last track in order.
- The currently playing track cannot be deleted.

Clearing the whole of program

Press either key.

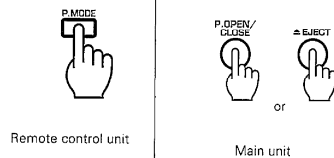

Auto-Space function

During playback in the program mode, when the [SPACE] key is pressed, a space of about 4 seconds is reserved automatically between the programmed tracks. This function is provided to facilitate the DPSS function of the cassette deck. However, such a space could also be reserved in case the sound of two tracks are continued, for example with some classic music and live recordings.

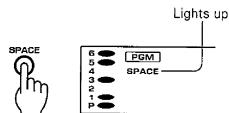

- To cancel Auto-Space function, press the [SPACE] key again.

■ **Repeated playback** (Preparation: Set the INPUT key on the preamplifier / tuner to CD.)

Repeated playback of programmed tracks.

Remote control unit only

1 Enter the PGM mode.

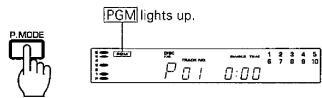

2 Select the desired track(s).

① Select the desired disc.

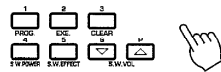

- If more than eight seconds elapse before proceeding to step ②, all tracks on the selected disc will be programmed. (1-DISC program)

② Select the desired tracks.

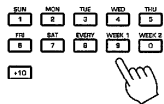

- All of the selected tracks will be played repeatedly.
- If only one track is selected, that track will be played repeatedly.

3 Press the REPEAT key.

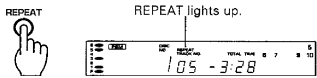

4 Start playback.

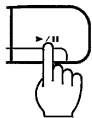

Repeated playback of the whole CD.

1 Extinguish the PGM indicator.

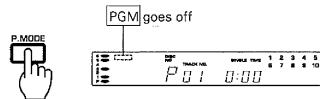

2 Press the REPEAT key.

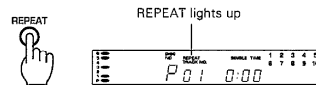

3 Start playback.



To resume normal playback

Press the **REPEAT** key again.

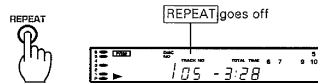

- The playback will be resumed under the CD player mode set before the repeat.

This function allows for random selection of the tracks each time and continuous playing in any order. It lets you enjoy hours of tireless track listening.

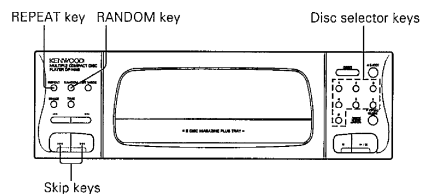

■ Playing tracks in a random order

1 Make sure the PGM indicator is extinguished.

- If the PGM indicator is lit, press the P.MODE key to extinguish the PGM indicator.

2 Select the desired random mode.

To randomly play a single disc

① Select the disc.

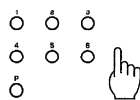

Select RANDOM ONE.

To randomly play all discs



Select RANDOM ALL.

Each press changes the random mode as shown below.



- Tunes are selected and played at random from all of the discs.

Display when track 7 of disc 3 is selected first



- When one tune ends, the next tune is randomly selected and played.

Display when track 3 of disc 5 is selected next

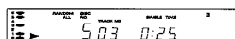

To select another track during random play

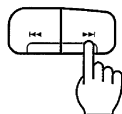

- When the skip key is pressed once during random play, the track starts again from the beginning.

To cancel random play

Select RANDOM OFF.



Each press changes the random mode as shown below.

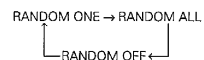

- Normal play starts.

or



- Playback stops.

Note:

The same track will not play twice over continuously, however, it may happen that the same track is repeated later in play.

Playing CDs (UD-900)

These pages describe the operations of only UD-900. For operations of UD-900M (CD changer), refer to pages 40 to 47.

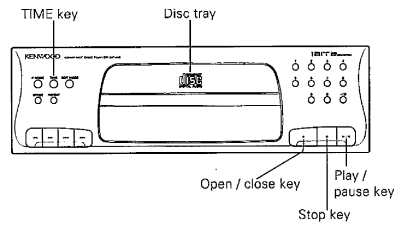

■ Playing a CD from the beginning (TRACK mode)

1 Select the CD source with the input selector of the Preamp / tuner.

2 Load a CD.

① Open the disc tray.

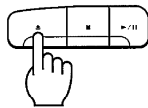

Label side facing up

② Place a disc on the tray.

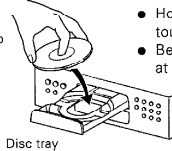

Disc tray

③ Close the tray.

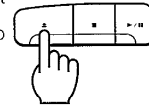

- Hold the disc taking care not to touch the side to be played.
- Be sure to place only one CD at a time.

TRACK indicator lights up → The track Nos. recorded on the CD are display.

3 Start playback.

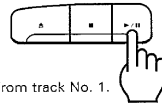

- In a few seconds, playback starts from track No. 1.

Track NO. being played Elapsed time from the beginning of track being played

To pause CD play

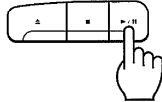

To resume playback, press the key again.

To stop CD play

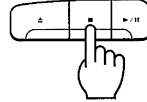

TIME key

Press the **TIME** key when you want to check the elapsed time and remaining time of the track being played. Every time the **TIME** key is pressed, the displayed time changes as shown below. The time information display may not appear when playing a CD containing 44 or more tracks. In such a case, the display (remaining SINGLE TIME) will show "-:--".

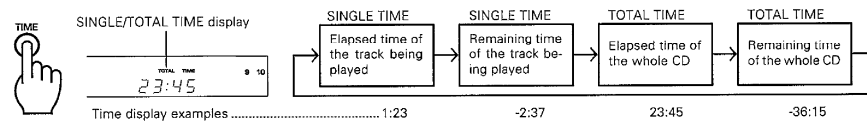

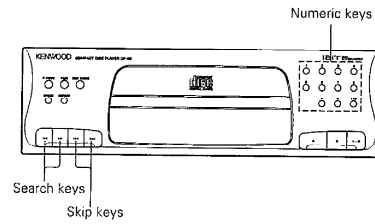

■ Listening from the desired track

Select with the skip key.

Press one of the skip keys according to which direction to skip.

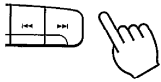

- The tunes are skipped in the direction of the key and the play starts at the beginning of the selected tune.
- When the key is pressed once during play, the track starts again from the beginning.

Select with the search key.

Press the forward or reverse search key according to the direction to search.

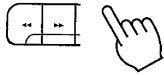

- The fast forward or reverse speed increases as the key is held depressed.
- The track will start to play from where you release the key.

Select with the numeric key.

1 Ensure that the CD player is in the TRACK mode.

- If the [PGM] indicator is lighted, press the [P. MODE] key.

2 Select the desired track.

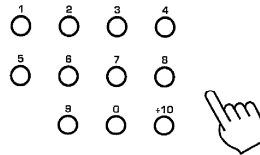

Examples of input

Track No. 23: [+10] [+10] [3]

Track No. 40: [+10] [+10] [-10] [+10] [0]

- Play starts from the selected tune and after.

Notes:

1. If a track No. which is not present on the CD is selected while the tray is open, the last track on the CD will be played.
2. Such a selection is not accepted after the tray has been closed or playback has started.

■ Playing desired tracks in desired order (PGM mode)

1 Enter the PGM mode.
Press the P. MODE key.

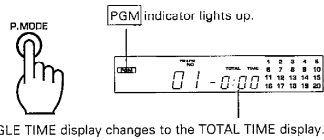

To check the programmed order

Remote control unit only

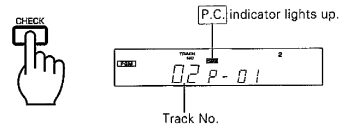

- Every time the [CHECK] key is pressed, the track No. and the order it was programmed (P.No.) are displayed in the order of programming.
- The previous display will resume in a few seconds.

2 Program desired tracks in desired order.

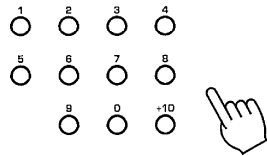

Example

To program track Nos. 2, 5 and 25: [2] [5] [+10] [+10] [5]

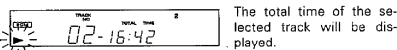
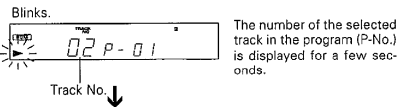

- Up to 20 tunes can be programmed. When the 21 or more tunes are selected, FULL is displayed.
- If you made a mistake, press the [CLEAR] key and select the correct track.
- Tracks can also be programmed by reading the disc label while the disc tray is open.
- If a tune number larger than 43 (44 and subsequent) is selected, the remaining time of the whole CD disc will not be displayed.

To resume normal playback



- The playback in the order of the track Nos. on CD will start after the track being played.

To stop programmed playback

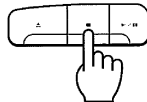

3 Start playback.

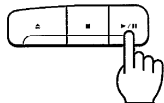

- Tracks are played in the order they are programmed (P.No.).
- If one of the skip keys ([SKIP FWD] or [SKIP REV]) is pressed during programmed playback, the track being played is skipped in the forward or reverse direction.

To check the time of each track on the disc.

In the program mode, when the disc is stopped, the time of each track on the disc can be checked by pressing the skip keys [SKIP FWD], [SKIP REV].

- The previous display will resume in a few seconds.

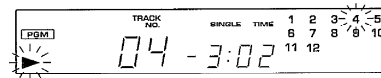

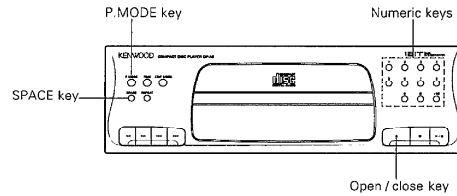
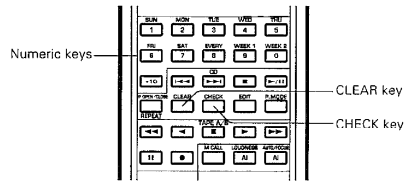

■ To add a track to the program

Press the key(s) for the track No. to be added.

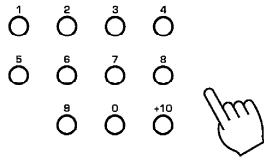

■ To clear tracks from the program

Clearing from the last track

Remote control unit only



- Every time the key is pressed, tracks are cleared from the last track in order.

■ To change a track in the program

Remote control unit only

1 Press the CHECK key.

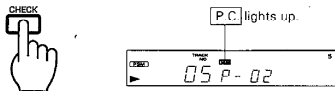

Press repeatedly until the program No. to be changed is displayed.

2 Press the key(s) to input the track No. to replace the previous one.

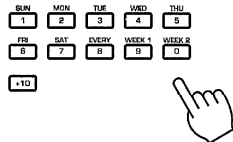

Press while the [P.C.] indicator is lighted.

- The track being played cannot be changed.

Clearing the whole of program

Press either key.

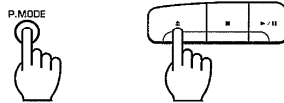

Auto-Space function

During playback in the program mode, when the [SPACE] key is pressed, a space of about 4 seconds is reserved automatically between the programmed tracks. This function is provided to facilitate the DPSS function of the cassette deck. However, such a space could also be reserved in case the sound of two tracks are continued for example with some classic music and live recordings.



- The total time is displayed including the time of the space.
- To cancel Auto-Space function, press the [SPACE] key again.

Playing CDs (UD-900)

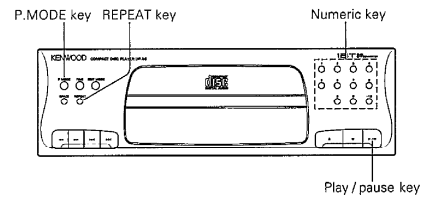

■ Repeated playback

Repeated playback of programmed tracks.

1 Enter the PGM mode.

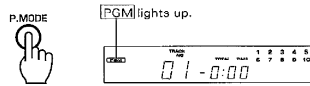

2 Select the desired track(s).

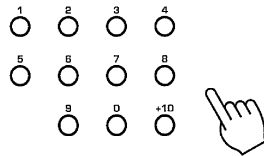

- All of the selected tracks will be played repeatedly.
- If only one track is selected, that track will be played repeatedly.

3 Press the REPEAT key.

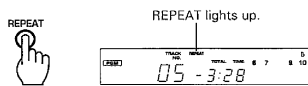

4 Start playback.

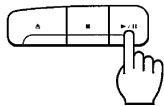

Repeated playback of the whole CD.

1 Enter the TRACK mode.

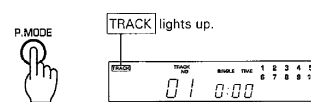

2 Press the REPEAT key.



3 Start playback.

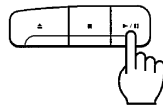

To resume normal playback

Press the REPEAT key again.



- The playback will be resumed under the CD player mode set before the repeat.

Playback operation of cassette decks

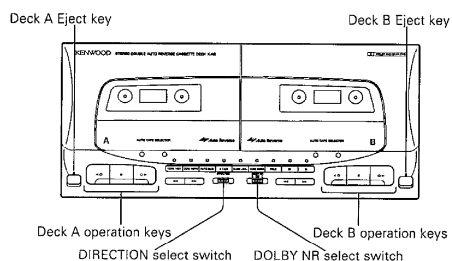

■ To playback a tape

1 Insert a cassette tape.

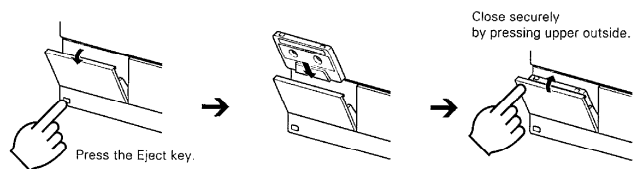

- The type of tape, Normal, Chrome or Metal, is detected and set automatically.
- Be sure to remove tape slack before insertion.

2 Determine the playback conditions.

① Select the playback mode.

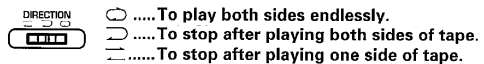

② Select the Dolby NR mode.

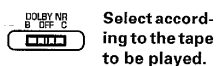

3 Start playback.

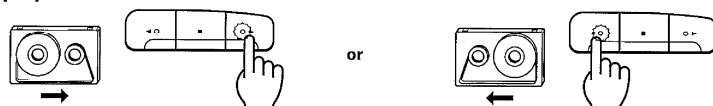

To stop playback

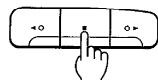

- Do not press the Eject key until the tape has stopped completely.

Dolby noise reduction system

The Dolby noise reduction system was developed to reduce the tape hiss noise generated during playback. The optimum effect of the Dolby NR system is obtained when the same type NR system is used for both recording and playback. If a different type NR system is used, playback is not performed correctly. Make sure that the same type noise reduction system is used for both recording and playback.

Dolby B NR

The most popular noise reduction system used in home audio components. Usually, Dolby NR system corresponds to B NR.

Dolby C NR

Dolby C NR offers improved noise reduction performance over that of the Dolby B NR. It features a superior noise reduction effect. Use Dolby C NR to record or playback with this unit.

It is recommended that tapes recorded with the Dolby NR system be marked "B" or "C", so that they can easily be distinguished.

Playback operation of cassette decks

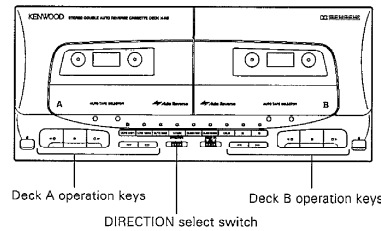

■ To wind the tape at high speed

1 Stop playback.

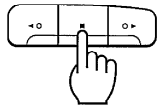

2 Press the ◀◀ key or ▶▶ key.

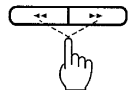

◀◀: Fast tape winding in the direction
▶▶: Fast tape winding in the direction

To stop fast tape winding

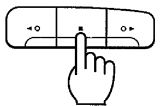

Tape transport direction indicators

The direction in which tape is transported during playback or recording is indicated by the lighting of one of the indicators ◀ and ▶. The direction selected when the tape was stopped the last time is maintained even after the power is turned off. When the tape is started automatically by the automatic play operation, etc., the transport starts with the direction shown by the direction indicator. If you want to change the transport direction for the next time the power is turned on, press the play key of the opposite direction before turning power off.

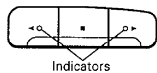

■ Relay playback

This function plays back the tapes in both decks A and B continuously and repeatedly.

1 Insert tapes.

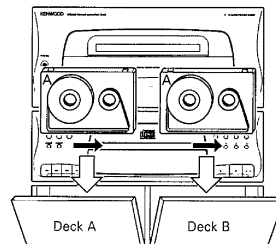

- Tapes are played in the directions indicated by their respective indicators.

2 Select the playback mode.



- ◻ ... Relay playback of both sides of tapes in decks A and B is repeated.
- ▬ ... Relay playback of only one side of tapes in decks A and B is repeated.

- Relay playback cannot be performed if the DIRECTION select switch is set to "◻".

3 Start playback.

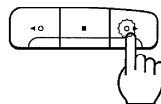

- The playback starts with the deck the play key of which is pressed.

DPSS operation

The DPSS (Direct Program Search System) enables the following convenient operations according to the instructions of the operation keys (these operation are, however, not available on both decks simultaneously). The DPSS functions are based on the detection of non-recorded spaces of 4 seconds or more between tunes.

- 1. Skip play** : By specifying a tune located several tunes beyond (or behind) the tune being played, skips tunes between the current tune and the selected tune, and starts playback from the beginning of the selected tune. Up to 16 tunes can be skipped in Skip Search.
- 2. Single-tune repeated playback** : One single tune is played back repeatedly up to 16 times.
- 3. Rewind & Play** : Rewinds the tape to the beginning and starts playback from there.
- 4. Dash & Play** : If a non-recorded space of more than 10 seconds is detected during playback, that space will be skipped by fast forward tape winding.

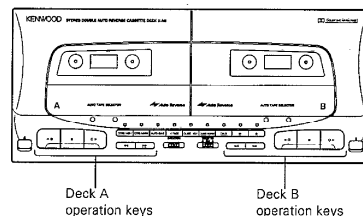
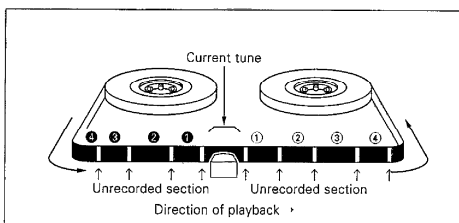

■ Skip play operation

The example below shows the case in which the direction indicated by the tape transport direction indicator is ►. If the direction indicated by the tape direction indicator is ◀, always press the keys for the opposite directions to those shown in the illustrations below.

To play a tune located immediately after the tune being played.

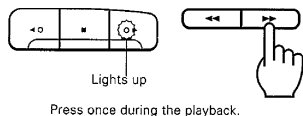

To play the tune being played from the beginning.

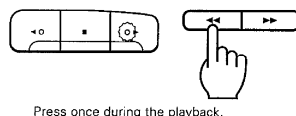

To play a tune located 4 tunes beyond.

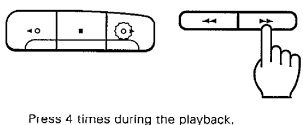

To play the tune located 4 tunes behind.

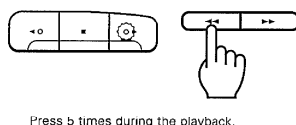

The DPSS will not function properly with the following types of tapes.

- Tapes containing spaces of 4 seconds or more, such as conversations and speeches.
- Tape containing extremely low levels or non-recorded spaces in the middle of tunes, such as classical music.
- Tapes containing recording of large noise between tunes.
- Tapes containing spaces of less than 4 seconds between tunes.
- Tapes recorded with low recording level.
- Tapes recorded using Cross-fade recording.

DPSS operation

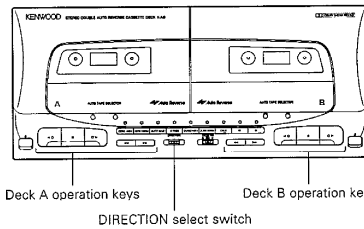

■ Rewind & Play operation

This operation is not available from the remote control unit.

■ Dash & Play operation

The Dash & Play skips long non-recorded spaces automatically as the tape is played. This operation is not available from the remote control unit.

Direction of tape direction indicator: ►

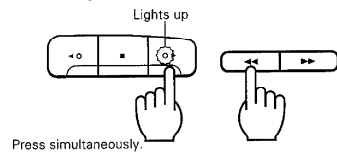

Press simultaneously.

Direction of tape direction indicator: ◀

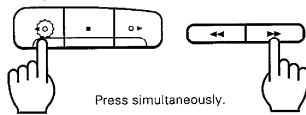

Press simultaneously.

■ Single-tune repeated playback operation

1 Play the tune to be repeated.

2 Press the play key of the same direction as the current tape transport direction.

When direction of tape direction indicator is: ►

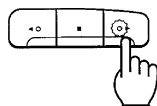

- Normal playback resumes after repeating the same tune for 16 times.

1 Determine the playback mode (conditions).



- Two sides are repeated 8 times, after which playback stops.
- ▷ Two sides are repeated only once, after which playback stops.
- ≡ One side is repeated 8 times, after which playback stops.

- In case the DIRECTION select switch is set to "▷" and tapes are inserted in both of the decks, when a deck finishes Dash & Play, the other deck starts Dash & Play for 16 times, after which it stops.

2 Press the ◀◀ and ▶▶ keys simultaneously.

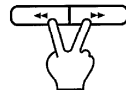

To cancel the playback above in the middle.

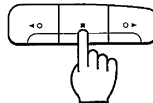

- Playback is stopped.

Recording operation on cassette deck (Deck B only)

The cassette deck incorporates the Dolby HX Pro headroom extension function and auto-bias function to provided a recording with superior high-frequency characteristics.

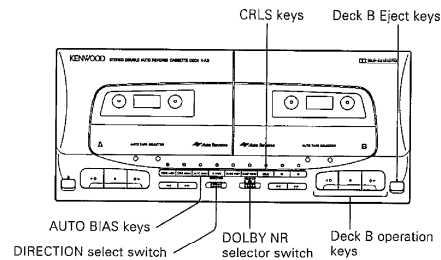

■ Ordinary recording

1 Set up the cassette deck.

① Insert a tape in deck B.

② Set the tape transport direction.

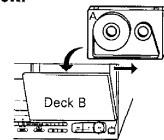

③ Select one-side or two-side recording.

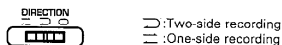

④ Select the Dolby NR mode.



- When the microphone is not to be used, be sure to set the MIC MIXING control fully counterclockwise.

2 Select the source to be recorded.



Select a music source other than TAPE.

To apply the equalizer effect

Refer to page 60.

- When recording tapes for playing in a car stereo or headphone stereo, select CAR AUDIO or HP STEREO. (See page 37.)

3 Activate the auto-bias setting.

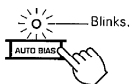

- The optimum bias is set in about 45 seconds, after which the deck enters the stop mode.
- To cancel the auto-bias adjustment operation in the middle, press the Stop key.
- Recording is possible even when the auto-bias setting is omitted.

4 Set the recording level.

① Play a music source.

② Press the CRLS key.

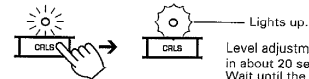

Level adjustment completes in about 20 seconds. Wait until the indicator lights steadily.

- The deck enters the record pause mode.
- If you press the Record key while the indicator is blinking, the recorded sound may distort.
- When the [CRLS] key is pressed while the indicator is blinking, the level adjustment is terminated at that moment and the deck enters the record-pause mode.
- The recording level setting is suspended if the sound of source is not input within about 5 second after the [CRLS] key has been pressed.

5 Start recording.

① Play the music source from the beginning.

② Press the [RECORD] key.

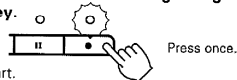

- Recording will start.
- The deck enters the stop mode automatically when the tape has been recorded till the end.

Auto-bias function

The tapes categorized as "normal" or "chrome" tape vary widely in the characteristics from popular to high-class types. Therefore, this system is equipped with the auto-bias adjustment function for exclusive use with normal or chrome tapes so that optimum recording can always be obtained with any types of normal or chrome tapes. It is recommended to use the auto-bias function when using a normal or chrome tape.

- During auto-bias adjustment, the keys are defeated except for the [REVERSE], [STOP] and [EJECT] keys of Deck A and [STOP] key of Deck B.
- If the amount of remaining tape is small, the auto-bias adjustment may be canceled in the middle and tape stopped at that position.
- The auto-bias level is canceled when the [EJECT] key of Deck B is pressed.

Recording operation on cassette deck (Deck B only)

■ To pause recording temporarily

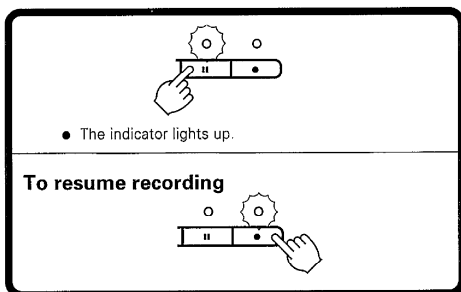

■ To stop recording

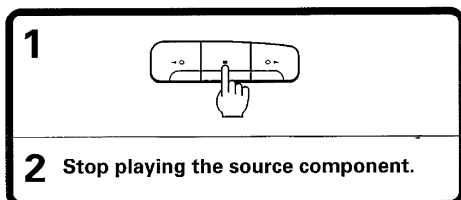

■ To re-start recording after mistake

The following procedure is useful when you want to cancel recording in progress and restart it.

A non-recorded space of about 4 seconds or more should be reserved before the position where recording was started.

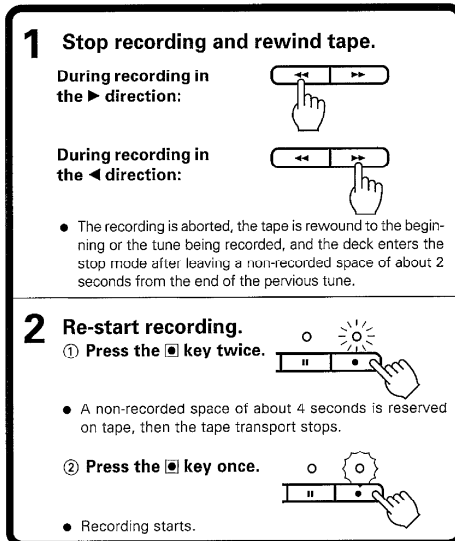

CRLS

CRLS (Computer-controlled Recording Level System):

This function sets the optimum recording level automatically based on the sampling of the levels of a musical source for about 20 seconds.

- Even when you do not press the [CRLS] key Recording is performed with the basic recording level. The basic recording level common for all input select keys has been set at the factory.
- The level is stored in memory once it has been set The level determined by the [CRLS] key for each input source (LD / AUX, VIDEO, MD / DAT, TUNER, CD) is stored in memory. From the next time, the same level is recalled for the same source and applied for recording even when the [CRLS] key is not pressed.
- To re-use the previous level after having pressed the [CRLS] key Press the Stop key while the CRLS indicator is blinking to re-use the previously-set level.
- When the [CRLS] key is held depressed for more than 3 seconds The indicator blinks at low speed then goes out. At this time, the CRLS level which has been stored for the input source being indicated returns to the basic recording level.

Recording with Dolby HX Pro

When recording on B deck, the Dolby HX Pro headroom extension function automatically operates to provide a recording with superior high-frequency characteristics.

What is Dolby HX Pro ?

In ordinary recording using high-frequency biasing, the high-frequency bias current, which should be constant, is increased with some recording sources due to the high-frequency component contained in the music, etc. This increase affects the recording characteristics with distorted high frequencies and degraded dynamic range and frequency response.

The Dolby HX Pro circuit detects the high-frequency component contained in the music source being recorded, and reduces excessive bias current to make it constant. As a result, the recording characteristics of high frequencies are drastically improved, and the improved high-frequency reproduction can also be enjoyed even when the tape is played on tape decks which are not equipped with circuit.

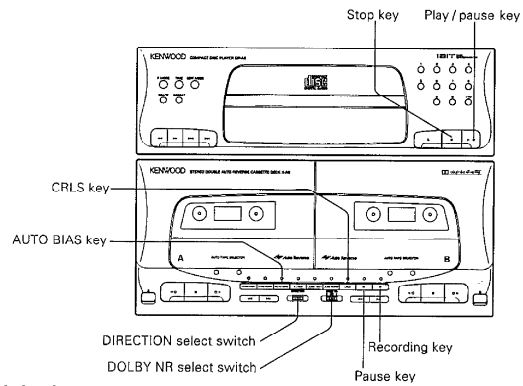

■ Synchro recording of CD

The cassette deck and the CD player can be started simultaneously.

1 Set up the cassette deck.

- ① Insert a tape in deck B.

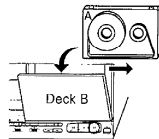

- ② Set the tape transport direction.

- ③ Select one-side or two-side recording.

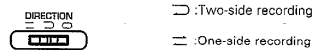

- ④ Select the Dolby NR mode.



2 Activate the auto-bias setting.

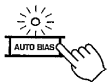

- The optimum bias is set in about 45 seconds, after which the deck enters the stop mode.

3 Adjust the recording level.

- ① Play a CD.

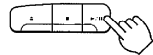

- With the UD-900M (DP-MA9) system, select the desired disc.

- ② Press the CRLS key.

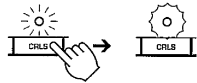

Level adjustment completes in about 20 seconds.

Wait until the indicator lights steadily.

- The deck enters the record-pause mode.

- ③ To pause CD play.

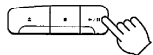

4 Start playing the CD.

- ① Select the desired tracks with the numeric key.
② Start playback.

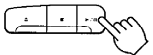

- Recording starts at the same time.
- When the CD player has completed playback, the cassette deck stops recording and enters the stop mode.

To pause recording

Press the [II] key of the CD player.

To resume recording

Press the [II] key of the CD player.

To stop recording

Press the [■] key of the CD player.

- When the [■] key on the cassette deck is pressed, the cassette deck enters the stop mode, but the playback of CD does not stop.

Recording operation on cassette deck (Deck B only)

■ Operation of CD REC key

The CD REC key allows to listen to another music source while recording a CD.

- 1 Press the CD REC key of the preamplifier / tuner.



- 2 Start recording the CD.

- Refer to "Synchro recording of CD" and "Recording of CD playback (CCRS)".

- 3 Select the music source to be listened to.



Press repeatedly.

Select a music source other than TAPE.

To cancel CD REC operation

Press the key again.



- This key is not accepted while the record indicator is lighted or blinking.

Notes:

1. When the **CD REC** key is set to ON, the CD sound cannot be recorded with the equalizer effect.
2. After CD REC recording, be sure to press the **CD REC** key to turn CD REC OFF.

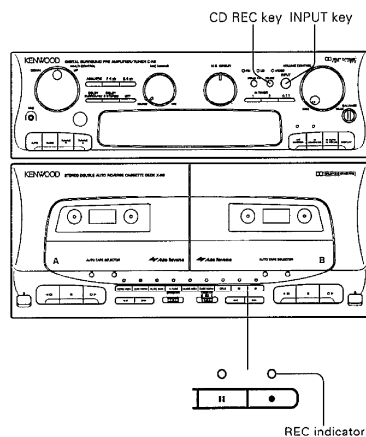

Recording modes

This system is equipped with the four recording modes listed below. Select the mode which best matches your recording purpose and sound preference.

- ① **CD REC mode**
Select using the **CD REC** key.

In this mode, sound is recorded directly from the CD for pure, high-quality recordings. If desired, you can listen to another music source while recording is being carried out.

- ② **PRESENCE REC mode**
Set to the **F. 4ch** position.

This mode applies a presence effect to the sound during recording which is ideal for playback on a car stereo or headphone stereo. (See page 30.)

- ③ **EQ. REC mode**
Set to **DSP OFF** or **ACOUSTIC** mode.

Use this mode to apply a desired equalizer effect to the sound during recording. (See page 37.)

If none of the above recording modes is selected, the music source is recorded normally without altering the sound.

- To play a tape recorded with presence or equalizer effect, cancel the effect.

Recording of CD playback (CCRS)

The CCRS (Computer-controlled CD Recording System) makes the following convenient recordings possible by setting the optimum recording level and recording bias for the specific CD to be recorded and starting recording automatically. (CCRS recording is available only with Deck B.)

- Recording of TRACK mode playback** : CCRS starts recording the CD tracks from the first track in order. When the end of one tape side is reached during recording, fade-out occurs there, and recording is continued on the other side of tape, which starts with fade-in.
- Recording of PGM mode playback** : CCRS starts recording the programmed CD tracks in the programmed order. When the end of one tape side is reached during recording, the track which should end in the middle is erased, and the recording on the other side of tape is started from the beginning of that track. (Programming back and forth between several discs is not possible.)
When programming tracks on two discs or more, perform the MULTI EDIT recording.
- Normal EDIT recording** : When the recording time of the tape is specified first, the order of the CD tracks are edited so that no track is interrupted at the end of each side of tape. The maximum number of tracks that can be edited is 20. (PRIORITY EDIT (UD-900 only): By programming desired tunes beforehand, those tunes will be given priority during the editing selection process.)
- AI EDIT recording** : When the total playing time of a CD exceeds the recording time of tape, all tracks can still be accommodated in the tape by fading out the end of each track. (AI PRIORITY EDIT (UD-900 only): By programming desired tunes beforehand, those tunes will be given priority during the editing selection process and will not be fade-out during recording)
- MULTI EDIT recording** : Tracks on multiple CDs can be edited and accommodated in a single tape.
- X.FADE (Cross-fade) recording** : The beginning and end of each track is faded in / out to create a music tape without interruption between tunes.
- CCRS double-speed recording** : Records CD at twice the normal speed.

Also, refer to "Playing CDs".

CCRS (Computer-controlled CD Recording System)

When the CCRS key is pressed, the following operations occur automatically and recording of CD starts after them.

1. The CD is played and its peak level is sampled from the level used when the disc was recorded.
2. The optimum recording level for that disc is determined from the sampled peak level and the cassette deck is set accordingly.
3. The cassette deck sets automatically the optimum bias for the tape used in recording.
4. The recording preparations detailed above are completed in about 90th seconds, after which actual recording starts.
5. When the recording is completed (when the CD player ends playback or when the tape has been recorded), both the cassette deck and CD player enter the stop mode.
 - The set recording level and auto bias level are maintained while the CCRS and AUTO BIAS indicators are lighted.
 - The recording level is canceled when the open / close key of the CD player is pressed, the auto bias level is canceled when the Eject key of Deck B is pressed, and both are canceled if the power is turned off.

Display during CCRS operation

indicator	Lighting ○ Blinking ☼ OFF ●			
	CCRS ₁	AUTO BIAS ₂	Pause	Recording
During recording level setting	☼ Quick blinking	●	○	○
During auto bias adjustment	☼	☼	●	○
	☼	☼	●	●
During recording	☼ Slow blinking	○	●	○
During record-pause	○	●	○	●
	UD-900	UD900M		

- *1. To cancel CCRS setting : Press the open / close key of the CD player.
- *2. To cancel auto bias setting : Press the Eject key of the cassette deck.
- *3. The time varies according to the number of the tunes to be recorded.

Fade-in and fade-out

Fade-in refers to a gradual increase of volume from the minimum to normal level when starting to play music. Inversely, fade-out refers to a gradual decrease of volume from the normal to minimum level at the end of music.

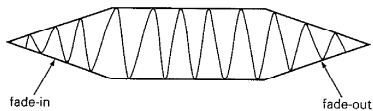

CCRS double-speed recording

CD and cassette deck are both played at twice the normal speed and recorded, making it possible to half the time required for recording. Since the CD is played in double speed in this case, the recorded content cannot be enjoyable as music even though it can be monitored from the speakers. In double-speed recording, tunes are recorded onto the tape without DOLBY NR effect. So playback the tape without DOLBY NR effect. During CCRS double-speed recording, cancel the equalizer effect. (Refer to page.37).

Recording of CD playback (CCRS)

■ Recording of CD playback in TRACK mode

Fade-out and fade-in occur at the end of tape where it is reversed.

1 Select CD with the input selector, and place a CD on the tray.

2 Perform "Ordinary recording" until step 2.
 • Refer to page 57.

3 Check that the CD player is in the TRACK mode.
 • If the [PGM] indicator is lighted up, press the [P.MODE] key.

With the UD-900M (DP-MA9) system, press the disc selector key to select the disc to be recorded.
 • Check the playback sound.

4 Start recording.

Normal-speed recording

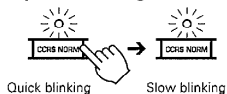

Double-speed recording

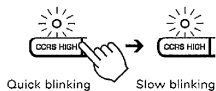

- The CCRS is activated so the recording will start in about 90 seconds.
- The tracks on the disc are recorded in the order of the track Nos.
- The operations as shown below occur at the end of tape where it is reversed.

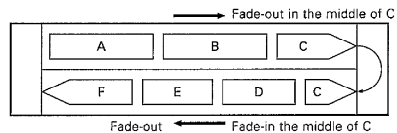

■ Recording of CD playback in PGM mode

Tracks are recorded so that they do not end in the middle at the end of tape.

1 Select CD with the input selector, and place a CD on the tray.

2 Perform "Ordinary recording" until step 2.
 • Refer to page 57.

3 In the PGM mode, select the order of tracks to be played.
 • For programming with the UD-900M system, refer to page 44. For programming with the UD-900 system, refer to page 50. (Programming back and forth between several discs is not possible.)
 • When programming tracks on two discs or more, perform the MULTI EDIT recording described on page 65.

4 Start recording.

Normal-speed recording

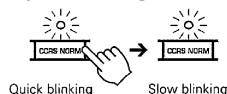

Double-speed recording

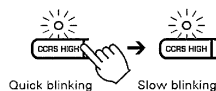

- The CCRS is activated so the recording will start in about 90 seconds.
- The tracks on the disc are recorded in the order of programmed order.
- The operations as shown below occur at the end of tape where it is reversed.

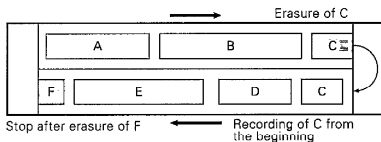

Notes:

1. When the [CCRS] key is pressed during CD playback, the playback is stopped and CCRS setting operation starts.
2. The CCRS recording makes it unnecessary to adjust the recording level manually.
3. The CCRS searches the peak level on a CD in a limited period of about 90 seconds. Therefore, it could happen that the optimum level cannot be adjusted, though it is a very rare case.
4. If the length of a track on the CD is extremely long such as with a classical music, the CCRS cannot be used because the music cannot be fit in one side of tape.
5. When the DIRECTION select switch of the cassette deck is "→" the tape end processing occurs only on the A side of tape.
6. When the tune being recorded at the end of the tape is to be faded out, the ending part of the previous tune may also be faded out if the space between the tunes is short.

Normal EDIT recording

This function allows to edit, base on the recording time of the tape specified, the order of the CD tracks so that no track is interrupted at the end of each side of tape.

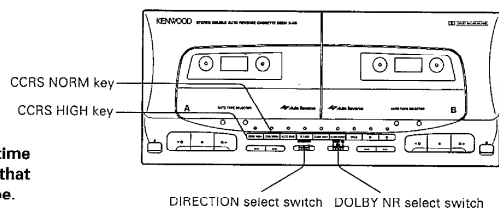

1 Set up Deck B ready for recording.

- ① Insert the cassette tape.
- ② Check the tape transport direction.
 -
- ③ Select the tape sides to be recorded.
 -
- ④ Select the Dolby NR mode.
 -

To apply an equalizer effect
See page 60.

2 Select the CD input.

3 Insert the disc in the CD player.

With the UD-900 system:

- When you wish to program tunes, carry out the programming before step 4.
- To use the auto space function (page 51), press the **[SPACE]** key.

With the UD-900M system:

- Close the door.
- Verify that the **[PGM]** indicator is extinguished. If even only one tune is programmed, editing cannot be carried out.

4 Select the EDIT mode with the EDIT MODE key of the CD player.

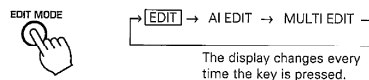

- Proceed to the next step within 8 seconds after setting EDIT. If 8 seconds have elapsed, select the EDIT mode again.

With the UD-900M (DP-MA9) system, press the disc selector key to select the disc to be recorded.

5 Input the two-way recording time of the tape.

Use the numeric keys of the CD player.

C-30 tape: **[+10] [+10] [+10] [0]**

C-46 tape: **[+10] [+10] [+10] [+10] [6]**

- 46, 54, 60 or 90 can also be selected every time the **[TIME]** key is pressed. In this case, press the **[EDIT MODE]** key again to establish the input.
- Tracks are edited automatically to fit sides A and B, and the end of editing is indicated when the **[EDIT]** indicator changes from blinking to continuous lighting.
- If a program containing a few tracks has been programmed previously, these tracks can be recorded in priority. (UD-900 only)
- When the **[EDIT MODE]** key is pressed again while **[EDIT]** is lighted, "SHUFFLE" appears on the display and re-editing of tracks is performed. (UD-900 only)

6 Press the CCRS key.

Normal-speed recording

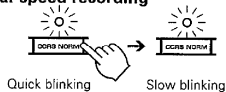

Double-speed recording

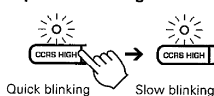

Recording occurs as shown below. (example for the UD-900 system)

Priority given to programmed tracks → Track subjected to time adjustment

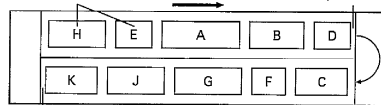

Track subjected to time adjustment ← Tracks are recorded basically according to their numbers, but some tracks are replaced with tracks subjected to time adjustment.

- The CD player and cassette deck enter the stop mode automatically after the completion recording.

Notes:

1. Edit operation does not occur if a track No. 44 or more has been programmed. (With the UD-900M system, programming is not possible.)
2. Repeat playback is not available.
3. To cancel the auto-spacing, press the **[P. MODE]** key and re-start the procedure from step 4. (UD 900 only)

AI EDIT recording

When the total playing time of a CD exceeds the recording time of tape, this function allows to accommodate all tracks in a tape by cutting the end of each track by means of fade-out. It is also possible to specify the important tracks that must not be cut. (AI PRIORITY EDIT (UD-900 only))

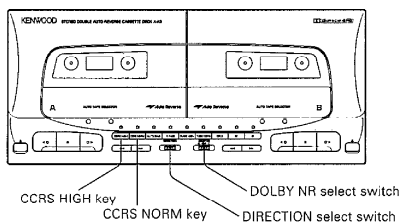

1 Set up Deck B ready for recording.

- ① Insert the cassette tape.
- ② Check the tape transport direction.
 - DIRECTION : Select two-side recording.
- ③ Select the tape sides to be recorded.
 - DOLBY NR : Select two-side recording.
- ④ Select the Dolby NR mode.

To apply an equalizer effect See page 60.

2 Select the CD input.

3 Insert the disc in the CD player.

- With the UD-900M system, close the door and make sure the [PGM] indicator is extinguished.

4 Select the tracks which must not be cut in recording.

- UD-900 only:**
- ① Press the P.MODE key.
 - [PGM] lights up.
 - ② Input the track Nos. using the numeric keys.
 - Input several numbers in a desired order.
 - For details, refer to "Playing desired tracks in desired order" on page 50.

5 Select the AI EDIT mode with the EDIT MODE key of the CD player.

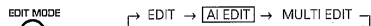

The display changes every time the key is pressed.

- Proceed to the next step within 8 seconds after setting AI EDIT. If 8 seconds have elapsed, select the AI EDIT mode again.

With the UD-900M (DP-MA9) system, press the disc selector key to select the disc to be recorded.

6 Input the two-way recording time of the tape.

Use the numeric keys of the CD player.

- C-30 tape: [+10] [+10] [+10] [0]
- C-46 tape: [+10] [+10] [+10] [+10] [6]

- 46, 54, 60 or 90 can also be selected every time the [TIME] key is pressed. In this case, press the [EDIT MODE] key again to establish the input.
- Tracks are edited automatically to fit sides A and B, and the end of editing is indicated when the [AI EDIT] indicator changes from blinking to continuous lighting.

7 Press the CCRS key.

Normal-speed recording

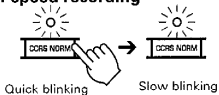

Double-speed recording

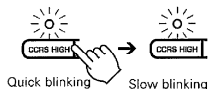

Recording occurs as shown below.(example for the UD-900 system)

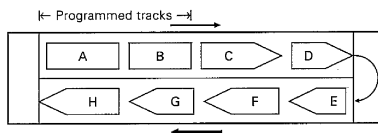

- First, the programmed tracks are recorded without any cutting, the other tracks are recorded with the end of every track cut by fade-out. (UD-900 only)
- If the tape has enough recording time, all tracks are recorded until the end.
- The CD player and cassette deck enter the stop mode automatically after the completion of recording.

Notes:

1. If an extremely-short tape recording time is set, automatic editing may not occur.
2. The [SPACE] key and [REPEAT] key functions are inoperative.
3. Edit operation does not occur if a track No. 44 or more has been programmed. (With the UD-900M system, programming is not possible.)
4. X: FADE recording is not possible.

■ MULTI EDIT (Multiple disc edit) recording

This function allows to edit desired tracks on multiple CDs, each of which containing no more than 20 tracks, and record them on a single tape while replacing discs.

With the UD-900M system, load the desired discs for editing into the magazine and plus-1 tray beforehand.

1 Set up Deck B ready for recording.

- ① Insert the cassette tape.
- ② Check the tape trans-
port direction.
- ③ Select the tape sides to
be recorded. ▷ :Select two-side recording.
- ④ Select the Dolby NR mode.

To apply an equalizer effect See page 60.

2 Select the CD input.

3 Insert the disc in the CD player.

- With the UD-900M system, close the door and make sure the [PGM] indicator is extinguished.

4 Select the MULTI EDIT mode with the EDIT MODE key of the CD player.

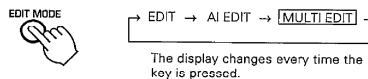

- Proceed to the next step within 8 seconds after setting MULTI EDIT. If 8 seconds have elapsed, select the MULTI EDIT mode again.

5 Input the two-way recording time of the tape.

Use the numeric keys of the CD player.

C-30 tape: [+10] [+10] [+10] [0]

C-46 tape: [+10] [+10] [+10] [+10] [6]

- 46, 54, 60 or 90 can also be selected every time the [TIME] key is pressed. In this case, press the [EDIT MODE] key again to establish the input.
- [MULTI EDIT] changes from blinking to continuous lighting, indicating the program input stand-by, and the recordable time of side A is displayed.

With the UD-900M system, select one of the seven discs loaded in the player.

- To select another disc, press the [] key while the play track number blinks.

6 Select the tracks to be recorded.

Using the numeric keys of the CD player, input the track Nos. in the order they are to be recorded. (on the remote control unit with the UD-900M system)

- The TOTAL TIME display shows the remaining time on the tape side A or B.
- When "FULL" appears on the display, this indicates that tracks cannot be recorded any more.

7 Press the CCRS key.

Normal-speed recording

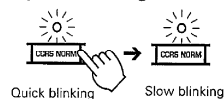

Double-speed recording

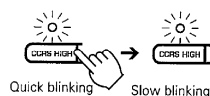

Recording occurs as shown below (example when three CDs are to be recorded).

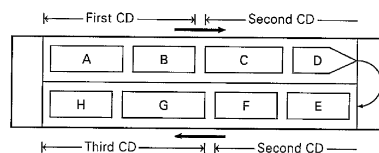

- When the first CD has been recorded, both the CD player and cassette deck enter the stop mode. With the UD-900 system, the tray of the CD player opens automatically.

With the UD-900 system:

To record the second and third CDs, repeat steps 6 and 7 after changing the CDs and closing the tray of the CD player.

With the UD-900M system:

Select another disc and repeat steps 6 and 7.

Notes:

1. In step 6, the display of the CD player shows FADE and the end of the selected tune which is longer than the preset time is faded out.
2. Track No. 44 (21 with the UD-900M system) or more cannot be input.
3. The [SPACE] key and [REPEAT] key functions are inoperative.
4. During recording, do not press the P.OPEN / CLOSE or magazine eject key. (UD-900M)

Recording of CD playback (CCRS)

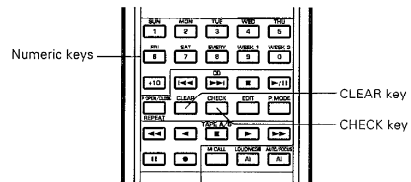

■ To check the edited contents

Remote control unit only

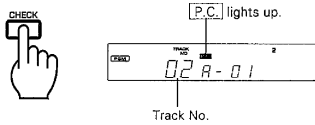

- Every time the key is pressed, the track Nos. are displayed in the edited order.
- Only the track Nos. on the disc being present in the CD player are displayed in case of MULTI EDIT. (With the UD-900M system, tunes from only the currently selected disc are deleted.)

■ To clear the edited contents

Remote control unit only

Clearing individual tracks from the last track (MULTI EDIT only)



- Every time the key is pressed, the last track in the edited sequence of tracks is cleared.
- Only the track on the disc being present in the CD player can be cleared. (With the UD-900M system, tunes from only the currently selected disc are deleted.)

Clearing all edited contents



or



(UD-900)



(UD-900M)

- Only the track on the disc being present in the CD player can be cleared in case of MULTI EDIT. (With the UD-900M system, tunes from only the currently selected disc are deleted. While playing a disc in plus-1 tray, press the P. OPEN / CLOSE key.)

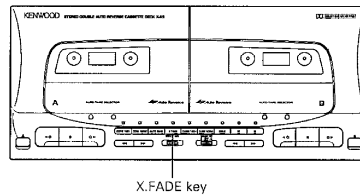

■ X.FADE recording of CD playback

Not available with double-speed recording

1 Select CD with the Input selector, and place a CD on the tray.

- For normally playback with the UD-900M (DP-MA9) system, press the disc selector key to select the disc to be recorder and check the playback sound.

2 Perform "Ordinary recording" until step 2.

- Refer to page 57.

3 Start recording.

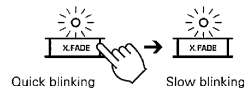

- The CCRS is activated so the recording will start in about 90 seconds.
- The recording operation according to the mode of the CD player starts.

In case of TRACK or PGM mode

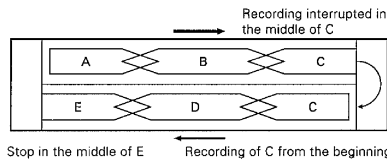

In case editing (Normal EDIT, MULTI EDIT) is executed before recording

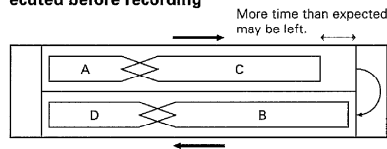

Note:

If a tune beginning and ending with fade-in and fade-out is recorded by X. FADE recording, spaces between recorded tunes may become very long.

Tape dubbing

The dubbing refers to the copy of the recorded contents of a tape to another tape (tape in Deck A → tape in Deck B).

Normal-speed dubbing: Copy at normal tape speed.
High-speed dubbing: Copy at double the normal speed.

1 Insert tapes in the cassette decks.

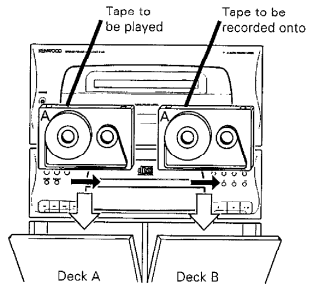

2 Set the same tape transport direction for both tapes.

- Refer to page 54.

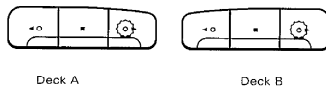

3 Select one-way or two-way dubbing mode.

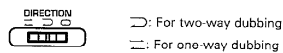

4 Press the AUTO BIAS key.

- The optimum bias is set in about 45 seconds, after which the cassette decks enter the stop mode.

5 Start dubbing.

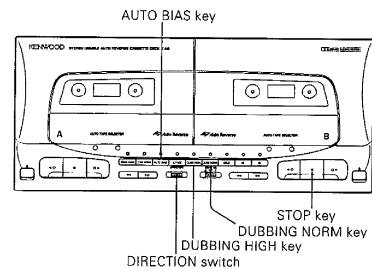
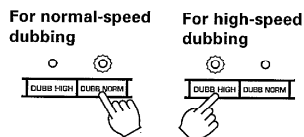

To stop dubbing

Press the Stop key of Deck B

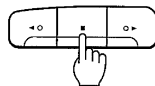

- Both Decks A and B enter the stop mode.

To pause dubbing

Normal-speed dubbing: Press the NORM key.

High-speed dubbing: Press the HIGH key.

- Only deck B enters the record-pause mode after leaving a non-recorded space of about 4 seconds in case of normal-speed dubbing, or about 6 seconds in case of high-speed dubbing.
- To skip tunes you do not want to dub on another tape during dubbing, press the [▶▶] key of Deck A.
- To resume dubbing after pause, press the same DUBBING key as above ([NORM] or [HIGH]) again.

Notes:

- The recording level cannot be adjusted for dubbing.
- The [DOLBY NR] switch does not function during dubbing.
 - * The tape recorded by dubbing features the same NR system as the original tape in Deck A.
- Noise from TV may interfere with dubbed sound if high-speed dubbing is executed near a TV set. To prevent this, install the system farther from the TV set.
- If the original tape was recorded at a high level, the sound quality may be degraded if high-speed dubbing is used. In such a case, use normal-speed dubbing.

Operation with video components

Please refer to page 12 for the connection of Audio / Visual components.
For the connections and operations, also read carefully the instruction manuals supplied with the video components to be connected.

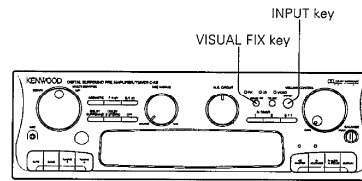

■ Playback of videotape

1 Switch the power of the monitor TV ON.

2 Set the input selector to VIDEO mode.

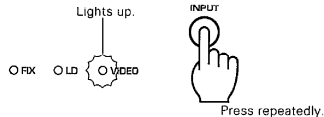

3 Play the VCR.

■ Recording of video source

1 Connect the video component to be recorded.

- A video player deck, video camera, LD player, DBS tuner, etc., can be connected.

2 Select the corresponding input source.

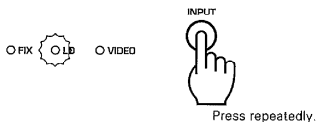

3 Play the video source component.

4 Put the VCR in the record mode.

■ Listening to CD or tape sound while watching video

1 Select the video component the image of which is to be viewed.

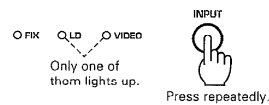

2 Press the VISUAL FIX key.



3 Select the audio source to be listened to.

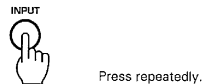

- Only the audio source is switched over while the image being displayed remains the same.

4 Play the selected video and audio components.

VISUAL FIX key

You can use this function to lock in a selected video input (LD / AUX, VIDEO). Once a video input is selected and VISUAL FIX is ON, the video signal will not change even if the input selector is switched to another video input.

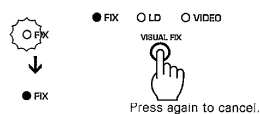

Simple Karaoke singing entertainment

HIT MASTER:

This key allow to reduce the vocal level of songs played on CD, etc., so that you can sing along with only the accompaniment just like in "Karaoke" singing. This feature is convenient when you want to master a latest song the "Karaoke" backing of which is not available. This key does not function in DOLBY SURROUND or DOLBY 3 STEREO mode.

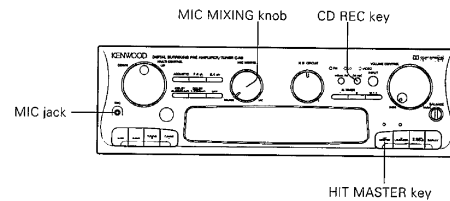

Microphone mixing

- 1 Turn the MIC MIXING control fully counterclockwise.



- 2 Insert the microphone plug into the MIC jack.



- 3 Adjust the volume balance between the microphone and source.



Singing "Karaoke"

- 1 Play the music source.

- 2 Press the HIT MASTER key.



- Only the vocal part level is reduced from the music source. However, note that this effect cannot be obtained with certain types of sources.

- 3 Sing along with the music.

- The overall volume is adjusted with the VOLUME CONTROL.

Recording "Karaoke"

- 1 Connect a microphone.

- 2 Ensure that the CD REC is OFF.



- 3 Press the HIT MASTER key.



- 4 Perform the "Ordinary recording" procedure until step 4.

- Refer to page 57.

- 5 Start recording.

- ① Play a music source.
- ② Press the record key.
- ③ Sing along with the music.

- A "Karaoke" accompaniment tape can also be created by recording music with the MIC MIXING control set fully counterclockwise.

- 6 Stop recording.

Notes:

1. When the microphone is not to be used, be sure to set the MIC MIXING control fully counterclockwise.
2. The mixture of microphone sound and tape playback sound can not be recorded.

Operation of timer

Be sure to adjust the present time before proceeding the following.

The timer of the system can be used for the following functions.

- Program timer** : Receives broadcast, records broadcast or plays tape or CD at the specified ON time, and switches power OFF at the specified OFF time.
Up to four timer programs can be set. The AI TIMER functions can be added to the program timer function.
- AI TIMER 1** : When the power is switched ON at the timer ON time, the volume will increase in three steps, providing a wake-up effect like an alarm clock.
- AI TIMER 2** : When the power is switched ON at the timer ON time, two tracks of a CD is played first, then the input is switched automatically to the tuner.
- Sleep timer** : Switches power OFF after a set time period has elapsed. If set before you go to bed, power can be switched OFF automatically even after you fell in sleep.
- One-touch timer** : Switches power ON after a specified time period, set in the unit of 30 minutes up to 12 hours, from the moment it is activated. The AI TIMER functions can be added to the one-touch timer function.
- Calendar check** : When the year, month and day are input in this order, the day of the week of that date is displayed by means of an indicator.

- For the timer setting procedures, read description on the next page and after.
- The contents of time programs can be modified as required.
- Even when a timer program has been input, the timer will not be activated unless its execution has been activated.
- Turn the AI TIMER functions OFF when they are not required; otherwise, they will be added to all of the programs executed on that day.
- Once set, the contents of a program cannot be cleared at once. The previous contents can only be cleared when they are replaced by modification.
- The programs must be set so that their time ranges do not overlap.

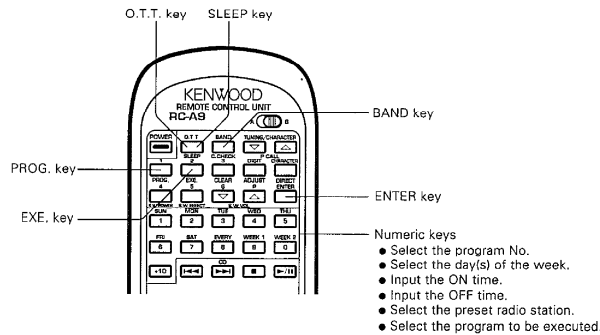

Types of days of the weeks which can be selected by numeric keys

1. To execute a program only once on the specified day of the week after its execution has been activated.

Numeric keys

Sunday	0	1	2	3	4	5	6	7
Monday	0	1	2	3	4	5	6	7
Tuesday	0	1	2	3	4	5	6	7
Wednesday	0	1	2	3	4	5	6	7
Thursday	0	1	2	3	4	5	6	7
Friday	0	1	2	3	4	5	6	7
Saturday	0	1	2	3	4	5	6	7

- If it is required to activate the timer in the same time period of the next week, activate the execution again.

2. To execute a program repeatedly on every week after its execution has been activated.

Numeric keys

Every day from Monday to Sunday	8
Every day from Monday to Saturday	9
Every day from Monday to Friday	0

- If timer operation is not required, cancel the program execution.

Be sure to adjust the present time before proceeding the following.

■ Timer reception of radio broadcast Remote control unit only

1 Switch the power ON.
Press the **[POWER]** key of the power amplifier.

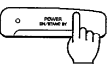

2 Select the program setting mode.



• The program No. indicators (1 to 4) blink.

3 Select the program No. to be used.

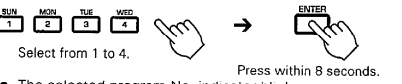

Select from 1 to 4.
Press within 8 seconds.

• The selected program No. indicator blinks.

4 Specify the day(s) of the week with the numeric keys.

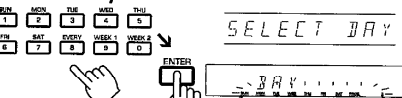

5 Input the ON time with the numeric keys.
6:30 AM: 0 6 3 0

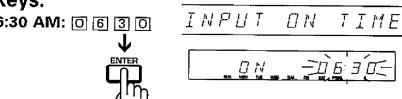

6 Input the OFF time with the numeric keys.
7:00 AM: 0 7 0 0

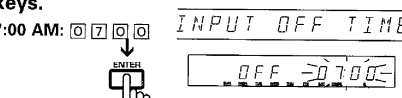

7 Select the PLAY mode.

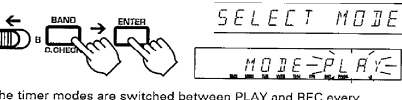

The timer modes are switched between PLAY and REC every time the **[BAND]** key is pressed.

8 Select the TUNER source.



The sources are switched every time the **[BAND]** key is press.

• "LAST" is selected when, for instance, DBS tuner or LD player is being recorded.

9 Select the preset key under which the station to be received has been preset.



• The station must be preset previously.

10 Activate the execution of the program.

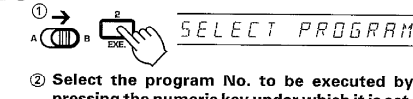

• The selected program No. indicator lights up.

11 Adjust the volume and tone.

12 Switch the power OFF.

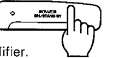

Press the **[POWER]** key of the power amplifier.

To continue the reception of radio station which as been started to be received by timer ON:

- Press the **[CLEAR]** key before the OFF time comes.
- Press the numeric key for the program No. being executed.

• When the program No. indicator goes off, it means that the program will be received continuously.

Notes:

- When a program has previously been set in the program No. selected in step 3, the newly-set program replaces the previous program.
- Do not operate the **[CLEAR]** key or **[POWER]** key while the timer program execution has been activated; otherwise malfunction will occur.

To change the program
During the setting operation



After setting is completed

Repeat the programming procedure from step 2.

■ Timer playback of CD Remote control unit only

1 Switch the power ON.
Press the **[POWER]** key of the power amplifier.



2 Select the program setting mode.

 SELECT PROGRAM
 PNO 1 2 3 4

- The program No. indicators (1 to 4) blink.

3 Select the program No. to be used.
 SUN MON TUE WED THU
 1 2 3 4
 Select from 1 to 4.
 Press within 8 seconds.
 ENTER

- The selected program No. indicator blinks.



4 Specify the day(s) of the week with the numeric keys.
 SUN MON TUE WED THU
 0 1 2 3 4 5 6 7 8 9
 SELECT DAY
 DAY 1 2 3 4 5 6 7 8 9 0

5 Input the ON time with the numeric keys.
 6:30 AM: 0 6 3 0
 INPUT ON TIME
 ON 06:30

6 Input the OFF time with the numeric keys.
 7:00 AM: 0 7 0 0
 INPUT OFF TIME
 OFF 07:00

7 Select the PLAY mode.

 SELECT MODE
 MODE PLAY

The timer modes are switched between PLAY and REC every time the **[BAND]** key is pressed.

8 Select the CD source.

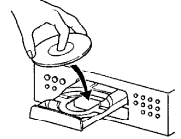
 SELECT SOURCE
 CD
 END
 TUNER → [CD] → TAPE → LAST

The sources are switched every time the **[BAND]** key is press.

9 Place a disc in the CD player.

- With the UD-900M, place the disc on the Plus 1 tray and close the door.
- It is not possible to preset a CD playback programs.

10 Activate the execution of the program.
 ①

 SELECT PROGRAM
 ② Select the program No. to be executed by pressing the numeric key under which it is set.
 SUN MON TUE WED THU
 1 2 3 4
 1 2 3 4
 92.50

- The selected program No. indicator lights up.

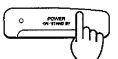
11 Adjust the volume and tone.

12 Switch the power OFF.

 Press the **[POWER]** key of the power amplifier.

Notes:
 1. When a program has previously been set in the program No. selected in step 3, the newly-set program replaces the previous program.
 2. Do not operate the **[CLEAR]** key or **[POWER]** key while the timer program execution has been activated; otherwise malfunction will occur.

To change the program
 During the setting operation

 After setting is completed
 Repeat the programming procedure from step 2.

Be sure to adjust the present time before proceeding the following.

■ Timer playback of tape Remote control unit only

1 Switch the power ON.
Press the **[POWER]** key of the power amplifier.



2 Select the program setting mode.

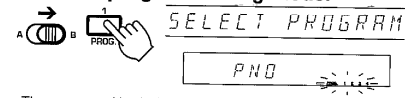

• The program No. indicators (1 to 4) blink.

3 Select the program No. to be used.



Select from 1 to 4.
• The selected program No. indicator blinks.

4 Specify the day(s) of the week with the numeric keys.

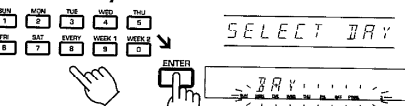

5 Input the ON time with the numeric keys.
6:30 AM: **INPUT ON TIME**



6 Input the OFF time with the numeric keys.
7:00 AM: **INPUT OFF TIME**



7 Select the PLAY mode.

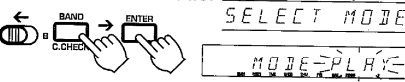

The timer modes are switched between PLAY and REC every time the **[BAND]** key is pressed.

8 Select the TAPE source.

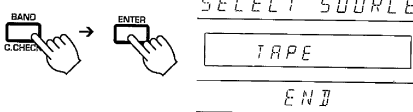

TUNER → CD → **[TAPE]** → LAST

The sources are switched every time the **[BAND]** key is press.

9 Insert a tape and determine the playback condition.

Select the side(s) to be played and the Dolby NR mode.



• Timer playback is possible with either Deck A or Deck B. However, if tapes are placed in decks, playback will begin from Deck B.

10 Activate the execution of the program.

①



② Select the program No. to be executed by pressing the numeric key under which it is set.



• The selected program No. indicator lights up.

11 Adjust the volume and tone.

12 Switch the power OFF.

Press the **[POWER]** key of the power amplifier.

Notes:

- When a program has previously been set in the program No. selected in step 3, the newly-set program replaces the previous program.
- Do not operate the **[CLEAR]** key or **[POWER]** key while the timer program execution has been activated; otherwise malfunction will occur.

To change the program
During the setting operation



After setting is completed

Repeat the programming procedure from step 2.

Be sure to adjust the present time before proceeding the following.

■ Timer recording of radio broadcast Remote control unit only

1 Switch the power ON and receive a station to be recorded.

2 Select the program setting mode.



- The program No. indicators (1 to 4) blink.

3 Select the program No. to be used.



- Select from 1 to 4. Press within 8 seconds.
- The selected program No. indicator blinks.

4 Specify the day(s) of the week with the numeric keys.

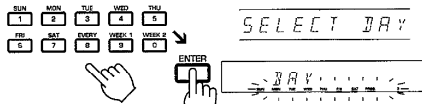

5 Input the ON time with the numeric keys.

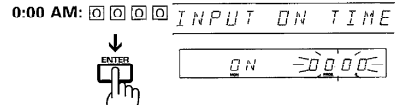

6 Input the OFF time with the numeric keys.

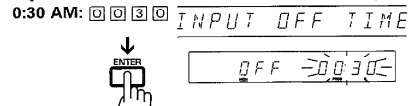

7 Select the REC mode.

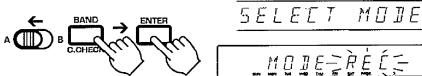

The timer modes are switched between PLAY and REC every time the [BAND] key is pressed.

8 Select the preset key under which the station to be received has been preset.

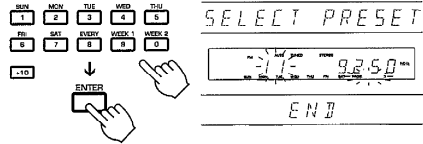

- The station must be preset previously.

9 Set up the cassette deck ready for recording.

- Insert a tape in Deck B.
- Set the tape transport direction.
- Select the side(s) to be recorded onto.
- Select the Dolby NR mode.
- Set the input selector to TUNER.
- Press the CRLS key.

- The auto-bias adjustment cannot be used.

10 Activate the execution of the program.

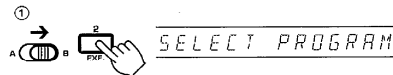

- Select the program No. to be executed by pressing the numeric key under which it is set.

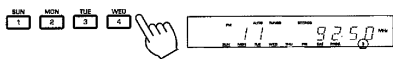

- The selected program No. indicator lights up.

11 Switch the power OFF.

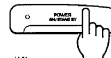

Press the [POWER] key of the power amplifier.

Notes:

- When a program has previously been set in the program No. selected in step 3, the newly-set program replaces the previous program.
- When the power is turned ON by the timer, the volume level is automatically set to the lowest level.
- Do not operate the [CLEAR] key or [POWER] key while the timer program execution has been activated, otherwise malfunction will occur.

To change the program

During the setting operation



After setting is completed

Repeat the programming procedure from step 2.

Be sure to adjust the present time before proceeding the following.

■ To check timer program contents

Remote control unit only

1 Press the PROG. key.



2 Press the numeric key corresponding to the program to be checked.



- If no program is selected while the program No. indicators are blinking, the previous display condition resumes.
- When a program is selected, its contents will be displayed for about 3 seconds, and the previous display resumes after it.

■ To cancel timer program execution

Remote control unit only

1 Press the CLEAR key.



2 Press the numeric key corresponding to the program the execution of which is to be cleared.

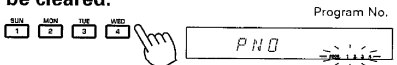

Select the number with a numeric key.

- The program contents are not cleared even when its execution is canceled.

Re-activation of timer execution after canceling it

Since the program itself is retained in memory, check its contents and perform the operation from the step "Activate the execution of the program" as follows.

- ① Press EXE. key.
- ② Select the program No. to be executed by pressing the numeric key under which it is set.
- ③ Adjust the volume and tone in case of timer reception of broadcast or timer playback of CD or tape.
- ④ Switch the power OFF.

■ Operation of one-touch timer

Press the O.T.T. key allows to switch power ON after a specified time period, set in the unit of 30 minutes, from the moment it is activated.

1 Set the timer ON time.

Press the O.T.T. key.

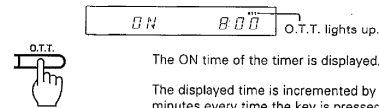

The displayed time is incremented by 30 minutes every time the key is pressed.

- When the key is pressed once, a time that can be divided by 30 minutes and within 30 minutes from the present time is displayed as the ON time. (Example: When pressed at 7:40, "8:00" will be displayed.)
- The ON time is incremented in 30-minute steps, for example from 0:00 to 0:30, 1:00, 1:30, and so on.
- The ON time can be set up to 12 hours later.
- The one-touch timer can be set even when the power is OFF.

2 Select a program source and adjust the volume.

Select CD, TUNER or TAPE.

3 Switch the power OFF.

Press the POWER key of the power amplifier.

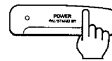

- The ON time can be checked by pressing the [O.T.T.] key once.
- When the power is switched ON, the sleep timer will automatically be set to 60 minutes.
- When the power is switched ON, the selected source (CD, TAPE, TUNER) will be played.

To cancel one-touch timer activated

Switch the power ON,

or

Press the O.T.T. key until the O.T.T. indicator goes off.

Notes:

1. If disc is not present while the CD input is selected or cassette tape is not present while the TAPE input is selected, the last broadcasting station received will be received again.
2. If the [ADJUST] key is pressed to set the clock, the one-touch timer is released.

Operation of timer

After setting the timer, one of the following operations can be added by pressing the AI TIMER keys. The AI TIMER 1 and AI TIMER 2 do not function in the timer recording mode.

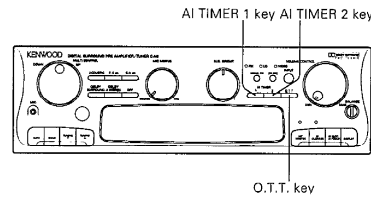

■ Operation of AI TIMER 1

With this function, when the power is switched ON by the program timer, the volume increases in three steps.

1 Complete the program timer setting.

Switch the power of the power amplifier OFF.

2 Press the AI TIMER 1 key.

The AI TIMER 1 indicator lights up.

Select the maximum volume.



- The maximum volume setting varies every time the key is pressed. When the key is released, the indicator goes out and the maximum volume setting set at that moment is stored in memory.

To cancel the execution of AI TIMER 1

Press the AI TIMER 1 key to select OFF.

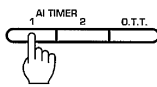

- The AI TIMER 1 indicator goes off.

Reference for volume selection

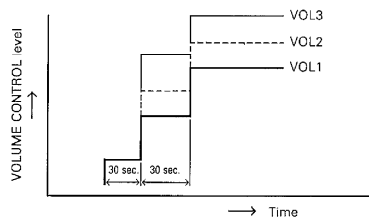

- The VOLUME CONTROL rotates as the volume changes.
- The graphic equalizer curve also varies accordingly.

■ Operation of AI TIMER 2

With this function, when the power is switched ON by the program timer, two tracks on the CD is played first, then the broadcast from the tuner is received automatically. This function is given the highest priority over other program timer functions.

1 Place a disc in the CD player.

- With the UD-900M, place the disc on the Plus 1 tray and close the door.

2 Perform operations of "Timer reception of radio broadcast".

- Refer to page 71.

3 Press the AI TIMER 2 key.

The AI TIMER 2 indicator lights up.



- Also press the AI TIMER 1 key if you want to increase the volume in three steps.

To cancel AI TIMER 2

Press the key again.

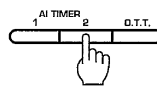

- The AI TIMER 2 indicator goes off.

Notes:

1. When the operation keys of the graphic equalizer or the [VOLUME CONTROL] key on the remote control unit is pressed while the AI TIMER 1 function is carried out, the volume is fixed at the level being set.
2. If the TUNER or TAPE input selector key is selected during the CD playback of AI TIMER 2, the CD playback stops there and the AI TIMER 2 function is canceled.
3. If the operation keys of the CD player is pressed during the CD playback of AI TIMER 2, the CD playback stops there and the AI TIMER 2 function is canceled.
4. If the CD has not been inserted, reception of radio broadcast starts at the moment AI TIMER 2 is activated.
5. Even when the program timer operation has completed, the AI TIMER 1 and 2 indicators do not go off. Be sure to turn off the indicators when the AI TIMER 1 and / or 2 is not required any more.

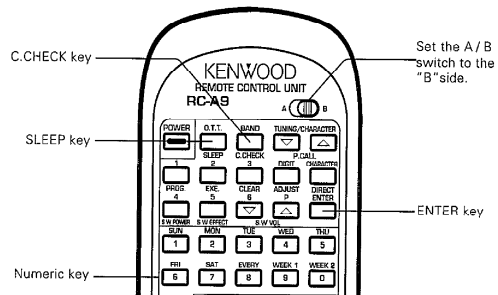

■ Operation of sleep timer

The sleep timer allows to turn the system power off after the specified period has elapsed. This function may be most convenient when you like to fall in sleep while listening to music.

The period can be set up to 90 minutes in 10-minute steps.

The sleep timer is applied in priority over other timer programs.

Remote control unit only

1 Switch the power ON.

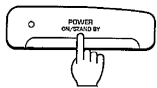

Press the **POWER** key of the power amplifier.

2 Specify the period after which the power is to be switched OFF.

Press the **SLEEP** key.

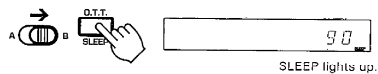

SLEEP lights up.

→ 90 → 80 → 70 → → 20 → 10 → Canceled

- Each press decreases the period by 10 minutes.

To cancel sleep timer:

Press the **SLEEP** key until the sleep timer is canceled,
or
Switch the power **OFF**.



■ Operation of calendar check

The calendar check allows to display the day of the week of the specified date input by the user in the order of year, month and day. This function covers the range from January 1, 1900 to December 31, 2099.

Remote control unit only

1 Press the C.CHECK key.

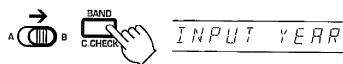

2 Input the year with the numeric keys.

Year 1992: [1] [9] [9] [2]

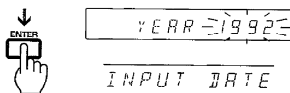

3 Input the month then the day with the numeric keys.

March 30: [0] [3] [3] [0]

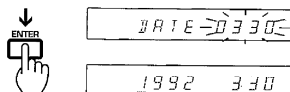

Day of the week.

- The day-of-the-week indicator of the date input above lights up. The previous display resumes in a few seconds.

In case of difficulty

What appears to be a malfunction may not always be serious. If your unit should not perform as expected, consult the table below to see if the problem can be corrected before seeking help from your dealer or service representative.

Remote control unit

Symptom	Cause	Remedy
Remote control operation is not possible.	<ul style="list-style-type: none"> Batteries are exhausted. The parallel cord is not connected properly. The remote control unit is too far away from the main system, controlling angle is too large, or there is an obstacle in between. The source component to be operated does not contain the tape(s) or CD. An attempt is made to play a tape which is being recorded in the cassette deck. 	<ul style="list-style-type: none"> Replace with new batteries. Connect properly referring to "System connections". Operate the remote control unit within the controllable range. Place the tape(s) or CD in the source component to be played. Wait until the recording is completed.

Preamplifier / tuner unit, power amplifier unit, speakers

Symptom	Cause	Remedy
Sound is not output.	<ul style="list-style-type: none"> The speaker cords are disconnected. The volume is set to minimum position. The [MUTE] key of the remote control unit is set to ON and the point indicator is blinking. The parallel cord is not connected properly. The headphones plug is left inserted in the PHONES jack. 	<ul style="list-style-type: none"> Connect properly referring to "System connections". Adjust the volume to a proper level. Press the [MUTE] key to OFF. Connect properly referring to "System connections". Remove the plug.
No sound is heard from the headphones.	<ul style="list-style-type: none"> The system is set to the NON DIRECTION 1 acoustic mode. 	<ul style="list-style-type: none"> Set to a mode other than NON DIRECTION 1.
The stand by indicator blinks and no sound is heard.	<ul style="list-style-type: none"> Speaker cords are short-circuited. 	<ul style="list-style-type: none"> Turn the power off, eliminate the short-circuiting, then turn on the power again.
Sound is not output from one of the speakers.	<ul style="list-style-type: none"> The speaker cord is disconnected. The BALANCE control is set to an extreme position. 	<ul style="list-style-type: none"> Connect properly referring to "System connection". Adjust the Left / Right balance.
Sound is not output from the Surround rear speaker and / or center speaker, or their sound is very small.	<ul style="list-style-type: none"> The rear-speaker cords and / or center speaker cord are disconnected. The Surround play mode has not been engaged. The REAR VOL. and / or CENTER VOL. controls are set to the minimum level. 	<ul style="list-style-type: none"> Connect properly referring to "System connections" Set the Dolby Surround or DSP presence mode. Adjust the REAR VOL. and CENTER VOL. controls.
The clock display is blinking without changing from a certain time.	<ul style="list-style-type: none"> There was a power failure. The power cord was unplugged. 	<ul style="list-style-type: none"> Set the current time again. Set the current time again.
The timer does not work.	<ul style="list-style-type: none"> The current time is not set, or there was a power failure. The timer ON time and OFF time have not been set. The timer execution has not been specified. 	<ul style="list-style-type: none"> Set the current time referring to "Time adjustment". Set the timer ON time and OFF time. Specify execution by pressing the [EXE] key.
Radio stations cannot be received.	<ul style="list-style-type: none"> No antenna is connected. The broadcast band is not set properly. The frequency of the desired station is not tuned. 	<ul style="list-style-type: none"> Connect an antenna. Set the broadcast band properly. Tune the frequency of the desired station.

Symptom	Cause	Remedy
A station which was preset cannot be received by pressing the corresponding numeric key.	<ul style="list-style-type: none"> The preset station belongs to a frequency that cannot be received. The preset memory was cleared because the power cord had been unplugged for a long period of time. 	<ul style="list-style-type: none"> Preset a station with a receivable frequency. Preset the station again.
Interference.	<ul style="list-style-type: none"> Noise due to ignition noise of an automobile. Noise due to an influence from an electric appliance. Noise due to a nearby TV set. 	<ul style="list-style-type: none"> Install the outdoor antenna apart from the road. Turn off the power of the appliance. Install the system more apart from the TV set.

Cassette decks

Symptom	Cause	Remedy
Sounds is not produced when the Play key is pressed.	<ul style="list-style-type: none"> The parallel cord is not connected properly. The head is dirty. Tape is irregularly wound and hard to take up. A non-recorded tape is being played. 	<ul style="list-style-type: none"> Connect properly referring to "System connections". Clean the head referring to "Cleaning the head section". Replace the tape. Play a recorded tape.
The deck does not work when an operation key is pressed.	<ul style="list-style-type: none"> The cassette holder is not closed completely. The operation key was pressed immediately after closing the cassette holder. The operation key was pressed within less than 3 seconds after the power was turned on. Tape is not inserted. Tape is irregularly wound and hard to take up. Tape has been fully wound to reel. 	<ul style="list-style-type: none"> Close the cassette holder completely. Press the desired operation key in a few seconds after closing the cassette holder. Press the desired operation key in more than 3 seconds after turning the power on. Insert a tape. Replace the tape. Change the tape transport direction or insert the tape inversely.
DPSS malfunctions.	<ul style="list-style-type: none"> The tape is not suitable for DPSS operation, for example the spaces between tunes are too short. 	<ul style="list-style-type: none"> Read "DPSS operation".
CCRS does not work.	<ul style="list-style-type: none"> A recordable tape is not inserted in Deck B. A disc is not placed in the CD player. The disc is dirty. 	<ul style="list-style-type: none"> Insert a recordable tape in Deck B and press the [CCRS] key. Place a disc in the CD player and press the [CCRS] key. Clean the disc, place it in the CD player, and press the [CCRS] key.
The dubbing on Deck A and Deck B ends at different timing.	<ul style="list-style-type: none"> This is due to the difference in tape length or to the characteristics of the cassette deck mechanisms. 	<ul style="list-style-type: none"> A small time difference is not regarded as a failure.
The cassette holder does not open when the Eject key is pressed.	<ul style="list-style-type: none"> The key is pressed during recording or playback. 	<ul style="list-style-type: none"> Press in the Stop mode.
Sound is hoarse, or high frequencies are not audible.	<ul style="list-style-type: none"> The head is dirty. The tape is stretched or wrinkled. 	<ul style="list-style-type: none"> Clean the head referring to "Cleaning the head section". Replace the tape.
Sound is distorted.	<ul style="list-style-type: none"> The recording level has not been set by the [CRLS] key. A tape recorded with distorted sound is being played. 	<ul style="list-style-type: none"> Adjust the recording level referring to "Recording operation on cassette deck". Replace the tape.

In case of difficulty

Symptom	Cause	Remedy
Recording is not initiated when the Recording key is pressed.	<ul style="list-style-type: none"> The protection tab on the cassette has been broken. The cassette holder is not closed completely. The TAPE input selector is selected on the preamplifier / tuner. Tape has been fully wound to a reel. 	<ul style="list-style-type: none"> Use a cassette with unbroken tab or close the hole. Close the cassette holder completely. Press the input select key of the source to be recorded. Change the tape transport direction of Deck B or insert the tape inversely.
Noise level is high.	<ul style="list-style-type: none"> The head is magnetized. External noise is induced. A tape recorded with Dolby NR ON is being played with Dolby NR OFF. 	<ul style="list-style-type: none"> Demagnetize the head referring to "Cleaning the head section". Install the system apart from other electrical appliances and TV set. The [DOLBY NR] selector switch to B or C.
Sound is vibrating.	<ul style="list-style-type: none"> The capstans or pinch rollers are dirty. Tape is irregularly wound. 	<ul style="list-style-type: none"> Clean the head referring to "Cleaning the head section". Wind the tape regularly by fast forwarding, rewinding or playing it fully from one reel to another.

CD player

Symptom	Cause	Remedy
Disc is loaded, player does not play.	<ul style="list-style-type: none"> Disc is loaded upside down. Disc is loose. Disc is dirty. Disc is cracked. Condensation occurred on the optical lens unit. 	<ul style="list-style-type: none"> Load the disc again with its label side up. Insert the disc properly. Wipe off the dust on the surface of the disc referring to "Disc handling precautions". Replace the disc with a new one. Remove condensed dew by referring to "Beware of condensation".
No sound.	<ul style="list-style-type: none"> Disc is not loaded. Play mode is not entered (The play / pause indicator is not lit.) Disc is too dirty. Disc is cracked. The parallel cord is not connected properly. 	<ul style="list-style-type: none"> Load a disc. Press the [▶/II] key. Wipe off the dust on the disc surface referring to "Disc handling precautions". Replace the disc with a new one. Connect properly referring to "System connection".
Music is Interrupted. (Sound is skipped.)	<ul style="list-style-type: none"> Disc is too dirty. Disc is cracked. Oscillation is applied to this unit. 	<ul style="list-style-type: none"> Wipe off the dust on the disc surface referring to "Disc handling precautions". Replace the disc with a new one. Try selecting a place where no strong vibrations occur by changing the installation place, etc.

Notes:

- With some tapes, a squeaky noise is produced when the tape is stopped automatically. This is due to the tape protection function, and not a malfunction.
- Do not use 120-minute tapes, for the tape is too thin and gets easily tangled.
- This system is microprocessor-controlled, so malfunction may occur due to external noise or interference noise. In such a case, unplug the power cord, plug it and turn power on again.
- Do not use contact cleaners because it could cause a malfunction. Be specially careful against contact cleaners containing oil, for they may deform the plastic components.

Specifications (For U.K. and Europe)

Pre Amplifier / Tuner unit (C-A9L)

FM Tuner section

Tuning frequency range	87.5 MHz ~ 108 MHz
Sensitivity (DIN at 75 Ω)	
MONO	0.7 μV / 8.2 dBf
Total harmonic distortion (DIN at 1 kHz, 65.2 dBf input)	
MONO	0.4 %
STEREO	0.5 %
Signal to noise ratio (DIN weighted at 1 kHz, 65.2 dBf input)	
MONO	70 dB
STEREO	64 dB
Selectivity (DIN ± 300 kHz)	60 dB
Stereo separation (DIN at 1 kHz)	40 dB
Frequency response	30 Hz ~ 15 kHz + 0.5 dB, - 3 dB

MW Tuner section

Tuning frequency range	531 kHz ~ 1,602 kHz
Usable sensitivity	10 μV / (500 μV / m)
Signal to noise ratio	48 dB

LW Tuner section

Tuning frequency range	153 kHz ~ 279 kHz
Usable sensitivity	22 μV
Signal to noise ratio	45 dB

Pre Amplifier section

Rated output voltage (PRE OUT)	1.0 V (40 Hz ~ 20 kHz, 0.02 %)
Total harmonic distortion	0.02 % (40 Hz ~ 20 kHz)
	0.01 % (1 kHz)
Signal to noise ratio	90 dB (IHF'66) / 85 dB (IHF'78)
Input sensitivity / Impedance	
MD / DAT, LD / AUX, VIDEO	200 mV / 47 kΩ
MIC	1.2 mV / 47 kΩ
Loudness control	
VOLUME at -30 dB level	+ 6 dB (100 Hz)
N.B. circuit (-30 dB Volume level)	+ 12 dB (at 60 Hz)
Output level / Impedance	
MD / DAT, VIDEO	200 mV / 2.2 kΩ
Graphic equalizer	
Individual channel	60 Hz, 150 Hz, 400 Hz, 1 kHz, 2.5 kHz, 6 kHz, 15 kHz

Note:

KENWOOD follows a policy of continuous advancements in development. For this reason specifications may be changed without notice.

Strömbrytarens POWER beredskapsläge

Indikatorn STAND BY tänds efter nätkabelns anslutning till ett vägguttag, oavsett strömbrytarens POWER tillfrånslag. Detta anger att en liten mängd ström leds till komponenten som stöd för minnesinnehållet.

Detta läge kallas för beredskapsläget. Strömbrytaren på fjärrkontrollen kan användas för att slå på och av strömmen så länge indikatorn STAND BY lyser.

Virtanäppäimen (POWER) valmiustila (STAND BY)

Kun laitteen verkkojohto on liitetty pistorasiaan, valmiustilan merkivalo syttyy riippumatta virtanäppäimen (POWER) asennosta (ON / OFF). Merkivalo osoittaa, että laitteessa on hieman virtaa muistin sisältöjen ylläpitoa varten. Tätä tilaa kutsutaan valmiustilaksi. Kun valmiustilan merkivalo (STAND BY) palaa, laitteen virta voidaan kytkeä ja katkaista kaukosäätimellä.

VIDEO section

Input level / Impedance	
VIDEO (composite)	1 Vp-p / 75 Ω
Input (LD / AUX, VIDEO IN)	
Output level / Impedance	
VIDEO (composite)	1 Vp-p / 75 Ω
Output (MONITOR OUT, VIDEO OUT)	

[General]

Dimensions	W: 270 mm (10-5 / 8")
	H: 85 mm (3-3 / 8")
	D: 318 mm (12-1 / 2")
Weight (net)	3.1 kg (6.8 lb)

Power Amplifier unit (B-A9)

Rated power output

(IEC / NF)	
From 63 Hz to 12,500 Hz, 0.7 % T.H.D.	
	37 W + 37 W (at 4 Ω)

(DIN)

1 kHz at 4 Ω	40 W + 40 W
Presence	
1 kHz at 8 Ω	20 W + 20 W

Total harmonic distortion

	0.06 % (40 Hz ~ 20 kHz, 35 W, 4 Ω)
	0.005 % (1 kHz, 1 / 2 Rated power, 4 Ω)

Frequency response

	40 Hz ~ 70 kHz, + 0 dB, - 1.5 dB
--	----------------------------------

Signal to noise ratio

	105 dB (IHF'66) / 90 dB (IHF'78)
--	----------------------------------

[General]

Power consumption	170 W
Dimensions	W: 270 mm (10-5 / 8")
	H: 120 mm (4-3 / 4")
	D: 317 mm (12-1/2")
Weight (net)	6.4 kg (14.1 lb)

Afbrydertastens (POWER) STAND BY funktion

När apparatets strömledning er tilsluttet en stikkontakt, lyser STAND BY indikatoren, uanset om der er tændt ved afbryderen på apparatet eller ej. Det angiver, at apparatet bliver forsynet med en ganske lille mængde strøm til opret-holdelse af hukommelsens indhold.

Denne funktion kaldes STAND BY. Når STAND BY indikatoren er tændt, kan strømmen til apparatet slås til og fra mod fjernsty-ringsenheden.

PÅ/AV-knappens Stand-by funksjon

Når strömledningen til dette anlegget er satt i en vekselsströmkontakt, vil STAND-BY indikatorlampen lyse enten PÅ/AV-knappen er på- eller avslått. Dette betyr at en viss mengde strøm tilføres anlegget slik at innholdet i minnet ikke går tapt.

Denne funksjonen kalles Stand-by. Når indikatorlampen for STAND-BY er tent, kan strømmen slås PÅ / AV fra fjernkontrollen.

Specifications (For U.S.A. and Canada)

Pre Amplifier / Tuner unit (C-A9)

FM Tuner section

Tuning frequency range 87.5 MHz ~ 108 MHz
Sensitivity (IHF) 12.8 dBf (1.2 μ V at 75 Ω)
Total harmonic distortion at 1 kHz
MONO 0.5 %
STEREO 0.6 %
Signal to noise ratio at 1 kHz
MONO 80 dB (85 dBf input)
STEREO 74 dB (85 dBf input)
Selectivity (IHF \pm 400 kHz) 50 dB
Stereo separation (IHF at 1 kHz) 40 dB
Frequency response... 30 Hz ~ 15 kHz + 0.5 dB, - 3 dB

AM Tuner section

Tuning frequency range 530 kHz ~ 1,700 kHz
Usable sensitivity 10 μ V / (500 μ V / m)
Signal to noise ratio 48 dB

Pre Amplifier section

Rated output voltage (PRE OUT)
..... 1.0 V (40 Hz ~ 20 kHz, 0.02 %)
Total harmonic distortion
..... 0.02 % (40 Hz ~ 20 kHz)
..... 0.01 % (1 kHz)
Signal to noise ratio ... 90 dB (IHF'66) / 85 dB (IHF'78)
Input sensitivity / Impedance
MD / DAT, LD / AUX, VIDEO 200 mV / 47 k Ω
MIC 1.2 mV / 47 k Ω
Loudness control
VOLUME at - 30 dB level + 6 dB (100 Hz)
N.B. circuit (- 30 dB Volume level) + 12 dB
(at 60 Hz)
Output level / Impedance
MD / DAT, VIDEO 200 mV / 2.2 k Ω
Graphic equalizer
Individual channel 60 Hz, 150 Hz, 400 Hz,
1 kHz, 2.5 kHz, 6 kHz, 15 kHz

VIDEO section

Input level / Impedance
VIDEO (composite) 1 Vp-p / 75 Ω
Input (LD / AUX, VIDEO IN)
Output level / Impedance
VIDEO (composite) 1 Vp-p / 75 Ω
Output (MONITOR OUT, VIDEO OUT)
[General]
Dimensions W: 270 mm (10-5 / 8")
H: 85 mm (3-3 / 8")
D: 318 mm (12-1 / 2")
Weight (net) 3.1 kg (6.8 lb)

Power Amplifier unit (B-A9)

Rated power output

35 watts per channel minimum RMS, both channels driven, at 4 Ω from 40 Hz to 20 kHz with no more than 0.06 % total harmonic distortion

Presence 1 kHz at 8 Ω 20 W + 20 W
Total harmonic distortion
..... 0.06 % (40 Hz ~ 20 kHz, 35 W, 4 Ω)
..... 0.005 % (1 kHz, 1 / 2 Rated power, 4 Ω)
Frequency response
..... 40 Hz ~ 70 kHz, + 0 dB, - 1.5 dB
Signal to noise ratio
..... 105 dB (IHF'66) / 90 dB (IHF'78)

[General]

Power consumption 170 W
Dimensions W: 270 mm (10-5 / 8")
H: 120 mm (4-3 / 4")
D: 317 mm (12-1 / 2")
Weight (net) 6.4 kg (14.1 lb)

Note:

KENWOOD follows a policy of continuous advancements in development. For this reason specifications may be changed without notice.

For the U.S.A.

FCC WARNING

This equipment may generate or use radio frequency energy. Changes or modifications to this equipment may cause harmful interference unless the modifications are expressly approved in the instruction manual. The user could lose the authority to operate this equipment if an unauthorized change or modification is made.

NOTE:

This equipment has been tested and found to comply with the limits for a Class B digital device, pursuant to Part 15 of the FCC Rules. These limits are designed to provide reasonable protection against harmful interference in a residential installation. This equipment may cause harmful interference to radio communications, if it is not installed and used in accordance with the instructions. However, there is no guarantee that interference will not occur in a particular installation. If this equipment does cause harmful interference to radio or television reception, which can be determined by turning the equipment off and on, the user is encouraged to try to correct the interference by one or more of the following measures:

- Reorient or relocate the receiving antenna.
- Increase the separation between the equipment and receiver.
- Connect the equipment into an outlet on a circuit different from that to which the receiver is connected.
- Consult the dealer or an experienced radio / TV technician for help.

Specifications (For other countries)

Pre Amplifier / Tuner unit (C-A9)

FM Tuner section

Tuning frequency range	87.5 MHz ~ 108 MHz
Sensitivity (IHF)	12.8 dBf (1.2 μ V at 75 Ω)
Total harmonic distortion at 1 kHz	
MONO	0.5 %
STEREO	0.6 %
Signal to noise ratio at 1 kHz	
MONO	80 dB (85 dBf input)
STEREO	74 dB (85 dBf input)
Selectivity (IHF \pm 400 kHz)	50 dB
Stereo separation (IHF at 1 kHz)	40 dB
Frequency response	30 Hz ~ 15 kHz + 0.5 dB, -3 dB

AM Tuner section

Tuning frequency range	
9 kHz step	531 kHz ~ 1,602 kHz
10 kHz step	530 kHz ~ 1,610 kHz
Usable sensitivity	10 μ V / (500 μ V / m)
Signal to noise ratio	48 dB

Pre Amplifier section

Rated output voltage (PRE OUT)	1.0 V (40 Hz ~ 20 kHz, 0.02 %)
Total harmonic distortion	
(40 Hz ~ 20 kHz)	0.02 %
(1 kHz)	0.01 %
Signal to noise ratio	90 dB (IHF'66) / 85 dB (IHF'78)
Input sensitivity / Impedance	
MD / DAT, LD / AUX, VIDEO	200 mV / 47 k Ω
MIC	1.2 mV / 47 k Ω
Loudness control	
VOLUME at -30 dB level	+ 6 dB (100 Hz)
N.B. circuit (-30 dB Volume level)	+ 12 dB (at 60 Hz)
Output level / Impedance	
MD / DAT, VIDEO	200 mV / 2.2 k Ω
Graphic equalizer	
Individual channel	60 Hz, 150 Hz, 400 Hz, 1 kHz, 2.5 kHz, 6 kHz, 15 kHz

VIDEO section

Input level / Impedance	
VIDEO (composite)	1 Vp-p / 75 Ω
Input (LD / AUX, VIDEO IN)	
Output level / Impedance	
VIDEO (composite)	1 Vp-p / 75 Ω
Output (MONITOR OUT, VIDEO OUT)	

[General]

Dimensions	W: 270 mm (10-5 / 8")
	H: 85 mm (3-3 / 8")
	D: 318 mm (12-1 / 2")
Weight (net)	3.1 kg (6.8 lb)

Note:

KENWOOD follows a policy of continuous advancements in development. For this reason specifications may be changed without notice.

Power Amplifier unit (B-A9)

Rated power output

(EIAJ 4 Ω)	50 W + 50 W
(IHF'66)	
From 40 Hz to 20 kHz, 0.06 % T.H.D.	
at 4 Ω	35 W + 35 W
(IEC / NF)	
From 63 Hz to 12,500 Hz, 0.7 % T.H.D.	
(at 4 Ω)	37 W + 37 W
Presence 1 kHz at 8 Ω	30 W + 30 W (EIAJ)
Total harmonic distortion	
(40 Hz ~ 20 kHz, 35 W, 4 Ω)	0.06 %
(1 kHz, 1 / 2 Rated power, 4 Ω)	0.005 %
Frequency response	40 Hz ~ 70 kHz, + 0 dB, - 1.5 dB
Signal to noise ratio	105 dB (IHF'66) / 90 dB (IHF'78)
[General]	
Power consumption	170 W
Dimensions	W: 270 mm (10-5 / 8")
	H: 120 mm (4-3 / 4")
	D: 317 mm (12-1/2")
Weight (net)	6.4 kg (14.1 lb)

For the U.S.A.

Note to CATV system installer:

This reminder is provided to call the CATV system installer's attention to Article 820-40 of the NEC that provides guidelines for proper grounding and, in particular, specifies that the cable ground shall be connected to the grounding system of the building, as close to the point of cable entry as practical.

Specifications

Cassette deck unit (X-A9)

Track 4-track, 2-channel stereo
Recording system AC bias system
(Frequency: 105 kHz)

Heads

A deck Playback head 1
B deck Playback / recording head 1
Erasing head 1

Motors

A deck 1
B deck 1

Fast winding time Approx. 110 seconds
(C-60 tape)

Frequency response

Normal tape 35 Hz to 17,000 Hz, ± 3 dB
CrO₂ tape 35 Hz to 18,000 Hz, ± 3 dB
Metal tape 35 Hz to 18,000 Hz, ± 3 dB

Signal to noise ratio

Dolby C NR ON 74 dB (Metal tape)
Dolby B NR ON 66 dB (Metal tape)
Dolby NR OFF 58 dB (Metal tape)

Harmonic distortion Less than 0.9 %
(at 1 kHz, 3rd H.D. Metal tape)

Wow and flutter 0.09 % (W.R.M.S.)
 ± 0.19 % (DIN)

[General]

Dimensions W: 270 mm (10-5 / 8")
H: 120 mm (4-3 / 4")
D: 259 mm (10-3 / 16")

Weight (net) 2.7 kg (5.9 lb)

CD player unit (DP-A9)

Laser Semiconductor laser
Playing rotation 200 rpm ~ 500 rpm (CLV)
Frequency response 20 Hz ~ 20 kHz, + 0 dB, - 1.5 dB
Signal to noise ratio More than 93 dB
Total harmonic distortion

..... Less than 0.01 % (at 1 kHz)

Channel separation More than 85 dB (at 1 kHz)

Wow & Flutter Unmeasurable Limit

[General]

Dimensions W: 270 mm (10-5 / 8")
H: 85 mm (3-3 / 8")
D: 259 mm (10-3 / 16")

Weight (net) 2.0 kg (4.4 lb)

CD player unit (DP-MA9)

Laser Semiconductor laser
Playing rotation 200 rpm ~ 500 rpm (CLV)
Frequency response 20 Hz ~ 20 kHz, ± 1 dB
Signal to noise ratio More than 93 dB
Total harmonic distortion

..... Less than 0.01 % (at 1 kHz)

Channel separation More than 85 dB (at 1 kHz)

Wow & Flutter Unmeasurable Limit

[General]

Dimensions W: 270 mm (10-5 / 8")
H: 85 mm (3-3 / 8")
D: 310 mm (12-3 / 16")

Weight (net) 3.2 kg (7.0 lb)

Speakers (LS-A9)

Enclosure Bass-reflex type

Speaker configuration 3-Way system

Woofers 150 mm, cone type

Midrange 80 mm, cone type

Tweeter 25 mm, dome type

Presence speaker 120 mm, cone type

Impedance

MAIN INPUT 4 Ω

NON-DIRECTION INPUT 8 Ω

Maximum input level

MAIN INPUT 70 W

NON-DIRECTION INPUT 45 W

Frequency response

MAIN INPUT 43 Hz ~ 20,000 Hz

NON-DIRECTION INPUT 100 Hz ~ 17,000 Hz

[General]

Dimensions W: 205 mm (8-1 / 16")

H: 436 mm (17-3 / 16")

D: 285 mm (11-1 / 4")

Weight (net) 7.2 kg (15.9 lb) (1 piece)

Note:
KENWOOD follows a policy of continuous advancements in development. For this reason specifications may be changed without notice.

Free Manuals Download Website

<http://myh66.com>

<http://usermanuals.us>

<http://www.somanuals.com>

<http://www.4manuals.cc>

<http://www.manual-lib.com>

<http://www.404manual.com>

<http://www.luxmanual.com>

<http://aubethermostatmanual.com>

Golf course search by state

<http://golfingnear.com>

Email search by domain

<http://emailbydomain.com>

Auto manuals search

<http://auto.somanuals.com>

TV manuals search

<http://tv.somanuals.com>