

# KENWOOD

AUDIO VIDEO SURROUND RECEIVER

## VR-8060

---

## INSTRUCTION MANUAL

KENWOOD CORPORATION

***About the supplied remote control***

Compared to standard remote controls, the remote control supplied with this receiver has several operation modes. These modes enable the remote control to control other audio/video components. In order to effectively use the remote control it is important to read the operating instructions and obtain a proper understanding of the remote control and how to switch its operation modes (etc.).

Using the remote control without completely understanding its design and how to switch the operation modes may result in incorrect operations.

***For the U.S.A.***

### **Register Online**

**Register your Kenwood Home Audio  
product at [www.kenwoodusa.com](http://www.kenwoodusa.com)**

**Plus opt in to receive e-mail updates and other offers  
when you register at our web site.**

# Before applying the power

 **Caution : Read this page carefully to ensure safe operation.**

Units are designed for operation as follows.

**U.S.A. and Canada** ..... **AC 120 V only**  
**Australia** ..... **AC 240 V only**  
**Europe and U.K** ..... **AC 230 V only**  
**China and Russia** ..... **AC 220 V only**  
**Other countries** ..... **AC 110-120 / 220-240 V switchable**

## Maintenance of the unit

When the front panel or case becomes dirty, wipe with a soft, dry cloth. Do not use thinner, benzine, alcohol, etc. for these agents may cause discoloration.

## In regard to contact cleaner

Do not use contact cleaners because it could cause a malfunction. Be specially careful not to use contact cleaners containing oil, for they may deform the plastic component.

## Safety precautions

### WARNING :

TO PREVENT FIRE OR ELECTRIC SHOCK,  
DO NOT EXPOSE THIS APPLIANCE TO  
RAIN OR MOISTURE.



**CAUTION**  
RISK OF ELECTRIC SHOCK  
DO NOT OPEN



CAUTION: TO REDUCE THE RISK OF ELECTRIC SHOCK, DO NOT REMOVE COVER (OR BACK). NO USER-SERVICEABLE PARTS INSIDE. REFER SERVICING TO QUALIFIED SERVICE PERSONNEL.



THE LIGHTNING FLASH WITH ARROWHEAD SYMBOL, WITHIN AN EQUILATERAL TRIANGLE, IS INTENDED TO ALERT THE USER TO THE PRESENCE OF UNINSULATED "DANGEROUS VOLTAGE" WITHIN THE PRODUCT'S ENCLOSURE THAT MAY BE OF SUFFICIENT MAGNITUDE TO CONSTITUTE A RISK OF ELECTRIC SHOCK TO PERSONS.



THE EXCLAMATION POINT WITHIN AN EQUILATERAL TRIANGLE IS INTENDED TO ALERT THE USER TO THE PRESENCE OF IMPORTANT OPERATING AND MAINTENANCE (SERVICING) INSTRUCTIONS IN THE LITERATURE ACCOMPANYING THE APPLIANCE.

## How to use this manual

This manual is divided into four sections, Preparations, Operations, Remote Control, and Additional Information.

### Preparations

Shows you how to connect your audio and video components to the receiver and prepare the surround processor.

Since this receiver works with all your audio and video components, we will guide you in setting up your system to be as easy as possible.

### Operations

Shows you how to operate the various functions available on the receiver.

### Remote Control



Shows you how to operate other components using the remote control, as well as a detailed explanation of all remote control operations. Once you have registered your components with the proper setup codes, you'll be able to operate both this receiver and your other AV components (TV, VCR, DVD player, CD player, etc.) using the remote control supplied with this receiver.

### Additional Information

Shows you additional information such as "In case of difficulty" (trouble-shooting) and "Specifications".

## Contents

**Caution :** Read the pages marked  carefully to ensure safe operation.

	<b>Before applying the power</b> .....	<b>2</b>
	Safety precautions .....	2
	How to use this manual .....	2
	Unpacking .....	3
	Preparing the remote control .....	4
	Special features .....	5
	<b>Names and functions of parts</b> .....	<b>6</b>
	Main Unit .....	6
	Remote control unit .....	7

## Unpacking

Unpack the unit carefully and make sure that all accessories are present.

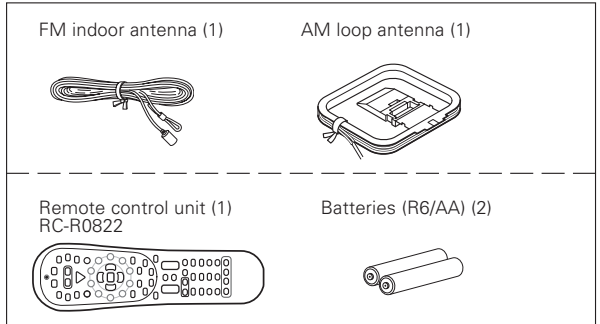

If any accessories are missing, or if the unit is damaged or fails to operate, notify your dealer immediately. If the unit was shipped to you directly, notify your shipper immediately. Kenwood recommends that you retain the original carton and packing materials in case you need to move or ship the unit in the future.

**Keep this manual handy for future reference.**

### Preparations

<b>Setting up the system</b> .....	<b>8</b>
Connecting the terminals .....	9
Connecting audio components .....	10
Connecting video components .....	11
Digital connections .....	12
Connecting video components (COMPONENT VIDEO) .....	13
Connecting a DVD player (6-channel input) ....	14
Connecting the speakers .....	15
Connecting to the AV AUX jacks .....	16
Connecting the antennas .....	16
<b>Preparing for surround sound</b> .....	<b>17</b>
Speaker settings .....	17

### Operations

<b>Normal playback</b> .....	<b>20</b>
Preparing for playback .....	20
Listening to a source component .....	20
Adjusting the sound .....	21
<b>Recording</b> .....	<b>23</b>
Recording audio (analog sources) .....	23
Recording video .....	23
Recording audio (digital sources) .....	23
<b>Listening to radio broadcasts</b> .....	<b>24</b>
Tuning radio stations .....	24
Presetting radio stations manually .....	24
Receiving preset stations .....	25
Receiving preset stations in order (P.CALL) ...	25
<b>Ambience effects</b> .....	<b>26</b>
Surround modes .....	26
Surround play .....	28
DVD 6-channel playback .....	30
Convenient functions .....	30

### Remote Control

<b>Basic remote control operations for other components</b> .....	<b>33</b>
Registering setup codes for other components .....	33
Searching for your codes .....	33
Checking the codes .....	34
Re-assigning device keys .....	34
Operating other components .....	34
Setup code chart .....	35
CASSETTE deck, CD player & MD recorder operations .....	39
Other components' operations .....	40

### Additional Information

<b>In case of difficulty</b> .....	<b>42</b>
 <b>Specifications</b> .....	<b>44</b>

## Preparing the remote control

### Loading the batteries

① Remove the cover.



② Insert the batteries.

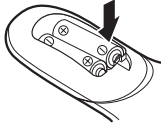

③ Close the cover.



- Insert two AA-size (R6) batteries as indicated by the polarity markings.

### Operation

When the **STANDBY** indicator is lit, the power turns ON when you press the **POWER RCVR** key on the remote control. When the power comes ON, press the key you want to operate.

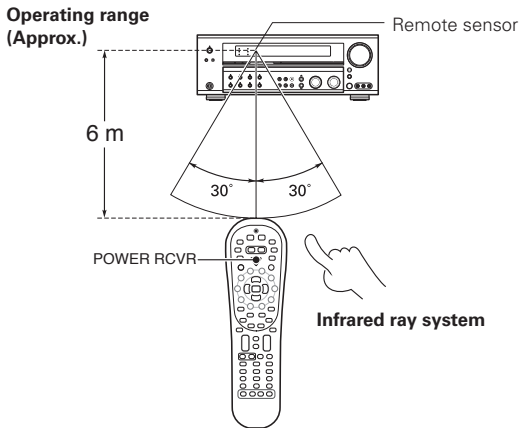

- When pressing more than one remote control key successively, press the keys securely by leaving an interval of 1 second or more between keys.

### Notes

1. The supplied batteries may have shorter lives than ordinary batteries due to use during operation checks.
2. When the remote-controllable distance gets shorter than before, replace both batteries with new ones.
3. Placing the remote sensor in direct sunlight, or in direct light from a high frequency fluorescent lamp may cause a malfunction. In such a case, change the location of the system installation to prevent malfunction.

### For the U.S.A.

#### FCC WARNING

This equipment may generate or use radio frequency energy. Changes or modifications to this equipment may cause harmful interference unless the modifications are expressly approved in the instruction manual. The user could lose the authority to operate this equipment if an unauthorized change or modification is made.

#### NOTE:

This equipment has been tested and found to comply with the limits for a Class B digital device, pursuant to Part 15 of the FCC Rules. These limits are designed to provide reasonable protection against harmful interference in a residential installation. This equipment may cause harmful interference to radio communications, if it is not installed and used in accordance with the instructions. However, there is no guarantee that interference will not occur in a particular installation. If this equipment does cause harmful interference to radio or television reception, which can be determined by turning the equipment off and on, the user is encouraged to try to correct the interference by one or more of the following measures:

- Reorient or relocate the receiving antenna.
- Increase the separation between the equipment and receiver.
- Connect the equipment into an outlet on a circuit different from that to which the receiver is connected.
- Consult the dealer or an experienced radio / TV technician for help.

### For the U.S.A.

#### Note to CATV system installer

This reminder is provided to call the CATV system installer's attention to Article 820-40 of the NEC that provides guidelines for proper grounding and, in particular, specifies that the cable ground shall be connected to the grounding system of the building, as close to the point of cable entry as practical.



As an ENERGY STAR® Partner, Kenwood Corporation has determined that this product meets the ENERGY STAR® guidelines for energy efficiency. This product can save energy. Saving energy reduces air pollution and lowers utility bills.

## Special features

### True home theater sound

This receiver incorporates a wide variety of surround modes to bring you maximum enjoyment from your video software. Select a surround mode according to your equipment or the software you are going to play and enjoy!

— 26

### Dolby Digital and Dolby Digital EX

The DOLBY DIGITAL mode lets you enjoy full digital surround from software processed in the Dolby Digital format. Dolby Digital provides up to 5.1 channels of independent digital audio for better sound quality and more powerful presence than conventional Dolby Surround. As for Dolby Digital EX, it creates six full-bandwidth output channels from the 5.1 channel sources. This is done using a matrix decoder that derives three surround channels from the two in the original recording. For best results, Dolby Digital EX should be used with movie soundtracks recorded with Dolby Digital Surround EX.

### Dolby PRO LOGIC IIx and Dolby PRO LOGIC II

DOLBY PRO LOGIC II, whilst totally compatible with its predecessor PRO LOGIC, provides greater advantages in surround sound. It allows user to enjoy the conventional stereo or Dolby Surround with a convincing "5.1 like" presentation. PRO LOGIC II offers special features for controlling the overall spatial, dimensionality and frontal sound field imaging. PRO LOGIC II produces an impressive surround sound from video software marked  and three-dimensional space from music CD. When listening to music, you will be able to enjoy the experience of sheer STEREO surround sound. DOLBY PRO LOGIC IIx enhanced DOLBY PRO LOGIC II's features. It creates 6.1 channel and 7.1 channel surround sound from stereo or 5.1 channel signals. This feature provides you an astonishing ambience effect which makes you feel you are surrounded by natural sound. Especially 7.1 channel surround sound can produce real back sound from Surround Back speakers.

### DTS and DTS-ES

DTS (Digital Theater System) is a 5.1 channel digital audio format that provides five full spectrum channels and one low-frequency (subwoofer) channel for unprecedented clarity, optimum channel separation and a (wide) dynamic range.

DTS-ES (Extended Surround) presents 6.1 channels surround system with additional Surround Back channel which evolved from the conventional 5.1 channels surround system. DTS-ES format that was recorded in DVD, CD or LD comprises of two modes. DTS-ES Discrete 6.1 produce the discrete surround back which is completely independent and DTS-ES Matrix 6.1 produces the surround back which synthesised within the left and right surround channels using matrix technology. DTS-ES has perfect compatibility with the conventional 5.1 channels surround system. 6.1 channels surround with an additional surround back presents a more natural presence and surround effects by increasing the impression of the sound image from back.

Important:

When a DTS disc is played on a CD, LD or DVD player, noise may be output from the analog output. It is recommended that you connect the digital output of the player to the digital input of this unit.

### DTS 96/24

DTS 96/24 made it possible to achieve a wide frequency range of over 40 kHz by increasing the sampling frequency to 96 or 88.2 kHz. Moreover, DTS 96/24's ability of 24 bit resolution offers the same frequency band and dynamic range as 96 kHz/24 bit PCM.

DTS 96/24 is, as with conventional DTS Surround, compatible with multi-channels. Therefore, sources recorded using DTS 96/24 technologies can be played in high sampling frequency, multi-channel audio with ordinary DVDs and CDs.

### Neo:6

Neo:6 is a new technology which was developed by DTS. It can produce high grade 6 channels surround with an astonishing fidelity from 2 channels content. Neo:6 has 2 mode, "CINEMA" mode is for movie playback and "MUSIC" mode is for music playback.

### DSP surround modes

The DSP (Digital Signal Processor) used for this receiver incorporates a variety of high quality adjustable sound fields, like "ARENA", "JAZZ CLUB", "THEATER", "STADIUM" and "DISCO". It is compatible with almost any kind of program source.

### DVD 6-channel input

If you own a DVD player equipped with 6-channel output, this receiver allows you to obtain the full surround sound impact of DVD source material featuring multi-channel encoding. Since the source signals are digital and each channel is input independently, the resulting ambience is far superior to what can be achieved with conventional surround sound systems.

### ACTIVE EQ

ACTIVE EQ mode will produce a more dynamic sound quality in any condition. You can enjoy a more impressive sound effect when ACTIVE EQ is turned on.

### SPEAKER EQ

SPEAKER EQ function is to adjust the receiver's audio output characteristics with the speakers' characteristics which differs depending on the size of the speakers. When activating the SPEAKER EQ function, you will be able to enjoy a more natural and dynamic sound experience even with small size speakers.

### Universal IR (InfraRed) remote control

In addition to the basic receiver, the remote control supplied with this receiver can also operate almost all of your remote controllable audio and video components. Just follow the simple setup procedure to register the components you have connected.

### Video up conversion

This receiver can convert the incoming composit video signals to S-Video signal.

If your monitor TV has S-Video jacks, it is not necessary to do the composit video connections, just use an S-Video cord to connect the receiver and your monitor TV.

# Names and functions of parts

## Main unit

\*Input channel indicators  
Input channel indicators light up according to the incoming audio signals.  
"S" indicator will light up when the surround component of the audio signals is only 1 channel.

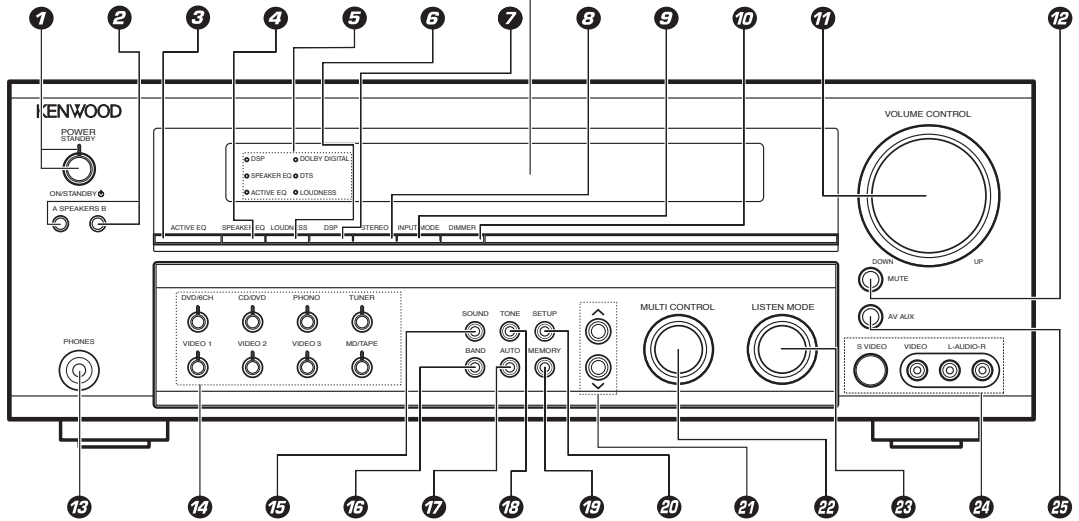
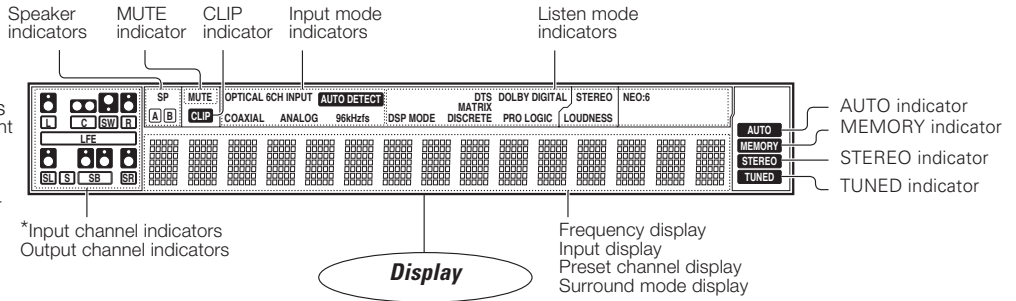

- 1 POWER ON/STANDBY  $\updownarrow$  key** - [17]  
Use to turn the power ON/STANDBY.  
**STANDBY indicator**
- 2 A SPEAKERS B keys** - [20]  
Use to turn the A/B speakers on or off.
- 3 ACTIVE EQ key** - [21]  
Use to select ACTIVE EQ's setting.
- 4 SPEAKER EQ key** - [21]  
Use to select SPEAKER EQ's setting.
- 5 Surround LED (lighting-emitting diode) indicators**  
**DSP mode LED indicator** - [29]  
Lights when the receiver is in the DSP mode.  
**SPEAKER EQ mode LED indicator** - [22]  
Lights when the receiver is in the SPEAKER EQ mode.  
**ACTIVE EQ mode LED indicator** - [22]  
Lights when the receiver is in the ACTIVE EQ mode.  
**DOLBY DIGITAL mode LED indicator** - [29]  
Lights when the receiver is in the Dolby Digital mode.  
**DTS mode LED indicator** - [29]  
Lights when the receiver is in the DTS mode.  
**LOUDNESS LED indicator** - [21]  
Lights when the LOUDNESS is ON.
- 6 LOUDNESS key** - [21]  
Use to switch the status of LOUDNESS.
- 7 DSP key** - [28]  
Use to select any of the DSP mode.
- 8 STEREO key** - [30]  
Use to switch the listen mode to STEREO.
- 9 INPUT MODE key** - [8]  
Use to switch between the full auto, digital and analog inputs.
- 10 DIMMER key** - [23]  
Use to select the REC MODE.  
Use to adjust the brightness of the display.
- 11 VOLUME CONTROL knob** - [20]  
**12 MUTE key** - [21]  
Use to temporarily mute the sound.
- 13 PHONES jack** - [22]  
Use for headphone listening.
- 14 Input Selector keys (DVD/6CH, CD/DVD, PHONO, TUNER, VIDEO 1, VIDEO 2, VIDEO 3, MD/TAPE)** - [20]  
Use to select input sources.
- 15 SOUND key** - [30]  
Use to adjust the sound quality and the ambience effects.
- 16 BAND key** - [24]  
Use to select the broadcast band.
- 17 AUTO key** - [24]  
Use to select the auto or manual tuning mode.
- 18 TONE key** - [21]  
Use to switch the status of TONE control.
- 19 MEMORY key** - [24]  
Use to store radio stations in the preset memory.
- 20 SETUP key** - [17]  
Use to select the speakers' settings etc.
- 21  $\wedge/\vee$  keys** - [17]  
Use for selection adjustments during sound, set up and preset channel functions.
- 22 MULTI CONTROL knob** - [17]  
Use to control a variety of settings.
- 23 LISTEN MODE knob** - [28]  
Use to select the listening mode.
- 24 AV AUX (S VIDEO, VIDEO, L-AUDIO-R) jacks** - [16]  
**25 AV AUX key** - [16]  
Use to switch the input to AV AUX.

## Standby mode

While the standby indicator is lit, a small amount of power is supplied to the system to back up the memory. This is called standby mode. Under the condition, the system can be turned ON by remote control unit.

## Remote control unit

This remote control unit can be use not only for Kenwood products but also for other non-Kenwood products by setting the appropriate manufacturer's setup codes. - [35]

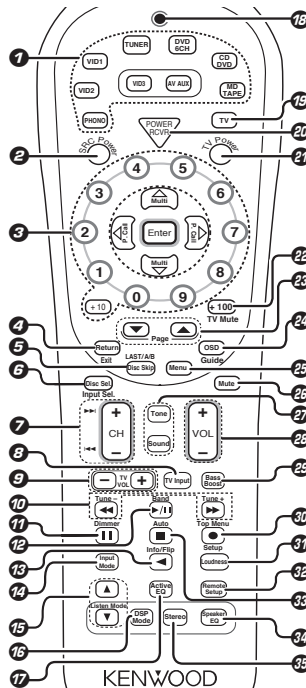

If the name of a function is different on the receiver and on the remote control, the name of the remote control key in this manual is indicated in parentheses.

- 1 Source keys (MD/TAPE, CD/DVD, DVD/6CH, TUNER, VID1, VID2, VID3, AV AUX, PHONO)**  
When press and hold for more than 3 seconds, they are used to select the registered components. - [33]  
**Input Selector keys (MD/TAPE, CD/DVD, DVD/6CH, TUNER, VID1, VID2, VID3, AV AUX, PHONO)**  
When press and release in less than 3 seconds, they are used to select the input sources. - [20]
- 2 SRC (source) Power key**  
Use to turn the other source components on or off.
- 3 Numeric keys** - [25]  
Provide functions identical to those of the original remote control supplied with the component you are controlling.  
**Multi (multi control)  $\Delta/\nabla$  keys** - [17]  
Use to control a variety of settings.  
**Multi (multi control)  $\leftarrow/\rightarrow$  keys** - [17]  
Use to operate other components.  
**P.Call  $\triangleleft/\triangleright$  keys** - [25]  
Use for selection adjustments during sound, set up and preset channel functions.  
**Enter key**  
Use to operate other components.
- 4 Return key**  
Use to operate the DVD component.  
**Exit key**  
Use to operate other components.
- 5 Disc Skip key**  
If CD is selected as the input source, this key functions as the multi-CD player disc skip key.  
**LAST/A/B key**  
If TAPE is selected as the input source, this is A and B deck of a double cassette deck.  
Use to operate other components.
- 6 Disc Sel. key**  
Use to operate other components.  
**Input Sel. key**  
Use to operate other components.
- 7 CH +/- keys**  
Use to select the channels.  
 **$\ggg/\lll$  keys**  
If CD, MD and DVD is selected as the input source, these keys function as skip keys.
- 8 TV Input key**  
Use when in TV operation.
- 9 TV VOL +/- keys**  
Use to adjust the TV's volume.
- 10  $\lll/\ggg$  keys**  
If CD, MD or Tape is selected as the input source, this key functions as search keys.
- Tune +/- keys** - [24]  
Use to operate the tuner mode.
- 11 II key**  
Use to operate other components.  
**Dimmer key** - [30]  
Use to adjust the brightness of the display.
- 12  $\triangleright/\text{II}$  key**  
If CD is selected as the input source, this key functions as the play/pause key.  
If MD or TAPE key is selected as input source, this key functions as the play key.  
**Band key** - [24]  
Use to select the broadcast band.
- 13  $\triangleleft$  key**  
If Tape is selected, this key functions as reverse play key.  
**Info/Flip key**  
Use to operate other components.
- 14 Input Mode key** - [8]  
Use to switch between the full auto, digital and analog inputs.
- 15 Listen Mode  $\blacktriangle/\blacktriangledown$  keys** - [28]  
Use to select the listening mode.
- 16 DSP Mode key** - [28]  
Use to select any of the DSP mode.
- 17 Active EQ key** - [21]  
Use to select ACTIVE EQ's setting.
- 18 LED (lighting-emitting diode) indicator**  
Blinks to show that signals are being transmitted.
- 19 TV key**  
Use to select the TV equipment.
- 20 POWER RCVR (receiver) key** - [17]  
Use to turn the receiver on or off.
- 21 TV Power key**  
Use to turn the TV on or off.
- 22 +100 key**  
Use to select the disc number with the multi-CD player.  
**TV mute key**  
Use to temporarily mute the TV sound.
- 23 Page  $\blacktriangle/\blacktriangledown$  keys**  
Use to operate other components.
- 24 OSD (on screen display) key**  
Use to operate the DVD component.  
**Guide key**  
Use to operate other components.
- 25 Menu key**  
Use to operate other components.
- 26 Mute key** - [21]  
Use to temporarily mute the sound.
- 27 Tone key** - [21]  
Use to switch the status of TONE control.
- 28 Sound key** - [30]  
Use to adjust the sound quality and the ambience effects.
- 29 VOL +/- keys** - [20]  
Use to adjust the receiver's volume.
- 30 Bass Boost key** - [21]  
Use to select the maximum adjustment setting for the low frequency range.
- 31  $\bullet$  key**  
If VCR is selected, this key functions as record key when it pressed twice sequentially.  
When in MD or Tape is selected, this key functions as record key.  
**Top Menu key**  
Use to operate the DVD component.  
**Setup key** - [17]  
Use to select the speakers' settings etc.
- 32 Loudness key** - [21]  
Use to switch the status of LOUDNESS.
- 33 Remote Setup key** - [33]  
Use to register other components.
- 34  $\blacksquare$  key**  
If CD, MD, or TAPE is selected as the input source, this key functions as the stop key.  
**Auto key** - [24]  
Use to select the auto or manual tuning mode.
- 35 Speaker EQ key** - [21]  
Use to select SPEAKER EQ's setting.
- 36 Stereo key** - [30]  
Use to switch the listen mode to STEREO.

# Setting up the system

Make connections as shown in the following pages. When connecting the related system components, be sure to refer to the instruction manuals supplied with the components you are connecting. Do not connect the power cord to a wall outlet until all connections are completed.

## Notes

1. Be sure to insert all connection cords securely. If their connections are imperfect, sound may not be produced or there will be noise inference.
2. Be sure to remove the power cord from the AC outlet before plugging or unplugging any connection cords. Plugging/unplugging connection cords without disconnecting the power cord can cause malfunctions and may damage the unit.
3. Do not connect power cords from components whose power consumption is larger than what is indicated on the AC outlet at the rear of this unit.

## Analog connections

Audio connections are made using RCA pin cords. These cables transfer stereo audio signal in an "analog" form. This means the audio signal corresponds to the actual audio of two channels. These cables usually have 2 plugs on each end, one red for the right channel and one white for the left channel. These cables are usually packed together with the source unit, or are available at your local electronics retailer.

## Microcomputer malfunction

If operation is not possible or an erroneous display appears, even though all connections have been made properly, reset the microcomputer referring to "In case of difficulty". - 42

## Memory back up function

Please note that the following items will be deleted from the unit's memory if the power cord is disconnected from the AC outlet for approximately 1 day.

- Power mode
- Input selector settings
- Picture output
- Speaker ON/OFF
- Volume level
- BASS, TREBLE, INPUT level
- TONE ON/OFF
- LOUDNESS ON/OFF
- Dimmer level
- MD/TAPE settings
- Listen mode setting
- Speaker settings
- Distance setting
- Input mode setting
- Sound mode settings
- Broadcast band
- Frequency setting
- Preset stations
- Tuning mode
- ACTIVE EQ mode
- SPEAKER EQ mode

## Input mode settings

CD/DVD, VIDEO 2, VIDEO 3 and DVD/6CH inputs each include jacks for digital audio input and analog audio input.

The initial factory settings for audio signal playback for CD/DVD, DVD/6CH, VIDEO 2 and VIDEO 3 are full auto.

After completing connections and turning on the receiver, follow the steps below.

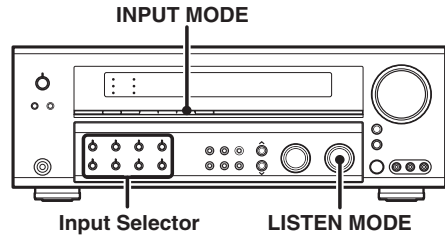

- 1 Use the Input Selector keys to select CD/DVD, VIDEO 2, VIDEO 3 or DVD/6CH.

- 2 Press the INPUT MODE key.

Each press switches the setting as follows:

### In DTS play mode

- 1 FULL AUTO (digital input, analog input)
- 2 DIGITAL MANUAL (digital input)

### In CD/DVD, VIDEO 2, VIDEO 3 or DVD/6CH play mode

- 1 FULL AUTO (digital input, analog input)
- 2 DIGITAL MANUAL (digital input)
- 3 6CH INPUT (DVD/6CH input)
- 4 ANALOG (analog input)

## Digital input:

Select this setting to play digital signals from a DVD, CD, or LD player.

## Analog input:

Select this setting to play analog signals from a cassette deck, VCR, or record player.

## Auto detect:

In "FULL AUTO" mode (AUTO DETECT indicator light up), the receiver detects the digital or analog input signals automatically. Priority is given to digital signal during input mode selection. The receiver will select the input mode and listening mode automatically during playback to match the type of input signal (Dolby Digital, PCM, DTS) and the speaker setting. The OPTICAL and COAXIAL indicator on the display will light up when digital signal is detected. If the input signal is analog, the ANALOG indicator will light up.

To keep the receiver set to the currently selected listening mode, use the INPUT MODE key to select "DIGITAL MANUAL" (manual sound). However, even when this setting is selected, there may be cases in which the listening mode is selected automatically to match a Dolby Digital source signal depending on the combination of listening mode and source signal.

At DIGITAL MANUAL, if the audio reproduction stops in the middle due to change in the input signals, etc. press the LISTEN MODE Knob.

If the INPUT MODE key is pressed quickly, sound may not be produced. Press the INPUT MODE key again.



## Connecting the terminals

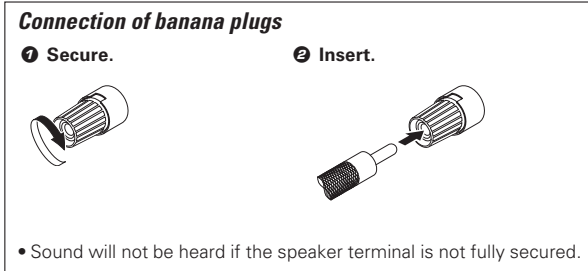
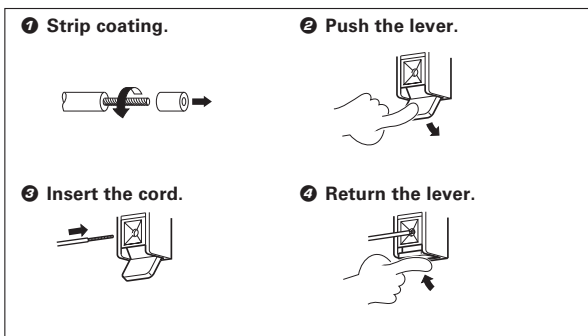
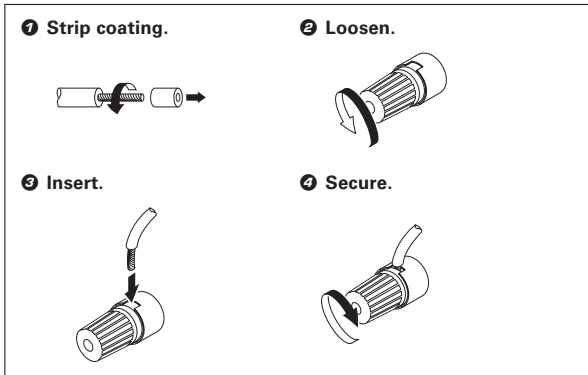

- Never short circuit the + and – speaker cords.
- If the left and right speakers are connected inversely or the speaker cords are connected with reversed polarity, the sound will be unnatural with ambiguous acoustic imaging. Be sure to connect the speakers correctly.

### Speaker impedance

After confirming the speaker impedance indications printed on the rear panel of the receiver, connect speakers with matching impedance ratings. Using speakers with a rated impedance other than that indicated on the rear panel of the receiver could result in malfunctions or damage to the speakers or receiver.

### Speaker placement

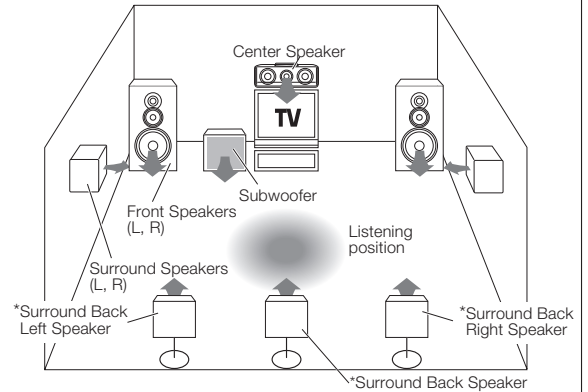

\*For Surround Back speaker, you may place either two Surround Back speakers (Surround Back Left Speaker and Surround Back Right Speaker) for 7.1 channel surround sound system or one Surround Back Speaker for 6.1 channel surround sound system.

#### Front (Left and Right) Speakers

Place at the front left and right of the listening position. Front Speakers are required for all surround modes.

#### Center Speaker

Place front and center. This speaker stabilizes the sound image and helps recreate sound motion. Required for surround playback.

#### Surround (Left and Right) Speakers

Place at the direct left and right, or slightly behind, the listening position at even heights, approximately 1 meter above the ears of the listeners. These speakers recreate sound motion and atmosphere. Required for surround playback.

#### Subwoofer

Reproduces powerful deep bass sounds.

#### Surround Back Speaker/s

Place the speaker/s directly at the rear of the listening position. The optimum position depends mainly on the room condition.

- Although the ideal surround system consists of all the speakers listed above, if you don't have a Center speaker or a Subwoofer, you can divide those signals between the available speakers in the speaker settings steps to obtain the best possible surround reproduction from the speakers you have available. 

## Connecting audio components

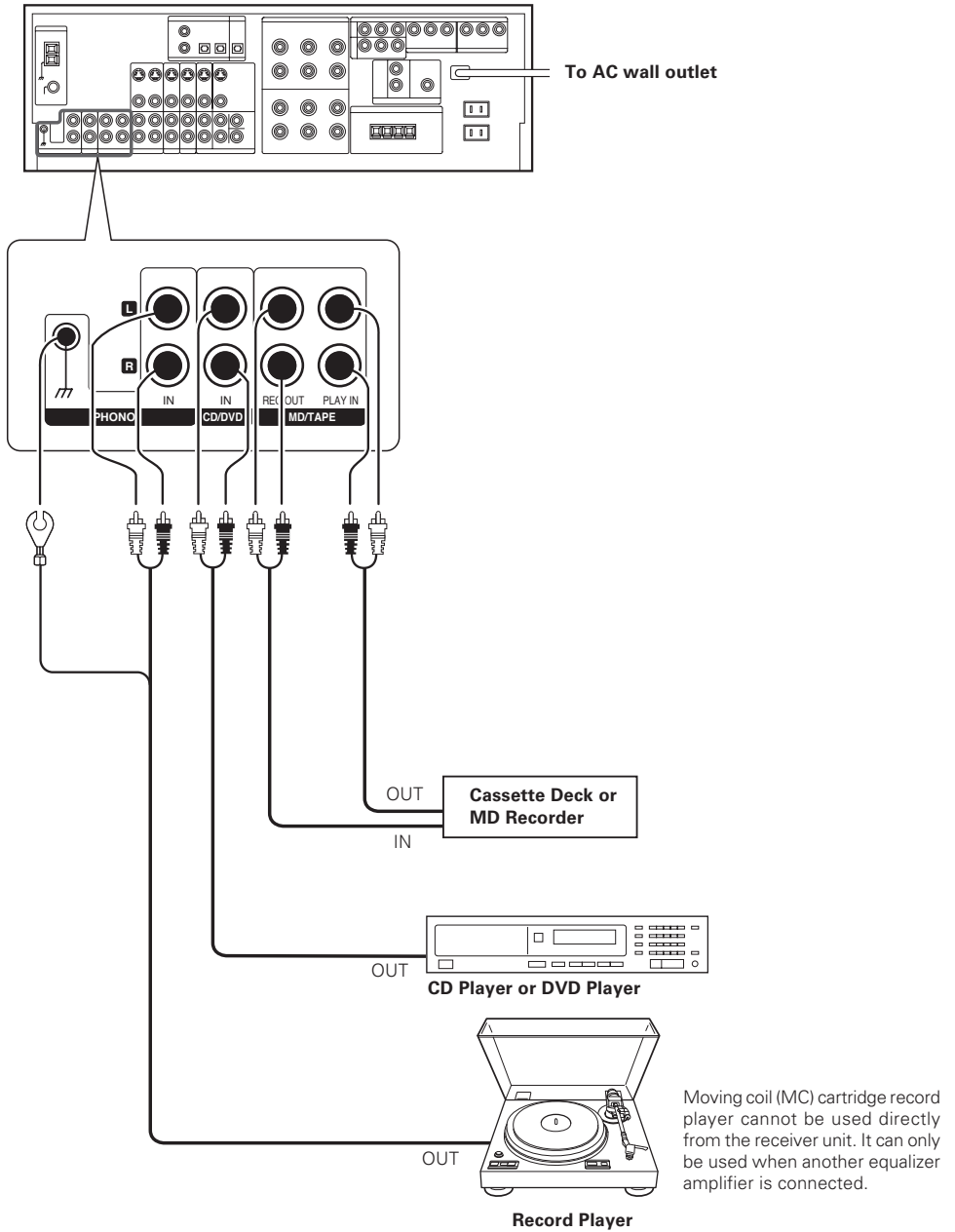

### CAUTION

Be sure to adhere to the following, or proper ventilation will be blocked causing damage or fire hazard.

- Do not place any object impairing heat radiation onto the top of the unit.
- Leave a space around the unit (from the largest outside dimension including projection) equal or greater than, shown below.

Top panel : 50 cm

Side panel : 10 cm

Back panel : 10 cm

## Connecting video components

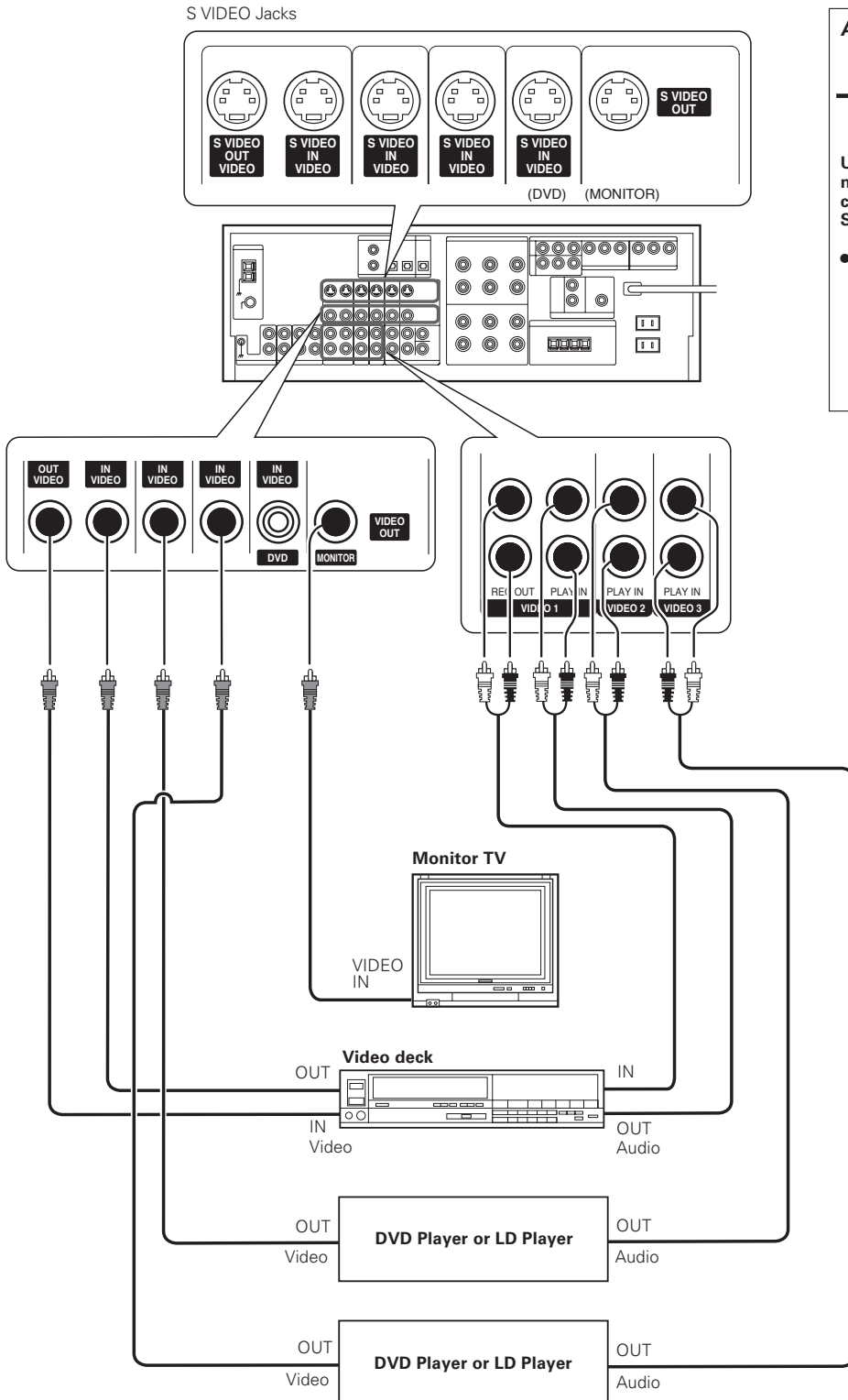

### About the S VIDEO Jacks

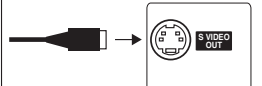

Use the S VIDEO Jacks to make connections to video components with S VIDEO IN/OUT Jacks.

- If you use the S VIDEO jacks to connect your video playback components, be sure to use the S VIDEO jacks when connecting your monitor and video recording components.

A video component with digital audio outputs should be connected to the VIDEO 2 or VIDEO 3 jacks.

## Digital connections

The digital in jacks can accept DTS, Dolby Digital, or PCM signals. Connect components capable of outputting DTS, Dolby Digital, or standard PCM (CD) format digital signals.

If you have connected any digital components to the receiver, be sure to read the "Input mode settings" section carefully.

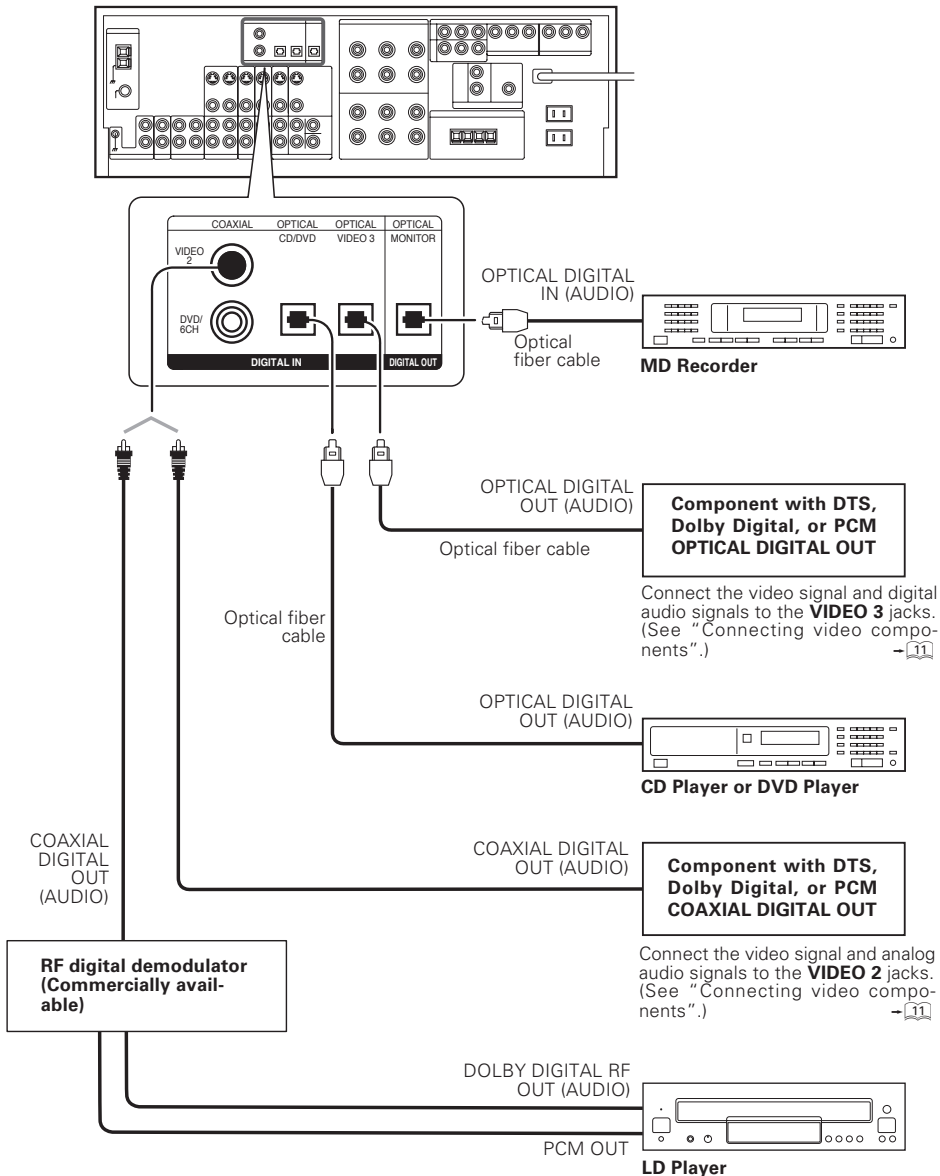

To connect an LD player with a DIGITAL RF OUT, connect the LD player to the RF digital demodulator (Commercially available). Next, connect the DIGITAL OUT jacks of the demodulator to the DIGITAL IN jacks of the receiver. Connect the video signal and analog audio signals to the VIDEO 2 or VIDEO 3 jacks. (See "Connecting video components".)

## Connecting video components (COMPONENT VIDEO)

If you have connected the receiver to a video component with COMPONENT jacks, you can get a better picture quality than by connecting to the S-VIDEO jacks.

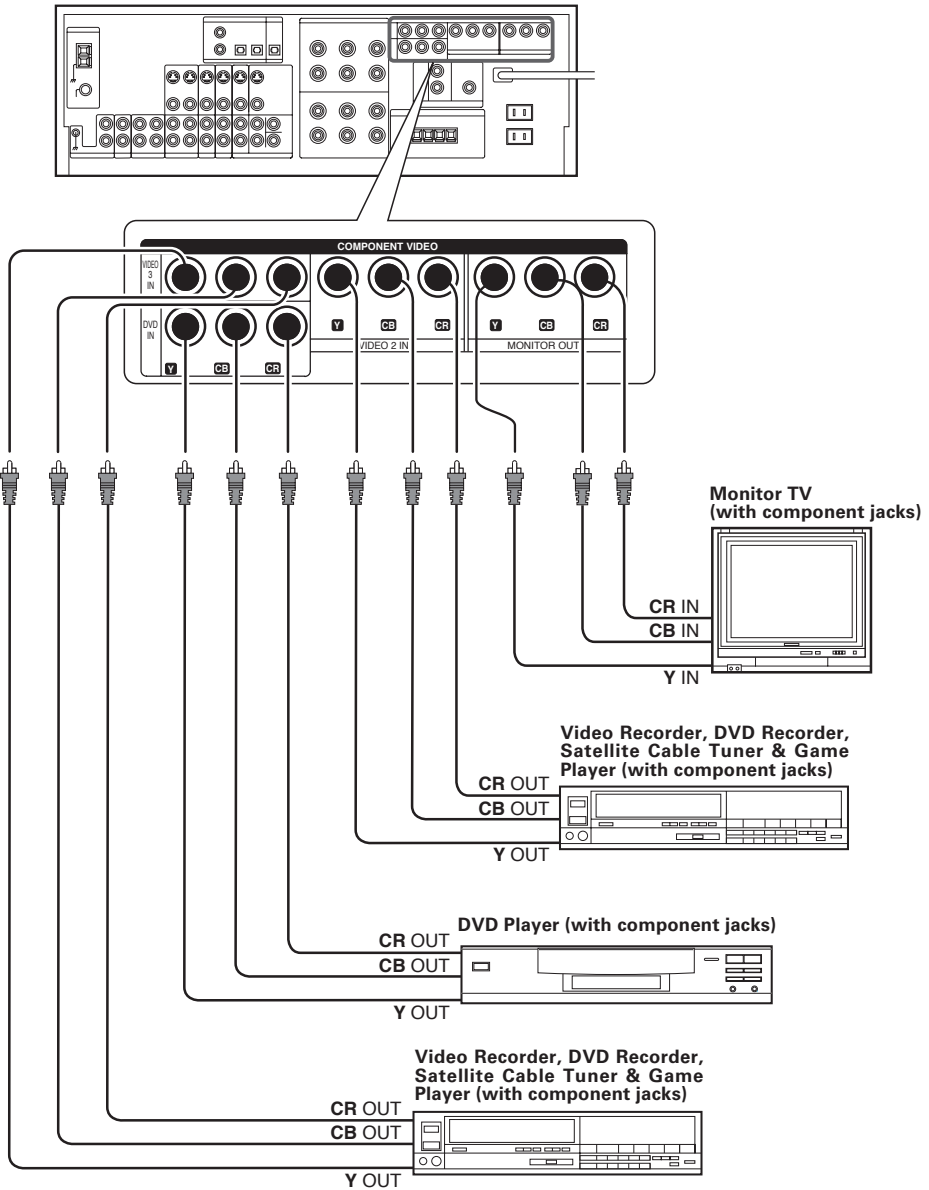

When connecting the TV to the COMPONENT jacks, be sure to connect all the other components to the COMPONENT jacks.

## Connecting a DVD player (6-channel input)

If you have connected a DVD player to the receiver with digital connection, be sure to read the "Input mode settings" section carefully.

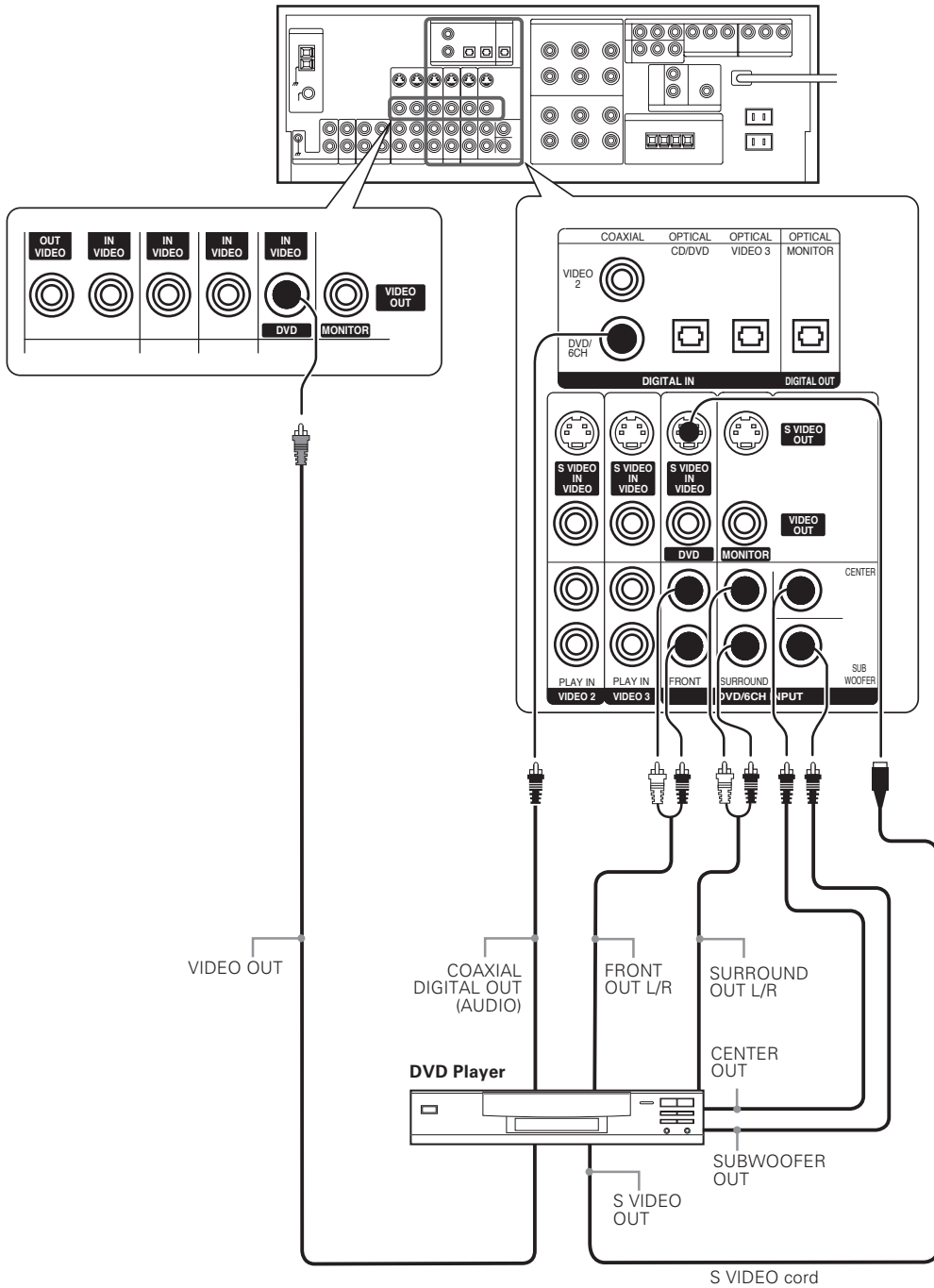

## Connecting the speakers

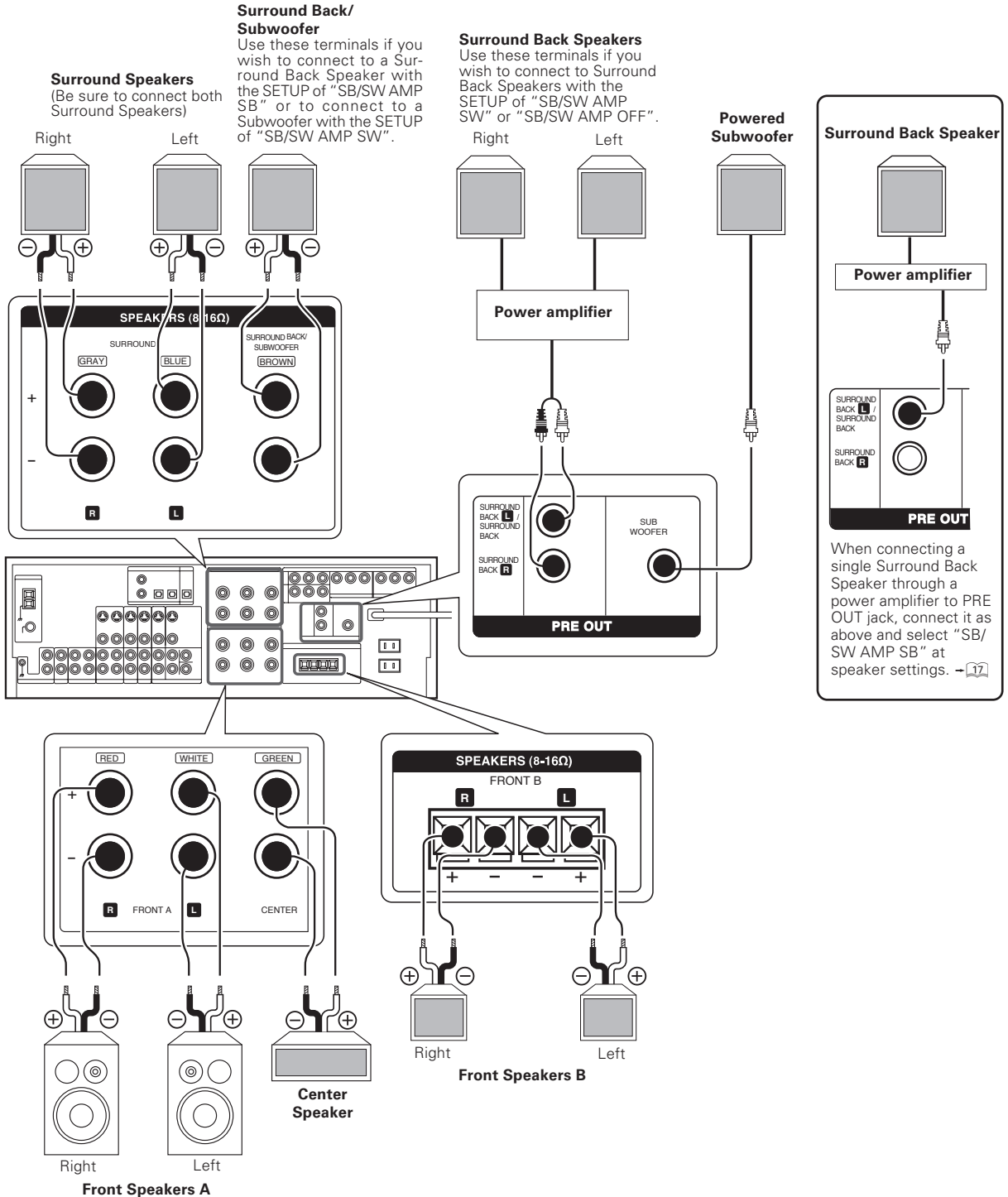

To make sure that each speaker has been connected properly, pay attention to the test tone from each speaker. Refer to " Adjust the speaker volume level."

## Connecting to the AV AUX Jacks

The **AV AUX** jacks are convenient for connection of video components such as a camcorder or a video game.

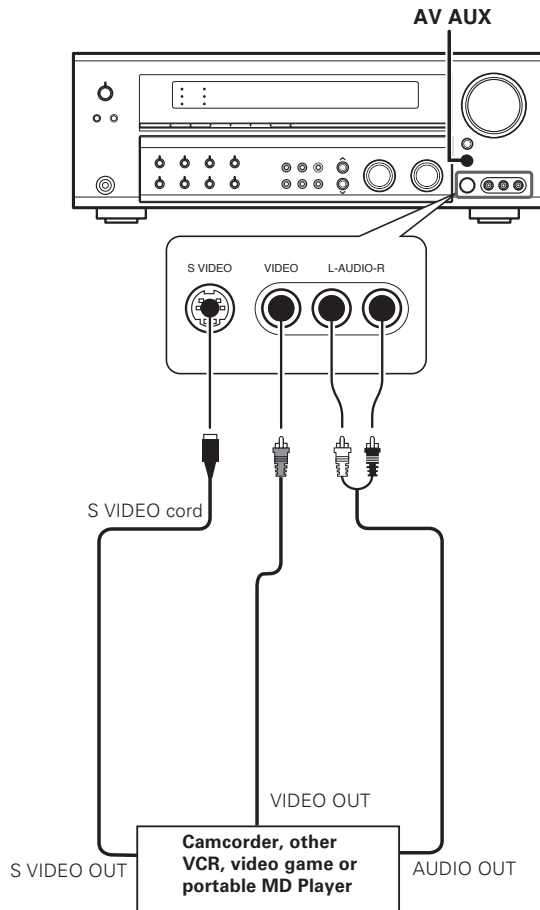

- To select the source connected to the AV AUX jacks press **AV AUX** key. - [20]
- When you connect the audio source such as the MD player, you do not need to connect the video cable.
- When you connect the unit and the component with the S VIDEO cord, you can get better picture quality.

## Connecting the antennas

The broadcast reception cannot be made unless the antennas are connected. Connect the antennas correctly as instructed below.

### AM Loop Antenna

Place the supplied loop antenna as far as possible from the receiver, TV set, speaker cords and power cord, and adjust the direction for best reception.

#### AM Antenna Terminal connections

1 Push lever.

2 Insert cord.

3 Release lever.

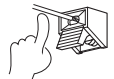
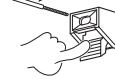
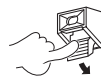

### FM Indoor Antenna

The supplied indoor antenna is for temporary use only. For stable signal reception we recommend using an outdoor antenna. Disconnect the indoor antenna when you connect one outdoors.

#### FM Antenna Terminal connections

Insert Connector.



### FM Outdoor Antenna

Lead the 75Ω coaxial cable connected to the FM outdoor antenna into the room and connect it to the FM 75Ω terminal.

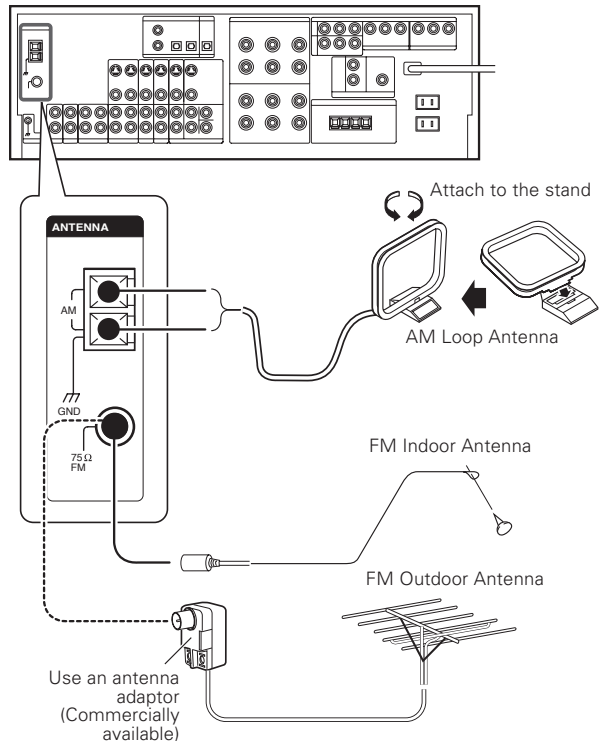



# Preparing for surround sound

## Speaker settings

To enable you to obtain optimum enjoyment from the receiver's listening modes, make sure to complete the speaker settings (Subwoofer, Front, Center, Surround and Surround Back Speakers) as described below.

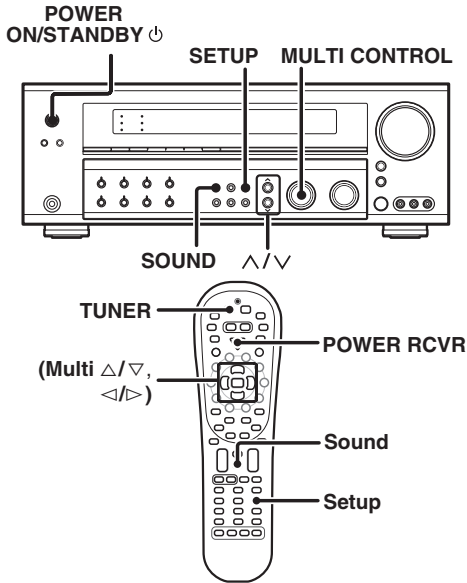

**1** Turn on the power to this receiver by pressing the **POWER ON/STANDBY** key or **POWER RCVR** key.

**2** For the remote control, press and hold the **TUNER** key for more than 3 seconds to switch to receiver mode.

**3** Press the **SETUP** key to enter the **SETUP** mode.

The Surround Back Speaker and Subwoofer output selections are displayed as follows:

- ① **SB/SW AMP SB** : Surround Back/Subwoofer Speaker terminal will output SB sound. Surround Back pre out will have output from SBL only.
- ② **SB/SW AMP SW** : Surround Back/Subwoofer Speaker terminal will output Subwoofer sound. Surround Back pre out will have output from SBL and SBR.
- ③ **SB/SW AMP OFF** : It is not advisable to use Surround Back/Subwoofer speaker terminal for this selection.

Use the **MULTI CONTROL** knob or **Multi** ( $\Delta/\nabla$ ) keys to select the speakers.  
Press the **SETUP** key to proceed to the next **SETUP** selection.

Use  $\Delta/\nabla$  keys or  $\triangleleft/\triangleright$  keys for the following displays.

- ① **SP SETUP**
- ② **TEST TONE**
- ③ **SP DISTANCE**
- ④ **LFE LEVEL**
- ⑤ **DISP MODE**
- ⑥ **EXIT**

The flow of the **SETUP** is as follows:

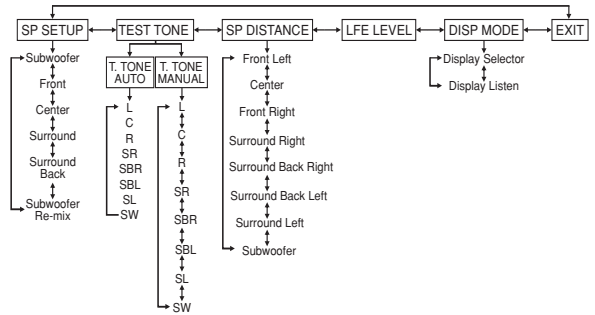

- If you have selected "SB/SW AMP SB", "SBR"/"Surround Back Right" and "SBL"/"Surround Back Left" are not appeared but "SB"/"Surround Back" is appeared on the Display.

### 4 Select a speaker system.

**1** Select the **SP SETUP** and press the **SETUP** key again so that the subwoofer setting indication "SUBW ON" appears.

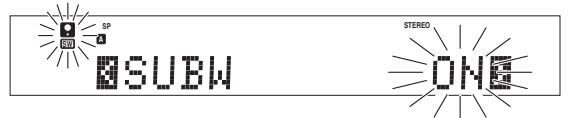

**2** Use the **MULTI CONTROL** knob or **Multi** ( $\Delta/\nabla$ ) keys to select the appropriate subwoofer setting.

- ① **SUBW ON** : Subwoofer setting mode to the receiver is ON.
- ② **SUBW OFF** : Subwoofer setting mode to the receiver is OFF.

- The initial setting is "SUBW ON".
- When the setting "SUBW OFF" is selected, the Front Speakers are automatically set to "FRNT LARGE" and the procedure skips to step ④.
- Before step ③, press the **SETUP** key to accept the setting.
- When Subwoofer output sound is required, select "FRNT NORMAL", or select both "FRNT LARGE" and "SW RE-MIX ON".
- After setting SW (Subwoofer) from OFF to ON, SB/SW AMP setup display will appear to enable you to re-select either SW or SB from the Surround Back Speaker or Subwoofer terminal.

**3** Press the  $\Delta$  key or  $\triangleright$  key to accept the setting.

- The front speakers setting indication "FRNT" appears.

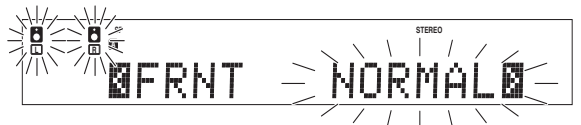

**4** Use the **MULTI CONTROL** knob or **Multi** ( $\Delta/\nabla$ ) keys to select the appropriate front speakers setting.

- ① **FRNT NORMAL** : Average size Front Speakers are connected to the receiver.
- ② **FRNT LARGE** : Large Front Speakers are connected to the receiver.

- For "FRNT LARGE" selection, no sound will be heard from Subwoofer speaker even when it is set to on. However, if you select "SW RE-MIX ON" when Subwoofer is selected, you will be able to hear sound from the Subwoofer.
- When in **STEREO** mode, the sound goes directly to Front Speaker.

**5** Press the  $\Delta$  key or  $\triangleright$  key to accept the setting.

- The Center speaker setting indication "CNTR" appears.

Continued to next page.

- 6 Use the MULTI CONTROL knob or Multi ( $\Delta/\nabla$ ) keys to select the appropriate Center Speaker setting.

If you selected "LARGE" as the Front Speakers setting,

- 1 CNTR NORMAL : An average size Center Speaker is connected to the receiver.
- 2 CNTR LARGE : A large Center Speaker is connected to the receiver.
- 3 CNTR OFF : Center Speaker setting mode to the receiver is OFF.

If you selected "NORMAL" as the Front Speakers setting,

- 1 CNTR NORMAL : An average size Center Speaker is connected to the receiver.
- 2 CNTR OFF : Center Speaker setting mode to the receiver is OFF.

- 7 Press the  $\wedge$  key or  $\triangleright$  key again to accept the setting.  
 • The Surround Speaker setting indication "SURR" appears.

- 8 Use the MULTI CONTROL knob or Multi ( $\Delta/\nabla$ ) to select the appropriate Surround Speaker setting.

If you selected "LARGE" as the Center Speaker setting,

- 1 SURR NORMAL : Average size Surround Speakers are connected to the receiver.
- 2 SURR LARGE : Large Surround Speakers are connected to the receiver.
- 3 SURR OFF : Surround Speaker setting mode to the receiver is OFF.

If you selected other than "LARGE" as the Center Speaker setting,

- 1 SURR NORMAL : Average size Surround speakers are connected to the receiver.
- 2 SURR OFF : Surround speaker setting mode to the receiver is OFF.

- When the setting "SURR OFF" is selected, the procedure skips to step 10.

- 9 Press the  $\wedge$  key or  $\triangleright$  keys again to accept the setting.  
 • The Surround Speaker setting indication "SB" appears.

- 10 Use the MULTI CONTROL knob or Multi ( $\Delta/\nabla$ ) keys to select appropriate Surround Back Speaker setting.

If you selected "LARGE" as the Surround Speaker setting,

- 1 SB NORMAL : Average size Surround Back Speaker is connected to the receiver.
- 2 SB LARGE : Large Surround Back Speaker is connected to the receiver.
- 3 SB OFF : Surround Back Speaker setting mode to the receiver is OFF.

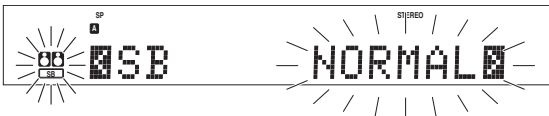

If you selected "NORMAL" as the Surround Speaker setting,

- 1 SB NORMAL : Average size Surround Back Speaker is connected to the receiver.
- 2 SB OFF : Surround Back Speaker setting mode to the receiver is OFF.

- After setting SB (Surround Back) from OFF to NORMAL, SB/SW AMP setup display will appear to enable you to re-select either SW or SB from the Surround Back Speaker or Subwoofer terminal.

- 11 Press the  $\wedge$  key or  $\triangleright$  key again to accept the setting.  
 • The Subwoofer remix setting indication "SW RE-MIX" appears.

- 12 Use the MULTI CONTROL knob or Multi ( $\Delta/\nabla$ ) keys to select the appropriate Subwoofer re-mix setting.

- 1 SW RE-MIX ON : Subwoofer re-mix setting mode to the receiver is ON.
- 2 SW RE-MIX OFF : Subwoofer re-mix setting mode to the receiver is OFF.

- If Subwoofer is turned off, Subwoofer re-mix setting is not visible.

- 13 Press the SETUP key again to return to the main setup displays.

### 5 Adjust the speaker volume level.

From your usual listening position, adjust the volume levels. The volume levels from each speaker should be the same.

- The receiver enters the speaker volume level adjustment mode.
- Indicators appear only for the channels of the speakers selected in step 4.

- 1 Press the  $\wedge/\nabla$  keys or  $\triangleleft/\triangleright$  keys to select TEST TONE.
- 2 Press the SETUP key for the following displays:
  - 1 T.TONE AUTO
  - 2 T.TONE MANUAL
- 3 The selection of AUTO/MANUAL TEST TONE is done by the MULTI CONTROL knob or Multi ( $\Delta/\nabla$ ) keys. Press the SETUP key again to begin TEST TONE.

Use the MULTI CONTROL knob or Multi ( $\Delta/\nabla$ ) keys to adjust the volume level of the test tone output from the speaker channel to be adjusted.

For AUTO selection, the first test tone is heard from the front left speaker for 2.5 seconds. The next test tone is heard from the speakers in the following sequence for 2 seconds each.

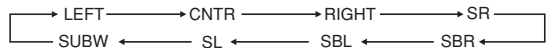

The channel indication blinks while the test tone is being output.



- If you have selected "SB/SW AMP SB", "SBR" and "SBL" are not appeared but "SB" is appeared on the Display.
- If you change the volume level settings for the speakers while listening to music, the settings referred to on this page are also changed. → 30
- If the speaker setting selects are OFF, the speaker level settings are reset.

For MANUAL selection, press the  $\wedge/\nabla$  keys or  $\triangleleft/\triangleright$  keys each time to select the speaker channel.

- 4 Press the SETUP key again.
  - The test tone is turned off and return to the main setup displays.

### 6 Input the distance to the speakers.

- Indicators appear only for the channels of the speakers selected in step 4.

- 1 Press the  $\wedge/\nabla$  keys or  $\triangleleft/\triangleright$  keys to select the SP DISTANCE on setup displays and press the SETUP key again.
- 2 Measure the distance from the listening position to each of the speakers.

Not down the distance to each of the speakers.  
 Distance to Front Left Speaker (L) : \_\_\_ feet (meters)  
 Distance to Center Speaker (C) : \_\_\_ feet (meters)  
 Distance to Front Right Speaker (R) : \_\_\_ feet (meters)

Distance to Surround Right (SR) : \_\_\_ feet (meters)  
 Distance to Surround Back Right (SBR) : \_\_\_ feet (meters)  
 Distance to Surround Back (SB) : \_\_\_ feet (meters)  
 Distance to Surround Back Left (SBL) : \_\_\_ feet (meters)  
 Distance to Surround Left (SL) : \_\_\_ feet (meters)  
 Distance to Subwoofer (SW) : \_\_\_ feet (meters)

- If you have selected "SB/SW AMP SB", "SBR" and "SBL" are not appeared but "SB" is appeared on the Display.

- Use the  $\wedge/\vee$  keys or  $\langle/\rangle$  keys to select the speakers and the MULTI CONTROL knob or Multi ( $\Delta/\nabla$ ) keys to adjust the distance to the Front Speakers.

The speaker indicator to be adjusted blinks.

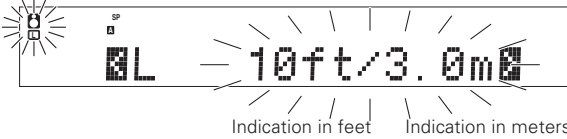

- The allowable setting range is 1 to 30 feet (0.3 to 9.0 m), adjustable in 1 foot (0.3 m) increments.

- Repeat steps 3 to input the distance for each of the speakers.
- Press the SETUP key again to return to main setup displays.
  - The speakers you have selected should appear on the display. Confirm that all the speakers have been correctly selected.

## 7 Adjust the LFE LEVEL (Low Frequency Effects).

- Select the LFE LEVEL from the setup displays and press the SETUP key again.
- Use the MULTI CONTROL knob or Multi ( $\Delta/\nabla$ ) keys to adjust the LFE LEVEL.



- The LFE LEVEL can be adjusted from 0dB to -10dB in 1dB decrements.

- Press the SETUP key again to return to main setup displays.

## 8 Select the display mode.

- Press the  $\wedge/\vee$  key or  $\langle/\rangle$  keys to select the DISP MODE.
- Press the SETUP key for the following displays:
  - DISP SELECTOR : Displays the current input selector.
  - DISP LISTEN : Displays the current listen mode.
- Use the MULTI CONTROL knob or Multi ( $\Delta/\nabla$ ) keys to select the display mode.



- Press the SETUP key again to accept the setting.
- Use the  $\wedge$  key or  $\triangleright$  key to select EXIT.

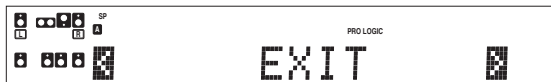

- Press the SETUP key to exit the SET UP mode.

## Input level adjustment (analog sources only)

If the input level of an analog source signal is too high, the CLIP indicator will light up to indicate the source signal. Adjust the input level.



- Use the Input Selector keys to select the source of which the input level you want to adjust.

- You can store a separate input level for each input source.

- Press the SOUND and  $\wedge/\vee$  keys or  $\langle/\rangle$  keys repeatedly until the "INPUT" indication appears.

- Use the MULTI CONTROL knob or Multi ( $\Delta/\nabla$ ) keys to adjust the input level.



- The adjustment mode is displayed for approximately 20 seconds.
- The input level may be adjusted to any one of three settings: 0dB, -3dB, and -6dB. (The initial setting is 0dB.)

- Press the SOUND key again to return to the input indication.

# Normal playback

## Preparing for playback

Some preparatory steps are needed before starting playback.

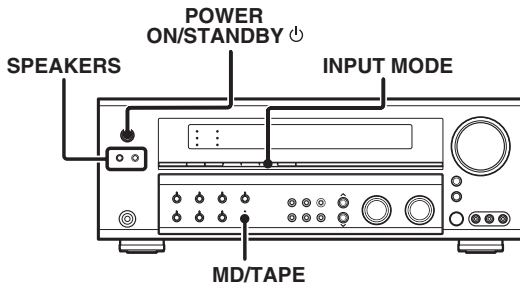

### Turning on the receiver

- 1 Turn on the power to the related components.
- 2 Turn on the power to this receiver by pressing the **POWER ON/STANDBY** key.

### Selecting the input mode

If you have selected a component connected to the **CD/DVD**, **VIDEO 2**, **VIDEO 3** or **DVD/6CH** jacks, make sure that the input mode setting is correct for the type of audio signal to be used. - 8 -

### Selecting MD/TAPE

Select the source name corresponding to the component connected to the MD/TAPE jacks. The initial factory setting is "TAPE". To change the source to "MD", follow the steps below:

**Hold down the MD/TAPE key for more than 2 seconds.**

- The source indication changes to "MD".
- To return to the original indication, repeat the above procedure.

### Selecting the speaker system

Press the **SPEAKERS** keys to select the speaker system to be used.

- A ON** : Sound from the speakers connected to the **SPEAKERS A** terminals on the rear panel.
- B ON** : Sound from the speakers connected to the **SPEAKERS B** terminals on the rear panel. No sound will be heard from the subwoofer.
- A+B ON** : Sound from both the speakers connected to the **SPEAKERS A** and **B** terminals on the rear panel.
- A+B OFF** : No sound from the speakers. Use this setting when listening with headphones for stereo sound in all playback modes. The display segments are different depending on the type of input signal.

The indicator for the speakers you want to use should be lit.

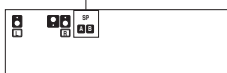

- Selecting "6CH INPUT" by pressing the **INPUT MODE** key, whereby "DVD/6CH" is the input source will cause **SPEAKERS A** to be selected automatically.

## Listening to a source component

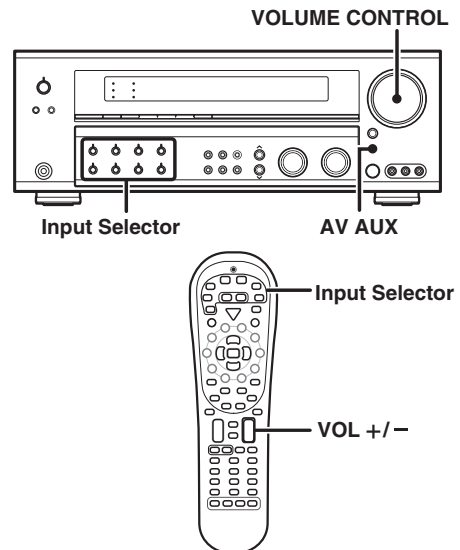

- 1 Use the **Input Selector** and **AV AUX** keys to select the source you want to listen to.

Selecting a source using each key.

- 1 "DVD/6CH"
- 2 "CD/DVD"
- 3 "PHONO"
- 4 "TUNER"
- 5 "VIDEO 1"
- 6 "VIDEO 2"
- 7 "VIDEO 3"
- 8 "MD/TAPE"
- 9 "AV AUX"

- 2 Start playback from the selected source.

- 3 Use the **VOLUME CONTROL** knob or **VOL +/-** keys to adjust the volume.

## Adjusting the sound

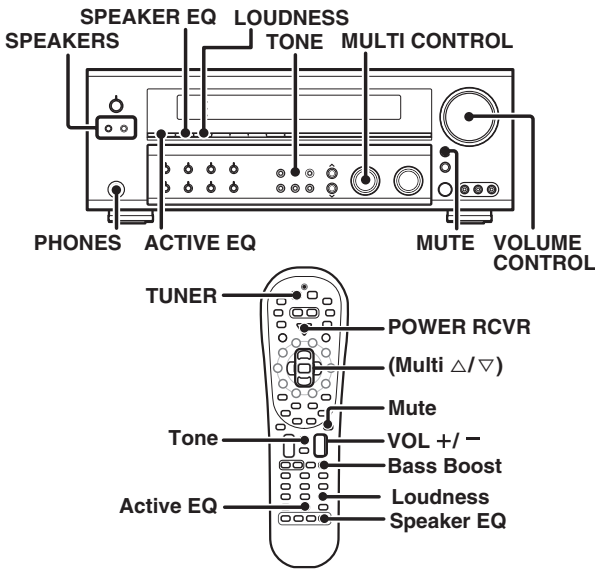

### Adjusting the TONE

You can adjust the sound quality when the receiver is in the PCM stereo and analog stereo mode.

- 1 For the remote control, press and hold the TUNER key for more than 3 seconds to switch to receiver mode.
- 2 Press the TONE key to select the TONE mode.
- 3 Use the MULTI CONTROL knob or Multi (Δ/∇) keys to select TONE ON/OFF.

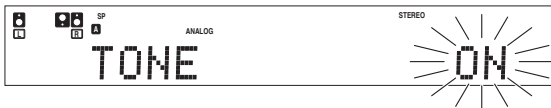

- 4 When in TONE ON selection, press the TONE key for the following displays.

**BASS** : Select this to adjust the low frequency range.  
**TREBLE** : Select this to adjust the high frequency range.

- 5 Use the MULTI CONTROL knob or Multi (Δ/∇) keys to adjust the sound quality.



- The bass and treble levels are adjustable from -10 to +10 in 2 step increments.
- The adjustment item is displayed for approximately 20 seconds.
- This function is available only for speakers connected to FRONT A terminals.

### Once-touch low frequency emphasis (BASS BOOST) (remote control only)

You can adjust the sound quality when the receiver is in the PCM stereo and analog stereo modes.

#### Press the Bass Boost key.

- Press the key once to select the maximum (+10) low frequency emphasis setting.
- This key does not function when the receiver is in the sound quality or ambience effects adjustment mode.
- This function is available only for speakers connected to FRONT A terminals.

### Switching back to the previous setting

Press the Bass Boost key again.

### Adjusting the LOUDNESS mode

You can adjust the Loudness function which controls the low volume settings to maintain the music's richness. The adjustment can be made when the receiver is in the PCM stereo and analog stereo mode.

#### Press the LOUDNESS key to turn the LOUDNESS setting ON.

- This function is available only for speakers connected to FRONT A terminals.

### To cancel

Press the LOUDNESS key again so that the "LOUDNESS" indicator goes off.

### Muting the sound

The MUTE key lets you mute the sound of the speakers.

Press the MUTE key.

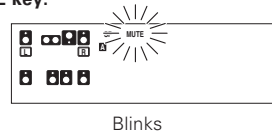

### To cancel

Press the MUTE key again so that the "MUTE" indicator goes off.

- MUTE ON can also be deactivated by turning the VOLUME CONTROL knob or pressing VOL +/- keys.

### ACTIVE EQ mode

You can enjoy a more impressive sound effect when ACTIVE EQ is turned ON.

Press the ACTIVE EQ key for the following selections;

- ① **ACTIVE EQ MUSIC** : Effective when listening to music.  
(The ACTIVE EQ indicator lights up.)
- ② **ACTIVE EQ CINEMA** : Effective when watching a movie.  
(The ACTIVE EQ indicator lights up.)
- ③ **ACTIVE EQ TV** : Effective when watching TV.  
(The ACTIVE EQ indicator lights up.)
- ④ **ACTIVE EQ OFF** : The ACTIVE EQ function is turned OFF.  
(The ACTIVE EQ indicator goes off.)

- "ACTIVE EQ" will scroll from right to left.
- ACTIVE EQ function will not be available when REC MODE, AUTO TUNING or PRESET MEMORY is ON.

### SPEAKER EQ mode

SPEAKER EQ function is to adjust the receiver's audio output characteristics with the speakers' characteristics which differs depending on the size of the speakers. When activating the SPEAKER EQ function, you will be able to enjoy a more natural and dynamic sound experience even with small size speakers.

Press the SPEAKER EQ key to switch the following setting;

- ① **SPEAKER EQ SMALL** : To select a small size speaker.  
(The SPEAKER EQ indicator lights up.)
- ② **SPEAKER EQ MEDIUM** : To select a medium size speaker.  
(The SPEAKER EQ indicator lights up.)
- ③ **SPEAKER EQ OFF** : The SPEAKER EQ function is turned OFF.  
(The SPEAKER EQ indicator goes off.)

- "SPEAKER EQ" will scroll from right to left.
- SPEAKER EQ function will not be available when REC MODE, AUTO TUNING or PRESET MEMORY is ON.
- SPEAKER EQ function will not be available when "LARGE" is selected for Front Speaker at the speaker settings.

### Listening with headphones

- ① Press the **SPEAKERS** keys so that the speaker indicator goes off.

Make sure the SPEAKERS indicators are turned off.

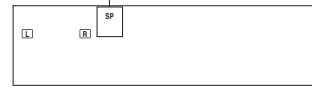

- If you turn off all of the speakers when in surround mode, the surround mode will be canceled as well, resulting in stereo playback.

- ② Connect headphones to the **PHONES** jack.

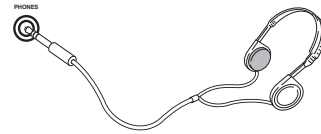

- ③ Use the **VOLUME CONTROL** knob or **VOL +/-** keys to adjust the volume.

# Recording

## Recording audio (analog sources)

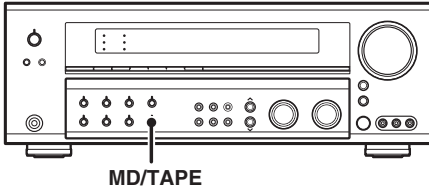

### Recording a music source

- 1 Use the Input Selector keys to select the source (other than "MD/TAPE") you want to record.
- 2 Set the MD or TAPE recorder to record.
- 3 Start playback, then start recording.

## Recording video

- 1 Use the Input selector keys to select the video source (other than "VIDEO 1") you want to record.
- 2 Set the video deck connected to VIDEO 1 to record.
  - Select the REC MODE to record a digital input source.
- 3 Start playback, then start recording.
  - Recording may not be normal for some video software. This is due to the copy guard condition. → 42

## Recording audio (digital sources)

Switch on the **REC MODE** to record a digital input source. Usually use the **REC MODE AUTO** to record audio input sources. When the digital mode changes during recording in the **REC MODE AUTO**, the audio input source may be interrupted momentarily.

### Recording music in REC MODE AUTO or MANUAL

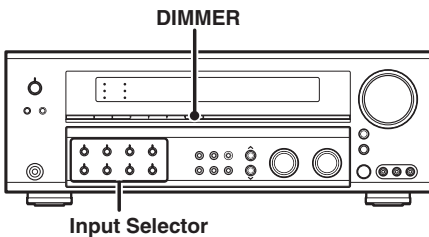

- 1 Use the Input Selector keys to select the source (CD/DVD, DVD/6CH, VIDEO 2, VIDEO 3) you want to record.
- 2 Set the MD or TAPE recorder to record.

- 3 Press and hold the DIMMER key for more than 2 seconds to select the REC MODE AUTO or MANUAL.

- ① **REC MODE off** : The digital input record mode is switched off.
- ② **REC MODE AUTO** : The digital input signals (DTS, Dolby Digital, or PCM) are identified automatically and converted into stereo signals that are ready for recording.
- ③ **REC MODE MANUAL** : The input signal type at the moment this mode is selected is held throughout this mode.

- When the **REC MODE MANUAL** is selected, the digital input signal is converted to stereo signals (down-mix). But once the digital signal is changed to other signal, no signal is output. When the **REC MODE AUTO** is selected, the digital input signal is converted to stereo signals even if the digital signal is changed.

For REC MODE AUTO :

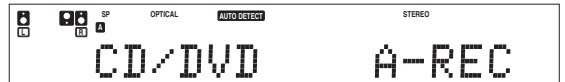

For REC MODE MANUAL :



- 4 Start playback, then start recording.
  - If the audio reproduction stops in the middle due to change in the input signals, etc., press the **DIMMER** key.

# Listening to radio broadcasts

The receiver can store up to 40 stations in the memory and recall them by one-touch operation.

## Tuning radio stations

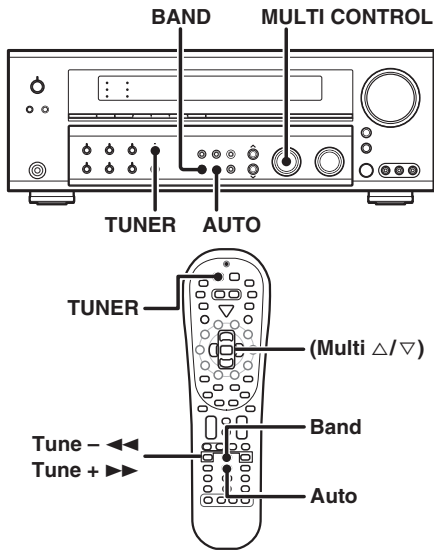

- 1 Use the **TUNER** key to select the tuner.
- 2 Use the **BAND** key to select the desired broadcast band.

Each press switches the band.



- 3 Use the **AUTO** key to select the desired tuning method.

Each press switches the tuning method to either auto or manual tuning.

"AUTO" indicator lights up in the display.



- Normally, set to "AUTO" (auto tuning). If the radio waves are weak and there is a lot of interference, switch to manual tuning. (With manual tuning, stereo broadcasts will be received in monaural.)

- 4 Use the **MULTI CONTROL knob or Multi (Δ/▽) keys, or Tune - ◀/▶ keys to select the station.**

"STEREO" lights when a broadcast is being received in stereo.



"TUNED" is displayed when a station is received.

**Auto tuning** : The next station is tuned automatically.

**Manual tuning** : Turn the knob or use the Multi (Δ/▽) keys to select the desired station.

## Presetting radio stations manually

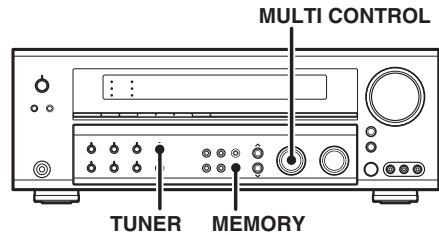

- 1 Tune to the station you want to store.
- 2 Press the **MEMORY** key while receiving the station.

Blinks for 20 seconds

Lights for 20 seconds

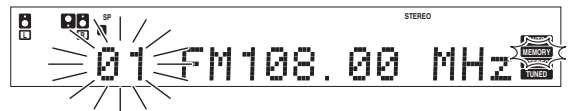

Proceed to step 3 within 20 seconds.  
(If more than 20 seconds elapse, press the MEMORY key again).

- 3 Use the **MULTI CONTROL knob or Multi (Δ/▽) keys to select one of the station presets (1 – 40).**
- 4 Press the **MEMORY** key again to confirm the setting.

- Repeat steps 1, 2, 3, and 4 to store as many stations as necessary.
- If you store a station at a previously used preset, the old station will be replaced by the new one.



## Receiving preset stations

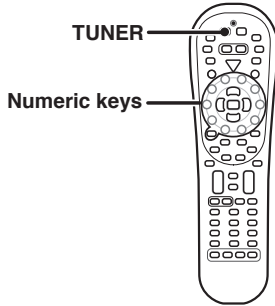

- 1** Press the **TUNER** key to select tuner as the source.
- 2** Enter the number of the preset station you want to receive (up to "40").

Press the Numeric keys in the following order:

For "15", press +10, 5  
 For "20", press +10, +10, 0

- If you make a mistake entering a two digit number, press the **+10** key repeatedly to return to the original display and start again.



## Receiving preset stations in order (P.CALL)

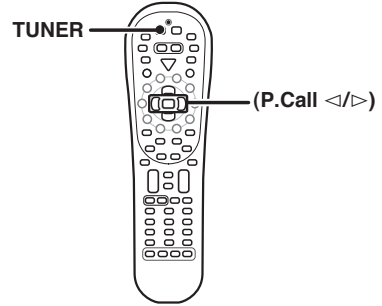

- 1** Press the **TUNER** key to select the tuner as the source.
- 2** Use the **P.Call </>** keys to select the desired station.

- Each time you press the key, another preset station is received in order.

Pressing the P.Call **>** does the following:

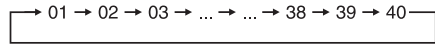

Pressing the P.Call **<** does the following:

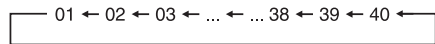

Holding down the **>** or **<** key, lets you skip through the presets, receiving each preset station at 0.5 second intervals.

# Ambience effects

This receiver is equipped with listening modes that allow you to enjoy an enhanced sonic ambience with a variety of video sources.

In order to obtain the optimum effect from the surround modes, make sure to input the proper speaker settings beforehand.



## Surround modes

The below speaker placements are for 5.1 channel surround sound system which are;

- Dolby Digital
- Dolby Pro Logic II
- DTS
- DTS 96/24
- DSP
- DVD 6-channel

The below speaker placements are for 6.1 channel surround sound system which are;

- Dolby Digital EX
- DTS-ES
- NEO:6

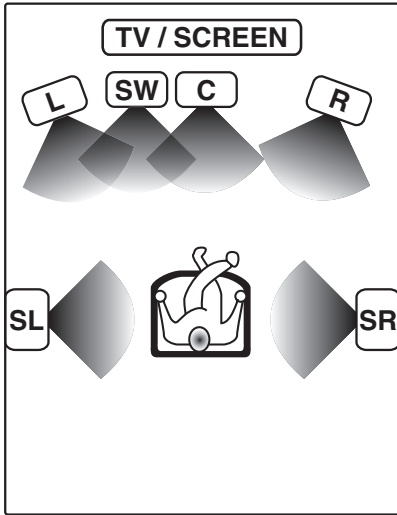

No Surround Back Speaker

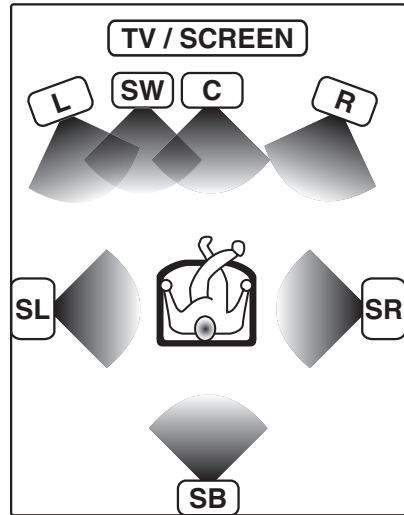

With Surround Back Speaker

The below speaker placements are for 7.1 channel surround sound system which is;

- Dolby Pro Logic IIx

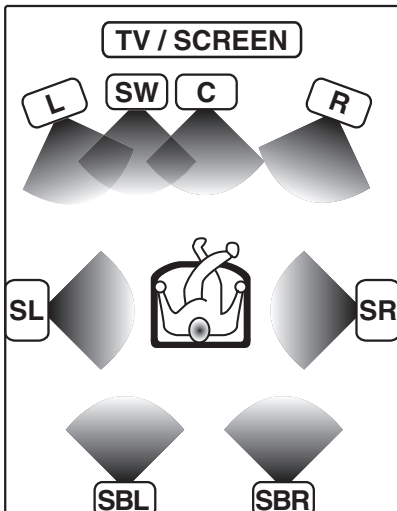

With Surround Back Left and Right Speakers

- |            |                                    |
|------------|------------------------------------|
| <b>L</b>   | <b>Front Left Speaker</b>          |
| <b>SW</b>  | <b>Subwoofer</b>                   |
| <b>C</b>   | <b>Center Speaker</b>              |
| <b>R</b>   | <b>Front Right Speaker</b>         |
| <b>SL</b>  | <b>Surround Left Speaker</b>       |
| <b>SR</b>  | <b>Surround Right Speaker</b>      |
| <b>SB</b>  | <b>Surround Back Speaker</b>       |
| <b>SBL</b> | <b>Surround Back Left Speaker</b>  |
| <b>SBR</b> | <b>Surround Back Right Speaker</b> |

Manufactured under license from Dolby Laboratories. "Dolby", "Pro Logic", "Surround EX" and the double-D symbol are trademarks of Dolby Laboratories.

"DTS", "DTS-ES", "Neo:6" and "DTS 96/24" are trademarks of Digital Theater Systems, Inc.



### Dolby Digital

The Dolby Digital surround format lets you enjoy up to 5.1 channels of digital surround sound from Dolby Digital program sources (such as Laserdisc or DVD software marked ). Compared with previous Dolby surround, Dolby Digital provides even better sound quality, greater spatial accuracy, and improved dynamic range.

### Dolby Digital EX

Dolby Digital EX is an extension of Dolby Digital technology, Dolby Digital EX creates six full-bandwidth output channels from 6.1-channel sources. This is done using a matrix decoder that derives three surround channels from the two in the original recording. This is achieved by using three different surround signals, surround left, surround right, and surround back, each driving its own array of speakers. Think of it as adding a center channel for the rear speakers, which give more diffuse and natural surround effect, even if you wanted the ability to completely encircle the audience with sound, positioning sound effects exactly where they would be heard in real life. For best results, Dolby Digital EX should be used with movie soundtracks recorded with Dolby Digital Surround EX which contain a digital flag that will automatically activate this feature. However, for titles released prior to late 2001, this feature has to be activated manually.

This model lets you enjoy Dolby Digital (and Dolby Surround) program sources, even if you connect only the Front Speakers. However, in order to enjoy the benefit of true 6.1 channel Dolby Digital Surround EX sound or 5.1 channel Dolby Digital Surround sound, KENWOOD recommends that you connect a full set of speakers.

Although only Dolby Digital soundtracks incorporate a separate low frequency channel, connecting a subwoofer will also improve deep bass performance in the other surround modes. The indication "**LFE**" appears in the display when a signal is being input for this channel.

### Dolby PRO LOGIC IIX and Dolby PRO LOGIC II

Dolby Pro Logic II was designed specifically to provide a new sense of spatiality, directionality and articulation of sounds from Dolby Surround encoded sources (such as video and Laserdisc software marked ). This is achieved with an intelligent, built-in feedback logic design, a matrix surround decoding and the decoding of stereo, full bandwidth surround outputs. DOLBY PRO LOGIC IIX enhanced DOLBY PRO LOGIC II's features.

It creates 6.1 channel and 7.1 channel surround sound from stereo or 5.1 channel signals. This feature provides you an astonishing ambience effect which makes you feel you are surrounded by natural sound. Especially 7.1 channel surround sound can produce real back sound from Surround Back speakers.

The PRO LOGIC IIX modes programmed into this model are "MOVIE", "MUSIC" and "GAME". The PRO LOGIC II modes programmed into this model are "MOVIE", "MUSIC", "GAME" and "PRO LOGIC". The "MOVIE" mode has preset characteristics to produce a calibrated, high-level surround sound playback while the "MUSIC" mode has user-adjustable characteristics to offer the three optional controls, like "Dimension", "Center Width" and "Panorama" modes to allow optimization of the soundfields as desired. The "Dimension" control allows the user to gradually adjust the soundfield either towards the front or towards the rear; the "Center Width" control allows various adjustment of the left-center-right speakers' balance; the "Panorama" mode extends the front stereo image to include the surround speakers for an exciting "wraparound" effect with side wall imaging. The "GAME" mode provides surrounded and exciting sound when you enjoy game or TV. Especially in PRO LOGIC IIX "GAME" mode, base sound not only from Front and Center but also from Surround channel is added to Subwoofer. This provides ever more dynamic surround effects.

### DTS

The DTS multi-channel audio format is available on CD, LD and DVD software. DTS is a strictly digital format and cannot be decoded inside most CD, LD or DVD players. For this reason, if you attempt to listen to DTS encoded software through the analog output of your new CD, LD or DVD player, you will experience digital noise in most cases. This noise can be quite loud if the analog output is connected directly to a high power amplification system. Proper measures for playing the digital output as described below should be taken to avoid this situation. To enjoy DTS Digital Surround playback, an external 5.1 channel DTS Digital Surround decoder system or an amplifier with a built-in DTS Digital Surround decoder must be connected to the digital output (S/P DIF, AES/EBU or TosLink) of a CD, LD or DVD player. All models are incorporated with the DTS decoder.

### DTS-ES

DTS-ES (Digital Theater System-Extended Surround) presents 6.1 channels surround system with additional Surround Back channel which evolved from the conventional 5.1 channels surround system. DTS-ES format that was recorded in DVD, CD or LD comprises of two modes. DTS-ES Discrete 6.1 produces the discrete surround back which is completely independent and DTS-ES Matrix 6.1 produces the surround back which synthesised within the left and right surround channels using matrix technology. DTS-ES has perfect compatibility with the conventional 5.1 channels surround system. 6.1 channels surround with an additional surround back presents a more natural presence and surround effects by increasing the impression of the sound image from back. Programs which are recorded using DTS-ES technology consist of information flags which will be able to control the Discrete and Matrix mode. Thus, it can automatically select the best matched mode.

### Neo:6

Neo:6 is a new technology which was developed by DTS. It can produce high grade 6 channels surround with an astonishing fidelity from 2 channels content. Neo:6 has 2 modes, "CINEMA" mode is for movie playback and "MUSIC" mode is for music playback.

### DTS 96/24

DTS 96/24 made it possible to achieve a wide frequency range of over 40 kHz by increasing the sampling frequency to 96 or 88.2 kHz. Moreover, DTS 96/24's ability of 24 bit resolution offers the same frequency band and dynamic range as 96 kHz/24 bit PCM. DTS 96/24 is, as with conventional DTS Surround, compatible with multi-channels. Therefore, sources recorded using DTS 96/24 technologies can be played in high sampling frequency, multi-channel audio with ordinary DVDs and CDs.

DTS has a ".1" or "LFE" channel.

The indication "**LFE**" appears in the display when a signal is being input for this channel.

### Note

**LFE** = Low Frequency Effects. This channel delivers separate non-directional bass signals to the subwoofer for more dynamic deep bass sound effects.

**DSP mode**

The DSP mode lets you add the atmosphere of a live concert or hall to almost any type of program source. These modes are particularly effective when used with stereo program sources, like CD, television, and FM radio. You might enjoy trying the ARENA, JAZZ CLUB, THEATER, STADIUM or DISCO mode the next time you watch a concert or sporting event!

**What's DSP mode?**

DSP stands for Digital Signal Processor. The way a sound is heard in an actual environment depends on a variety of different factors. One of the most important is reverberation (the act of decaying elements of sound echoing in various places). The DSP modes produce the feeling of presence by using the DSP to create reverberation, without spoiling the sound quality of the original signal.



**DVD 6-channel mode**

Using a DVD player or the like equipped with six (5.1) output channels and this model, you can enjoy multi-channel encoded DVD source material in all its splendor. Since the source signals are digital and each channel is input independently, the resulting sound quality, sense of spaciousness, and dynamic range are superb.

The indication "6CH INPUT" appears in the display during DVD 6-channel mode selection.

**Surround play**

The DTS compatible models can reproduce a CD, DVD, or LD carrying the DTS mark.

DOLBY DIGITAL can be used when playing DVD or LD software bearing the  mark and DOLBY DIGITAL format digital broadcasts (etc.). DOLBY PRO LOGIC can be used when playing video, DVD, or LD software bearing the  mark.

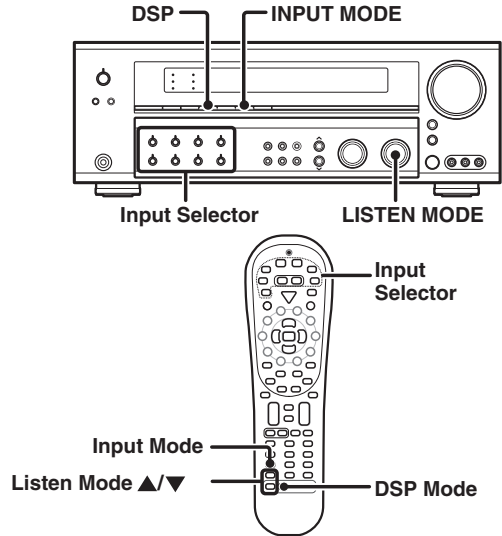

**Preparations**

- Turn ON related components.
- Complete "Preparing for surround sound" (speaker settings). → 17
- Use the **Input Selector** keys to select the component you wish to play back with surround sound.
- Use the **INPUT MODE** key to select the input mode (analog or digital) for the source you wish to play back. → 8
- Noise will be produced when a DTS source is played by selecting the analog input.

**1 Start playing the video software.**

**2 Use the LISTEN MODE knob or Listen Mode ▲/▼ keys to select the listening mode.**

The listening mode settings are stored separately for each input. If the input mode is set to full auto ("AUTO DETECT" lights), the receiver selects the optimal listening mode automatically based on the type of input signal and the speaker settings.

**Each turn of the LISTEN MODE knob or press of the Listen Mode ▲/▼ keys switches the setting as listed below.**

**The listening mode settings are different depending on the type of input signal.**

**Dolby Digital Surround EX compliant disc :**

Dolby Digital Surround EX compliant disc contains identification signals. When you choose **FULL AUTO** during "Input mode settings" (→ 8), this amplifier detects the identification signals and change the LISTEN mode to the **DOLBY DIGITAL EX** (Dolby Digital Surround EX mode) automatically.

But sometimes we find some discs which are Dolby Digital Surround EX compliant disc but it does not contain the identification signals. If you find the notice like "Surround EX" on the label of disc or package, you can choose **DOLBY DIGITAL EX**, then you can enjoy Dolby Digital Surround EX sound.

**When the DOLBY DIGITAL or DOLBY DIGITAL EX signal is input :**

- ① **DOLBY DIGITAL** : DOLBY DIGITAL surround.  
(DOLBY DIGITAL indicator lights up.)
- ② **DOLBY D EX** : DOLBY DIGITAL EX surround.  
(DOLBY DIGITAL indicator lights up.)
- ③ **D+PLIIx MOVIE** : DOLBY DIGITAL+PRO LOGIC IIx surround MOVIE mode.  
(DOLBY DIGITAL and PRO LOGIC indicators light up.)
- ④ **D+PLIIx MUSIC** : DOLBY DIGITAL+PRO LOGIC IIx surround MUSIC mode.  
(DOLBY DIGITAL and PRO LOGIC indicators light up.)
- ⑤ **PLIIx MOVIE** : DOLBY PRO LOGIC IIx surround MOVIE mode.\*  
(DOLBY DIGITAL and PRO LOGIC indicators light up.)
- ⑥ **PLIIx MUSIC** : DOLBY PRO LOGIC IIx surround MUSIC mode.\*  
(DOLBY DIGITAL and PRO LOGIC indicators light up.)
- ⑦ **PLIIx GAME** : DOLBY PRO LOGIC IIx surround GAME mode.\*  
(DOLBY DIGITAL and PRO LOGIC indicators light up.)
- ⑧ **PLII MOVIE** : PRO LOGIC II surround MOVIE mode.\*  
(DOLBY DIGITAL and PRO LOGIC indicators light up.)
- ⑨ **PLII MUSIC** : PRO LOGIC II surround MUSIC mode.\*  
(DOLBY DIGITAL and PRO LOGIC indicators light up.)
- ⑩ **PLII GAME** : PRO LOGIC II surround GAME mode.\*  
(DOLBY DIGITAL and PRO LOGIC indicators light up.)
- ⑪ **PRO LOGIC** : PRO LOGIC II surround PRO LOGIC mode.\*  
(DOLBY DIGITAL and PRO LOGIC indicators light up.)
- ⑫ **STEREO** : Normal stereo playback.  
(DOLBY DIGITAL and STEREO indicators light up.)

(\* This mode can be selected only when 2 channel stereo signal comes in.)

**When you select DOLBY DIGITAL**  
"DOLBY DIGITAL" will be displayed.



**When the DTS or DTS-ES (matrix or discrete) signal is input :**

- ① **DTS-ES Mtrx 6.1** : DTS-ES MATRIX 6.1 channel surround.  
(DTS and MATRIX indicators light up.)
- ② **DTS-ES Dscrt 6.1** : DTS-ES DISCRETE 6.1 channel surround.  
(DTS and DISCRETE indicators light up.)
- ③ **DTS** : DTS 5.1 channel surround.  
(DTS indicator lights up.)
- ④ **DTS+NEO:6 Cin** : DTS+NEO:6 surround CINEMA mode.  
(DTS and NEO:6 indicators light up.)
- ⑤ **NEO:6 CINEMA** : NEO:6 surround CINEMA mode.\*  
(DTS and NEO:6 indicators light up.)
- ⑥ **NEO:6 MUSIC** : NEO:6 surround MUSIC mode.\*  
(DTS and NEO:6 indicators light up.)

- ⑦ **DTS 96/24** : DTS 96/24 playback mode.  
(DTS indicator lights up.)
- ⑧ **STEREO** : Normal stereo playback.  
(DTS and STEREO indicators light up.)

(\* This mode can be selected only when 2 channel stereo signal comes in.)

**When the analog signal or the digital signal (except for DOLBY DIGITAL or DTS signal) is input :**

- ① **PLIIx MOVIE** : PRO LOGIC IIx surround MOVIE mode.  
(PRO LOGIC indicator lights up.)
- ② **PLIIx MUSIC** : PRO LOGIC IIx surround MUSIC mode.  
(PRO LOGIC indicator lights up.)
- ③ **PLIIx GAME** : PRO LOGIC IIx surround GAME mode.  
(PRO LOGIC indicator lights up.)
- ④ **PLII MOVIE** : PRO LOGIC II surround MOVIE mode.  
(PRO LOGIC indicator lights up.)
- ⑤ **PLII MUSIC** : PRO LOGIC II surround MUSIC mode.  
(PRO LOGIC indicator lights up.)
- ⑥ **PLII GAME** : PRO LOGIC II surround GAME mode.  
(PRO LOGIC indicator lights up.)
- ⑦ **PRO LOGIC** : PRO LOGIC II surround PRO LOGIC mode.  
(PRO LOGIC indicator lights up.)
- ⑧ **NEO:6 CINEMA** : NEO:6 surround CINEMA mode.  
(NEO:6 indicator lights up.)
- ⑨ **NEO:6 MUSIC** : NEO:6 surround MUSIC mode.  
(NEO:6 indicator lights up.)
- ⑩ **STEREO** : Normal stereo playback.  
(STEREO indicator lights up.)

• Dolby Digital or DTS signal having more channels than the maximum number of playback channels available using the receiver's current settings is input, downmixing is performed to match the number of available channels.

**3 DSP mode (Digital Signal Processor).**

DSP can produce these effects without spoiling the sound quality of the original music or video source.  
This mode can be selected when digital signals other than DOLBY DIGITAL or DTS, or analog signal come in.

① **Pressing the DSP key or DSP Mode key will display the current DSP MODE status.**

② **Each press of the key will switch to the next status as shown below:**

- ① **ARENA** : DSP surround ARENA mode.
- ② **JAZZ CLUB** : DSP surround JAZZ CLUB mode.
- ③ **THEATER** : DSP surround THEATER mode.
- ④ **STADIUM** : DSP surround STADIUM mode.
- ⑤ **DISCO** : DSP surround DISCO mode.

• The DSP mode selection is displayed for approximately 3 seconds.

**4 Adjust the volume.**

Notes

- Depending on the type of the signal or speaker setting, some listening modes cannot be selected.
- When playback is started, the sound may be cut or interrupted before the input source is confirmed as Dolby Digital.
- To enjoy Dolby Digital surround (as well as all the other listening modes) from a single component, be sure to use a Dolby Digital compatible source component.

## DVD 6-channel playback

Using a DVD player or the like equipped with six (5.1) output channels and the receiver, you can enjoy surround sound playback.  
Connecting a DVD player which can decode the surround signal itself is also acceptable.

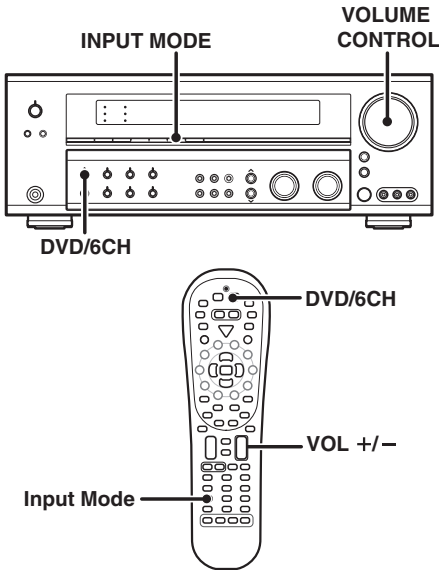

### Preparations

- Connect your DVD player to the DVD/6CH jacks of the receiver.
- Turn on all other components that will be used.
- Complete "Preparing for surround sound".

- 17

- 1 Press "DVD/6CH" as the input source.
- 2 Select "6CH INPUT" by pressing the INPUT MODE key.

- If speaker system B is on when "6CH INPUT" is selected as the input source, it switches off and speaker system A turns on automatically.

- 3 Start playback of the DVD software.

- 4 Adjust the volume.

- It is not possible to adjust the volume level or sound quality (SET UP, SOUND, LISTEN MODE, ACTIVE EQ, SPEAKER EQ, STEREO, DSP, LOUDNESS and TONE key will not be functional) of the channels separately when the receiver is in the 6CH INPUT mode. Adjust the volume with the controls of the DVD player. For the powered subwoofer, you can adjust the volume of the subwoofer using the subwoofer's own volume control.

## Convenient functions

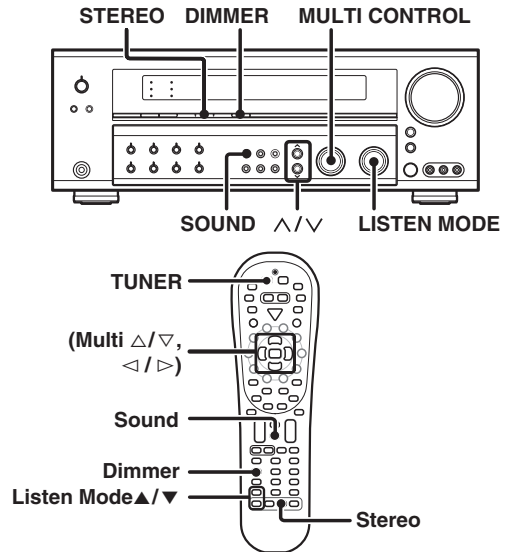

### Adjusting the sound

You can make further adjustments to the sound while listening to playback in the surround mode.

- 1 For the remote control, press and hold the TUNER key for more than 3 seconds to switch to receiver mode.
- 2 Press the SOUND key and then use the  $\Delta/\nabla$  keys or  $\triangle/\triangleright$  keys until the desired item appears in the display.

Each time you press the  $\Delta/\nabla$  keys or  $\triangle/\triangleright$  keys, the menu changes as follows:

Note that some items are not displayed depending on speaker settings and listening modes.

- 1 CNTR (Center speaker level adjustment)\*
- 2 SR (Surround Right speaker level adjustment)\*
- 3 SBR (Surround Back Right speaker level adjustment)\*
- 4 SBL (Surround Back Left speaker level adjustment)\*
- 5 SL (Surround Left speaker level adjustment)\*
- 6 SUBW (Subwoofer level adjustment)\*
- 7 INPUT (Input level adjustment - analog mode only) - 19
- 8 MIDNIGHT (Midnight mode ON/OFF - Dolby Digital and DTS mode only)
- 9 PANORAMA (Panorama mode ON/OFF)\*\*
- 10 DIMENSION (Dimension adjustment)\*\*
- 11 CENTER WIDTH (Center width adjustment)\*\*
- 12 DUAL MONO (Dual Mono selection - Dolby Digital mode only)

\* The adjustment is only temporary for the current input selection. The value will return automatically to the original setup value when the power is turned on/off or when the input selector is changed.

\*\* Pro Logic IIx Music and Pro Logic II Music mode only.

- If you have selected "SB/SW AMP SB", "SBR" and "SBL" are not appeared but "SB" is appeared on the Display.

- 3 Use the MULTI CONTROL knob or Multi ( $\Delta/\nabla$ ) keys to adjust the setting as desired.
  - The adjustment item is displayed for approximately 20 seconds.

### Midnight mode (Dolby Digital and DTS mode only)

When watching movies at night, you might not be able to raise the volume as loud as normal. Midnight mode compresses the dynamic range of previously specified heavy sound passage of the Dolby Digital and DTS sound track (like scenes with sudden increases in volume) to minimize the difference in volume between the scenes with heavy sound passage and scenes with normal sound passage. This makes it easy to hear all of the sound track, even when listening at low volumes.

① Press the **SOUND** key, then press the **^/v** keys or **</>** keys until **"MIDNIGHT"** appears on the display.

- This can be selected only if CD/DVD, DVD/6CH, VIDEO 2 or VIDEO 3 is selected as the source and the input signal is set to "DOLBY DIGITAL" or "DTS".

② Use the **MULTI CONTROL** knob or **Multi (Δ/▽)** keys to select the **ON** or **OFF** setting.



- The adjustment item is displayed for approximately 20 seconds.
- Some Dolby Digital or DTS software may not be compatible with the Midnight mode.

### Panorama mode (Pro Logic IIx Music and Pro Logic II Music mode only)

When listening to music, you will be able to enjoy the "wrap-around" sound effect when you adjust the panorama mode.

① Press the **SOUND** key, then press the **^/v** keys or **</>** keys until **"PANORAMA"** appears on the display.

② Use the **MULTI CONTROL** knob or **Multi (Δ/▽)** keys to select **PANORAMA ON** or **OFF**.

- ① **PANORAMA ON** : PANORAMA mode is ON.
- ② **PANORAMA OFF** : PANORAMA mode is OFF.

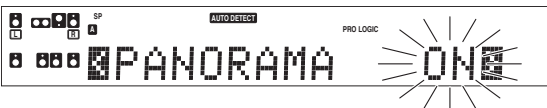

### Dimension mode (Pro Logic IIx Music and Pro Logic II Music mode only)

When listening to music with certain recordings, you will also be able to achieve a suitable balance from all the speakers by adjusting the dimension mode.

① Press the **SOUND** key, then press the **^/v** keys or **</>** keys until **"DIMENSION"** appears on the display.

② Use the **MULTI CONTROL** knob or **Multi (Δ/▽)** keys to adjust the soundfield towards the rear or the front.

Soundfield is adjusted towards the front.

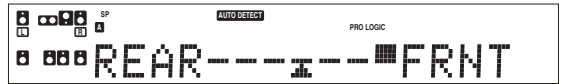

Soundfield is in neutral position.

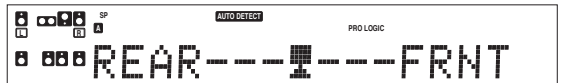

Soundfield is adjusted towards the rear.

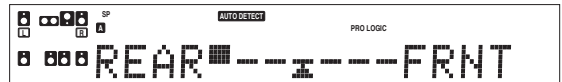

### Center Width mode (Pro Logic IIx Music and Pro Logic II Music mode only)

Center width adjustment allows you to enjoy an enhanced sound when listening to music through center image from only center speaker, or left and right speakers or various combinations adjustments.

① Press the **SOUND** key, then press the **^/v** keys or **</>** keys until **"CENTER WIDTH"** appears on the display.

- The **CENTER WIDTH** indication scrolls across the display.
- When the center speaker is switched OFF, this mode will not be effective.

② Use the **MULTI CONTROL** knob or **Multi (Δ/▽)** keys to adjust the **left-center-right** output.

Center image will be heard from center speaker only.

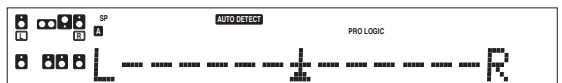

Center image will be heard from left and right speakers only.

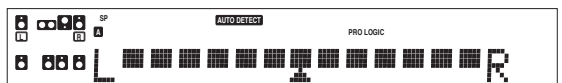

- When in other position, center image from center speaker, left and right speakers can be heard simultaneously with various combinations.

### Dual Mono mode (Dolby Digital mode only)

When the Dolby Digital source have Multiplex sound, you can select Main / Sub sound for Audio output.

➊ Press the **SOUND** key, then press the **▲/▼** keys or **◀/▶** keys until **"DUAL MONO"** appears on the display.

- This can be selected only if CD/DVD, DVD/6CH, VIDEO 2 or VIDEO 3 is selected as the source and the input signal is set to "Dolby Digital."

➋ Use the **MULTI CONTROL** knob or **Multi (▲/▼)** keys for the following selection.

- ➊ **Main** : Multiplex Main channel output.
- ➋ **Sub** : Multiplex Sub channel output.
- ➌ **Main + Sub** : Multiplex Main + Sub channel output.
- ➍ **Stereo** : Main channel from the left speaker. / Sub channel from the right speaker.

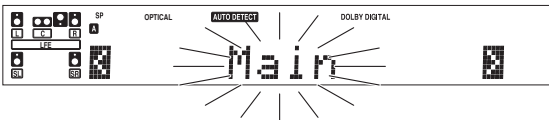

- The adjustment item is displayed for approximately 20 seconds.

### Display dimmer adjustment

The dimmer function lets you select the brightness of the receiver's display. You might find this useful if you darken your room to watch movies or listen to music.

**Each time you press the DIMMER key, the display brightness changes among the three available settings.**

**Select the brightness level you find most pleasing.**

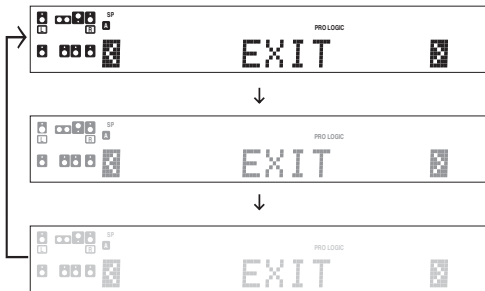

### 96kHz LPCM playback

The receiver is compatible with the 96kHz LPCM playback. To play a 96kHz DVD, set the listen mode other than DSP mode.

- When in **FULL AUTO** input mode and the listen mode is set to DSP mode, the listen mode will automatically be STEREO.
- When in **DIGITAL MANUAL** input mode and the listen mode is set to DSP mode, "96kHz LPCM" will appear in the display and no sound can be heard from the speakers. Use the **LISTEN MODE** knob or **STEREO** key to select STEREO mode to output sound from the speakers.



# Basic remote control operations for other components

The remote control supplied with this receiver is also capable of controlling components from a variety of manufacturers once you register the appropriate setup codes into the remote control unit.

### Low battery warning

Replace all two batteries with new ones when you notice a shortening of the distance from which the remote control will operate. The remote control is designed to retain setup codes in memory while you change batteries.

## Registering setup codes for other components

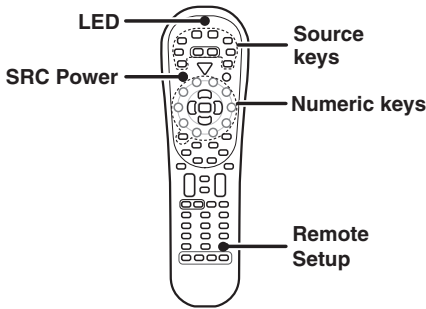

### 1 Find the setup code of the component to be registered.

- Refer to the setup code lists to find the setup code for the component to be registered. - 35
- Example: To register a DVD made by KENWOOD, you would enter "0534".

Input jack	Component	Maker	Code	Key
DVD/6CH	DVD player	KENWOOD	0534	DVD 6CH

Source key	Other components
TUNER	Receiver (KENWOOD)
DVD/6CH	DVD
CD/DVD	CD and MD (KENWOOD)
MD/Tape	Cassette deck (KENWOOD)
VID1 / AV AUX	VCR and PVR
VID2	Cable and DTV decoder
VID3	DSS
PHONO	Additional key for re-assigning
TV	TV/VCR combo, TV/DVD combo, TV

### 2 Press the source keys (DVD/6CH, CD/DVD, VID1, VID2, VID3, TV, MD/TAPE, AV AUX, PHONO). - 34

- PHONO key has to be re-assigned to another key before a setup code can be registered. - 34
- While in Tuner mode, setup code function will not be available.

### 3 Press and hold the Remote Setup key until the LED blinks twice, then release the Remote Setup key.

### 4 Press the Numeric key to enter the four-digit code for the component to be registered.

- If performed correctly, the LED will blink twice.
- Point the remote control at the component and press SRC Power key once. It should turn on/off but if it does not, repeat step 2 to 4
- If the component still does not work, try searching for the code.

### 5 Repeat steps 2 to 4 to register additional components until all components have been registered.

#### Note

Although each setup code is designed to work with a number of different models, certain codes may not work with some models. (Also, certain codes may only operate some of the functions available on a given model.)

## Searching for your codes

If your component does not respond after trying all the codes listed for your component, or if your component is not listed at all, try searching for your code.

For example, to search for code for your TV:

### 1 Press the TV key once. Next, press and hold the Remote Setup key until the LED blinks twice, then release the Remote Setup key.

### 2 Press the Numeric key to enter 9, 9, 1.

- The LED will blink twice.

### 3 Point the remote control at the TV and slowly alternate between pressing the SRC Power and TV keys.

- Stop when the TV turns on or off.
- In the search mode, the remote control will send IR codes from its library to the selected device, starting with the most popular code first.

### 4 Press the Remote Setup key once to lock in the code.

### 5 To search for the codes of your other components, repeat steps 1 through 4, but substitute the appropriate key (i.e., DVD/6CH, CD/DVD, VID1, VID2, VID3, TV, MD/TAPE, AV AUX, PHONO).

- PHONO key has to be re-assigned to another key before a setup code can be programmed.

## Checking the codes

If you have setup the remote control using the procedures described in "Searching for your codes", you may need to find out which four-digit code is operating your equipment:

For example, to find out which code is operating your TV:

**1** Press the TV key once. Next, press and hold the Remote Setup key until the LED blinks twice, then release the Remote Setup key.

**2** Press the Numeric key to enter **9**, **9**, **0**.

- The LED will blink twice.

**3** To view the code for the first digit, press "1" once. Wait for 3 seconds, counts the number of times the LED blinks (e.g., blinks=3) and write down that number.

- If a code digit is "0", the LED will not blink.

**4** Repeat step 3 three more times for the remaining digits. Use "2" for the second digit, "3" for the third digit, and "4" for the fourth digit.

**5** To check the codes of your other components, repeat steps 1 through 4, but substitute the appropriate key (i.e., DVD/6CH, CD/DVD, VID1, VID2, VID3, TV, MD/TAPE, AV AUX, PHONO) for the component you are checking.

- As suggested earlier on, write down each of the four-digit code.
- PHONO key has to be re-assigned to another key before a setup code can be programmed.

## Re-assigning device keys

The remote control can be setup to control second TV or VCR, or any combination of eight home entertainment components.

For example, to control the operation of two different VCR using the remote control, the user need to re-assign the unused VID2 key to operate the second VCR(VID1) as follows:

**1** Press and hold the Remote Setup key until the LED blinks twice, then release the Remote Setup key.

**2** Press the Numeric key to enter **9**, **9**, **2**.

- The LED will blink twice.

**3** Press VID1 key once, then press the VID2 key once.

- The user now can operate VID2 as a second VCR along with VID1.
- Refer to the table in the previous page for the combination of source keys and the other components assignment. - 39

**4** To re-assign other device keys, repeat steps 1 through 3 by substituting the key sequence from the below chart for the most popular components:

To re-assign key

Sequence	Perform
TV as 2nd VID1 key	Remote Setup 9 9 2 VID1 TV
TV as 2nd VID2 key	Remote Setup 9 9 2 VID2 TV
TV as 2nd CD/DVD key	Remote Setup 9 9 2 CD/DVD TV
TV as 2nd TV key	Remote Setup 9 9 2 TV TV
VID1 as 2nd TV key	Remote Setup 9 9 2 TV VID1
VID1 as 2nd VID2 key	Remote Setup 9 9 2 VID2 VID1
VID1 as 2nd CD/DVD key	Remote Setup 9 9 2 CD/DVD VID1
VID1 as 2nd VID1 key	Remote Setup 9 9 2 VID1 VID1

**5** To clear the re-assignment and reset the remote control to its original operation mode:

**1** Press and hold the Remote Setup key until the LED blinks twice, then release the remote setup key.

**2** Press the Numeric key to enter **9**, **9**, **2**.

**3** Press VID2 key twice.

- When a re-assignment is done, the LED will blink twice to confirm your choice. At that time, you will need to program the remote control in order to control the new component.
- If an invalid key sequence is entered, the LED blink once and return to normal operation.
- When in Tuner mode, re-assignment is not available.

## Operating other components

This operation lets you operate the registered components.

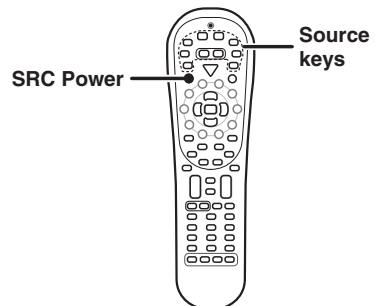

**1** Use the source keys to select the component you desire.

- Pressing the source keys also changes the input selector on the receiver.

**2** Press the SRC Power key.

- To return to the receiver operation mode, press the TUNER key for more than 3 seconds.

**3** Press the operation keys you desire. - 39

The remote control mode remains at the selected input. If you wish to operate another component, repeat step 2 or 3.

### Resetting the Remote control

- To initialize the remote control, press the Remote Setup key until the LED blinks twice. Then press the Numeric key to enter **9**, **8**, **1**. The LED will blink twice.

## Setup code chart

### VCR setup codes

Maker	Setup Codes
Admiral	0048, 0209
American High	0035
Bell & Howell	0104
Broksonic	0121, 0184, 0209
Canon	0035
Carver	0081
Craig	0047
Curtis Mathes	0035, 0060, 0162, 0760
Daewoo	0045
Denon	0042
Emerex	0032
Emerson	0043, 0121, 0184, 0209
Fisher	0047, 0104
Fuji	0033, 0035
GE	0035, 0060, 0760
HI-Q	0047
Harman/Kardon	0081
Hitachi	0042
Hughes Network Systems	0042
JVC	0067
Kenwood	0067
Kodak	0035
MEI	0035
MGA	0043
Magnavox	0035, 0039, 0081, 0563
Marantz	0035, 0081
Matsushita	0035, 0162
Memorex	0035, 0039, 0047, 0048, 0104, 0162, 0209
Minolta	0042
Mitsubishi	0043, 0067
Motorola	0035, 0048
NEC	0067, 0104
Olympus	0035
Optimus	0048, 0104, 0162, 1048, 1062
Orion	0184, 0209
Panasonic	0035, 0162, 0225, 0616, 1062
Penney	0035, 0042
Pentax	0042
Philco	0035, 0209
Philips	0035, 0081, 0618, 1081, 1181
Pioneer	0067
Polk Audio	0081
Proscan	0060, 0760
Pulsar	0039
Quasar	0035, 0162
RCA	0042, 0060, 0760
Realistic	0035, 0047, 0048, 0104
ReplayTV	0614, 0616
Runco	0039
STS	0042
Samsung	0045
Sanky	0039, 0048
Sansui	0067, 0209

Maker	Setup Codes
Sanyo	0047, 0104
Scott	0043, 0045, 0121, 0184
Sears	0035, 0042, 0047, 0104
Semp	0045
Sharp	0048
Sonic Blue	0614, 0616
Sony	0032, 0033, 0035, 0636, 1032
Sylvania	0035, 0043, 0081
Technics	0035, 0162
Teknika	0035
Tivo	0618, 0636
Toshiba	0043, 0045
Vector	0045
Video Concepts	0045
Wards	0035, 0042, 0047, 0048, 0060, 0081, 0760
White Westinghouse	0209
XR-1000	0035
Zenith	0033, 0039, 0209

### Cable setup codes

Maker	Setup Codes
ABC	0003, 0008, 0014, 0017
Americast	0899
Bell & Howell	0014
Bell South	0899
Director	0476
General Instrument	0003, 0276, 0476, 0810
GoldStar	0144
Hamlin	0009, 0273
Jerrold	0003, 0012, 0014, 0276, 0476, 0810
Memorex	0000
Motorola	0276, 0476, 0810, 1106
Pace	0237
Panasonic	0000, 0107
Paragon	0000
Philips	0305, 0317
Pioneer	0144, 0533, 0877, 1877
Pulsar	0000
Quasar	0000
Regal	0273, 0279
Runco	0000
Samsung	0144
Scientific Atlanta	0008, 0017, 0477, 0877, 1877
Sony	1006
Starcom	0003
Supercable	0276
Tocom	0012
Torx	0003
Toshiba	0000
Zenith	0000, 0525, 0899

## Setup code chart

### TV setup codes

Maker	Setup Codes
AOC	0019, 0030
Admiral	0093, 0463
Adventura	0800
Aiko	0092
Aiwa	0701, 0800, 0802
Akai	0030
Alaron	0179
America Action	0180
Ampro	0751
Anam	0180
Apex Digital	0748, 0765, 0767
Asha	0804
Audiovox	0092, 0180, 0451, 0623, 0802
Baysonic	0180
Belcor	0019
Bell & Howell	0016, 0154
Beaumarck	0804
Bradford	0180
Brockwood	0019
Broksonic	0236, 0463, 0817, 0901
CXC	0180
Calix	0802
Candle	0030, 0056
Carnivale	0030
Carver	0054
Celebrity	0000
Changhong	0765
Cineral	0092, 0451
Citizen	0030, 0056, 0060, 0092, 0802, 0816
Concerto	0056
Contec	0180
Craig	0180, 0802, 0804
Crosley	0054
Crown	0180
Curtis Mathes	0016, 0030, 0047, 0054, 0056, 0060, 0093, 0145, 0154, 0166, 0451, 0466, 0747, 0809, 1147, 1347
Cybernex	0804
Daewoo	0019, 0092, 0451, 0623, 0816
Daytron	0019
Denon	0145
Dumont	0017, 0019
Dynatech	0800
Dwin	0720, 0774
Electroband	0000
Electrohome	0802
Electroponic	0802
Emerson	0019, 0154, 0178, 0179, 0180, 0236, 0463, 0623, 0800, 0802, 0816, 0817
Envision	0030
Fisher	0154
Fujitsu	0179, 0683
Funai	0171, 0179, 0180, 0800
Futuretech	0180
Garrard	0800

Maker	Setup Codes
GE	0021, 0047, 0051, 0178, 0251, 0451, 0747, 0804, 0807, 0809, 0811, 1147, 1347
Gibraltar	0017, 0019, 0030
GoldStar	0019, 0030, 0178, 0802, 0814
Gradiente	0053, 0056, 0800
Grunpy	0179, 0180
Hallmark	0178
Harley Davidson	0179, 0800
Harman/Kardon	0054
Harvard	0180
Havermy	0093
Hitachi	0016, 0056, 0145, 0800
Infinity	0054
Inteq	0017
JBL	0054
JCB	0000
JVC	0053
KEC	0180, 0802
KTV	0030, 0180
Kenwood	0019, 0030
Kodak	0802
Konka	0632, 0628, 0638, 0703, 0707
LG	0056
LXI	0047, 0054, 0154, 0156, 0178, 0747, 0802
Logik	0016
Luxman	0056
Lloyd's	0800
MGA	0019, 0030, 0150, 0178, 0804
MTC	0019, 0030, 0056, 0060, 0800, 0804
Magnavox	0030, 0054, 0179, 0800, 0818, 1254, 1454
Magnasonic	0816
Magnin	0804
Majestic	0016
Marantz	0030, 0054
Marta	0802
Matsushita	0250
Megatron	0145, 0178
Memorex	0016, 0150, 0154, 0178, 0179, 0250, 0463, 0800, 0802, 0804, 0810, 0812, 0814, 0815
MGN Technology	0804
Midland	0017, 0047, 0051, 0747
Minutz	0021
Mitsubishi	0019, 0093, 0150, 0178, 0807
Motorola	0093
Multitech	0180, 0800
NAD	0156, 0166, 0178
NEC	0019, 0030, 0056, 0497
NTC	0092
Nikko	0030, 0092, 0178, 0802
Noblex	0804
Onwa	0180
Optimus	0154, 0166, 0250, 0802, 0812, 0815
Optonica	0093

## Setup code chart

Maker	Setup Codes
Orion	0179, 0236, 0463, 0817
Panasonic	0051, 0250, 0809, 0812, 0815, 0907, 0908
Penney	0019, 0021, 0030, 0047, 0051, 0060, 0156, 0178, 0747, 0802, 0804, 0809, 0814, 1347
Philco	0019, 0030, 0054, 0145, 0463
Philips	0054, 0904, 1454
Pilot	0019, 0030, 0802
Pioneer	0166, 0679
Portland	0019, 0092
Princeton	0717
Prism	0051
Proscan	0047, 0747, 0811
Profitronic	0804
Proton	0178, 0466
Pulsar	0017, 0019
Quasar	0051, 0250, 0809, 0812
RCA	0019, 0047, 0090, 0679, 0747, 0804, 0807, 0809, 0811, 0905, 1047, 1147, 1247, 1347, 1447, 1547
RadioShack	0019, 0030, 0047, 0056, 0154, 0178, 0180, 0747, 0800, 0810
Radix	0802
Randex	0802
Realistic	0019, 0030, 0056, 0154, 0178, 0180, 0800, 0802
Runco	0017, 0030, 0251, 0497, 0603
SSS	0019, 0180
Sampo	0030
Samsung	0019, 0030, 0056, 0060, 0178, 0766, 0804
Sansei	0451
Sansui	0463, 0800, 0817, 0901
Sanyo	0154, 0804
Scimitsu	0019
Scotch	0178
Scott	0019, 0178, 0179, 0180, 0236
Sears	0047, 0054, 0056, 0154, 0156, 0171, 0178, 0179, 0747, 0800, 0802, 0814
Semivox	0180
Semp	0156
Sharp	0093, 0688, 0689, 0807, 0900
Shogun	0019, 0804
Signature	0016
Sony	0000, 0800, 0813
Soundesign	0178, 0179, 0180
Squareview	0171
Starlite	0180
Supreme	0000
Sylvania	0030, 0054, 0171, 0800, 0818, 0903
Symphonic	0171, 0180, 0800
TMK	0056, 0178, 0804
TNCi	0017
Tandy	0093
Teac	0800
Technics	0051, 0250
Technol Ace	0179

Maker	Setup Codes
Techwood	0051, 0056
Teknika	0016, 0019, 0054, 0056, 0060, 0092, 0150, 0179, 0180, 0800, 0802
Telefunken	0056
Thomas	0800
Toshiba	0060, 0154, 0156, 0901, 0906, 1256
Totevision	0802, 0804
Unitech	0804
Vector Research	0030
Victor	0053
Videomagic	0802
Vidikron	0054, 0242
Vidtech	0019, 0178
Videosonic	0804
Villian	0800
Wards	0016, 0019, 0021, 0030, 0054, 0056, 0178, 0179, 0800, 0804
Waycon	0156
White Westinghouse	0463, 0623, 0816
XR-1000	0800
Yamaha	0019, 0030, 0769
Zenith	0016, 0017, 0092, 0463, 0800, 0817

### DSS setup codes

Maker	Setup codes
Alpha Star	0772
Chaparral	0216
Crossdigital	1109
Dishpro	0775, 1005
Echostar	1005, 0775
Expressvu	0775
GE	0566
GOI	0775
General Instrument	0869
HTS	0775
Hitachi	0819
Hughes Network System	0749, 1749, 1142
JVC	0775
Magnavox	0722, 0724
Memorex	0724
Mitsubishi	0749
Motorola	0869
Next Level	0869
Panasonic	0247, 0701
Paysat	0724
Philips	1076, 1142, 0722, 0724, 0749, 1749
Proscan	0392
RCA	0566, 0392, 0143, 0855
RadioShack	0869
SKY	0856
Samsung	1109
Sony	0639
Star Choice	0869
Toshiba	0749, 0790, 1749
Uniden	0724, 0722
Zenith	0856, 1856

## Setup code chart

### DVD player Setup codes

Maker	Setup Codes
Aiwa	0641
Apex Digital	0672, 0717, 0755, 0794, 0795, 0796, 0797, 0830
Blue Parade	0571
DVD2000	0521
Daewoo	0784
Denon	0490, 0634
Emerson	0591
Enterprise	0591
Fisher	0670
GE	0522, 0717, 0815
GPX	0769
Go Video	0715
Gradiente	0651
Greenhill	0717
Harman/Kardon	0582, 0702
Hitachi	0573, 0664
Hiteker	0672
JBL	0702
JVC	0558, 0623
KLH	0717
Kenwood	0490, 0534, 0682
Konka	0711
Koss	0651
Magnavox	0503, 0675
Marantz	0539
Microsoft	0522
Mintek	0717
Mitsubishi	0521
Nesa	0717
Onkyo	0503
Oritron	0651
Panasonic	0490, 1490
Philips	0503, 0539, 0646
Pioneer	0525, 0571
Polk Audio	0539
Proscan	0522
RCA	0522, 0571, 0717
Rowa	0823
Sampo	0698
Samsung	0573
Sanyo	0670
Shinsonic	0533
Sony	0533
Sylvania	0675
Technics	0490
Theta Digital	0571
Toshiba	0503
Urban Concepts	0503
Yamaha	0490, 0539, 0545
Zenith	0503, 0591

### DTV decoders setup codes

Maker	Setup Codes
Panasonic	1120
Pioneer	1010
Princeton	0113, 0295
Samsung	1190
Sensory Science	1126
Sharp	1010

### Cassette deck Setup codes

Maker	Setup Codes
Kenwood	0070, 0071, 0092, 0183, 0205, 0233, 0234, 0251, 0386

### CD and MD players setup codes

Maker	Setup Codes
Kenwood	0028, 0037, 0190, 0338, 0339, 0340, 0523, 0626, 0677, 0681, 0826, 0858, 0859, 1490

## CASSETTE deck, CD player & MD recorder operations

Refer to the following for the type of remote control operations available for each component.

- ❶ Select the input source.
- ❷ Press the keys corresponding to the operations you desire. Refer to the following sections for details.

- When pressing keys in succession, press each key firmly and be sure to wait at least 1 second before pressing the next key.
- Numeric keys function the same as the numeric keys on the original remote.

These keys can be used to perform the basic operations of KENWOOD and other manufacturers' components which the setup code for each component had been entered beforehand.

### Cassette deck operations keys

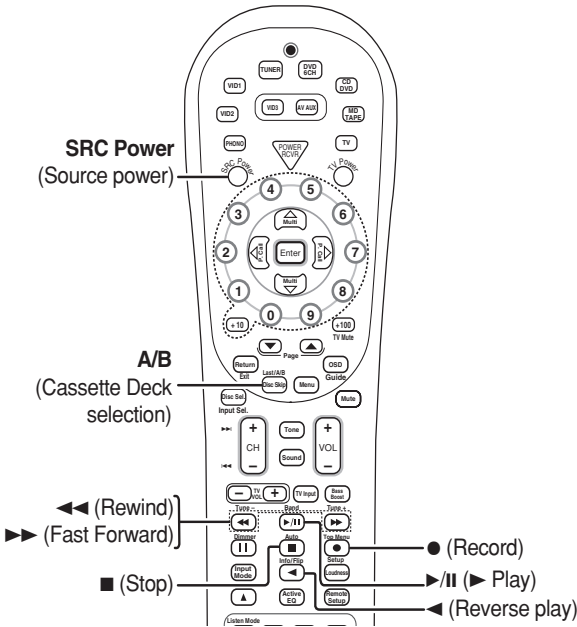

### CD player operation keys

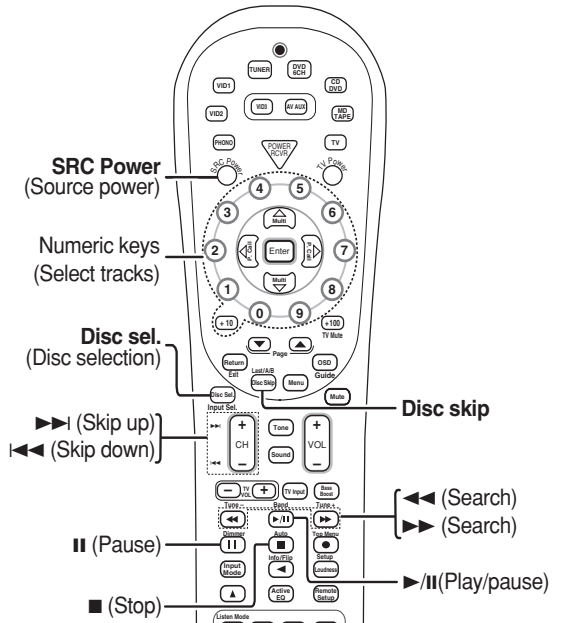

### MD recorder operation keys

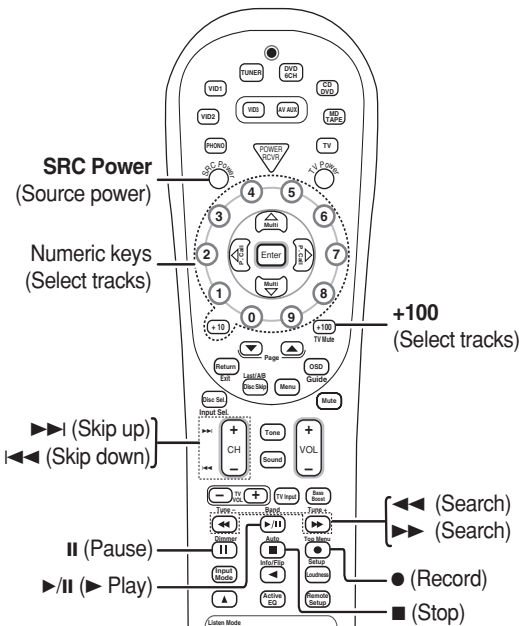

## Other components' operations

Refer to the following for the type of remote control operations available for each component.

### TV operation keys

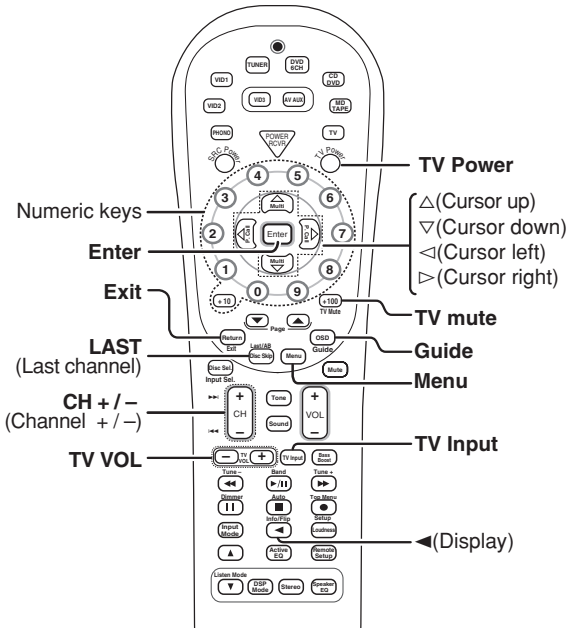

### VCR operation keys

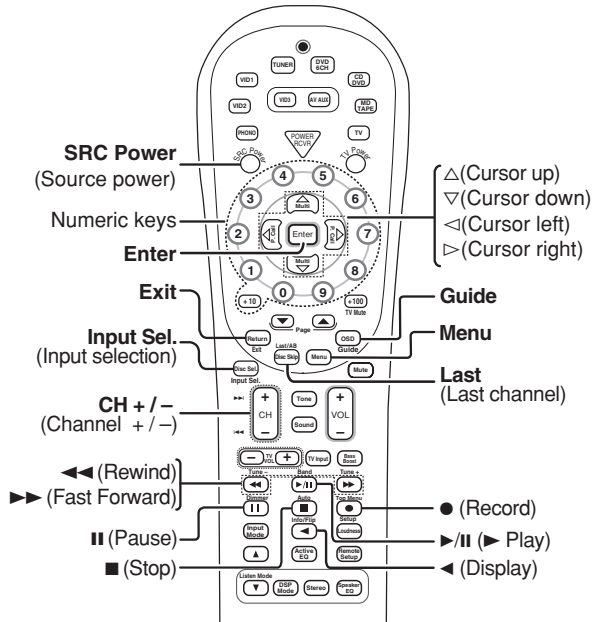

### DVD Player operation keys

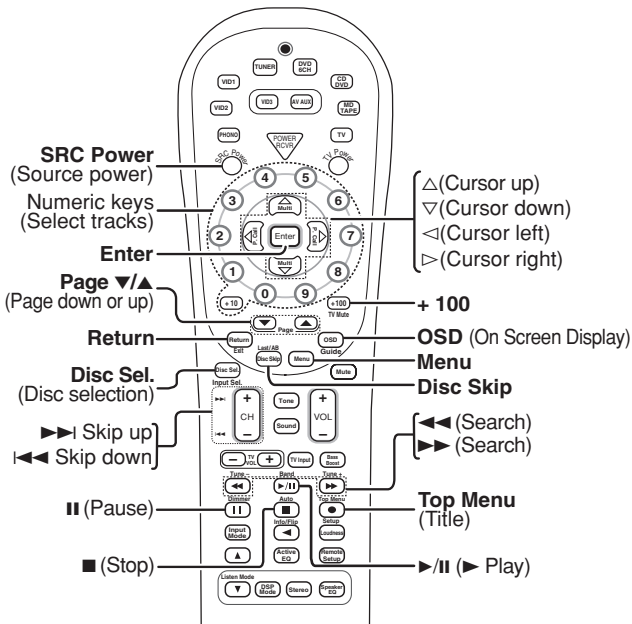



## Basic remote control operations for other components

Refer to the following for the type of remote control operations available for each component.

### DSS operation keys

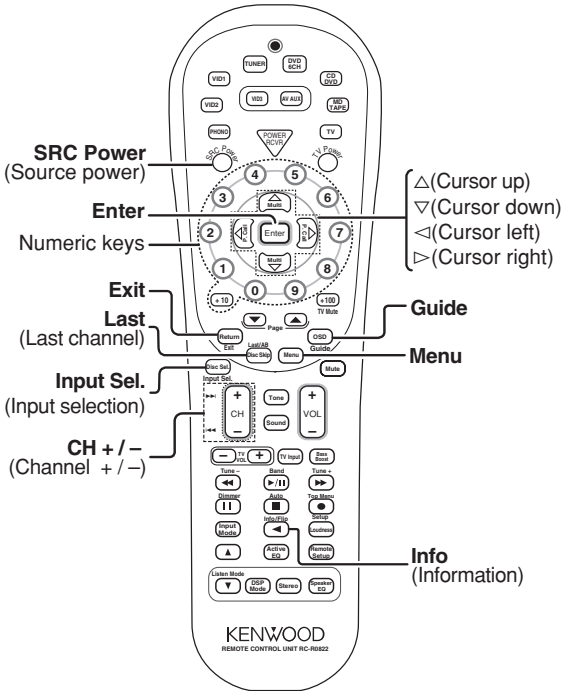

### Cable operation keys

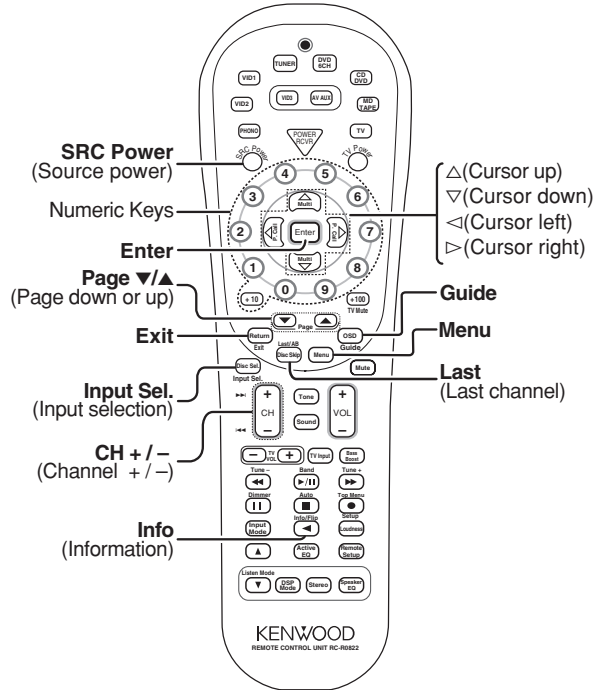

#### Notes

1. Certain codes may only operate some of the function available on a given model.
2. The above show the typical type functions available for each component. Some manufacturers use different key combinations to perform similar functions. For that reason, we have programmed extra functions on some of the unused number keys to help you control your equipment.

## Resetting the Microcomputer

The microcomputer may malfunction (unit cannot be operated, or shows an erroneous display) if the power cord is unplugged while the power is ON, or due to some other external factor. If this happens, execute the following procedure to reset the microcomputer and return the unit to its normal operating condition.

**Unplug the power cord from the wall outlet, then plug it back in while holding down the POWER ON/STANDBY key.**

- Please note that resetting the microcomputer will clear the contents of the memory and returns the unit to the state it was in when it left the factory.

## Amplifier

Symptom	Cause	Remedy
No sound from the speakers.	<ul style="list-style-type: none"> <li>• The speaker cords are disconnected.</li> <li>• VOLUME is set to the minimum position.</li> <li>• MUTE is ON.</li> <li>• The SPEAKERS switches are set to OFF.</li> </ul>	<ul style="list-style-type: none"> <li>• Connect them properly referring to "Connecting the speakers" → [15]</li> <li>• Adjust the volume to a proper level.</li> <li>• Turn OFF the MUTE. → [21]</li> <li>• Set the SPEAKERS switches to ON. → [20]</li> </ul>
The standby indicator blinks and sound is not output.	<ul style="list-style-type: none"> <li>• Speaker cords are short-circuited.</li> </ul>	<ul style="list-style-type: none"> <li>• Turn the power off, eliminate the short-circuiting, then turn on the power again.</li> </ul>
Sound is not output from one of the speakers.	<ul style="list-style-type: none"> <li>• The speaker cord is disconnected.</li> <li>• The speaker is not set up correctly.</li> </ul>	<ul style="list-style-type: none"> <li>• Connect it properly referring to "Connecting the speakers". → [15]</li> <li>• Set it up properly referring to "Speaker settings". → [17]</li> </ul>
Sound is not output from the surround speakers and / or the center speaker, or their sound is very small.	<ul style="list-style-type: none"> <li>• The surround speaker cords and/or the center speaker cord is disconnected.</li> <li>• The speaker is not set up correctly.</li> <li>• A surround mode has not been engaged.</li> <li>• The surround and/or center volume controls are set to the minimum level.</li> </ul>	<ul style="list-style-type: none"> <li>• Connect it properly referring to "Connecting the speakers". → [15]</li> <li>• Set it up properly referring to "Speaker settings". → [17]</li> <li>• Select a surround mode.</li> <li>• Adjust the speaker levels using the test tone. → [18]</li> </ul>
A humming noise is generated when the PHONO input selector is selected.	<ul style="list-style-type: none"> <li>• The audio cord from the record player is not connected to the PHONO jacks.</li> <li>• The record player is not grounded.</li> </ul>	<ul style="list-style-type: none"> <li>• Insert the audio cord plugs securely into the PHONO jacks.</li> <li>• Connect the grounding wire to the GND terminal on the rear panel.</li> </ul>
When playing a Dolby Digital source signal using a DVD player, the sound is cut off soon after it starts.	<ul style="list-style-type: none"> <li>• There are many possible causes for this problem, depending on the type of DVD player used.</li> </ul>	<ul style="list-style-type: none"> <li>• Set the input mode to digital manual before starting playback of the Dolby Digital source. → [8]</li> </ul>
No sound is produced during playback from a DVD player.	<ul style="list-style-type: none"> <li>• The input mode is set to digital manual.</li> </ul>	<ul style="list-style-type: none"> <li>• Press the INPUT MODE key to select to full auto mode. → [8]</li> </ul>
A video source cannot be recorded normally.	<ul style="list-style-type: none"> <li>• The software is copy-guarded.</li> </ul>	<ul style="list-style-type: none"> <li>• Copy-guarded video software cannot be recorded.</li> </ul>

## Tuner

Symptom	Cause	Remedy
Radio stations cannot be received.	<ul style="list-style-type: none"> <li>• No antenna is connected.</li> <li>• The broadcast band is not set properly.</li> <li>• The frequency of the desired station is not tuned.</li> </ul>	<ul style="list-style-type: none"> <li>• Connect an antenna. → [16]</li> <li>• Set the broadcast band properly.</li> <li>• Tune the frequency of the desired station. → [24]</li> </ul>
Interference.	<ul style="list-style-type: none"> <li>• Noise due to ignition noise from an automobile.</li> <li>• Noise due to interference from an electric appliance.</li> <li>• Noise due to a nearby TV set.</li> </ul>	<ul style="list-style-type: none"> <li>• Install the outdoor antenna away from the road.</li> <li>• Turn off the power to the appliance.</li> <li>• Install the receiver farther away from the TV.</li> </ul>
A station which was preset cannot be received by pressing the corresponding numeric key.	<ul style="list-style-type: none"> <li>• The preset station belongs to a frequency that cannot be received.</li> <li>• The preset memory was cleared because the power cord had been unplugged for a long period of time.</li> </ul>	<ul style="list-style-type: none"> <li>• Preset a station with a receivable frequency.</li> <li>• Preset the station again.</li> </ul>

**Remote control unit**

Symptom	Cause	Remedy
<b>Certain inputs cannot be selected using the remote control.</b>	<ul style="list-style-type: none"> <li>• No setup codes registered for the respective input(s).</li> </ul>	<ul style="list-style-type: none"> <li>• Register a setup code at the respective input(s). → <a href="#">35</a></li> </ul>
<b>Remote control operation is not possible.</b>	<ul style="list-style-type: none"> <li>• The remote control is set to a different operation mode.</li> <li>• Batteries are exhausted.</li> <li>• The remote control unit is too far away from the main system, controlling angle is too large, or there is an obstacle between the receiver and the remote.</li> <li>• No tape or CD is placed in the source component.</li> <li>• An attempt is made to play a tape which is being recorded in the cassette deck.</li> <li>• The remote control has not been set to the operation mode for the component you wish to control.</li> </ul>	<ul style="list-style-type: none"> <li>• Press any of the <b>Input Selector</b> keys to select the appropriate operation mode.</li> <li>• Replace with new batteries.</li> <li>• Operate the remote control unit within the controllable range.</li> <li>• Place the tape or CD in the source component which you want to play.</li> <li>• Wait until recording has completed.</li> <li>• Press any of the source keys or <b>SRC Power</b> key to activate the operation mode for the component you want to control before operation. → <a href="#">34</a></li> </ul>

## AUDIO section

Rated power output during STEREO operation

100 watts per channel minimum RMS, both channels driven, at 8 Ω from 20 Hz to 20 kHz with no more than 0.09% total harmonic distortion. (FTC)

Effective power output during SURROUND operation

FRONT (20 ~ 20 kHz, 0.09 % T.H.D. at 8 Ω one channel driven)	100 W + 100 W
CENTER (20 ~ 20 kHz, 0.09 % T.H.D. at 8 Ω one channel driven)	100 W
SURROUND (20 ~ 20 kHz, 0.7 % T.H.D. at 8 Ω one channel driven)	100 W + 100 W
SURROUND BACK/SUBWOOFER (20 ~ 20 kHz, 0.09 % T.H.D. at 8 Ω one channel driven)	100 W
Total harmonic distortion	0.009 % (1 kHz, 50 W, 8 Ω)
Frequency response	Line (CD/DVD, TAPE, VIDEO 1, VIDEO 2, VIDEO 3, DVD/6CH) 10 Hz ~ 100 kHz, +0 dB ~ -3.0 dB
PHONO 'RIAA' response	40 Hz ~ 20 kHz, +1.5 dB ~ -3.0 dB
Maximum input level	PHONO (MM) 40 mV, 1 % T.H.D. at 1 kHz
Signal to noise ratio (IHF'66)	PHONO (MM) 75 dB Line (CD/DVD, TAPE, VIDEO 1, VIDEO 2, VIDEO 3, DVD/6CH) 95 dB
Loudness control	VOLUME at -30 dB level +6 dB (100 Hz)
Input sensitivity / impedance	PHONO (MM) 6 mV / 47 kΩ Line (CD/DVD, TAPE, VIDEO 1, VIDEO 2, VIDEO 3, DVD/6CH) 500 mV / 47 kΩ
Output level / impedance	TAPE REC 500 mV / 1 kΩ PRE OUT (SURROUND BACK CHANNEL) 1 V / 1 kΩ PRE OUT (SUBWOOFER) 1 V / 1 kΩ
Tone control	BASS ±10 dB (at 100 Hz) TREBLE ±10 dB (at 10 kHz)

## DIGITAL AUDIO section

Sampling frequency	32 kHz, 44.1 kHz, 48 kHz, 96 kHz
Input level / impedance / wave length	Optical -15 dBm ~ -24 dBm, 660 nm ±30 nm Coaxial 0.5 Vp-p / 75 Ω
Output level / impedance / wave length	Optical -21 dBm ~ -15 dBm, 660 nm ±30 nm

## VIDEO section

VIDEO inputs / outputs	VIDEO (composite) 1 Vp-p / 75 Ω
S VIDEO inputs / outputs	S VIDEO (luminance signal) 1 Vp-p / 75 Ω S VIDEO (chrominance signal) 0.286 Vp-p / 75 Ω
COMPONENT VIDEO inputs / outputs	COMPONENT VIDEO (luminance signal) 1 Vp-p / 75 Ω COMPONENT VIDEO (CB/CR-signal) 0.7 Vp-p / 75 Ω

## FM tuner section

Tuning frequency range	87.5 MHz ~ 108.0 MHz
Usable sensitivity (MONO)	1.3 μV (75 Ω) / 13.2 dBf (75 kHz dev, SINAD 30 dB)
50 dB quieting sensitivity	STEREO 28 μV (75 Ω) / 40.2 dBf (75 kHz dev)
Total harmonic distortion	MONO (1 kHz, 75 kHz dev) 0.5% (65 dBf input) STEREO (1 kHz, 67.5 + 67.5 kHz dev) 0.7% (65 dBf input)
Signal to noise ratio	MONO (1 kHz, 75 kHz dev) 75 dB (65 dBf input) STEREO (1 kHz, 67.5 + 67.5 kHz dev) 68 dB (65 dBf input)
Stereo separation (1 kHz)	40 dB
Selectivity (±400 kHz)	70 dB
Frequency response (30 Hz ~ 15 kHz)	+0.5 dB, -3.0 dB

## AM tuner section

Tuning frequency range	10 kHz step 530 kHz ~ 1,700 kHz
Usable sensitivity (30% mod, S/N 20 dB)	16 μV / (600 μV/m)
Signal to noise ratio (30% mod, 400 Hz)	50 dB (60 dBμV EMF input)

## GENERAL

Power consumption	3.4 A
Standby Power consumption	Less than 1 W
AC outlet	SWITCHED (total 150 W, 1.25 A max.)
Dimensions	W : 440 mm (17-5/16") H : 159 mm (6-1/4") D : 392 mm (15-7/16")
Weight (Net)	11.0 kg (24.3 lb)

## Notes

1. KENWOOD follows a policy of continuous advancements in development. For this reason specifications may be changed without notice.
2. The full performance may not be exhibited in an extremely cold location (under a water-freezing temperature).

## For your records

Record the serial number, found on the back of the unit, in the spaces designated on the warranty card, and in the space provided below. Refer to the model and serial numbers whenever you call upon your dealer for information or service on this product.

Model \_\_\_\_\_ Serial Number \_\_\_\_\_

# KENWOOD

## Free Manuals Download Website

<http://myh66.com>

<http://usermanuals.us>

<http://www.somanuals.com>

<http://www.4manuals.cc>

<http://www.manual-lib.com>

<http://www.404manual.com>

<http://www.luxmanual.com>

<http://aubethermostatmanual.com>

Golf course search by state

<http://golfingnear.com>

Email search by domain

<http://emailbydomain.com>

Auto manuals search

<http://auto.somanuals.com>

TV manuals search

<http://tv.somanuals.com>