

# KENWOOD

COMPONENT SYSTEM/COMPACT HI-FI SYSTEM

## XD SERIES

XD-751/XD-701

XD-771S

XD-551/XD-501

XD-571S

---

## INSTRUCTION MANUAL

KENWOOD CORPORATION

This instruction manual is used to describe multiple models listed above.  
Model availability and features (functions) may differ depending on the country and sales  
area.



COMPACT  
disc  
DIGITAL AUDIO

B60-3768-00 00 (MA) (MC) (Y,M,X,T,Q)  
99/12 11 10 9 8 7 6 5 4 3 2 1 98/12 11 10 9 8 7 6 5 4 3 2 1

# 2 Before applying power

**⚠ Caution : Read this page carefully to ensure safe operation.**

XD-SERIES (En)

Units are designed for operation as follows.

U.S.A. and Canada ..... AC 120 V only  
 Austraria ..... AC 240 V only

Europe and U.K. .... AC 230 V only  
 China and Russia ..... AC 220 V only  
 \*Other countries ..... AC 110-120 / 220-240 V switchable

Preparation section

### \*AC voltage selection

The AC voltage selector switch on the rear panel is set to the voltage that prevails in the area to which the unit is shipped. Before connecting the power cord to your AC outlet, make sure that the setting position of this switch matches your line voltage. If not, it must be set to your voltage in accordance with the following direction.

#### AC voltage selector switch



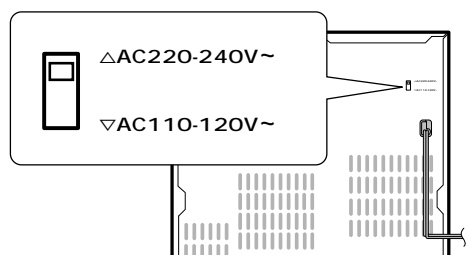

Move switch lever to match your line voltage with a small screwdriver or other pointed tool.



Note:  
 Our warranty does not cover damage caused by excessive line voltage due to improper setting of the AC voltage selector switch.

## Safety precautions

**WARNING :** TO PREVENT FIRE OR ELECTRIC SHOCK, DO NOT EXPOSE THIS APPLIANCE TO RAIN OR MOISTURE.

	<b>CAUTION</b> RISK OF ELECTRIC SHOCK DO NOT OPEN		CAUTION: TO REDUCE THE RISK OF ELECTRIC SHOCK, DO NOT REMOVE COVER (OR BACK). NO USER-SERVICEABLE PARTS INSIDE. REFER SERVICING TO QUALIFIED SERVICE PERSONNEL.
	THE LIGHTNING FLASH WITH ARROWHEAD SYMBOL, WITHIN AN EQUILATERAL TRIANGLE, IS INTENDED TO ALERT THE USER TO THE PRESENCE OF UNINSULATED "DANGEROUS VOLTAGE" WITHIN THE PRODUCT'S ENCLOSURE THAT MAY BE OF SUFFICIENT MAGNITUDE TO CONSTITUTE A RISK OF ELECTRIC SHOCK TO PERSONS.		
	THE EXCLAMATION POINT WITHIN AN EQUILATERAL TRIANGLE IS INTENDED TO ALERT THE USER TO THE PRESENCE OF IMPORTANT OPERATING AND MAINTENANCE (SERVICING) INSTRUCTIONS IN THE LITERATURE ACCOMPANYING THE APPLIANCE.		

### REQUIREMENT BY NEDERLAND GAZETTE

Batteries are supplied with this product. When they empty, you should not throw away. Instead, hand them in as small chemical waste.

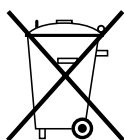



### The marking of products using lasers (Except for some areas)

**CLASS 1  
 LASER PRODUCT**

The marking is located on the rear panel and says that the component uses laser beams that have been classified as Class 1. It means that the unit is utilizing laser beams that are of a weaker class. There is no danger of hazardous radiation outside the unit.

# Contents

## Preparation section

-  Before applying power ..... 2
-  Safety precautions ..... 2
- Special features ..... 4
- Handling of discs and tapes ..... 5
- System connection (XD-7...series)..... 6
  - Connection of the System Accessories ..... 6
  - Connection of Options (Optional Parts) ..... 8
- System connection (XD-5...series)..... 10
  - Connection of the System Accessories ..... 10
  - Connection of Options (Optional Parts) ..... 12
- Controls and indicators ..... 14
  - Main Unit ..... 14
  - Display ..... 16
  - Remote control Unit..... 17
- Operation of remote control unit ..... 18
  - CHANNEL SPACE setting..... 18

## Basic section

- Let's put out some sound ..... 20
  - Basic use method ..... 20
  - Playback of CD ..... 22
  - Playback of tape ..... 24
  - Searching for the desired music program (DPSS).. 27
  - Receiving broadcast station ..... 28
- Let's record ..... 30
  - Recording (Deck B only) ..... 30
  - Copying tape (Tape dubbing) ..... 33

## Application section

- Playback of CD ..... 34
  - Listening in the desired sequence (program playback) ..... 34
  - Repeated playback ..... 36
  - Listening to an unexpected title sequence (random playback) ..... 38
- R.D.S. (Radio Data System) (Except for some areas) ..... 39
  - Searching for a desired program type (PTY search) ..... 40
  - To be able to listen to the desired information at any time ..... 42
- Convenient CD recording ..... 44
  - Selection of the convenient CD recording type ..... 44
  - Recording only desired titles (CD ONE TRACK RECORD) ..... 45
  - Recording of an entire CD (CD RECORD) ..... 46
  - Giving preference to the tape length over the title sequence (CD EDIT) ..... 47
  - Recording the programmed titles (CD PGM RECORD) ..... 48
- Effective Sound Adjustment ..... 49
  - Adjustment of balance and input level ..... 49
  - Listening with the desired sound (equalizer function) ..... 50
  - Enjoying Sound Field Effects ..... 52
  - Enjoying Karaoke (Except for some areas) ..... 53
- Clock adjustment ..... 54
- Timer operation ..... 55
  - Sleep timer (SLEEP) ..... 55
  - Operate easy To use Timer (Operate easy To use Timer:O.T.T.) ..... 55
  - Timer programming ..... 56

Preparation section

## Knowledge section

- Important Items ..... 59
  - Maintenance ..... 59
  - Reference ..... 59
- In case of difficulty ..... 60
- Specifications ..... 63



# Special features

## 3D Wide FL display → 16

The easy to see graphical display features a large spectrum analyzer. A running indicator shows the operations such as CD playback and skipping at a glance.

## Easy to operate, new multi control jog dial → 19

The jog dial makes possible easy setup of CD playback, timer recording/playback and other operations while monitoring the displayed information. The same operation is also available on the remote control unit.

## Built in sub woofer (XD-7....series only) → 21

Each 3-way speaker incorporates an additional sub woofer to reproduce heavy bass more powerfully than conventional system speakers.

## 3-Disc carousel CD player → 22

Three discs can be set. There are various ways for enjoyment at the time of program playback, repeat playback, random playback, etc.

## Versatile tone and sound field adjustment → 50

Equalizer patterns can not only be selected from preset patterns, but patterns also can be created and registered. It is possible to recreate a feeling of presence and to recreate a sound field.

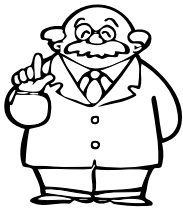

## Demonstration

When the power supply is restored after a power failure or the power cord is unplugged and plugged in again during use, this unit automatically starts the demonstration function (display only). During the demonstration, the display changes in sequence but the audio does not change. The demonstration can be canceled with the following procedure.

- Press the key during demonstration to stop it.

To switch over the demonstration:

**Turn the unit OFF (STANDBY mode) and press the key.**

**Each press of the key switches the demonstration as shown below.**



- ① DEMO (Demonstration executed)
- ② OFF (Demonstration canceled)

## Unpacking

Unpack the unit carefully and make sure that all accessories are put aside so they will not be lost.

Examine the unit for any possibility of shipping damage. If your unit is damaged or fails to operate, notify your dealer immediately. If your unit was shipped to you directly, notify the shipping company without delay. Only the consignee (the person or company receiving the unit) can file a claim against the carrier for shipping damage.

We recommend that you retain the original carton and packing materials for use should you transport or ship the unit in the future.

## Accessories

FM indoor antenna (1)

Europe and U.K.



Other countries

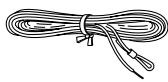

Loop antenna stand (1)

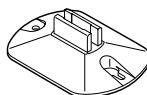

AM loop antenna (1)

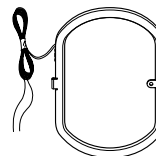

Speaker cushion (8)



Speaker cords (4)

XD-7....Series

Speaker cords (2)

XD-5....Series



(Provided in the speaker package)

Remote control unit (1)

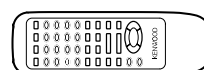

Batteries (R6/AA) (2)

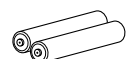

# Handling of discs and tapes

## Disc handling precautions

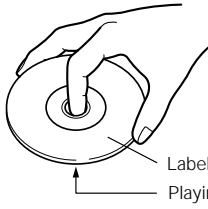

### Handling

Hold compact discs so that you do not touch the playing surface.

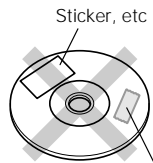

Do not attach paper or tape to either the playing side or the label side of compact discs.

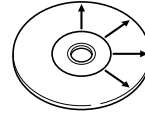

### Cleaning

If fingerprints or foreign matter become attached to the disc, lightly wipe the disc with a soft cotton cloth (or similar) from the center of the disc outwards in a radial manner.

### Storage

When a disc is not to be played for a long period of time, remove it from the CD player and store it in its case.

## CD accessories

The CD accessories (stabilizer, protection sheet, protection ring, etc.) which are marketed for improving the sound quality or protecting discs as well as the disc cleaner should not be used with this system because they may cause malfunction.

## Discs which can be played with this unit

### CD (12 cm, 8 cm), CDV (only the audio part)

- With CD-G (CD Graphics) discs, this unit can play only the audio.
- Please do not use discs which are not round because they may cause a malfunction.

## Caution on disc used

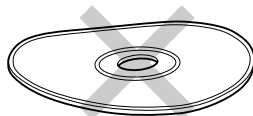
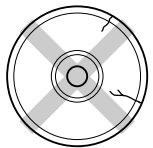

### Never play cracked or warped disc.

During playback, the disc rotates at high speed in the player. Therefore, to avoid malfunction, never use a cracked or deformed disc or a disc repaired with tape or adhesive agent.

### Do not use cleaning discs.

Please do not use commercially available cleaning discs, they may damage the internal mechanism.

## Notes on cassette tape

### Safety tab (accidental erasure prevention tab)

After an important recording has been finished, break the safety tab, to prevent the recorded contents from being erased or recorded on accidentally.

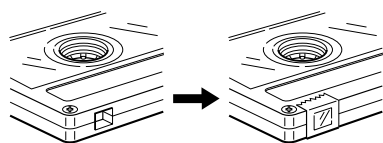
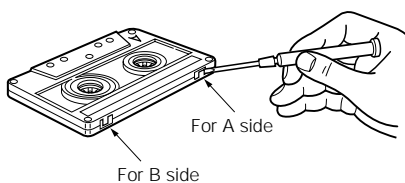

### To re-record

Apply tape only to the position where the tab has been removed.

### To store cassette tapes

Do not store the tapes in a place which is subject to direct sunlight, or near equipment that generates heat. Keep the cassette tapes away from any magnetic field.

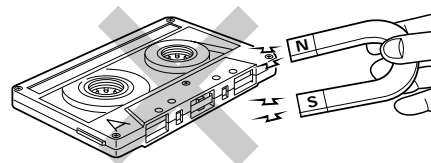

### When there is slack in the tape

In such a case, insert a pencil into the reel hole and wind the reel hub to remove the slack.

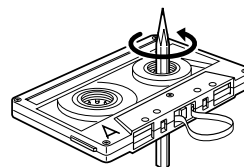

### 1. Longer tape than 110 minutes cassette tape

Since longer tape than 110 minutes cassette tape is very thin, the tape could adhere to the pinch roller or be easily cut. It is recommended that these tapes not be used with this unit to prevent possible damage.

### 2. Endless tapes

Do not use an endless tape, as this could damage the mechanism of the unit.

## Connection of the System Accessories

This is the connection method for system and accessories. Please look carefully at the illustration and connect correctly in the order of the numbers.

### AM loop antenna

The supplied antenna is for indoor use. Place it as far as possible from the main system, TV set, speaker cords and power cord, and set it to a direction which provides the best reception.

### Malfunction of microcomputer

If operation is not possible or erroneous display appears even though all connections have been made properly, reset the microcomputer referring to "In case of difficulty".



Europe and U.K.

Other countries

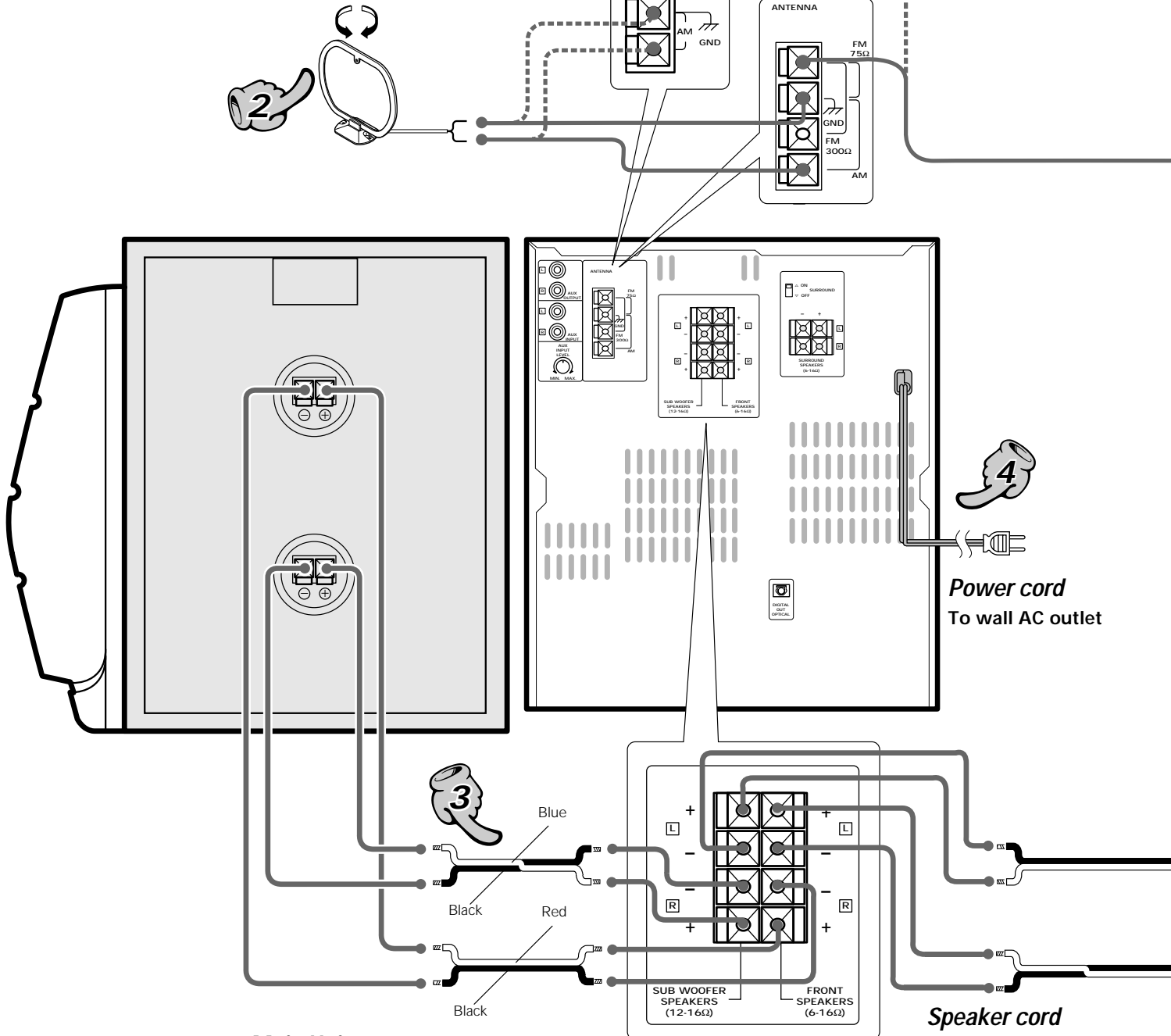

### Main Unit

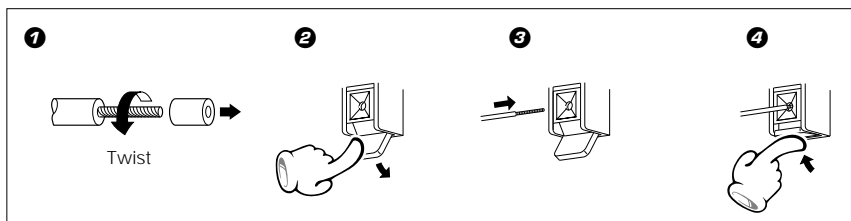

### Speaker and TV installation

If there is a magnet or other device generating magnetic force nearby, interaction between the magnet and speaker may cause color blotching on the TV. If this happens, move the speaker at least 20 cm away from the TV set.

### Caution regarding placement

To maintain proper ventilation, be sure to leave a space around the unit (from the largest outer dimensions including projections) equal to, or greater than, shown below.

rear panel: 10 cm

### FM indoor antenna

The accessory antenna is for temporary indoor use only. For stable signal reception we recommend using an outdoor antenna. Remove the indoor antenna if you connect one outdoors.

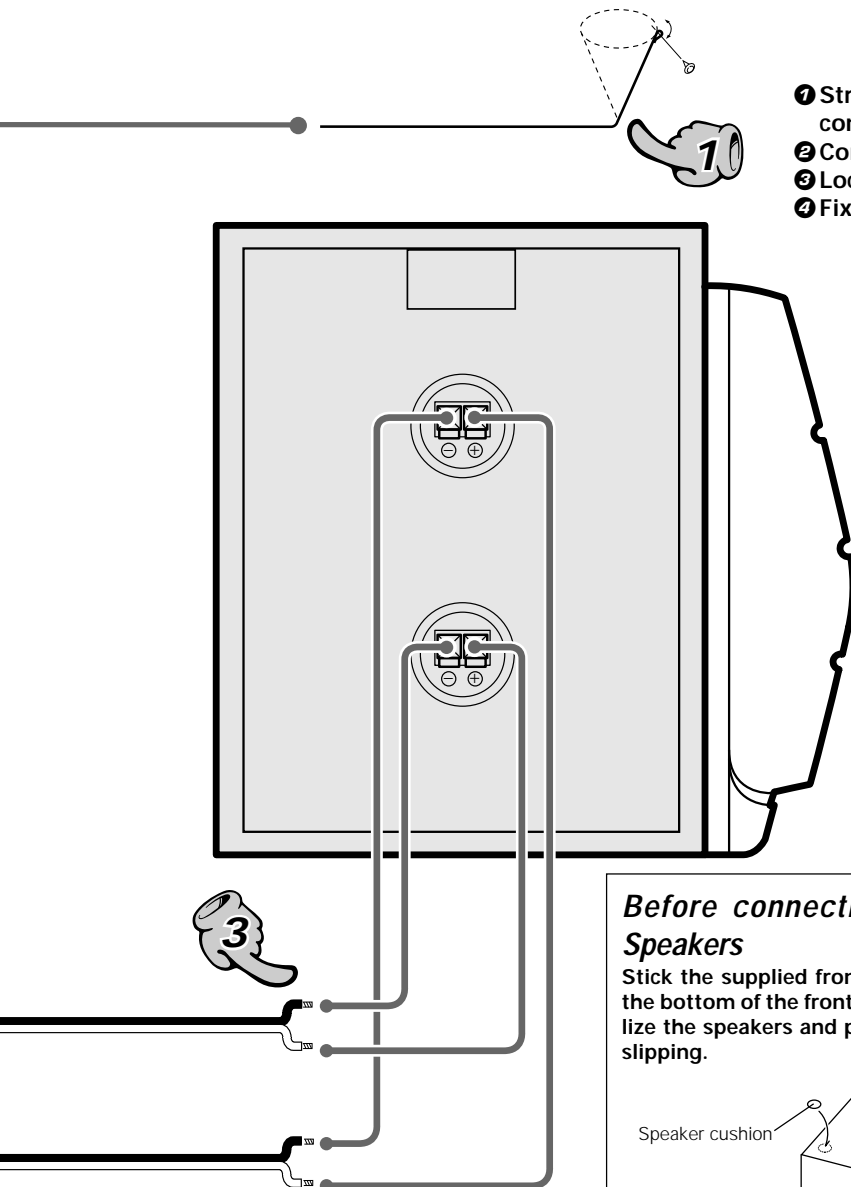

- ❶ Strip the coating from the tip of cord and twist the conductor.
- ❷ Connect to the antenna terminal.
- ❸ Locate the position providing good reception condition.
- ❹ Fix the antenna.

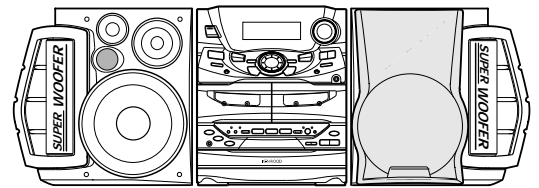

The external view is variable depending on the model and marketing destination area.

### Before connecting the Front Speakers

Stick the supplied front speaker pads to the bottom of the front speakers to stabilize the speakers and prevent them from slipping.

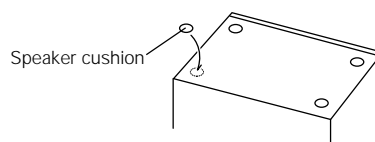

### Speaker Unit

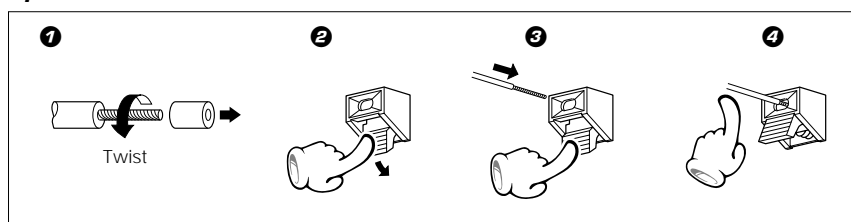

1. In case an associated system component is connected, also read the instruction manual of the component.
2. Never short-circuit the + and - speaker cords.
3. If the left and right speaker connections or the + and - polarity are inverted, the sound will be unnatural with unclear positioning of musical instruments, etc. Be sure to connect them without mistake.



1. Be sure to insert all connection cords securely. If their connections are imperfect, the sound may not be produced or noise may interfere.
2. Before plugging or unplugging a connection cord, be sure to unplug the power cord from the wall AC outlet. If connection cords are plugged or unplugged with the power cord left plugged in, malfunction or damage may result.

## Connection of Options (Optional Parts)

Connect separately sold parts as shown in the figure.  
Do not plug the power cord into the power outlet until all of the required connections have been made.

### In regard to the SURROUND switch

This switch can be used only when the separately sold surround (rear) speakers are connected. When the switch is set to ON, surround playback can be enjoyed. When this switch is set to OFF, normal playback is executed.

- Please operate this switch while the power is switched off.
- We recommend to keep this switch set to OFF when no surround (rear) speakers are connected to obtain a better sound quality.
- When the switch is set to OFF, no sound will come from the surround (rear) speakers.

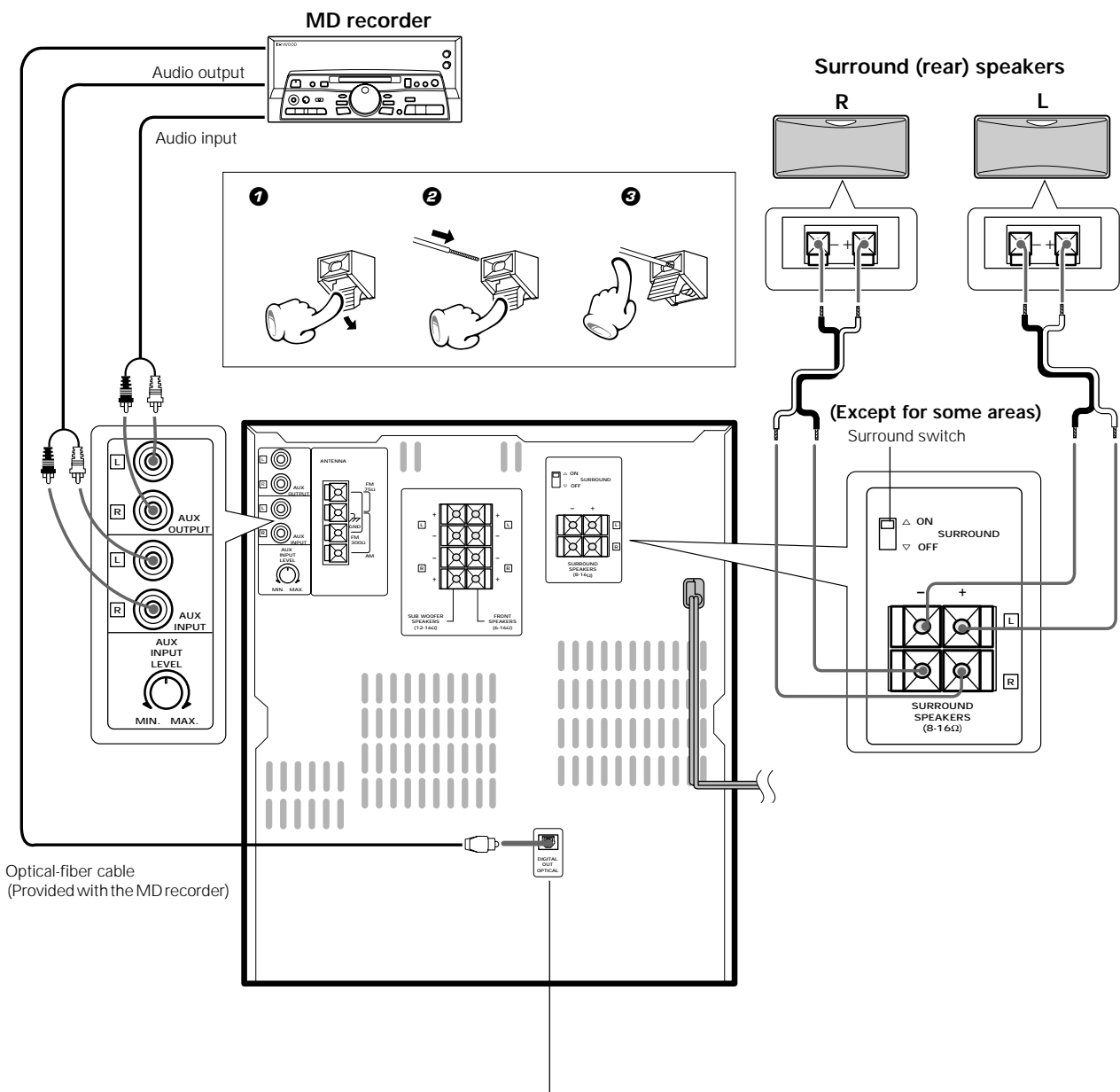

### DIGITAL OUT jack (OPTICAL)

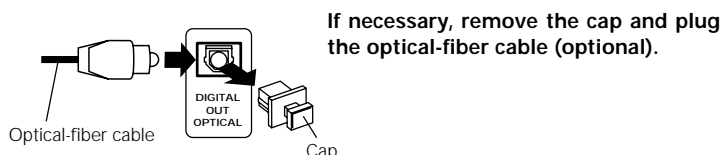



**FM outdoor antenna**

Lead the 75Ω coaxial cable connected to the FM outdoor antenna into the room and connect it to the FM 75Ω terminal.

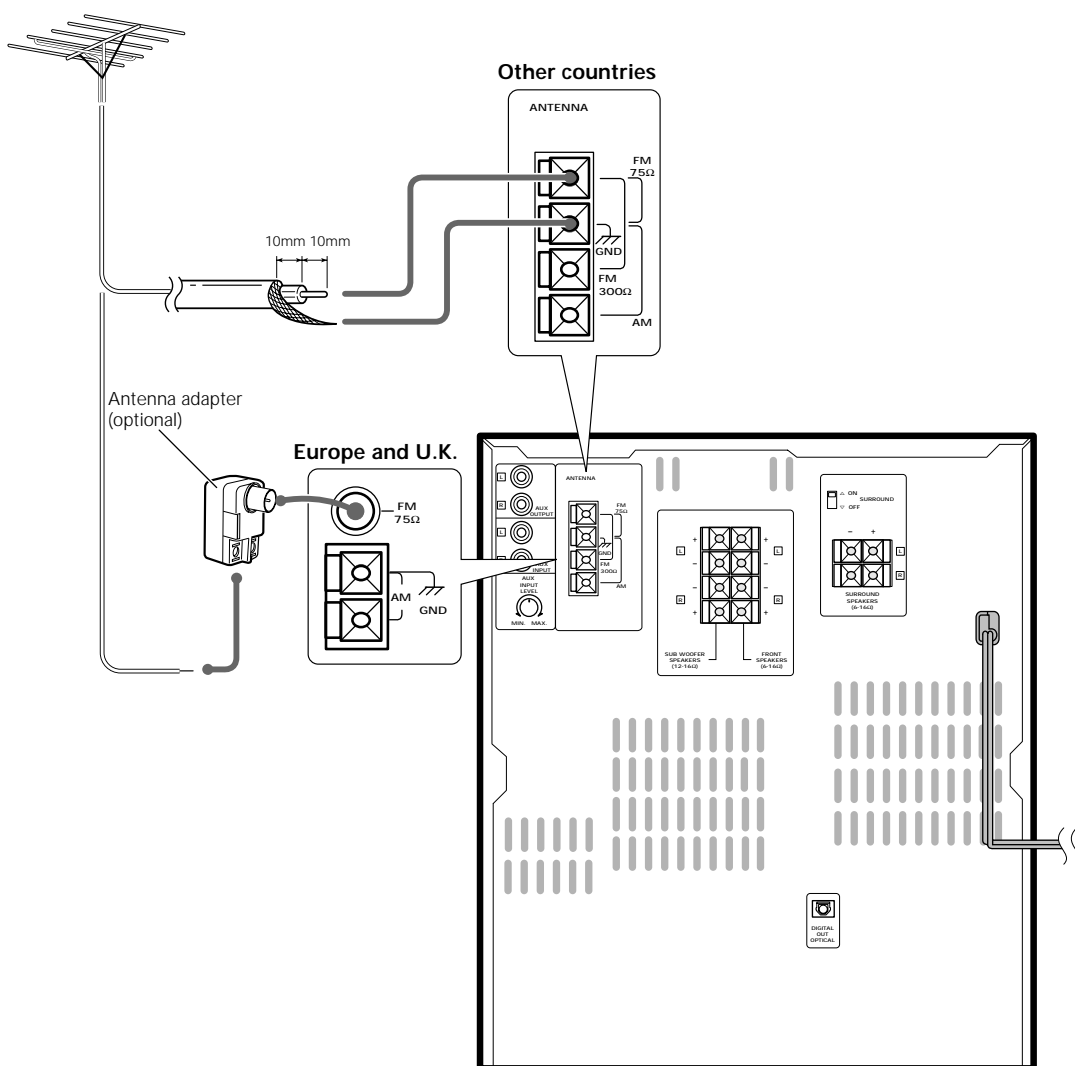
**Notes**

1. All of the optical-fiber cables sold in audio stores cannot always be used. If the cable you purchased cannot be connected to this unit, please consult your dealer or KENWOOD distributor.
2. Insert the optical-fiber cable straight into the connector until it clicks.
3. Be sure to attach the protection cap when the connector is not used.
4. Never band or bundle the optical-fiber cable.

## Connection of the System Accessories

This is the connection method for system and accessories. Please look carefully at the illustration and connect correctly in the order of the numbers.

### AM loop antenna

The supplied antenna is for indoor use. Place it as far as possible from the main system, TV set, speaker cords and power cord, and set it to a direction which provides the best reception.

### Malfunction of microcomputer

If operation is not possible or erroneous display appears even though all connections have been made properly, reset the microcomputer referring to "In case of difficulty".



60

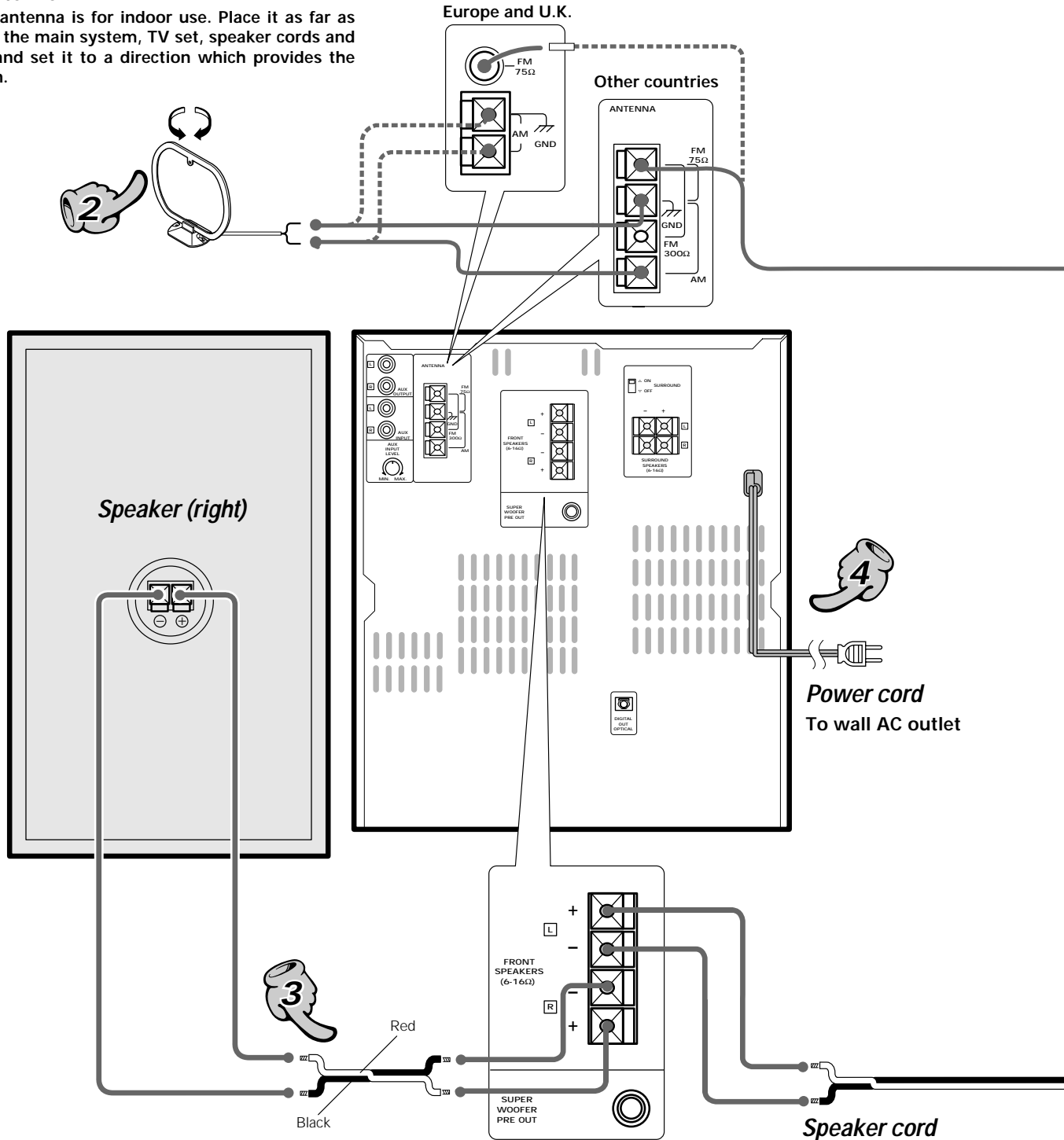

### Main Unit

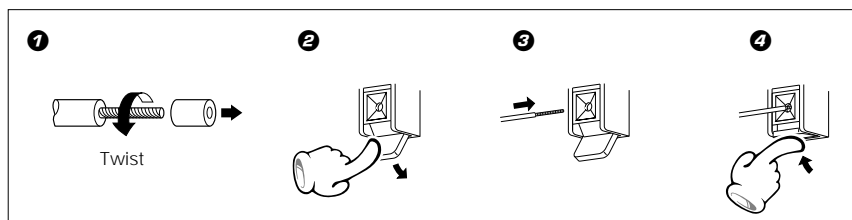

**Caution regarding placement**

To maintain proper ventilation, be sure to leave a space around the unit (from the largest outer dimensions including projections) equal to, or greater than, shown below.

rear panel: 10 cm

**FM indoor antenna**

The accessory antenna is for temporary indoor use only. For stable signal reception we recommend using an outdoor antenna. Remove the indoor antenna if you connect one outdoors.

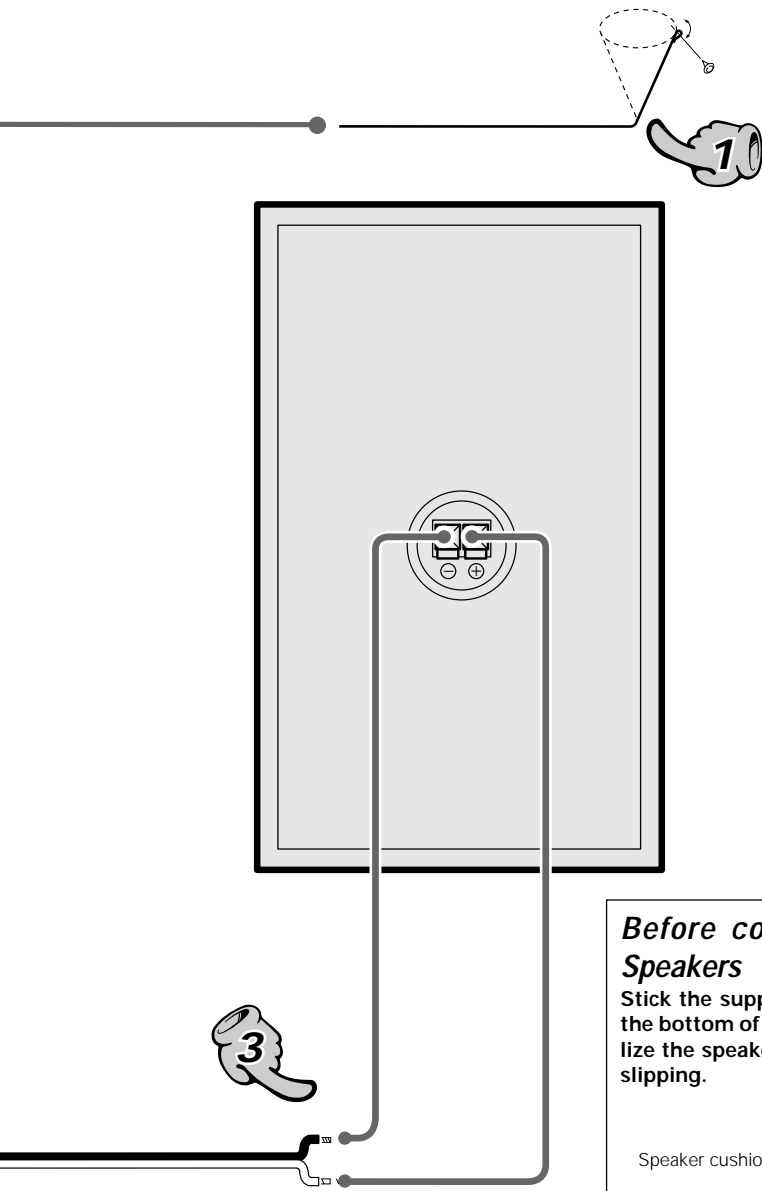

- ❶ Strip the coating from the tip of cord and twist the conductor.
- ❷ Connect to the antenna terminal.
- ❸ Locate the position providing good reception condition.
- ❹ Fix the antenna.

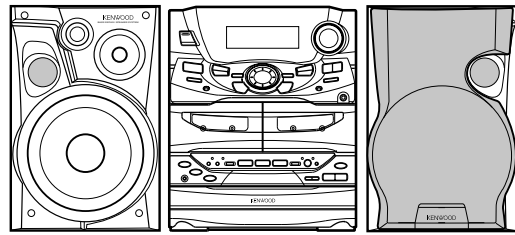

The external view is variable depending on the model and marketing destination area.

**Before connecting the Front Speakers**

Stick the supplied front speaker pads to the bottom of the front speakers to stabilize the speakers and prevent them from slipping.

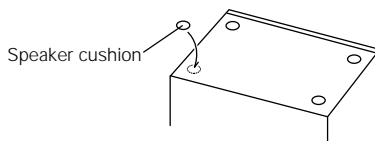

**Speaker Unit**

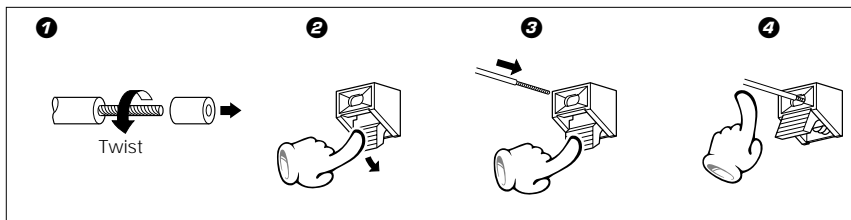

1. In case an associated system component is connected, also read the instruction manual of the component.
2. Never short-circuit the + and - speaker cords.
3. If the left and right speaker connections or the + and - polarity are inverted, the sound will be unnatural with unclear positioning of musical instruments, etc. Be sure to connect them without mistake.



1. Be sure to insert all connection cords securely. If their connections are imperfect, the sound may not be produced or noise may interfere.
2. Before plugging or unplugging a connection cord, be sure to unplug the power cord from the wall AC outlet. If connection cords are plugged or unplugged with the power cord left plugged in, malfunction or damage may result.

# Connection of Options (Optional Parts)

Connect separately sold parts as shown in the figure.  
Do not plug the power cord into the power outlet until all of the required connections have been made.

## In regard to the SURROUND switch

This switch can be used only when the separately sold surround (rear) speakers are connected. When the switch is set to ON, surround playback can be enjoyed. When this switch is set to OFF, normal playback is executed.

- Please operate this switch while the power is switched off.
- We recommend to keep this switch set to OFF when no surround (rear) speakers are connected to obtain a better sound quality.
- When the switch is set to OFF, no sound will come from the surround (rear) speakers.

Preparation section

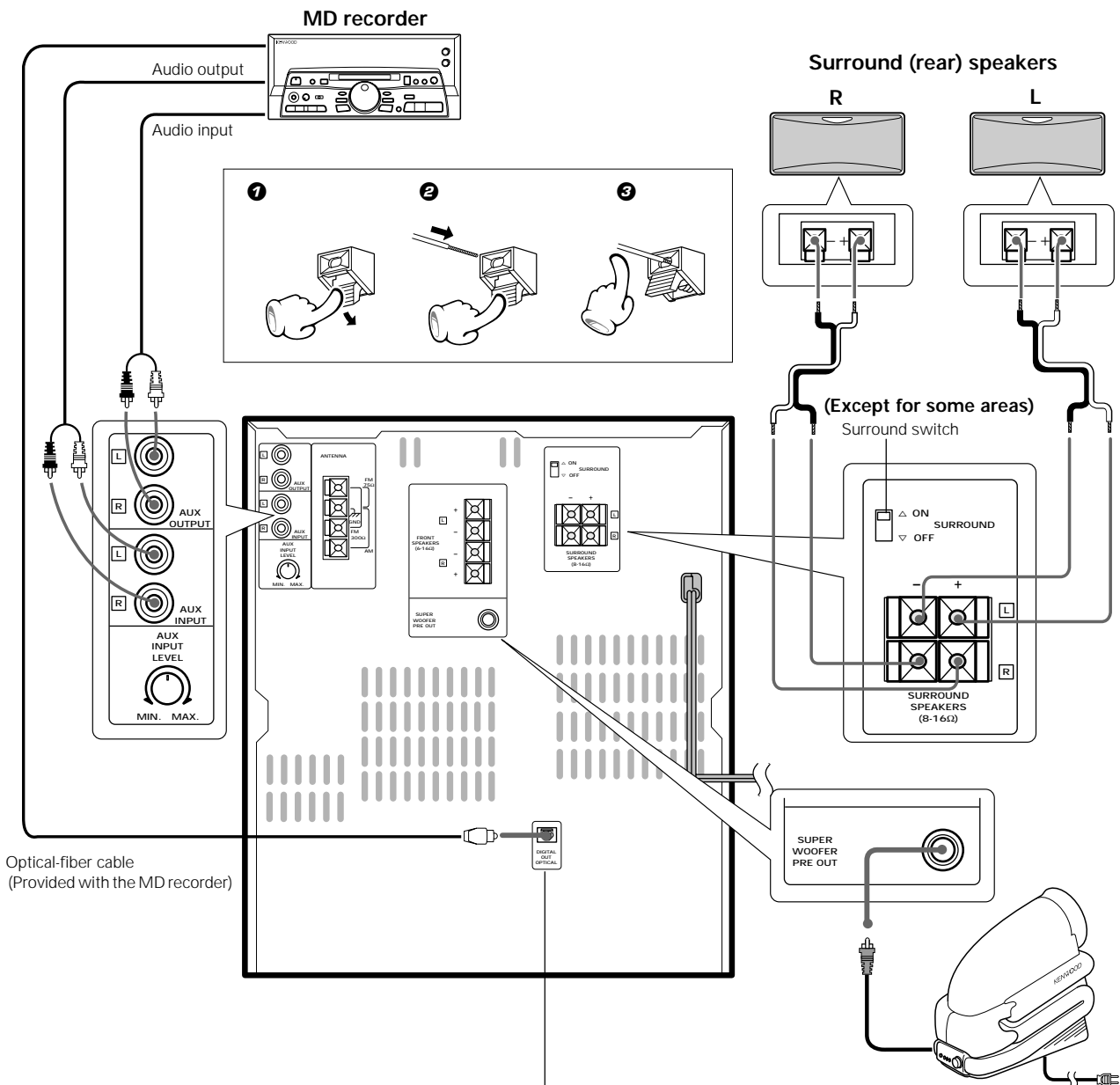

### DIGITAL OUT jack (OPTICAL)

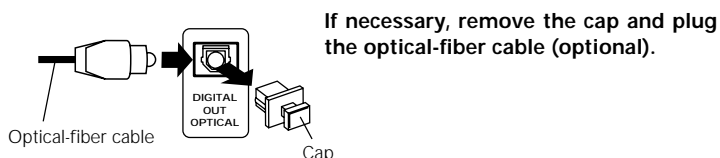

### Super woofer

Extremely low sound is played back powerfully. This can be used with any type of playback.



Main Unit

Preparation section

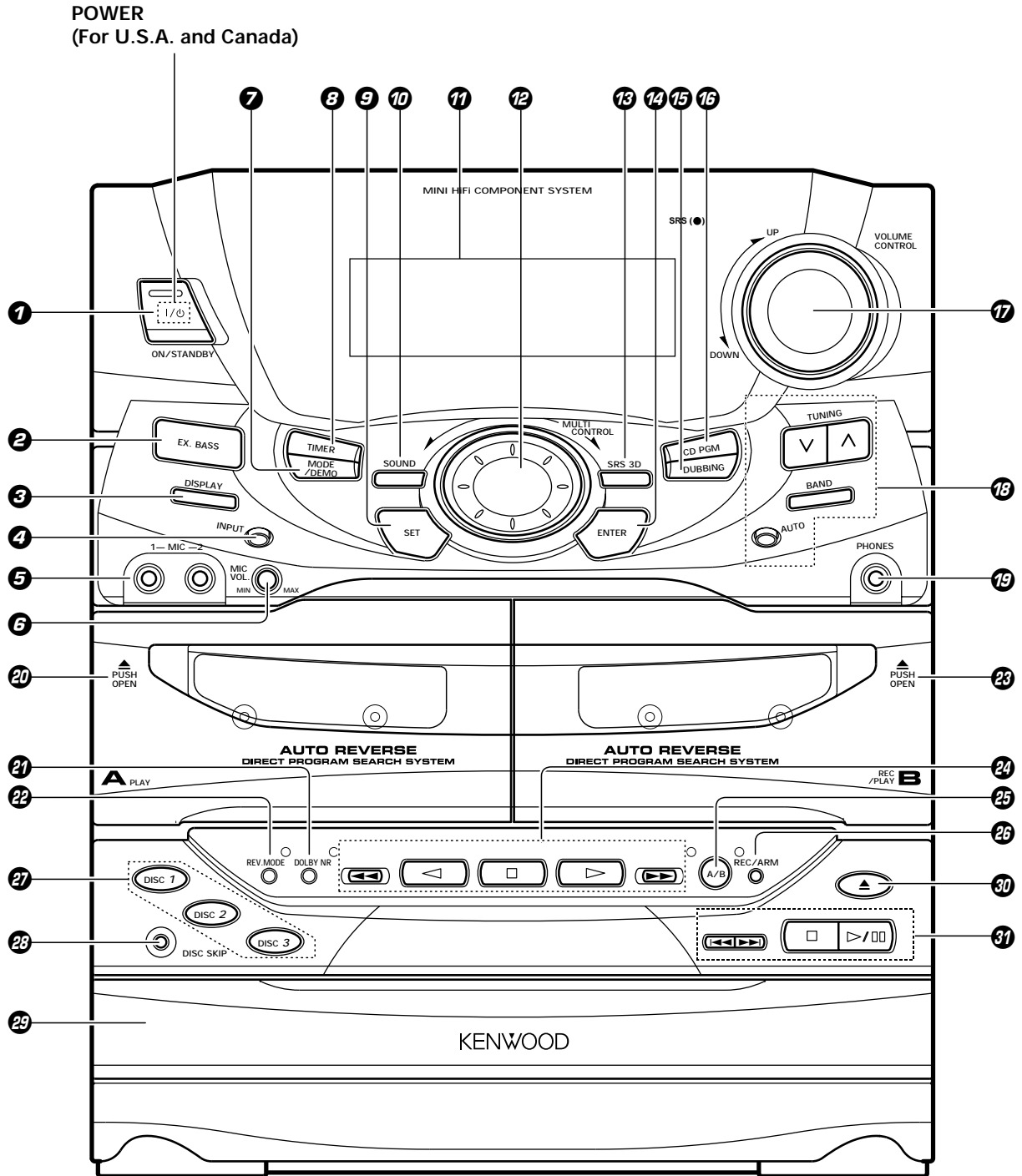

**Receiver**

- ➊ **ON/STANDBY (I / ⏻) POWER) key** → 20  
Power ON/OFF switching is executed.
- ➋ **EX. BASS (Extra bass) key** → 21  
Switches the extra bass play on and off.
- ➌ **DISPLAY key** → 50  
Switches the displayed information.
- ➍ **INPUT key** → 20  
Press to select the input source. When TAPE or CD is selected, playback starts automatically provided that a tape or disc has already been loaded.
- ➎ **MIC 1, MIC 2 terminal (Except for some areas)** → 53  
For connection of a microphone (optional).
- ➏ **MIC VOL. knob (Except for some areas)** → 53  
At the time of mic mixing, this knob controls the volumes of the microphones.
- ➐ **MODE/DEMO key** → 4 → 21 → 49 → 52  
Used for setting or selection of various modes.  
The items which can be selected differ according to the status at that time.  
When power is STANDBY: Switches the demonstration on and off.
- ➑ **TIMER key** → 54 → 58  
Used for time adjustment, timer setting, etc.
- ➒ **SET key** → 21  
Used for setting of various modes or establishing a selection.
- ➓ **SOUND key/Indicator** → 50 → 51  
Used for the equalizer mode setting, etc.

- ➑ **DISPLAY** → 16
- ➒ **MULTI CONTROL jog dial** → 19  
Used for selection of various modes.
- ➓ **SRS 3D key/Indicator** → 52  
Switches the SRS 3D play on and off.
- ➑ **ENTER key** → 21  
Used for entering a selected mode in memory or executing it.
- ➒ **DUBBING key** → 33 → 45 → 48  
Used for tape dubbing or CD recording onto tape.
- ➓ **CD PGM key** → 34  
Used for programming CD tracks.
- ➑ **VOLUME CONTROL knob** → 20  
This is used for volume adjustment.
- ➒ **Tuner operation keys** → 28 → 29  
**TUNING keys**  
Press to select a radio station.  
**BAND key**  
Press to switch the receiving band.  
**AUTO key**  
Switches the tuning mode.
- ➓ **PHONES terminal** → 20  
For connection of a headphone (optional).

**Cassette deck unit**

- ➑ **A deck cassette holder**  
Press the area marked ▲ **PUSH OPEN** to load or eject a tape.
- ➒ **DOLBY NR key** → 25  
Dolby noise reduction ON/OFF switching is executed.
- ➓ **REV. MODE key** → 25  
The reverse mode of the deck (both sides, repeated, one side) is switched.
- ➑ **B deck cassette holder**  
Press the area marked ▲ **PUSH OPEN** to load or eject a tape.
- ➒ **Cassette deck operation keys** → 24 → 25  
**Play (◀ ▶) keys**  
**Stop (■) key**  
**Fast forward and rewind (◀◀ ▶▶) keys**
- ➓ **A/B key** → 24 → 32  
Press to select the deck to be operated. Used as the beat cancel key during recording of AM broadcasting.
- ➑ **REC/ARM key** → 31 → 33  
Press to start recording. Pressing the key during recording stops it after leaving a non-recorded space (blank) of about 4 seconds.

**CD player unit**

- ➑ **DISC SELECTOR key** → 23  
The disc for playback (or recording) is selected.
- ➒ **DISC SKIP key** → 23  
The disc for playback (or recording) is selected. This is also used for insertion of a CD to the inside of the disc tray.
- ➓ **Disc tray** → 22  
Three discs can be stored.
- ➑ **OPEN/CLOSE (▲) key** → 22  
The disc tray is opened and closed.
- ➒ **CD operation keys** → 22 → 23  
**Play/pause (▶/⏸) key**  
**Stop (■) key**  
**Skip (◀◀ ▶▶) keys**

# Display

(The displays given in this manual are approximations only. They may differ from what actually appears on the display.)

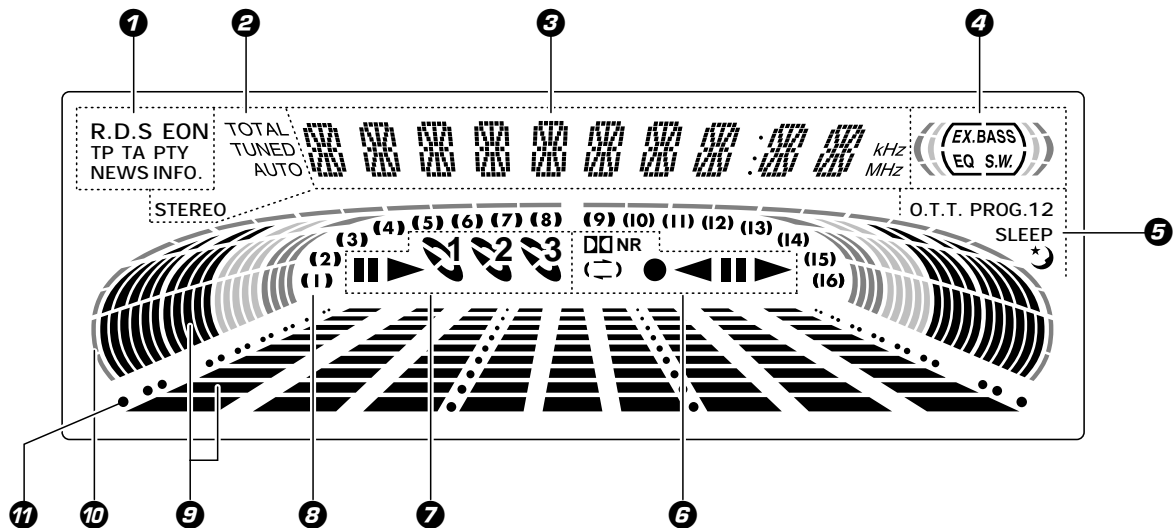

## 1 RDS-related indicators (Provided except for some areas)

### 2 Tuner and applied CD operation indicators

This section contains the indicators of the tuner operations and applied CD operations.

### 3 Character information display

Displays the input selection, frequency, volume level, etc.

### 4 Tone and sound field-related indicators

### 5 Timer-related indicators

## 6 Cassette deck indicators

This section contains the cassette deck operation indicators. The indicated information includes the tape reverse mode and tape transport direction.

## 7 CD player indicators

This section displays the CD playback and pause mode information as well as the disc number being played.

## 8 Track number indicator

Indicates the CD track number being played.

## 9 Spectrum analyzer display

## 10 RUNNING INDICATOR

This indicator rotates according to the operation modes during operation of the CD player, cassette deck, etc. It also shows the approximate sound level during volume control.

## 11 Guideline

Blinks during the setting of an item using the jog dial.



# Remote control Unit

The keys on the remote control unit with the same names as on the main unit have the same function as the keys on the main unit.

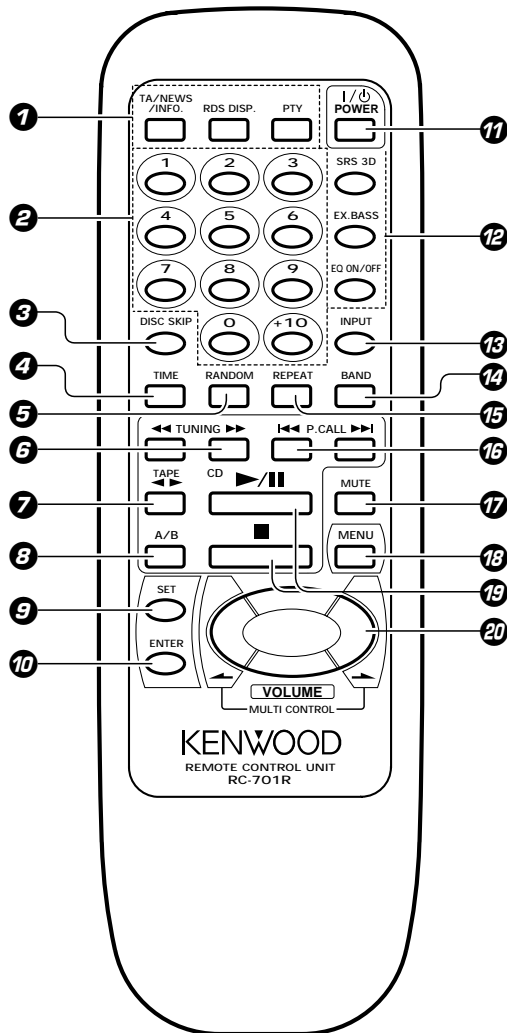

Europe and U.K. : RC-701R  
Other countries : RC-701

Model: See left.  
Infrared ray system.

- 2 Numeric keys** → 23  
Used as number keys when the input is CD or TUNER.
- 3 DISC SKIP key** → 23
- 4 TIME key** → 22  
Press to switch the time information on the CD player unit.
- 5 RANDOM key** → 38  
For CD playback, switching is executed between random playback and normal playback.
- 6 TUNING (◀◀ ▶▶) keys (TUNER/CD)** → 28 → 23
- 7 TAPE play (◀ ▶) keys** → 24
- 8 A/B key** → 24 → 32
- 9 SET key** → 21
- 10 ENTER key** → 21
- 11 ON/STANDBY (I / ⏻ POWER) key** → 20  
Power ON/OFF switching is executed.
- 12 Tone and sound field-related keys**
  - SRS 3D key** → 52
  - EX. BASS key** → 21
  - EQ. ON/OFF key** → 50  
Press to switch the equalizer ON and OFF.
- 13 INPUT key** → 20
- 14 BAND key** → 28
- 15 REPEAT key** → 36  
Used for repeated playback of a CD.
- 16 P.CALL (Preset Call) (◀◀ ▶▶) keys (TUNER/CD)** → 28 → 23  
Used to recall a preset radio station.  
During CD playback, press to skip CD tracks.
- 17 MUTE key** → 21  
This is used to mute the sound temporarily.
- 18 MENU key**  
Used to switch the function of the MULTI CONTROL keys.  
The function items that can be selected with the MULTI CONTROL keys are variable depending on the current operation status.  
Items such as CD PGM, DUBBING, SOUND, DISPLAY, TIMER and MODE are selected using keys 20.
- 19 CD play/pause (▶/||) key**  
**Stop (■) key**
- 20 MULTI CONTROL/VOLUME keys** → 21  
The left and right keys have the same functions as the MULTI CONTROL jog dial on the amplifier/tuner unit.  
The top and bottom keys are used to adjust the volume. → 20

## 1 RDS-related keys (Except for the RC-701)

- TA/NEWS/INFO. key** → 42  
Used for automatic reception of transmissions of a certain content.
- RDS DISP. key** → 39  
The display contents are switched during reception of RDS broadcasts.
- PTY key** → 40  
This is used to specify the program type when searching for a station.

## Loading batteries

❶ Remove the cover.

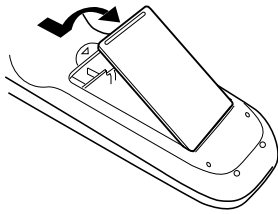

❷ Insert batteries.

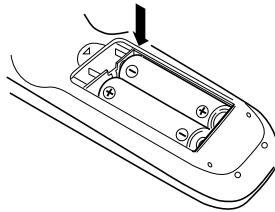

❸ Close the cover.

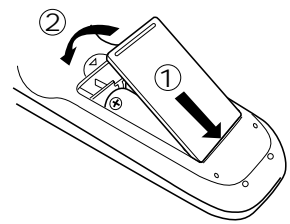

- Insert two R6 ("AA"-size) batteries following the polarity indications.

## Operation

Plug the power cord into the mains power outlet and press the on/standby (I / ⏻ POWER) key of the remote control unit to turn power ON. After the power has been turned ON, press the desired key.

To turn power off, press the on/standby (I / ⏻ POWER) key again. The system enters the standby mode in which only the time display is lit.

- When pressing more than one remote control keys successively, press the keys securely by leaving an interval of 1 second or more between keys.

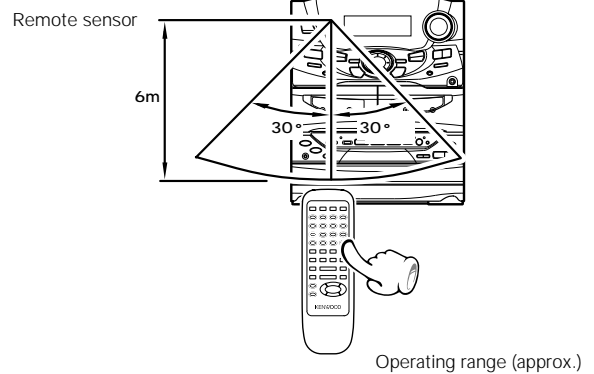

1. The provided batteries are intended for use in operation checking, and their service life may be short.
2. When the remote controllable distance becomes short, replace both of the batteries with new ones.
3. If direct sunlight or the light of a high-frequency fluorescent lamp (inverter type, etc.) is incident to the remote sensor, malfunction may occur. In such a case, change the installation position to avoid malfunction.

## CHANNEL SPACE setting

(Except for the U.S.A., Canada, U.K. Europe and Australia)

The space between radio channels has been set to the one that prevails in the area to which the system is shipped. However, if the current channel space setting does not match the setting in the area where the system is to be used, for instance when you move from area 1 or area 2 shown in the following table or vice versa, proper reception of AM/FM (SW/MW/FM) broadcasts cannot be expected. In this case, change the channel space setting in accordance with your area by referring to the following table.

Area	CHANNEL SPACE freq.
1 USA, Canada and South American countries	FM : 100 kHz AM: 10 kHz
2 Other countries	FM : 50 kHz AM: 9 kHz

❶ Turn power off.



❷ Select the channel space.

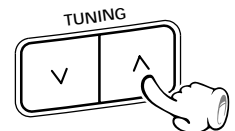

Each press switches the space frequency alternately.

- ① "FM100/AM10 kHz" ..... STEP,
- ② "FM 50 /AM 9 kHz" ..... STEP,

- The "AM" display is variable depending on the model (country or area), and "MW" may be displayed in some areas.

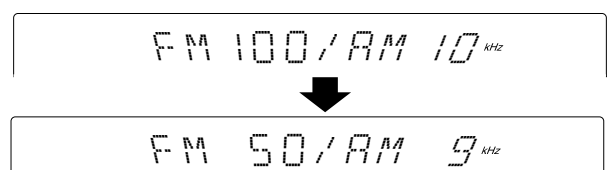

❸ Establish the selection.



## MULTI CONTROL jog dial

The MULTI CONTROL jog dial (or the MULTI CONTROL keys on the remote control unit) allows you to set (or enter) a variety of functions with an easy operation.

The mode for setting (using) MULTI CONTROL is initiated when any of the CD PGM, DUBBING, SOUND, DISPLAY, TIMER and MODE/DEMO keys is pressed.

In the setting mode, select the operation mode with the MULTI CONTROL jog dial and press the SET and/or ENTER key(s) to set, establish, enter or execute the function.

(The ENTER key is always pressed at the end.)

With the remote control unit, pressing the MENU key makes it possible to select the same items as those available on the main unit using the MULTI CONTROL keys.

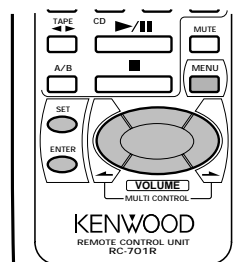
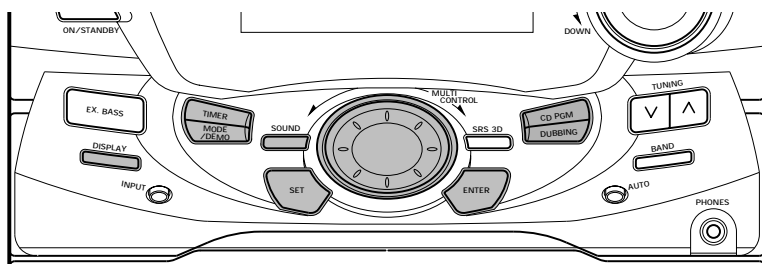

CD PGM  
DUBBING  
SOUND  
DISPLAY  
TIMER  
MODE

- During the setting of an item (while the guideline is blinking), other keys are defeated except for the basic control keys such as the **VOLUME CONTROL** and **ON/STANDBY** keys.
- To cancel the mode for setting (using) MULTI CONTROL, read the description of each item in this manual.

## For Russia

### Reception mode switching of FM broadcast

When you want to receive an FM broadcast in PILOT TONE mode, changing the setting as follows.

- 1 Turn power off.



- 2 Press the TUNING (^) key.

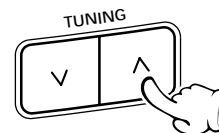

Each press switches the reception mode alternately.

- 1 POLAR system
- 2 PILOT TONE system

POLAR

PILOT

- 3 Establish the selection.



# Basic use method

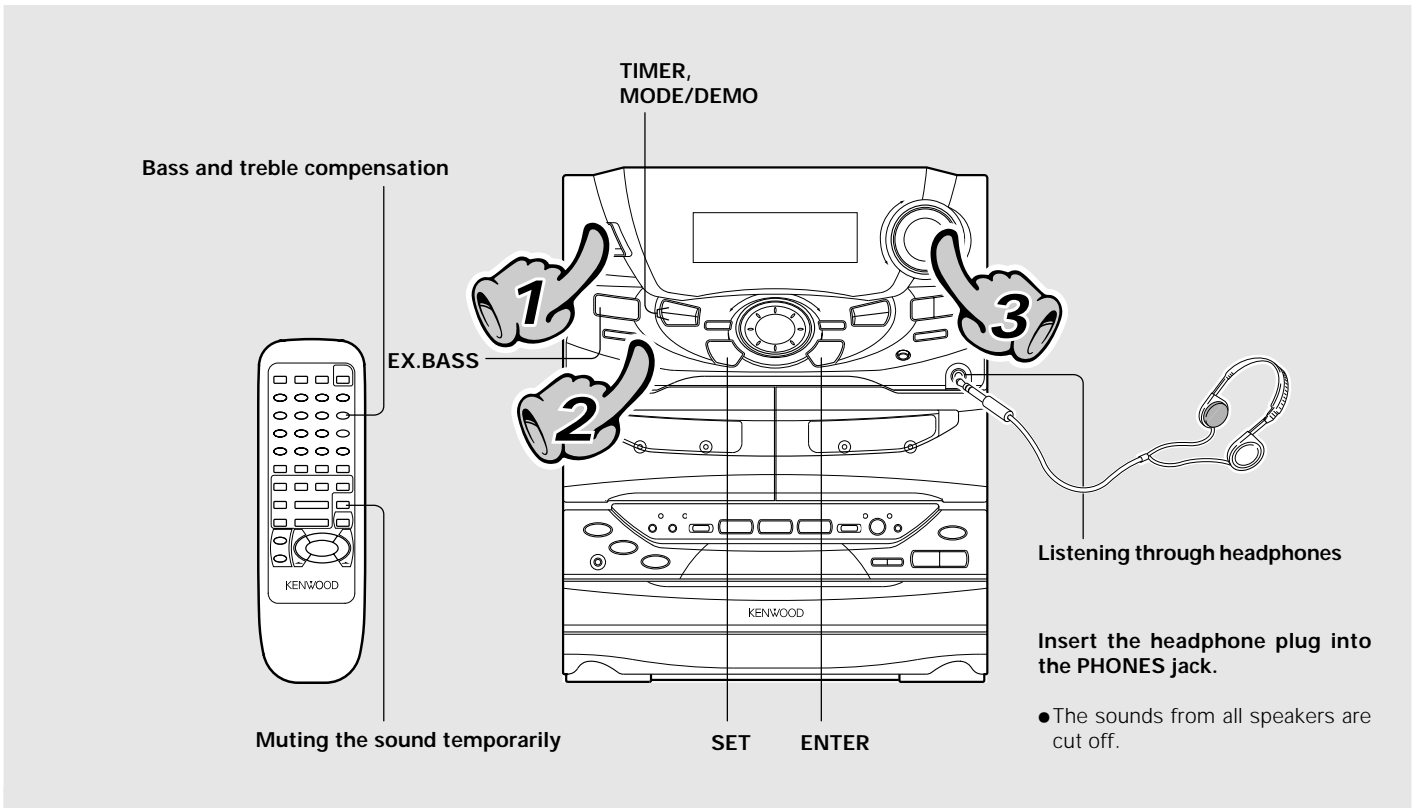

Basic section

## 1. Switching the power ON (OFF)

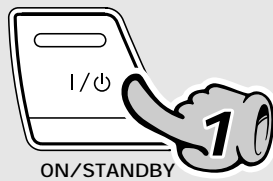

The power can also be turned ON by pressing the play key of the CD player, the play key of the cassette deck or the BAND key of the tuner. When the ON/STANDBY key is pressed while the power is ON, the power will be switched OFF.

- The display part becomes dark when the power is switched OFF. (DIMMER function)

## 2. Selecting the desired output



TUNER (Radio)	→	28	
CD	→	22	
TAPE	→	24	
AUX (External input)	→	8	→ 12

- When you select the AUX input, be also sure to read the instruction manual of the component connected to the AUX input jacks. (AUX INPUT LEVEL adjustment → 49)
- When CD or TAPE is selected, playback will start when a disc or a tape already has been inserted into deck B.

## 3. Volume adjustment

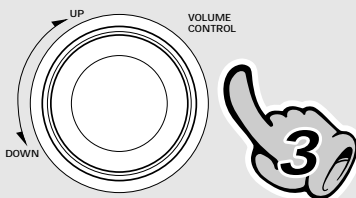

- Quick turning produces a larger change amount. (AI VOLUME control function)
- The display shows a reference value.

### Muting the sound temporarily (Remote control unit only)

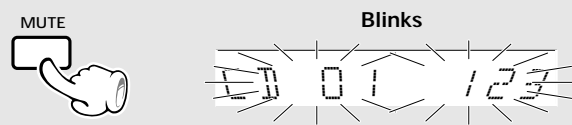

**Remote control unit**

- Press again to resume the original volume.
- The sound muting is also canceled when the volume is controlled.

### Bass compensation (EX.BASS)



- Each press switches EX.BASS on and off alternately.
- The EX.BASS is switched off automatically during recording.

### Sub woofer level adjustment

(Except for the XD-5...series)

Adjust the sub woofer level according to the category of music and your liking.

① Press the MODE/DEMO key.



② Select "S.W." and press the SET key.

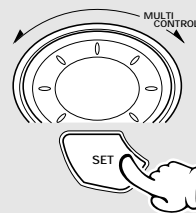

SRS LEVEL  
(Only when SRS 3D is ON)  
S.W.  
L/R BALANCE

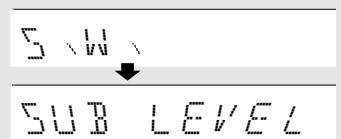

Go to step ③ within 15 sec.

③ Select the desired level and press the ENTER key.

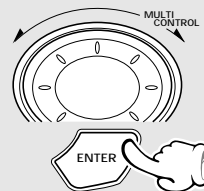

OFF  
LEVEL 1  
LEVEL 2  
LEVEL 3  
LEVEL 4  
LEVEL 5

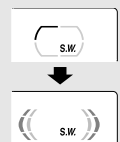

### STANDBY mode of ON/STANDBY (I / ⏻) switch

When the display shows the time or "--:--", a small amount of current is supplied to the unit to back up the internal memory. This status is referred to as the STANDBY mode, and the unit in the STANDBY mode can be turned ON from the remote control unit.

When CD has been selected.

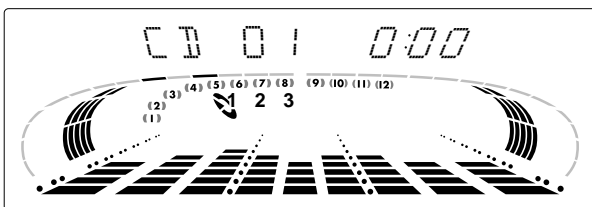

Volume display

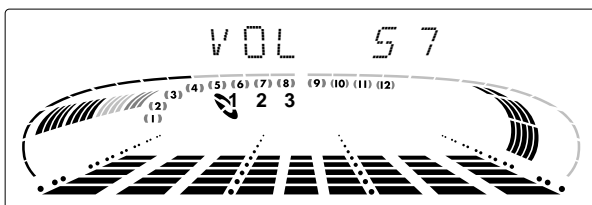

### AUTO POWER SAVE function

When the power is ON and neither recording nor playback is executed for 30 minutes or more, the power is switched off automatically by this function. This function can be made active or not active by the following operation.

① Press the TIMER key.



② Select "AUTO POWER SAVE" and press the SET key.

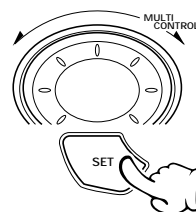

SLEEP  
TIME SET  
O.T.T.  
PROG. ON/OFF  
PROG. 1  
PROG. 2  
AUTO POWER SAVE

③ Select "ON" or "OFF" and press the ENTER key.

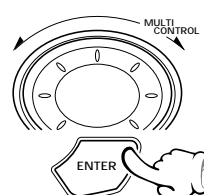

AUTO POWER

← Scrolled display  
(AUTO POWER SAVE)

ON ..... Auto power save is used.  
OFF .... Auto power save is not used.  
RETURN

● This function is not available when the AUX input is selected. When the TUNER input is selected, it is available only when the volume is set to 0.

# Playback of CD



If a disc has already been loaded in the CD player and the power is OFF, simply pressing the CD play key turns power automatically ON and starts playback.

Playback from desired track

TIME

High-speed search in forward and reverse directions

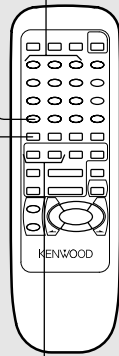

Skipping tracks

To stop Playback

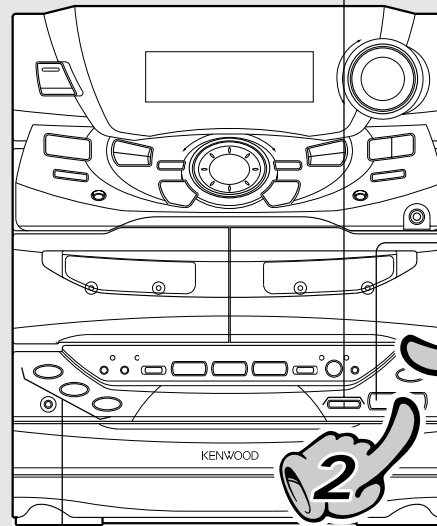

Playback form desired track

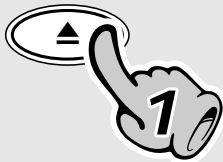

The tray opens when the key is pressed and closes when the key is pressed again.

## 1. Load a disc.

- ① Open the tray.
- ② Place a disc.
- ③ Close the tray.

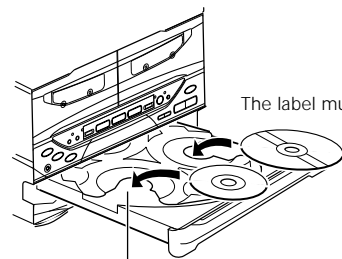

The label must be on top.

Disc played first when the ►/|| key is pressed.



## 2. Start playback.

- After a few seconds, play starts from track No.1.

### Time display on the CD player

Each press of the TIME key of the remote control unit switches the displayed time information.

● Only the time information related to the track being played can be displayed in the program, CD EDIT and random modes.

①	123	Elapsed time of track being played
②	-237	Remaining time of track being played
③	2345	Elapsed time of disc (TOTAL lights up)
④	-36:15	Remaining time of disc (TOTAL lights up)

### Skipping tracks

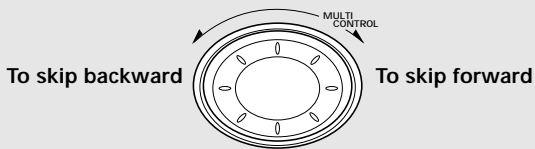

- The tracks in the direction the dial is rotated are skipped, and the selected track will be played from the beginning.
- When the jog dial is rotated a little in the direction of counterclockwise once during playback, the track being played will be played from the beginning.
- The CD tracks can also be skipped using the ◀◀ or ▶▶ key of the remote control unit and amplifier/tuner unit.

### Playback from desired track

**Select the disc.**

**Select the desired track No.**

**Press the numeric keys as shown below....**

To enter track No. 23 : [+10] [+10] [3]

To select track No. 40 : [+10] [+10] [+10] [+10] [0]

### High-speed search in forward and reverse directions

Backward search

Forward search

Remote control unit

- Playback starts from the position where the key is released.

### To pause playback

- Each press pauses and plays the CD alternately.

### To stop playback

- Do not touch the played side of disc.
- Rotate the tray with the **DISC SKIP** key to insert the third disc.
- The tray of the disc to be played should come to the left position when the unit is seen from the front.

The selected disc is indicated.

Lights when a disc is inserted at the time of playback.

The recorded track No. are shown.

## Playback of tape



If you load a tape in a cassette deck (deck B) while the power is off, simply pressing the tape play key turns power automatically ON and starts playback with deck B.

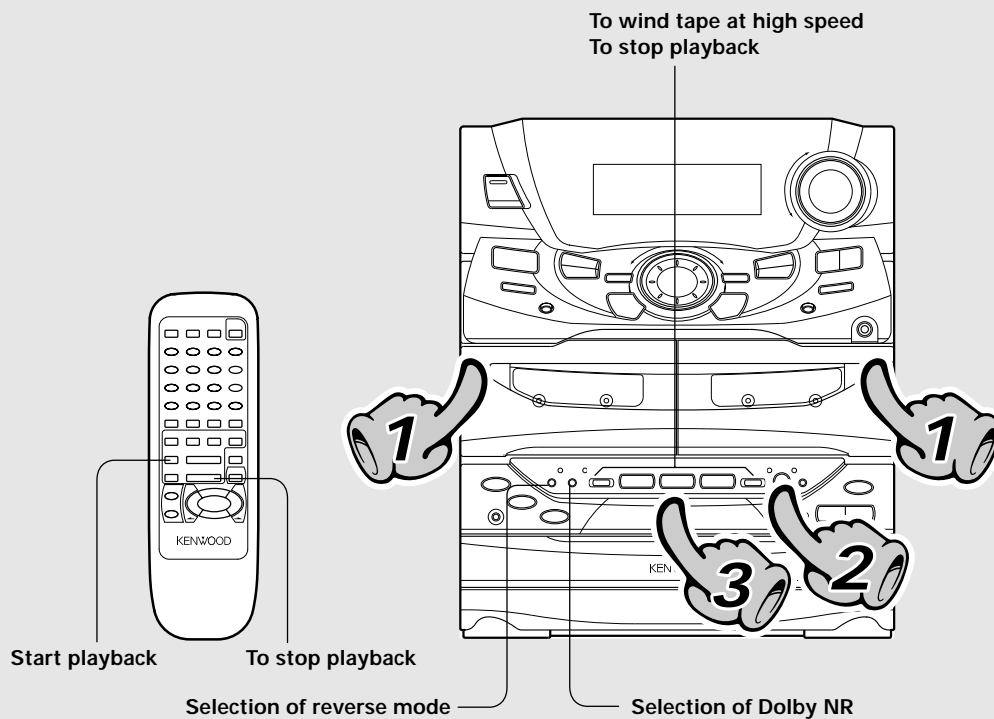

### 1. Load a cassette tape.

- ① Open the door.
- ② Insert a tape and close the door.

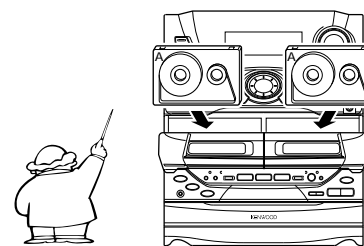
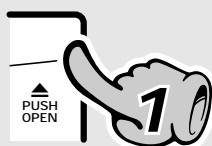

### 2. Select the deck to be used for playback.

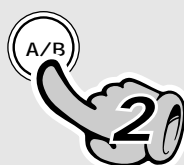

### 3. Start playback.

Press the play key of the desired direction.

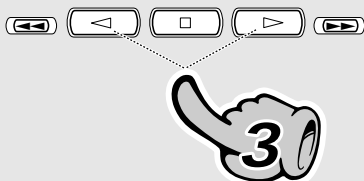



**To wind tape at high speed**

To fast wind in direction ←      To fast wind in direction →

● Press the □ key to stop fast winding.

**Selection of reverse mode.**

REV.MODE

Each press switches the modes as follows.

- ① "↔" ... Both sides are played back (recorded), and then the tape stops.
- ② "↻" .. Both sides are played back endlessly. (The tape stops after recording onto both sides.)
- ③ "→" .. Only one side is played back (recorded), and then the tape stops.

- Normal (TYPE I), high (TYPE II), or metal (TYPE IV) tape selection is set automatically.
- Remove tape slack before loading.
- Close the door securely.

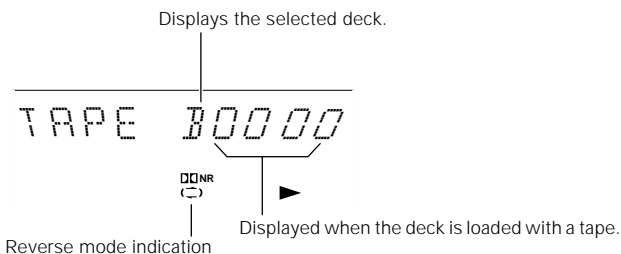

- If the tape transport direction is opposite to the desired direction, press the play key corresponding to this.

**To stop playback**

● Do not take out the cassette tape until the tape transport has stopped completely.

**Selection of DOLBY NR (Noise Reduction)**

The Dolby NR system minimizes the hiss noise heard when playing tape. When playing a tape prerecorded with Dolby NR ON, be sure to set the DOLBY NR ON for playback.

Lit when "DOLBY NR" is ON.

Each press switches the modes as follows.

- ① "DOLBY NR" ON ..... DOLBY NR is used.
- ② "DOLBY NR" OFF ..... DOLBY NR is not used.

● Select the Dolby NR mode according to the recording condition of the tape.

Dolby noise reduction manufactured under license from Dolby Laboratories Licensing Corporation. "DOLBY" and the double-D symbol are trademarks of Dolby Laboratories Licensing Corporation.

**Transport direction indicators**

The indicators (◀, ▶) indicate the current direction in which the tape advances when playback or recording is started automatically by the easy operation function, etc. This direction is the direction stored in memory when the tape was last stopped. (To switch the tape transport direction, press the play key corresponding to the desired direction then press the stop (■) key.)

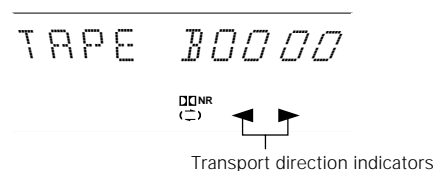

- Only the tape transport direction of deck B is shown when the selected input is other than TAPE.
- To see the tape transport direction of deck A, press the A/B key to switch to deck A.

Please play back tapes recorded with equalizer etc. without applying any effect.

### Relay play

When tapes are set in the decks A and B and the reverse mode is set to "↔" (play of both sides), play of the second deck will be started automatically after play of the first deck has been completed. Tape play will be repeated alternately.

- Relay play is not possible in the reverse modes "↔" and "↔".

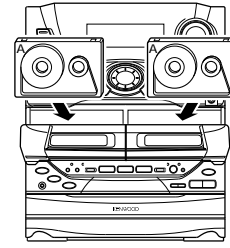

### A tip for use of the tape counter

The tape counter is set to "0000" when a cassette tape is loaded. By writing down the counter reading in case you want to interrupt recording (playback) in the middle of the tape, the memo will be helpful as a reference for locating the same position when continuing the recording (playback) the next time. The tape counter figure decrements during recording or playback of the back side (while the ◀ tape transport indicator is lit). To set the tape counter to "0000", open the cassette holder once. Then the counter will be reset.

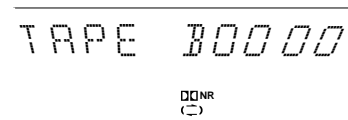

## Searching for the desired music program (DPSS)

The DPSS (Direct Program Search System) is capable of detecting non-recorded spaces of more than 4 seconds as "blanks between programs" and, based on this information, can return to the beginning of the music program being played or the beginning of a desired program by skipping up to 16 other programs.

### During play in direction ►

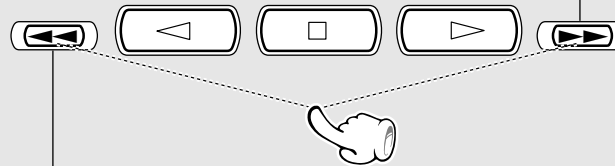
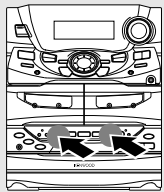

To play the next program : Press once.  
To play the 4th program after the current program : Press 4 times.

To return to the beginning of the current program : Press once.  
To play the 4th program before the current program : Press 5 times.

### During play in direction ◀

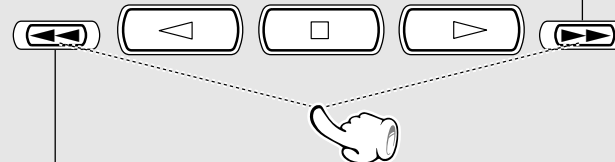

To return to the beginning of the current program : Press once.  
To play the 4th program before the current program : Press 5 times.

To play the next program : Press once.  
To play the 4th program after the current program : Press 4 times.



The DPSS may not function normally with the following kinds of tape.

- Tapes containing several no-sound intervals of more than 4 seconds, such as conversation and talk tapes.
- Tapes containing pianissimo sections, such as classical music tape.
- Tapes in which large noise is recorded in blanks between programs.
- Tapes containing blanks between programs that are shorter than 4 seconds.
- Tapes recorded at low level.
- Tapes recorded by cross-fade recording (in which the beginning of next program is overlapped on the end of previous program).

# Receiving broadcast station

It is also possible to receive them by one-touch operations by storing up to 40 stations in the preset memory.



When the BAND key is pressed, this unit will be switched on automatically.

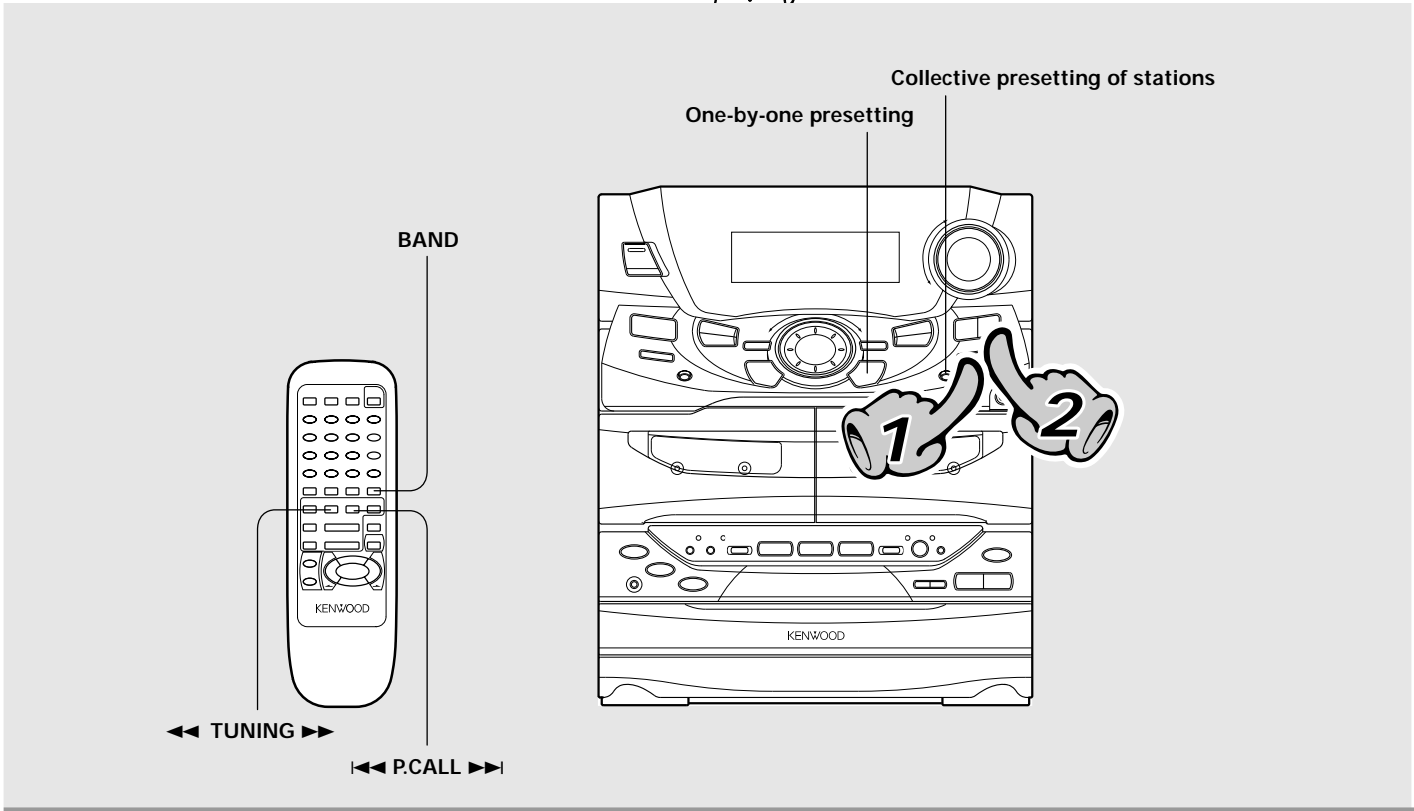

Basic section



## 1. Select the broadcast band.

Each press changes the band.

- ① FM
  - ② AM
- or
- ① FM
  - ② MW (AM)
  - ③ LW
- or
- ① FM
  - ② MW (AM)
  - ③ SW

•The broadcast bands are variable depending on the model (country or area).

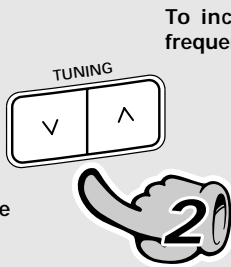

To increase frequency

To decrease frequency

## 2. Select a station.

When no stations have been memorized

**Auto tuning** : Each press receives the next station.  
**Manual tuning** : Press the key repeatedly or hold it depressed until a station is received.

When stations have been memorized (preset call)

Select a station.

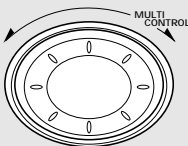

Remote control unit

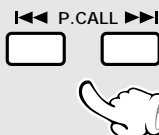

Every time the key is pressed, the preset stations are switched over as follows.

Press ►► for the order of 1→2→3 ... 38→39→40→1...  
 Press ◄◄ for the order of 40→39→38 ... 3→2→1→40...



### Collective presetting of stations (auto preset)

Keep the **AUTO** key depressed (about 2 seconds).



For Europe and U.K. (during FM reception)

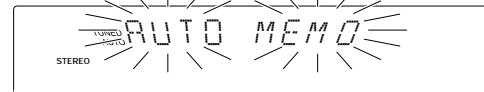

"MEMORY" is displayed during AM (MW) reception.

Other countries



### One-by-one presetting (manual preset)

1 Press the **ENTER** key during reception.



Presetting is cancelled when no operation is executed for 10 seconds or more.

2 Select one of the preset numbers from 1 to 40.

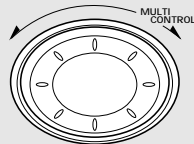

Presetting is cancelled when no operation is executed for 5 seconds or more.

3 Press the **ENTER** key again.



- With priority for FM, a maximum of 40 stations is preset automatically.
- When there are many stations and the intended station has not been preset, please also use "One-by-one presetting (manual preset)".
- The stations which have been preset manually are overwritten.

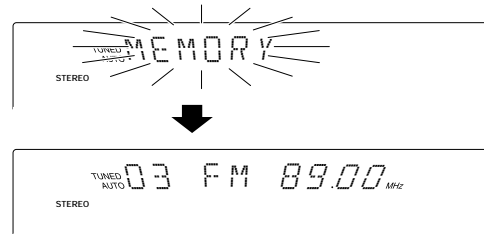

- Repeat steps 1-3 to preset other stations.
- If several stations are preset under the same number, the previous memory is replaced with the latest memory contents.

Example when an FM station is received

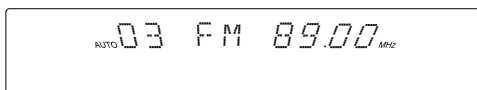

Example when an SW station is received

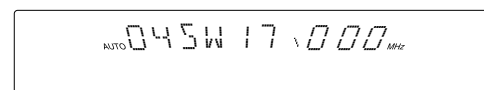

Lights during stereo reception

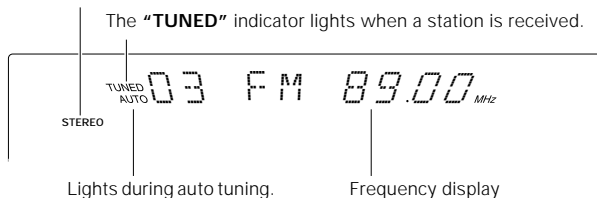

### Select the tuning mode.



Each press alternates the mode.

- 1 "AUTO" lit (Auto tuning)
- 2 "AUTO" not lit (Manual tuning)

Use the manual tuning mode when reception is noisy due to weak reception. (In the manual mode, stereo broadcasts are received in monaural.)

- Normally, use the **AUTO** (Auto tuning) mode.

- When a key is held depressed, preset stations will be skipped at an interval of about 0.5 second.
- Preset stations can also be recalled using the numeric keys of the remote control unit.

# Recording (Deck B only)



Note that this cassette deck cannot record onto Metal tapes.



When equalizer or another effect is applied to the sound, the sound with the applied effect can be recorded. → 50

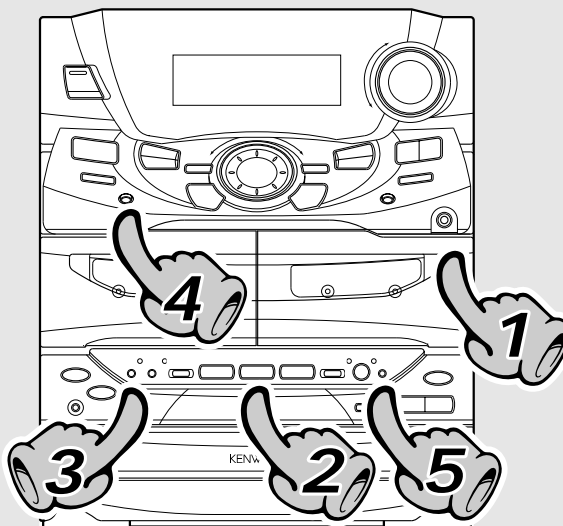
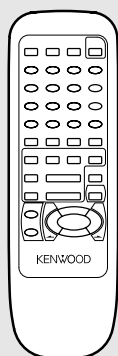

Basic section

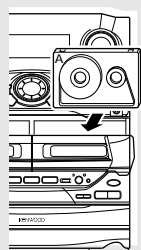

## 1. Load a tape in deck B.

- ❶ Open the door of deck B.
- ❷ Insert a tape.
- ❸ Close the door.

- Differentiation between normal (TYPE I) and high (TYPE II) tape is set automatically.
- Remove tape slack before loading.

(Except for some areas)

- When the microphone is not used, set the **MIC VOL.** control knob fully counterclockwise to the minimum position.

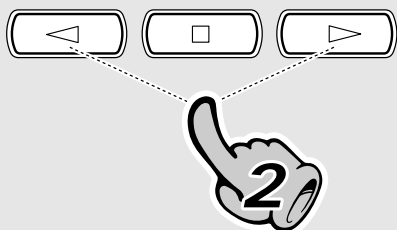

## 2. Select the tape transport direction.

To reverse the transport direction

- ❶ Press the play key corresponding to the desired direction.
- ❷ Stop playback (by pressing the □ key).

- When recording is started, the tape is transported in the direction selected in this step.
- Wind the tape to the position where recording is to be started.

Check the tape transport direction indicator.

TAPE 30000

DO NR



REV.MODE    DOLBY NR

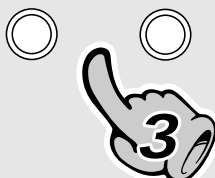

## 3. Set the recording condition.

- ❶ Select the reverse mode.
- ❷ Select the Dolby NR mode.

### Selection of the reverse mode



Each press switches the modes as follows.

- ① "↔" ... Both sides are played back (recorded), and then the tape stops.
- ② "↔" .. Both sides are played back endlessly. (The tape stops after recording onto both sides.)
- ③ "↔" .. Only one side is played back (recorded), and then the tape stops.

### Selection of DOLBY NR (Noise Reduction)

The Dolby NR system minimizes the hiss noise heard when playing tape. When playing a tape prerecorded with Dolby NR ON, be sure to set the DOLBY NR ON for playback.



Lit when "DOLBY NR" is ON.

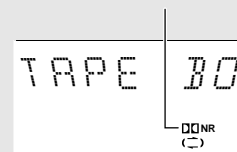

Each press switches the modes as follows.

- ① "DOLBY NR" ON ..... DOLBY NR is used.
- ② "DOLBY NR" OFF ..... DOLBY NR is not used.



Select an input source other than "TAPE".

### 4. Select the source to be recorded.

The input source component to be recorded should be displayed.

- ① TUNER (Radio)
- ② CD
- ③ TAPE
- ④ AUX (External input)

(AUX INPUT LEVEL adjustment → 49)

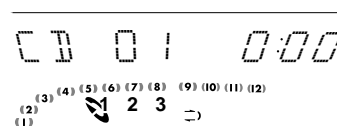

- When the CD input is selected and if a disc has been set in the CD player, its playback starts immediately.

REC/ARM



### 5. Start recording.

- ① Play (or tune) the input source to be recorded.
- ② Start recording.

- Recording stops automatically when the tape side(s) to be recorded have been fully recorded.
- The beat cancel function can be used when recording MW broadcasts. → 32

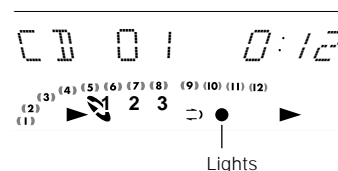

### To pause recording

REC/ARM



- Pressing the key pauses recording after leaving a non-recorded space of about 4 seconds.
- If the key is pressed again in less than 4 seconds after it has been pressed, recording resumes from that instant.

### Beat cancel function

There may be cases in which beat noise interferes with recording of MW/LW broadcasting.

In such a case, press the A/B key during recording to reduce or suppress the beat noise. The A/B key acts as the demonstration key except during tuner recording.

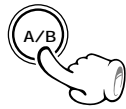
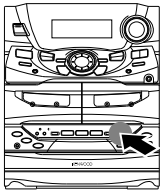

### Points in CD recording

When recording CD tracks onto a tape, if you leave the cassette deck in record-pause mode beforehand, the cassette deck recording can be started at the same time as the CD starts to be played. (Synchro recording function)



- ❶ Put the CD player in pause mode.
- ❷ Select the track to be recorded with the skip (◀◀, ▶▶) keys.  
(The CD player pauses at the beginning of the selected track.)
- ❸ Put the cassette deck in Record-pause mode.  
(Press the REC/ARM key twice.)
- ❹ Start playing the CD.  
(Synchro recording starts)

→ 31

- Recording stops when the stop key of the CD player is pressed.



## Copying tape (Tape dubbing)

The contents of the tape in deck A can be copied onto the tape in deck B.

**1** Select the "TAPE" input.

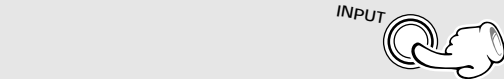

**2** Select "↔" (double-side recording) or "→" (one-side recording).

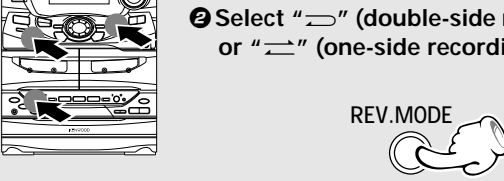

**3** Press the DUBBING key.



**4** Select "TAPE DUBBING" and press the SET key.

1. Select.      2. Press SET.

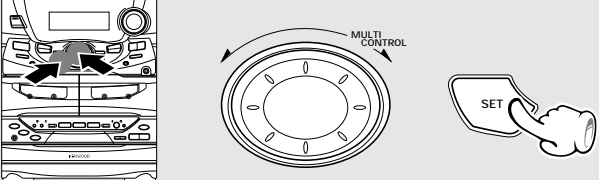

**5** Use the same tape transport directions.

(1) Select the transport direction of deck A.

1. Select.      2. Press SET.

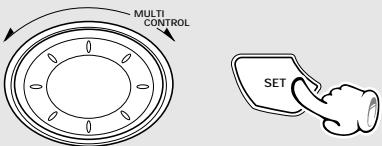

(2) Select the transport direction of deck B.

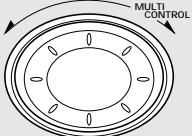

**6** Start dubbing.



### Load tapes in the decks.

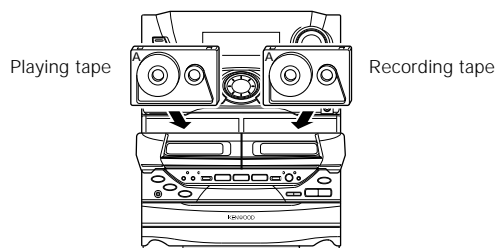

- CD RECORD
- CD EDIT
- CD PGM RECORD
- TAPE DUBBING

TAPE DUBBI

← Scrolled display (TAPE DUBBING)

- When recording is started, the tape will be transported in the direction selected in this step.

Check the tape transport direction indicators.

- A DIR FWD
- A DIR RVS

A DIR FWD

- B DIR FWD
- B DIR RVS
- RETURN

- By selecting "RETURN" and pressing the **ENTER** key, the operation returns to the previous step so the current step can be restarted.
- Dubbing ends automatically when the side(s) to be dubbed has been completed.

### To stop dubbing

REC/ARM



- The deck B will stop after creating a non-recorded portion of about 4 sec, and then the deck A will stop.
- Dubbing can also be stopped by pressing the stop (■) key. Note that the non-recorded space is not created in this case.



The **DOLBY NR** key is not active in dubbing mode. The tape recorded on deck B assumes the same Dolby NR condition as the tape played on deck A.

## Listening in the desired sequence (program playback)

Any titles on the discs in the tray can be listened to in the desired sequence. (Max. 32 titles)

Select the "CD" input.

**1** Check that the CD player is in the stop mode.

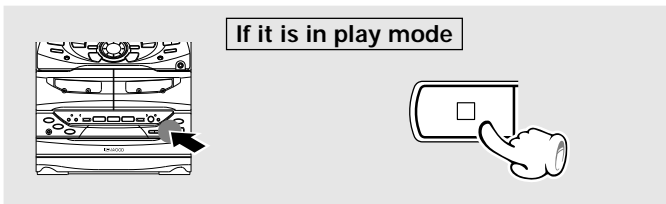

- Press the CD PGM key during to program the track being played.

**2** Press the CD PGM key.



**3** Enter track Nos. in the order you want to play them.

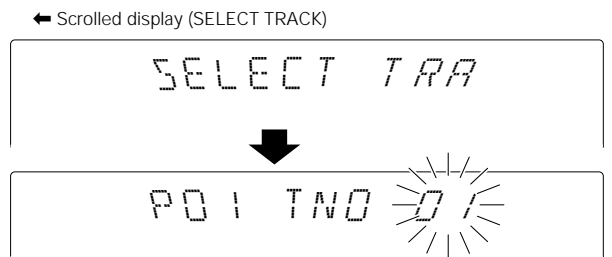
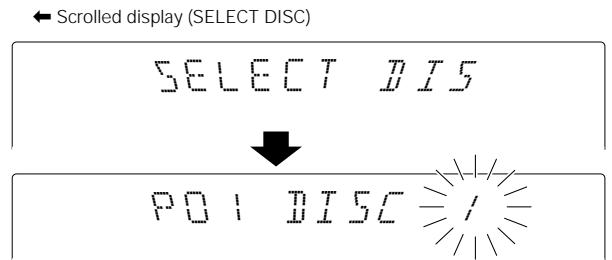
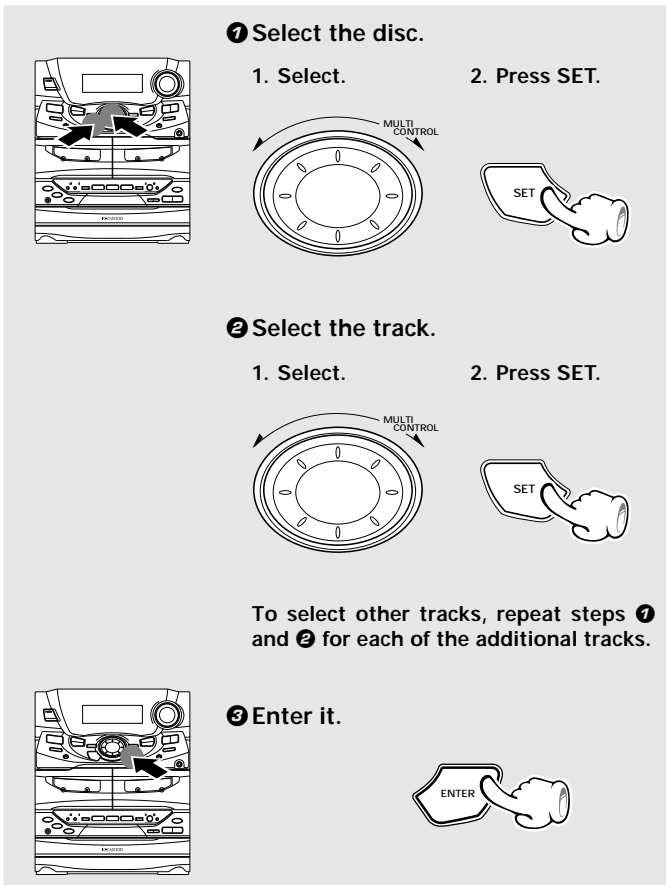

- Even if you program a disc or track which does not exist in the tray, it is deleted automatically in playback.

- Up to 32 tracks can be programmed. When "FULL" is displayed, no more tracks can be programmed.

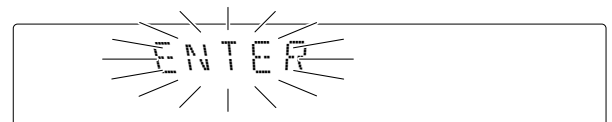

#### 4 Check the programmed tracks (and replace, add or delete tracks as required).

To check:

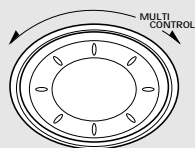

P 0 1 D 2 T 0 2

- The programmed tracks are displayed in sequence.

To replace a track in the program:

- 1 Select the programmed disc or track to be replaced and press the SET key.

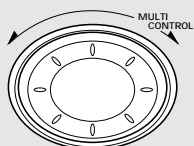

- 2 Select a disc or track to replace the disc or track selected above (step 1 and 2).

P 1 2 ~~0 3~~ T 0 4

- The blinking item can be replaced.

To add a track to the program:

- 1 Select the display as shown on the right and press the SET key.

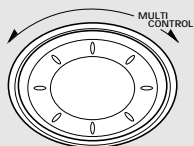

- 2 Perform the same operations as in step 1-1 and 2.

P - - D - T - -

- The added track number is added to the end of the existing program.

To delete a track from the program:

- 1 Select the programmed disc or track to be cleared and press the SET key.

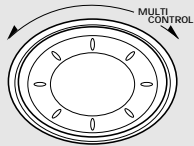

- 2 Select "CLEAR" and press the SET key.

P 1 2 ~~0 3~~ T 0 4  
 ↓  
 P 1 2 CLEAR

To end the above operation:



To perform an operation in step 4 after ending it, press the CD PGM key once.



#### 5 Start playback.

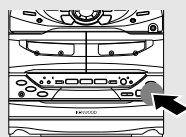

- When the ◀◀ or the ▶▶ key is pressed during play, the program will jump to the preceding or the following track respectively.
- When the ◀◀ key is pressed once during playback, the play position returns to the beginning of the current track being played.

To quit the program mode

Press twice.  
(at an interval of 2 sec. or more)

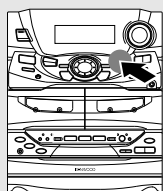

Remote control unit

- If you are using the remote control unit, press the key once again while "CD PGM" is displayed.

PGMD 1 T 0 1  
 ↓  
 CD 0 1 0 0 0

- If the key is pressed during playback, normal playback in order of tracks resumes from the current track.

# Repeated playback

Desired titles or discs can be played back repeatedly.

Select the "CD" input.

## To repeat a disc

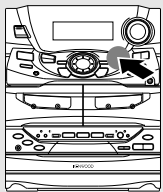

- 1 Confirm that the "PGM....." indicator is not lit.



If the "PGM....." indicator is lit, press the CD PGM key to turn it off.



CD 01 0:00

- 2 Press to select "DISC REPEAT".

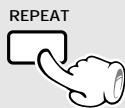

Press the key repeatedly to switch the display.

- 1 REPEAT
- 2 DISC REPEAT
- 3 ALL REPEAT
- 4 REPEAT OFF

← Scrolled display (DISC REPEAT)

DISC REPEAT

- 3 Select the disc.



## To stop repeated playback

Press the REPEAT key 3 times to select "REPEAT OFF".

## To repeat all discs

- 1 Confirm that the "PGM....." indicator is not lit.

If the "PGM....." indicator is lit, press the CD PGM key to turn it off.



CD 01 0:00

- 2 Press to select "ALL REPEAT".



Press the key repeatedly to switch the display.

- 1 REPEAT
- 2 DISC REPEAT
- 3 ALL REPEAT
- 4 REPEAT OFF

← Scrolled display (ALL REPEAT)

ALL REPEAT

- 3 Select the disc to be played first.



## To stop repeated playback

Press the REPEAT key twice to select "REPEAT OFF".

Select the "CD" input.

### To repeat only one track

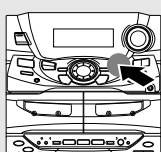

1 Confirm that the "PGM....." indicator is not lit.



If the "PGM....." indicator is lit, press the CD PGM key to turn it off.



2 Select "REPEAT".



Press the key repeatedly to switch the display.

- 1 REPEAT
- 2 DISC REPEAT
- 3 ALL REPEAT
- 4 REPEAT OFF

REPEAT



3 Select the disc.



4 Select the track.

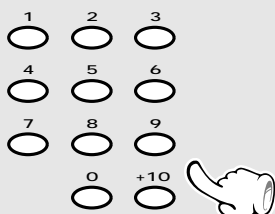

### To stop repeated playback

Press the REPEAT key 4 times to select "REPEAT OFF".

### To repeat only the programmed tracks

1 Perform the procedure in "Listening in the desired sequence (program playback)" till step 4 to program the desired CD tracks. → 34 → 35



2 Select "PGM REPEAT".



• All of the programmed tracks will be played repeatedly.

Press the key repeatedly to switch the display.

- 1 PGM REPEAT
- 2 REPEAT OFF

PGM REPEAT



3 Start playback.

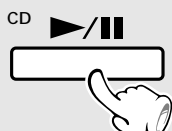

### To stop repeated playback

Press the REPEAT key twice to select "REPEAT OFF".

# Listening to an unexpected title sequence (random playback)

As the titles each time are selected randomly, the music can be enjoyed without getting tired of it.

Select the "CD" input.

## 1 Confirm that the "PGM....." indicator is not lit.

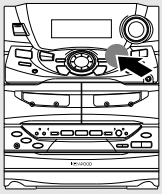

If the "PGM....." indicator is lit, press the CD PGM key to turn it off.



CD 01 0:00

## 2 Select the RANDOM mode.

For "ONE DISC RANDOM" playback, select the disc in advance.



Press the key repeatedly to switch the display.

- ① ONE DISC RANDOM ..... Random play of one disc
- ② ALL RANDOM ..... Random play of all discs
- ③ RANDOM OFF (Normal playback)

Random play of one disc  
← Scrolled display  
(ONE DISC RANDOM)

Random play of all discs  
← Scrolled display

DISC RANDO  
↓  
D RNDM T02

ALL RANDOM  
↓  
A RNDM T02

● Playback stops after each title has been played once.

### To select another track in the middle of playing one



● Pressing the P.CALL key once returns to the beginning of the track being played.

### To repeat random playback

Select "RANDOM REPEAT".

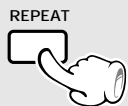

Press the key repeatedly to switch the display.

- ① REPEAT OFF
- ② RANDOM REPEAT

### To cancel random playback

Select "RANDOM OFF".



RDS is a system which transmits useful information (digital data) for FM broadcasts together with the broadcast signal. Tuners and receivers designed for RDS reception can extract the information from the broadcast signal for use with various functions such as automatic display of the station name.

## This unit is equipped with the following functions utilizing RDS data:

### PTY (Program Type Identification) Search : 40

The tuner automatically searches for a station which is currently broadcasting a specified program type (genre).

### PS (Program Service Name) Display : (See below.)

When an RDS broadcast is received, the station name is automatically displayed.

### EON (Enhanced Other Network) : 42

When the information to be received is set in advance and any RDS station in the same network starts broadcasting of such information, the reception automatically will be switched to that station.

The "RDS" indicator lights up when an RDS broadcast (signal) is received.

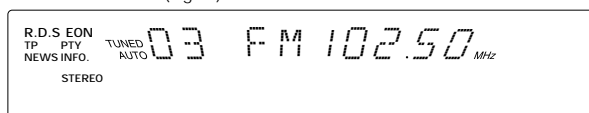

- Some functions may not be provided or be given different names depending on countries or areas.

## Note before the use of RDS

To receive RDS stations, you have to preset RDS stations using the auto preset function. The auto preset function presets the RDS stations in priority. Flashing "NO DATA" will be displayed when no RDS station has been preset with this function.

Set the receiving band to FM and preset RDS stations with the auto preset function.

## To switch the display contents

Pressing the RDS DISPLAY key changes the display contents.



## Display mode priority ranking

When an RDS broadcast is received :

- ① PS (Program Service Name) Display :  
When an RDS broadcast is received, the station name is automatically displayed.  
If no PS data was sent, "NO PS" is displayed.



- ② Frequency Display :  
The frequency of the current station is displayed.

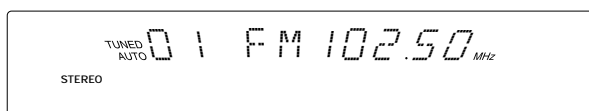

## Searching for a desired program type (PTY search)

By specifying the type of program (genre) you want to listen to, the tuner automatically searches for a station which is currently broadcasting a program of the specified type.

Set the reception band to FM. Preset RDS stations with the auto preset function. → 29

### 1 Select the PTY search mode.

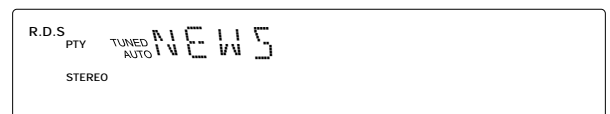
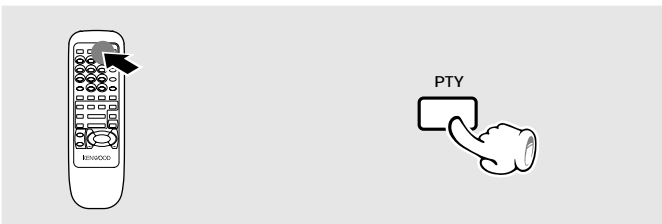

When an RDS broadcast is received, the program type is shown on the display. If no PTY data is available, or if the station is not an RDS station, "NONE" is displayed.

### 2 Select the desired program type.

Use program type table on the right for your convenience.

Ⓐ To select using the P.CALL (◀▶) keys

Select while "PTY" is lit.

The P.CALL (◀▶) keys can be used to select one of the 29 program types by displaying them in sequence. Press and hold the key and release it when the desired program type appears.

Ⓑ To select using the numeric keys

The numeric keys can be used to specify the desired program type directly by selecting a number between 01 and 28.

**Example:**  
To select 23: Press **+10** **+10** **3**.

Program type table

Ⓐ ◀▶ keys	Ⓑ	Program Type Name	Display
	01	Pop Music	POP M
	02	Rock Music	ROCK M
	03	*M.O.R. Music	M.O.R. M
	04	Light Classical	LIGHT M
	05	Serious Classical	CLASSICS
	06	Other Music	OTHER M
	07	News	NEWS
	08	Current Affairs	AFFAIRS
	09	Information	INFO
	00	Sport	SPORT
	10	Education	EDUCATE
	11	Drama	DRAMA
	12	Culture	CULTURE
	13	Science	SCIENCE
	14	Varied	VARIED
	15	Weather	WEATHER
	16	Finance	FINANCE
	17	Children's programmes	CHILDREN
	18	Social affairs	SOCIAL A
	19	Religion	RELIGION
	20	Phone in	PHONE IN
	21	Travel	TRAVEL
	22	Leisure	LEISURE
	23	Jazz music	JAZZ
	24	Country music	COUNTRY
	25	National music	NATION M
	26	Oldies music	OLDIES
	27	Folk music	FOLK M
	28	Documentary	DOCUMENT

\*M.O.R. Music (Middle of the Road Music)



### 3 Start the search.

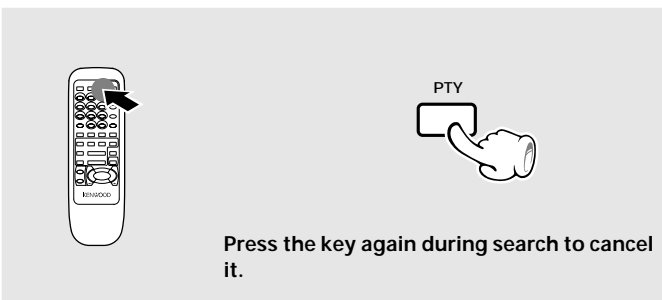

#### When searching for a Rock Music broadcast

##### Display while the tuner is searching.

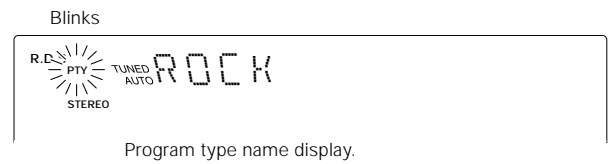

#### When a station is received.

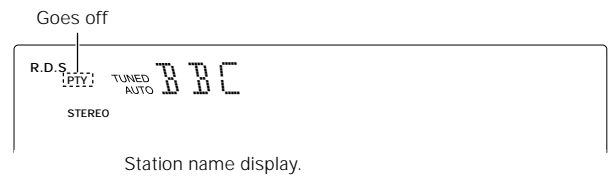

#### To change to a different program type :

Repeat steps 1, 2, 3.

- No sound is heard while "PTY" is blinking.
- If a program of the desired type cannot be found, "NO PROG" is displayed, then after several seconds the display returns to the original display.
- If a program of the desired type is found, that program is received and the program type name display changes temporarily to the frequency display, and then to the station name display.

# To be able to listen to the desired information at any time

By using the EON function, which manages the information of other stations, listening to desired information like traffic information or news etc. can be reserved even when it is not being transmitted at the present. When listening to a station with the "EON" display lit and another station of the same network starts to broadcast an information program for which a reservation has been made, then that station will be selected automatically. When the desired information program ends, return is made to the original program.

Set the reception band to FM. → 28

## 1 Auto preset the stations.

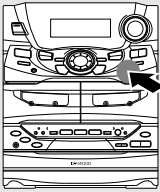

- 1 Receive a broadcast.
- 2 Keep the AUTO key pressed (2 sec or longer).





The EON data presently being broadcasted are taken in automatically.



This is not required when auto presetting has already been executed. → 29

- When all 40 stations have already been preset by the procedure for "One-by-one presetting", the EON function will not operate. Auto presetting must be used.

## 2 Select the desired information.

Each press switches the modes as follows.

- 1 TA ..... Traffic Announcement
- 2 NEWS ..... News
- 3 INFO. .... Information
- 4 Display not lit ..... EON cancelled

Lights with a station broadcasting traffic announcement programs.

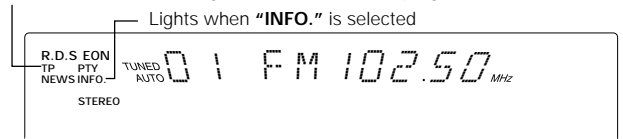

- Please execute automatic presetting when TA, NEWS, and INFO. can not be selected.

## 3 Receive an RDS station.

Select a station where "RDS" and "EON" are lit.

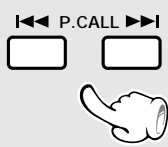
"RDS" and "EON" are lit

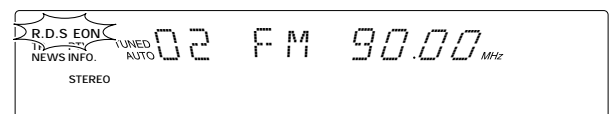

- When "EON" does not light although an RDS station is received, that station is not transmitting EON data. Please select a different station.
- If you want TA programs, select the stations with which the "TP" indicator lights.

#### **4** Wait for the desired information.

CD or tape playback may also be started.  
As long as the unit is ON, the unit is always ready for the reception.

#### **Waiting for information while a RDS station without EON function is tuned**

If the EON indicator does not light with the RDS station in steps **2** and **3**, the tuner will wait for only the desired information broadcast from the tuned RDS station provided that the desired information has been selected in the previous step.

- When one of the stations of the network of the station received in **3** starts broadcasting the program contents selected in **2**, that station will be received automatically. At this time, tape playback will stop and CD playback will pause. However, external equipment (AUX) will remain as it is.
- When the power is OFF and during recording (including dubbing), the EON function does not operate.
- When the transmission of the selected program contents ends in case of automatic reception with the EON function, return will be made to the status directly before operation of the EON function. When tape or CD playback has been interrupted, it will be continued from the point of interruption.

#### **TP (Traffic Program) indicator**

The lighting of the TP indicator indicates that the currently tuned station or a station in the same network as it broadcasts traffic announcement programs. If the TP indicator already lights with the current station, you can listen to the traffic announcement program through the station without making reservation with the EON function.

## Selection of the convenient CD recording type

With this unit, the following edit recording is possible according to the purpose.



Note that this cassette deck cannot record onto Metal tapes.

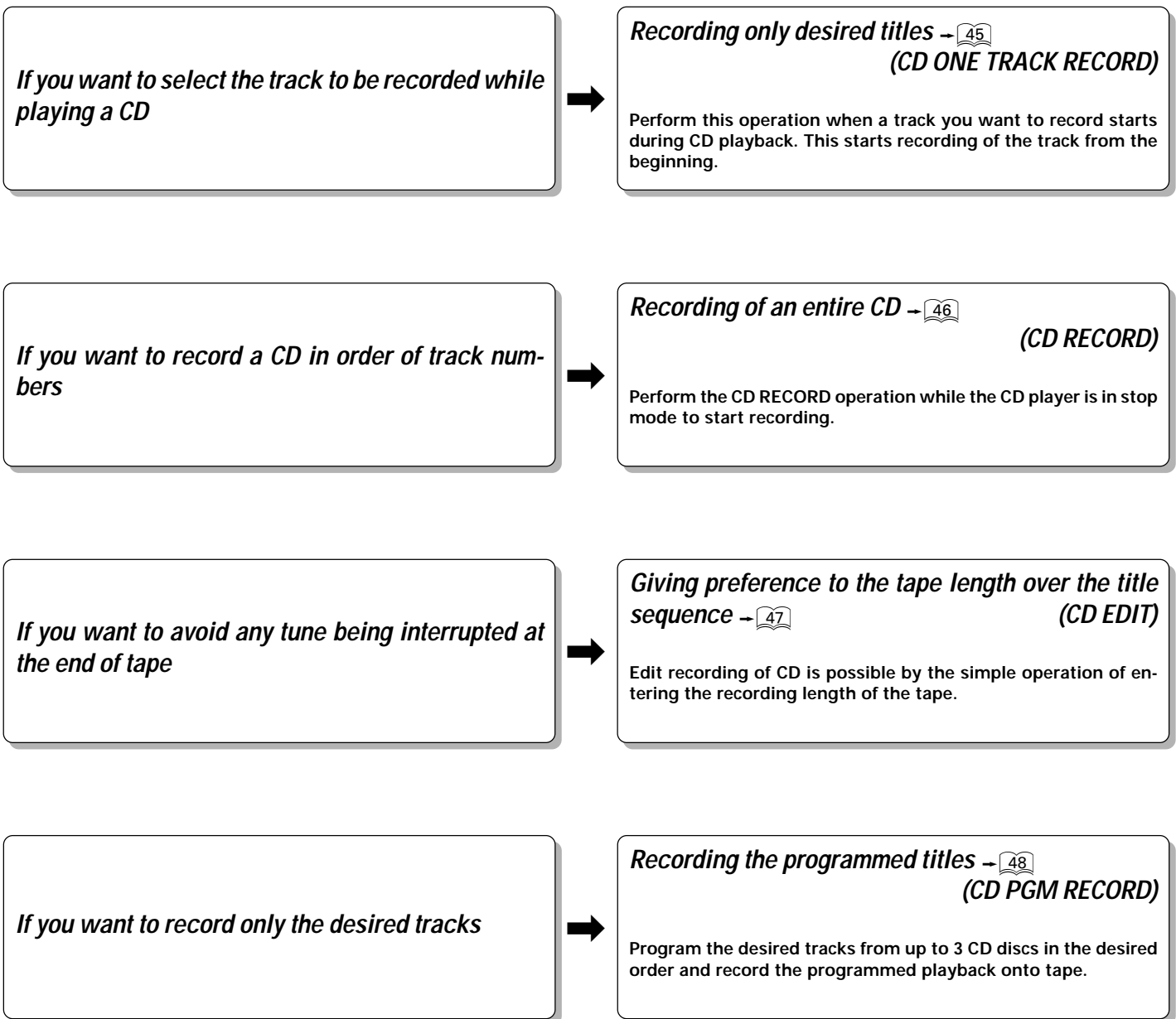

# Recording only desired titles (CD ONE TRACK RECORD)

At the time of CD playback, any desired title can be selected immediately for recording.



When equalizer or another effect is applied to the sound, the sound with the applied effect can be recorded. — 50

Recording preparations are required. — 30 (Steps 1 to 4)

## 1 Playback of CD.

Select a mode other than random play.

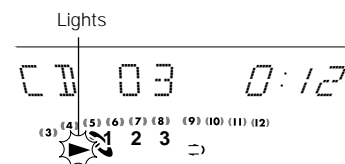

## 2 Press the DUBBING key.

In case the key is pressed with track No.3

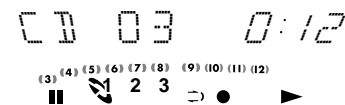

## 3 Select "CD ONE TRACK RECORD".

- CD ONE TRACK RECORD
- CD RECORD
- CD EDIT
- CD PGM RECORD



← Scrolled display (CD ONE TRACK RECORD)

## 4 Start recording.

Press the ENTER key.

- Playback restarts from the beginning of the track being played and recording starts at the same time.

### To end recording in the middle

- Both the cassette deck and CD player stop.

When recording has been completed, a non-recorded portion of 4 seconds will be produced and the cassette deck part will stop. The CD player will enter temporary stop condition.

To record a different track, repeat the steps 1 to 4.



## Recording of an entire CD (CD RECORD)

Perform the following operation while the CD player is in stop mode to start recording at the same time as the start of playback.



When equalizer or another effect is applied to the sound, the sound with the applied effect can be recorded. → 50

Recording preparations are required. → 30 (Steps 1 to 4) (For the reverse mode, select "▷" (two-way recording).)

### 1 Press the DUBBING key.

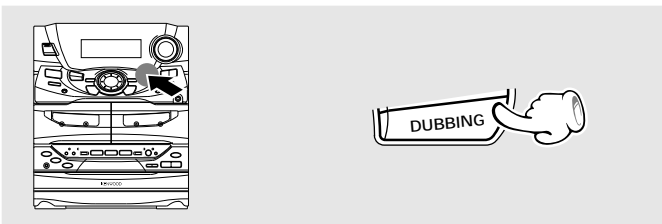

### 2 Select "CD RECORD".

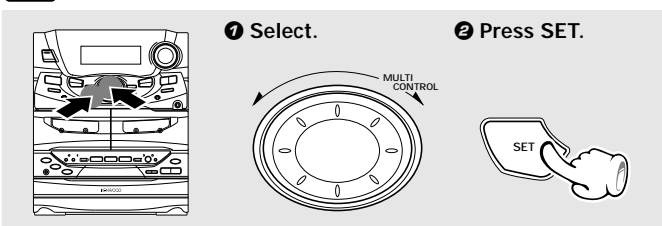

CD RECORD  
CD EDIT  
CD PGM RECORD  
TAPE DUBBING

(Only when the selected input is TAPE and tapes are present in both decks A and B)

CD RECORD

### 3 Select the disc.

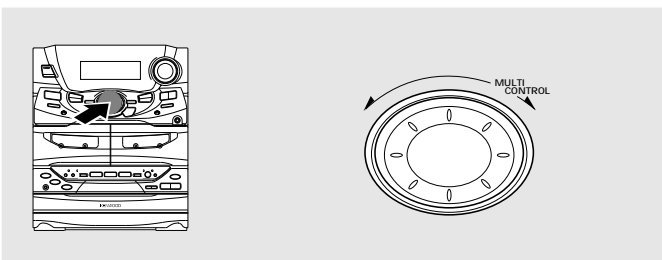

DISC 2

### 4 Start recording.



- Recording of CD starts at the same time as playback.
- At the end of tape, the music is not recorded on the leader tape portion. If you do not want any music to be interrupted in the middle, refer to "Recording" and start recording of side B with the interrupted track. → 30

### To end recording in the middle

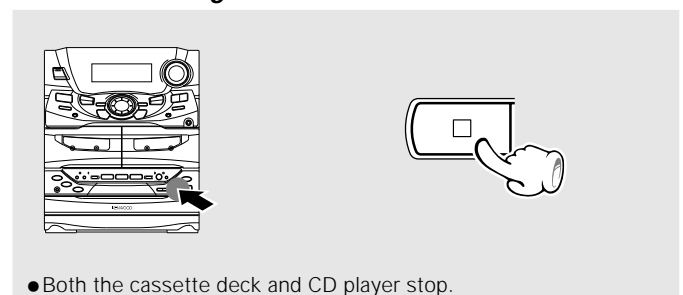

- Both the cassette deck and CD player stop.

# Giving preference to the tape length over the title sequence (CD EDIT)

When the tape recording time is specified, recording is executed with changing the title sequence so that no title will be interrupted when the tape direction is changed at the end of one side.



When equalizer or another effect is applied to the sound, the sound with the applied effect can be re-recorded. → 50

Recording preparations are required. → 30 (Steps 1 to 5) (For the reverse mode, select "▷" (two-way recording).)

## 1 Press the DUBBING key.



## 2 Select "CD EDIT" and press the SET key.

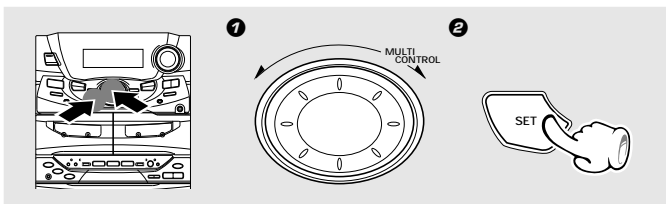

## 3 Select a disc and press the SET key.

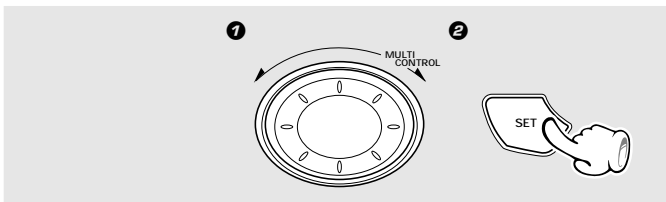

## 4 Set the tape length (recording time) and press the ENTER key.

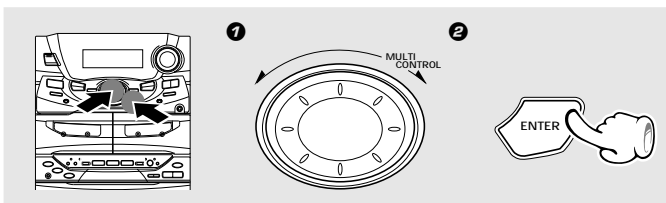

## 5 Start edit recording.



Press the CD PGM key twice to cancel CD EDIT.

CD ONE TRACK RECORD (Only during CD playback)  
 CD RECORD  
 CD EDIT  
 CD PGM RECORD  
 TAPE DUBBING

CD EDIT

(Only when the selected input is TAPE and tapes are present in both decks A and B)

DISC 2

• Even if the disc has already been selected, select the disc again.

C-60  
 ↓  
 Automatic editing of tape sides A and B  
 ↓  
 ENTER

EDIT A TO 1  
 ⏪ 1 2 3 ⏩ ● ▶

- The tape and CD stop automatically when recording has completed.
- Press the stop (■) key to stop recording in the middle.
- If you commit an error in the time entry, restart the procedure from step 1.



Depending on the combination of conditions from CD contents (number of titles and length of the titles) and tape recording time, interruption of a title may not be avoidable. In such a case, the respective title will not be recorded.

## Recording the programmed titles (CD PGM RECORD)

Program the desired tracks from up to 3 CD discs in the desired order and record the programmed playback onto tape.



When equalizer or another effect is applied to the sound, the sound with the applied effect can be recorded. → 50

Recording preparations are required. → 30 (Steps 1 to 3)

### 1 Press the DUBBING key.

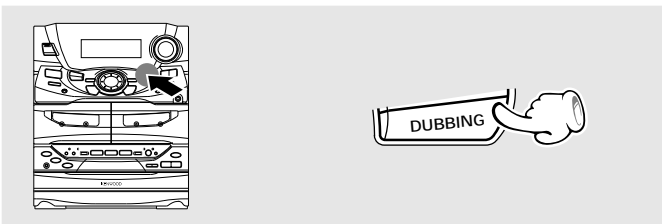

### 2 Select "CD PGM RECORD".

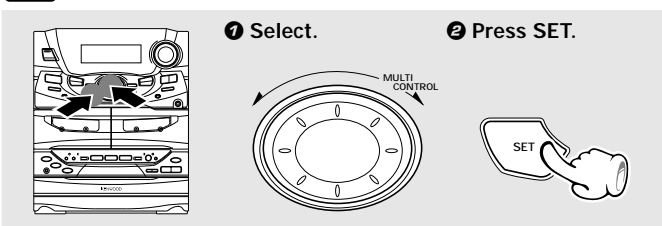

- CD ONE TRACK RECORD (Only during CD playback)
  - CD RECORD
  - CD EDIT
  - CD PGM RECORD
  - TAPE DUBBING
- (Only when the selected input is TAPE and tapes are present in both decks A and B)

CD PGM REC

← Scrolled display (CD PGM RECORD)

### 3 Program the desired tracks.

- 1 Select tracks in the order you want to play them.

(Perform step 2 on page 34.)

- 2 Check, replace, add or delete the programmed tracks as required.

(Perform step 2 on page 35.)

### 4 Start recording.

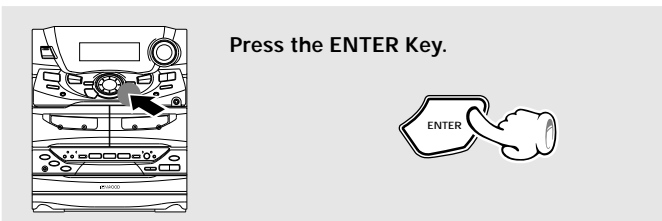

Press the ENTER Key.

### To end recording in the middle

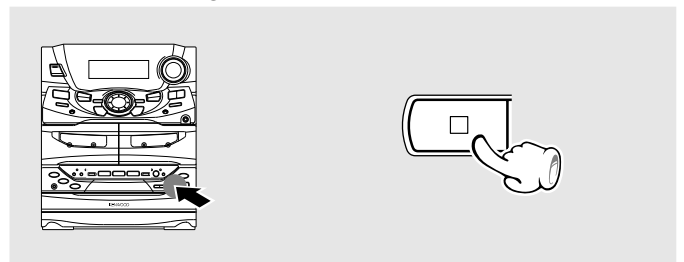



This unit permits selection of equalizer and sound field playback. Please select the equalizer as desired according to the music genre. Select the sound field mode according to the desired atmosphere.

## Adjustment of balance and input level

Balance..... Adjusts the balance of left and right volume.

Input level..... Adjusts the volume of external equipment (video deck etc.) connected to the AUX terminal. Please adjust as required when the volume from external equipment is too high etc.

### Balance adjustment :

**1** Press the **MODE/DEMO** key.

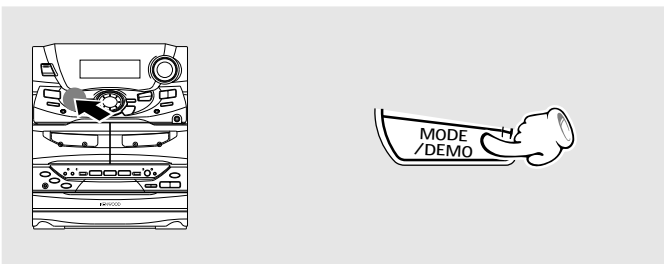

**2** Select **"L/R BALANCE"**.

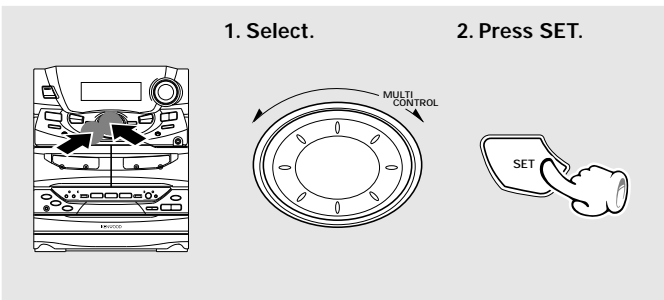

→ SRS LEVEL  
S.W. (Except for the XD-5...series)  
→ L/R BALANCE

← Scrolled display (L/R BALANCE)

L R BALANC

● When SRS 3D is ON, "SRS LEVEL" (strength of the 3D effect) also is displayed.

**3** Adjust.

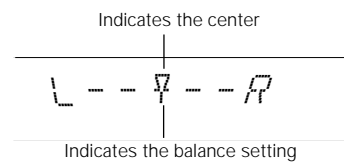
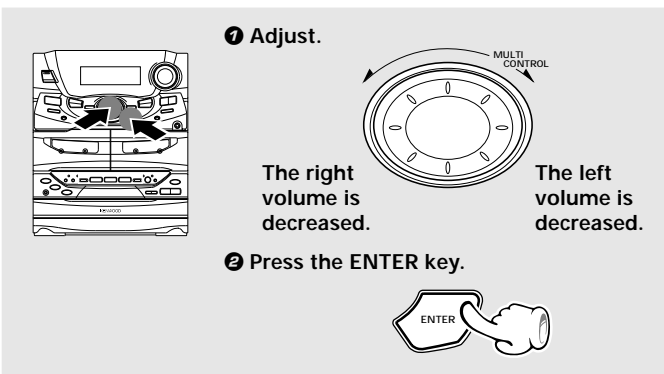

### Input level adjustment :

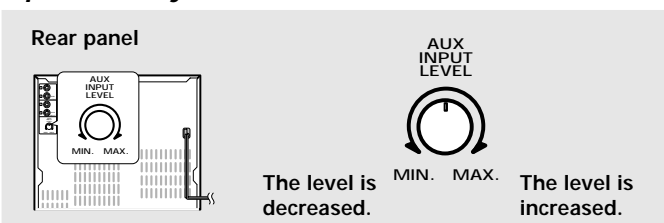

Adjusts the volume of external equipment (video deck etc.) connected to the AUX terminal. Please adjust as required when the volume from external equipment is too high etc.

● Sound is not output at the MIN. position.



# Listening with the desired sound (equalizer function)

In addition to the 4 kinds of equalizer patterns which have been preset at the factory, 3 equalizer patterns created manually by the user can be stored in memory and recalled any time.

A SOURCE DIRECT mode is provided for simple audio reproduction by defeating the EX.BASS and SRS 3D circuits.

## Selecting an equalizer pattern

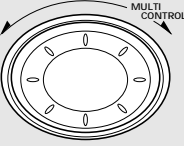
It is possible to select the desired equalizer pattern according to the category of the played music. The graphic equalizer effect can be recorded together with the sound.

- 1 Play desired music.
- 2 Switch on the equalizer mode.
 
- 3 Select the desired equalizer pattern.
 
- 4 Press the ENTER key.
 



### Equalizer patterns which can be recalled

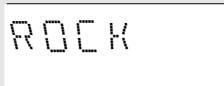

- ▶ ROCK ..... Rock music
- ▶ POP ..... Pop music
- ▶ CLASSIC ..... Classic music
- ▶ JAZZ ..... Jazz music
- ▶ MANUAL EQ1
- ▶ MANUAL EQ2
- ▶ MANUAL EQ3
- ▶ EQ. OFF ..... Canceled.
- ▶ SOURCE DIRECT ..... For simple audio reproduction by defeating the EX.BASS and SRS 3D circuits.



- On the remote control unit, each press of the EQ. ON/OFF key switches the on/off of equalizer patterns.
- To cancel the equalizer effect, select "EQ.OFF" or press the EQ. ON/OFF key of the remote control unit.

Application section

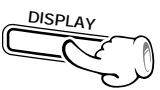
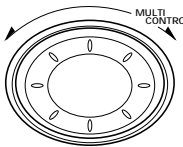
## Switching the spectrum analyzer display mode

- 1 Press the DISPLAY key.
 
- 2 Select the DISPLAY mode.
 
  - ▶ DISPLAY AUTO
  - ▶ DISPLAY 1
  - ▶ DISPLAY 2 (Normal display)
  - ▶ DISPLAY 3
- 3 Press the ENTER key.
 

### Example of reference mode display

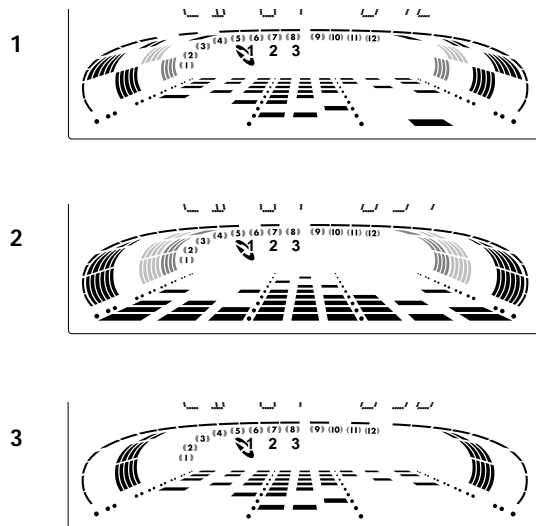

- When DISPLAY AUTO is selected, the display mode is switched in sequence from 1 to 3 every time a track changes during CD playback.

## Creation and memorizing of an equalizer pattern

You can edit desired patterns manually and store them in memory.

❶ Switch on the equalizer mode.

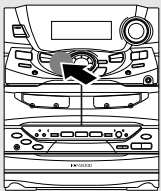

❷ Select the number to be used for storage.  
(MANUAL EQ1 - EQ3)

1. Select.

2. Press SET.

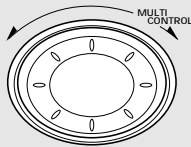
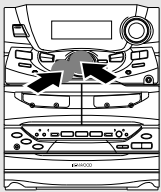

- ROCK
- POP
- CLASSIC
- JAZZ
- MANUAL EQ1
- MANUAL EQ2
- MANUAL EQ3
- EQ. OFF
- SOURCE DIRECT

MANUAL EQ 1

Go to step ❸ within 15 sec.

❸ Adjust the equalizer pattern.

1. Adjust the level.

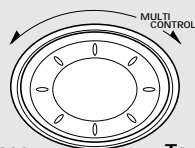

To decrease the level

To increase the level

2. Press the SET key.

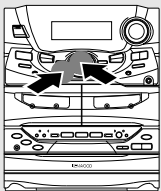

The LOW, MID and HIGH frequency bands can be adjusted independently by repeating step ❸ for each of them.

❹ Store the pattern in memory.

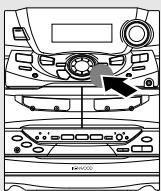

● Wait until "LEVEL ??", or "ENTER" is displayed before pressing the key. (?? = -8 to +8)

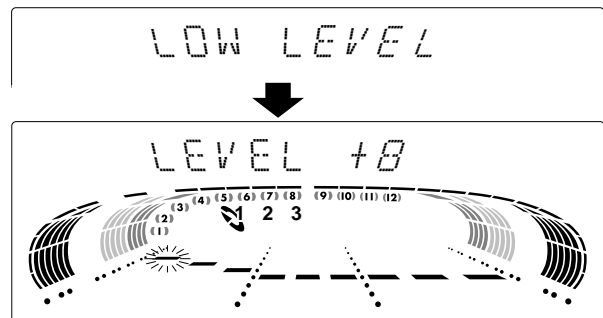

● Each frequency band can be adjusted in the range between -8 and +8.

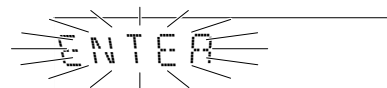

# Enjoying Sound Field Effects

## Experiencing SRS 3D (Sound Retrieval System)

The Sound Retrieval System is an epochal system which produces a three-dimensional sound space by applying the most suitable processing to the sound signal on the basis of the human listening mechanism. This permits real depth and sound location, considered as difficult to realize with conventional 2-channel stereo (general stereo). A sufficient effect can be obtained for any source (CD, tape, broadcasts, etc.). Recording with applied SRS 3D also is possible.

### 1 Set SRS 3D to ON.

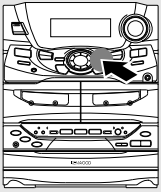

Each press of the key switches SRS 3D on and off alternately.

← Scrolled display (SRS 3D ON)

SRS 3D ON

### 2 Press the MODE/DEMO key.

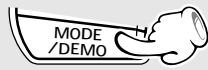

### 3 Select "SRS LEVEL".

1. Select.

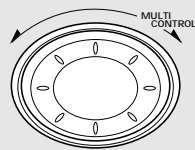
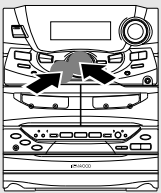

2. Press SET.



SRS LEVEL  
S.W. LEVEL (Except for the XD-5...series)  
L/R BALANCE

### 4 Adjust the effect strength (level).

1. Adjust.

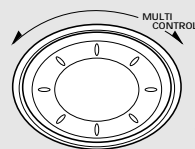
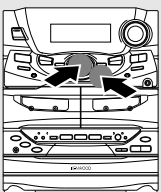

The level decreases.

The level increases.

2. Press ENTER.



● SRS 3D ON/OFF switching is not possible during recording.

SRS LEVEL



LEVEL +5

Level display

● Adjustment is possible in the range from -8 to +8.  
● Please set as desired according to the titles being played back etc.

## Enjoying Karaoke (Except for some areas)

When CDs or tapes with recorded voice and instrument music are played, it is possible to lower the volume only for the voice part. In combination with mic mixing, this permits easy enjoyment of Karaoke.

### 1 Connect a microphone.

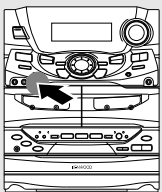

- Turn the MIC VOL. control fully counterclockwise.

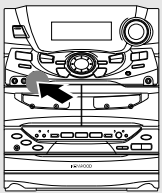

- Plug the microphone into one of the MIC jacks.

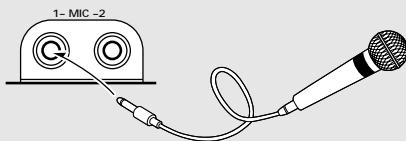

- Adjust the volume balance between the music input and microphone input.



To decrease  
microphone  
volume

To increase  
microphone  
volume

### 2 Play the music.

### 3 Sing along with the accompaniment.

After the above steps, you can record your karaoke singing onto a tape. However, note that the karaoke singing using a tape cannot be recorded onto a tape.



- Set the **MIC VOL.** control knob to the fully counterclockwise position when the microphone is not used.

---



---

- The microphone audio cannot be reproduced while the DPSS function of the cassette deck is in use. → 27

This unit incorporates a clock function. Be sure to adjust the correct time before using the timer function. The time is displayed only while the power is off.

## 1 Activate the clock adjustment mode.

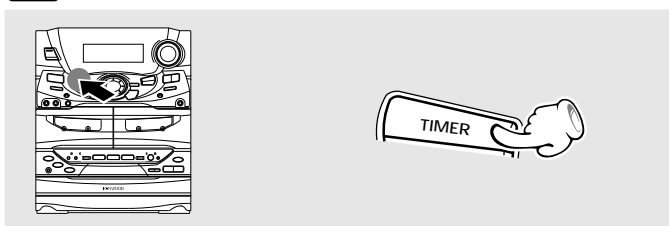

## 2 Select "TIME SET".

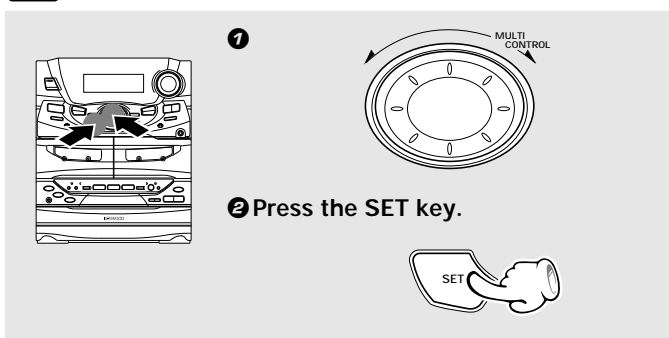

## 3 Enter the figure of hour.

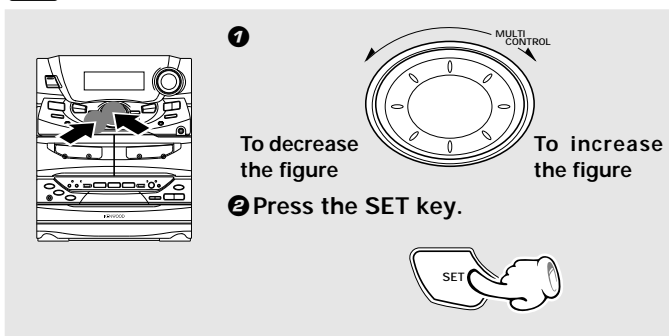

## 4 Enter the figure of minute.

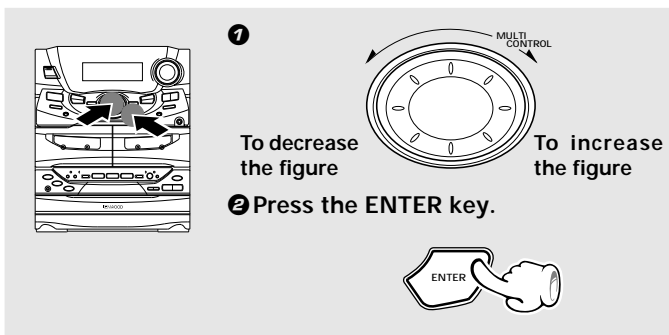

SLEEP  
TIME SET  
O.T.T.  
PROG. ON/OFF  
PROG. 1  
PROG. 2  
AUTO POWER SAVE



• The time display starts to blink.

Example: Adjustment to 8:45



AM12 ↔ AM1 ↔ AM2...PM1 ↔ PM2... ↔ RETURN ↔ AM12...

• The time of the day is represented in 12-hour AM/PM method.  
• Press the **SET** key. The hour is entered and the minute display starts to blink.

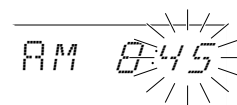

00 ↔ 01 ↔ 02...59 ↔ RETURN ↔ 00 ↔ 01...

• If you made a mistake, select "RETURN" and press the **ENTER** key and restart the entry.  
• To adjust correct time, press the **ENTER** key at the same moment as a time announcement.  
• The "- - - -" display appears after a power failure or when the power cord has been unplugged from the AC outlet and plugged again. In such a case, adjust the clock again.

## Sleep timer (SLEEP)

The power is turned OFF automatically after the specified period has elapsed.

## Operate easy To use Timer (O.T.T.)

Playback of the selected input source starts at the specified time, and the power is switched off after one hour. This timer operates only once directly after setting.

## Timer playback, timer recording (PROG.1, PROG.2)

With each of the two timer programs, a selected source can be played (or radio broadcast can be recorded) in the previously set time period.

## AI timer playback (PROG.1, PROG.2)

When timer playback starts, the volume increases gradually.

## AUTO POWER SAVE

When the power is ON and neither recording nor playback is executed for 30 minutes or more, the power is switched off automatically by this function.

*Adjust the clock before setting the timer.*

## Sleep timer (SLEEP)

Set the number of minutes after which the power is to be turned OFF.

- Press the **TIMER** key.
- Select **"SLEEP"** and press the **SET** key.
- Set the time and press the **ENTER** key.



10 ↔ 20 ↔ 30...80 ↔ 90 ↔ RETURN ↔ SLEEP OFF ↔ 10 ↔ 20...

- The displayed time changes in 10-minute steps. The maximum time that can be set is 90 minutes.
- The power is turned OFF automatically after the set time has elapsed.

### To cancel

Turn the unit off or select **"SLEEP OFF"** and press the **ENTER** key.

## Operate easy To use Timer (Operate easy To use Timer : O.T.T.)

Timer playback can be set with a simple operation of just setting the time. With this function, the last source selected before turning power off can be played by the timer. The power turned ON by the timer is switched off automatically in an hour after the timer playback starts.

- Select the desired source and adjust the volume.
- Press the **TIMER** key.
- Select **"O.T.T."** and press the **SET** key.
- Set the ON time and press the **ENTER** key.
- Switch OFF the power supply.

The time is returned.      The time is advanced.



The program timer does not operate until O.T.T. operation has ended. At the time of tape playback by timer operation, the B deck has priority.



- The ON time can be set in steps of 5 minutes.

### To cancel

If you are in the middle of time setting, press the **TIMER** key. If the O.T.T. operation has already been started, turn the unit off.

# Timer programming

Two 24-hour timer systems (PROG.1, PROG.2) (which can be used every day) and a sleep timer system (which works only once) are available.

In each of PROG.1 and PROG.2, the timer data including the operating period and played contents can be set and selected to be activated or not as required.

- Timer reservation is possible for the two types PROG.1 and PROG. 2 at the same time.
- Please make reservations with an interval of at least one minute, so that the operation times of PROG. 1 and PROG. 2 do not overlap.
- If you made a mistake during timer setting: Select "RETURN" in the time setting or selection item and press the **SET** or **ENTER** key. (This makes it possible to the previous step so the current step can be restarted.)

## Adjust the clock before setting the timer.

### 1 Make preparations for the play (recording).

- To listen to radio

The station should be preset prior to the above.



- To listen to CD

Insert a disc. (Program playback is not possible.)

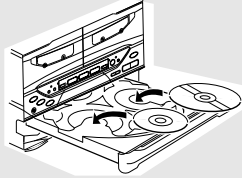

Select the disc to be played (1, 2 or 3).

- To listen to tape

Set a tape into deck B.

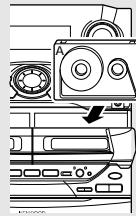

The B deck has priority at the time of timer playback.

- Playing the auxiliary input source

Make timer setting of the component connected to the AUX jacks.

- For recording

Make preparations for recording.



### 2 Adjust the listening volume.

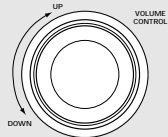

- When the timer function is used for timer recording of an input source, the speakers do not output the audio even after the unit is turned on by the timer.

### 3 Press the TIMER key.

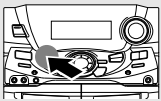

### 4 Select a program No. and press the SET key.

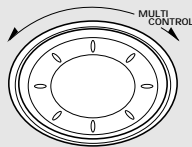

- SLEEP
- TIME SET
- O.T.T.
- PROG. ON/OFF
- PROG.1 ..... Program 1
- PROG.2 ..... Program 2
- AUTO POWER SAVE

PROG. 1

- The selected program No. lights.

- If a program No. under which a timer program has already been reserved, it is replaced by the new timer program.

### 5 Enter the ON time.

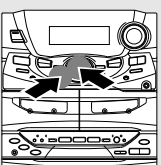

1

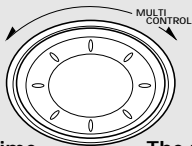

2



The time is returned.

The time is advanced.

- After entering the figure of "hour" with the procedure in 1 and 2, enter the figure of "minute" using the same procedure.

AM 7:20



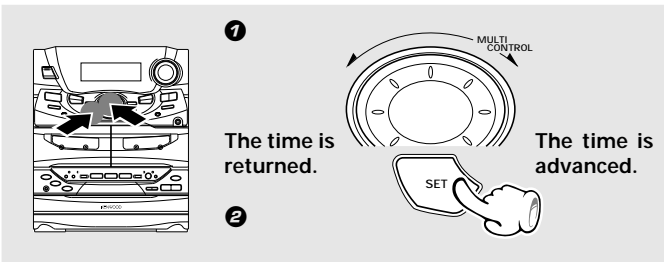

**6** Enter the OFF time.

- After entering the figure of "hour" with the procedure in **1** and **2**, enter the figure of "minute" using the same procedure.

**7** Make the desired reservation.

## For timer playback or AI timer playback

**1** Select the mode.

Select "TIMER PLAY" or "AI PLAY".

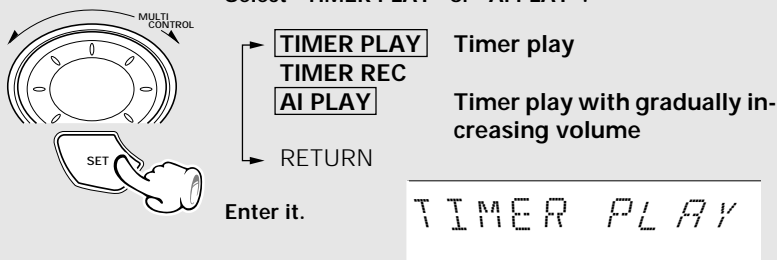
**2** Select the input source.

Select the source to be played.

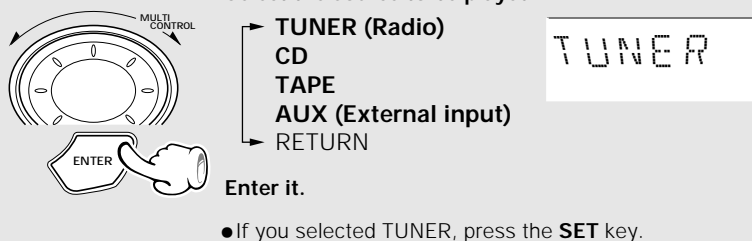

- If you selected TUNER, press the **SET** key.

**3** Select the broadcast station (only when TUNER is selected above).

Select the preset station No.

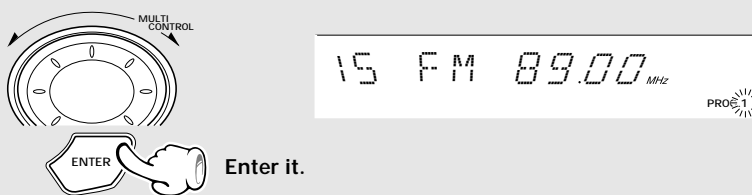

## For timer recording

**1** Select the mode.

Select "TIMER REC".

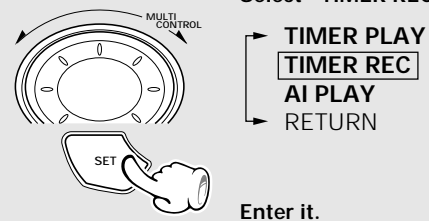
**2** Select the input source.

Select the recorded input source.

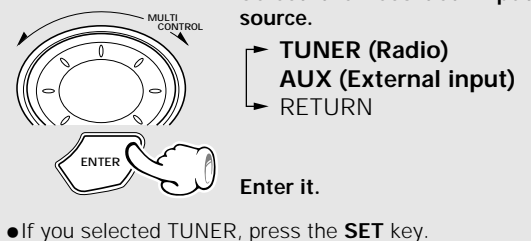

- If you selected TUNER, press the **SET** key.

**3** Select the broadcast station (only when TUNER is selected above).

Select the preset station No.

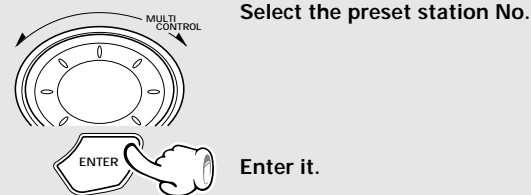
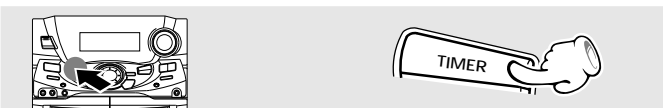
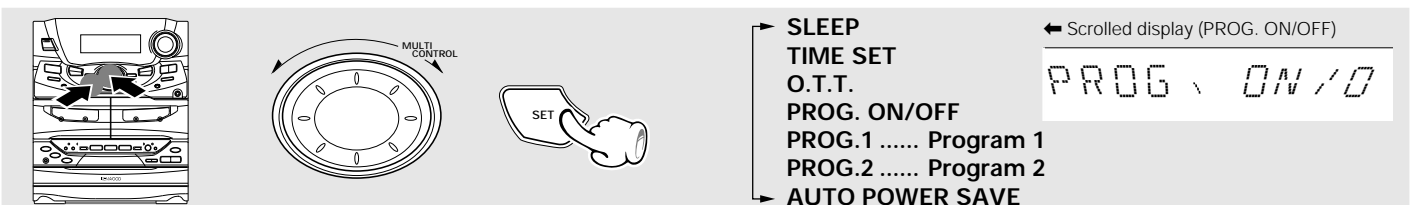
**8** Press the **TIMER** key.**9** Select "PROG. ON/OFF" and press the **SET** key.

Continued on next page...

**10** Select the program number to be used and press the ENTER key.

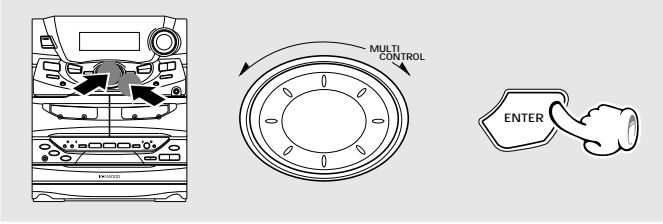

- PROG.1 ..... Program 1 operates.
- PROG.2 ..... Program 2 operates.
- PROG.1 / 2 .... Programs 1 and 2 operate.
- PROG. OFF .... Timer off.

•The selected contents of the timer programming will be displayed in sequence.  
(ON TIME → OFF TIME → Mode → Input source → Preset channel)

**11** Set the POWER switch to OFF (STANDBY) position.



**When timer operation is not required**

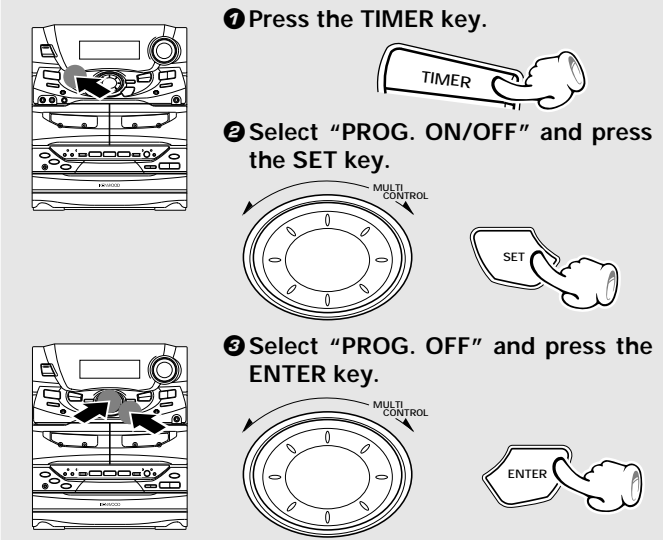

**Note** The reservation contents cannot be cleared. The contents are cleared only when they are changed.

- SLEEP TIME SET
- O.T.T.
- PROG. ON/OFF
- PROG. 1
- PROG. 2
- AUTO POWER SAVE



- PROG.1 ..... Program 1 operates.
- PROG.2 ..... Program 2 operates.
- PROG.1 / 2 .... Programs 1 and 2 operate.
- PROG. OFF .... No program operates.

•The reservation contents are held in memory.

**To set the same timer program again**

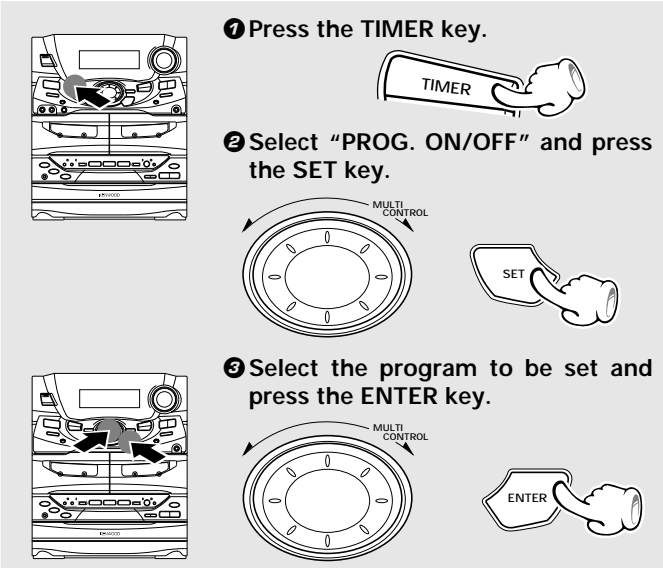

- SLEEP TIME SET
- O.T.T.
- PROG. ON/OFF
- PROG. 1
- PROG. 2
- AUTO POWER SAVE

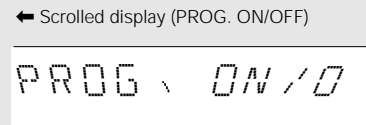

- PROG.1 ..... Program 1 operates.
- PROG.2 ..... Program 2 operates.
- PROG.1 / 2 .... Programs 1 and 2 operate.
- PROG. OFF .... No program operates.

•Also prepare the disc or tape and adjust the listening volume.

## Maintenance

### Cleaning the head section

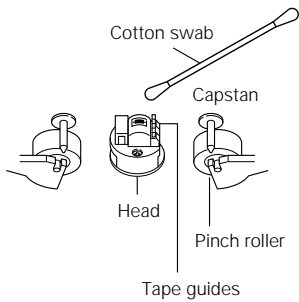

### Cleaning the heads and peripheral components

For maintaining the best condition of the deck and for longer service life, always keep the heads (recording / playback / erase), capstan and pinch roller clean. To clean them, perform the following:

1. Open the cassette holder.
2. Using a cotton swab dipped in alcohol, clean the head (recording / playback / erase), capstan and pinch roller carefully.

### Demagnetizing the head

When the recording / playback head is magnetized, the sound quality will deteriorate. In such a case, demagnetize the head using a commercially available demagnetizer (head eraser).



There are precisely aligned parts around the heads, including the tape guides. When cleaning, pay special attention so as not to apply shock to them.

### Maintenance of the set

When the front panel or case becomes dirty, wipe with a soft, dry cloth. Do not use thinner, benzine, alcohol, etc. for these agents may cause discoloration.

### In regard to contact cleaner

Do not use contact cleaners because it could cause a malfunction. Be specially careful not to use contact cleaners containing oil, for they may deform the plastic component.

## Reference

Sound Retrieval System manufactured under licence from SRS Labs, Inc. "SOUND RETRIEVAL SYSTEM" and the SRS Symbol **SRS** (●) are trademarks of SRS Labs, Inc. Purchase of this product does not convey the right to sell recordings made with the SOUND RETRIEVAL SYSTEM.

### Note related to transportation and movement (CD player)

Before transporting or moving this unit, carry out the following operations.

1. Turn the power ON but do not load a disc.
2. Press the ►/|| key.
3. Wait a few seconds, and ensure that the display is as shown below.

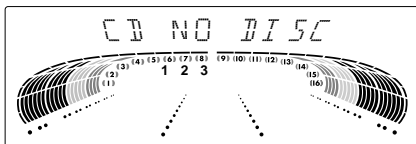

4. Wait for a few seconds then turn power off.

### Caution on condensation

Condensation (of dew) may occur inside the unit when there is a great difference in temperature between this unit and the outside. This unit may not function properly if condensation occurs. In this case, leave the unit for a few hours with the power left ON, and restart the operation after the condensation has dried up.

Be specially cautious against condensation in a following circumstance:

When this unit is carried from a place to another across a large difference in temperature, when the humidity in the room where this unit is installed increases, etc.

### Memory backup function

Stored contents which are cleared immediately when power plug is unplugged from power outlet	Clock display
Stored contents which are cleared in at least a day after power plug is unplugged from power outlet	<b>Amplifier</b> POWER status (ON or OFF) Input selection Volume control value Equalizer's manual memory created by the user SRS 3D level <b>Tuner unit</b> Receiving band Frequency Preset stations Program timer setting contents <b>Cassette deck unit</b> Transport direction DOLBY NR Reverse mode

When your unit needs to be repaired, bring the entire set (Speakers excluded) to your dealer.

What seems to be a malfunction is not always so. Before calling for service, check the following table according to the symptom of your trouble.

## Operation to reset

The microcomputer may fall into malfunction (impossibility to operate, erroneous display, etc.) when the power cord is unplugged while power is ON or due to an external factor. In this case, execute the following procedure to reset the microcomputer and return it to normal condition.

- Please note that resetting the microcomputer clears the contents stored in and returns and to condition when it left the factory.

Unplug the power cord from the power outlet then, while holding the eject ENTER key depressed, plug the power cord again.

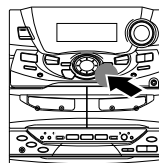



## Remote control unit

Symptom	Cause	Remedy
Remote control operation is not possible.	<ul style="list-style-type: none"> <li>● Batteries are exhausted.</li> <li>● The remote control is too far away from the system, the controlling angle is deviated or there is an obstacle in between.</li> <li>● There is no tape or CD set in the component to be played.</li> <li>● An attempt is made to play the cassette deck which is recording something.</li> <li>● The MULTI CONTROL setting mode is activated.</li> </ul>	<ul style="list-style-type: none"> <li>● Replace with new batteries. → <a href="#">18</a></li> <li>● Operate the unit inside the remote controllable range. → <a href="#">18</a></li> <li>● Set a tape or CD in the component to be played.</li> <li>● Wait until the recording ends.</li> <li>● Cancel the MULTI CONTROL setting mode. → <a href="#">19</a></li> </ul>

## Receiver, speakers













Symptom	Cause	Remedy
Sound is not produced.	<ul style="list-style-type: none"> <li>● The speaker cords are disconnected.</li> <li>● The MUTE switch of remote control unit is switched ON.</li> <li>● The headphone plug is inserted into the jack.</li> </ul>	<ul style="list-style-type: none"> <li>● Connect properly referring to "System connection".</li> <li>● Switch MUTE OFF.</li> <li>● Unplug the headphone plug. → <a href="#">20</a></li> </ul>
AUX (external input) sound is not produced.	<ul style="list-style-type: none"> <li>● The AUX INPUT LEVEL control on the rear panel is set to MIN.</li> </ul>	<ul style="list-style-type: none"> <li>● Adjust to an optimum level. → <a href="#">49</a></li> </ul>
Sub-woofer sound is not produced.	<ul style="list-style-type: none"> <li>● The LEVEL control is set to OFF.</li> </ul>	<ul style="list-style-type: none"> <li>● Adjust to an optimum level. → <a href="#">21</a></li> </ul>
Sound is not output in the TUNER mode.	<ul style="list-style-type: none"> <li>● Sound is not output when the radio wave is weak (DEMO ON).</li> </ul>	<ul style="list-style-type: none"> <li>● Switch the demonstration off. → <a href="#">4</a></li> </ul>
The character display blinks and sound is not produced.	<ul style="list-style-type: none"> <li>● The speaker cords are short-circuited.</li> </ul>	<ul style="list-style-type: none"> <li>● Turn the power OFF, remove the short-circuit and turn the power ON again.</li> </ul>
Sound is not produced from the left or right speakers.	<ul style="list-style-type: none"> <li>● The speaker cords are disconnected.</li> </ul>	<ul style="list-style-type: none"> <li>● Connect properly referring to "System connection".</li> </ul>
The clock display shows "- : - : -".	<ul style="list-style-type: none"> <li>● There was a power failure.</li> <li>● The power cord was unplugged from the outlet.</li> </ul>	<ul style="list-style-type: none"> <li>● Adjust the present time again. → <a href="#">54</a></li> <li>● Adjust the present time again. → <a href="#">54</a></li> </ul>
Timer operation is not possible.	<ul style="list-style-type: none"> <li>● The present time has not been adjusted or there was a power failure.</li> <li>● The timer ON time and OFF time have not been set.</li> <li>● The timer execution was not set up.</li> </ul>	<ul style="list-style-type: none"> <li>● Adjust the present time referring to "Clock adjustment". → <a href="#">54</a></li> <li>● Set the timer ON time and OFF time. → <a href="#">56</a></li> <li>● Execute the timer program. → <a href="#">58</a></li> </ul>
Radio stations cannot be received.	<ul style="list-style-type: none"> <li>● The antennas have not been connected.</li> <li>● A proper broadcasting band has not been selected.</li> <li>● The frequency of the station to be received is not tuned.</li> </ul>	<ul style="list-style-type: none"> <li>● Connect antennas. → <a href="#">28</a></li> <li>● Select a band. → <a href="#">28</a></li> <li>● Tune to the frequency of the desired station. → <a href="#">28</a></li> </ul>
Noise interferes.	<ul style="list-style-type: none"> <li>● Car ignition noise.</li> <li>● Influence of an electric appliance.</li> <li>● A TV set is installed near the system.</li> </ul>	<ul style="list-style-type: none"> <li>● Install the outdoor antenna in an apart position from the road.</li> <li>● Switch the suspected electric appliance OFF.</li> <li>● Install the TV or the system at an increased distance between them.</li> </ul>

<b>A station has been preset but it cannot be received by pressing the P.CALL key.</b>	<ul style="list-style-type: none"> <li>● The frequency of the preset station is not tunable.</li> <li>● The preset memory has been cleared because the power cord has been unplugged for a long period.</li> </ul>	<ul style="list-style-type: none"> <li>● Preset stations with tunable frequencies. →  29</li> <li>● Preset stations again. →  29</li> </ul>
<b>Demonstration starts suddenly.</b>	<ul style="list-style-type: none"> <li>● The power plug was unplugged from the outlet while the power switch was ON, or there was a power failure.</li> </ul>	<ul style="list-style-type: none"> <li>● This is not malfunction. Press the <b>MODE/ DEMO</b> key to cancel the demonstration. →  4</li> </ul>

## General





Symptom	Cause	Remedy
<b>No operation occurs when an operation key is pressed.</b>	<ul style="list-style-type: none"> <li>● The MULTI CONTROL setting mode is activated.</li> </ul>	<ul style="list-style-type: none"> <li>● Cancel the MULTI CONTROL setting mode. →  19</li> </ul>

## Cassette deck







Symptom	Cause	Remedy
<b>Sound cannot be produced by pressing the play key or no operation occurs even when an operation key is pressed.</b>	<ul style="list-style-type: none"> <li>● The head is dirty.</li> <li>● The tape is wound too tight due to irregular winding.</li> <li>● A nonrecorded tape is played.</li> </ul>	<ul style="list-style-type: none"> <li>● Clean the head referring to "Maintenance". →  59</li> <li>● Try another tape.</li> <li>● Play a recorded tape.</li> </ul>
<b>No operation occurs even when an operation key is pressed.</b>	<ul style="list-style-type: none"> <li>● The cassette holder is not closed completely.</li> <li>● The operation key is pressed immediately after closing the cassette holder.</li> <li>● The operation key is pressed in less than 4 seconds after turning the power ON.</li> <li>● A tape is not inserted in the unit.</li> <li>● The tape is wound too tight due to irregular winding.</li> <li>● The tape is fully wound to one of the reels.</li> </ul>	<ul style="list-style-type: none"> <li>● Close the holder completely. →  24</li> <li>● Press operations keys in more than a few seconds after closing the holder.</li> <li>● Press operation keys after waiting for more than 4 seconds.</li> <li>● Insert a tape. →  24</li> <li>● Try another tape.</li> <li>● Change the tape transport direction or reverse the tape insertion orientation. →  24</li> </ul>
<b>The DPSS malfunctions.</b>	<ul style="list-style-type: none"> <li>● The tape used is not suitable for DPSS, for example the spaces between tunes may be too short.</li> </ul>	<ul style="list-style-type: none"> <li>● Refer to "Searching for the desired music program (DPSS)". →  27</li> </ul>
<b>In dubbing, the tape stops at different moments in decks A and B.</b>	<ul style="list-style-type: none"> <li>● This is due to the difference in the tape length or characteristics of the mechanisms of two cassette decks.</li> </ul>	<ul style="list-style-type: none"> <li>● Small time difference does not mean a malfunction.</li> </ul>
<b>The cassette holders cannot be opened by pressing the  PUSH OPEN area.</b>	<ul style="list-style-type: none"> <li>● The key is pressed during recording or playback.</li> <li>● The microcomputer is malfunctioning due to external noise.</li> </ul>	<ul style="list-style-type: none"> <li>● Press in stop mode.</li> <li>● Reset the microcomputer. →  60</li> </ul>
<b>Sound is harsh or high frequencies are not reproduced.</b>	<ul style="list-style-type: none"> <li>● The head is dirty.</li> <li>● The tape is stretched or shrunk.</li> </ul>	<ul style="list-style-type: none"> <li>● Clean the head referring to "Maintenance". →  59</li> <li>● Try another tape.</li> </ul>
<b>Sound is distorted.</b>	<ul style="list-style-type: none"> <li>● The tape being played was recorded with distorted sound.</li> <li>● A tape recorded using the equalizer or SRS 3D level effect is played using the equalizer effect again.</li> </ul>	<ul style="list-style-type: none"> <li>● Try another tape.</li> <li>● Switch the equalizer or SRS 3D level effect.</li> </ul>
<b>The AUX sound is distorted.</b>	<ul style="list-style-type: none"> <li>● The AUX INPUT LEVEL is set too high.</li> </ul>	<ul style="list-style-type: none"> <li>● Decrease the AUX INPUT LEVEL. →  49</li> </ul>
<b>Noise is noticeable.</b>	<ul style="list-style-type: none"> <li>● The tape head is magnetized.</li> <li>● External noise is induced.</li> <li>● A tape recorded with Dolby NR ON is played with Dolby NR OFF.</li> </ul>	<ul style="list-style-type: none"> <li>● Demagnetize the head referring to "Maintenance". →  59</li> <li>● Install the system at a distance from other electric appliances and TV.</li> <li>● Set the Dolby NR to on. →  25</li> </ul>
<b>Sound vibrates.</b>	<ul style="list-style-type: none"> <li>● The capstans or pinch rollers are dirty.</li> <li>● The tape is wound irregularly.</li> </ul>	<ul style="list-style-type: none"> <li>● Clean the head referring to "Maintenance". →  59</li> <li>● Wind the tape again by fast forwarding, rewinding or playing from an end to the other. →  25</li> </ul>



1. With some tapes, a squeaky noise is produced when the tape is stopped automatically. This is due to the tape protection function, and not a malfunction.
2. Do not use longer tape than 110 minutes tapes, for the tape is too thin and gets easily tangled.

<b>Recording cannot be started by pressing the record key.</b>	<ul style="list-style-type: none"> <li>● The recording protect tab of the cassette has been broken.</li> <li>● The cassette holder is not closed completely.</li> <li>● The <b>TAPE</b> input is selected.</li> <li>● The tape is fully wound to one of the reels.</li> </ul>	<ul style="list-style-type: none"> <li>● Use a cassette with an unbroken recording protect tab or block the hole. →  5</li> <li>● Close the holder completely. →  24</li> <li>● Select the source to be recorded with the input selector key. →  31</li> <li>● Change the tape transport direction of deck B or reverse the tape insertion orientation. →  30</li> </ul>
<b>Volume of the recorded track changed.</b>	<ul style="list-style-type: none"> <li>● <b>MIC VOL.</b> control knob is moved during recording.</li> </ul>	<ul style="list-style-type: none"> <li>● Fully turn the <b>MIC VOL.</b> control knob to the left. →  30</li> </ul>

### CD player

Symptom	Cause	Remedy
<b>A CD is placed in the player but it cannot be played.</b>	<ul style="list-style-type: none"> <li>● The disc is placed upside down.</li> <li>● The disc position is displaced.</li> <li>● The disc is extremely dirty.</li> <li>● The disc is scratched.</li> <li>● Dew is condensed on the optics lens.</li> </ul>	<ul style="list-style-type: none"> <li>● Place the disc properly, with the label side facing upward. →  22</li> <li>● Place the disc properly. →  22</li> <li>● Clean the disc referring to "Disc handling precautions". →  5</li> <li>● Try another disc.</li> <li>● Refer to "Caution on condensation" and remove the condensation by evaporation. →  59</li> </ul>
<b>Sound is not produced.</b>	<ul style="list-style-type: none"> <li>● The disc has not been placed.</li> <li>● The player is not put to the play mode.</li> <li>● The disc is extremely dirty.</li> <li>● The disc is scratched.</li> </ul>	<ul style="list-style-type: none"> <li>● Place a disc in the CD player. →  22</li> <li>● Press the play key. →  22</li> <li>● Clean the disc referring to "Disc handling precautions". →  5</li> <li>● Try another disc.</li> </ul>
<b>Sound skips.</b>	<ul style="list-style-type: none"> <li>● The disc is dirty.</li> <li>● The disc is scratched.</li> <li>● The player is subject to vibration.</li> </ul>	<ul style="list-style-type: none"> <li>● Clean the disc referring to "Disc handling precautions". →  5</li> <li>● Try another disc.</li> <li>● Install the unit in a place not subject to vibrations.</li> </ul>

#### **WARNING NOTICE:**

IN MOST CASES IT IS AN INFRINGEMENT OF COPYRIGHT TO MAKE COPIES OF TAPES OR DISCS WITHOUT THE PERMISSION OF THE COPYRIGHT OWNERS. ANYONE WISHING TO COPY COMMERCIALLY AVAILABLE TAPES OR DISC SHOULD CONTACT THE MECHANICAL COPYRIGHT PROTECTION SOCIETY LIMITED OR THE PERFORMING RIGHTS SOCIETY LIMITED.

## Main unit

### [ Amplifier section ]

(RXD-A8/RXD-7...Series)

Rated power output (U.S.A. and Canada)

100 watts per channel minimum RMS, both channels driven, at 6 Ω from 40 Hz to 14 kHz with no more than 0.9 % total harmonic distortion.

Effective output power during STEREO operation

U.S.A. and Canada

FRONT (1 kHz, 0.9 % T.H.D., 6 Ω) ..... 100 W + 100 W

Sub woofer (60 Hz, 0.9 % T.H.D., 12 Ω // 12 Ω) ..... 100 W

Other countries

FRONT (1 kHz, 10 % T.H.D., 6Ω) ..... 135 W + 135 W

Sub woofer (60 Hz, 10 % T.H.D., 12 Ω // 12 Ω) ..... 135 W

Rated output power during STEREO operation

Europe, U.K. and Russia

(DIN) 1 kHz, 0.7 % T.H.D., 6 Ω ..... 100 W + 100 W

Other countries

1 kHz, 1.0 % T.H.D., 6 Ω ..... 115 W + 115 W

(RXD-A5/RXD-5...Series)

Rated power output (U.S.A. and Canada)

70 watts per channel minimum RMS, both channels driven, at 6 Ω from 40 Hz to 14 kHz with no more than 0.9 % total harmonic distortion.

Effective output power during STEREO operation

1 kHz, 10 % T.H.D., 6 Ω ..... 100 W + 100 W

Rated output power during STEREO operation

Europe, U.K. and Russia

(DIN) 1 kHz, 0.7 % T.H.D., 6 Ω ..... 80 W + 80 W

Other countries

1 kHz, 1.0 % T.H.D., 6 Ω ..... 95 W + 95 W

Signal to noise ratio

AUX ..... 90 dB

Input sensitivity / impedance

AUX ..... 400 mV / 47 kΩ

MIC 1, 2 (Except for some areas) ..... 2.5 mV / 22 kΩ

Output level / impedance

AUX (Except for U.S.A. and Canada) ..... 1.2 V / 3.3 kΩ

(RXD-A5/RXD-5...Series)

SUPER WOOFER PREOUT ..... 1.8 V / 3.3 kΩ

### [ Tuner section ]

FM tuner section

Tuning frequency range ..... 87.5 MHz ~ 108 MHz

(For Russia) ..... 65.0 MHz ~ 74.0 MHz

MW (AM) Tuner section

Tuning frequency range

Europe, U.K. and Russia ..... 531 kHz ~ 1,602 kHz

Other countries

9 kHz step ..... 531 kHz ~ 1,602 kHz

10 kHz step ..... 530 kHz ~ 1,610 kHz

U.S.A. and Canada ..... 530 kHz ~ 1,700 kHz

LW Tuner section (For the United Kingdom and Russia)

Tuning frequency range ..... 153 kHz ~ 279 kHz

SW Tuner section (RXD-771S/RXD-571S)

Tuning frequency range ..... 5.9 MHz ~ 17.9 MHz

### [ Cassette deck section ]

Track ..... 4-track, 2-channel stereo

Recording system ..... AC bias system  
(Frequency: 105 kHz)

Heads

A deck Playback head ..... 1

B deck Playback / recording head ..... 1

Erasing head ..... 1

Motors ..... 2

Fast winding time ..... Approx. 115 seconds  
(C-60 tape)

### [ CD player section ]

Laser ..... Semiconductor laser

Wow & Flutter ..... Less than unmeasurable Limit  
(Except for U.S.A. and Canada)

Digital output (Optical) ..... - 15 dBm ~ - 21 dBm  
(Wave length 660 nm)

### [ General ]

Power consumption ..... (RXD-7...Series) 210 W  
..... (RXD-A8/RXD-A5/RXD-5...Series) 200 W

Dimensions ..... W: 280 mm (11")  
..... H: 332 mm (13-1/16")  
..... D: 344 mm (13-9/16")

Weight (net) ..... (RXD-A8/RXD-7...Series) 11.1kg (24.5 lb)  
..... (RXD-A5/RXD-5...Series) 10.5kg (23.1 lb)

### Speakers (LS-N701/N751) RXD-A8/RXD-7...Series

Enclosure ..... Bass-reflex type

Speaker configuration

Sub woofer ..... 160 mm, cone type

Woofer ..... 160 mm, cone type

Tweeter ..... 65 mm, cone type

Super-tweeter ..... 25 mm, dome type

Impedance ..... 6 Ω (Sub woofer 12 Ω)

Peak input level ..... 135 W (Sub woofer 70 W)

Maximum input level ..... 100 W (Sub woofer 50 W)

Dimensions ..... W: 333 mm (13-1/8")  
..... H: 330 mm (13")  
..... D: 425 mm (16-3/4")

Weight (net) ..... 7.1 kg (15.6 lb) (1 piece)

### Speakers (LS-N501/N551) RXD-5...Series

Enclosure ..... Bass-reflex type, magnetically shielded

Speaker configuration

Woofer ..... 180 mm, cone type

Tweeter ..... 65 mm, cone type

Super-tweeter ..... 25 mm, dome type

Impedance ..... 6 Ω

Maximum input level ..... 100 W

Dimensions ..... W: 220 mm (8-11/16")  
..... H: 330 mm (13")  
..... D: 316 mm (12-7/16")

Weight (net) ..... 4.1 kg (9.0 lb) (1 piece)

### Speakers (LS-N451) RXD-A5

Enclosure ..... Bass-reflex type, magnetically shielded

Speaker configuration

Woofer ..... 160 mm, cone type

Tweeter ..... 50 mm, cone type

Super-tweeter ..... 25 mm, dome type

Impedance ..... 6 Ω

Maximum input level ..... 100 W

Dimensions ..... W: 200 mm (7-7/8")  
..... H: 330 mm (13")  
..... D: 284 mm (11-3/16")

Weight (net) ..... 4.0 kg (8.8 lb) (1 piece)



1. KENWOOD follows a policy of continuous advancements in development. For this reason specifications may be changed without notice.  
2. Sufficient performance may not be possible at very low temperatures (0°C or less).

This instruction manual is used to describe multiple models listed above. Model availability and features (functions) may differ depending on the country and sales area.

	→ 8 → 12 SURROUND switch/ SPEAKERS terminals	→ 12 SUBWOOFER PRE OUT	→ 21 S.W. LEVEL	→ 53 MIC 1,2 / VOL.	→ 39 → 42 R.D.S. EON
XD-751/XD-701	YES		YES	YES (Except for Europe, U.K. and Russia)	YES (Europe and U.K. only)
XD-771S	YES		YES	YES	
XD-551/XD-501	YES (Except for Europe, U.K. and Russia)	YES		YES (Except for Europe, U.K. and Russia)	YES (Europe and U.K. only)
XD-571S	YES	YES		YES	

# KENWOOD

### *For your records*

Record the serial number, found on the back of the unit, in the spaces designated on the warranty card, and in the space provided below. Refer to the model and serial numbers whenever you call upon your dealer for information or service on this product.

Model \_\_\_\_\_

Serial Number \_\_\_\_\_



## Free Manuals Download Website

<http://myh66.com>

<http://usermanuals.us>

<http://www.somanuals.com>

<http://www.4manuals.cc>

<http://www.manual-lib.com>

<http://www.404manual.com>

<http://www.luxmanual.com>

<http://aubethermostatmanual.com>

Golf course search by state

<http://golfingnear.com>

Email search by domain

<http://emailbydomain.com>

Auto manuals search

<http://auto.somanuals.com>

TV manuals search

<http://tv.somanuals.com>