

KENWOOD

COMPONENT SYSTEM/COMPACT HI-FI SYSTEM

XD SERIES

XD-8001 XD-6051

XD-8051 XD-6551

XD-8501

XD-8551

INSTRUCTION MANUAL

KENWOOD CORPORATION

This instruction manual is used for six models.
Model availability and features (functions) may differ depending on the country and sales area.



B60-3850-00 00 (MA) (T E2 Q) !M̄C̄!
99/12 11 10 9 8 7 6 5 4 3 2 1 98/12 11 10 9 8 7 6 5 4

2 Before applying power

 **Caution** : Read this page carefully to ensure safe operation.

XD SERIES (En/E2)

Units are designed for operation as follows.

Europe , U.K. and Russia AC 230 V only

For the United Kingdom

Factory fitted moulded mains plug

- 1.The mains plug contains a fuse. For replacement, use only a 13-Amp ASTA-approved (BS1362) fuse.
- 2.The fuse cover must be refitted when replacing the fuse in the moulded plug.
- 3.Do not cut off the mains plug from this equipment. If the plug fitted is not suitable for the power points in your home or the cable is too short to reach a power point, then obtain an appropriate safety approved extension lead or adapter, or consult your dealer. If nonetheless the mains plug is cut off, remove the fuse and dispose of the plug immediately, to avoid a possible shock hazard by inadvertent connection to the mains supply.

IMPORTANT: The wires in the mains lead are coloured in accordance with the following code:

Blue : Neutral
Brown : Live

Do not connect those leads to the earth terminal of a three-pin plug.

The marking of products using lasers (Except for some areas)

**CLASS 1
LASER PRODUCT**

The marking is located on the rear panel and says that the component uses laser beams that have been classified as Class 1. It means that the unit is utilizing laser beams that are of a weaker class. There is no danger of hazardous radiation outside the unit.



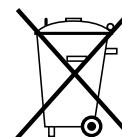

REQUIREMENT BY NEDERLAND GAZETTE

Batteries are supplied with this product. When they empty, you should not throw away. Instead, hand them in as small chemical waste.



Safety precautions

WARNING : TO PREVENT FIRE OR ELECTRIC SHOCK, DO NOT EXPOSE THIS APPLIANCE TO RAIN OR MOISTURE.



 <div style="border: 1px solid black; padding: 2px; text-align: center;"> CAUTION <small>RISK OF ELECTRIC SHOCK DO NOT OPEN</small> </div> 	<p>CAUTION: TO REDUCE THE RISK OF ELECTRIC SHOCK, DO NOT REMOVE COVER (OR BACK). NO USER-SERVICEABLE PARTS INSIDE, REFER SERVICING TO QUALIFIED SERVICE PERSONNEL.</p>
	<p>THE LIGHTNING FLASH WITH ARROWHEAD SYMBOL, WITHIN AN EQUILATERAL TRIANGLE, IS INTENDED TO ALERT THE USER TO THE PRESENCE OF UNINSULATED "DANGEROUS VOLTAGE" WITHIN THE PRODUCT'S ENCLOSURE THAT MAY BE OF SUFFICIENT MAGNITUDE TO CONSTITUTE A RISK OF ELECTRIC SHOCK TO PERSONS.</p>
	<p>THE EXCLAMATION POINT WITHIN AN EQUILATERAL TRIANGLE IS INTENDED TO ALERT THE USER TO THE PRESENCE OF IMPORTANT OPERATING AND MAINTENANCE (SERVICING) INSTRUCTIONS IN THE LITERATURE ACCOMPANYING THE APPLIANCE.</p>

This instruction manual is designed for common use by six models and the combination of components of each model is shown in the following table. As the functions of each component is variable depending on the model, please check the component models delivered to you by referring to the following table.

	Tuner/ Equalizer	Amplifier	Cassette deck	CD player	Speaker
XD-8001	C-H6	A-H5	X-H5	DP-H5	LS-J6
XD-8051	C-H6	A-H5	X-H5	DP-H5	LS-J6
XD-8501	C-H6	A-H5	X-H5	DP-MH5	LS-J6
XD-8551	C-H6	A-H5	X-H5	DP-MH5	LS-J6
XD-6051	C-H5	A-H5	X-H5	DP-H5	LS-H5
XD-6551	C-H5	A-H5	X-H5	DP-MH5	LS-H5

Contents

Preparation section

 Before applying power	2
 Safety precautions	2
Contents	3
Special features	4
Handling of discs and tapes	5
System connection	6
Connection of the System Accessories	6
Connection of other components and accessories ..	8
Controls and indicators	10
Tuner/Equalizer Unit (C-H6)	10
Display (C-H6)	11
Tuner/Equalizer Unit (C-H5)	12
Display (C-H5)	13
Amplifier unit	14
Cassette deck unit	15
CD player unit (DP-H5)	16
CD player unit (DP-MH5)	17
Remote control Unit	18
Operation of remote control unit	19

Basic section

Let's put out some sound	20
Basic use method	20
Playback of CD (DP-H5)	22
Playback of CD (DP-MH5)	24
Playback of tape	26
DPSS (Direct Program Search System)	28
Receiving broadcast station	30
Let's record	32
Recording (Deck B only)	32
Adjusting the recording level	34
Copying tape (Tape dubbing)	35

Application section

Playback of CD (DP-H5)	36
Listening in the desired sequence (program playback)	36
Repeated playback	38
Listening to an unexpected title sequence (random playback)	39
Playback of CD (DP-MH5)	40
Listening in the desired sequence (program playback)	40
Repeated playback	42

Listening to an unexpected title sequence (random playback)	43
R.D.S. (Radio Data System)	45
Searching for a desired program type (PTY search)	46
To be able to listen to the desired information at any time	48
Convenient CD recording	50
Selection of the convenient CD recording type	50
One-touch recording of an entire CD (ONE TOUCH EDIT.....recording of all titles)	52
Recording only desired titles (ONE TOUCH EDIT.....single title recording)	53
Recording favorite tracks from CD onto a single tape (Program edit recording)	54
Giving preference to the tape length over the title sequence (Time edit recording)	55
Fading in/out sound at tape reversal positions (Fade edit recording)	57
Twin recording	58
Effective Sound Adjustment	59
Enjoying Sound Field Effects	59
Listening with the desired sound (equalizer function)	60
Adjustment of balance and input level	62
Switching the display	63
Clock adjustment	64
Timer operation	65
Timer programming	66

Knowledge section

Important Items	69
Maintenance	69
Reference	69
In case of difficulty	70
Specifications	73

Special features

3D dual display (For the systems including the C-H6)

The 3D dual display allows to utilize the limited display area effectively and shows a variety of information including the character display, volume display and graphic equalizer display at a glance. The dual display can be switched to a single display which is simpler.

SRS 3D system

The SRS (Sound Retrieval System) is an innovative system creating a 3-dimensional acoustic space. It improves the feeling of depth, width of the sound field and positioning of acoustic images and also expands the listening area.

Versatile spectrum analyzer display

The desired spectrum analyzer display can be selected from a variety of formats.

Simplified CD recording

Various CD editing & recording features are available for selection according to the tape you require.

- One-touch edit recording : Single press of a key allows to record the entire CD or a track.
- Program edit recording : Recording desired CD tracks in desired order.
- Time edit recording : Recording CD tracks within the specified tape length so that no track is interrupted in the middle.
- Fade edit recording : Recording CD tracks sequentially from No. 1.
- Twin recording : A single CD can be recorded on a MD and cassette tape simultaneously. (For the systems including the DP-MH5)

Versatile tone and sound field adjustment

Equalizer patterns can not only be selected from preset patterns, but patterns also can be created and registered. It is possible to recreate a feeling of presence and to recreate a sound field.

The tone can be selected according to the genre of the music played:

ROCK, POP, DISCO, JAZZ, CLASSIC.

Convenient timer functions

In addition to the capacity of storing 2 timer programs, the timer provides the following convenient functions.

- O.T.T. (Operate easy-To-use Timer) : With an extremely simple setup, the power can be turned off automatically in an hour after it is turned on by the timer.
- Timer recording, timer playback : The selected source can be played or recorded at the set time range.
- AI (Artificial Intelligence) timer : The volume is increased gradually after the power is turned on by the timer.
- Sleep timer : Convenient function when you want to go asleep while listening to music.

Unpacking

Unpack the unit carefully and make sure that all accessories are put aside so they will not be lost.

Examine the unit for any possibility of shipping damage. If your unit is damaged or fails to operate, notify your dealer immediately. If your unit was shipped to you directly, notify the shipping company without delay. Only the consignee (the person or company receiving the unit) can file a claim against the carrier for shipping damage.

We recommend that you retain the original carton and packing materials for use should you transport or ship the unit in the future.

Accessories

FM indoor antenna (1)

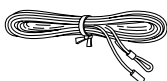

AM loop antenna (1)

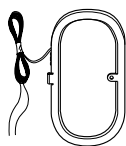

Loop antenna stand (1)

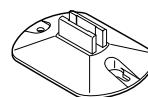

Speaker cords (2)



Remote control unit (1)

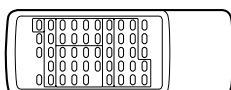

Batteries (R6/AA) (2)



Parallel cord (1)



Handling of discs and tapes

Disc handling precautions

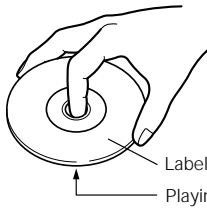

Handling

Hold compact discs so that you do not touch the playing surface.

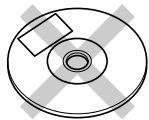

Do not attach paper or tape to either the playing side or the label side of compact discs.

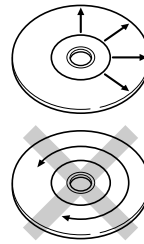

Cleaning

If fingerprints or foreign matter become attached to the disc, lightly wipe the disc with a soft cotton cloth (or similar) from the center of the disc outwards in a radial manner.

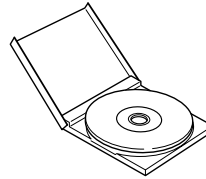

Storage

When a disc is not to be played for a long period of time, remove it from the CD player and store it in its case.

Caution on disc used

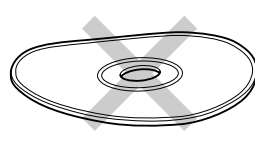
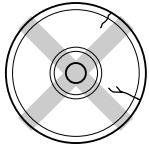

Never play cracked or warped disc.

During playback, the disc rotates at high speed in the player. Therefore, to avoid malfunction, never use a cracked or deformed disc or a disc repaired with tape or adhesive agent.

Discs which can be played with this unit

CD (12 cm, 8 cm), CDV (only the audio part)

- With CD-G (CD Graphics) discs, this unit can play only the audio.

CD accessories

The CD accessories (stabilizer, protection sheet, protection ring, etc.) which are marketed for improving the sound quality or protecting discs as well as the disc cleaner should not be used with this system because they may cause malfunction.

Notes on cassette tape

Safety tab (accidental erasure prevention tab)

After an important recording has been finished, break the safety tab, to prevent the recorded contents from being erased or recorded on accidentally.

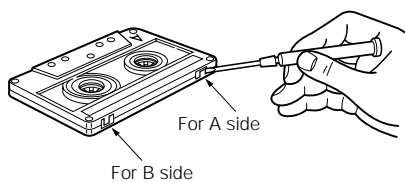

To store cassette tapes

Do not store the tapes in a place which is subject to direct sunlight, or near equipment that generates heat. Keep the cassette tapes away from any magnetic field.

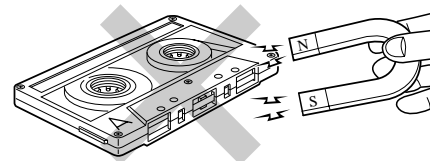

When there is slack in the tape

In such a case, insert a pencil into the reel hole and wind the reel hub to remove the slack.

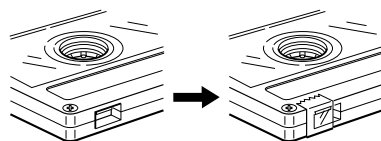
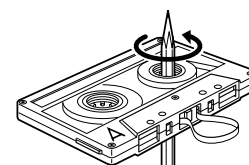

To re-record

Apply tape only to the position where the tab has been removed.



1. Longer tape than 110 minutes cassette tape

Since longer tape than 110 minutes cassette tape is very thin, the tape could adhere to the pinch roller or be easily cut. It is recommended that these tapes not be used with this unit to prevent possible damage.

2. Endless tapes

Do not use an endless tape, as this could damage the mechanism of the unit.

Connection of the System Accessories

This is the connection method for system and accessories. Please look carefully at the illustration and connect correctly in the order of the numbers.

With certain models, the positions of the connectors, jacks and terminals may differ from the following illustration but their designs are the same as those illustrated below: With such models, please make connections by referring to the following illustration.

Malfunction of microcomputer

If operation is not possible or erroneous display appears even though all connections have been made properly, reset the microcomputer referring to "In case of difficulty".

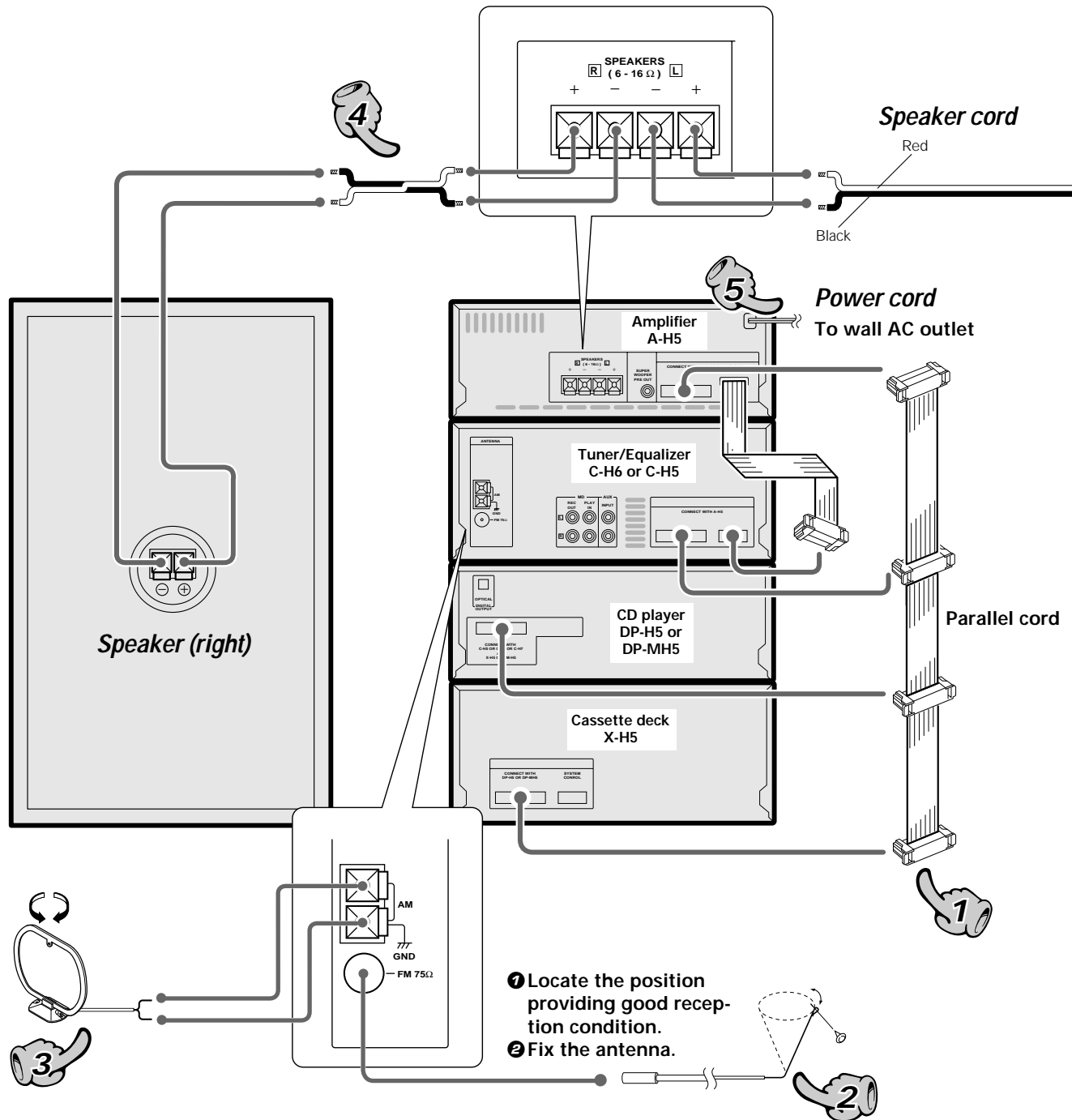

- 1 Locate the position providing good reception condition.
- 2 Fix the antenna.

AM loop antenna

The supplied antenna is for indoor use. Place it as far as possible from the main system, TV set, speaker cords and power cord, and set it to a direction which provides the best reception.

FM indoor antenna

The accessory antenna is for temporary indoor use only. For stable signal reception we recommend using an outdoor antenna. Remove the indoor antenna if you connect one outdoors.

Connection of parallel cord

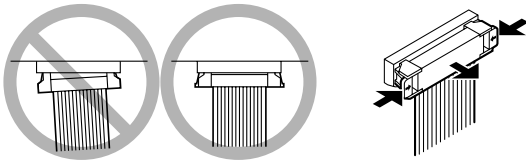

- When connecting the parallel cord, insert plug straight into the connector until it clicks to lock them securely.
- When connecting the parallel cord, the wire while line should come to the left side end.
- When disconnecting the parallel cord, push in the two sides of the plug and pull it straight out.

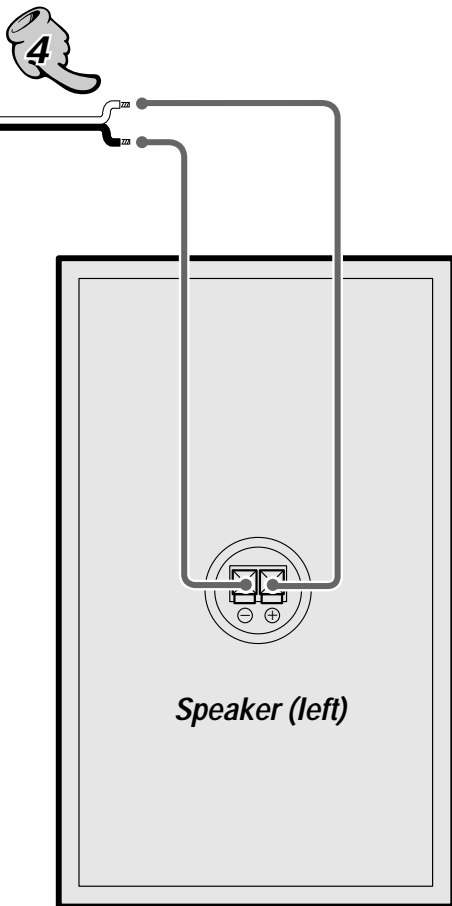

Caution regarding placement (Front View)

The external view is variable depending on the model and marketing destination type.

Please install as shown below, as otherwise fire may be caused by overheating.

From the top to the bottom

- Amplifier : A-H5
- Tuner/Equalizer : C-H6 or C-H5
- CD player : DP-H5 or DP-MH5
- Cassette deck : X-H5

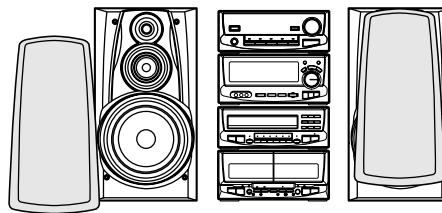

To maintain proper ventilation, be sure to leave a space around the unit (from the largest outer dimensions including projections) equal to, or greater than, shown below.

top panel: 50 cm
 rear panel: 10 cm
 left and right panels: 10 cm



1. Be sure to insert all connection cords securely. If their connections are imperfect, the sound may not be produced or noise may interfere.
2. Before plugging or unplugging a connection cord, be sure to unplug the power cord from the wall AC outlet. If connection cords are plugged or unplugged with the power cord left plugged in, malfunction or damage may result.
3. When arranging the system units in a vertical, stacked configuration, observe the stacking order indicated in the system connection diagram.
4. In case an associated system component is connected, also read the instruction manual of the component.
5. Align the front panels of all sets flush.
6. Never short-circuit the + and - speaker cords.
7. If the left and right speaker connections or the + and - polarity are inverted, the sound will be unnatural with unclear positioning of musical instruments, etc. Be sure to connect them without mistake.

Main unit

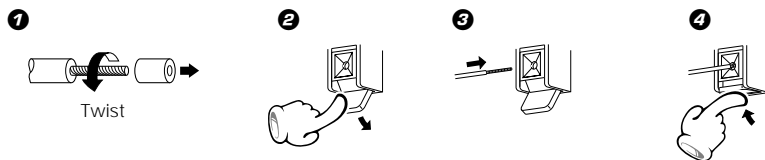

Speaker Unit

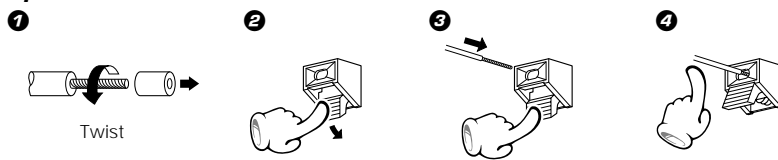

Connection of other components and accessories

Connect separately sold parts as shown in the figure.
Do not plug the power cord into the power outlet until all of the required connections have been made.



For playback or recording from the equipment connected to the AUX terminals, press the AUX key of the amplifier input selector key.

For playback from the equipment connected to the MD terminals, press the MD key of the amplifier input selector keys.

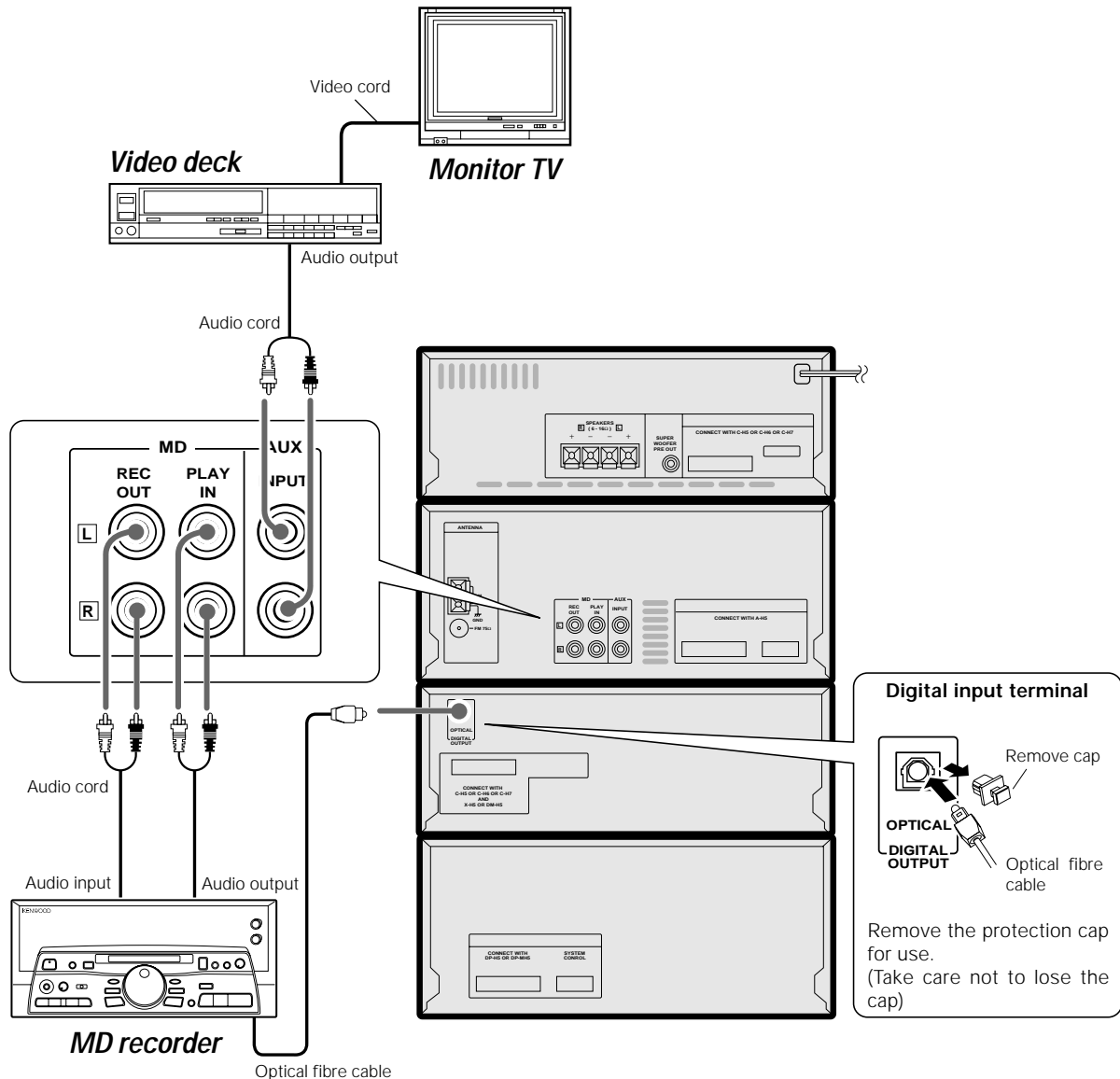

Connection of system control cord

Plugging the connector

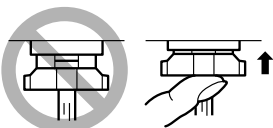

Insert the plug straight into the connector until it locks

Unplugging the connector

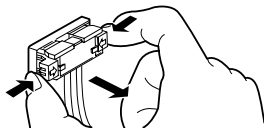

While pushing the two sides of connector in pull it straight out

Note on connection of optical-fiber cable

- Insert the optical-fiber cable straight into the connector until it clicks.
- Be sure to attach the protection cap when the connector is not used.
- Never bend or bundle the optical-fiber cable.
- All of the optical-fiber cables sold in audio stores cannot always be used. If the cable you purchased cannot be connected to this unit, please consult your dealer or KENWOOD distributor.

Super woofer (SW-500) (Optional)
 Extremely low sound is played back powerfully. This can be used with any type of playback.

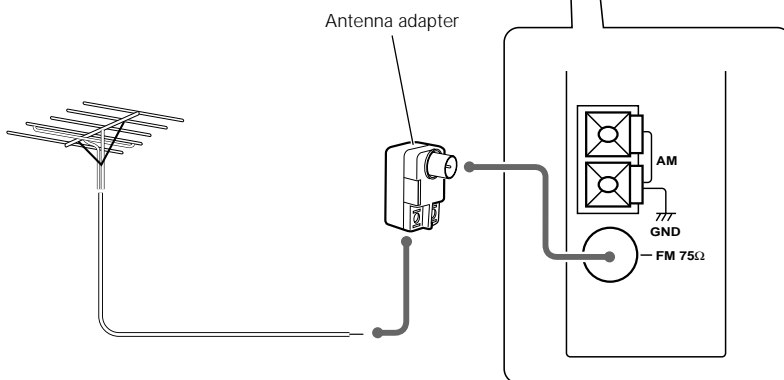
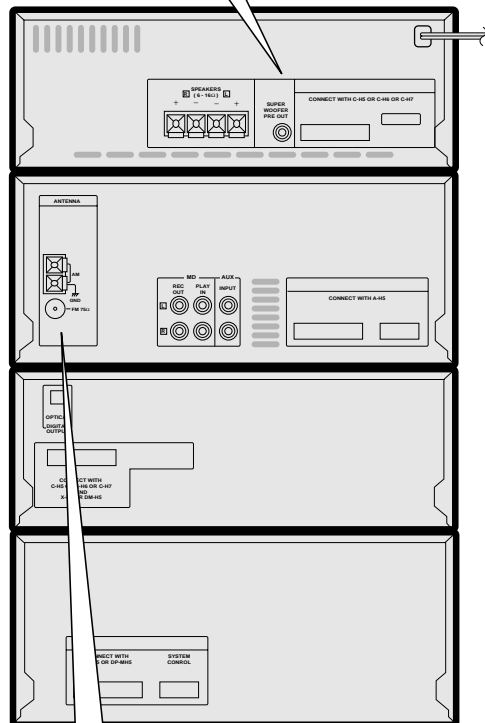
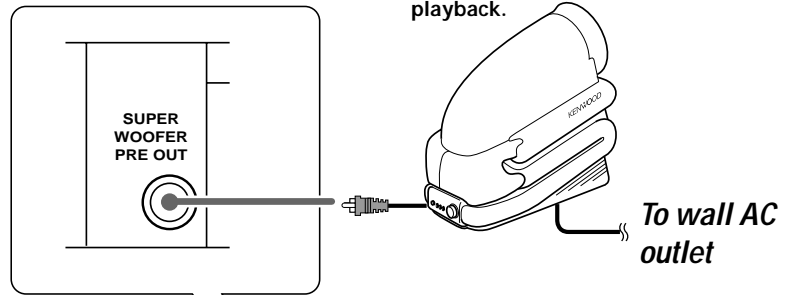

FM outdoor antenna

Lead the 75Ω coaxial cable connected to the FM outdoor antenna into the room and connect it to the FM 75Ω terminal.

Tuner/Equalizer Unit (C-H6)

Preparation section

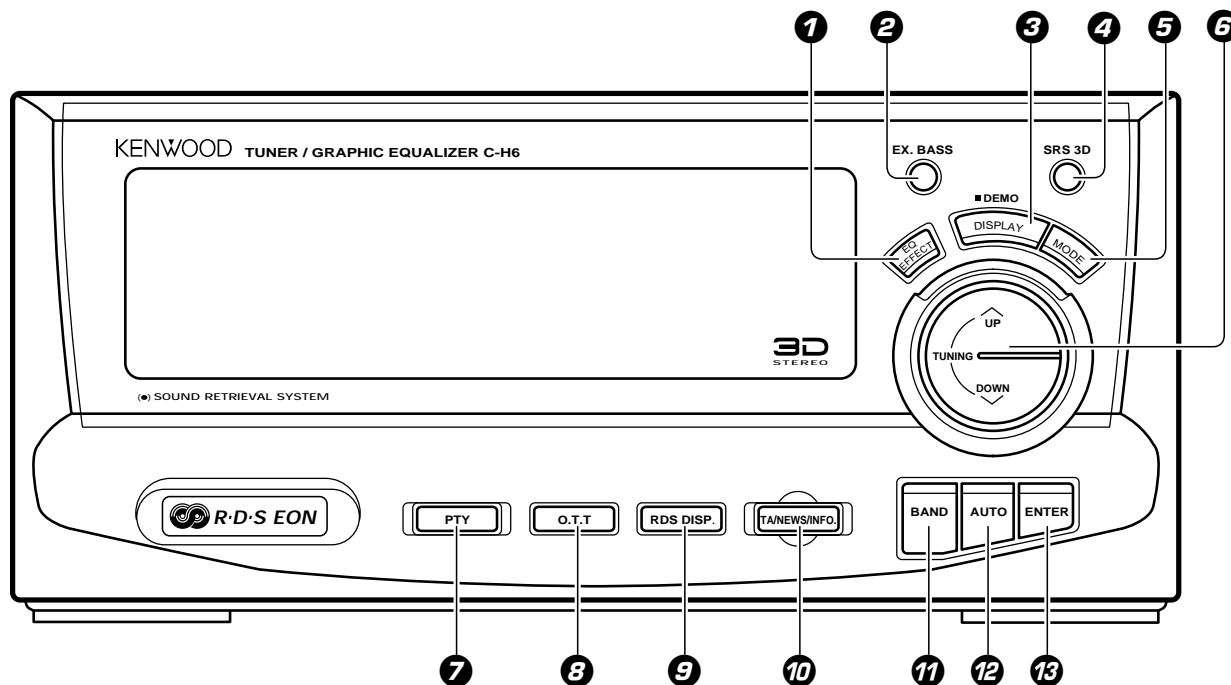

- 1 EQ. EFFECT key** → [60](#)
 The equalizer effect is switched ON/OFF and the type of equalizer effect is selected.
- 2 EX. BASS (Extra bass) key/Indicator** → [21](#) → [66](#)
 When power is ON: Press to enhance the high and low frequencies.
 When power is STANDBY: Used in the timer setting operation.
- 3 DISPLAY/DEMO key** → [60](#)
 When power is ON: Switches the displayed information. Switches the demonstration on and off.
 When power is STANDBY: Switches the demonstration on and off.
- 4 SRS 3D key/Indicator** → [59](#) → [67](#)
 When power is ON: Switches the SRS 3D play on and off.
 When power is STANDBY: Used in the timer setting operation.
- 5 MODE key** → [59](#)
 Press to switch the function of the **TUNING UP/DOWN** keys. The function which can be selected are variable depending on the condition of the system at each moment.

- 6 TUNING UP/DOWN key** → [30](#) → [59](#)
 These keys are usually used to select the broadcast station to be selected. When required, the functions of these keys can be switched with the **MODE** key.
- 7 PTY key** → [46](#)
- 8 O.T.T key** → [65](#)
 Press when setting the O.T.T timer function.
- 9 RDS DISP. key** → [45](#)
- 10 TA/NEWS/INFO. key** → [21](#) → [48](#)
 When power is STANDBY: Switches the auto power-save mode on and off.
- 11 BAND key** → [30](#)
 Press to switch the receiving band.
- 12 AUTO key** → [31](#) → [64](#)
 When power is ON: Switches the tuning mode.
 When power is STANDBY: Used in the clock adjustment.
- 13 ENTER key**
 Used for time setting, timer setting, etc.

Display (C-H6)

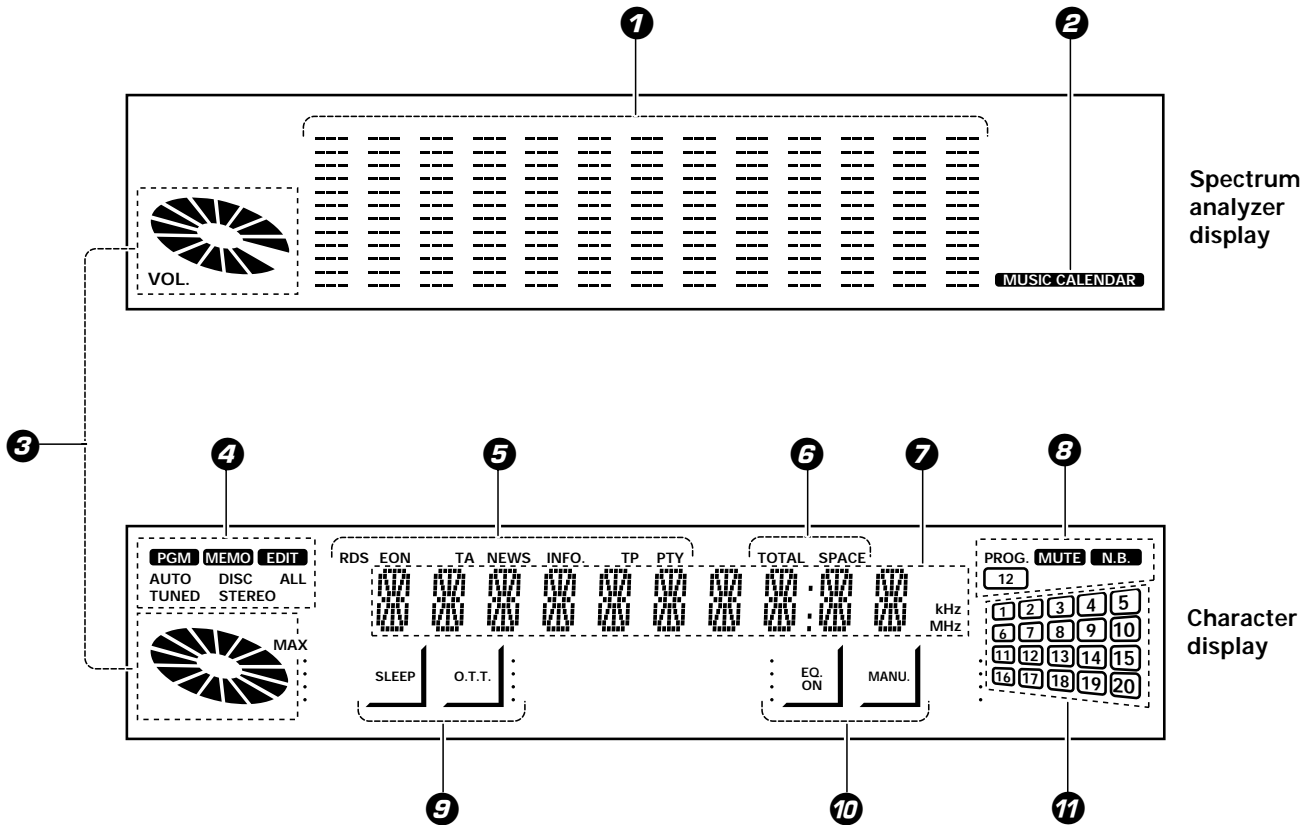

1 Equalizer indicator

This section shows the equalizer pattern in use. The equalizer pattern display format can be switched.

2 MUSIC CALENDER indicator

3 Volume indicator

The display varies as the **VOLUME CONTROL** of the amplifier unit (A-H5) is operated. Usually, this section shows the current volume setting.

4 Tuner and applied operation indicators

This section contains the indicators of the tuner operations as well as applied CD operation.

5 RDS-related indicators

6 CD-related indicators

These indicator light during recording and playback of CD.

7 Character information indicators

8 Timer reservation program No./MUTE/N.B. indicators

9 Timer-related indicators

10 Equalizer operation indicators

11 Music calendar indicators

The indicators in this section show the number of tracks recorded on a CD. Each track number indicators turns off when the playback of the track has completed.

Tuner/Equalizer Unit (C-H5)

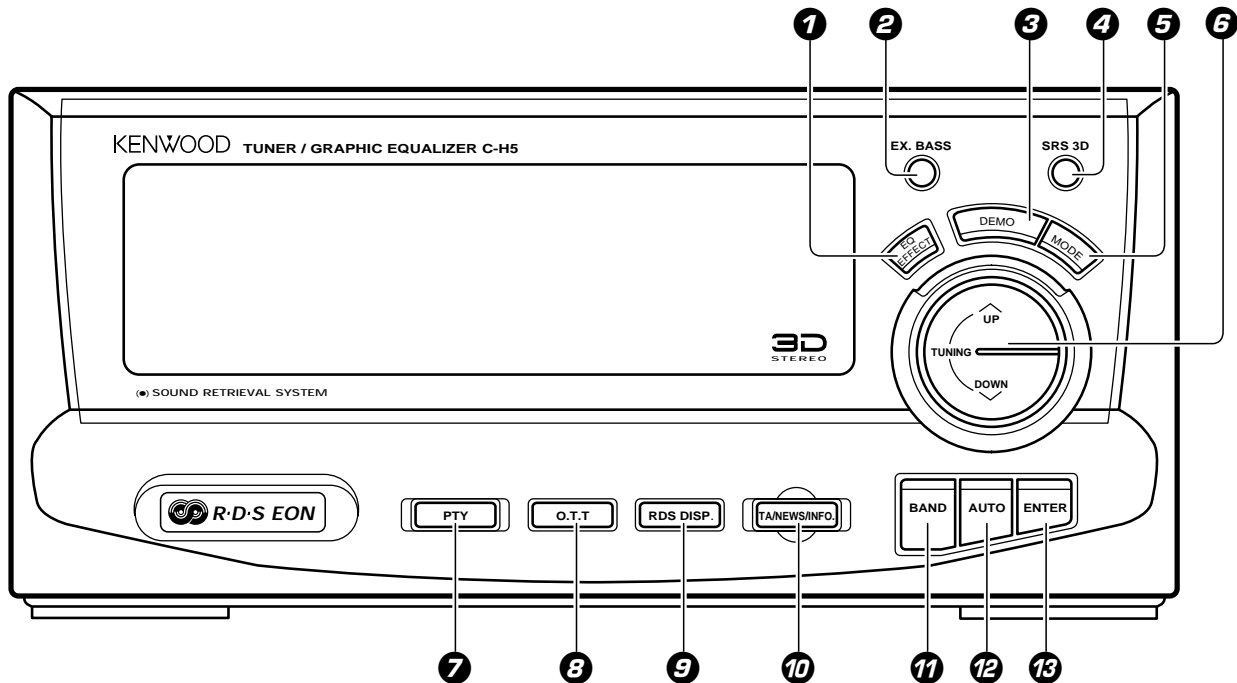

1 EQ. EFFECT key → 60
The equalizer effect is switched ON/OFF and the type of equalizer effect is selected.

2 EX. BASS (Extra bass) key/Indicator → 21 → 66
When power is ON: Press to enhance the high and low frequencies.

When power is STANDBY: Used in the timer setting operation.

3 DEMO key → 60
Press to switch the demonstration on/off.

4 SRS 3D key/Indicator → 59 → 67
When power is ON: Switches the SRS 3D play on and off.
When power is STANDBY: Used in the timer setting operation.

5 MODE key → 59
Press to switch the function of the **TUNING UP/DOWN** keys. The function which can be selected are variable depending on the condition of the system at each moment.

6 TUNING UP/DOWN key → 30 → 59
These keys are usually used to select the broadcast station to be selected. When required, the functions of these keys can be switched with the **MODE** key.

7 PTY key → 46

8 O.T.T key → 65
Press when setting the O.T.T timer function.

9 RDS DISP. key → 45

10 TA/NEWS/INFO. key → 21 → 48
When power is STANDBY: Switches the auto power-save mode on and off.

11 BAND key → 30
Press to switch the receiving band.

12 AUTO key → 31 → 64
When power is ON: Switches the tuning mode.
When power is STANDBY: Used in the clock adjustment.

13 ENTER key
Used for time setting, timer setting, etc.

Display (C-H5)

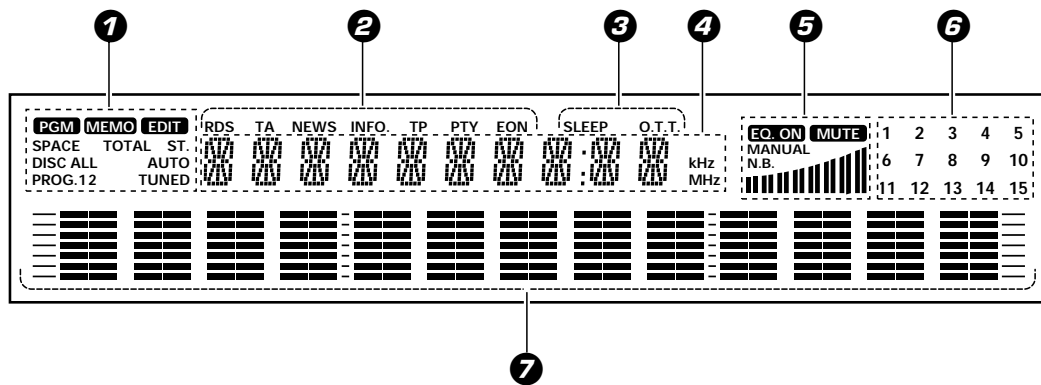

1 Tuner and applied operation indicators

This section contains the indicators of the tuner operations as well as applied CD operation.

2 RDS-related indicators

3 Timer-related display

4 Character information display

5 Volume/tone-related display

This includes the graphic display of the current volume size and the indicators which light up when the equalizer is controlled.

6 Music calendar display

The indicators in this section show the number of tracks recorded on a CD. Each track number indicators turns off when the playback of the track has completed.

7 Graphic equalizer display

The displayed equalizer pattern varies according to the music played. The equalizer pattern display format can be changed as required.

Amplifier unit

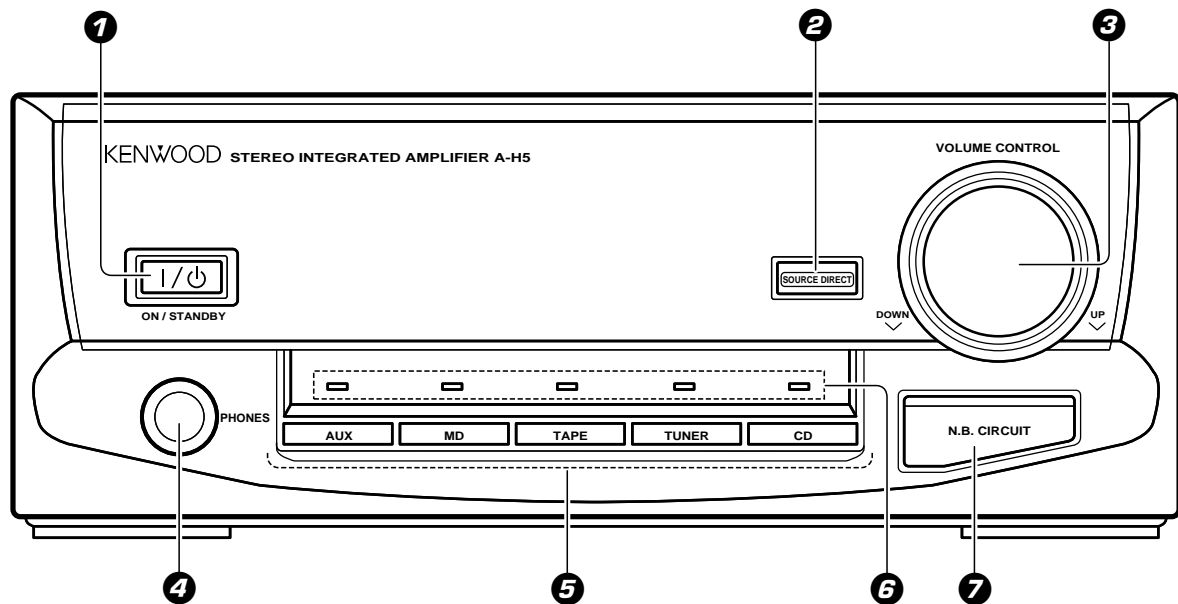

1 ON/STANDBY (I / ⏻) key/Indicator

Power ON/OFF switching is executed.

The indicator in the key lights in green when the power is ON and in red when it is off (provided that the power cord is connected to a power outlet).

2 SOURCE DIRECT key/Indicator

Press the key when you want to enjoy a purer sound.

→ 21

3 VOLUME CONTROL knob

Normally this is used for volume adjustment.

This control is also used to adjust the input level when the MD recorder or other external equipment is used.

4 PHONES terminal

For connection of a headphone (optional).

5 Input key

Press to select the input source. When TAPE or CD is selected, playback starts automatically provided that a tape or disc has already been loaded.

6 Input indicators

The indicator corresponding to the currently selected input source lights up.

7 N.B. CIRCUIT key

Press to compensate for the lack of heavy bass sound which may occur during low-level listening.

→ 21

Cassette deck unit

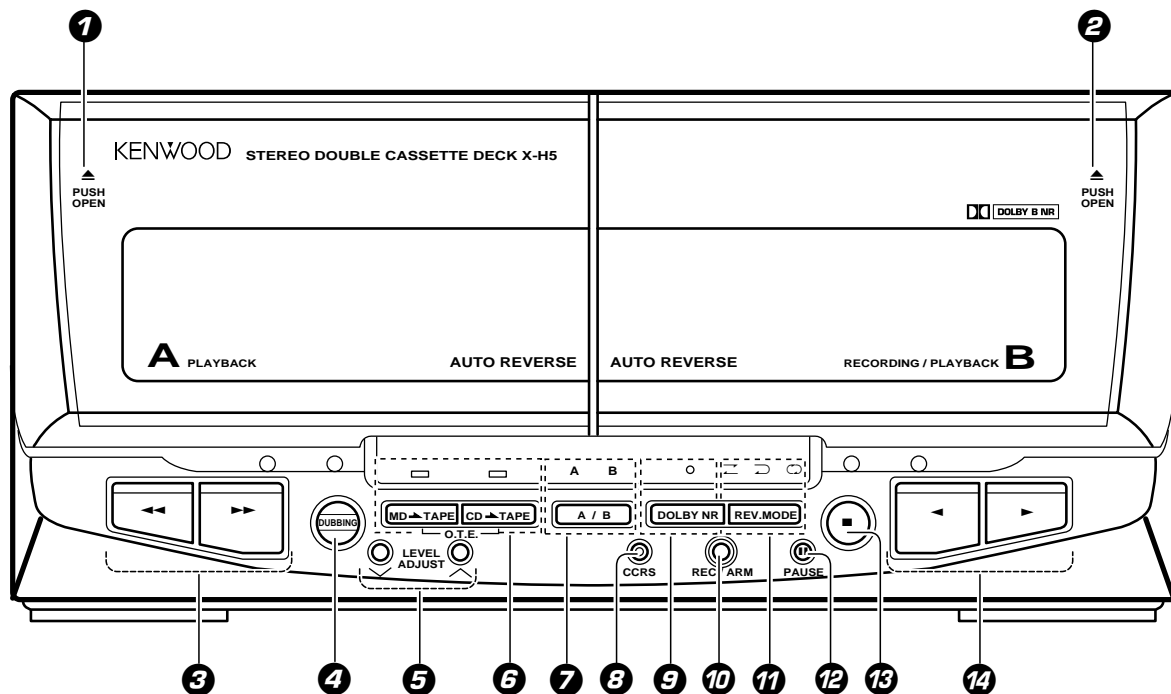

1 A deck cassette holder

Press the area marked **PUSH OPEN** to load or eject a tape.

2 B deck cassette holder

Press the area marked **PUSH OPEN** to load or eject a tape.

3 Fast forward and rewind (◀▶) keys

4 DUBBING key

→ 35

The contents of the tape of the A deck are copied to the tape of the B deck.

5 LEVEL ADJUST key

→ 34

Press to adjust the input level for recording.

6 O.T.E. key/Indicator

→ 52

CD→TAPE : When this key is pressed during CD playback, only the title being played at that time will be recorded on tape. When this key is pressed during stop, the CD selected at that time will be recorded on tape from the first title onward.

MD→TAPE : When this key is pressed during MD playback, only the title being played at that time will be recorded on tape. When this key is pressed during stop, the MD selected at that time will be recorded on tape from the first title onward. Please also read the instruction manual of the optional MD recorder (DM-F70).

7 A/B key/Indicator

Press to select the deck to be operated.

8 CCRS key/Indicator

The CCRS can be used when recording CD onto a tape.

→ 50

9 DOLBY NR key/Indicator

Dolby noise reduction ON/OFF switching is executed.

→ 27

10 REC/ARM key/Indicator

Press to start recording. Pressing the key during recording stops it after leaving a non-recorded space (blank) of about 4 seconds.

→ 33

11 REV. MODE key/Indicator

The reverse mode of the deck (both sides, repeated, one side) is switched.

→ 27

12 PAUSE (||) key/Indicator

Press to let playback or recording pause temporarily.

13 Stop (■) key

14 Play (◀▶) keys

CD player unit (DP-H5)

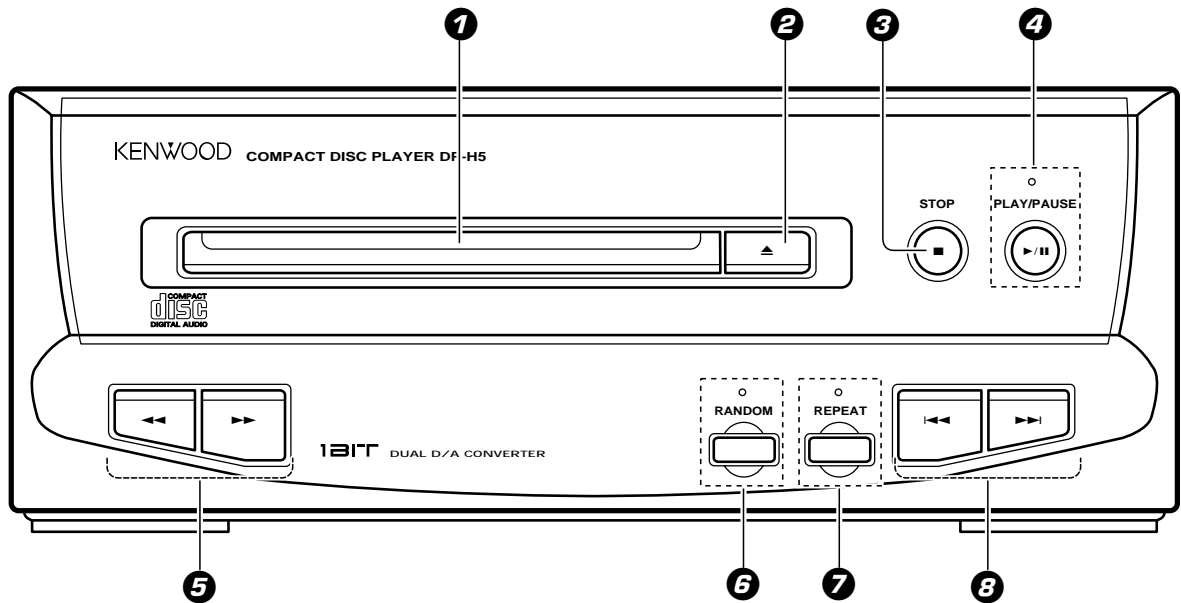

1 Disc tray

2 Eject (▲) key

The disc tray is opened and closed.

3 STOP (■) key

4 PLAY/PAUSE (▶/⏸) key/Indicator

The playback or pause functions are activated alternately every time the key is pressed.

5 Fast forward and fast reverse (⏩ ⏪) keys

Press to move the played position forward or backward.

6 RANDOM key/Indicator

Press to play tracks in a different order than the recorded order. → 39

7 REPEAT key/Indicator

Press to start repeat playback. → 38

8 Skip (⏮ ⏭) keys

Press to skip tracks to the beginning of the desired track.

CD player unit (DP-MH5)

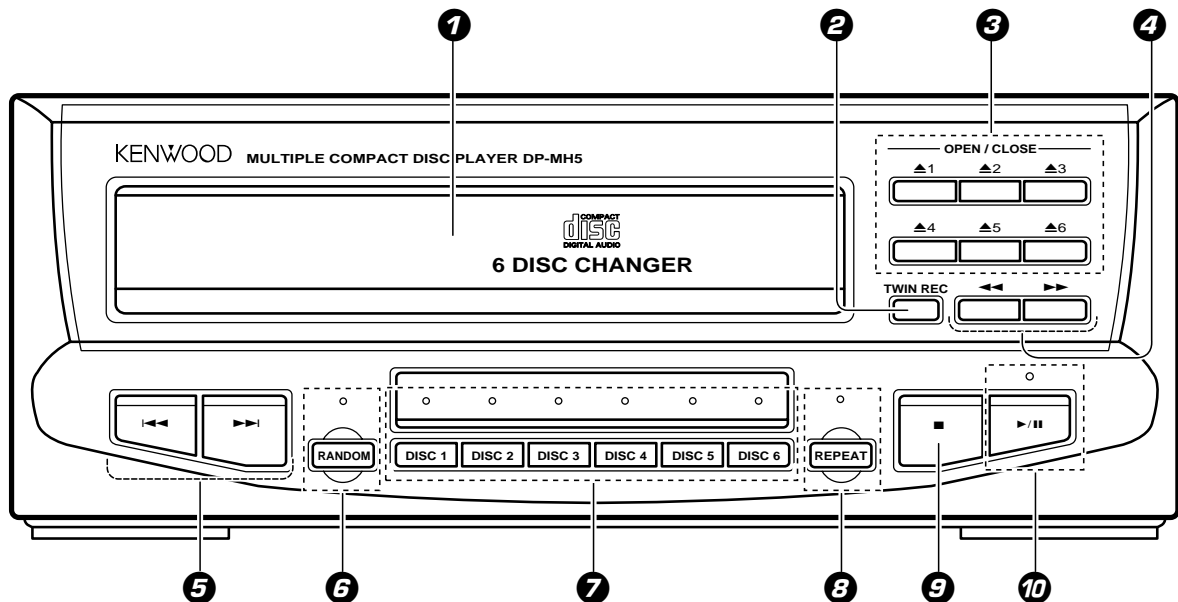

1 Disc tray

2 TWIN REC key

Press when recording CD simultaneously onto a MD and tape. → 58

3 OPEN/CLOSE (▲1-▲6) key

The disc tray is opened and closed.

4 Fast forward and fast reverse (◀◀ ▶▶) keys

Press to move the played position forward or backward.

5 Skip (◀◀ ▶▶) keys

Press to skip tracks to the beginning of the desired track.

6 RANDOM key/Indicator

Press to play tracks in a different order than the recorded order. → 43

7 Disc selector (DISC 1 to DISC 6) keys/indicators

Press one of the keys to select the disc to be played. If a disc exists in the selected tray, the indicator of the key lights up. The indicator blinks during playback of the disc.

8 REPEAT key/Indicator

Press to start repeat playback. → 42

9 Stop (■) key

10 Play/pause (▶/||) key

The playback or pause functions are activated alternately every time the key is pressed.

Remote control Unit

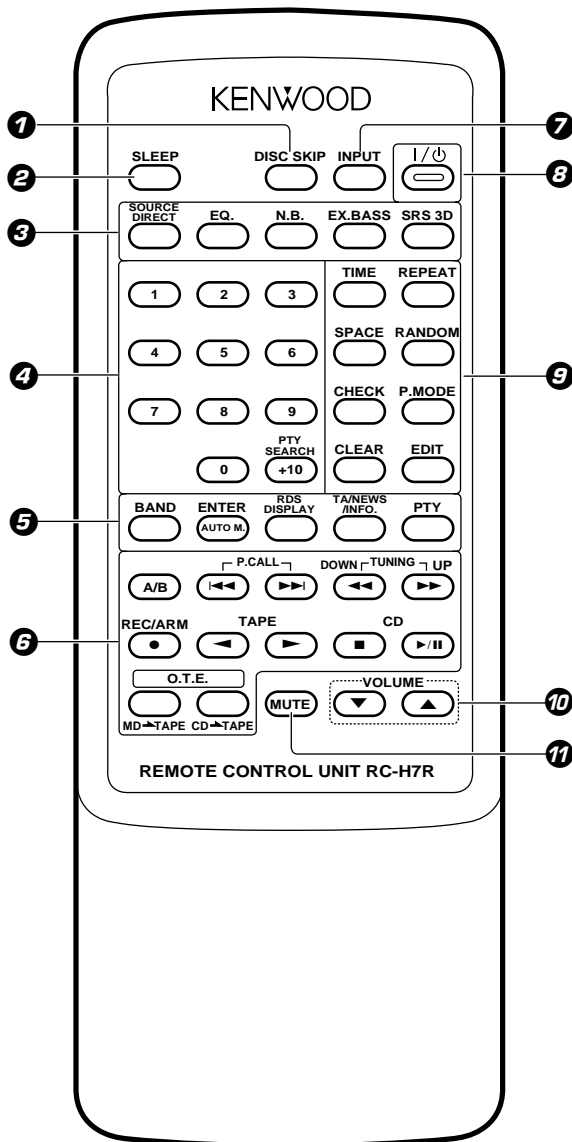

Model: RC-H7R
Infrared ray system

1 DISC SKIP key (For DP-MH5)

Press to select the disc to be used for playback or recording.

2 SLEEP key

Press to set the sleep timer function. → 65

3 Tone control-related keys

SOURCE DIRECT key : Press the key when you want to enjoy a purer sound. → 21

EQ. key : Press before operating the equalizer. → 60

N.B. key : Press to compensate for the lack of heavy bass sound which may occur during low-level listening. → 21

EX. BASS key : Press to enhance the high and low frequencies. → 21

SRS 3D key : Switches the SRS 3D play on and off. → 59

4 Numeric keys

Select a CD track or tuner stations.

5 Tuner-related keys

BAND key : Press to switch the receiving band. → 30

ENTER/AUTO M. key : Press when entering a station in memory. → 31

RDS DISPLAY key

TA/NEWS/INFO. key

PTY key

6 General operation keys

A/B key : Press to select the deck to be operated.

P.CALL (◀◀▶▶) keys :

When the TUNER input is selected, used to recall a preset station.

When the CD input is elected, used to skip tracks. → 30

TUNING UP/DOWN (◀▶) keys :

When the TUNER input is selected, used to receive a station.

When the CD or TAPE input is selected, used to move the played position in the forward or reverse direction. → 23 → 25

REC/ARM (●) key :

Press to start recording. Pressing the key during recording stops it after leaving a non-recorded space (blank) of about 4 seconds. → 33

TAPE play (◀▶) keys

Stop (■) key

CD play/pause (▶/■) key

O.T.E. MD→TAPE key : Press when copying sound from a MD to a tape.

O.T.E. CD→TAPE key : Press when copying sound from a CD to a tape. → 50

7 INPUT key

Press to select the input source to be played or recorded. This key has the same function as the input selector keys on the amplifier unit.

8 On/standby (I / ⏻) key

This key has the same function as the key with the same name on the amplifier unit.

9 CD applied operation-related keys

TIME key : Press to switch the time information displayed on the CD player. → 23 → 25

REPEAT key : Press to play CD track(s) repeatedly. → 38 → 42

SPACE key : Press during CD recording, etc. to create a non-recorded blank of a few seconds. → 37 → 41

RANDOM key : Press to play tracks in a different order than the recorded order. → 39 → 43

CHECK key : Press to check the order of tracks which have been programmed. → 37 → 41

P.MODE key : Press to switch the program mode on-off. This key is also used when entering a track in the program. → 36 → 40

CLEAR key : Press to clear a programmed track(s). → 37 → 41

EDIT key : Press when recording a CD. → 55

10 VOLUME CONTROL (▽ △) keys

These keys have the same function as the VOLUME CONTROL on the amplifier unit.

11 MUTE key

→ 21

Loading batteries

❶ Remove the cover.

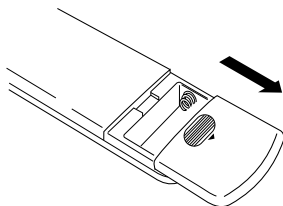

❷ Insert batteries.

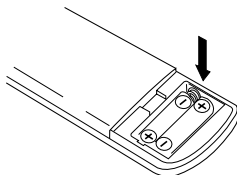

❸ Close the cover.

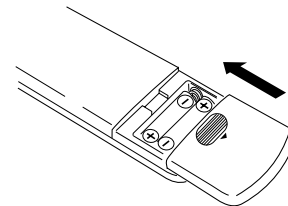

- Insert two R6 ("AA"-size) batteries following the polarity indications.

Operation

Plug the power cord of the amplifier unit (A-H5) into a power outlet and press the ON/STANDBY (I / ⏻) key of the remote control unit to turn power ON. When the power is turned ON, press the desired operation keys.

To turn power off, press the I / ⏻ (on/standby) key again. The system enters the standby mode in which only the time display is lit.

- When pressing more than one remote control keys successively, press the keys securely by leaving an interval of 1 second or more between keys.

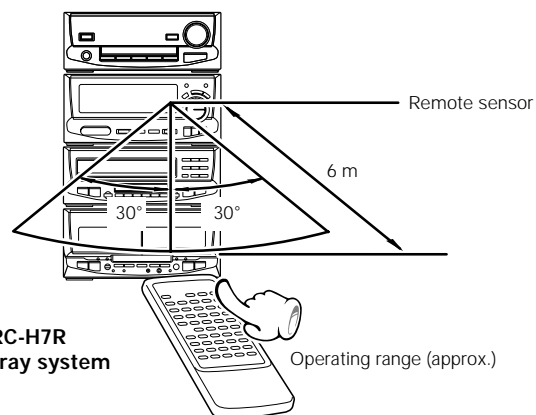

1. The provided batteries are intended for use in operation checking, and their service life may be short.
2. When the remote controllable distance becomes short, replace both of the batteries with new ones.
3. If direct sunlight or the light of a high-frequency fluorescent lamp (inverter type, etc.) is incident to the remote sensor, malfunction may occur. In such a case, change the installation position to avoid malfunction.

Basic use method

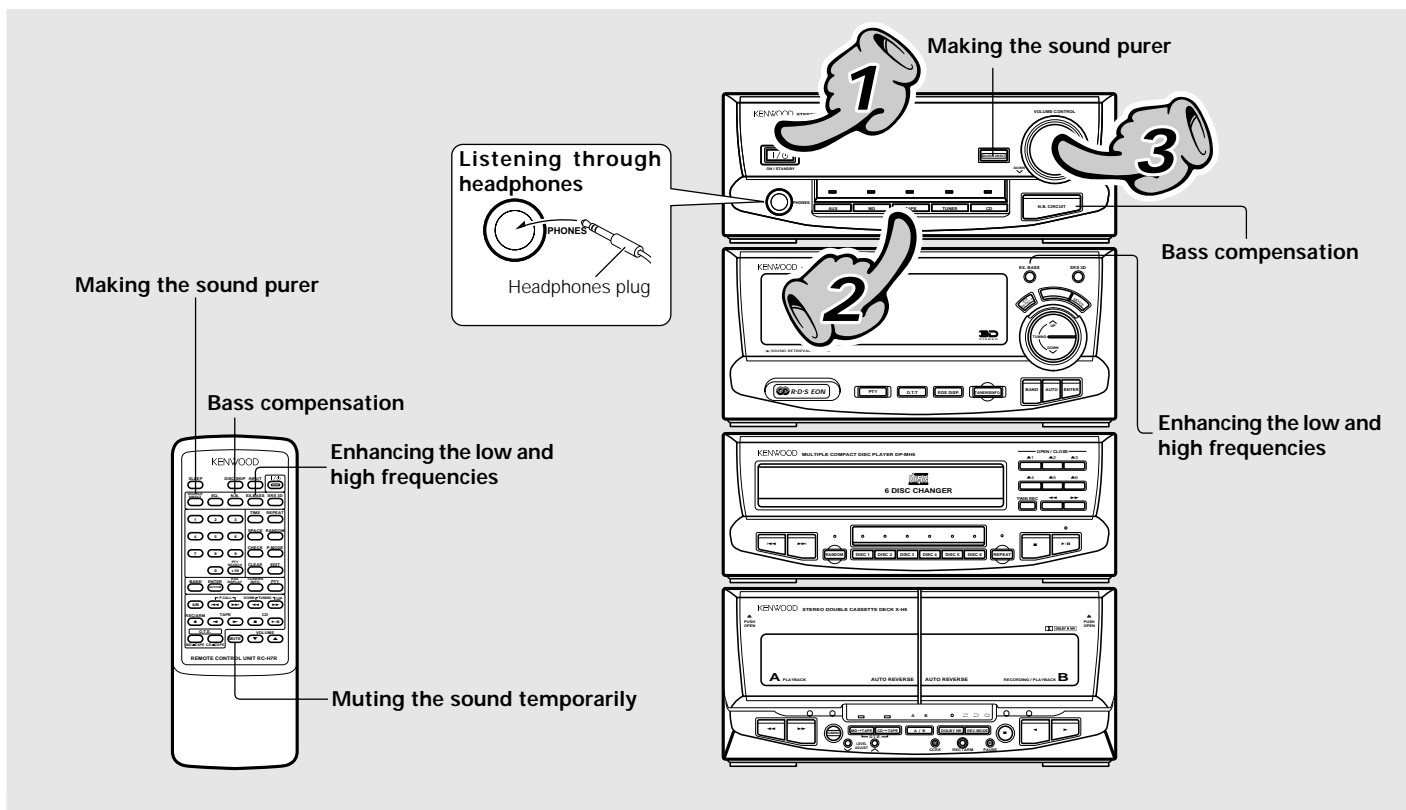

Basic section

Press the ON/STANDBY key.



1. Switching the power ON (OFF)

When the ON/STANDBY (I / ⏻) key is pressed while the power is ON, the power will be switched OFF.

- The display part becomes dark when the power is switched OFF. (DIMMER function)



2. Selecting the desired output

CD (DP-H5)	→ 22
CD (DP-MH5)	→ 24
Tape	→ 26
Broadcasts	→ 30

- When you are using the remote control unit, press the **INPUT** key repeatedly until the desired source is selected.
- When CD or TAPE is selected, playback will start when a disc or a tape already has been inserted.
- When using the MD recorder, be sure to read the instruction manual of the optional MD recorder (DM-F70).
- When you select the AUX input, be also sure to read the instruction manual of the component connected to the AUX input jacks.

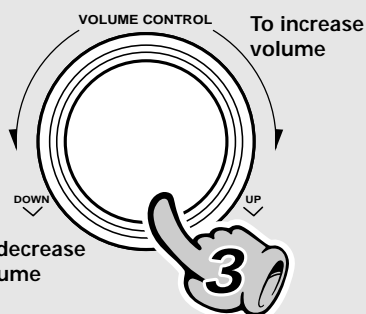

3. Volume adjustment

- Quick turning produces a larger change amount. (Dynamic rotary volume control function)
- The display shows a reference value.

Making the sound purer (SOURCE DIRECT)

When SOURCE DIRECT is on, the signal path inside the system is simplified so that the sound can be reproduced with an improved purity.



- Other functions than the balance control cannot be used because the audio signals bypass the circuits.
- Press the key again to switch SOURCE DIRECT off.

Bass compensation (N.B.CIRCUIT : Natural Bass circuit)

The N.B. CIRCUIT allows to enjoy low frequencies in a natural tone.

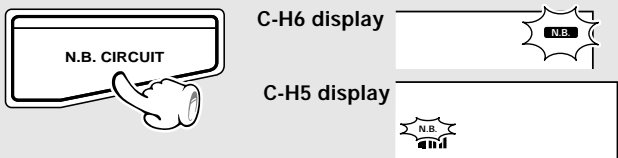

Each press of the key switches the setting.

- 1 NB 1 The low frequencies are compensated according to the current volume level. (Effective for low-level listening)
- 2 NB 2 The low frequencies are compensated regardless of the volume level.
- 3 NB OFF (N.B. deactivated)

Enhancing the low and high frequencies (EX. BASS)

The Extra Bass has been set to on when the system left the factory.



- Each press switches EX.BASS on and off alternately.

Muting the sound temporarily (Remote control unit only)



- Press again to resume the original volume.
- The sound muting is also cancelled when the volume is controlled.

Listening through headphones

- 1 Insert the headphone plug into the PHONES jack.
 - The sounds from all speakers are cut off.
- 2 Adjust the volume.
 - Be sure to decrease the volume before plugging or unplugging the headphones.

When CD has been selected.

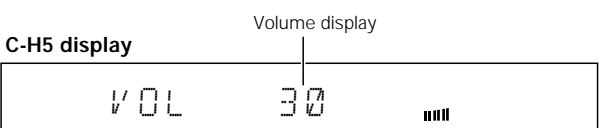
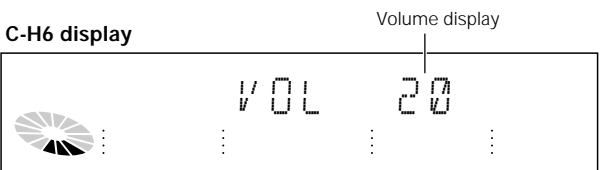
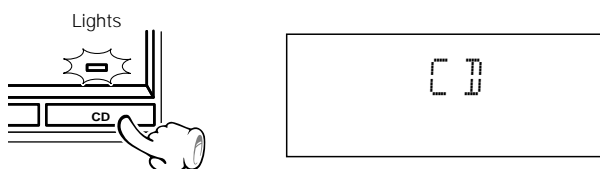

AUTO POWER SAVE function

When the power is ON and neither recording nor playback is executed for 30 minutes or more, the power is switched off automatically by this function. This function can be made active or not active by the following operation.

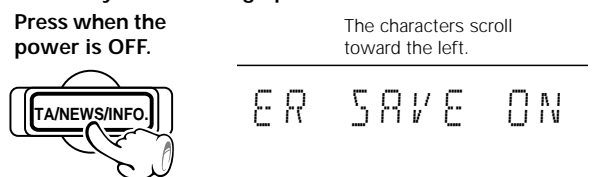

Each press switches the modes as follows.

- 1 "AUTO POWER SAVE ON" Auto power save is used.
- 2 "AUTO POWER SAVE OFF" Auto power save is not used.

- This function is not available when the AUX input is selected. When the TUNER input is selected, it is available only when the volume is set to 0.

STANDBY mode

While the power cord of the set is plugged into an AC power outlet, the ON/STANDBY (I / ⏻) key lights in red even when the power is not switched ON. This indicates that a small amount of current is being supplied to the unit to back up the memory contents. This mode is referred to as the Standby mode. While the ON/STANDBY (I / ⏻) key is lit, the power of the system can be switched ON/OFF from the remote control unit.

Playback of CD (DP-H5)

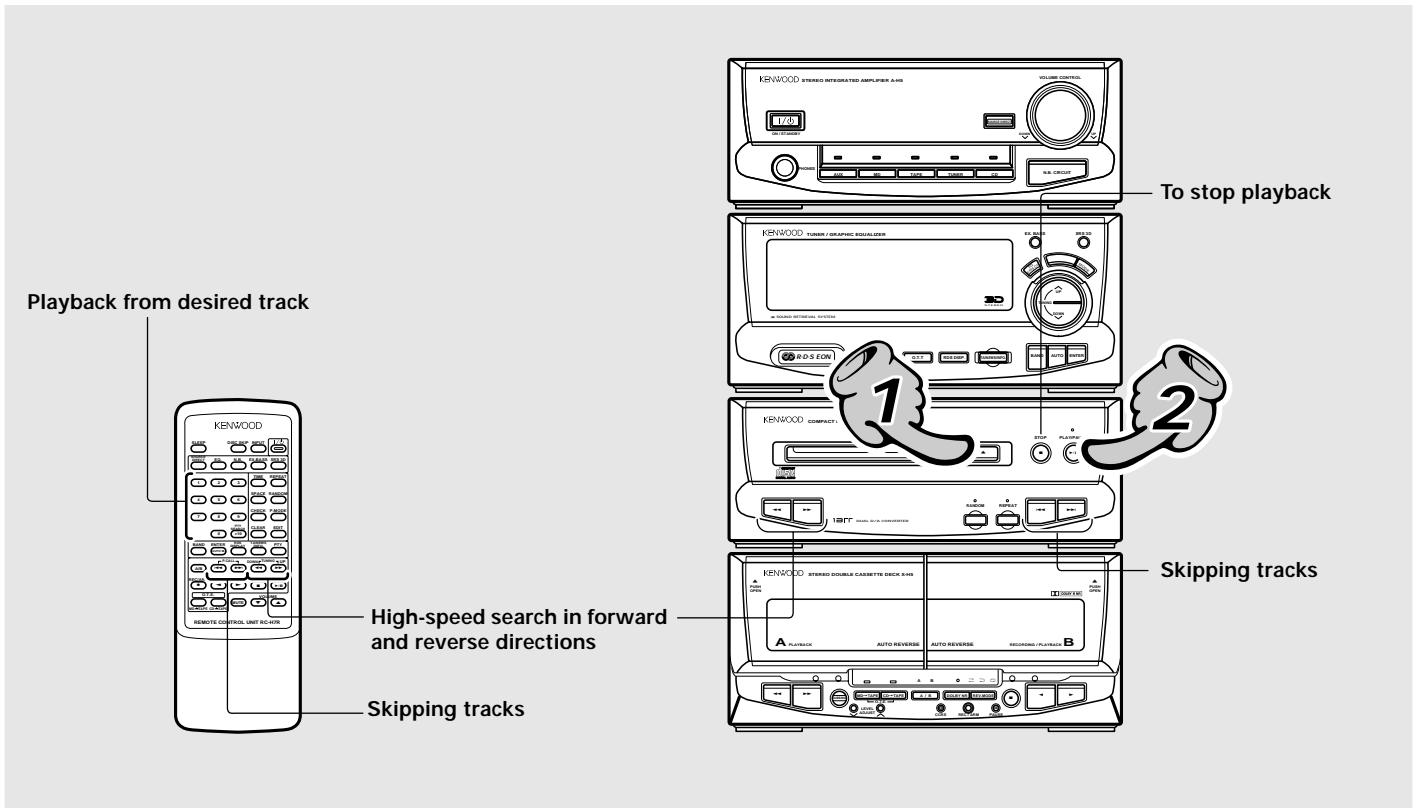

Basic section

1. Load a disc.

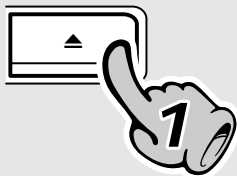

- ① Open the tray.
- ② Place a disc.
- ③ Close the tray.

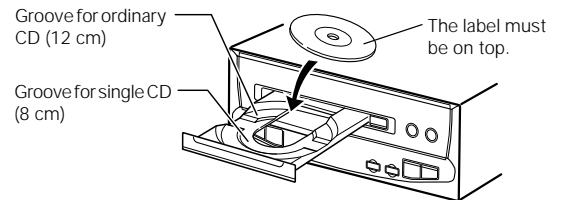

The tray opens when the key is pressed and closes when the key is pressed again.

Do not place more than one disc at a time, for this will lead to malfunction.

2. Start playback.

○
PLAY/PAUSE



Lights up when play starts

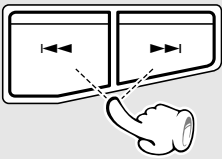

Skipping tracks

To skip backward  To skip forward

- The track in the direction of the button pressed is skipped, and the selected track will be played from the beginning.
- When the **⏮** key is pressed once during playback, the track being played will be played from the beginning.

High-speed search in forward and reverse directions

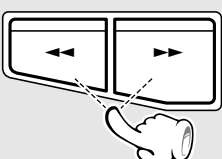
Backward search  Forward search

- Playback starts from the position where the key is released.

To stop playback

STOP



- Do not touch the played side of disc.
- Place the disc correctly along the groove on the tray. (A disc deviated from the correct position may cause malfunction.)
- The commercially-available CD single (8 cm) disc adapter cannot be used with the set.

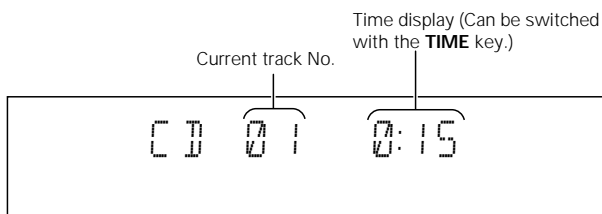

- After a few seconds, play starts from track No.1.

Playback from desired track

Select the desired track No.

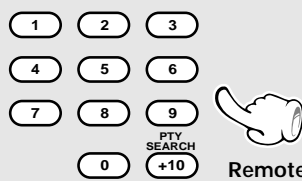

Remote control unit

Press the numeric keys as shown below....

To enter track No. 23 : **+10** **+10** **3**

To select track No. 40 : **+10** **+10** **+10** **+10** **0**

To pause playback



- Each press pauses and plays the CD alternately.



The disc indicators light up when the power is turned ON, but they go off in a few seconds when no disc is loaded.

Time display for the CD player

Each press of the TIME key switches the time information.

- ① 1:23 : Elapsed time of track being played
- ② - 2:37 : Remaining time of track being played
- ③ 23:45 : Elapsed time of disc ("TOTAL" lights.)
- ④ - 36:15 : Remaining time of disc ("TOTAL" lights.)

- The **TOTAL** display items are not shown in the EDIT and RANDOM modes.

Playback of CD (DP-MH5)

Up to 6 discs can be loaded in the CD player unit. During playback of a disc, any of the other 5 discs can be replaced.

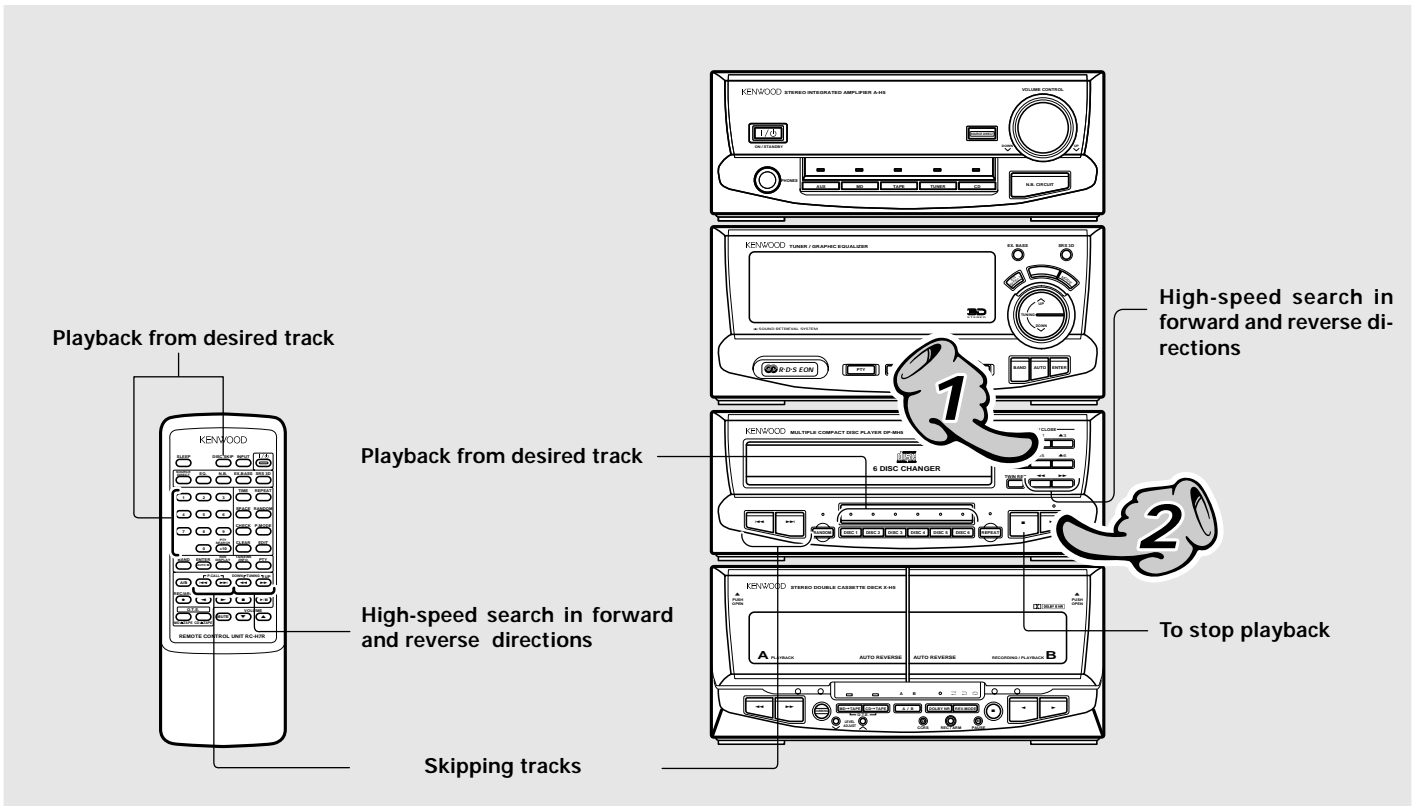

Basic section

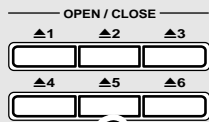

The tray opens when the key is pressed and closes when the key is pressed again. Pressing the key of another disc number while the tray is open closes the tray automatically and opens the tray for the pressed disc number.

1. Load a disc.

- ① Open the tray.
- ② Place a disc.
- ③ Close the tray.

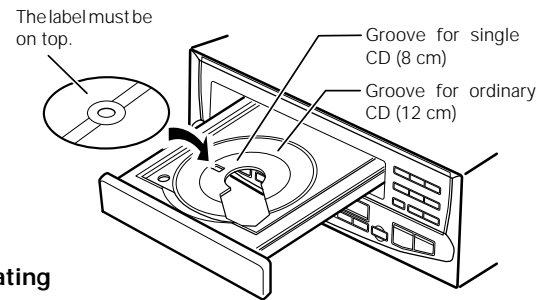

Up to 6 discs can be stored by repeating steps ① to ③ for each. Do not place more than one disc at a time, for this will lead to malfunction.

2. Start playback.

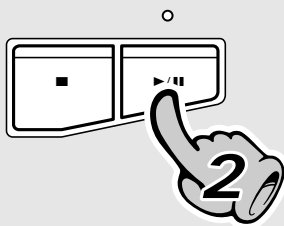

Lights up when play starts

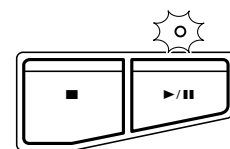

Skipping tracks

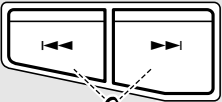
To skip backward  To skip forward

- The track in the direction of the button pressed is skipped, and the selected track will be played from the beginning.
- When the **⏮** key is pressed once during playback, the track being played will be played from the beginning.

High-speed search in forward and reverse directions

Backward search  Forward search

- Playback starts from the position where the key is released.



To stop playback

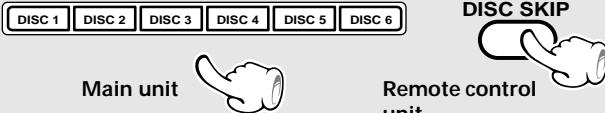

Playback from desired track

① Select the disc.



Main unit  Remote control unit 

② Select the desired track No.

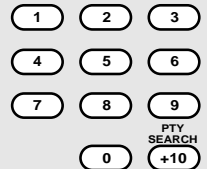

Remote control unit 

Press the numeric keys as shown below....

To enter track No. 23 : **+10 +10 3**

To select track No. 40 : **+10 +10 +10 +10 0**

To pause playback

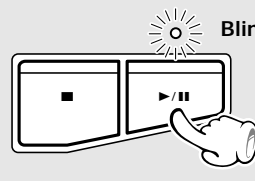

Blinks.

- Each press pauses and plays the CD alternately.



When the power is turned OFF then ON again, all of the disc indicators light up regardless of whether discs are loaded or not.

Indicator of which the disc tray is opened blinks.



- Do not touch the played side of disc.
- Place the disc correctly along the groove on the tray. (A disc deviated from the correct position may cause malfunction.)
- The commercially-available CD single (8 cm) disc adapter cannot be used with the set.

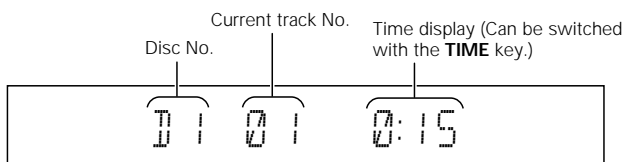

- After a few seconds, play starts from track No.1 of DISC 1.
- To start playback with the desired disc, select the disc with the **DISC1** to **DISC6** disc selector keys.

Time display for the CD player (Provided during playback only)

Each press of the TIME key switches the time information.

- ① 1:23 :Elapsed time of track being played
- ② - 2:37 :Remaining time of track being played
- ③ 23:45 :Elapsed time of disc ("TOTAL" lights.)
- ④ - 36:15 :Remaining time of disc ("TOTAL" lights.)

- The **TOTAL** display items are not shown in the PROGRAM, EDIT and RANDOM modes.

Playback of tape



A tape recorded by using the equalizer or SRS effect should be played back without the effect. → 59, → 60

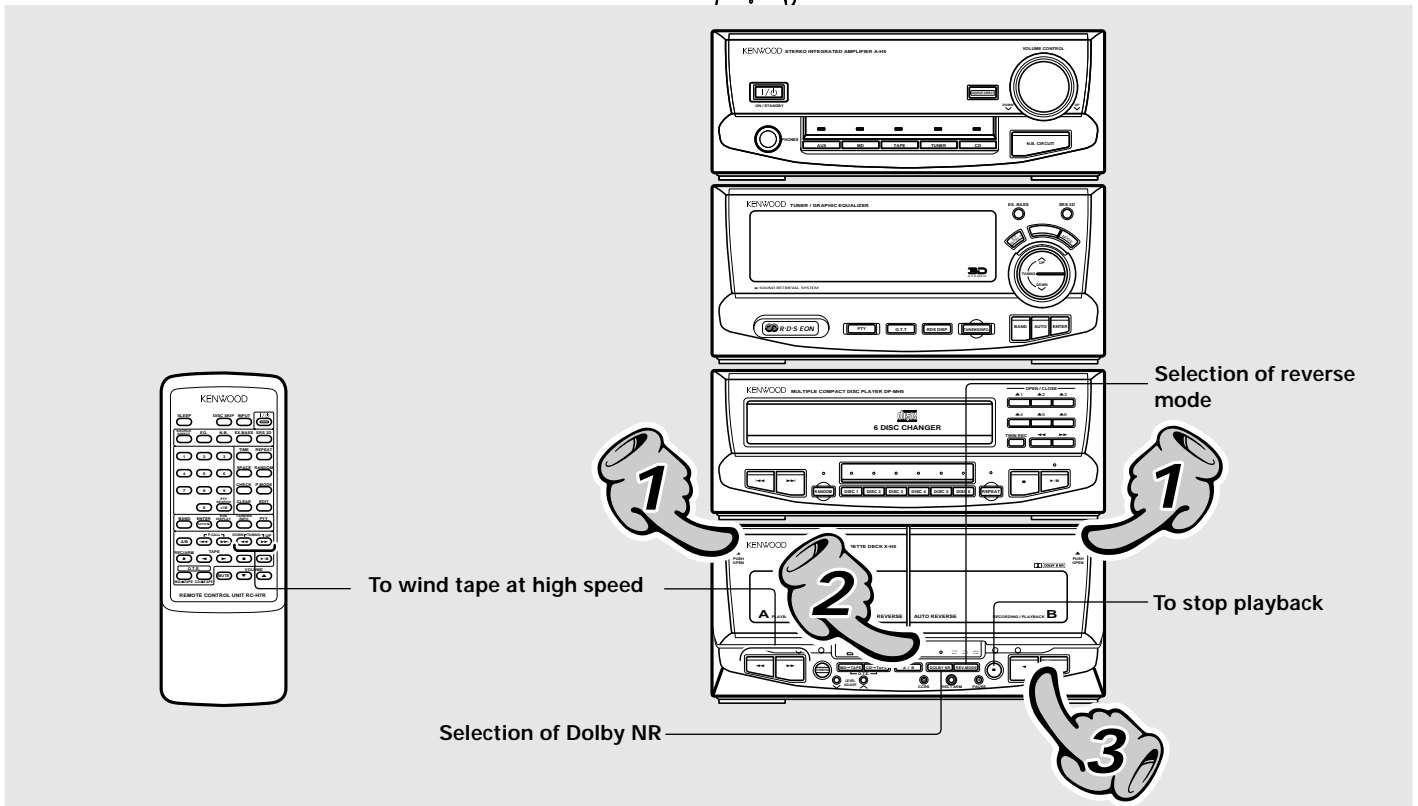

Basic section

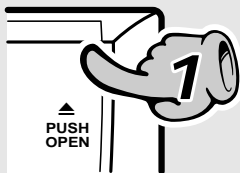

1. Load a cassette tape.

- ❶ Open the door.
- ❷ Insert a tape and close the door.

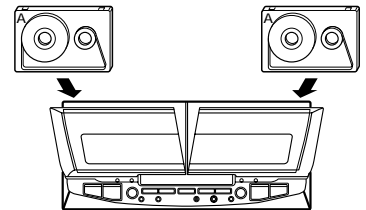

2. Select the deck to be used for playback.

Each press of the key switches A (deck A) and B (deck B) alternately.

The indicator of the selected deck lights up.

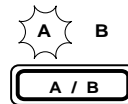

Press ◀ or ▶ key

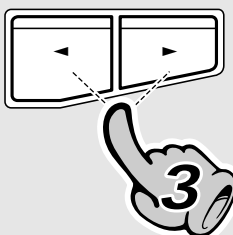

3. Start playback.

Press the play key of the desired direction.

The indicator of the selected direction lights up.

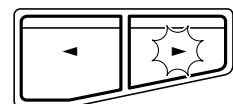

By loading tape in the cassette deck while the power is ON, the cassette deck playback can be started by simply pressing the TAPE input selector key.

To wind tape at high speed

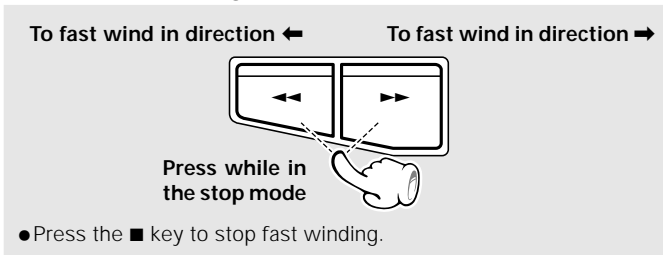

Selection of reverse mode.

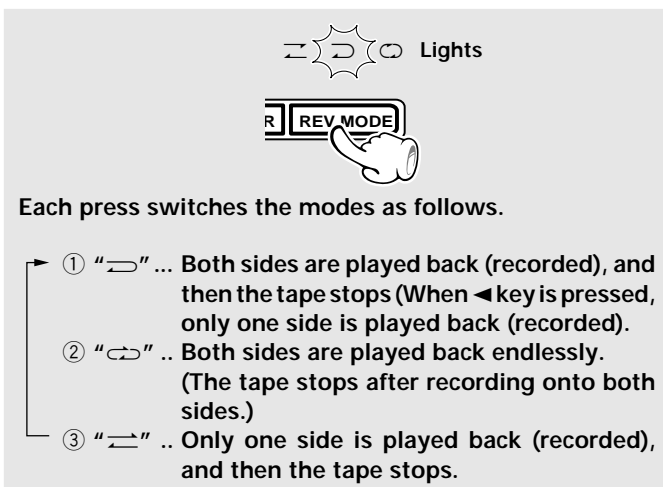

To stop playback

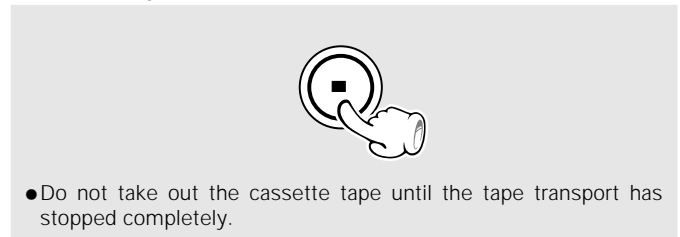

Selection of DOLBY NR (Noise Reduction)

The Dolby NR system minimizes the hiss noise heard when playing tape. When playing a tape prerecorded with Dolby NR ON, be sure to set the DOLBY NR ON for playback.

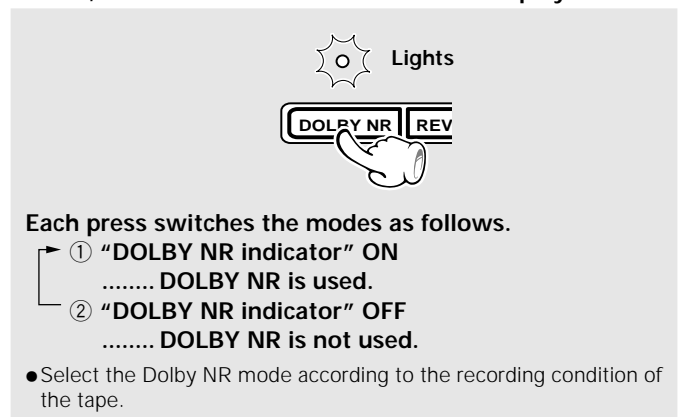

Dolby noise reduction manufactured under license from Dolby Laboratories Licensing Corporation.
"DOLBY" and the double-D symbol are trademarks of Dolby Laboratories Licensing Corporation.

- Normal (TYPE I), high (TYPE II), or metal (TYPE IV) tape selection is set automatically.
- Remove tape slack before loading.
- Close the door securely.

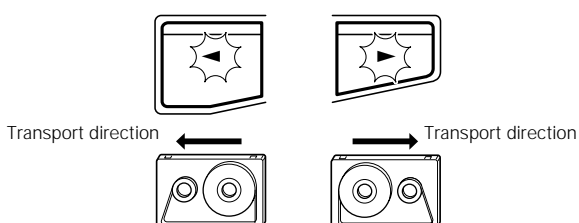

Transport direction indicators

The ◀ and ▶ indicators indicate the current direction in which the tape advances when playback or recording is started automatically by the easy operation function, etc. This direction is the direction stored in memory when the tape was last stopped. (To switch the tape transport direction, press the play key corresponding to the desired direction then press the stop (■) key.)

DPSS (Direct Program Search System)

DPSS (Direct Program Search System) detects an unrecorded part of 4 seconds or more as the interval between titles and permits easy operation of cassette tape like a CD.

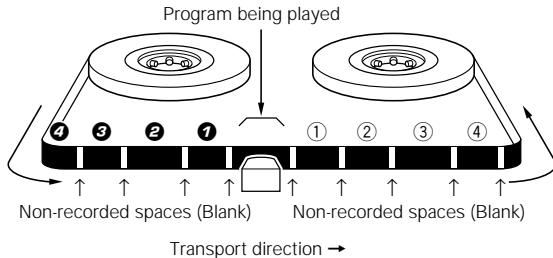

1. Skip search

: Plays the desired music program from the beginning by skipping programs until there. Up to 16 programs can be skipped.

2. Dash & play

: Plays music programs repeatedly by skipping non-recorded spaces of more than 10 seconds.

3. One-program repeat playback

: Plays a single music program repeatedly up to 16 times.

4. Rewind playback

: Rewinds tape to the beginning and restarts playback from there.

Skip search (DPSS)

Plays the desired music program from the beginning by skipping programs until there. Up to 16 programs can be skipped.

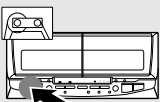
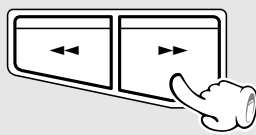
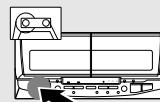
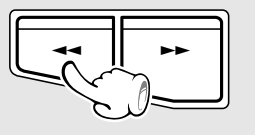
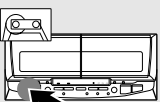
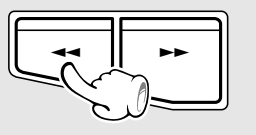
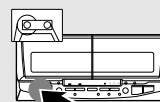
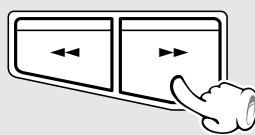
	<div style="border: 1px solid black; padding: 2px; width: fit-content; margin: 0 auto;">During playback of top side (while ► is lit)</div> 		<div style="border: 1px solid black; padding: 2px; width: fit-content; margin: 0 auto;">During playback of reverse side (while ◀ is lit)</div> 
<p>To play the next program : Press once. To play the 4th program after the current program : Press 4 times.</p>		<p>To play the next program : Press once. To play the 4th program after the current program : Press 4 times.</p>	
			
<p>To return to the beginning of the current program : Press once. To play the 4th program before the current program : Press 5 times.</p>		<p>To return to the beginning of the current program : Press once. To play the 4th program before the current program : Press 5 times.</p>	

Listening with fast forward for unrecorded portions (dash & play)

Plays music programs repeatedly by skipping non-recorded spaces of more than 10 seconds.

Main unit only

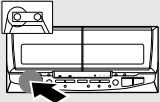
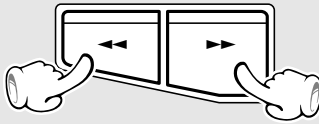
Press simultaneously.

The operation changes in reverse mode.

- ① "↔" lit A tape side is played 8 times, after which playback stops.
- ② "↔" lit The deck stops after having played both sides for once.
- ③ "↔" lit The two tape sides are played 8 times, after which playback stops.

- The tape is played in the direction indicated by the tape direction indicator.
- When the ■ key is pressed, playback stops and the dash & play is cancelled.

One-program repeat playback

Plays a single music program repeatedly up to 16 times.

Press during playback.

During playback of top side (while ► is lit)

During playback of reverse side (while ◀ is lit)

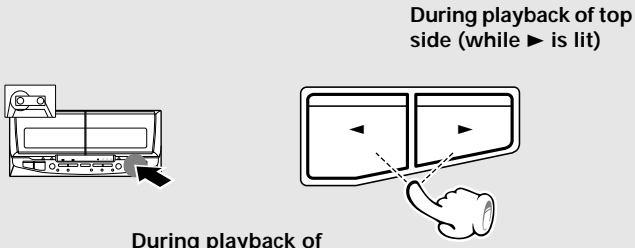

- The program being played will be repeated 16 times, after which normal playback resumes.
- When the ■ key is pressed, playback stops and the one program repeat is cancelled.

Rewind playback

Rewinds tape to the beginning and restarts playback from there.

Main unit only

Press simultaneously.

During playback of top side (while ► is lit)

Press simultaneously.

During playback of reverse side (while ◀ is lit)

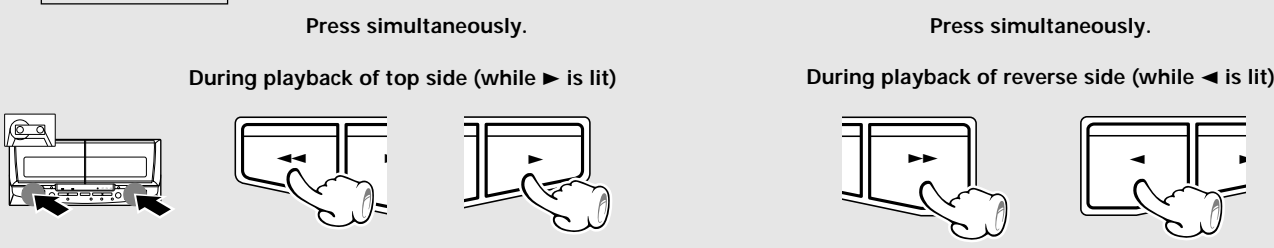



The DPSS may not function normally with the following kinds of tape.

- Tapes containing several no-sound intervals of more than 4 seconds, such as conversation and talk tapes.
- Tapes containing pianissimo sections, such as classical music tape.
- Tapes in which large noise is recorded in blanks between programs.
- Tapes containing blanks between programs that are shorter than 4 seconds.
- Tapes recorded at low level.
- Tapes recorded by cross-fade recording (in which the beginning of next program is overlapped on the end of previous program).

Relay play

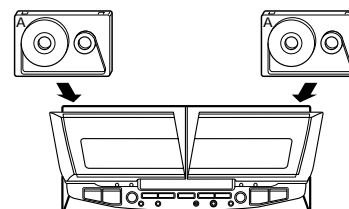
When tapes are set in the decks A and B and the reverse mode is set to "↔" (play of both sides), play of the second deck will be started automatically after play of the first deck has been completed. Tape play will be repeated alternately.



- Relay play is not possible in the reverse modes "↔" and "↔".

Receiving broadcast station

It is also possible to receive them by one-touch operations by storing up to 40 stations in the preset memory.

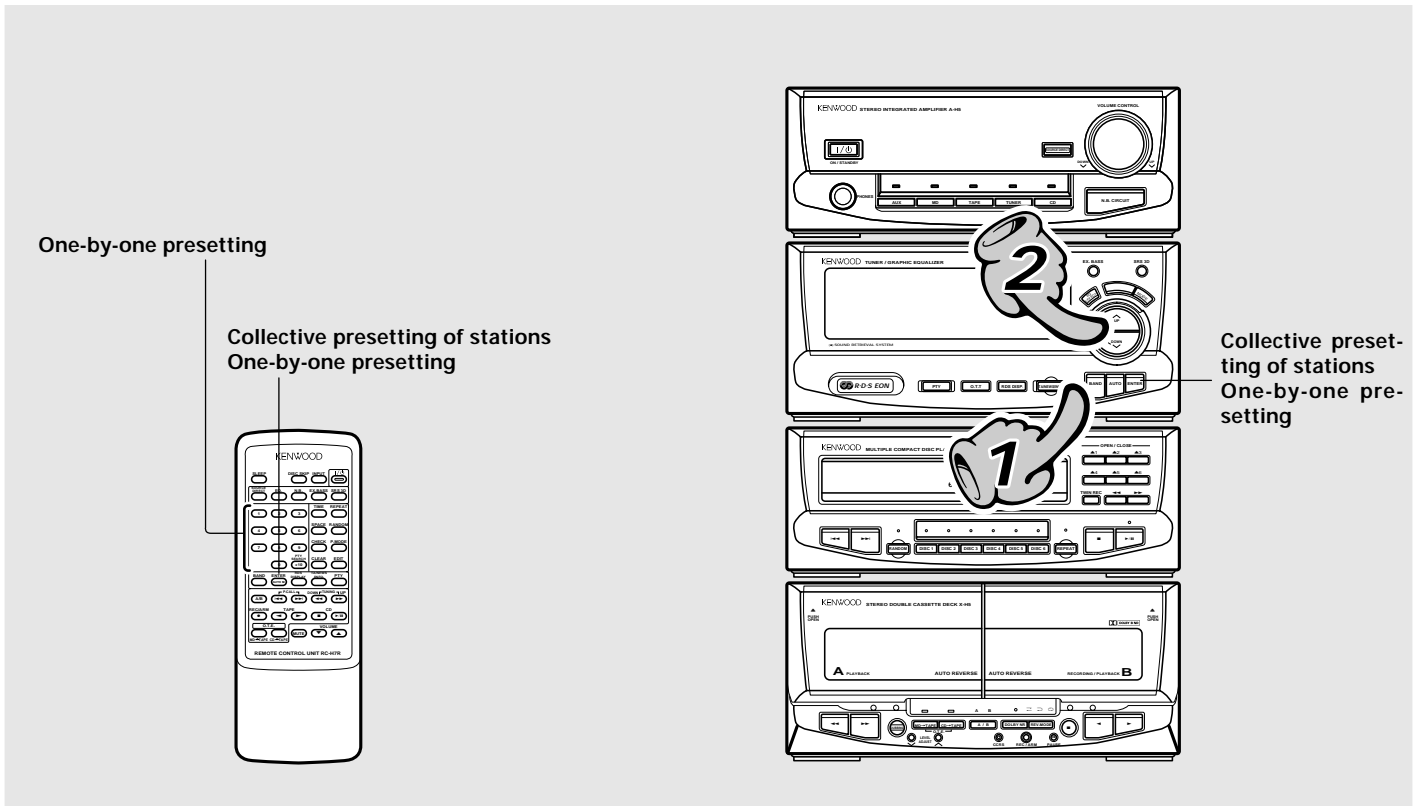

Basic section



1. Select the broadcast band.

Each press changes the band.

- ① FM
- ② AM

•The broadcast bands are variable depending on the model (country or area).

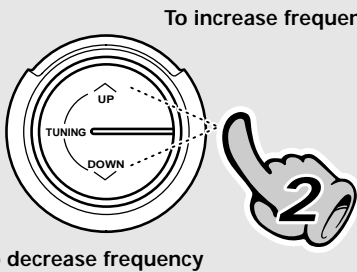

2. Select a station.

When no stations have been memorized

Auto tuning : Each press receives the next station.
Manual tuning : Press the key repeatedly or hold it depressed until a station is received.

When stations have been memorized (preset call)

Remote control unit

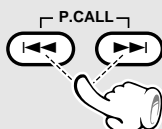

Select a station.

Every time the key is pressed, the preset stations are switched over as follows.

- Press ►► for the order of 1→2→3 ... 38→39→40→1...
- Press ◀◀ for the order of 40→39→38 ... 3→2→1→40...



Collective presetting of stations (auto preset)

Keep the ENTER key depressed (about 2 seconds).

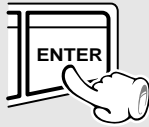

One-by-one presetting (manual preset)

1 Press the ENTER key during reception.



Presetting is cancelled when no operation is executed for 5 seconds or more.

2 Select one of the preset numbers from 1 to 40.

Presetting is cancelled when no operation is executed for 5 seconds or more.

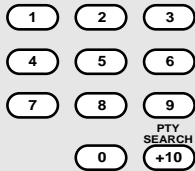

Remote control unit

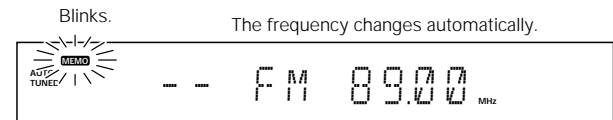

- With priority for FM, a maximum of 40 stations is preset automatically.
- When the intended station has not been preset, please also use "One-by-one presetting (manual preset)".

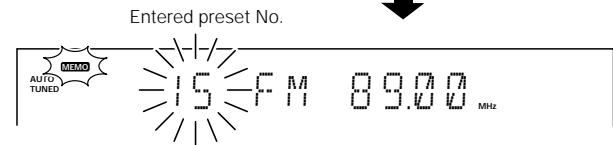
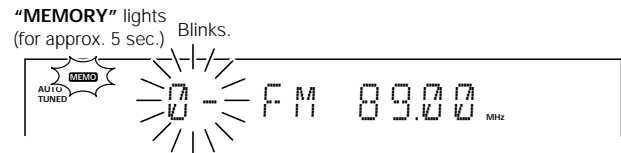

Press the numeric keys as shown below...

To enter 15 : [+10] [5]

To select 40 : [+10] [+10] [+10] [+10] [0]

- Repeat steps 1 2 to preset other stations.
- If several stations are preset under the same number, the previous memory is replaced with the latest memory contents.

Selected broadcast band.

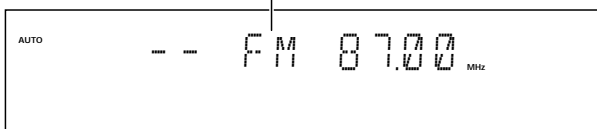

C-H6 display

The "TUNED" indicator lights when a station is received.

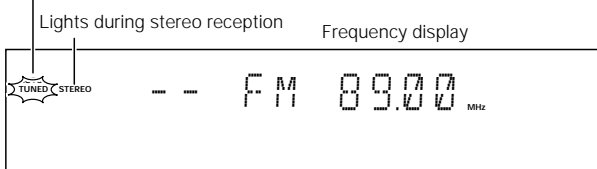

C-H5 display

The "TUNED" indicator lights when a station is received.

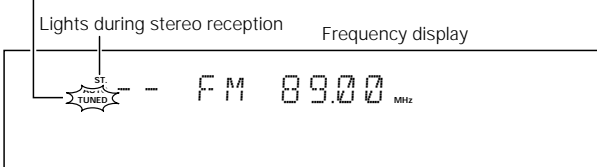

Select the tuning mode.



Each press alternates the mode.

- 1 "AUTO" lit (Auto tuning)
- 2 "AUTO" not lit (Manual tuning)

Use the manual tuning mode when reception is noisy due to weak reception. (In the manual mode, stereo broadcasts are received in monaural.)

- Normally, use the **AUTO** (Auto tuning) mode.

- When a key is held depressed, preset stations will be skipped at an interval of about 0.5 second.

Recording (Deck B only)



Note that this cassette deck cannot record onto Metal tapes.



When equalizer or another effect is applied to the sound, the sound with the applied effect can be recorded.

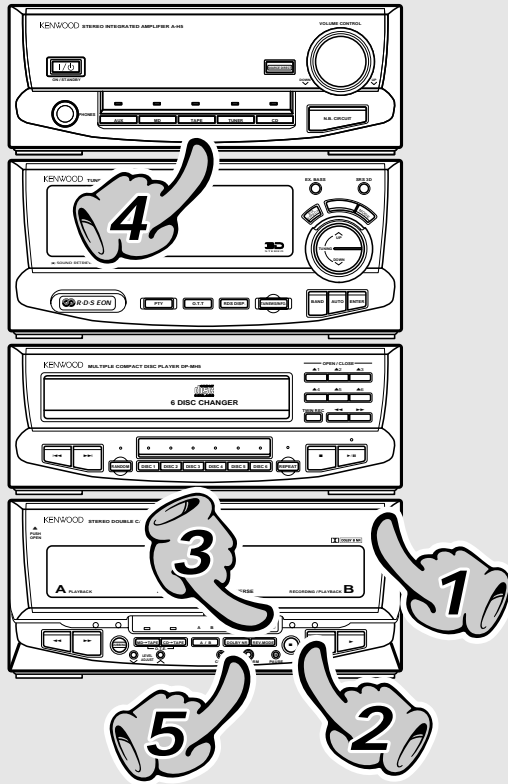
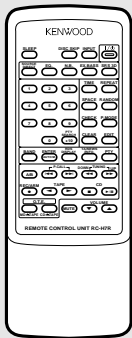
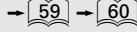

Basic section

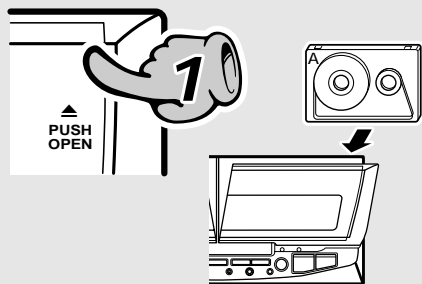

1. Load a tape in deck B.

- 1 Open the door of deck B.
- 2 Insert a tape.
- 3 Close the door.

- Differentiation between normal (TYPE I) and high (TYPE II) tape is set automatically.
- Remove tape slack before loading.

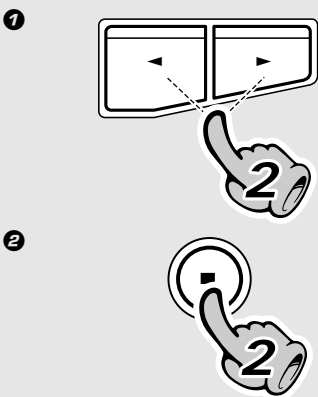

2. Select the tape transport direction.

To reverse the transport direction

- 1 Press the play (◀▶) key corresponding to the desired direction.
- 2 Stop playback.

The tape is transported in the direction indicated by the lighted key.

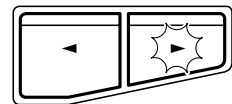

- When recording is started, the tape is transported in the direction selected in this step.
- Wind the tape to the position where recording is to be started.



3. Set the recording condition.

- 1 Select the reverse mode.
- 2 Select the Dolby NR mode.

To end recording

1



- Pressing the key pauses recording after leaving a non-recorded space of about 4 seconds.
- If the key is pressed again in less than 4 seconds after it has been pressed, recording resumes from that instant.
- Recording can also be stopped by pressing the stop (■) key. However, the non-recorded section is not left in this case.

2



To let recording pause temporarily (Pause)



- Press the REC/ARM key to resume recording.

Selection of DOLBY NR (Noise Reduction)

The Dolby NR system minimizes the hiss noise heard when playing tape.



Each press switches the modes as follows.

- ① "DOLBY NR indicator" ON
..... DOLBY NR is used.
- ② "DOLBY NR indicator" OFF
..... DOLBY NR is not used.

Selection of the reverse mode



Each press switches the modes as follows.

- ① "↔" ... Both sides are recorded, and then the tape stops (If direction ◀ is selected, only the back side of tape will be recorded.).
- ② "↔" .. Both sides are recorded (If direction ◀ is selected, only the back side of tape will be recorded.).
- ③ "↔" .. Only one side is played back (recorded), and then the tape stops.

4. Select the source to be recorded.

Select the input source to be recorded.



Select an input source other than "TAPE".

Lights up (when CD input is selected)

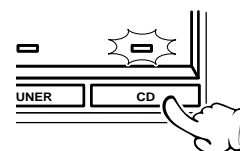

If you want to use one of "Convenient recording functions", make preparation until this stage. → 50

- When the CD input is selected and if a disc has been set in the CD player, its playback starts immediately. Press the stop (■) key to stop the playback.

Lights



5. Start recording.

- ① Start recording.
- ② Play (or tune) the input source to be recorded.

- Recording stops automatically when the tape side(s) to be recorded have been fully recorded.



When the recorded sound level is too low or too high causing distortion, it is possible to adjust the recording level manually.

Adjusting the recording level

- ① Perform the procedure of "Recording" until step ④.  32

- ② Adjust the recording level.

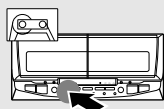

The adjustment range is between -2 ~ +2.

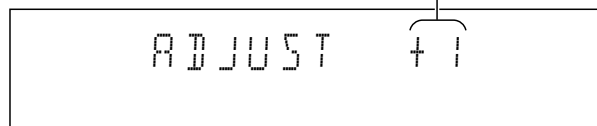

- ③ To restart recording

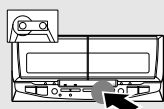

- If the recorded sound is too large or distorted, decrease the recording level. If it is too low, increase the recording level.



Restarting recording

The following procedure allows to re-record sound from the middle of recording.

The following procedure assumes the presence of a non-recorded section of 4 seconds before the recording start position.

- ① Press the key during recording.

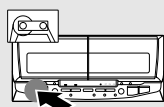

When the tape is moving ◀ way.

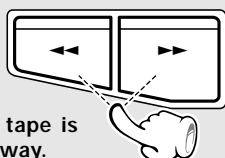

When the tape is moving ▶ way.

- ② Return the recording source component to the position you want to restart recording, and put the source component to pause mode.

- ③ Press the REC/ARM key twice.



- ④ Press the REC/ARM key once.

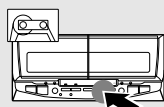

- ⑤ Play (Receive) the music to be recorded.

- Recording is stopped, the tape is returned to the recording start position, and the deck enters stop mode after leaving a non-recorded section of about 2 seconds after the previous music.
- If there is no music recorded before the recording start position, the deck enters stop mode after tape rewinding.

Blinks.



REC / ARM

In a few sec., REC/ARM and PAUSE keys light up.



REC / ARM



PAUSE

- The deck enters record-pause mode after leaving a non-recorded section of about 4 seconds.
- In case recording is restarted from the beginning of a tape, feed the leader tape (the non-recordable section at the beginning of each side of tape) manually before starting recording.

- When recording a CD, the CD playback and tape recording can be started simultaneously by pressing the CD play (▶/||) key in step ④.

Copying tape (Tape dubbing)

The contents of the tape in deck A can be copied onto the tape in deck B.

- 1** Select the "TAPE" input.

- 2** Load tapes in the decks.

3 Select "↔" (double-side recording) or "→" (one-side recording).

- 4** Use the same tape transport directions.

(1) Select the deck to change the transport direction.

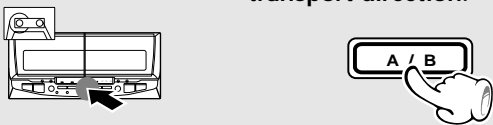

(2) Press the play key corresponding to the desired direction.



(3) Stop playback.

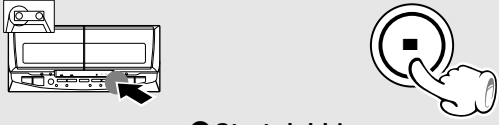

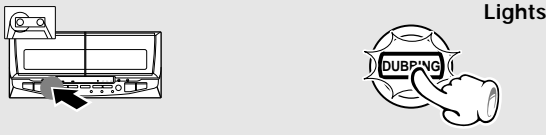
- 5** Start dubbing.

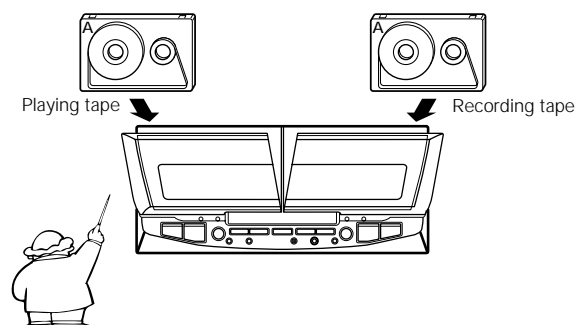

Press during stop.

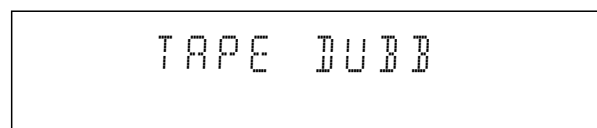

- When recording is started, the tape will be transported in the direction selected in this step.



- Dubbing ends automatically when the side(s) to be dubbed has been completed.

To stop dubbing



- The deck B will stop after creating a non-recorded portion of about 4 sec, and then the deck A will stop.
- Dubbing can also be stopped by pressing the stop (■) key. Note that the non-recorded space is not created in this case.



The **DOLBY NR** key is not active in dubbing mode. The tape recorded on deck B assumes the same Dolby NR condition as the tape played on deck A.

Listening in the desired sequence (program playback)

Any titles can be listened to in the desired sequence.
(Max. 32 titles)

Note For C-H6: Character information indicators cannot be displayed while the spectrum analyzer display is used. Switch to the dual display or character display mode to see the information. → 11 → 63

Select the "CD" input.

1 Check that the CD player is in the stop mode.



2 Light the "PGM" indicator.

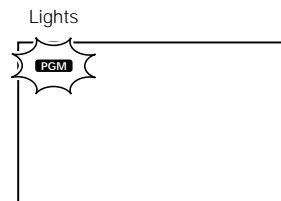
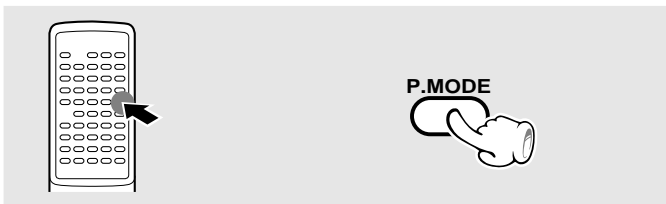

3 Enter track Nos. in the order you want to play them.

1 Select the track.

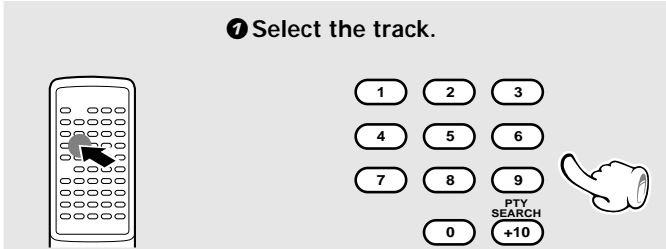

Go to step 2 within 8 seconds.

2 Establish the selection.

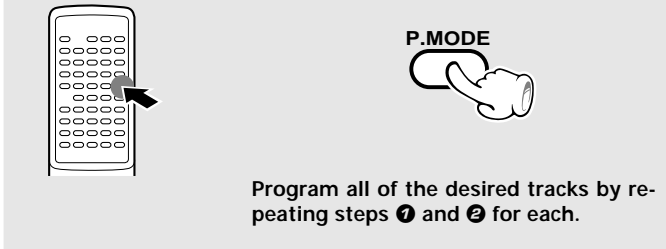

Program all of the desired tracks by repeating steps 1 and 2 for each.

Press the numeric keys as shown below....

To enter track No. 23 : [+10] [+10] [3]

To select track No. 40 : [+10] [+10] [+10] [+10] [0]



- Up to 32 tracks can be programmed. When "FULL" is displayed, no more tracks can be programmed.
- If you make a mistake, press the P.MODE key to quit the program mode and restart from step 2.

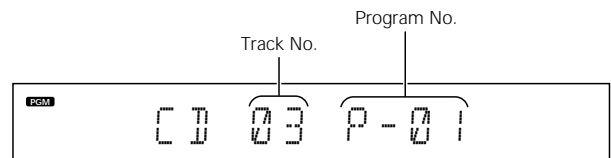

4 Start playback.

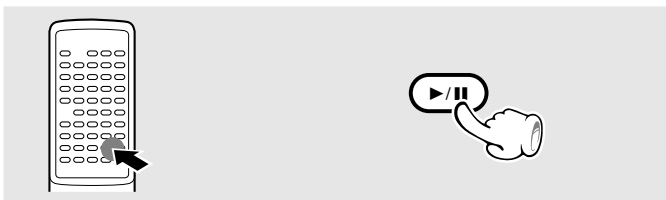

- Tracks will be played in the order they were programmed (in order of P Nos.).
- When the << or the >> key is pressed during play, the program will jump to the preceding or the following track respectively.
- When the << key is pressed once during playback, the play position returns to the beginning of the current track being played.

Auto space function (Remote control unit only)

When the SPACE key is pressed during programming of tracks, a non-recorded space of a few seconds will be created between tracks. By recording tracks with these spaces on tape, the search and repeat play operations of tape using the DPSS function (which works by searching the non-recorded spaces) can be performed reliably.

- Even when the performances of two tracks are continuous (which occurs with classical or live recording music), the spaces will be created if they have different track Nos.
- To cancel the auto space function, press the P.MODE key or the SPACE key again.

To stop playback

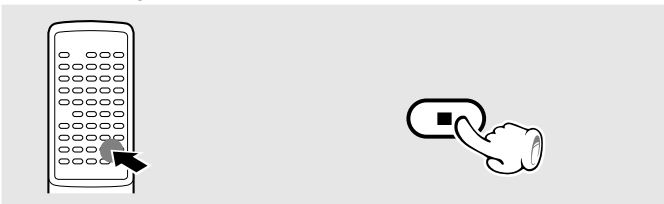

To check the programmed tracks Remote control unit only

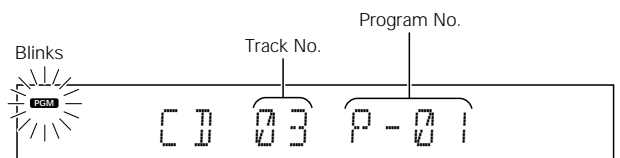

- Each time the key is pressed, the program No. (P-NO) and the disc No. are displayed.
- The previous display resumes in a few seconds.

To add a track to the program

1 Select the track.

Go to step 2 within 8 seconds.

2 Establish the selection.

- Add the desired tracks to the program by repeating steps 1 and 2 for each.
- The added track number is added to the end of the existing program.

To clear tracks from the program

Press to clear tracks from the end.

Remote control unit only

To clear all track.

- Each time the key is pressed, the last track in the program is cleared.
- The track being played cannot be cleared.

- The entire program contents also are erased when the disc tray is opened.

Repeated playback

Desired titles or discs can be played back repeatedly.

Select the "CD" input.

To repeat a disc

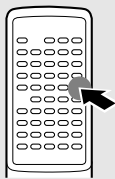

- 1 Confirm that the "PGM" indicator is not lit.
If the "PGM" indicator is lit, press the P.MODE key to turn it off.

P.MODE



Confirm that this is not lit.

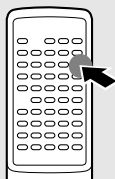

- 2 Press the REPEAT key.

REPEAT



Each press switches the repeat mode.

- 1 Repeat playback (Lit)
- 2 Repeat cancelled (Not lit)

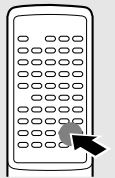

- 3 Start playback.



Lights
REPEAT

DP-H5

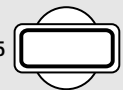

To stop repeated playback

Press the REPEAT key again.

- The REPEAT indicator turns off and the playback according to the current CD player mode starts.
- Repeat playback is also cancelled when the disc tray is opened.

To repeat only the programmed tracks

- 1 Perform the procedure in "Listening in the desired sequence (program playback)" till step 3 to program the desired CD tracks. → 36

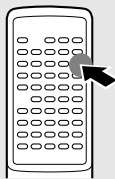

- 2 Press the REPEAT key.

REPEAT



Each press switches the repeat mode.

- 1 Repeat playback (Lit)
- 2 Repeat cancelled (Not lit)

Lights
REPEAT

DP-H5

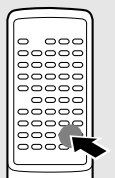
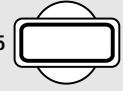

- 3 Start playback.



To stop repeated playback

Press the REPEAT key again.

- The REPEAT indicator turns off and the playback according to the current CD player mode starts.
- Repeat playback is also cancelled when the disc tray is opened.

Listening to an unexpected title sequence (random playback)

As the titles each time are selected randomly, the music can be enjoyed without getting tired of it.

Note For C-H6: Character information indicators cannot be displayed while the spectrum analyzer display is used. Switch to the dual display or character display mode to see the information. → 11 → 63

Select the "CD" input.

1 Confirm that the "PGM" indicator is not lit.

If the "PGM" indicator is lit, press the P.MODE key to turn it off.

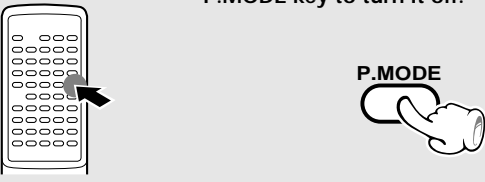
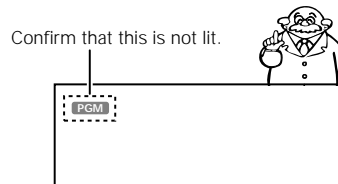



2 Select the RANDOM mode.

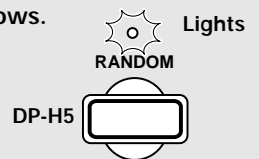

Each press switches the modes as follows.

- ① Random playback (Lights.)
- ② Random playback cancellation. (Goes off.)



- After every track, the music calendar blinks and the next selected track is played.
- Playback stops after each title has been played once.
- The random playback can also be repeated by pressing the REPEAT key.



To select another track in the middle of playing one

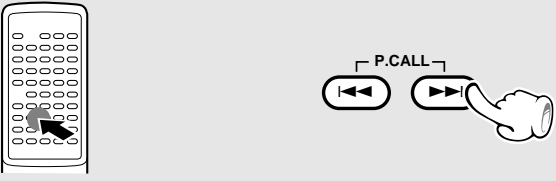

- Pressing the P.CALL key once returns to the beginning of the track being played.

To cancel random playback

Press so that the RANDOM indicator goes off.

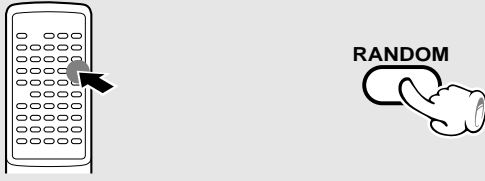

- The RANDOM indicator goes off and the playback in order of the tracks starts from the track being played.
- Random playback is also cancelled when the disc tray is opened.

Listening in the desired sequence (program playback)

Any titles can be listened to in the desired sequence.
(Max. 32 titles)

Note For C-H6: Character information indicators cannot be displayed while the spectrum analyzer display is used. Switch to the dual display or character display mode to see the information. → 11 → 63

Select the "CD" input.

1 Check that the CD player is in the stop mode.



2 Light the "PGM" indicator.

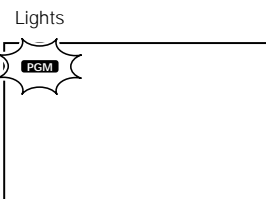
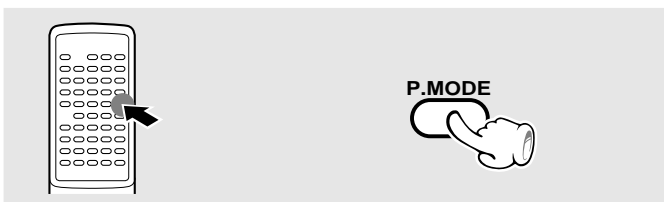

3 Enter track Nos. in the order you want to play them.

1 Select the disc. Go to step 2 within 8 seconds.

2 Select the track.

Go to step 3 within 8 seconds.

3 Press the P.MODE key.
To select tracks from more than one CD, repeat steps 1, 2 and 3.

DISC SKIP

1 2 3
4 5 6
7 8 9
0 +10

PTY SEARCH

- The disc can also be selected with the Disc selector (**DISC 1-DISC 6**) key.
- Up to 32 tracks can be programmed. When "FULL" is displayed, no more tracks can be programmed.
- To program all tracks of a CD, select the disc and then press the **P.MODE** key without selecting any tracks.
- If you make a mistake, press the **P.MODE** key to quit the program mode and restart from step 2.

Press the numeric keys as shown below....

To enter track No. 23 : [+10] [+10] [3]

To select track No. 40 : [+10] [+10] [+10] [+10] [0]

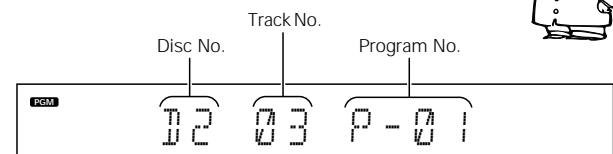

4 Start playback.

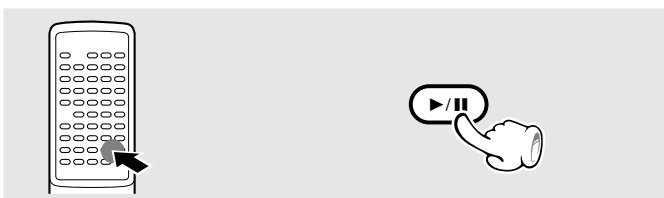

- Tracks will be played in the order they were programmed (in order of P Nos.).
- When the ◀◀ or the ▶▶ key is pressed during play, the program will jump to the preceding or the following track respectively.
- When the ◀◀ key is pressed once during playback, the play position returns to the beginning of the current track being played.

Auto space function (Remote control unit only)

When the SPACE key is pressed during programming of tracks, a non-recorded space of a few seconds will be created between tracks. By recording tracks with these spaces on tape, the search and repeat play operations of tape using the DPSS function (which works by searching the non-recorded spaces) can be performed reliably.

- Even when the performances of two tracks are continuous (which occurs with classical or live recording music), the spaces will be created if they have different track Nos.
- To cancel the auto space function, press the **P.MODE** key or the **SPACE** key again.

To stop playback

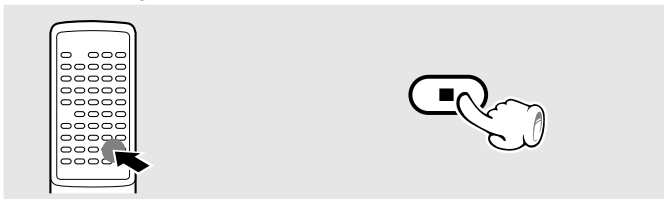

To check the programmed tracks Remote control unit only

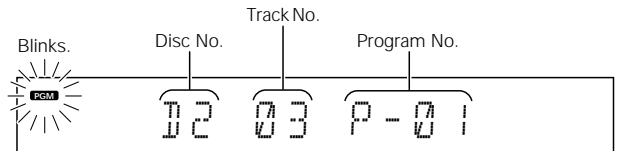

- Each time the key is pressed, the program No. (P-NO) and the disc No. are displayed.
- The previous display resumes in a few seconds.

To add a track to the program

1 Select the disc. Go to step 2 within 8 seconds.

DISC SKIP

2 Select the track.

1	2	3
4	5	6
7	8	9
0	PTY SEARCH +10	

Go to step 3 within 8 seconds.

3 Establish the selection.

P.MODE

- To select tracks from more than one CD, repeat steps 1 to 3 for each track.
- The added track number is added to the end of the existing program.

To clear tracks from the program

Press to clear tracks from the end.

CLEAR Remote control unit only

- Each time the key is pressed, the last track in the program is cleared.
- The track being played cannot be cleared.

To clear all track.

P.MODE

- The entire program contents also are erased when the disc tray is opened.

Repeated playback

Desired titles or discs can be played back repeatedly.

Select the "CD" input.

To repeat all discs

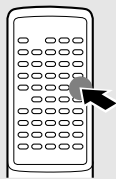

- 1 Confirm that the "PGM" indicator is not lit.
If the "PGM" indicator is lit, press the P.MODE key to turn it off.



Confirm that this is not lit.

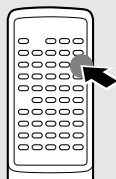

- 2 Press the REPEAT key.



Each press switches the repeat mode.

- 1 Repeat playback (Lit)
- 2 Repeat cancelled (Not lit)

Lights

DP-MH5

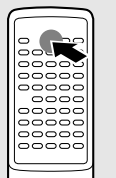

- 3 Select the disc to be played first



To stop repeated playback

Press the REPEAT key again.

- The REPEAT indicator turns off and the playback according to the current CD player mode starts.
- Repeat playback is also cancelled when the disc tray is opened.

To repeat only the programmed tracks

- 1 Perform the procedure in "Listening in the desired sequence (program playback)" till step 3 to program the desired CD tracks. → 40

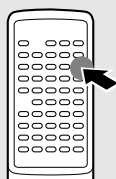

- 2 Press the REPEAT key.



Each press switches the repeat mode.

- 1 Repeat playback (Lit)
- 2 Repeat cancelled (Not lit)

Lights

DP-MH5

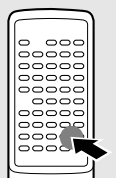

- 3 Start playback.



To stop repeated playback

Press the REPEAT key again.

- The REPEAT indicator turns off and the playback according to the current CD player mode starts.
- Repeat playback is also cancelled when the disc tray is opened.

Listening to an unexpected title sequence (random playback)

As the titles each time are selected randomly, the music can be enjoyed without getting tired of it.

Select the "CD" input.

1 Confirm that the "PGM" indicator is not lit.

If the "PGM" indicator is lit, press the P.MODE key to turn it off.





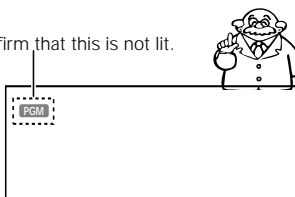

P.MODE

Confirm that this is not lit.

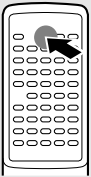

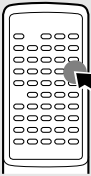
2 Select the RANDOM mode.

 <p>Random playback of one CD</p> <p>① Select the disc.</p> <p>DISC SKIP</p> 	 <p>Random playback of all discs</p> <p>② Press repeatedly until the DISC indicator lights.</p> <p>RANDOM</p> 
---	--

Press repeatedly until the ALL indicator lights.



Each press switches the modes as follows.



Lights

- ① RANDOM indicator lit/DISC indicator lit: Random playback of one CD
- ② RANDOM indicator lit/ALL indicator lit: Random playback of all CDs
- ③ Indicators off: Random playback cancelled

- After every track, the music calendar blinks and the next selected track is played.
- Playback stops after each title has been played once.
- The random playback can also be repeated by pressing the REPEAT key.

To select another track in the middle of playing one

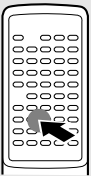

P.CALL

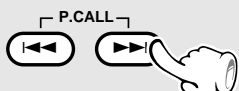

- Pressing the P.CALL key once returns to the beginning of the track being played.

To cancel random playback

Press so that the RANDOM indicator goes off.

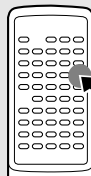

RANDOM



- The RANDOM indicator goes off and the playback in order of the tracks starts from the track being played.
- Random playback is also cancelled when the disc tray is opened.

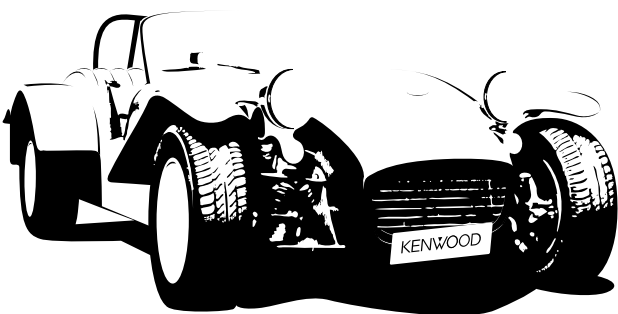

RDS is a system which transmits useful information (digital data) for FM broadcasts together with the broadcast signal. Tuners and receivers designed for RDS reception can extract the information from the broadcast signal for use with various functions such as automatic display of the station name.

This unit is equipped with the following functions utilizing RDS data:

PTY (Program Type Identification) Search :  46
The tuner automatically searches for a station which is currently broadcasting a specified program type (genre).

PS (Program Service Name) Display : (See below.)
When an RDS broadcast is received, the station name is automatically displayed.

EON (Enhanced Other Network) :  48
When the information to be received is set in advance and any RDS station in the same network starts broadcasting of such information, the reception automatically will be switched to that station.

The "RDS" indicator lights up when an RDS broadcast (signal) is received.

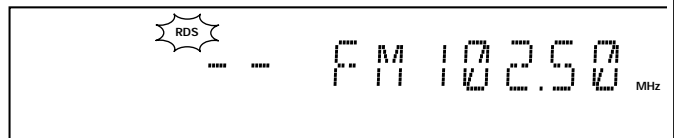

- Some functions may not be provided or be given different names depending on countries or areas.

Note before the use of RDS

To receive RDS stations, you have to preset RDS stations using the auto preset function. The auto preset function presets the RDS stations in priority. Flashing "NO DATA" will be displayed when no RDS station has been preset with this function.

Set the receiving band to FM and preset RDS stations with the auto preset function.  31

To switch the display contents

Pressing the RDS DISPLAY key changes the display contents.

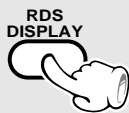
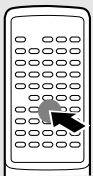

Display mode priority ranking

When an RDS broadcast is received :

- ① **PS (Program Service Name) Display :**
When an RDS broadcast is received, the station name is automatically displayed.
If no PS data was sent, "NO PS" is displayed.

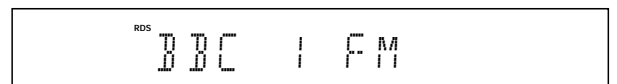

- ② **Frequency Display :**
The frequency of the current station is displayed.

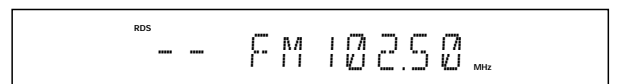

Searching for a desired program type (PTY search)

By specifying the type of program (genre) you want to listen to, the tuner automatically searches for a station which is currently broadcasting a program of the specified type.

Set the reception band to FM. Preset RDS stations with the auto preset function.



1 Select the PTY search mode.

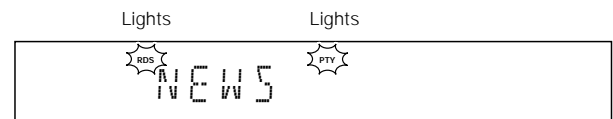
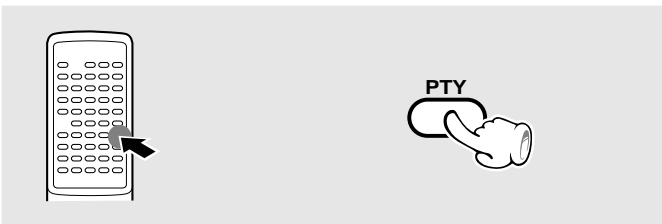

When an RDS broadcast is received, the program type is shown on the display. If no PTY data is available, or if the station is not an RDS station, "NONE" is displayed.

2 Select the desired program type.

Use program type table on the right for your convenience.

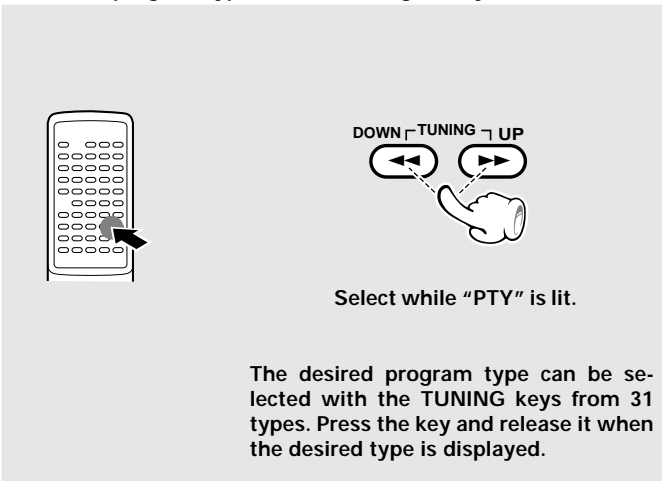

Program type table

TUNING keys	Program Type Name	Display
	Pop Music	POP M
	Rock Music	ROCK M
	* M.O.R. Music	M.O.R. M
	Light Classical	LIGHT M
	Serious Classical	CLASSICS
	Other Music	OTHER M
	News	NEWS
	Current Affairs	AFFAIRS
	Information	INFO
	Sport	SPORT
	Education	EDUCATE
	Drama	DRAMA
	Culture	CULTURE
	Science	SCIENCE
	Varied	VARIED
	Weather	WEATHER
	Finance	FINANCE
	Children's programmes	CHILDREN
	Social affairs	SOCIAL A
	Religion	RELIGION
	Phone in	PHONE IN
	Travel	TRAVEL
	Leisure	LEISURE
	Jazz music	JAZZ
	Country music	COUNTRY
	National music	NATION M
	Oldies music	OLDIES
	Folk music	FOLK M
	Documentary	DOCUMENT
	Alarm test	TEST
	Alarm	ALARM

*M.O.R. Music (Middle of the Road Music)

3 Start the search.

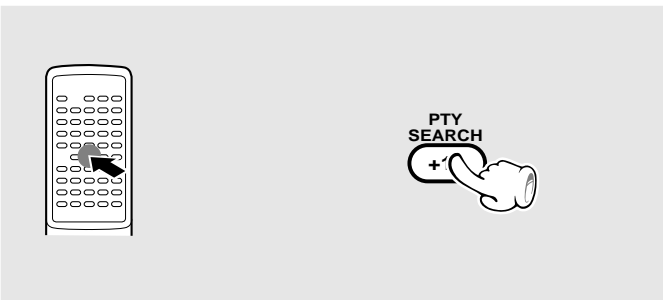

When searching for a Rock Music broadcast Display while the tuner is searching.

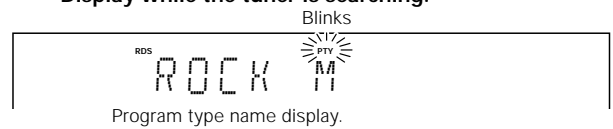

When a station is received.

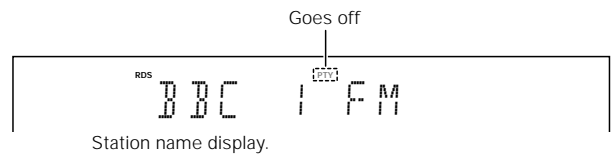

To change to a different program type :

Repeat steps 1, 2, 3.

- No sound is heard while "PTY" is blinking.
- If a program of the desired type cannot be found, "NO PROG" is displayed, then after several seconds the display returns to the original display.
- If a program of the desired type is found, that program is received and the program type name display changes temporarily to the frequency display, and then to the station name display.

To be able to listen to the desired information at any time

By using the EON function, which manages the information of other stations, listening to desired information like traffic information or news etc. can be reserved even when it is not being transmitted at the present. When listening to a station with the "EON" display lit and another station of the same network starts to broadcast an information program for which a reservation has been made, then that station will be selected automatically. When the desired information program ends, return is made to the original program.

Set the reception band to FM.

1 Auto preset the stations.



- 1 Receive a broadcast.
- 2 Keep the ENTER key pressed (2 sec or longer).

ENTER
AUTO M.

The EON data presently being broadcast are taken in automatically.



This is not required when auto presetting has already been executed.

- When all 40 stations have already been preset by the procedure for "One-by-one presetting", the EON function will not operate. Auto presetting must be used.

2 Select the desired information.

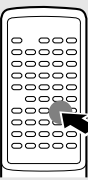

TA/NEWS
/INFO.

Each press switches the modes as follows.

- 1 TA Traffic Announcement
- 2 NEWS News
- 3 INFO Information
- 4 Display not lit EON cancelled

C-H6 display

Lights when "INFO." is selected

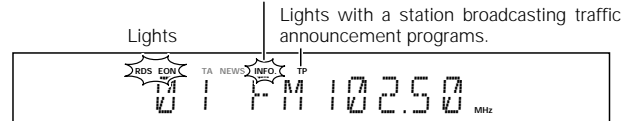

C-H5 display

Lights with a station broadcasting traffic announcement programs.

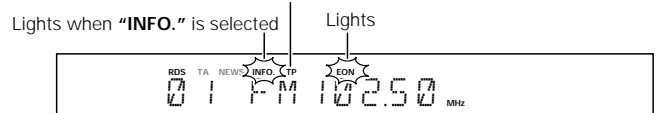

- Please execute automatic presetting when TA, NEWS, and INFO can not be selected.

3 Receive an RDS station.

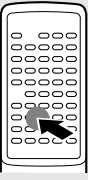

Select a station where "RDS" and "EON" are lit.

P.CALL

C-H6 display

"RDS" and "EON" are lit

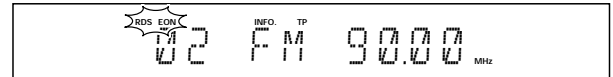

C-H5 display

Lights

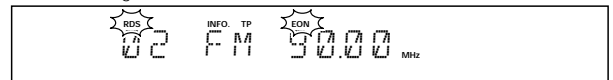

- When "EON" does not light although an RDS station is received, that station is not transmitting EON data. Please select a different station.
- If you want TA programs, select the stations with which the "TP" indicator lights.

4 Wait for the desired information.

CD or tape playback may also be started.
As long as the unit is ON, the unit is always ready for the reception.

- When one of the stations of the network of the station received in **3** starts broadcasting the program contents selected in **2**, that station will be received automatically. At this time, tape playback will stop and CD playback will pause. However, external equipment (AUX or MD) will remain as it is.
- When the power is OFF and during recording (including dubbing), the EON function does not operate.
- When the transmission of the selected program contents ends in case of automatic reception with the EON function, return will be made to the status directly before operation of the EON function. When tape or CD playback has been interrupted, it will be continued from the point of interruption.

Waiting for information while a RDS station without EON function is tuned

If the EON indicator does not light with the RDS station in steps **3** and **4**, the tuner will wait for only the desired information broadcast from the tuned RDS station provided that the desired information has been selected in the previous step.

TP (Traffic Program) indicator

The lighting of the TP indicator indicates that the currently tuned station or a station in the same network as it broadcasts traffic announcement programs. If the TP indicator already lights with the current station, you can listen to the traffic announcement program through the station without making reservation with the EON function.

Selection of the convenient CD recording type

With this unit, the following edit recording is possible according to the purpose.



Note that this cassette deck cannot record onto Metal tapes.

If you want to record a CD in order of track numbers



A. ONE TOUCH EDIT.....recording of all titles

→ 52

Press the O.T.E. key when in the stop mode. The disc will start to be recorded.

If you want to select the tracks to be recorded while playing a CD



B. ONE TOUCH EDIT.....single title recording

→ 53

Play a CD and, if a track you want to record starts, press the O.T.E. key. The track will be recorded from the beginning.

To record tracks in your desired order



C. Program edit recording

→ 54

This allows to select and record only the desired tracks in the desired order.

If you want to avoid any tune being interrupted at the end of tape



D. Time edit recording

→ 55

Edit recording of CD is possible by the simple operation of entering the recording length of the tape.

To fade out the track interrupted at the end of tape side by decreasing its volume gradually



E. Fade edit recording

→ 57

This allows to fade out a track which should be interrupted at the end of tape side and restart recording on the back side of tape by fading in the same track from the middle of it.

CCRS (Computer Controlled Recording System)

The CCRS is a function allowing CD recording on a cassette with a simple, one-touch operation.

Press the CCRS key. The contents of the CD and the type of tape used are identified in about 60 seconds (this is variable depending on the CD contents), the recording level is set automatically and recording is started. After completion, the recording stops automatically.

→ 54 → 55 → 57

The setup made by the CCRS is cancelled when the power is turned OFF or the CD is stopped.

Another convenient function (Only for the systems including the DP-MH5)

Twin recording : Function which records a single CD onto a MD and cassette tape simultaneously.

→ 58

Fade-in/fade-out

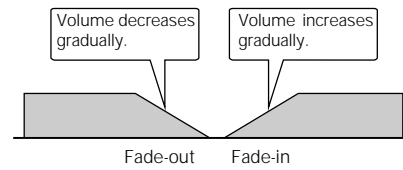

Fade-out :Ending a tune by gradually decreasing the volume.

Fade-in :Starting a tune by gradually increasing the volume.



A One-touch recording of one CD

(One-touch edit all-track recording)

→ 52

Records all tracks on a CD with a very simple operation.

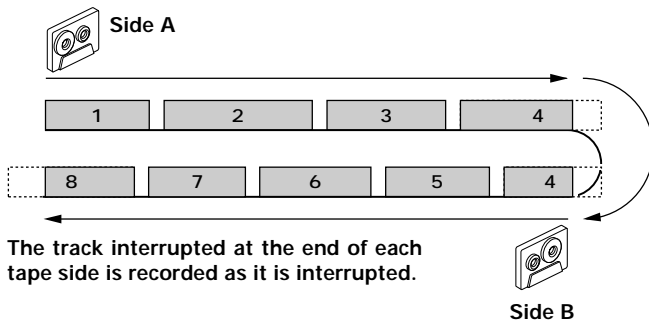

The track interrupted at the end of each tape side is recorded as it is interrupted.

B Recording of desired tracks while listening to a CD

(One-touch edit single-track recording)

→ 53

While playing a CD, pressing a single button allows to record the current track being played from the beginning to the end.

This function is convenient when you want to record desired tracks while playing a CD you have not played before.

For the systems including the DP-MH5

C Recording tracks from one or several CDs

(Program edit recording)

→ 54

From one CD CD tracks are recorded in the order they are programmed.

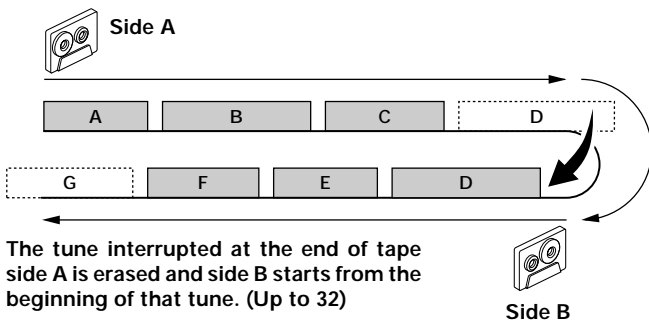

The tune interrupted at the end of tape side A is erased and side B starts from the beginning of that tune. (Up to 32)

From more than one CD CD tracks of several CDs are recorded in the order they are programmed.

For the systems including the DP-MH5 only

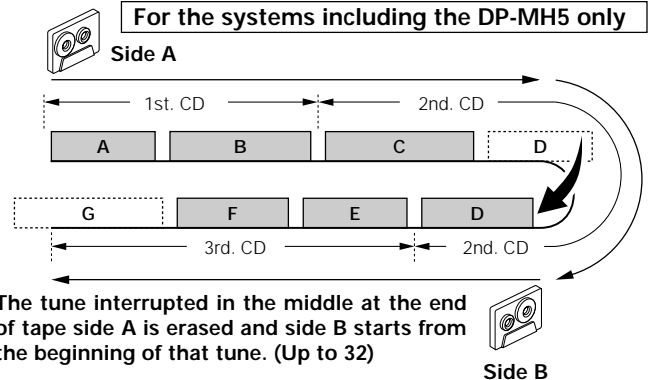

The tune interrupted in the middle at the end of tape side A is erased and side B starts from the beginning of that tune. (Up to 32)

D Reordering tracks according to the tape length

(Time edit recording)

→ 55

Side A The order of CD tracks are changed automatically so that no tune is interrupted at the end of tape sides A and B. (Up to 32)

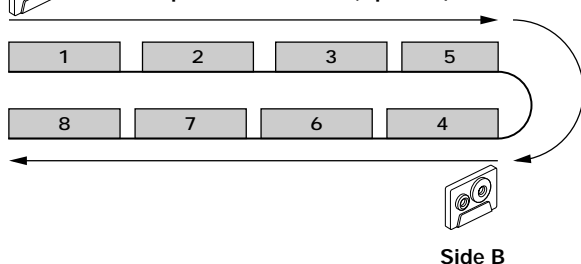

E Recording by fading in and fading out the tracks at the ends of tape sides

(Fade edit recording)

→ 57

Side A CD tracks are recorded in the order they are recorded. The tune interrupted at the end of tape side A is faded out and side B starts with fading in from the middle of that tune. (Up to 32)

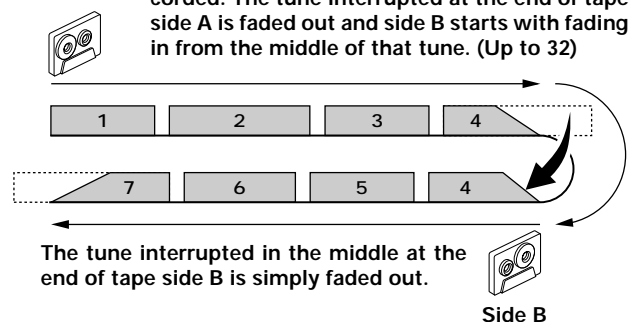

The tune interrupted in the middle at the end of tape side B is simply faded out.

One-touch recording of an entire CD (ONE TOUCH EDIT....recording of all titles)

When the O.T.E. key is pressed while the CD player is in the stop mode, recording of a CD can be started at the same time as playback.

When recording sound from the MD recorder to a cassette deck, be sure to read the instruction manual of the optional MD recorder (DM-F70).



When equalizer or another effect is applied to the sound, the sound with the applied effect can be recorded. → 60



If you record a CD using the SRS 3D system, it is recommended to use the CCRS.

1 Preparation → 32

- 1 Load a cassette tape in deck B.
- 2 Select the tape transport direction (◀ or ▶).
- 3 Select "↔", "→" (two-side recording).
- 4 Select the Dolby NR mode.
- 5 Select the "CD" input.
- 6 Insert disc(s) in the CD player.

If your system includes the DP-H5, skip to step 3 below.

2 Select the disc. (DP-MH5 only)

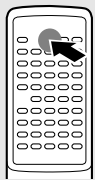

Go to step 3 before playback starts.

Selected disc (DISC 1)

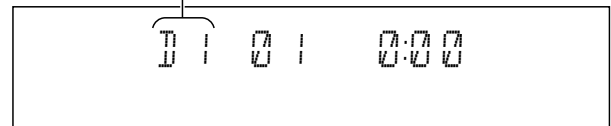

3 Press the O.T.E. key.

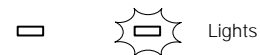
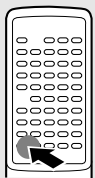

X-H5



- Recording of CD starts at the same time as playback.
- At the end of tape, the music is not recorded on the leader tape portion. If you do not want any music to be interrupted in the middle, refer to "Recording" and start recording of side B with the interrupted track.

→ 32

To end recording in the middle

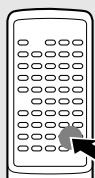

- Both the cassette deck and CD player stop.

Recording only desired titles (ONE TOUCH EDIT.....single title recording)

At the time of CD playback, any desired title can be selected immediately for recording.
When recording sound from the MD recorder to a cassette deck, be sure to read the instruction manual of the optional MD recorder (DM-F70).



When equalizer or another effect is applied to the sound, the sound with the applied effect can be recorded. → 60



If you record a CD using the SRS 3D system, it is recommended to use the CCRS.

1 Preparation

→ 32

- 1 Load a cassette tape in deck B.
- 2 Select the tape transport direction (◀ or ▶).
- 3 Select "↔", "→" (two-side recording).
- 4 Select the Dolby NR mode.
- 5 Select the "CD" input.
- 6 Insert disc(s) in the CD player.

2 Play a CD.

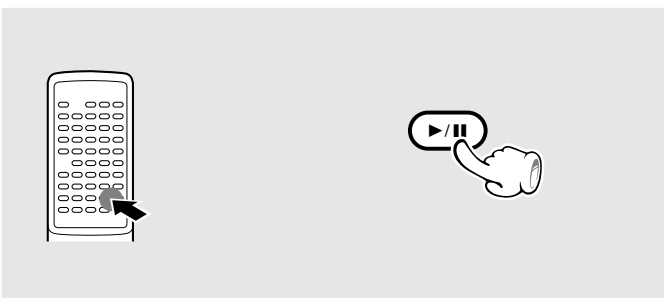

3 When you want to record a track being played, press the O.T.E. key.

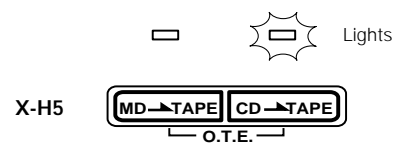
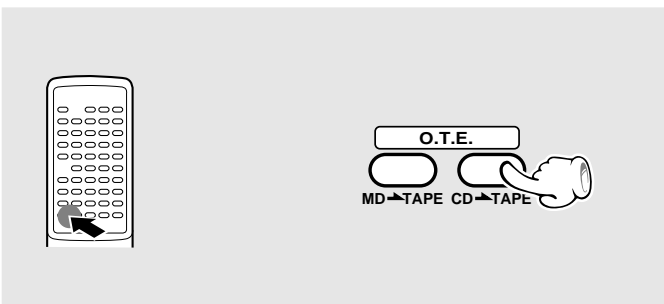

- Playback restarts from the beginning of the track being played and recording starts at the same time.

When recording has been completed, a non-recorded portion of 4 seconds will be produced and the cassette deck part will stop. The CD player will enter temporary stop condition.

To record a different track, repeat the steps 2 and 3.

To end recording in the middle

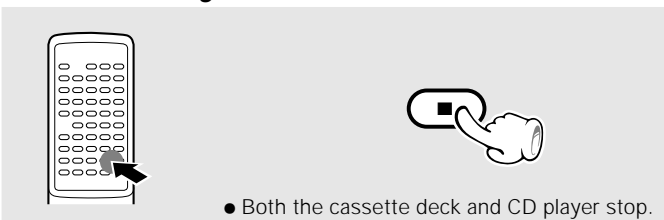

Recording favorite tracks from CD onto a single tape

(Program edit recording)

Use the following procedure to record CD tracks in the order programmed by yourself so that no tune is interrupted in the middle at the ends of tape sides.

The tune interrupted at the end of tape side A is erased and side B starts from the beginning of that tune.



When equalizer, SRS 3D or another effect is applied to the sound, the sound with the applied effect can be recorded.

→ 59 → 60



For C-H6: Character information indicators cannot be displayed while the spectrum analyzer display is used. Switch to the dual display or character display mode to see the information.

→ 11 → 63

Recording preparations are required. → 32 For the reverse mode, select "↔", "⇄" (two-way recording).

1 Press so that the "PGM" indicator lights.

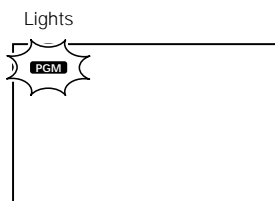
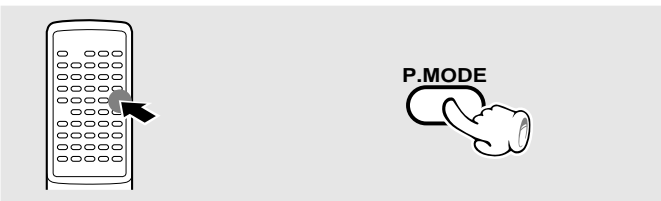

2 Enter disc Nos. and track Nos. in the order you want to record them. (Editing)

1 Enter the disc No. (DP-MH5 only)

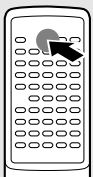

DISC SKIP



Go to step 2 within 8 seconds.

2 Enter the track No.

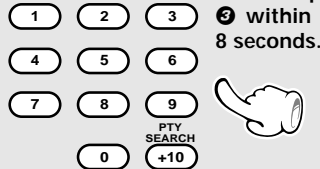
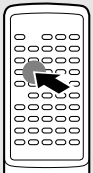

Go to step 3 within 8 seconds.

3 Press the P.MODE key to enter the selection in memory.

For the systems including the DP-H5:
Program other tracks by repeating steps 2 and 3 for each.

For the systems including the DP-MH5:
If you program tracks from more than one CD, repeat steps 1 to 3 for each.

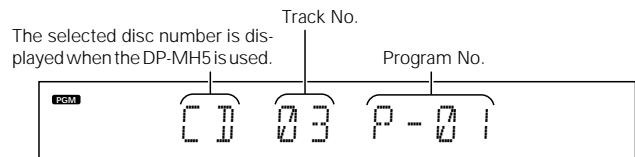

Press the numeric keys as shown below....

To enter track No. 23 : [+10] [+10] [3]

To select track No. 40 : [+10] [+10] [+10] [+10] [0]



- Select CD tracks so that their total playing time does not exceed the recording time of the tape.
- Up to 32 tracks can be programmed. When "FULL" is displayed, no more tracks can be programmed.
- If you make a mistake, press the CLEAR key and enter the track No. from the beginning.
- When the P.MODE key is pressed without selecting a title after selection of a disc, all titles of the disc are programmed, so that the CCRS function does not operate. Please begin again from step 1.
- The REPEAT key is invalid.

To check the edited contents → 56
To clear the edited contents → 56

3 Start edit recording.

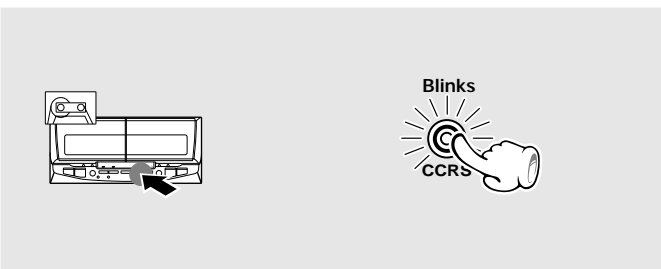

During recording: X-H5

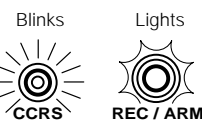

- The recording level and bias will be adjusted automatically in approx. 60 seconds (variable depending on CD contents), after which recording starts.
- For the systems including DP-MH5: In editing from more than one CD, the CCRS setting operation is performed after every disc change. In this case, the deck stops automatically and restart recording after having completed the CCRS operation.



1. When the CCRS key is pressed during playback of CD, the playback stops and the CCRS setting (preparation for edited recording) starts.
2. Edit recording is not possible with CDs containing a track that is longer than one tape side, which may occur with classical music, etc.
3. If the deck is set for one-side recording (↔), the processing at the tape end is applied only on side A.

Giving preference to the tape length over the title sequence (Time edit recording)

When the tape recording time is specified, recording is executed with changing the title sequence so that no title will be interrupted when the tape direction is changed at the end of one side.



When equalizer, SRS 3D or another effect is applied to the sound, the sound with the applied effect can be recorded. → 59 → 60



For C-H6: Character information indicators cannot be displayed while the spectrum analyzer display is used. Switch to the dual display or character display mode to see the information. → 11 → 63

Recording preparations are required. → 32 For the reverse mode, select "↔", "↔" (two-way recording).

1 Press so that the "PGM" indicator goes off.

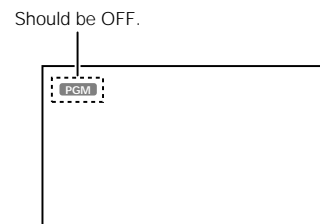
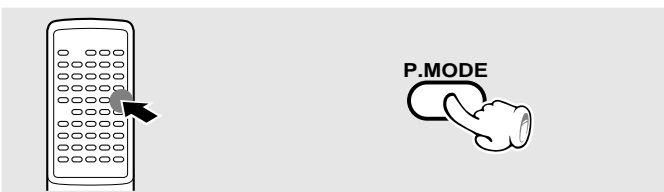

2 Light the "EDIT" indicator.

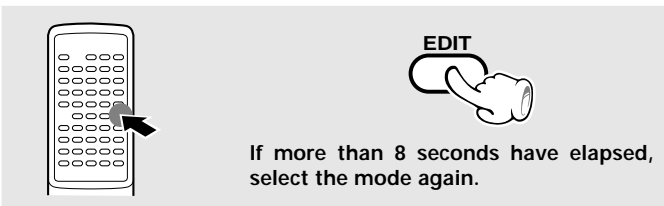

•When pressing the **EDIT** key, "SPACE" indicator also lights up with "EDIT" indicator. To cancel the auto-space function, press the **SPACE** key. → 37 → 41

3 Enter the disc and tape conditions.

1 Enter the disc No. (DP-MH5 only)
DISC SKIP

Go to step 2 within 8 seconds.

2 Press the EDIT key. (DP-MH5 only)
Go to step 3 within 8 seconds.

3 Enter the recording length of the tape.

1 2 3
4 5 6
7 8 9
0 +10

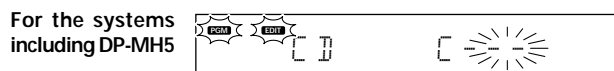

- The recording time is 99 minutes maximum.
- Up to 32 tracks can be edited.
- CD tracks will be edited automatically onto tape sides A and B. After editing, the "EDIT" indicator stops blinking and starts to light steadily.

Press the numeric keys as shown below.

30-minute tape : +10 +10 +10 0

46-minute tape : +10 +10 +10 +10 6

46-, 54-, 60- or 90-minute tapes can be selected simply by pressing the TIME key for the required number of times. (The recording time can be adjusted in 1-minute steps with the ◀◀ and ▶▶ keys.) After entry, press the EDIT key then proceed to step 4.

4 Start edit recording.

Wait until the "EDIT" indicator stops blinking, and then press the CCRS key.

Blinks

During recording: X-H5

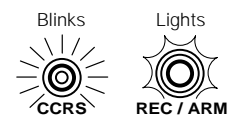

- The tape and CD stop automatically when recording has completed.



Depending on the combination of conditions from CD contents (number of titles and length of the titles) and tape recording time, interruption of a title may not be avoidable. In such a case, the respective title will not be recorded.

Note For C-H6: Character information indicators cannot be displayed while the spectrum analyzer display is used. Switch to the dual display or character display mode to see the information. → 11 → 63

**To check the edited contents
(Program edit recording, Time edit recording)**

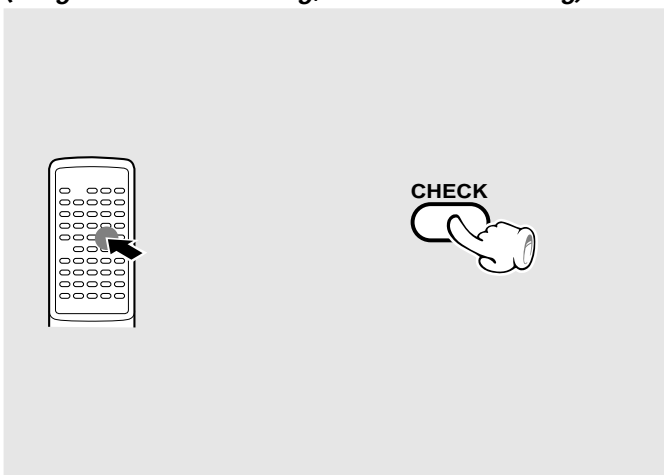

Example of checking the edited contents for program edit recording

For the systems including the DP-H5

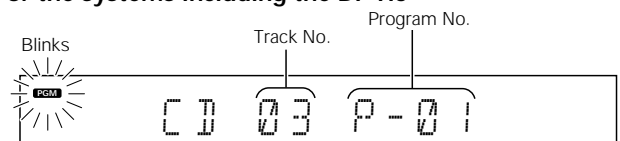

For the systems including the DP-MH5

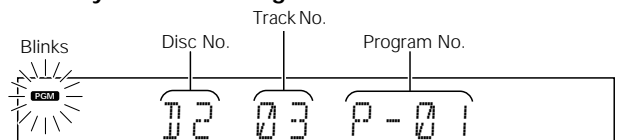

- **Program edit recording** : Each time the key is pressed, the program No. (P-NO) and the disc No. are displayed.
- **Time edit recording** : Edit indicator blinks, and edited contents are shown in order with the music calendar indicators.

**To clear the edited contents
(Program edit recording, Time edit recording)**

Method: 1

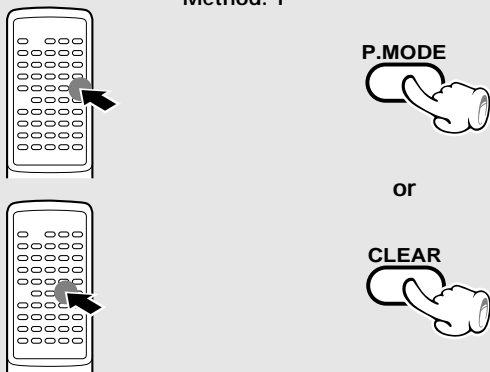

Method: 2

For the systems including DP-H5

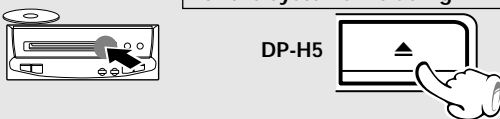

For the systems including DP-MH5

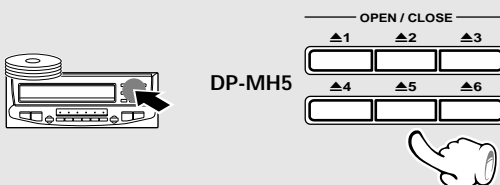

- When the **P.MODE** key is pressed at the time of program recording, all editing contents are erased. When the **CLEAR** key is pressed, the tracks are deleted one by one from the end of the program.
- When the **P.MODE** key or the **CLEAR** key is pressed at the time of time editing, the entire editing contents are deleted.

- Even when a disc tray not related to the program contents is opened during program recording, the entire editing contents are deleted.
- At the time of time editing, the entire editing contents are deleted only when the edited disk is removed.

Fading in/out sound at tape reversal positions (Fade edit recording)

The tune interrupted at the end of tape side A is faded out and side B starts with fading in from the middle of that tune. The tune interrupted at the end of tape side B is simply faded out.



When equalizer, SRS 3D or another effect is applied to the sound, the sound with the applied effect can be recorded.

→ 59 → 60

Recording preparations are required. → 32 For the reverse mode, select "↔", "⇄" (two-way recording).

1 Press so that the "PGM" indicator goes off.

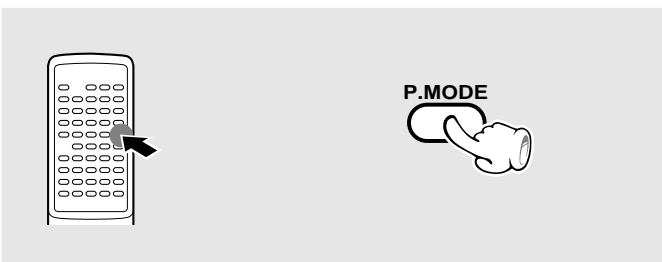

Should be OFF.

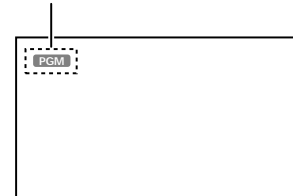

If your system includes the DP-H5, skip to step 2 below.

2 Select the disc. (DP-MH5 only)



Selected disc No.

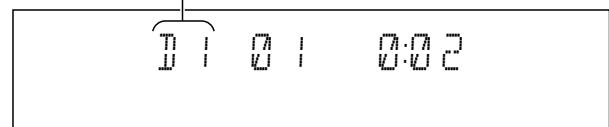

3 Start edit recording.

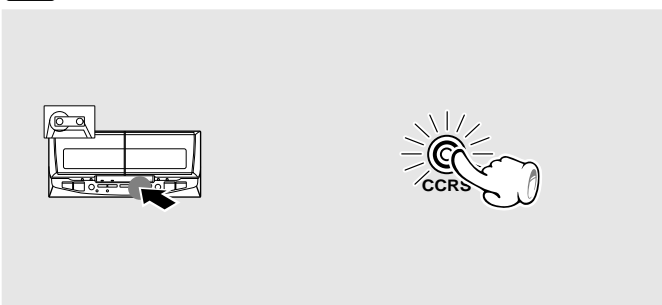

During recording: X-H5

Blinks

Lights



- The recording level and bias will be adjusted automatically in approx. 60 seconds (variable depending on CD contents), after which recording starts.
- The CD tracks are recorded in the order they are recorded on the CD.
- The tape and CD stop automatically when recording has completed.



1. When the **CCRS** key is pressed during playback of CD, the playback stops and the CCRS setting (preparing edited recording) starts.
2. Edit recording is not possible with CDs containing a track that is longer than one tape side, which may occur with classical music, etc.
3. If the deck is set for one-side recording (↔), the processing at the tape end is applied only on side A.
4. When the last tune of tape side B is faded out, the ending part of the last but one tune may sometimes be faded out if the space between it and the last tune is short.

Twin recording (For the systems including DP-MH5)

This function allows to record CD sound simultaneously on a tape and MD. All tracks on a CD can be recorded in the same order as they are recorded on the CD.

When recording sound from the MD recorder to a cassette deck, be sure to read the instruction manual of the optional MD recorder (DM-F70).

Recording preparations are required. →  For the reverse mode, select "↔", "⇄" (two-way recording).

1 Press so that the "PGM" indicator goes off.

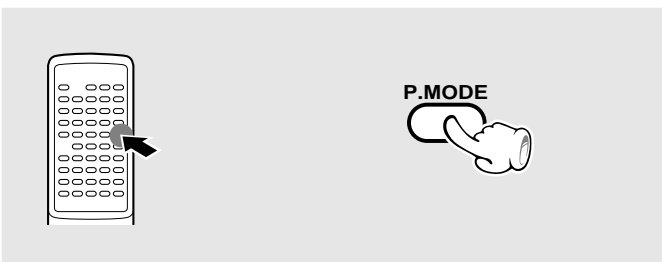

Should be OFF.

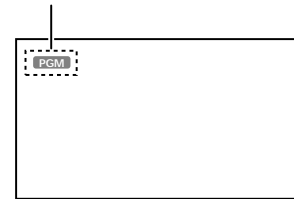

- The recording input of the MD recorder is set automatically to "DIGITAL".

2 Select the disc.



Selected disc No.

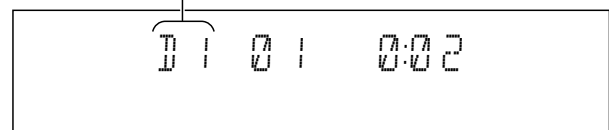

3 Start edit recording.

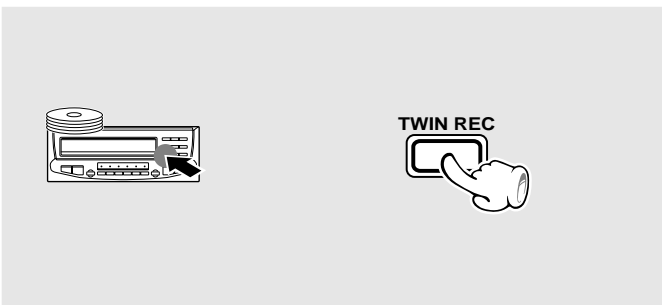

During recording: X-H5

Blinks

Lights



- The recording level and bias will be adjusted automatically in approx. 60 seconds (variable depending on CD contents), after which recording starts.
- The CD tracks are recorded in the order they are recorded on the CD.
- The tape and CD stop automatically when recording has completed.

To end recording in the middle

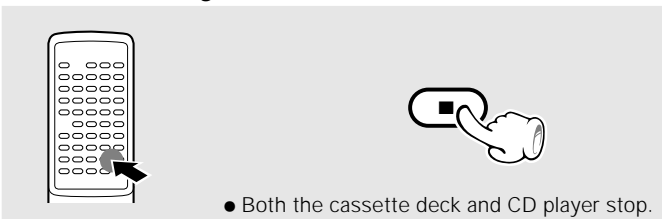

1. When the **TWIN REC** key is pressed during playback of CD, the playback stops and the CCRS setting (preparing edited recording) starts.
2. The automatic recording level setting in the edit recording is based on a suitable section for recording level setting in the loaded CD.
3. If the deck is set for one-side recording (↔), the processing at the tape end is applied only on side A.

This unit permits selection of equalizer and sound field playback. Please select the equalizer as desired according to the music genre. Select the sound field mode according to the desired atmosphere.

Enjoying Sound Field Effects



When playing back a tape recorded by applying the SRS 3D effect, be sure to turn off the SRS 3D system.

Experiencing SRS 3D (Sound Retrieval System)

The Sound Retrieval System is an epochal system which produces a three-dimensional sound space by applying the most suitable processing to the sound signal on the basis of the human listening mechanism. This permits real depth and sound location, considered as difficult to realize with conventional 2-channel stereo (general stereo). A sufficient effect can be obtained for any source (CD, tape, broadcasts, etc.). Recording with applied SRS 3D also is possible.

1 Set SRS 3D to ON.

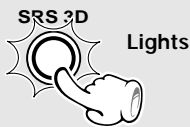
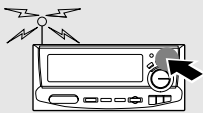

Each press switches the modes as follows.

- ① SRS 3D indicator lit SRS 3D STEREO ON.
- ② SRS 3D indicator not lit SRS 3D STEREO OFF.

The characters scroll toward the left.

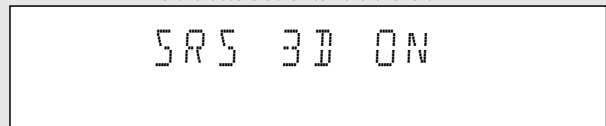

2 Adjust the effect strength (level).

(1) LEVEL will be displayed.

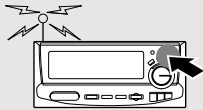

Each press switches the modes as follows.

- ① Strength of the SRS 3D effect (LEVEL)
- ② Spectrum analyzer display switching (DISPLAY)
- ③ Left and right volume balance

(2) Adjust the strength of the effect.

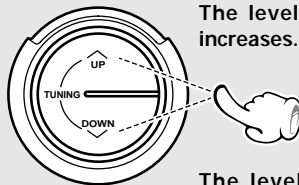
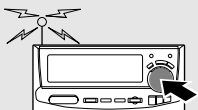

The level increases.

The level decreases.

Level display

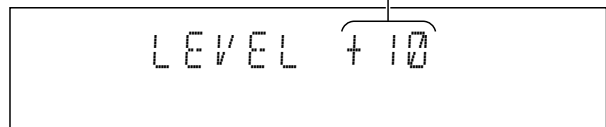

- Adjustment is possible in the range from -10 to +10.
- Please set as desired according to the titles being played back etc.
- SRS 3D ON/OFF switching is not possible during recording.



When equalizer or another effect is applied to the sound, the sound with the applied effect can be recorded. (Recording and playback of the sound with sound effect are impossible with a component connected to the MD jacks.)

Listening with the desired sound (equalizer function)

In addition to the five kinds of equalizer patterns which have been preset at the factory for use as reference, one equalizer pattern created manually by the user can be stored in memory and recalled any time.



When playing back a tape recorded by applying the equalizer effect, be sure to turn off the equalizer.

In regard to equalizer adjustment

The setting items are displayed only when the equalizer is set to **MANUAL** (user memory).

Selecting an equalizer pattern

It is possible to select the desired equalizer pattern according to the category of the played music. The graphic equalizer effect can be recorded together with the sound.

① Play desired music.

② Select the desired equalizer pattern.



- On the remote control unit, each press of the **EQ** key switches the equalizer patterns.
- The equalizer effect cannot be switched on and off during recording.

Equalizer patterns which can be recalled

- ① **ROCK** (Rock)
- ② **POP** (Popular)
- ③ **DISCO** (Discotheque)
- ④ **JAZZ** (Jazz)
- ⑤ **CLASSIC** (Classic)
- ⑥ **MANUAL** An equalizer effect can be created manually and stored here.
- ⑦ **EQ OFF** (EQ ON not lit ... Equalizer cancelled)

C-H6 display

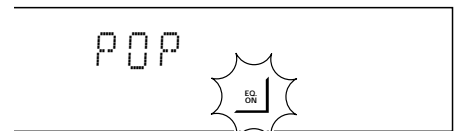

Lights.

C-H5 display

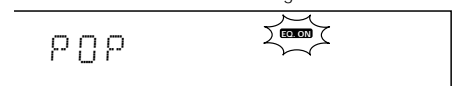

Lights.



When equalizer or another effect is applied to the sound, the sound with the applied effect can be recorded. (Recording and playback of the sound with sound effect are impossible with a component connected to the MD jacks.)

Demonstration

A demonstration of the tone adjustment functions including the equalizer, SRS 3D, EX. BASS and NB CIRCUIT can be performed in sequence.

Press so that "DEMO ON" is displayed.

For the systems including the C-H6 :

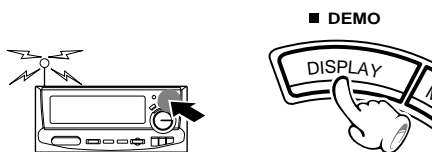

■ DEMO

Press and hold for more than 2 seconds.

For the systems including the C-H5 :



The characters scroll toward the left.

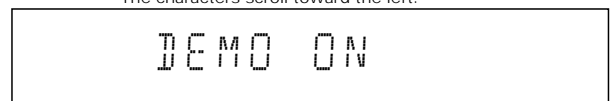

- To end demonstration, press the key again. The "DEMO OFF" characters scroll away and the demonstration is cancelled.
- Even when the power is turned OFF during demonstration, the demonstration continues without stopping. Press the **DEMO** key again to stop it.

Creation and memorizing of an equalizer pattern

You can edit desired patterns manually and store them in memory.

1 Display "MANUAL".

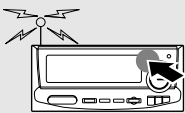

Go to step 2 within 4 sec.

2 Adjust the equalizer pattern.

(1) Select the frequency band.

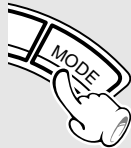
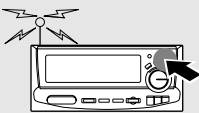

(2) Adjust the level.

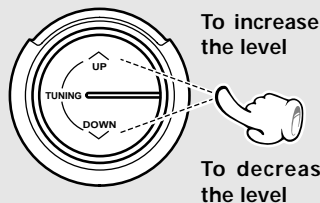
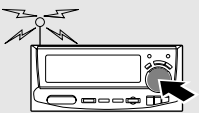

(3) Adjust other items by repeating steps (1) and (2) for each.

3 Store the pattern in memory.

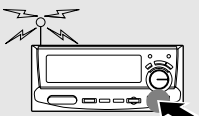

Each press of the key switches the frequency bands.

- 1 ROCK
- 2 POP
- 3 DISCO
- 4 JAZZ
- 5 CLASSIC
- 6 MANUAL
- 7 EQ OFF

C-H6 display

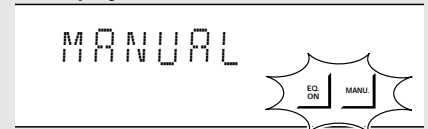

C-H5 display

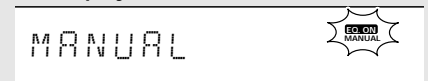

Each press of the key switches the frequency bands.

For the systems including the C-H6

- 1 68 Hz
- 2 130 Hz
- 3 400 Hz
- 4 1 kHz
- 5 2 kHz
- 6 6.3 kHz
- 7 16 kHz

For the systems including the C-H5

- 1 LOW Low frequencies (bass, bass drum, etc.)
- 2 MID Medium frequencies (vocals, guitars, etc.)
- 3 HIGH High frequencies (cymbals, etc.)

C-H6 display

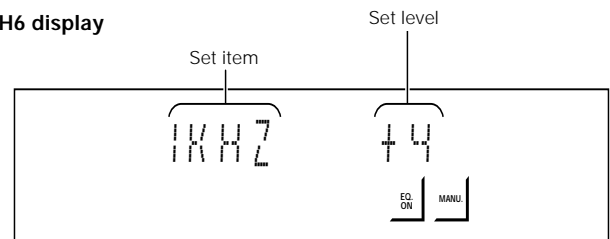

C-H5 display

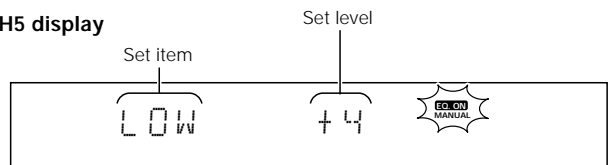

• Each frequency band can be adjusted in the range between -4 and +4.

Adjustment of balance and input level

Balance Adjusts the balance of left and right volume.

Input level The input level from the external equipment connected to the AUX input jacks (VCR, etc.) or the external equipment connected to the MD PLAY jacks (MD recorder, etc.) can be adjusted. This adjustment is necessary when the volume of the external equipment is too loud, etc. Please adjust as required when the volume from external equipment is too high etc.

BALANCE adjustment

- ① Select the balance adjustment mode.



When no operation is executed for 4 seconds or more, the adjustment is ended automatically.

- ② Adjust.

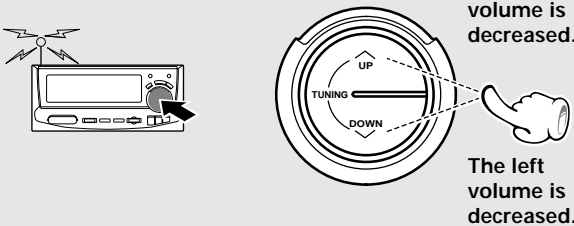

The right volume is decreased.

The left volume is decreased.

Each press switches the modes as follows.

- ① Strength of the SRS 3D effect (LEVEL)
- ② Spectrum analyzer display switching (DISPLAY)
- ③ Left and right volume balance

- "LEVEL" (the level of the SRS 3D effect) is displayed only when the SRS 3D system is active.

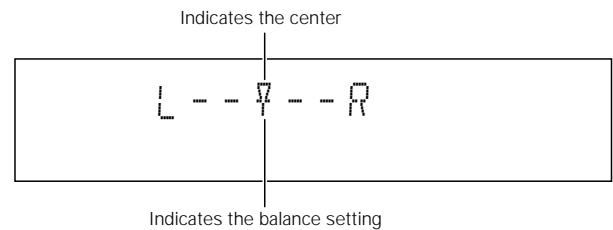

INPUT LEVEL adjustment

- ① Press the MD or AUX key twice successively.

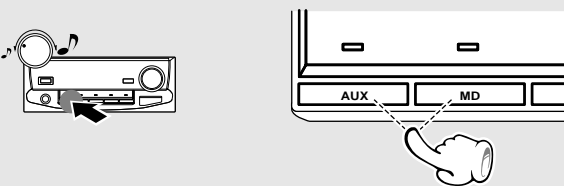

When no operation is executed for 4 seconds or more, the adjustment is ended automatically.

- ② Adjust.

The level is decreased.

The level is increased.

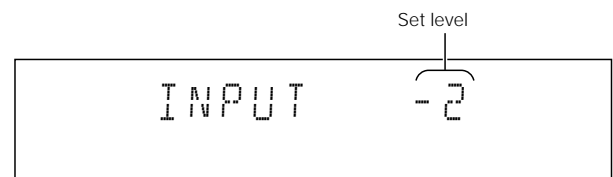
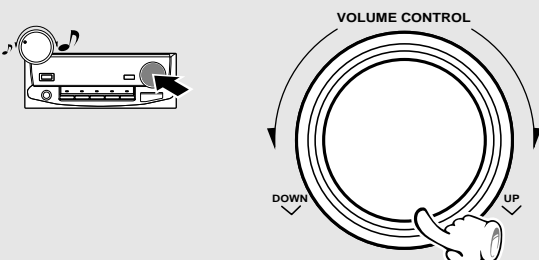

- Adjustment is possible in the range from -5 to 0.



Adjusting the input level affects the recording level from external equipment connected to the AUX input jacks or MD PLAY input jacks.
"Adjusting the recording level"

Switching the display

From the wide range of display formats provided by the system, it is possible to select the desired formats.

Switching the dual display (For the systems including C-H6)

The display panel of the tuner/equalizer unit has been designed to show two groups of display information three-dimensionally. However, this can be changed so that only one group of display information is shown at a time.

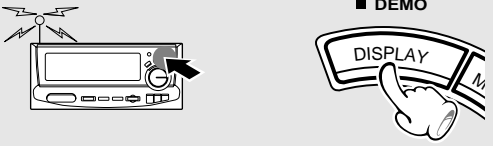

Each press switches the display formats as follows.

- ① Dual display
- ② Character display
- ③ Spectrum analyzer display

① Dual display

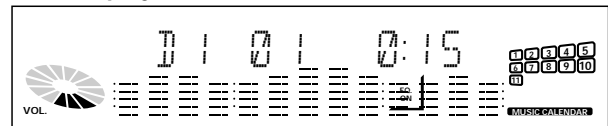

② Character display

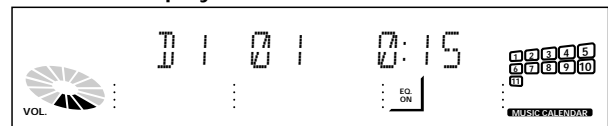

③ Spectrum analyzer display

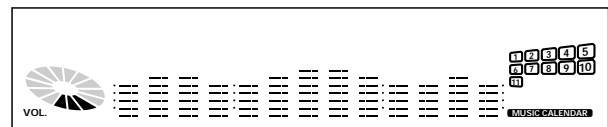

Switching the spectrum analyzer display

① Select "DISPLAY".



② Select the desired spectrum analyzer display format.

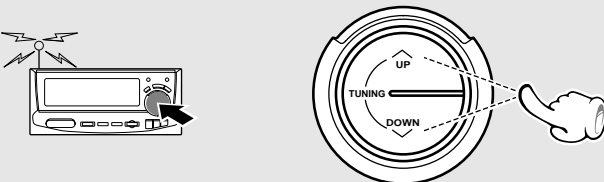

Each press switches the modes as follows.

- ① Strength of the SRS 3D effect (LEVEL)
- ② Spectrum analyzer display switching (DISPLAY)
- ③ Left and right volume balance

● "LEVEL" (the level of the SRS 3D effect) is displayed only when the SRS 3D system is active.



● One of the 7 display formats can be selected (DISPLAY 1 to DISPLAY 7).

This unit incorporates a clock function. Be sure to adjust the correct time before using the timer function.

Ensure that the power is OFF.

1 Activate the clock adjustment mode.

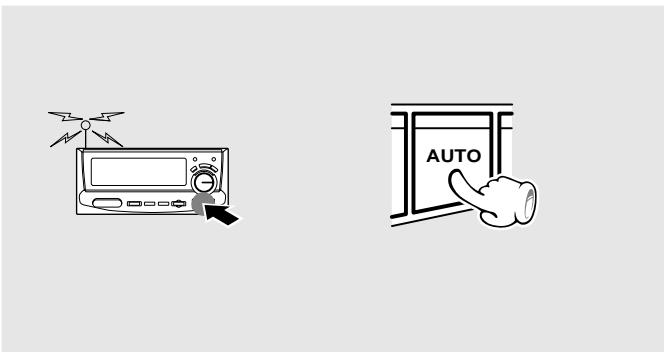

Example: Adjustment to 8:45

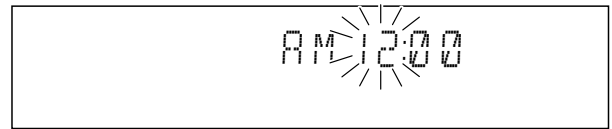

- The time display starts to blink.

2 Enter the figure of hour.

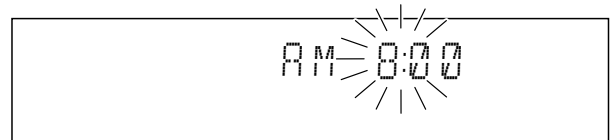
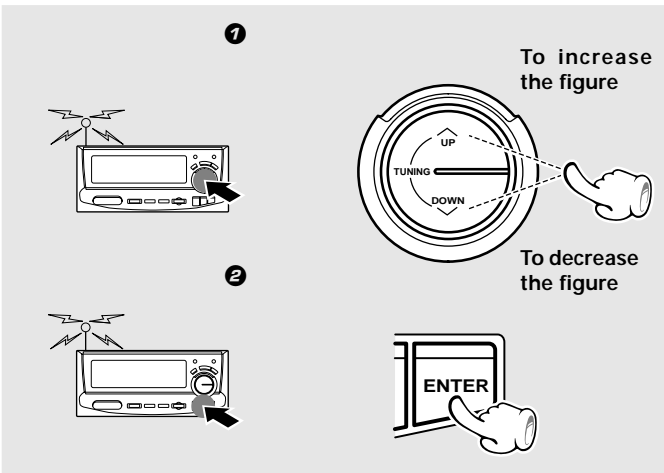

- The time of the day is represented in 12-hour AM/PM method.
- Press the **ENTER** key. The hour is entered and the minute display starts to blink.

3 Enter the figure of minute.

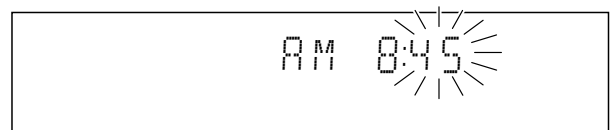
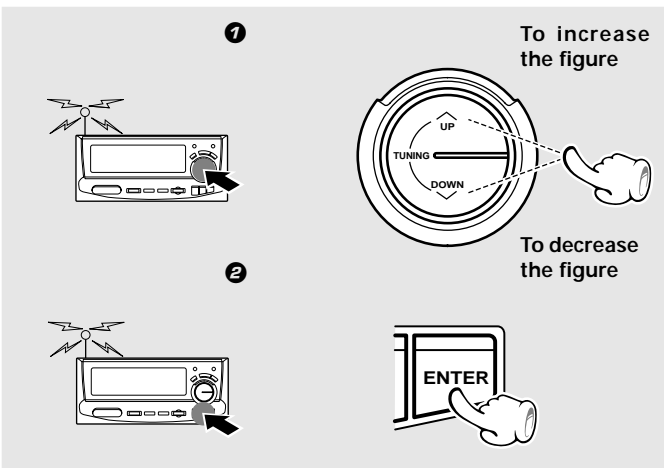

- If you make a mistake, restart from the beginning.
- To adjust correct time, press the **ENTER** key at the same moment as a time announcement.
- The time display blinks after a power failure or when the power cord has been unplugged from the AC outlet and plugged again. In such a case, adjust the clock again.

Operate easy To use Timer (O.T.T.)

Playback of the selected input source starts at the specified time, and the power is switched off after one hour. This timer operates only once directly after setting.

Sleep timer (SLEEP)

The power is turned OFF automatically after the specified period has elapsed.

Timer playback, timer recording (PROG.1, PROG.2)

With each of the two timer programs, a selected source can be played (or radio broadcast can be recorded) in the previously set time period.





AI timer playback (PROG.1, PROG.2)

The volume increases gradually until the factory-set level.

Adjust the clock before setting the timer.

Operate easy To use Timer (Operate easy To use Timer : O.T.T.)

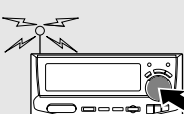
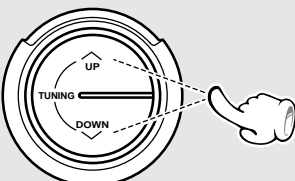
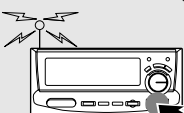
Timer playback can be set with a simple operation of just setting the time. With this function, the last source selected before turning power off can be played by the timer. The power turned ON by the timer is switched off automatically in an hour after the timer playback starts.

- 1 Select the desired source and adjust the volume.
 
- 2 Press the O.T.T. key.
 
- 3 Set the ON time.
 

- 4 Press the ENTER key.
 

- 5 Switch OFF the power supply.



The program timer does not operate until O.T.T. operation has ended.

- At the time of tape playback by timer operation, the B deck has priority.
- For the systems including the DP-MH5: Timer playback of a CD is possible only with the CD loaded in tray No. 1.
- The input source and ON time are displayed when the O.T.T. key is pressed.

Each press switches the modes as follows.

- 1 O.T.T. lit Timer can be used.
- 2 O.T.T. not lit ... Timer is not used.

C-H6 display

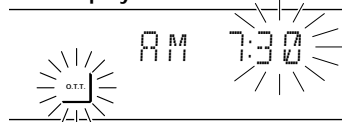

C-H5 display

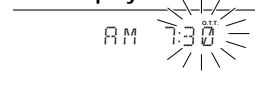





- The ON time can be set in steps of 5 minutes.
- When the O.T.T. timer is used simultaneously with another timer function, the last operated input source will be played.
- The O.T.T. timer can be set even while the power is OFF.

To cancel

Press the O.T.T key twice.

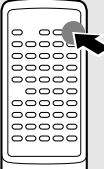
Sleep timer (SLEEP)

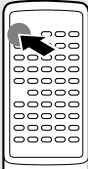
Set the number of minutes after which the power is to be turned OFF.

- 1 Turn the power ON.
 

- 2 Set the time.
 

- The power is turned OFF automatically after the set time has elapsed.
- Each press decreases the time by 10 minutes. The maximum time that can be set is 90 minutes.

90→80→70...30→20→10→Cancel→90→80...

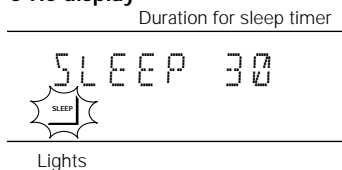
C-H6 display



C-H5 display

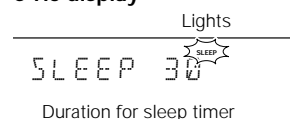

To cancel

Turn the power OFF or press the SLEEP key until the sleep time is cancelled.

Timer programming

Two 24-hour timer systems (PROG.1, PROG.2) (which can be used every day) are available.

In each of PROG.1 and PROG.2, the timer data including the operating period and played contents can be set and selected to be activated or not as required.

- Timer reservation is possible for the two types PROG.1 and PROG. 2 at the same time.
- Please make reservations with an interval of at least one minute, so that the operation times of PROG. 1 and PROG. 2 do not overlap.

Adjust the clock before setting the timer.

1 Make preparations for the play (recording).

To listen to radio	To listen to CD	To listen to tape	Playing the auxiliary input source	For recording
The station should be preset prior to the above. → 31	Insert a disc. (Program playback is not possible.) DP-MH5 only: The CD should be loaded in tray No. 1 so that it can be played by the timer.	Set a tape into deck B. The B deck has priority at the time of timer playback.	Make timer setting of the component connected to the AUX or MD jacks.	Make preparations for recording. → 32

2 Adjust the listening volume.

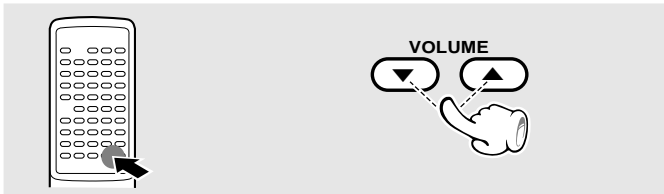

- When recording radio, the listening volume is automatically set to the minimum volume at the moment the power is turned ON by the timer.

3 Set the POWER switch to OFF (STANDBY) position.



4 Select a program No.

Each press of the key switches the program numbers as follows.

- ① PROG.1 Program 1
- ② PROG.2 Program 2
- ③ Normal operation

Within 8 seconds!

EX.BASS

ENTER (AUTO. M.)

C-H6 display

Lights

C-H5 display

Lights

- The selected program No. lights.
- If a program No. under which a timer program has already been reserved, it is replaced by the new timer program.

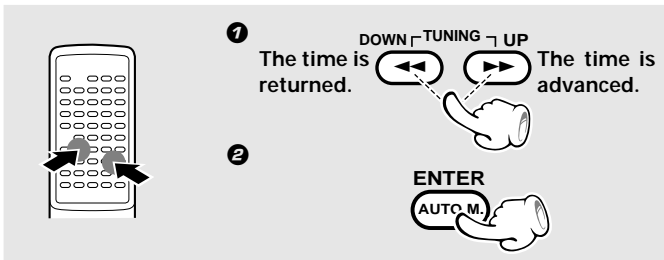
5 Enter the ON time.

- After entering the figure of "hour" with the procedure in **1** and **2**, enter the figure of "minute" using the same procedure.

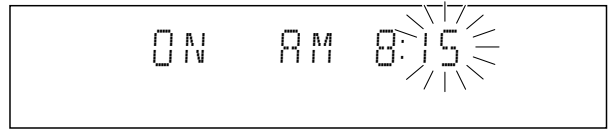

- If you commit a mistake, restart from step **4**.

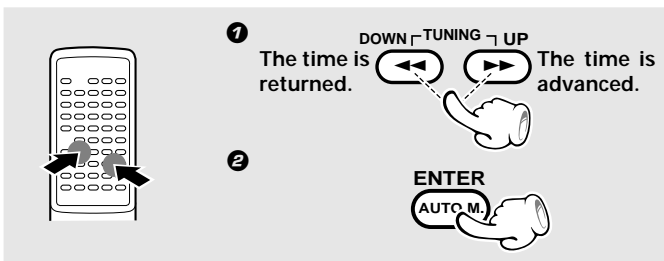
6 Enter the OFF time.

- After entering the figure of "hour" with the procedure in **1** and **2**, enter the figure of "minute" using the same procedure.

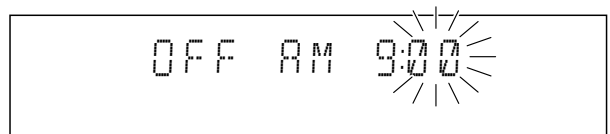

- If you commit a mistake, restart from step **4**.

7 Make the desired reservation.

For timer playback or AI timer playback

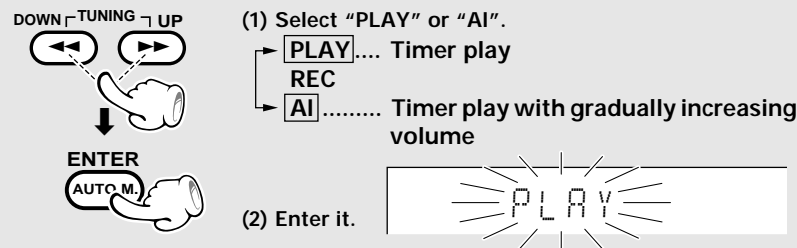
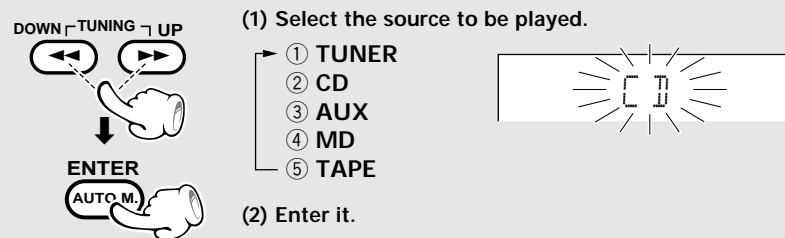
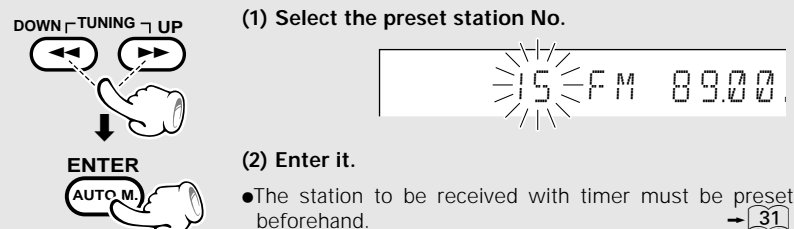
1 Select the mode.**2** Select the input source.**3** Select the broadcast station (only when TUNER is selected above).

Timer recording of radio broadcasts

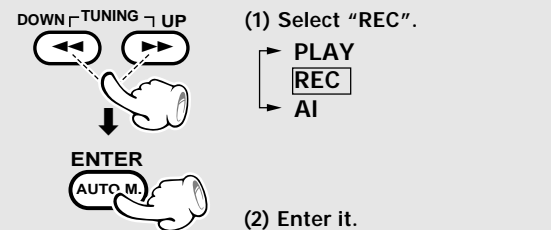
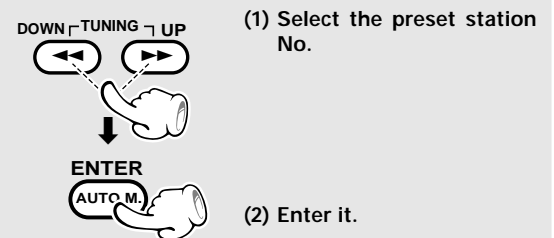
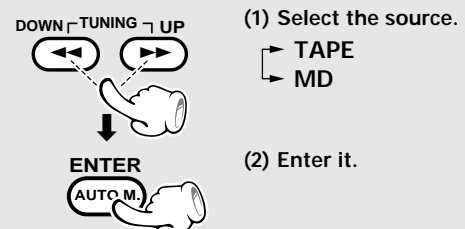
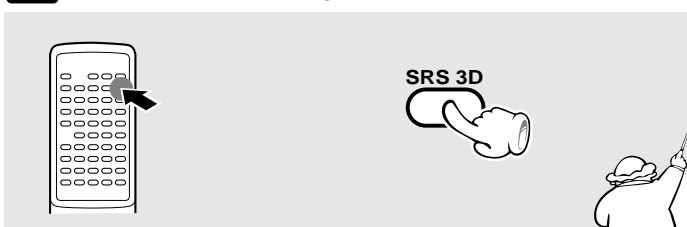
1 Select the mode.**2** Select the broadcast station**3** Select the input source.**8** Select the timer program No. to be used.

Each press of the key switches the program numbers as follows.

- ① **PROG.1** Execution of program 1 only.
- ② **PROG.2** Execution of program 2 only.
- ③ **PROG.1, 2** . Execution of programs 1 and 2.
- ④ **Timer OFF**

- The selected program No. lights.
- The timer will not function unless a program No. is selected.

Ensure that the power is OFF.



The reservation contents cannot be cleared. The contents are cleared only when they are changed.

Check the reservation content.

Select the program number to be checked.

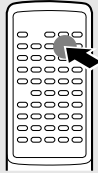

EX.BASS



Each press of the key switches the program numbers as follows.

PROG.1 Display of program 1
 PROG.2 Display of program 2
 Normal mode

- The reserved contents will be displayed for 3 seconds per item. After this, the previous display content appears again.

To change the reserved contents

Restart the procedure of "Timer programming" from the beginning.

When timer operation is not required

Press so that all PROG. indicators are OFF.

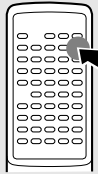

SRS 3D



Each press of the key switches the program numbers as follows.

PROG.1 Program 1 operates.
 PROG.2 Program 2 operates.
 PROG.1, 2 Programs 1 and 2 operate.
 Not lit No program operates.

- The reservation contents are held in memory.

To set the same timer program again

Press so that the desired PROG. indicators lights.

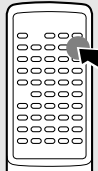

SRS 3D



Each press of the key switches the program numbers as follows.

PROG.1 Program 1 operates.
 PROG.2 Program 2 operates.
 PROG.1, 2 Programs 1 and 2 operate.
 Not lit No program operates.

- Also prepare the disc or tape and adjust the listening volume.

Maintenance

Cleaning the head section

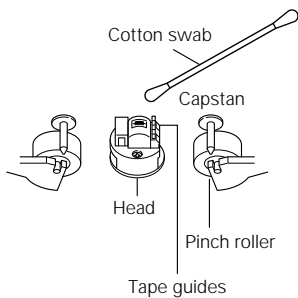

Cleaning the heads and peripheral components

For maintaining the best condition of the deck and for longer service life, always keep the heads (recording / playback / erase), capstan and pinch roller clean. To clean them, perform the following:

1. Open the cassette holder.
2. Using a cotton swab dipped in alcohol, clean the head (recording / playback / erase), capstan and pinch roller carefully.

Demagnetizing the head

When the recording / playback head is magnetized, the sound quality will deteriorate. In such a case, demagnetize the head using a commercially available demagnetizer (head eraser).



There are precisely aligned parts around the heads, including the tape guides. When cleaning, pay special attention so as not to apply shock to them.

Maintenance of the set

When the front panel or case becomes dirty, wipe with a soft, dry cloth. Do not use thinner, benzine, alcohol, etc. for these agents may cause discoloration.

In regard to contact cleaner

Do not use contact cleaners because it could cause a malfunction. Be specially careful not to use contact cleaners containing oil, for they may deform the plastic component.

Reference

Beware of condensation

When water vapor comes into contact with the surface of a cold material, condensation is produced. If condensation occurs, correct operation may not be possible, or the unit may not function correctly. This is not a malfunction, however, and the unit should be dried-out. (To do this, turn the ON/STANDBY switch ON and leave the unit as it is for several hours.)

Be especially careful in the following conditions:

- When the unit is brought from a cold place to a warm place, and there is a large temperature difference.
- When a heater starts operating.
- When the unit is brought from an air-conditioned place to a place of high temperature with high humidity.
- When there is a large difference between the internal temperature of the unit and the ambient temperature, or in conditions where condensation occurs easily.

Memory backup function

Stored contents which are cleared immediately when power plug is unplugged from power outlet

Clock display

Stored contents which are cleared in at least a day after power plug is unplugged from power outlet

- Amplifier**
 - POWER status (ON or OFF)
 - Input selection
 - Volume control value
- Tuner/equalizer unit**
 - Receiving band
 - Frequency
 - Preset stations
 - Program timer setting contents
 - Balance setting
 - Equalizer's manual memory created by the user
 - SRS 3D level
- Cassette deck unit**
 - Recording level
 - Transport direction
 - DOLBY NR
 - Reverse mode

Sound Retrieval System manufactured under licence from SRS Labs, Inc. "SOUND RETRIEVAL SYSTEM" and the SRS Symbol (●) are trademarks of SRS Labs, Inc. Purchase of this product does not convey the right to sell recordings made with the SOUND RETRIEVAL SYSTEM.

Note related to transportation and movement (CD player)

Before transporting or moving this unit, carry out the following operations.

1. Turn the power ON. Then press the OPEN/CLOSE (▲) key of the CD player and take out all CDs.

DP-MH5: Ensure that no CD is loaded in any of the DISC1 to DISC6 trays by opening each of them.

2. Select the "CD" input and ensure that the following message is displayed.

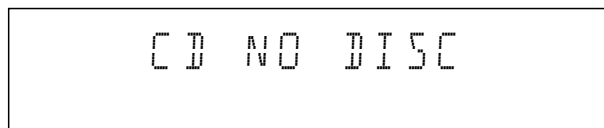

3. Wait for a few seconds then turn power off.

When your unit needs to be repaired, bring the entire set (Speakers excluded) to your dealer.

What seems to be a malfunction is not always so. Before calling for service, check the following table according to the symptom of your trouble.

Operation to reset

The microcomputer may fall into malfunction (impossibility to operate, erroneous display, etc.) when the power cord is unplugged while power is ON or due to an external factor. In this case, execute the following procedure to reset the microcomputer and return it to normal condition.

- Please note that resetting the microcomputer clears the contents stored in and returns and to condition when it left the factory.

While holding the ENTER key depressed, unplug the power cord and plug it again.

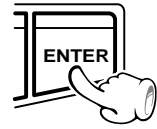
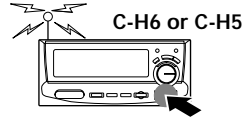

Tuner/Equalizer Unit

Symptom	Cause	Remedy
The clock display blinks without changing the figures.	<ul style="list-style-type: none"> ● There was a power failure. ● The power cord was unplugged from the outlet. 	<ul style="list-style-type: none"> ● Adjust the present time again. → 64 ● Adjust the present time again.
Timer operation is not possible.	<ul style="list-style-type: none"> ● The present time has not been adjusted or there was a power failure. ● The timer ON time and OFF time have not been set. ● The timer execution was not set up. 	<ul style="list-style-type: none"> ● Adjust the present time referring to "Clock adjustment". → 64 ● Set the timer ON time and OFF time. → 66 ● Execute the timer program with the SRS 3D key. → 67
Radio stations cannot be received.	<ul style="list-style-type: none"> ● The antennas have not been connected. ● A proper broadcasting band has not been selected. ● The frequency of the station to be received is not tuned. 	<ul style="list-style-type: none"> ● Connect antennas. → 6 ● Select a band. → 30 ● Tune to the frequency of the desired station. → 30
Noise interferes.	<ul style="list-style-type: none"> ● Car ignition noise. ● Influence of an electric appliance. ● A TV set is installed near the system. 	<ul style="list-style-type: none"> ● Install the outdoor antenna in an apart position from the road. ● Switch the suspected electric appliance OFF. ● Install the TV or the system at an increased distance between them.
A station has been preset but it cannot be received by pressing the P.CALL key.	<ul style="list-style-type: none"> ● The frequency of the preset station is not tunable. ● The preset memory has been cleared because the power cord has been unplugged for a long period. 	<ul style="list-style-type: none"> ● Preset stations with tunable frequencies. → 31 ● Preset stations again. → 31
Demonstration starts suddenly.	<ul style="list-style-type: none"> ● The power plug was unplugged from the outlet while the power switch was ON, or there was a power failure. 	<ul style="list-style-type: none"> ● This is not malfunction. Press the DEMO key to cancel the demonstration. → 60
Power is turned OFF suddenly.	<ul style="list-style-type: none"> ● The AUTO POWER SAVE function is activated. 	<ul style="list-style-type: none"> ● Cancel the AUTO POWER SAVE function. → 21
An error message is displayed (ERROR * (figure))	<ul style="list-style-type: none"> ● There is a certain trouble. The displayed figure is variable depending on the details of the trouble. 	<ul style="list-style-type: none"> ● Please consult your nearest KENWOOD service station.

Cassette deck unit

Symptom	Cause	Remedy
Sound cannot be produced by pressing the play key or no operation occurs even when an operation key is pressed.	<ul style="list-style-type: none"> ● Cords are connected improperly. ● The head is dirty. ● The tape is wound too tight due to irregular winding. ● A nonrecorded tape is played. 	<ul style="list-style-type: none"> ● Connect cords properly by referring to "Connections" . → 6 ● Clean the head referring to "Maintenance" . → 69 ● Try another tape. ● Play a recorded tape.
No operation occurs even when an operation key is pressed.	<ul style="list-style-type: none"> ● The cassette holder is not closed completely. ● The operation key is pressed immediately after closing the cassette holder. ● The operation key is pressed in less than 4 seconds after turning the power ON. ● A tape is not inserted in the unit. ● The tape is wound too tight due to irregular winding. ● The tape is fully wound to one of the reels. 	<ul style="list-style-type: none"> ● Close the holder completely. ● Press operations keys in more than a few seconds after closing the holder. → 26 ● Press operation keys after waiting for more than 4 seconds. ● Insert a tape. ● Try another tape. ● Change the tape transport direction or reverse the tape insertion orientation. → 26
The DPSS malfunctions.	<ul style="list-style-type: none"> ● The tape used is not suitable for DPSS, for example the spaces between tunes may be too short. 	<ul style="list-style-type: none"> ● Refer to "Searching for the desired music program (DPSS)" . → 28
The CCRS does not function.	<ul style="list-style-type: none"> ● A recordable tape is not present in deck B. ● A disc is not present in the CD player. ● The disc is dirty. ● The system control code is not connected. 	<ul style="list-style-type: none"> ● Insert a recordable tape in deck B and retry operation. → 32 ● Place a disc in the CD player and retry operation. ● Clean the disc, place it in the CD player and try the operation again. ● Connect the system control cord. → 6
In dubbing, the tape stops at different moments in decks A and B.	<ul style="list-style-type: none"> ● This is due to the difference in the tape length or characteristics of the mechanisms of two cassette decks. 	<ul style="list-style-type: none"> ● Small time difference does not mean a malfunction.
The cassette holders cannot be opened by pressing the PUSH OPEN area.	<ul style="list-style-type: none"> ● The key is pressed during recording or playback. ● The microcomputer is malfunctioning due to external noise. 	<ul style="list-style-type: none"> ● Press in stop mode. ● Reset the microcomputer. → 70
Sound is harsh or high frequencies are not reproduced.	<ul style="list-style-type: none"> ● The head is dirty. ● The tape is stretched or shrunk. 	<ul style="list-style-type: none"> ● Clean the head referring to "Maintenance" . → 69 ● Try another tape.
Sound is distorted.	<ul style="list-style-type: none"> ● The recording level is not adjusted properly. ● The tape being played was recorded with distorted sound. ● A tape which has been recorded by applying the equalizer or SRS 3D effect is being played by applying the same effect again. 	<ul style="list-style-type: none"> ● Read the section entitled "Recording" . → 32 ● Try another tape. ● Switch the equalizer and SRS 3D effects off. → 59 → 60
Noise is noticeable.	<ul style="list-style-type: none"> ● The tape head is magnetized. ● External noise is induced. ● A tape recorded with Dolby NR ON is played with Dolby NR OFF. 	<ul style="list-style-type: none"> ● Demagnetize the head referring to "Maintenance" . → 69 ● Install the system at a distance from other electric appliances and TV. ● Set the Dolby NR to on. → 27
Sound vibrates.	<ul style="list-style-type: none"> ● The capstans or pinch rollers are dirty. ● The tape is wound irregularly. 	<ul style="list-style-type: none"> ● Clean the head referring to "Maintenance" . → 69 ● Wind the tape again by fast forwarding, rewinding or playing from an end to the other. → 27
Recording cannot be started by pressing the record key.	<ul style="list-style-type: none"> ● The recording protect tab of the cassette has been broken. ● The cassette holder is not closed completely. ● The TAPE input is selected. ● The tape is fully wound to one of the reels. 	<ul style="list-style-type: none"> ● Use a cassette with an unbroken recording protect tab or block the hole. → 5 ● Close the holder completely. ● Select the source to be recorded with the input selector key. → 33 ● Change the tape transport direction of deck B or reverse the tape insertion orientation. → 26

Amplifier/Speaker unit

Symptom	Cause	Remedy
Sound is not produced.	<ul style="list-style-type: none"> ● The speaker cords are disconnected. ● The volume control is set to the minimum position. ● The MUTE switch of remote control unit is switched ON. ● The headphone plug is inserted into the jack. ● Connection cords of the system are disconnected. 	<ul style="list-style-type: none"> ● Connect properly referring to "System connection". → ● Adjust to an required volume. → ● Switch MUTE OFF. → ● Unplug the headphone plug. → ● Check the connection cords. →
"PROTECT" is displayed and sound is not produced.	<ul style="list-style-type: none"> ● The speaker cords are short-circuited. 	<ul style="list-style-type: none"> ● Turn the power OFF, remove the short-circuit and turn the power ON again.
No sound from headphones.	<ul style="list-style-type: none"> ● The headphones are plugged incompletely. 	<ul style="list-style-type: none"> ● Plug headphones securely into the jack. →
Sound is not produced from the left or right speakers.	<ul style="list-style-type: none"> ● The speaker cords are disconnected. ● The balance is set to the left or right extremity. 	<ul style="list-style-type: none"> ● Connect properly referring to "System connection". → ● Adjust the left/right balance. →

CD player unit

Symptom	Cause	Remedy
A CD is placed in the player but it cannot be played.	<ul style="list-style-type: none"> ● The disc is placed upside down. ● The disc position is displaced. ● The disc is extremely dirty. ● The disc is scratched. ● Dew is condensed on the optics lens. 	<ul style="list-style-type: none"> ● Place the disc properly, with the label side facing upward. → ● Place the disc properly. → ● Clean the disc referring to "Disc handling precautions". → ● Try another disc. → ● Refer to "Beware of condensation" and remove the condensation by evaporation. →
Sound is not produced.	<ul style="list-style-type: none"> ● The disc has not been placed. ● The player is not put to the play mode. ● The disc is extremely dirty. ● The disc is scratched. 	<ul style="list-style-type: none"> ● Place a disc in the CD player. → ● Press the play (▶/) key. → ● Clean the disc referring to "Disc handling precautions". → ● Try another disc. →
Sound skips.	<ul style="list-style-type: none"> ● The disc is dirty. ● The disc is scratched. ● The player is subject to vibration. 	<ul style="list-style-type: none"> ● Clean the disc referring to "Disc handling precautions". → ● Try another disc. → ● Install the unit in a place not subject to vibrations. →
The tray cannot be closed but opens when the OPEN/CLOSE key is pressed to close an open tray.	<ul style="list-style-type: none"> ● You attempt to close the tray while the loaded 8 cm (CD single) disc is deviated from the groove on the tray. 	<ul style="list-style-type: none"> ● Place the disc correctly along the groove on the tray, press the OPEN/CLOSE key, ensure that the DISC indicator is lit, and press the play (▶/) key to start playback. → →

Remote control unit

Symptom	Cause	Remedy
Remote control operation is not possible.	<ul style="list-style-type: none"> ● Batteries are exhausted. ● The remote control is too far away from the system, the controlling angle is deviated or there is an obstacle in between. ● There is no tape or CD set in the component to be played. ● An attempt is made to play the cassette deck which is recording something. 	<ul style="list-style-type: none"> ● Replace with new batteries. → ● Operate the unit inside the remote controllable range. → ● Set a tape or CD in the component to be played. ● Wait until the recording ends.



1. With some tapes, a squeaky noise is produced when the tape is stopped automatically. This is due to the tape protection function, and not a malfunction.
2. Do not use longer tape than 110 minutes tapes, for the tape is too thin and gets easily tangled.

Tuner / Equalizer / Amplifier unit (C-H6 or C-H5 / A-H5)

FM Tuner section

Tuning frequency range
 For U.K. and Europe 87.5 MHz ~ 108 MHz
 For Russia
 87.5 MHz ~ 108 MHz
 65.0 MHz ~ 74.0 MHz
 Sensitivity (DIN at 75 Ω)
 MONO 1.8 μV / 16.2 dBf

AM Tuner section

Tuning frequency range 531 kHz ~ 1,602 kHz

[General]

Dimensions W: 270 mm (10-5 / 8")
 H : 124 mm (4-7 / 8")
 D : 330 mm (13")
 Weight (net) 2.1 kg (4.6 lb)

Amplifier section

Rated power output
 80 W + 80 W RMS (1 kHz, 10 % T.H.D. at 6 Ω)
 60 W + 60 W DIN (1 kHz 0.7 % T.H.D. at 6 Ω)
 Total harmonic distortion 0.09 % (1 kHz, 30 W, 6 Ω)
 Signal to noise ratio
 Line (AUX, MD) 90 dB (IHF' A)
 Input sensitivity / Impedance
 Line (AUX, MD)
 200 mV / 47 kΩ (SOURCE DIRECT ON)
 Output level / Impedance
 SUPER WOOFER PRE OUT
 2.0 V / 2.2 kΩ (SOURCE DIRECT ON)
 MD REC 200 mV / 2.2 kΩ

[General]

Power consumption 180 W
 Dimensions W : 270 mm (10-5 / 8")
 H : 104 mm (4-1 / 8")
 D : 343 mm (13-1 / 2")
 Weight (net) 4.6 kg (10.2 lb)

Cassette deck unit (X-H5)

Track 4-track, 2-channel stereo
 Recording system AC bias system
 (Frequency: 105 kHz)

Heads

A deck Playback head 1
 B deck Playback / recording head 1
 Erasing head 1

Motors

A deck 1
 B deck 1

Fast winding time Approx. 115 seconds
 (C-60 tape)

Frequency response

Type I tape 50 Hz to 15,000 Hz, ± 3 dB
 Type II tape 50 Hz to 16,000 Hz, ± 3 dB

Signal to noise ratio

Dolby B NR ON 64 dB (3rd H.D. 3 % ,Type II tape)
 Dolby NR OFF 56 dB (3rd H.D. 3 % ,Type II tape)

Wow and flutter 0.15 % (W.R.M.S.)

[General]

Dimensions W : 270 mm (10-5 / 8")
 H : 124 mm (4-7 / 8")
 D : 322 mm (12-11 / 16")
 Weight (net) 2.7 kg (6 lb)

WARNING NOTICE:

IN MOST CASES IT IS AN INFRINGEMENT OF COPYRIGHT TO MAKE COPIES OF TAPES OR DISCS WITHOUT THE PERMISSION OF THE COPYRIGHT OWNERS. ANYONE WISHING TO COPY COMMERCIALY AVAILABLE TAPES OR DISC SHOULD CONTACT THE MECHANICAL COPYRIGHT PROTECTION SOCIETY LIMITED OR THE PERFORMING RIGHTS SOCIETY LIMITED.



1. KENWOOD follows a policy of continuous advancements in development. For this reason specifications may be changed without notice.
2. Sufficient performance may not be possible at very low temperatures (0°C or less).

CD player unit (DP-H5 / DP-MH5)**Format section**

Laser Semiconductor laser

D/A convertors section

D/A conversion 1 bit

Oversampling 8 fs (352.8 kHz)

Audio sectionFrequency response 8 Hz ~ 20 kHz, ± 1.0 dB

Signal to noise ratio More than 96 dB

Dynamic range More than 90 dB

Total harmonic distortion
..... Less than 0.008 % (at 1 kHz)

Channel separation More than 90 dB (at 1 kHz)

Wow & Flutter Unmeasurable Limit

Digital output

Optical -15 dBm ~ -21 dBm (wave length 660 nm)

[General]

Dimensions W : 270 mm (10-5 / 8")

H : 104 mm (4-1 / 8")

D : 326 mm (12-13 / 16")

Weight (net)

DP-H5 2.3 kg (5.1 lb)

DP-MH5 3.4 kg (7.5 lb)

Speakers (LS-J6/LS-H5)**LS-J6**

Enclosure Bass-reflex type

Speaker configuration 3-Way system

Woofer 180 mm, cone type

Tweeter 65 mm, cone type

Tweeter 25 mm, dome type

Impedance 6 Ω

Maximum input level 80 W

[General]

Dimensions W : 240 mm (9-7 / 16")

H : 456 mm (17-15 / 16")

D : 286 mm (11-1 / 4")

Weight (net) 6 kg (13.3 lb) (1 piece)

LS-H5

Enclosure Bass-reflex type

Speaker configuration 3-Way system

Woofer 160 mm, cone type

Tweeter 50 mm, cone type

Tweeter 25 mm, dome type

Impedance 6 Ω

Maximum input level 80 W

Frequency response 45 Hz ~ 20,000 Hz

[General]

Dimensions W : 230 mm (9-1 / 16")

H : 456 mm (17-15 / 16")

D : 295 mm (11-5 / 8")

Weight (net) 5.6 kg (12.4 lb) (1 piece)



1. KENWOOD follows a policy of continuous advancements in development. For this reason specifications may be changed without notice.
2. Sufficient performance may not be possible at very low temperatures (0°C or less).

KENWOOD

For your records

Record the serial number, found on the back of the unit, in the spaces designated on the warranty card, and in the space provided below. Refer to the model and serial numbers whenever you call upon your dealer for information or service on this product.

Model _____

Serial Number _____

Free Manuals Download Website

<http://myh66.com>

<http://usermanuals.us>

<http://www.somanuals.com>

<http://www.4manuals.cc>

<http://www.manual-lib.com>

<http://www.404manual.com>

<http://www.luxmanual.com>

<http://aubethermostatmanual.com>

Golf course search by state

<http://golfingnear.com>

Email search by domain

<http://emailbydomain.com>

Auto manuals search

<http://auto.somanuals.com>

TV manuals search

<http://tv.somanuals.com>