

# KENWOOD

DVD COMPACT HIFI SYSTEM

**XD-DV90**

**XD-DV80**

**XD-DV70**

**XD-DV60**

**XD-DV50**

**XD-A850DV**

---

## INSTRUCTION MANUAL

KENWOOD CORPORATION

This instruction manual is used to describe multiple models listed above.  
Model availability and features (functions) may differ depending on the country and sales area.



B60-4911-08 (K/Y/T/M/X) 01/03

## Before applying power

**⚠ Caution : Read this section carefully to ensure safe operation.**

Units are designed for operation as follows.

**U.S.A. and Canada ..... AC 120 V only**  
**Europe and U.K. .... AC 230 V only**

**Australia ..... AC 240 V only**  
**\*Other countries ..... AC 110-120 / 220-240 V switchable**

### For the United Kingdom

#### Factory fitted moulded mains plug

1. The mains plug contains a fuse. For replacement, use only a 3-Amp ASTA-approved (BS 1362) fuse.
2. The fuse cover must be refitted when replacing the fuse in the moulded plug.
3. Do not cut off the mains plug from this equipment. If the plug fitted is not suitable for the power points in your home or the cable is too short to reach.

A power point, then obtain an appropriate safety approved extension lead or adapter, or consult your dealer. If nonetheless the mains plug is cut off, remove the fuse and dispose of the plug immediately, to avoid a possible shock hazard by inadvertent.

Connection to the mains supply.

#### IMPORTANT :

The wires in the mains lead are coloured in accordance with the following code:

Blue : Neutral

Brown : Live

Do not connect those leads to the earth terminal of a three-pin plug.

### \*For other countries

#### AC voltage selection

The AC voltage selector switch on the rear panel is set to the voltage that prevails in the area to which the unit is shipped. Before connecting the power cord to your AC outlet, make sure that the setting position of these switches matches your line voltage. If not, it must be set to your voltage in accordance with the following direction.

#### AC voltage selector switches



Move switch lever to match your line voltage with a small screwdriver or other pointed tool.

#### Note:

Our warranty does not cover damage caused by excessive line voltage due to improper setting of the AC voltage selector switch.

## Safety precautions

**⚠ Caution : Read this section carefully to ensure safe operation.**

**WARNING : TO PREVENT FIRE OR ELECTRIC SHOCK, DO NOT EXPOSE THIS APPLIANCE TO RAIN OR MOISTURE.**

	<p><b>CAUTION</b> RISK OF ELECTRIC SHOCK DO NOT OPEN</p>		<p><b>CAUTION: TO REDUCE THE RISK OF ELECTRIC SHOCK, DO NOT REMOVE COVER (OR BACK). NO USER-SERVICEABLE PARTS INSIDE, REFER SERVICING TO QUALIFIED SERVICE PERSONNEL.</b></p>
	<p><b>THE LIGHTNING FLASH WITH ARROWHEAD SYMBOL, WITHIN AN EQUILATERAL TRIANGLE, IS INTENDED TO ALERT THE USER TO THE PRESENCE OF UNINSULATED "DANGEROUS VOLTAGE" WITHIN THE PRODUCT'S ENCLOSURE THAT MAY BE OF SUFFICIENT MAGNITUDE TO CONSTITUTE A RISK OF ELECTRIC SHOCK TO PERSONS.</b></p>		
	<p><b>THE EXCLAMATION POINT WITHIN AN EQUILATERAL TRIANGLE IS INTENDED TO ALERT THE USER TO THE PRESENCE OF IMPORTANT OPERATING AND MAINTENANCE (SERVICING) INSTRUCTIONS IN THE LITERATURE ACCOMPANYING THE APPLIANCE.</b></p>		

### The marking of products using lasers (Except for some areas)

**CLASS 1  
LASER PRODUCT**

The marking is located on the rear panel and says that the component uses laser beams that have been classified as Class 1. It means that the unit is utilizing laser beams that are of a weaker class. There is no danger of hazardous radiation outside the unit.

## Unpacking

Unpack the unit carefully and make sure that all accessories are put aside so they will not be lost.

Examine the unit for any possibility of shipping damage. If your unit is damaged or fails to operate, notify your dealer immediately. If your unit was shipped to you directly, notify the shipping company without delay. Only the consignee (the person or company receiving the unit) can file a claim against the carrier for shipping damage.

We recommend that you retain the original carton and packing materials for use should you transport or ship the unit in the future.

**Keep this manual handy for future reference.**

## Accessories

Please confirm that the following accessories are present.

### Accessories packed with the main unit

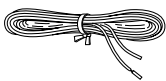
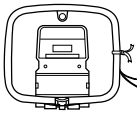
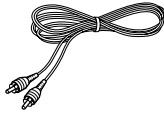
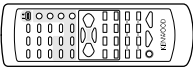
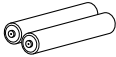
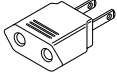
<b>FM indoor antenna (1)</b> 	<b>Loop antenna (1)</b> 	<b>Video cord (1)</b> 
<b>Remote control unit (1)</b> 	<b>Batteries (R6/AA) (2)</b> 	<b>*AC plug adaptor (1)</b>  <p>* Use to adapt the plug on the power cord to the shape of the wall outlet. (Accessory only for regions where use is necessary.)</p>

### Speaker model names and accessories packed with the speakers

System	Front speakers	Surround Speakers and accessories
XD-DV90	LS-N90V (Left speaker and right speaker)	CRS-N90V (Center speaker × 1, surround speakers × 2, speaker cords × 3, speaker stabilizer × 12)
XD-DV80	LS-N70V (Left speaker and right speaker)	CRS-N90V (Center speaker × 1, surround speakers × 2, speaker cords × 3, speaker stabilizer × 12)
XD-DV70	LS-N90V (Left speaker and right speaker)	—
XD-DV60	LS-N70V (Left speaker and right speaker)	—
XD-DV50	LS-N50V (Left speaker and right speaker)	—
XD-A850DV	LS-N50V (Left speaker and right speaker)	—

## CHANNEL SPACE setting (Except for the U.S.A., Canada, U.K., Europe and Australia)

The space between radio channels has been set to the one that prevails in the area to which the system is shipped. However, if the current channel space setting does not match the setting in the area where the system is to be used, for instance when you move from area 1 or area 2 shown in the following table or vice versa, proper reception of AM/FM broadcasts cannot be expected. In this case, change the channel space setting in accordance with your area by referring to the following table.

Area	CHANNEL SPACE frequency
1 USA, Canada and South American countries	FM : 100 kHz AM : 10 kHz
2 Other countries	FM : 50 kHz AM : 9 kHz

### Setting the CHANNEL SPACE

- ① Set the **POWER** key to standby (power off) mode.
- ② Press and hold the **STOP** (■) key for more than 2 seconds.

Each press for more than 2 seconds switches the modes as follows.

- ① "FM100/AM10 kHz" STEP
- ② "FM 50 /AM 9 kHz" STEP

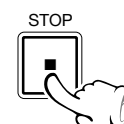

## In regard to demonstration

When this unit is switched on for the first time or after the power cable has been disconnected for a long time, it will enter automatically into demonstration mode (only display). During the demonstration, the display changes in sequence but the audio does not change. The demonstration can be canceled with the following procedure.

### Cancellation of Demonstration mode

- ❶ Set the **POWER** key to ON.
- ❷ Press the **DISPLAY/DEMO** key.



### To start demonstration:

Press and hold The **DISPLAY/DEMO** key for more than 2 seconds.

## Special features

This document classifies the applications of each feature using the following marks

- DVD** : Description of a feature that can be used with DVD.
- VCD** : Description of a feature that can be used with Video CD.
- CD** : Description of a feature that can be used with CD.

<b>DVD</b>	<b>Higher video quality than S-VHS video and LaserDisc</b>
<b>DVD</b>	<b>Higher audio quality than music CD</b>
<b>DVD</b> <b>CD</b> <b>VCD</b>	<b>Graphical user interface (GUI) compatibility</b>
<b>DVD</b>	<b>6-Channel independent outputs using built-in Dolby Digital (AC-3) decoder (only for XD-DV90/XD-DV80)</b>
<b>DVD</b>	<b>Versatile DVD playback features</b>
<b>DVD</b> <b>CD</b>	<b>DTS digital output compatibility</b>

# IMPORTANT SAFEGUARDS

 **Caution :** Read this page carefully to ensure safe operation.

5

XD-DV series (EN/K,M,T,X,Y)

Please read all of the safety and operating instructions before operating this appliance. Adhere to all warnings on the appliance and in the instruction manual. Follow all the safety and operating instructions. These safety and operating instructions should be retained for future reference.

**1. Power sources** – The appliance should be connected to a power supply only of the type described in the instruction manual or as marked on the appliance. If you are not sure of the type of power supply to your home, consult your appliance dealer or local power company. For appliances intended to operate from battery power, or other sources, refer to the instruction manual.

**2. Power-cord protection** – Power-supply cords should be routed so that they are not likely to be walked on or pinched by items placed upon or against them, pay particular attention to cords at plugs, convenience receptacles, and the point where they exit from the appliance.

**3. CAUTION – Polarization** – This appliance may be equipped with a polarized alternating-current line plug (a plug having one blade wider than the other). This plug will fit into the power outlet only one way. This is a safety feature. If you are unable to insert the plug fully into the outlet, try reversing the plug. If the plug should still fail to fit, contact your electrician to replace your obsolete outlet. Do not defeat the safety purpose of the polarized plug.

**4. Ventilation** – Slots and openings in the cabinet are provided for ventilation and to ensure reliable operation of the appliance and to protect it from overheating, and these openings must not be blocked or covered. The appliance should be situated so that its location or position does not interfere with its proper ventilation.

To maintain good ventilation, do not put records or a tablecloth on the appliance. Place the appliance at least 10 cm away from the walls.

Do not use the appliance on a bed, sofa, rug or similar surface that may block the ventilation openings. This appliance should not be placed in a built-in installation such as a bookcase or rack unless proper ventilation is provided or the manufacturer's instructions have been adhered to.

**5. Water and moisture** – The appliance should not be used near water - for example, near a bathtub, washbowl, kitchen sink, laundry tub, in a wet basement, or near a swimming pool, etc.

**6. Temperature** – The appliance may not function properly if used at extremely low, or freezing temperatures. The ideal ambient temperature is above +5°C (41°F).

**7. Heat** – The appliance should be situated away from heat sources such as radiators, heat registers, stoves, or other appliances (including amplifiers) that produce heat.

**8. Electric shock** – Care should be taken so that objects do not fall and liquid is not spilled into the enclosure through openings. If a metal objects, such as a hair pin or a needle, comes into contact with the inside of this appliance, a dangerous electric shock may result. For families with children, never permit children to put anything, especially metal, inside this appliance.

**9. Enclosure removal** – Never remove the enclosure. If the internal parts are touched accidentally, a serious electric shock might occur.

**10. Magnetic fields** – Keep the appliance away from sources of magnetic fields such as TV sets, speaker systems, radios, motorized toys or magnetized objects.

**11. Cleaning** – Unplug this appliance from the wall outlet before cleaning. Do not use volatile solvents such as alcohol, paint thinner, gasoline, or benzene, etc. to clean the cabinet. Use a clean dry cloth.

**12. Accessories** – Do not place this appliance on an unstable cart, stand, tripod, bracket, or table. The appliance may fall, causing serious injury to a child or adult, and serious damage to the appliance. Use only with a cart, stand, tripod, bracket, or table recommended by the manufacturer, or sold with the appliance. Any mounting of the appliance should follow the manufacturer's instructions, and should use a mounting accessory recommended by the manufacturer. An appliance and cart combination should be moved with care. Quick stops, excessive force, and uneven surfaces may cause the appliance and cart combination to overturn.

**13. Lightning** – For added protection for this appliance during a lightning storm, or when it is left unattended and unused for long periods of time, unplug it from the wall outlet and disconnect the antenna or cable system. This will prevent damage to the appliance due to lightning and power-line surges.

**14. Abnormal smell** – If an abnormal smell or smoke is detected, immediately turn the power OFF and unplug the appliance from the wall outlet. Contact your dealer or nearest service center.

**15. Damage requiring service** – The appliance should be serviced by qualified service personnel when:

- A.** The power-supply cord or the plug has been damaged.
- B.** Objects have fallen, or liquid has been spilled into the appliance.
- C.** The appliance has been exposed to rain or water.
- D.** The appliance does not appear to operate normally by following the instruction manual. Adjust only those controls that are covered by the instruction manual as an improper adjustment of other controls may result in damage and will often require extensive work by a qualified technician to restore the appliance to its normal operation.
- E.** The appliance has been dropped, or the enclosure damaged.
- F.** The appliance exhibits a marked change in performance.

**16. Servicing** – The user should not attempt to service the appliance beyond that described in the instruction manual. All other servicing should be referred to qualified service personnel.

**17. Outdoor antenna grounding** – If an outside antenna is connected to the appliance, be sure the antenna system is grounded so as to provide some protection against voltage surges and built up static charges. Article 810 of the National Electrical Code ANSI/NFPA 70, provides information with respect to proper grounding of the mast and supporting structure, grounding of the lead-in wire to an antenna discharge unit, size of grounding conductors, location of antenna discharge unit, connection to grounding electrodes, and requirements for the grounding electrode. See Figure.

**18. Power lines** – An outside antenna system should not be located in the vicinity of overhead power lines or other electric light or power circuits, or where it can fall into such power lines or circuits. When installing an outside antenna system, extreme care should be taken to keep from touching such power lines or circuits as contact with them might be fatal.

**19. AC outlets** – Do not connect other audio equipment with a power consumption larger than that specified to the AC outlet on the rear panel. Never connect other electrical appliances, such as an iron or toaster, to it to prevent fire or electric shock.

**20. Overloading** – Do not overload wall outlets, extension cords, or integral convenience receptacles as this can result in a risk of fire or electric shock.

**21. Attachment** – Do not use attachments not recommended by the appliance manufacturer as they may cause hazards.

**22. Replacement parts** – When replacement parts are required, be sure the service technician has used replacement parts specified by the manufacturer or have the same characteristics as the original parts. Unauthorized substitutions may result in fire, electric shock, or other hazards.

**23. Safety check** – Upon completion of any service or repairs to this appliance, ask the service technician to perform safety checks to determine that the appliance is in proper operating condition.

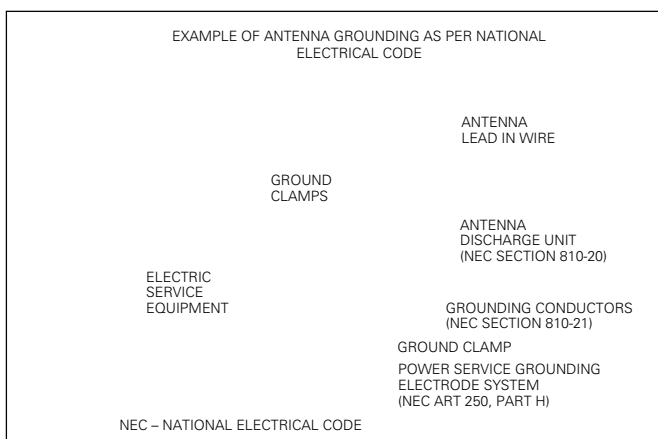

Notes:

1. Item 3 is not required except for grounded or polarized equipment.
2. Item 17 and 18 are not required except for units provided with antenna terminals.
3. Item 17 complies with UL in the U.S.A.

## Preparation section

<b>Introduction</b> .....	<b>2</b>
⚠ Before applying power .....	2
⚠ Safety precautions .....	2
Accessories .....	3
CHANNEL SPACE setting .....	3
In regard to demonstration .....	4
Special features .....	4
⚠ <b>IMPORTANT SAFEGUARDS</b> .....	<b>5</b>
<b>Contents</b> .....	<b>7</b>
<b>Region codes</b> .....	<b>8</b>
Region codes in the world .....	8
Examples of TV screen display of each video format .....	8
<b>Video formats</b> .....	<b>9</b>
Video formats of DVD discs that can be played on this unit .....	9
<b>Discs information</b> .....	<b>10</b>
Recording systems and types of playable discs .....	10
Unplayable discs .....	10
Icons on the DVD discs .....	10
<b>Handling of discs and tapes</b> .....	<b>11</b>
⚠ <b>System Connections</b> .....	<b>12</b>
AM loop antenna .....	12
FM antenna .....	12
Connection of the front speakers .....	13
Connection of the sub woofers or super woofer (optional) .....	13
Connection of the surround speaker system .....	14
Connection of the TV monitor (optional) and VCR (optional) .....	15
Connection of the MD recorder/CD recorder (optional) .....	15
<b>Controls and indicators</b> .....	<b>16</b>
Main unit (1) .....	16
Main unit (2) .....	17
DISPLAY .....	17
<b>Operation of remote control unit</b> .....	<b>18</b>
<b>SMART MENU operation/Clock adjustment</b> .....	<b>19</b>
SMART MENU operation .....	19
Clock adjustment .....	19

## Operation

<b>Let's put out some sound</b> .....	<b>21</b>
Basic use method .....	21
Changing the Tone .....	22
<b>Playback of discs</b> .....	<b>24</b>
Sequential playback from the first track or chapter .....	24
Playback from the desired track or chapter .....	25
Repeat play .....	26
A-B repeat play .....	26
Random play .....	27

<b>Program play (Using the On-screen display)(DVD/CD/VCD)</b> .....	<b>28</b>
Using the On-screen banner display .....	30
Selecting a Title .....	31
Selecting a Chapter or Track .....	31
Changing the Audio Language .....	32
Changing the Subtitle Language .....	32
Changing the Camera angle .....	33
Using IntroScan function .....	33
Using Bookmarks .....	34
Receiving broadcast station .....	35
Storing the broadcast stations (one-by-one presetting) .....	36
Using RDS function ( for Europe and U.K. only) .....	37
Playback of tapes .....	39
Normal Recording (TAPE B only) .....	40
CD Direct Recording (TAPE B only) .....	41
CD Program Recording (TAPE B only) .....	42
TAPE DUBBING .....	43
Menu playback .....	44
Hierarchical structure of VCD menus (P.B.C.) .....	44
Enjoying karaoke singing (only for some areas) .....	45
<b>Set Up functions</b> .....	<b>46</b>
Set up menu .....	46
Select Audio Language .....	47
Select Subtitle Language .....	47
Select Menu Language .....	48
Select Rating (Parental Lock) .....	48
Password .....	49
TV aspect .....	51
Dynamic Range .....	52
Digital Audio Out .....	52
<b>Setting up surround mode</b> .....	<b>53</b>
What are surround modes? .....	53
Setting up audio options .....	45
<b>SPEAKER SETUP</b> .....	<b>54</b>
<b>Timer function</b> .....	<b>58</b>
Sleep timer .....	58
Timer Play .....	59
Timer recording .....	60
AUTO POWER SAVE function .....	61

## Knowledge section

<b>Knowledge</b> .....	<b>62</b>
<b>Important items</b> .....	<b>63</b>
Maintenance .....	63
Reference .....	63
<b>In case of difficulty</b> .....	<b>64</b>
<b>Specifications</b> .....	<b>68</b>

Every player of this model has a certain region code assigned to it based on the country where the player is used. When the player is used to play back DVD discs, it can only play the DVD discs carrying the region codes matching the region code of the player.

The region code for this player is described on the rear panel of the player.

## Region codes in the world

The DVD players are given a region code according to the country or area it is marketed, as shown in the following map.

Preparations

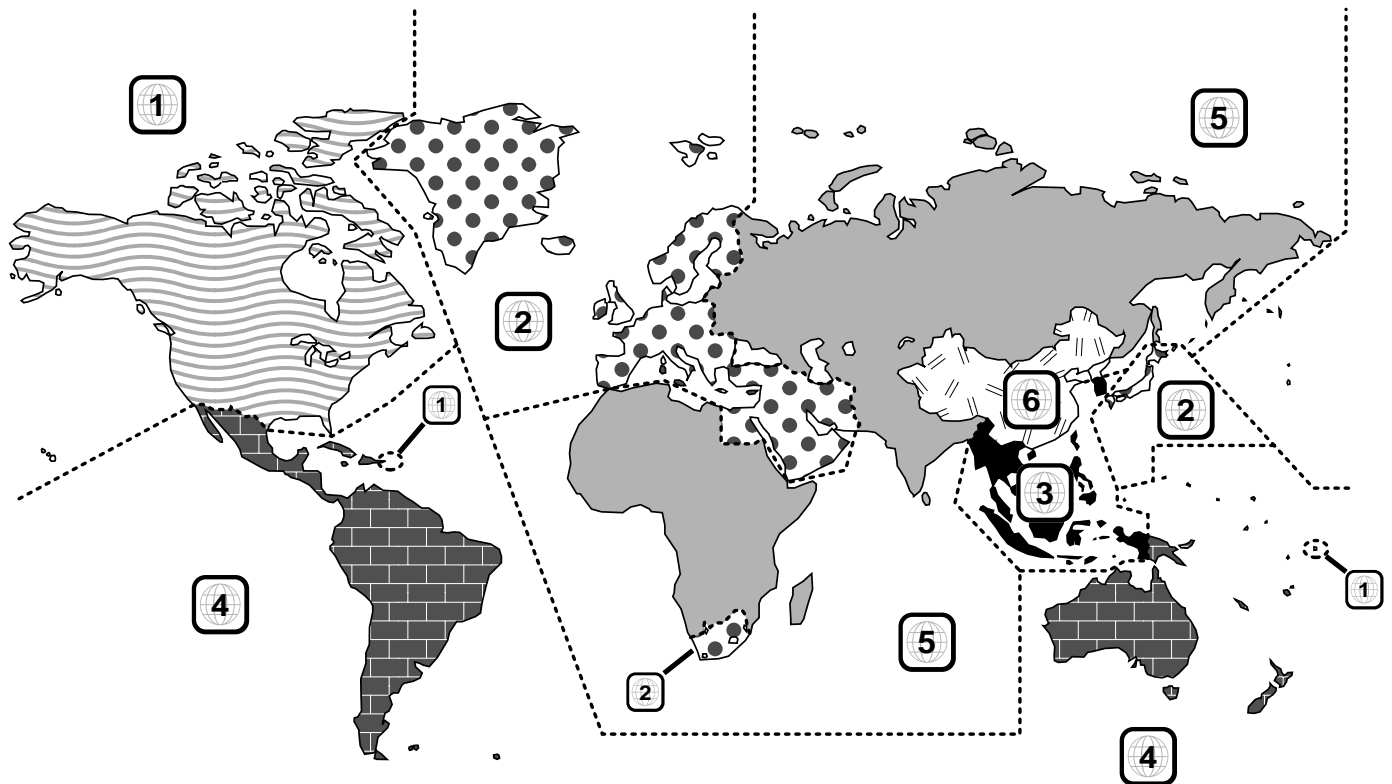

## Examples of TV screen display of each video format

### When your TV is switchable between PAL/NTSC

Try play a disc. If the picture is black and white or as shown on the right, stop playback and switch the screen display formats of this unit and the TV to another format. This will improve the played picture quality.

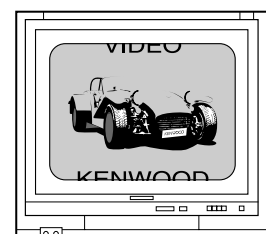
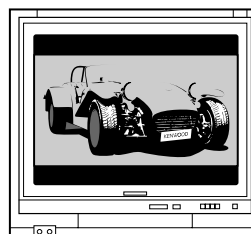

### When your TV is compatible only with the PAL format

With certain discs, the playback picture may have black spaces above and below it (as shown on the right). This is because the disc has been recorded in the NTSC format. The screen may be somewhat hard to see but this is not malfunction.

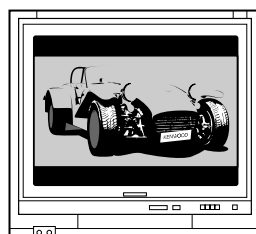

### When your TV is compatible only with the NTSC format

With certain discs, the playback picture may be cut above and below it (as shown on the right). This is because the disc has been recorded in the PAL or SECAM format. The screen may be somewhat hard to see but this is not malfunction.

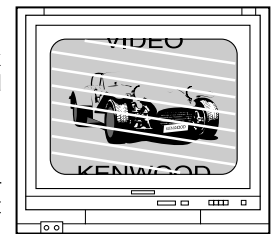



The video signals used to display TV pictures and video disc pictures are mainly based on two types of signal formats (PAL, SECAM and NTSC), which are assigned to each country or area as shown on the right. As a result, it is required to select discs according to the video format used with your TV monitor (in your country or area).

### TV formats of major countries

TV Format	Major Countries & Areas
NTSC	Japan, Taiwan, Korea, U.S.A., Canada, Mexico, Philippines, Chile, etc.
PAL	China, North Korea, U.K., Germany, Australia, New Zealand, Kuwait, Singapore, etc.
SECAM	France, Eastern Europe

## Video formats of DVD discs that can be played on this unit

Set the video formats of the DVD discs to be played on this unit as described below.



### 1 Check the video format(s) used by your TV monitor.

- Refer to the operating instructions of your TV monitor for details.

### 2 Select DVD discs or VCD discs recorded with the playable video format by referring to the following table.

- See the region code table on the bottom of this page for details on districts 1 to 6.









Your TV format	Playable Disc Formats								
	District 1	District 2-1	District 2-2	District 2-3	District 3	District 4-1	District 4-2	District 5	District 6
NTSC only	NTSC	NTSC* PAL*	NTSC	NTSC PAL*	NTSC PAL*	NTSC* PAL*	NTSC	NTSC* PAL*	NTSC PAL*
PAL only	NTSC*	NTSC PAL	NTSC*	NTSC* PAL	NTSC* PAL	NTSC PAL	NTSC*	NTSC PAL	NTSC* PAL
NTSC/PAL switchable	NTSC	NTSC PAL	NTSC	NTSC PAL	NTSC PAL	NTSC PAL	NTSC	NTSC PAL	NTSC PAL

 Normal video may not be reproduced when a disc recorded with the video format marked \* in the above table is played. See "Examples of TV screen display of each video format" for details. 

### 3 When your TV is switchable between NTSC and PAL,

- Districts 1, 2-2 and 4-2: Set the TV to **NTSC**.
- Districts 2-1, 4-1 and 5: Set the TV to **PAL**.
- Districts 2-3, 3 and 6: Set the TV according to each disc to be played.

### Region code table

	District 1	District 2-1	District 2-2	District 2-3	District 3	District 4-1	District 4-2	District 5	District 6
Area or Country Name, Region Code	North America 	U. K. and Europe 	Japan 	Middle East 	Southeast Asia 	Oceania 	South America 	Russia 	China 

### Restrictions due to difference between discs

Some DVD and VCD discs can be played only in certain playback modes according to the intentions of the software producers. As this player plays discs according to their intentions, some functions may not work as intended by you. Please be sure to read the instructions provided with each disc. When an inhibition icon is displayed on the TV screen connected to the player, it indicates that the disc being played is under the restriction as described above.

Inhibition icon



## Recording systems and types of playable discs

The system using this unit does not only play music from CD but can also play the discs listed below to offer you high-quality entertainment of video of movies and live concerts.

Playable Disc		DVD		CD		VCD
Logo mark on disc						
Disc size		 8cm	 12cm	 8cm	 12cm	 12cm
Played sides		One or both	One or both	One side only	One side only	One side only
Contents	Video + Audio	Approx. 41 min. (1 side, 1 layer) Approx. 75 min. (1 side, 2 layers) Approx. 82 min. (2 sides, 1 layer) Approx. 150 min. (2 sides, 2 layers)	Approx. 133 min. (1 side, 1 layer) Approx. 242 min. (1 side, 2 layers) Approx. 266 min. (2 sides, 1 layer) Approx. 484 min. (2 sides, 2 layers)	/		Max. 74 min.
	Audio	/				Max. 20 min., digital

## Unplayable discs

This player cannot play back any of the following discs.

- DVD-ROM discs
- DVD-R/DVD-RAM discs
- CD-ROM discs
- VSD discs
- CDV discs (Only the audio part can be reproduced.)
- CD-G/CD-EG/CD-EXTRA discs (Only the audio can be reproduced.)
- CD-R/CD-RW discs (Never attempt to play them.)
- Photo CD discs (Never attempt to play them.)

## Icons on the DVD discs

Icon	Description
	Indicates the region code where the disc can be played.
	Number of voice languages recorded with the audio function. The number in the icon indicates the number of voice languages. (Max. 8 languages)
	Number of subtitle languages recorded with the subtitle function. The number in the icon indicates the number of subtitle languages. (Max. 32 languages)
	Number of angles provided by the angle function. The number in the icon indicates the number of angles. (Max. 9 angles)
	Aspect ratios that can be selected. "LB" stands for Letter Box and "PS" for Pan/Scan. In the example on the left, the 16:9 video can be converted into letter box video.

## Disc handling precautions

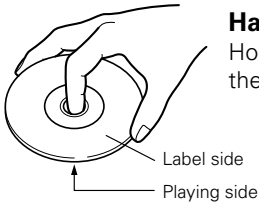

### Handling

Hold the discs so that you do not touch the playing surface.

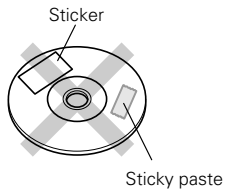

Do not attach paper or tape to either the playing side or the label side of the discs.

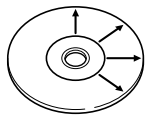

### Cleaning

If fingerprints or foreign matter become attached to the disc, lightly wipe the disc with a soft cotton cloth (or similar) from the center of the disc outwards in a radial manner.

### Storage

When a disc is not to be played for a long period of time, remove it from the player and store it in its case.

## Never play a cracked or warped disc

During playback, the disc rotates at high speed in the player. Therefore, to avoid danger, never use a cracked or deformed disc or a disc repaired with tape or adhesive agent. Please do not use discs which are not round because they may cause a malfunction.

## Disc accessories

The disc accessories (stabilizer, protection sheet, protection ring, etc.) which are marketed for improving the sound quality or protecting discs as well as the disc cleaner should not be used with this system because they may cause malfunction.

## Notes on cassette tape

### Safety tab (accidental erasure prevention tab)

After an important recording has been finished, break the safety tab, to prevent the recorded contents from being erased or recorded on accidentally.

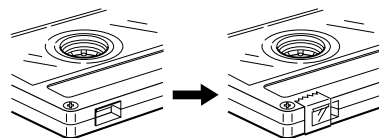
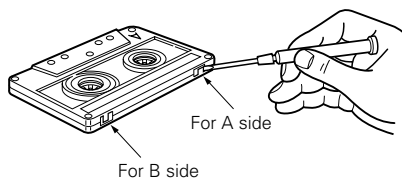

### To re-record

Apply tape only to the position where the tab has been removed.

### To store cassette tapes

Do not store the tapes in a place which is subject to direct sunlight, or near equipment that generates heat. Keep the cassette tapes away from any magnetic field.

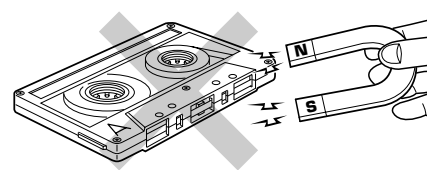

### When there is slack in the tape

In such a case, insert a pencil into the reel hole and wind the reel hub to remove the slack.

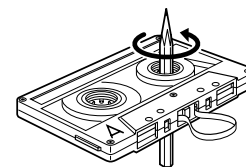

### 1. Longer tape than 90 minutes cassette tape

Since longer tape than 90 minutes cassette tape is very thin, the tape could adhere to the pinch roller or be easily cut. It is recommended that these tapes not be used with this unit to prevent possible damage.

### 2. Endless tapes

Do not use an endless tape, as this could damage the mechanism of the unit.

Make connections as shown below.  
When connecting the related system components, refer also to the instruction manuals of the related components.

**Caution:**

Do not plug in the power lead until all connections are completed.

**Caution**

Be sure to adhere followings. Or proper ventilation will be blocked causing damage or fire hazard.

- Do not place any objects impairing heat radiation onto the top of unit.
- Leave a space around the unit (from the largest outside dimension including projection) equal or greater than, shown below.

Top panel : 50 cm      Side panel : 10 cm      Back panel : 10 cm

**Malfunction of microcomputer**

If operation is not possible or erroneous display appears even though all connections have been made properly, reset the microcomputer referring to "In case of difficulty".

- 55

Preparations

## AM loop antenna

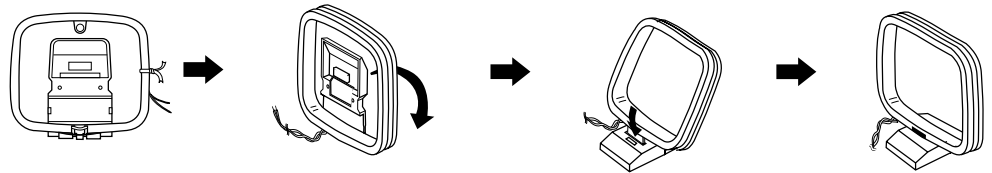

### AM loop antenna connection

The supplied antenna is for indoor use. Place it as far as possible from the main system, TV set, speaker cords and power cord, and set it to a direction which provides the best reception.

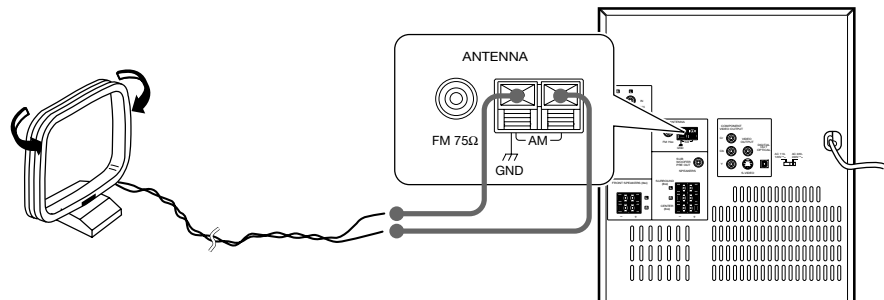

Example of the XD-DV90

## FM antenna

### FM indoor antenna connection

The accessory antenna is for temporary indoor use only. For stable signal reception we recommend using an outdoor antenna. Remove the indoor antenna if you connect one outdoors.

- 1 Connect to the antenna terminal.
- 2 Locate the position providing good reception condition.
- 3 Fix the antenna.

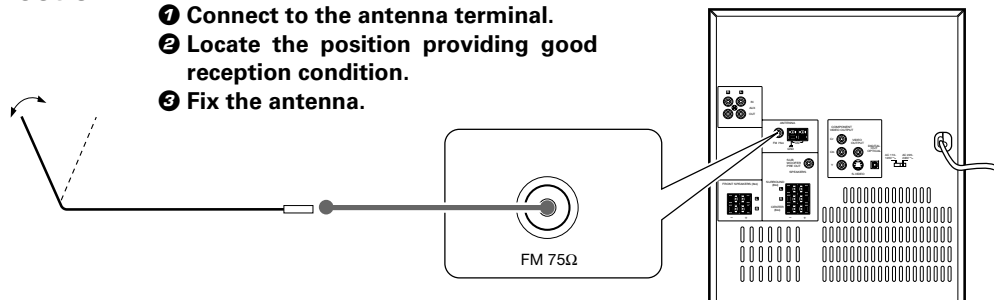

### FM outdoor antenna (commercially available)

Lead the 75 coaxial cable connected to the FM outdoor antenna into the room and connect it to the FM 75 terminal.

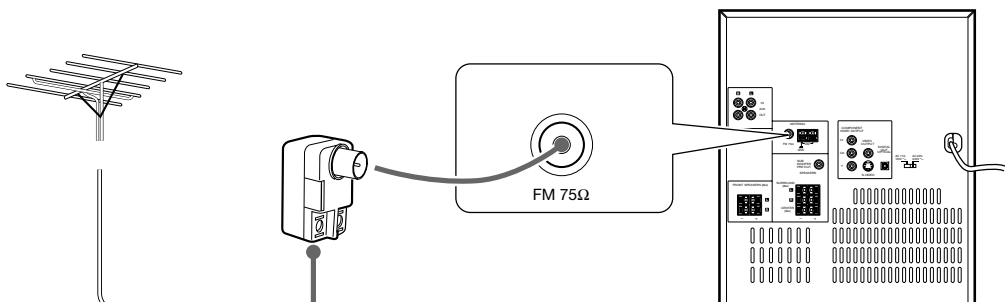

Example of the XD-DV90

## Connection of the front speakers

Do not plug the power cord into the power outlet until all of the required connections have been made.

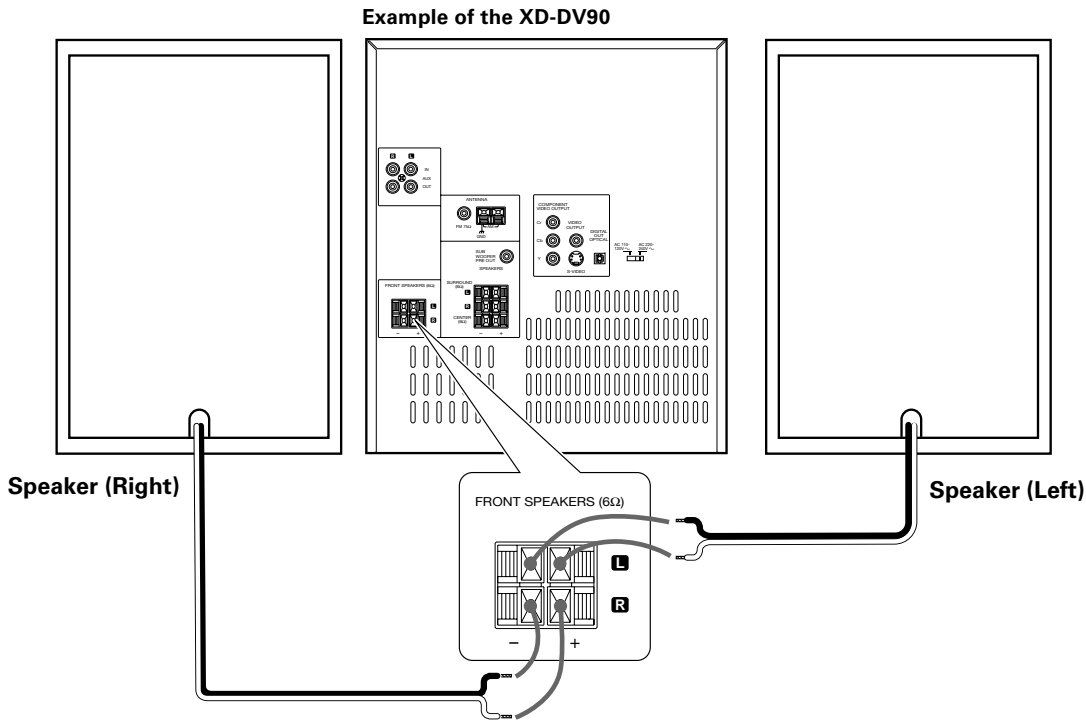

- Never short-circuit the + and – speaker cords.
- If the left and right speakers are connected inversely or if the speaker cords are connected with reversed polarity, the sound becomes unnatural with ambiguous acoustic image positioning. Be sure to connect the speakers and speaker cords correctly.

## Connection of the sub woofre or super woofer (optional)

For XD-DV70/XD-DV60/XD-DV50/XD-A850

For XD-DV90/XD-DV80

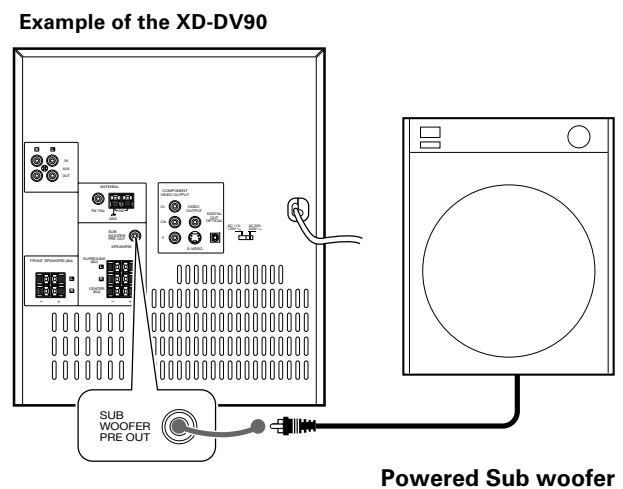
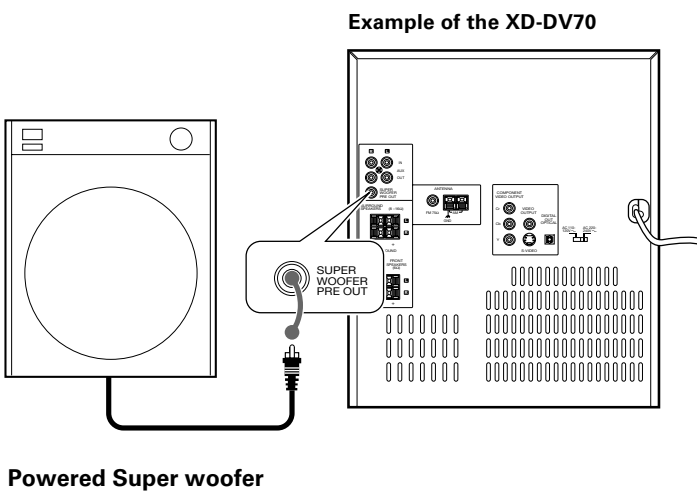

# Connection of the surround speaker system

**For XD-DV90/XD-DV80**

Preparations

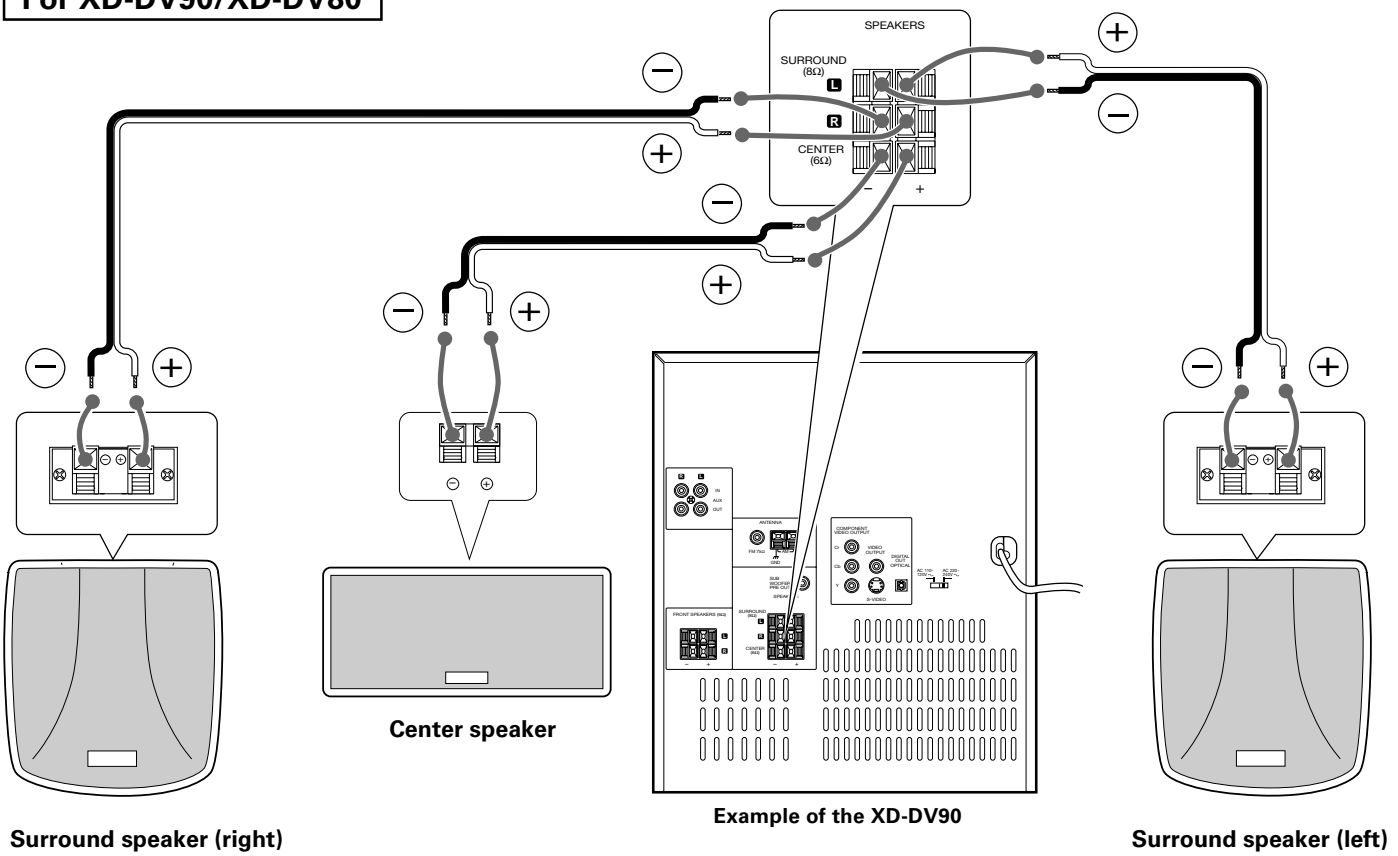

**Use of the speaker stabilizer (only for XD-DV90 and XD-DV80)**  
 Please attach this to the rear of the speaker when the center speaker or the surround speaker is not stable.

**For XD-DV70/XD-DV60/XD-DV50/XD-A850 (Optional)**

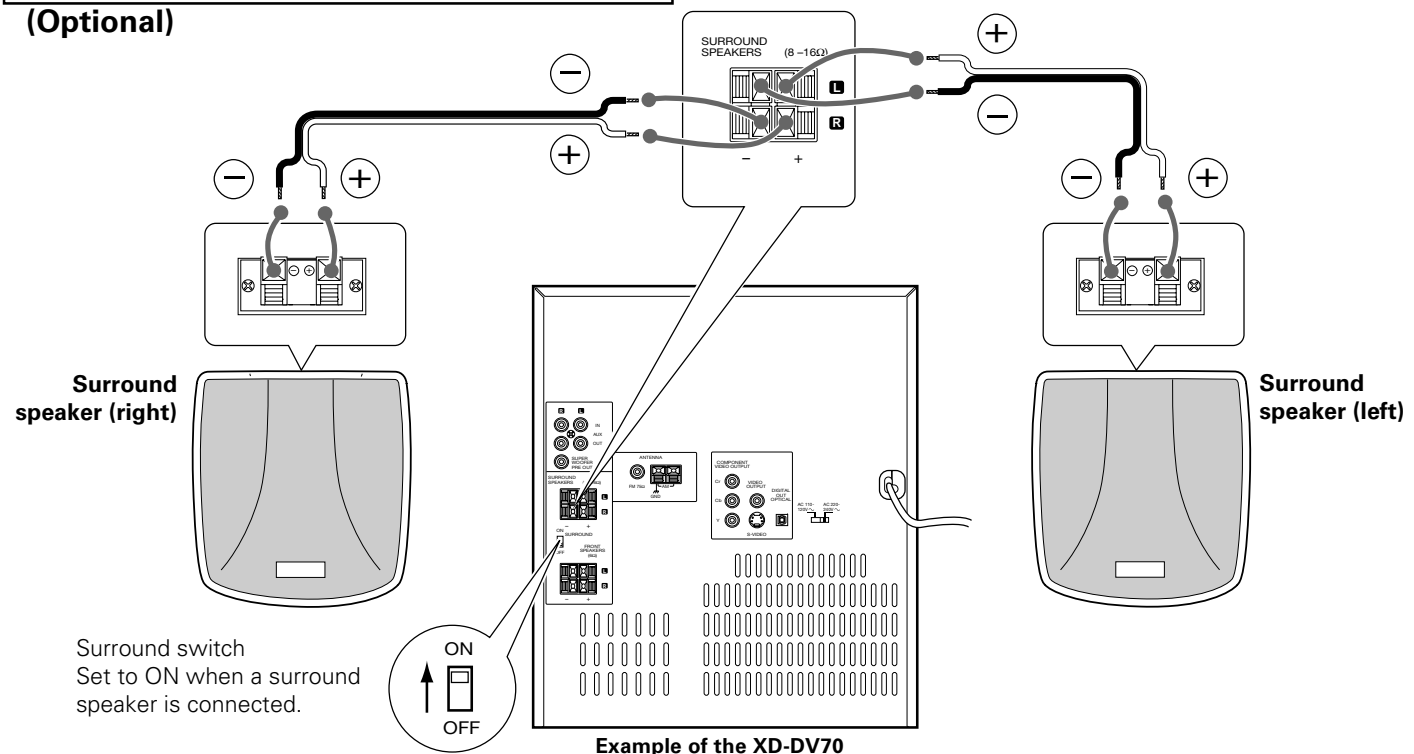

## Connection of the TV monitor (optional) and VCR (optional)

This product is compatible with the MacroVision type copy protection. Some discs contain the recording of copy inhibit signals, and the video may be disturbed when the video of such discs is recorded onto a VCR and played back.

### For XD-DV90/XD-DV80/XD-DV70/XD-DV60

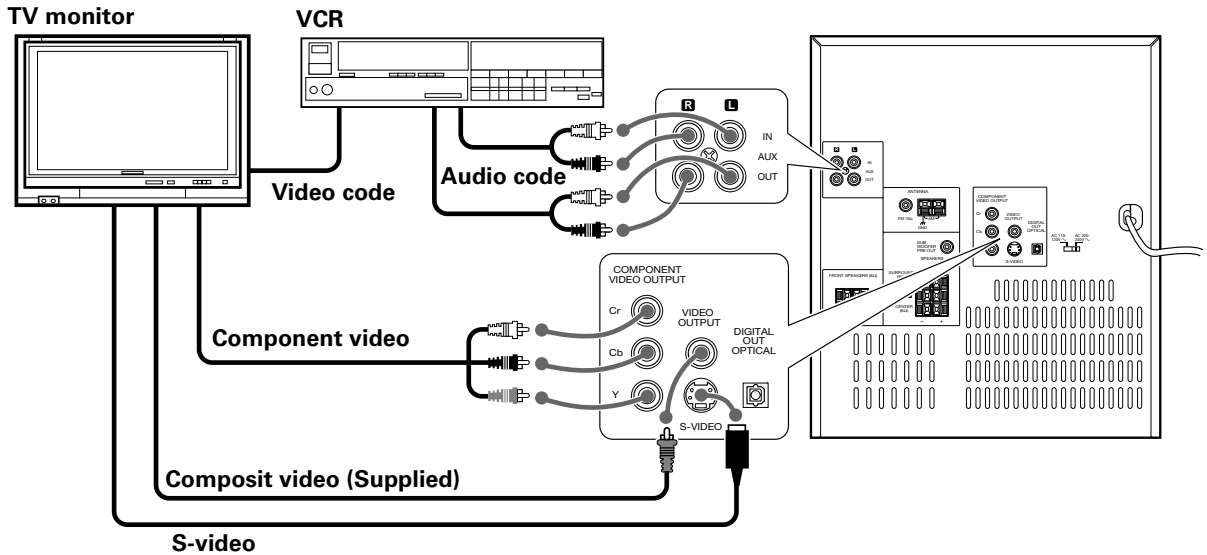

### For XD-DV50/XD-A850DV

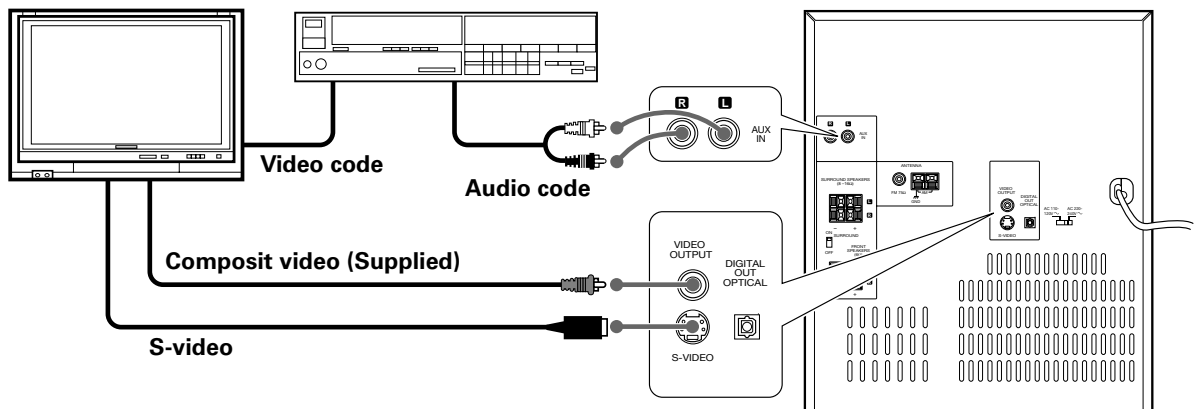

## Connection of the MD recorder/CD recorder (optional)

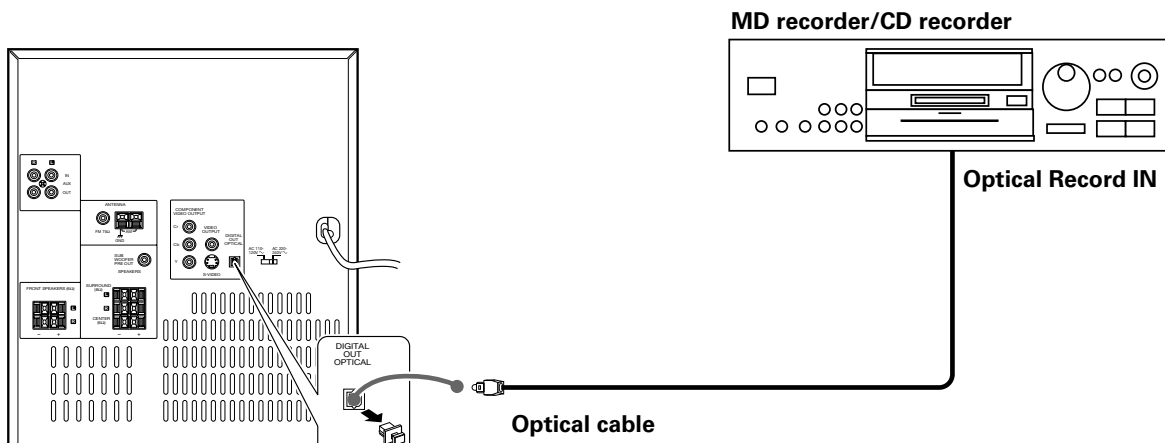

## Main unit (1)

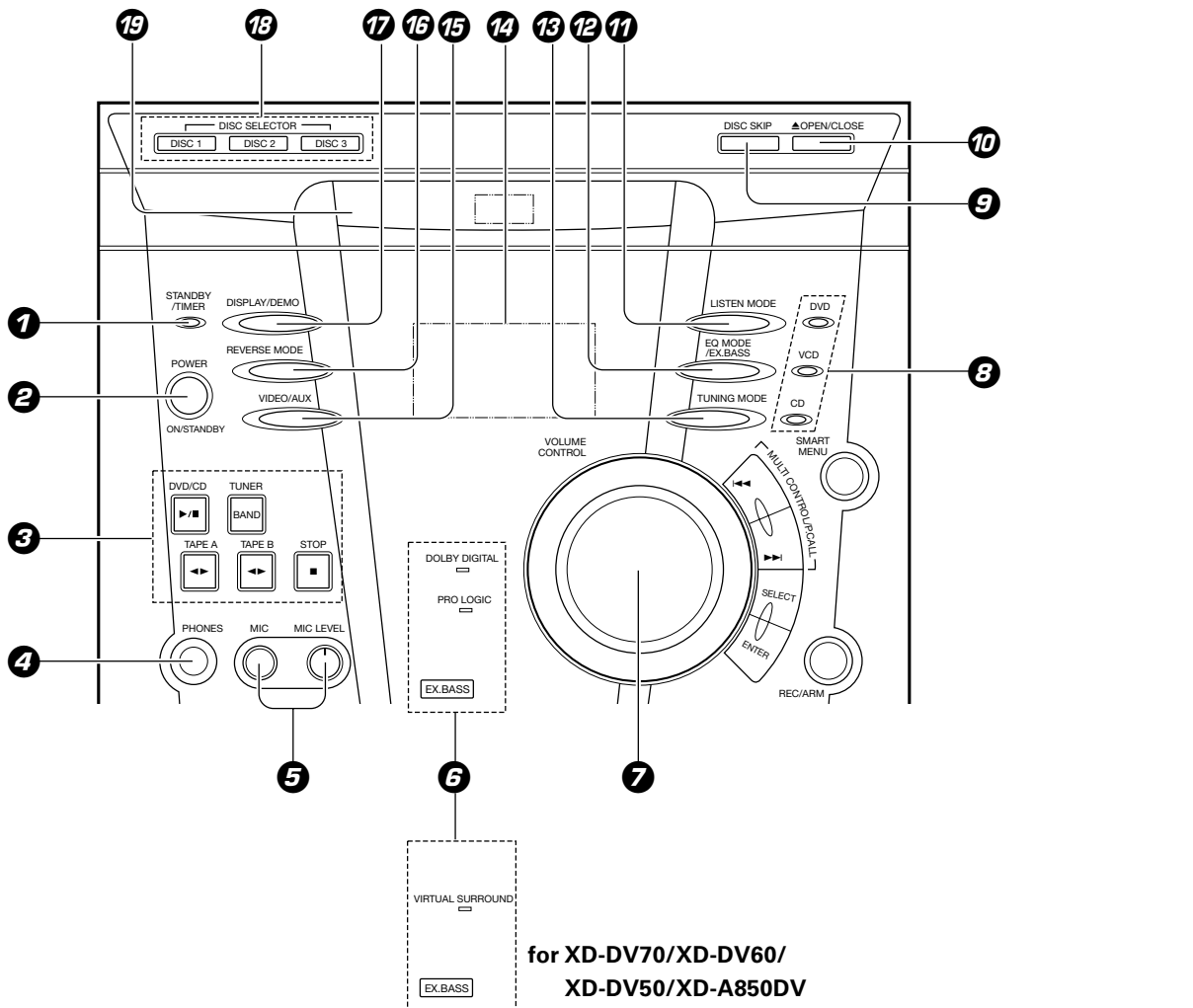

for XD-DV70/XD-DV60/  
XD-DV50/XD-A850DV

- |   |  |      |    |   |      |
|---|--|------|----|---|------|
| 1 | STANDBY/TIMER indicator  | → 16 | 8  | DVD indicator                           | → 38 |
| 2 | POWER ON/STANDBY (I/⏻) key   | → 16 |    | VCD indicator                           | → 38 |
| 3 | DVD/CD play/pause (▶/⏸) key  | → 17 |    | CD indicator                            | → 38 |
|   | TUNER /BAND key  | → 17 | 9  | DISC SKIP key                           | → 19 |
|   | TAPE A play (◀▶) key / direction key                                   | → 17 | 10 | OPEN/CLOSE (⏏) key                      | → 19 |
|   | TAPE B play (◀▶) key / direction key                                   | → 17 | 11 | LISTEN MODE key (for XD-DV90/XD-DV80)   | → 44 |
|   | STOP (■) key   | → 19 |    | VIRTUAL SORROUND key                    | → 44 |
| 4 | PHONES jack  | → 17 |    | (for XD-DV70/XD-DV60/XD-DV50/XD-A850DV) | → 44 |
| 5 | MIC jack (only for some areas)   | → 41 | 12 | EQ MODE/EX. BASS key                    | → 18 |
|   | MIC LEVEL. control knob (only for some areas)                          | → 41 | 13 | TUNING MODE key                         | → 19 |
| 6 | DOLBY DIGITAL indicator  | → 45 | 14 | Display section                         | → 14 |
|   | (for XD-DV90/XD-DV80)  | → 45 | 15 | VIDEO/AUX key                           | → 19 |
|   | PRO LOGIC indicator (for XD-DV90/XD-DV80)                              | → 48 | 16 | REVERSE MODE key                        | → 19 |
|   | VIRTUAL SURROUND indicator (for XD-DV70/<br>XD-DV60/XD-DV50/XD-A850DV) | → 48 | 17 | DISPLAY/DEMO key                        | → 19 |
|   | EX. BASS indicator   | → 18 | 18 | DISC SELECTOR keys                      | → 19 |
| 7 | VOLUME CONTROL knob  | → 17 | 19 | Disc tray                               | → 19 |

### STANDBY mode of ON/STANDBY ( I/⏻ ) switch

When the power cable plug of this unit is inserted into a receptacle, a minute current flows for memory protection. This status is referred to as the STANDBY mode, and the unit in the STANDBY mode can be turned ON from the remote control unit.



## Main unit (2<sup>1</sup>)

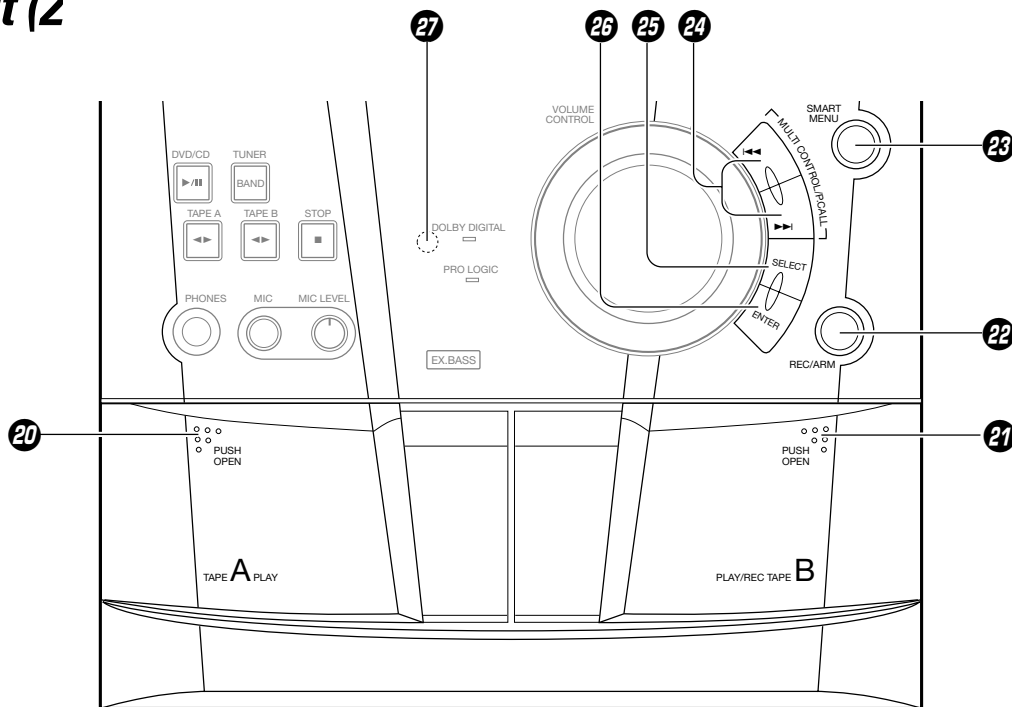

- 20** Cassette holder (TAPE A) → 38  
Press the area marked "PUSH OPEN" to load or eject a tape.
- 21** Cassette holder (TAPE B) → 38  
Press the area marked "PUSH OPEN" to load or eject a tape.
- 22** REC/ARM key → 39
- 23** SMART MENU key → 34
- 24** MULTI CONTROL/P.CALL/◀▶ key → 16
- 25** SELECT key → 16
- 26** ENTER key → 40
- 27** Remote sensor → 15

## DISPLAY

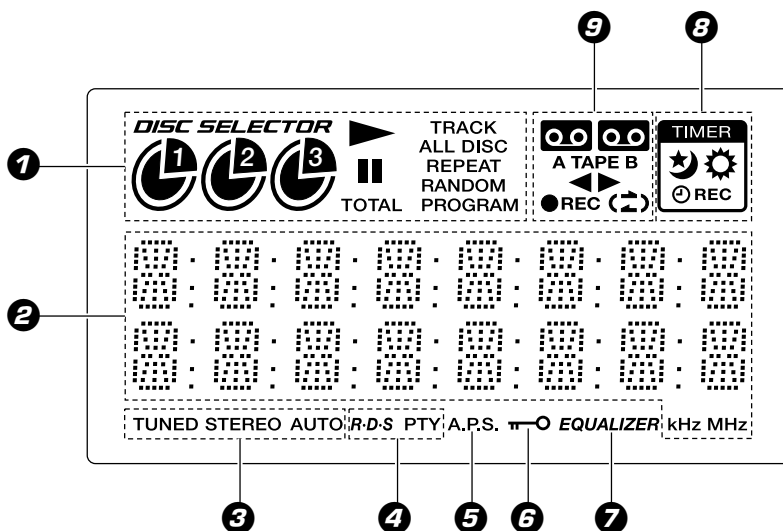

- 1** CD (DVD or VCD)-related indicators  
This section contains the CD (DVD or VCD) play and pause mode indicators.
- 2** Character information display  
Displays the input selection, frequency, volume level etc.
- 3** Tuner-related indicators
- 4** R.D.S., PTY indicators  
(Only for Europe and U.K.)
- 5** A.P.S. (Auto Power Save) indicators
- 6** PARENTAL lock indicator
- 7** EQUALIZER indicator
- 8** Timer-related indicators
- 9** Cassette deck-related indicators  
This section contains the cassette deck operation indicators. The indicated information includes the tape reverse mode and tape transport direction.

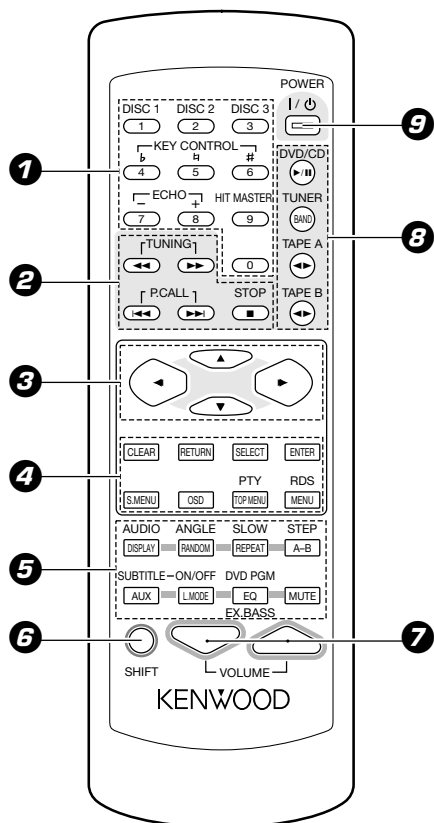

The keys on the remote control unit with the same names as on the main unit have the same function as the keys on the main unit.

- |  |  |
|--|--|
| <p><b>1</b> Numeric keys - 22</p> <p>Disc selector keys (DISC1, DISC2, DISC3)</p> <p>KARAOKE keys (only for some areas)</p> <p>KEY CONTROL keys</p> <p>ECHO keys</p> <p>HIT MASTER key</p> <p><b>2</b> Search (◀◀, ▶▶)/TUNING keys - 19</p> <p>Skip (◀◀◀, ▶▶▶) /P.CALL keys - 19</p> <p>Stop (■) key - 19</p> <p><b>3</b> Cursor Up, Down, Left and Right keys - 20</p> <p><b>4</b> CLEAR key - 19</p> <p>RETURN key - 19</p> <p>SELECT key - 19</p> <p>ENTER key - 19</p> <p>S.MENU (Smart Menu) key - 19</p> <p>OSD (On screen display) key - 19</p> <p>TOP MENU key (PTY key for only U.K. and Europe) - 19</p> | <p>MENU key (RDS key for only U.K. and Europe) - 19</p> <p><b>5</b> DISPLAY/AUDIO key - 16</p> <p>RANDOM/ANGLE key - 50</p> <p>REPEAT/SLOW key - 18</p> <p>A-B (A-B repeat)/STEP key - 38</p> <p>AUX/SUBTITLE key - 29</p> <p>L.MODE (Listen mode)/(SUBTITLE) ON/OFF key - 53</p> <p>EQ (Equalizer)/EX. BASS/DVD PGM (Program) key - 18</p> <p>MUTE key - 40</p> <p><b>6</b> SHIFT key - 17</p> <p><b>7</b> VOLUME (up/down) keys - 17</p> <p><b>8</b> DVD/CD play pause (▶/  ) key - 20</p> <p>TUNER/BAND key - 25</p> <p>TAPE A play/direction (◀▶) key - 27</p> <p>TAPE B play/direction (◀▶) key - 27</p> <p><b>9</b> POWER (I/⏻) key</p> <p>Power ON/OFF switching is executed.</p> |
|--|--|

**Model :** RC-DV90 (for U.S.A., Canada, Australia and U.S. Military)  
 RC-DV90E (for Europe and U.K.)  
 RC-DV90M (for Other countries)

**Infrared ray system**

## Use of the SHIFT key

When a key corresponding to the SHIFT function is pressed within 5 seconds of pressing the SHIFT key ("S" flashes on the display), a different function from the normal function will operate. For example, when the REPEAT (SLOW) key is pressed after the SHIFT key, SLOW operation mode will be reached. While the "S" indication is flashing, operation of the SHIFT function is possible without pressing the SHIFT key.

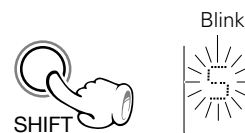

## Loading batteries

**1** Remove the cover.

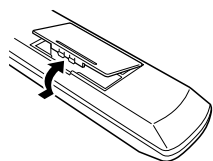

**2** Insert batteries.

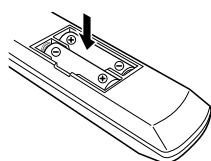

- Insert two R6/LR6 ("AA"-size) batteries following the polarity indications.
- Align the poles (+ and -) properly when inserting the batteries

**3** Close the cover.

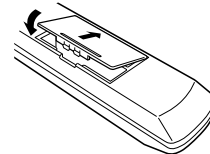

## Operation

Plug the power cord into the mains power outlet and press the on/standby (I/⏻ POWER) key of the remote control unit to turn power ON. After the power has been turned ON, press the desired key.

To turn power off, press the on/standby (I/⏻ POWER) key again.

- When pressing more than one remote control keys successively, press the keys securely by leaving an interval of 1 second or more between keys.

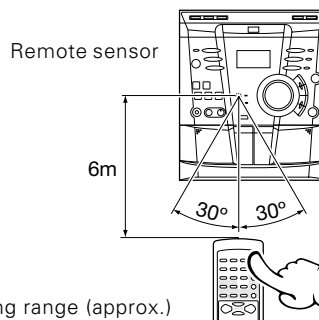

Operating range (approx.)



1. The provided batteries are intended for use in operation checking, and their service life may be short.
2. When the remote controllable distance becomes short, replace both of the batteries with new ones.
3. If direct sunlight or the light of a high-frequency fluorescent lamp (inverter type, etc.) is incident to the remote sensor, malfunction may occur. In such a case, change the installation position to avoid malfunction.

## SMART MENU operation

When one of the MULTI CONTROL keys (◀◀, ▶▶/P.CALL keys) is pressed after the SMART MENU key (S.MENU key) has been pressed, various operations can be performed while watching the display.

- SELECT key → Selects an item.
- ENTER key → Confirms the selected contents.
- RETURN key → Returns to the previous operation.

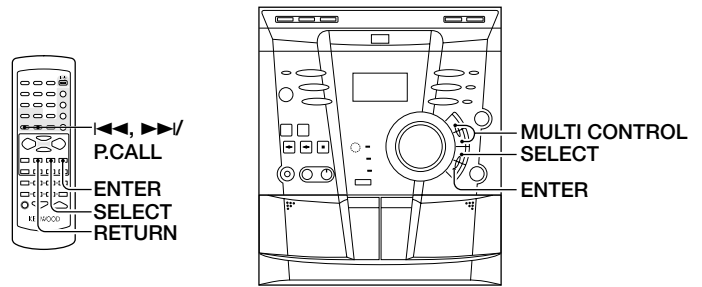

## Clock adjustment Adjust the clock before setting the timer.

### 1 Switching the power ON.

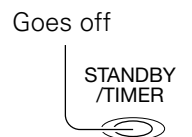
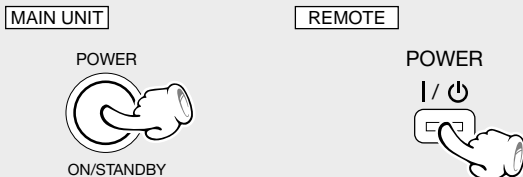

### 2 Press the SMART MENU key.

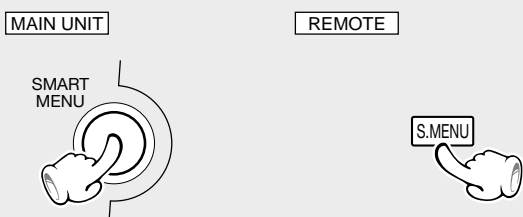

### 3 Select "CLOCK OPTION", then press the SELECT key.

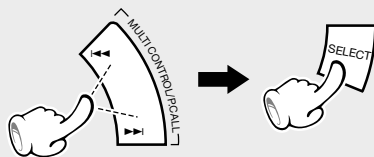

- When operating on the remote control unit, Press the ◀◀, ▶▶ keys to select "Clock Option", then press the SELECT key.

### 4 Select "ADJUST TIME", then press the SELECT key.

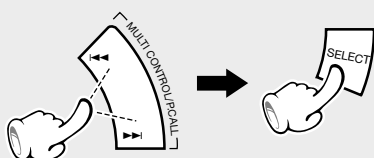

- When operating on the remote control unit, Press the ◀◀, ▶▶ keys to select "ADJUST TIME", then press the SELECT key.

This unit incorporates a clock function. Be sure to adjust the correct time before using the timer function. The time is displayed only while the power is off.

The following items can be selected by pressing the **MULTI CONTROL** keys.

- ◀ "RECORDING OPTION"
- ◀ "TAPE DUBBING"
- ◀ "AUDIO OPTION"
- ▶ "CLOCK OPTION"

The following items can be selected by pressing the **MULTI CONTROL** keys.

- ◀ "SLEEP TIMER"
- ▶ "ADJUST TIME"
- ◀ "TIMER PLAY"
- ◀ "AUTO POWER SAVE"

*Continued on next page...*

### 5 Select "TIME 24H" or "TIME 12H", then press the SELECT key.

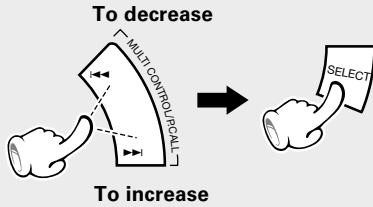

- When operating on the remote control unit, Press the ◀◀, ▶▶ keys to select "TIME 24H" or "TIME 12H", then press the SELECT key.

### 6 Enter the figure of hour, then press the SELECT key.

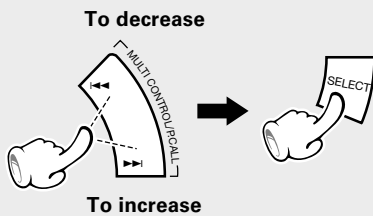

- When operating remote control unit, Press the Cursor ◀◀, ▶▶ keys to select figure of hour, then press the SELECT key.

### 7 Enter the figure of minute, then press the ENTER key.

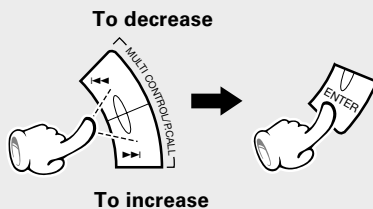

- When operating remote control unit, Press the Cursor ◀◀, ▶▶ keys to select figure of minut, then press the ENTER key.

The following items can be selected by pressing the **MULTI CONTROL** keys.

- ◀ "TIME 24H"
- ▶ "TIME 12H"

23:00

Example of the 24 hour display.

11:00

Example of the 12 hour display.

- The time display starts to blink.

#### "TIME 24H" mode

Blink

#### "TIME 12H" mode

Blink

- The minute display starts to blink.

#### "TIME 24H" mode

Blink

#### "TIME 12H" mode

Blink

## Display the clock

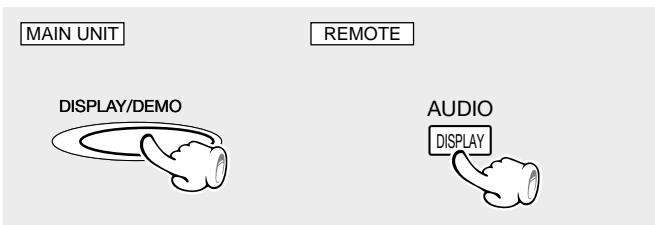

- When the **DISPLAY/DEMO** key is pressed while the power is off, the present time will be displayed for about 5 seconds.

## In regard to input switching between VIDEO and AUX

When the VIDEO/AUX key is pressed, the input is switched to the AUX terminal at the rear of the unit. Each time the VIDEO/AUX key is pressed for more than 2 seconds, the display is switched between VIDEO and AUX.



## Basic use method

### 1 Selecting the desired input

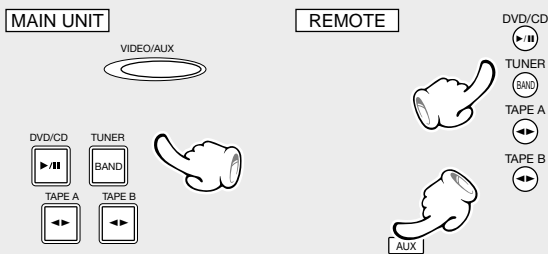

- When one of the keys on the left is pressed while the power is off, the power will be switched on automatically and the input will be selected.
- When a disc is set in the disc tray and the **DVD/CD** key is pressed, disc playback will start automatically. Trays without a disc will be skipped.
- When a cassette is set in the holder and the **TAPE** key is pressed, tape playback will start.

The mark of the disk being played flashes.

### 2 Volume adjustment

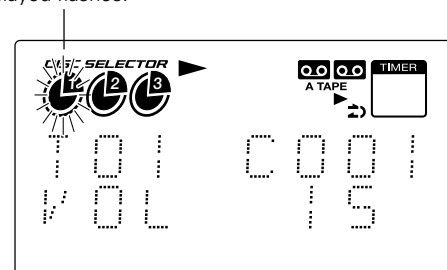
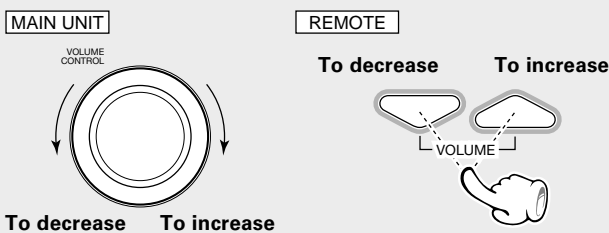

An example of DVD

## Muting the sound temporarily



- Press **MUTE** key.
- Press again to resume the original volume.
- The sound muting is also cancelled when the volume is controlled.

## Listening through headphone

Insert the headphone plug into the **PHONES** jack.

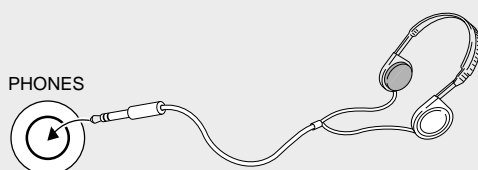

- The sounds from all speakers are cut off.

This unit offers various surround modes, but it switches automatically to stereo mode when headphones are connected. For listening via the speakers, disconnect the headphones plug and set the listening mode again. (See page 52.)

## Changing the Tone

This unit is equipped with various preset equalizers and three custom equalizers, which can be preset freely, so that various sounds can be enjoyed. In addition, it has an EX-BASS function for one-touch bass correction.

### Extra Bass

When the EX. BASS function is switched on, richer bass tones can be reproduced.

**Press and hold the EX. BASS key for mor than 2 seconds.**

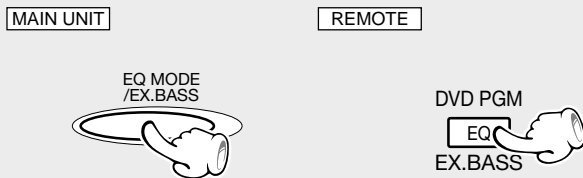

Each press switches the EX-BASS on or off.

- ➊ EX-BASS ON
- ➋ EX-BASS OFF

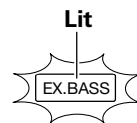

- Switching is not possible when the **DOLBY DIGITAL** indicator is lit. (Only XD-DV90/VD-DV80)  
This does not function when the listening mode is DOLBY DIGITAL. (See page 52)

### Selecting the desired Tone

The desired sound can be selected from five preset equalizers and three custom equalizers.

**Press the EQ MODE (EQ) key.**

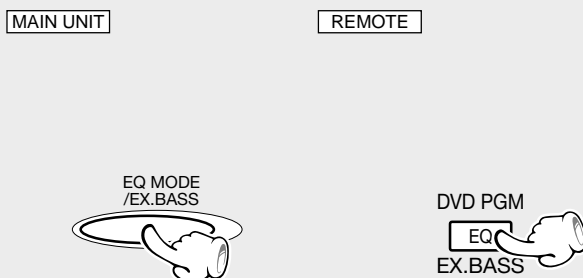

Each press switches the mode.

- ➊ ROCK
  - ➋ DISCO
  - ➌ POP
  - ➍ JAZZ
  - ➎ CLASSIC
  - ➏ EQ 1
  - ➐ EQ 2
  - ➑ EQ 3
  - ➒ EQ OFF
- ➊ to ➎ are grouped as **Preset equalizer modes**.  
➏ to ➒ are grouped as **Custom equalizer modes**.

For use of a CUSTOM equalizer effect, the parameters must be set in advance.

**To set the CUSTOM EQ.**

**1 Press the SMART MENU key.**

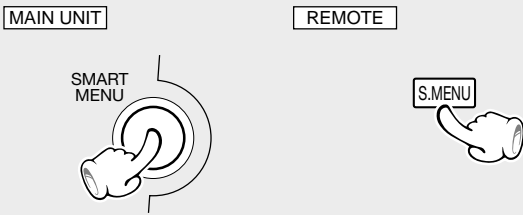

**2 Select "AUDIO OPTION", then press the SELECT key.**

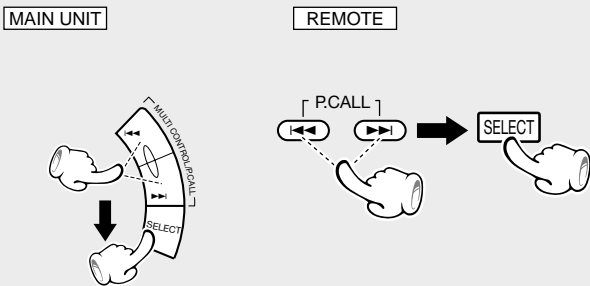

**3 Select "CUSTOM EQ 1", then press the SELECT key.**

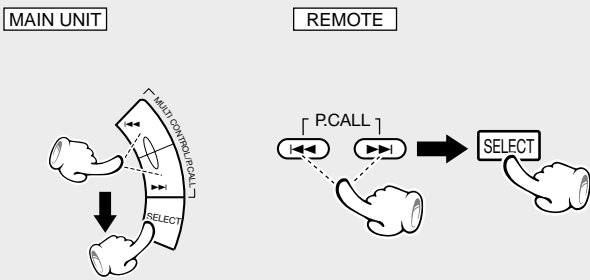

**4 Select desired BASS level ("BASS -8" to "BASS +8"), then press the SELECT key.**

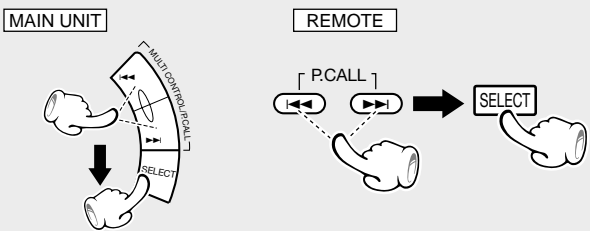

**5 Select desired MID level ("MID -8" to "MID +8"), then press the SELECT key.**

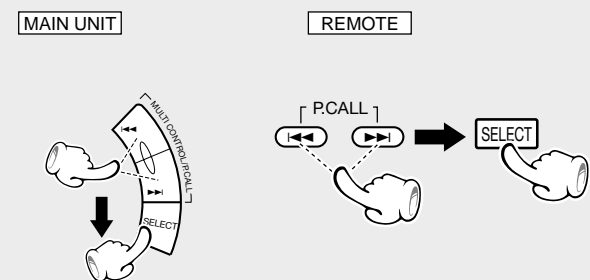

The following items can be selected by pressing the **MULTI CONTROL** keys.

- "RECORDING OPTION"
- "TAPE DUBBING"
- "AUDIO OPTION"
- "CLOCK OPTION"

The following items can be selected by pressing the **MULTI CONTROL** keys or cursor keys on the remote.

- "CUSTOM EQ 1"
- "CUSTOM EQ 2"
- "CUSTOM EQ 3"
- "BALANCE"
- "VIDEO/AUX INPUT LEVEL"

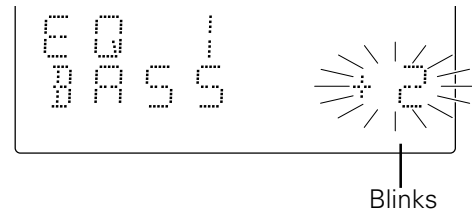

**6 Select desired HIGH level ("HIGH -8" to "HIGH +8"), then press the ENTER key.**

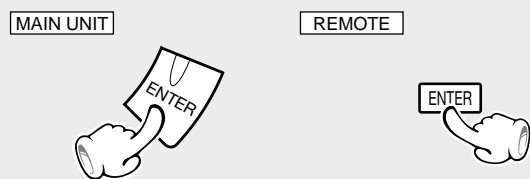

The same setting as with {1} to {6} also is possible for CUSTOM EQ 2 and CUSTOM EQ 3.

## Sequential playback from the first track or chapter

### 1 Open the tray and place a disc



### 2 Close the tray

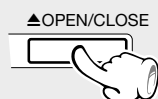

### 3 Press the DVD/CD (▶/⏸) key



- Each press pauses and plays the disc alternately.

- The tray opens when the key is pressed and closes when the key is pressed again.

The label must be on top.

Disc number

- Depending on the disc, playback may start automatically.

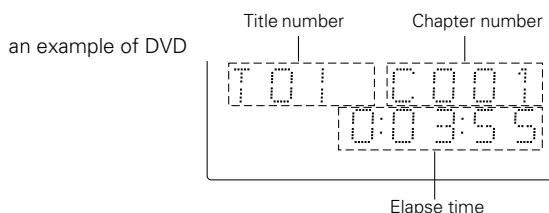

#### When a Disc Menu appears on the screen (DVD or VCD)

In case of interactive DVDs, a Disc Menu appears on the screen. Then press **ENTER** to select specific menu you want to play by using Cursor keys.

The operation method may differ according to the disc.

#### DVD CD VCD Select a Different Disc

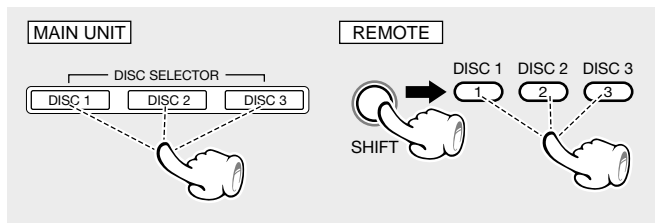

#### To change the disc of another tray during playback, do the following.

- Press the **OPEN/CLOSE** key.
  - Set the disc.
  - Press the **OPEN/CLOSE** key to close the tray.
- The disc being played back remains as it is, while the other discs can be exchanged.



#### DVD CD VCD To pause playback

MAIN UNIT

REMOTE

- Each press pauses and plays the disc alternately.
- With some VCD discs, return to the menu screen is done with pause at the time of P.B.C. ON.

#### DVD CD VCD To stop playback

MAIN UNIT

REMOTE

- Press the **■** key twice to cancel playback.

### RESUME playback

When playback has been stopped while watching a movie, it may be desired to restart playback from the stopped part. This unit memorizes the stop position even when the power is switched off, and when the unit is switched on again, it is possible to continue playback from the previous stop position. This function is called the RESUME function. When the **■** key has been pressed once during playback to stop the playback, and then playback is started again, play will start from the point where the playback had been stopped. When the **■** key is pressed again during stop, the RESUME function is cancelled. RESUME is cancelled when 5 minutes have passed in RESUME status.



# Playback from the desired track or chapter

## DVD CD VCD Skipping tracks or chapters

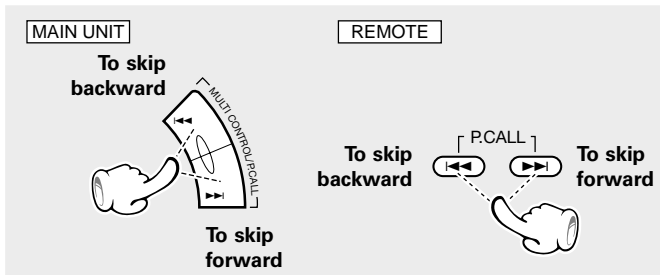

- The chapter (or track) in the direction of the key pressed is skipped, and the selected chapter (or track) will be played from the beginning.
- When the I◀◀ key is pressed once during playback, the chapter (or track) being played will be played from the beginning.
- When P.B.C. (see page 00) is switched ON at the time of VCD playback, there will be no return to the preceding track.

## High-speed search in forward and reverse directions

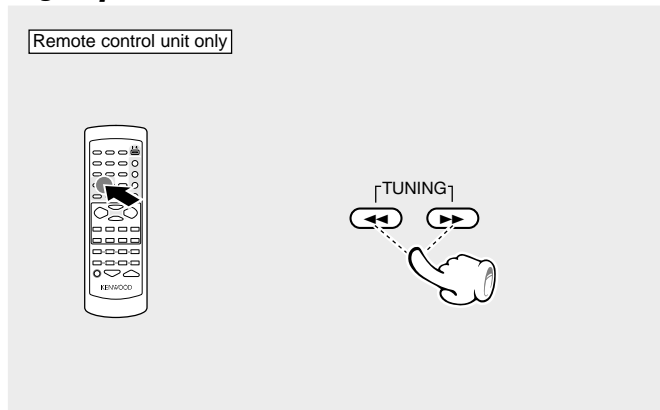

- During playback, press the ◀◀ or ▶▶ key
- Each press switches the searching speed.

### DVD (At the time of DVD playback)

- ① F. SEARCH 1 / R. SEARCH 1
- ② F. SEARCH 2 / R. SEARCH 2
- ③ F. SEARCH 3 / R. SEARCH 3
- ④ F. SEARCH 4 / R. SEARCH 4

### CD VCD (At the time of CD/VCD playback)

- ① F. SEARCH 1 / R. SEARCH 1
- ② F. SEARCH 2 / R. SEARCH 2
- ③ F. SEARCH 3 / R. SEARCH 3

- Press the ▶/|| key at any time to resume normal playback.

## DVD VCD Step Motion playback

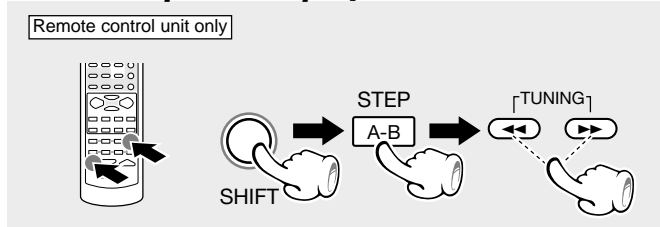

Press the **SHIFT** key and then press the **STEP** key within 5 seconds. Press the ◀◀ or ▶▶ key.

- Each time the ◀◀ or ▶▶ key is pressed, a new frame will appear.
- Press ▶/|| key to resume normal playback.

## DVD VCD Slow motion playback

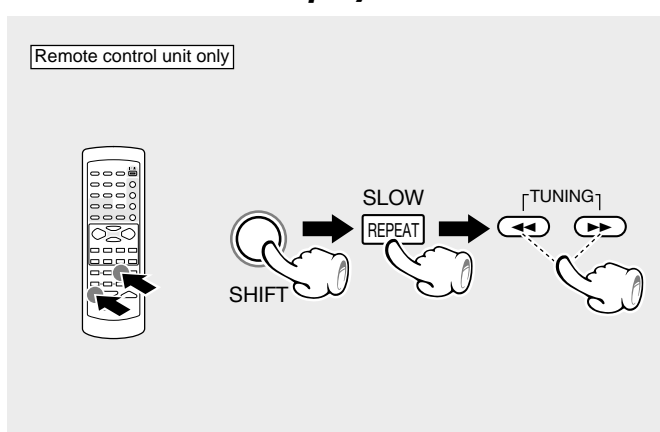

Press the **SHIFT** key and then press the **SLOW** key within 5 seconds. Press the ◀◀ or ▶▶ key.

- Each press switches the searching speed.

### DVD (At the time of DVD playback)

- ① F. SLOW 1/16 / R. SLOW 1/16
- ② F. SLOW 1/8 / R. SLOW 1/8
- ③ F. SLOW 1/4 / R. SLOW 1/4
- ④ F. SLOW 1/2 / R. SLOW 1/2

### CD VCD (At the time of CD/VCD playback)

- ① F. SLOW 1/8 / R. SLOW 1/8
- ② F. SLOW 1/4 / R. SLOW 1/4
- ③ F. SLOW 1/2 / R. SLOW 1/2



- Press the ▶/|| key at any time to resume normal playback.

## DVD CD VCD Repeat play

Desired tracks or all discs can be played back repeatedly.

- All Disc – Repeat all discs.
- 1 Disc– Repeat the disc that is playing.
- Title – Repeat the title that is playing.
- Chapter – Repeat the chapter that is playing.
- Track – Repeat the track that is playing.

**1** During playback, press REPEAT on the remote.



**LED display**

TRACK REPEAT indicator  
ALL DISC REPEAT indicator REPEAT indicator



Each press of the key switches the REPEAT mode.

**At the time of DVD playback**

- 1 Repeat All Discs
- 2 Repeat 1 Disc
- 3 Repeat Title
- 4 Repeat Chapter
- 5 Repeat Off

**At the time of CD and VCD playback**

- 1 Repeat All Discs
- 2 Repeat 1 Disc
- 3 Repeat Track
- 4 Repeat Off

- To cancel repeat playback, press the REPEAT key and select "Repeat off".

At the time of VCD playback, this function operates only when P.B.C. is OFF.

## DVD CD VCD A-B Repeat play

The A-B repeat function lets you mark a segment to repeat between the beginning "A" and the end "B" of the segment you want to replay.

**1** Press the A-B key on the remote when you want to choose a scene (sound) as the beginning point.

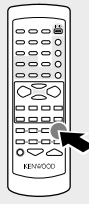
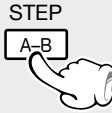



The Repeat A- display appears

**Blink**

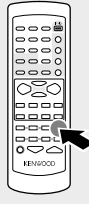
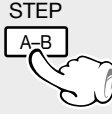

**2** Press the A-B key again to choose a scene (sound) as the end point.

The Repeat A-B display appears



- To cancel A-B Repeat playback, press the A-B key and select "Repeat off".

**CD VCD** *Random play*

The tracks of the disc are played in random order.

**1** During playback or stop mode, press **RANDOM** on the remote.

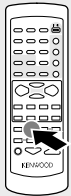

The Random Play display appears

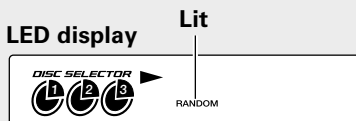

Each time you press **RANDOM** on the remote, random play would be on and off.

- ① "Random Play"
- ② "Standard Play"

The Standard Play display appears when random is off.



- The menu is switched off when no operation is performed for about 3 seconds.

- When the **RANDOM** key is pressed during playback, the tracks of the disc being played will be selected in random order for playback.
- After all tracks of a disc have been played in random order, playback will stop. (Random mode will be cancelled.)

- When the **RANDOM** key is pressed during random playback, return to normal playback will be made from that track on.
- When All Disc Repeat is selected and the **RANDOM** key is pressed, random playback will be performed for the disc being played, and then the unit will shift to random playback of the next disc. When a DVD disc is set at this time, the random mode will be cancelled when the unit shifts to the DVD disc, and return to normal playback will be made. The random function does not operate with DVD discs.

## Program Edit

- During stop mode, press the SHIFT key on the remote, then press the DVD PGM key on the remote.

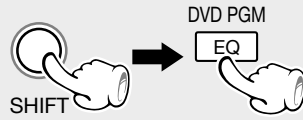
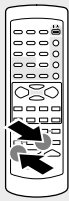

- Select desired disc number, title, chapter or track by Press Cursor up/down (▲/▼) keys or numeric keys.

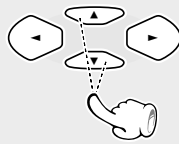

- Press the ENTER key.



- Select Add icon on the screen to register selected value onto Playlist, then press the ENTER key.



- You can select maximum 32 values by repeating step 2 - 4.
- Press the PLAY key to start playback.

Program edit display appears.

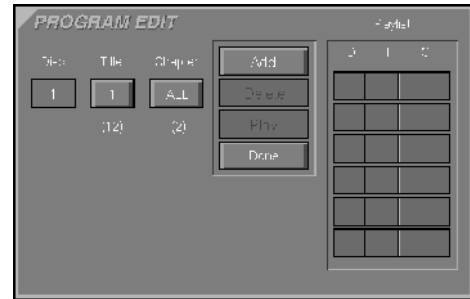

(An example of DVD program edit menu)

- : (blue) Selected icon
- : An icon which can be selected
- : An icon which presently can not be selected



- When you don't add values onto "Playlist" and return to play mode, select Done icon and press ENTER key on the remote.
- To return to standard play, press SHIFT key, then press DVD PGM key on the remote.
- While a disc is playing, press SHIFT key, then press DVD PGM key on the remote to start Program play.
- When the Done button is selected and the ENTER key is pressed, the program input mode is cancelled.

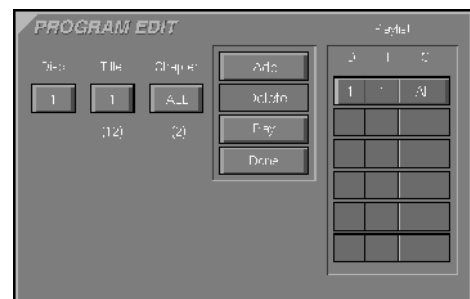

## Delete Program

- Use the Cursor up/down (▲/▼) keys to select the column to be deleted from the "Play list". (The color of the column where the Cursor is located will change.)

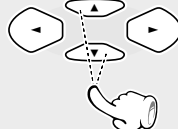

- Press the Cursor left (◀) key, use the Cursor up/down keys to move the Cursor to the Delete icon, and press the ENTER key.



Selected chapter (track) deletes

It is possible to delete all programs by one of the following methods.

- Press the OPEN/CLOSE key to open the tray  
or
- Switch off the power.

## Insert chapter or track

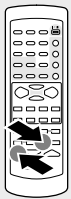

- 1 Press the SHIFT key on the remote, then press the DVD PGM key on the remote.

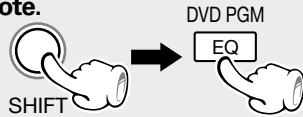

- 2 Select specific title/chapter or track to insert by Press Cursor up/down (▲/▼) keys or numeric keys.

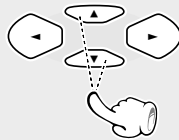

- 3 Move the cursor with the Cursor right (▶) key to the "Play list" and select the column to be added with the Cursor up/down (▲/▼) keys.



(The color of the column where the Cursor is located will change.)



- 4 Move the cursor with the Cursor left (◀) key to the Insert icon and press the ENTER key.

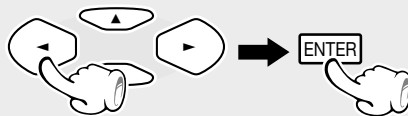

The new chapter or track will be inserted before (above) the selected column.

Program edit display appears.

(An example of DVD program edit menu)

The on-screen Banner Display contains many playback features. To see the Banner Display, press **OSD** key on the remote while a disc is playing. Use the Cursor (Up/Down/Left/Right) keys on the remote to move through the different features in the Banner Display. Each feature is illustrated with an icon.

① During playback, press the OSD key on the remote.



② Press the Cursor left/right (◀/▶) keys to highlight a banner display icon.

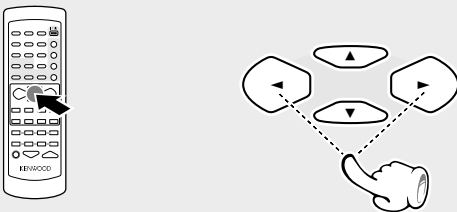

③ Press the ENTER key.



## When playing a DVD

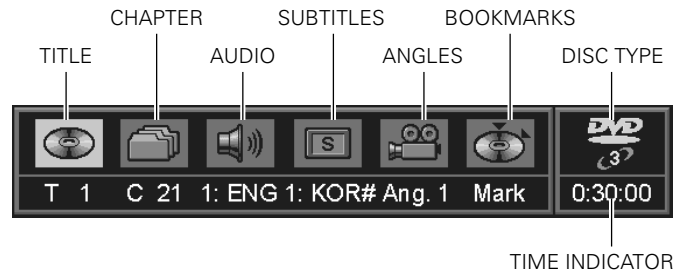

## When playing a CD

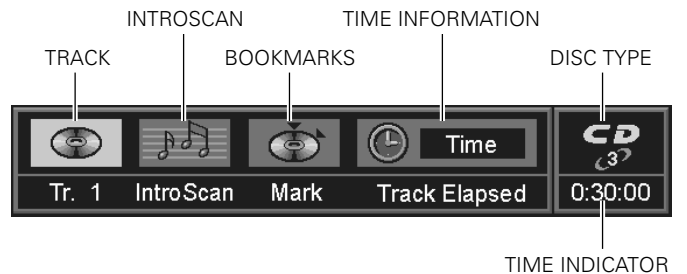

Switch the CD time indicator as follows.

- ① Select the time information with the cursor key.
- ② Each time the ENTER key is pressed, the time indicator changes as follows.

- ① **Track Elapsed** (elapsed time of the track being played)
- ② **Track Remain** (remaining time of the track being played)
- ③ **Disc Elapsed** (elapsed time of the disc being played)
- ④ **Disc Remain** (remaining time of the disc being played)

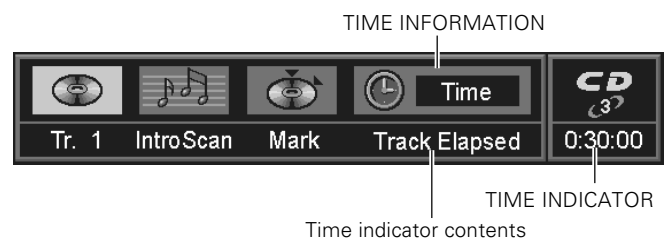

## To display disappear from the screen

Press the OSD key or CLEAR key

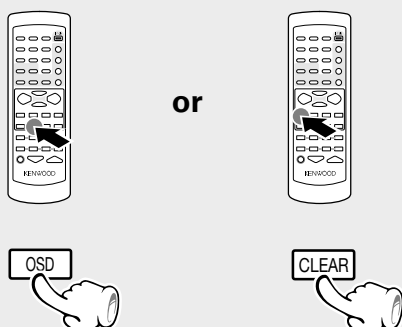

- You can only access the banner display when you're playing a disc.
- The banner display feature are only available if the disc was created with that particular feature (i.e., if you select the Subtitle icon, you won't be able to change the subtitle language unless the author of the disc created the disc with subtitles).
- The invalid symbol appears on the screen when you press a key that doesn't have any function. If one of the icons is "grayed out," the banner display feature isn't available for the disc you're playing.

## DVD Selecting a Title

Some discs contain more than one title. For example, there might be four movies on one disc (each movie might be considered a title).

- ① During playback, press the OSD key on the remote.



- ② Press the Cursor left/right (◀/▶) keys until the TITLE icon is highlighted.

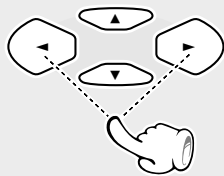

- ③ Press the ENTER key. ("T\_" appears)



- ④ Use the ◀◀ / ▶▶ keys or the numeric keys to enter the title number.

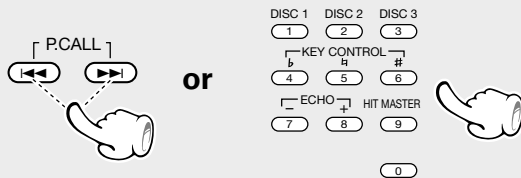

When you enter a one-digit Title number, you may have to press ENTER on the remote after pressing the numeric key on the remote. Otherwise press 0 first and the other value. Then play starts. This varies depending on number of Title within the disc you're playing.



Some discs only have one title.

## DVD CD Selecting a Chapter or Track

Because DVD discs use digital technology, a title can be divided into individual chapters (similar to tracks on a CD). You can skip a specific chapter by using the Chapter section in the Banner Display.

- ① During playback, press the OSD key on the remote.



- ② Press the Cursor left/right (◀/▶) keys until the CHAPTER or TRACK icon is highlighted.

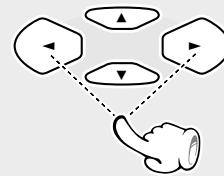

- ③ Press the ENTER key. ("C\_" or "Tr\_" appears)



- ④ Use the ◀◀ / ▶▶ keys or the numeric keys to enter the chapter or title number.

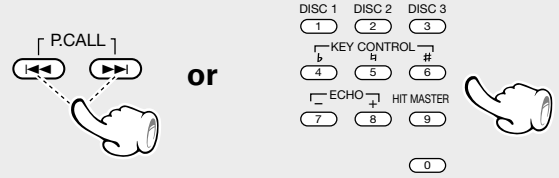

When you enter a one-digit chapter or title number, you may have to press ENTER on the remote after pressing the numeric key on the remote. Otherwise press 0 first and the other value. Then play starts. This varies depending on number of chapter or track within the disc you're playing.



The Chapter feature won't work if the disc isn't formatted with separate chapters.

## DVD Changing the Audio Language

If the disc was created with different language tracks, you can use the Banner Display to temporarily change the DVD player's Audio setting.

### Using the on-screen banner display



- 1 During playback, press the OSD key on the remote.



- 2 Press the Cursor left/right (◀/▶) keys until the AUDIO icon is highlighted.

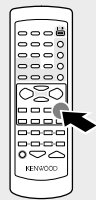
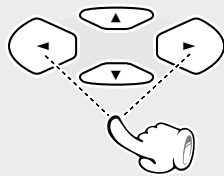

- 3 Press the ENTER key.



The audio menu appears



- 4 Select the audio language with press the ENTER key.

- The menu is switched off when no operation is performed for about 3 seconds.

### Using the AUDIO key on the remote

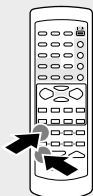

- 1 During playback, press the SHIFT key, then press the AUDIO key on the remote.

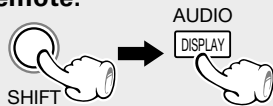

- 2 Select the audio language with press the ENTER key or AUDIO key.

- The menu is switched off when no operation is performed for about 3 seconds.



1. The language feature only works if the disc was created with multiple audio tracks.
2. When you chose an audio language from the Banner Display, you only override the audio language setting in the DVD Player's main menu (in the Language Preferences menu within Setup menu) temporarily.

## DVD Changing the Subtitle Language

You can change the Subtitle language while you're watching a disc (but only if the disc was created with subtitles).

### Using the on-screen banner display



- 1 During playback, press the OSD key on the remote.



- 2 Press the Cursor left/right (◀/▶) keys until the SUBTITLE icon is highlighted.

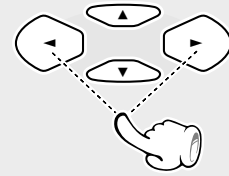

- 3 Press the ENTER key.



Displayed when SUB TITLE is ON

The subtitle menu appears



- 4 Select the subtitle language with press the ENTER key.
- 5 Press the SUB TITLE ON/OFF key to sub title ON or OFF.

- The menu is switched off when no operation is performed for about 3 seconds.

### Using the SUB TITLE key on the remote

- 1 During playback, press the SHIFT key, then press the SUB TITLE key on the remote

- 2 Select the subtitle language with press the ENTER key or SUB TITLE key.

- 3 When the SUB TITLE ON/OFF key is pressed, subtitles will be displayed. Switching between display of subtitles and no display of subtitles is done each time the key is pressed.

Displayed when SUB TITLE is ON



1. The subtitle feature only works if the disc was created with multiple audio tracks.



## DVD Changing the Camera angle

Some disc contains multiple angles particular scene or sequence. If the disc only has one angle, this feature won't work.

### Using the on-screen banner display



- 1 During playback, press the OSD key on the remote.



- 2 Press the Cursor left/right (◀/▶) keys until the ANGLE icon is highlighted.

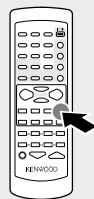
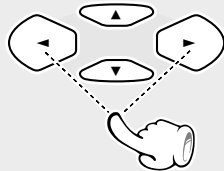

- 3 Press the ENTER key.



The ANGLE menu appears



- 4 Select the angle with press the ENTER key.

- The menu is switched off when no operation is performed for about 3 seconds.

## CD VCD Using IntroScan function

IntroScan plays the first few seconds of each track on the CD similar to the scan feature that's on many car radios.

### Using the on-screen banner display



- 1 During playback, press the OSD key on the remote.



- 2 Press the Cursor left/right (◀/▶) keys until the IntroScan icon is highlighted.

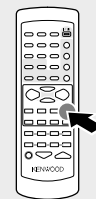
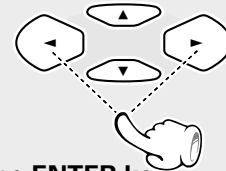

- 3 Press the ENTER key.



- The first 10 seconds of each track play.
- After Intro Scan goes through all of the tracks, it stops.
- If you want to stop IntroScan while it's in progress, just press STOP (■) key on the remote.

### Using the ANGLE key on the remote



- 1 During playback, press the SHIFT key, then press the ANGLE key on the remote.

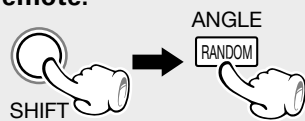

- 2 Select the Camera angle with press the ENTER key or ANGLE key.

- The menu is switched off when no operation is performed for about 3 seconds.

## DVD CD VCD Using Bookmarks

The bookmark feature lets you mark a point on the disc that you can go to quickly. You can store up to 9 bookmarks.

### Create the bookmark



- 1 During playback, press the OSD key on the remote.



- 2 Press the Cursor left/right (◀/▶) keys until the BOOKMARK icon is highlighted.

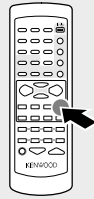
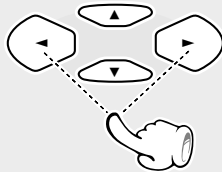

- 3 Press the ENTER key.



The bookmark menu appears



- 4 When you reach the scene you want to mark, press ENTER.



The bookmark appears on under square



- Press the ON SCREEN key or CLEAR key to switch the menu off.

### Clearing a bookmark

The bookmark is cleared each time a disc is removed from the player or when the power is turned off.



- If all 9 bookmarks are in use, you can still mark new scenes, but the previous bookmarks will be erased.
- Depending on the disc, the Bookmark function may not work.

### Recalling a bookmarked scene



- 1 During playback, press the OSD key on the remote.



- 2 Press the Cursor left/right (◀/▶) keys until the BOOKMARK icon is highlighted.

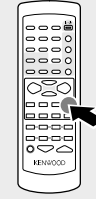
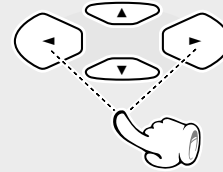

- 3 Press the ENTER key.



The bookmark appears on under square



- 4 Press the Cursor up (▲) key on the remote to go the parts of the Bookmark menu.



- 5 Use the Cursor left/right (◀/▶) keys on the remote to select the bookmarked scene you want to activate.

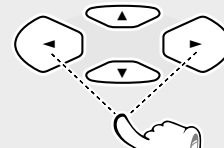

- 6 Press the ENTER key to active the bookmark.



- Press the OSD key or CLEAR key to switch the menu off.

It is also possible to receive them by one-touch operations by storing up to 45 stations in the preset memory. (see page 36)

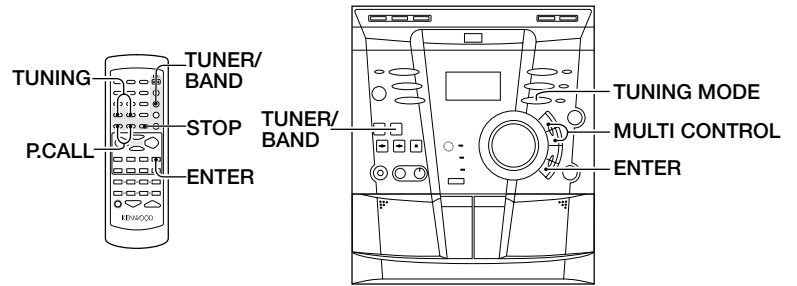

## 1 Select the TUNER input

MAIN UNIT

REMOTE



## 2 Select the broadcast band

MAIN UNIT

REMOTE

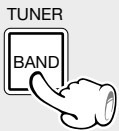

## 3 Select a tuning mode

MAIN UNIT

REMOTE

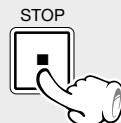
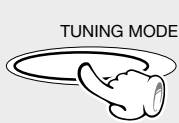

When the BAND key is pressed, this unit will be switched on automatically.

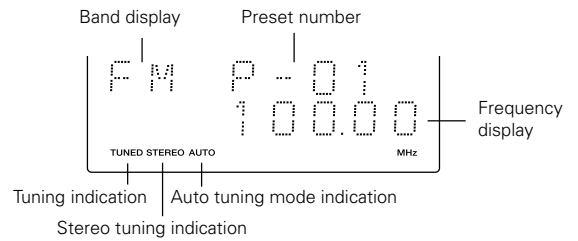

Each press changes the band.

- ① FM
- ② AM

Each press switches the mode

- ① auto tuning mode
- ② manual tuning mode



## 4 Select a station

### P.CALL (preset call)

MAIN UNIT

REMOTE

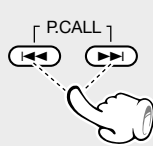
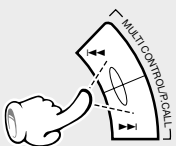

Press the MULTI CONTROL keys or press the P.CALL keys to select a preset station.

### AUTO (auto tuning)

REMOTE

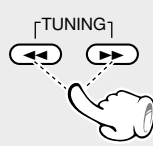

Press the TUNING key to receive the next tuned station automatically

### MANUAL (manual tuning)

REMOTE

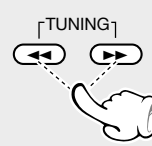

Use the manual tuning mode when reception is noisy due to weak reception. (In the manual mode, stereo broadcasts are received in monaural.)

You can store up to 45 stations in the memory and recall with a single touch of the key.

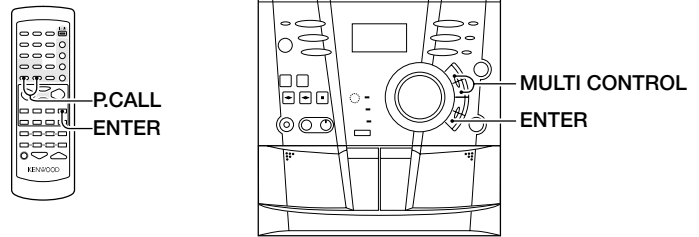

## Storing the broadcast stations (one-by-one presetting)

**1** Select a station (auto tuning or manual tuning) → 34

**2** Press the ENTER key

REMOTE



**3** Select the desired preset number

REMOTE

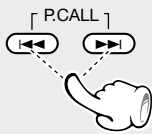

**4** Press the ENTER key

REMOTE



Repeat steps **1** to **4** to preset other stations.

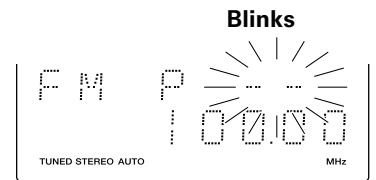

In case of input with the number keys, a preset number will be decided simply by input of a 2-digit number without pressing the ENTER key.

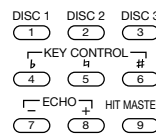
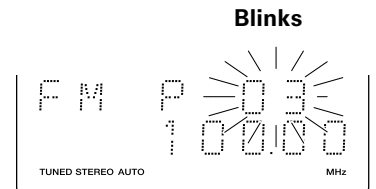

0



RDS is a system which transmits useful information (digital data) for FM broadcasts together with the broadcast signal. Tuners and receivers designed for RDS reception can extract the information from the broadcast signal for use with various functions such as automatic display of the station name.

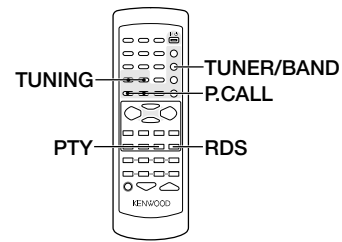

## Using RDS function ( for Europe and U.K. only)

### Functions made possible with RDS

**PTY (Program Type Identification) Search :**

The tuner automatically searches for a station which is currently broadcasting a specified program type (genre).

**PS (Program Service Name) Display :**

When an RDS broadcast is received, the station name is automatically displayed.

**RT (Radio text) :**

Displays the radio text data transmitted by some RDS stations when you select the **RT** mode.

**CT (Clock Time) :**

Decodes the real time clock from the FM frequency.

### Using the RDS Display function

**1 Select the FM broadcast station**



**2 Press the SHIFT key, then press the RDS key**

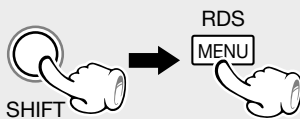

Each press switches the display mode as follows.

- ① PS NAME display
- ② PTY display
- ③ RT display
- ④ CT display
- ⑤ Current FM frequency display

**PS NAME**

- If the PS information is being received, the PS name (**BBC, AFO, NDR**, etc.) is shown on the display.
- If the PS information is not received, the original FM frequency is shown.
- Even though no **RDS key** is pressed, the reception of PS information ensues the PS name is displayed.

**RT display**

- Text data accompanying the RDS broadcast scrolls across the display (64 characters can be displayed).



←Scrolled display

- If the RT information is not received, the **"NO RT"** is shown on the display.

**CT display**

- If the CT information will take up to 2 minutes to be decoded therefore the clock is not displayed immediately.
- If the CT information is not received, the **"NO CT"** is shown on the display.
- The CT clock does not update the system clock.

## PTY function

The PTY information is composed of an identification symbol, which helps the FM radio to recognize the program type of each FM station.

The 29 PTY modes are shown in the display by pressing the PTY key.

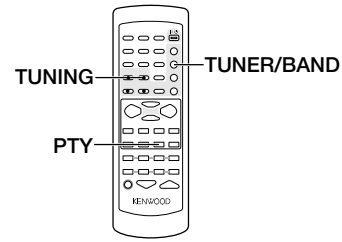

## Using the PTY search function

### 1 Select the FM band



→ 34

### 2 Press the PTY key



- The PTY MODE (POP M, ROCK M etc.) appears on the display.

### 3 Press the P.CALL (◀◀/▶▶) keys to select the desired program type.

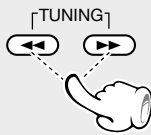

### 4 When the program type is selected, press the PTY key.



- Auto-search the station sequentially
- Press again during search to cancel.

#### PTY found

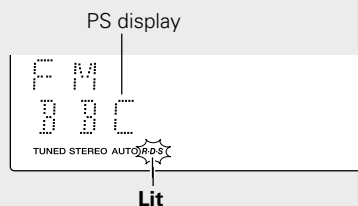

#### PTY not found



## RDS Program types

Program Type Name	Receiver Display
News	NEWS
Current Affairs	AFFAIRS
Information	INFO
Sport	SPORT
Education	EDUCATE
Drama	DRAMA
Culture	CULTURE
Science	SCIENCE
Varied	VARIED
Pop Music	POP M
Rock Music	ROCK M
Easy Listening Music	EASY M
Light Classical Music	LIGHT M
Serious Classical Music	CLASSICS
Other Music	OTHER M
Weather	WEATHER
Finance	FINANCE
Children's programmes	CHILDREN
Social affairs	SOCIAL
Religion	RELIGION
Phone in	PHONE IN
Travel	TRAVEL
Leisure	LEISURE
Jazz Music	JAZZ
Country Music	COUNTRY
National Music	NATION M
Oldies Music	OLDIES
Folk Music	FOLK M
Documentary	DOCUMENT

This unit can only use tape for the normal position (Type I).



**Longer tape than 90 minutes cassette tape:**  
 Since longer tape than 90 minutes cassette tape is very thin, the tape could adhere to the pinch roller or be easily cut. It is recommended that these tapes not be used with this unit to prevent possible damage.

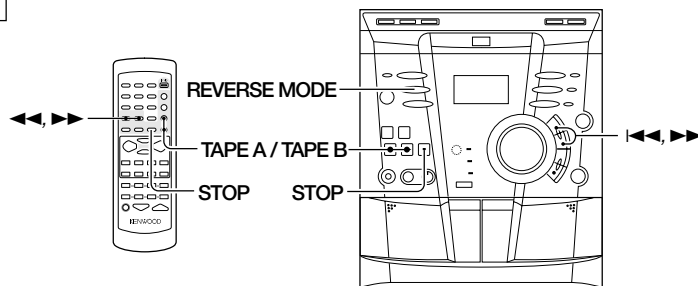

## 1 Load a cassette tape

- 1 Open the door.
  - 2 Insert a tape
  - 3 close the door.
- Remove tape slack before loading.
  - Close the door securely.

Press the area marked **PUSH OPEN** to load or eject a tape.

## 2 Select reverse mode

MAIN UNIT



Each press switches the modes as follows

- 1 " ⇄ ": playback stops after having played both side of tape in a deck.
- 2 " (⇄) ": Endless playback of both sides of tape.
- 3 " = ": playback stops after having played one side of tape.

## 4 Start playback

MAIN UNIT

REMOTE

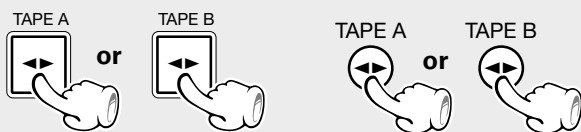

- If the tape transport direction is opposite to the desired direction, press the play key corresponding to this.

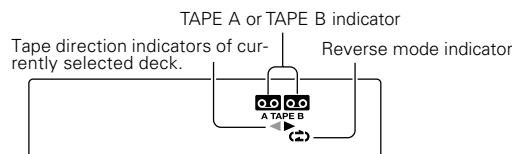

## To wind tape at high speed

MAIN UNIT

REMOTE

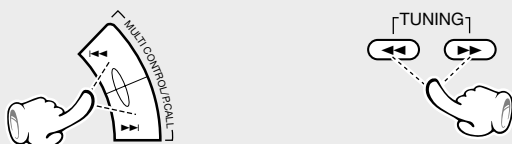

## To stop playback

MAIN UNIT

REMOTE

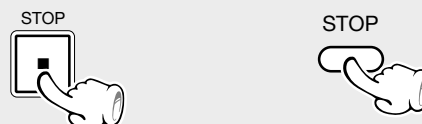

Operations

This unit can only use tape for the normal position (Type I).

To record a DOLBY SURROUND disc, please switch the listening mode to STEREO.

## Preparation

### 1 Open the door.

Press the area marked **PUSH OPEN** to load or eject a tape

### 2 Insert a tape.

### 3 Close the door.

- Remove tape slack before loading.
- Close the door securely.

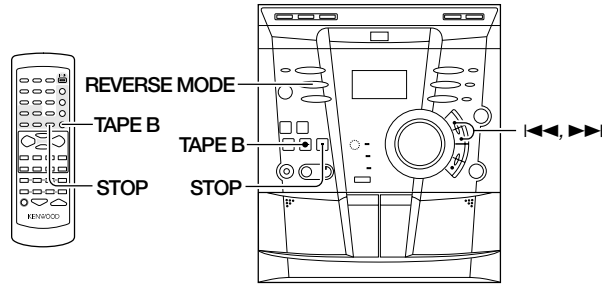

## 1 Select reverse mode

MAIN UNIT

REVERSE MODE



## 2 Select tape transport direction, Then press the STOP (■) key.

MAIN UNIT

TAPE B

REMOTE

TAPE B

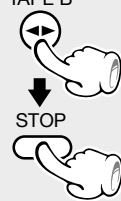

## 3 Select the source to be recorded

MAIN UNIT

VIDEO/AUX

REMOTE

DVD/CD

TUNER

BAND



## 4 Start recording

MAIN UNIT ONLY

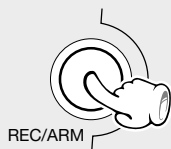

## Each press switches the modes as follows

- ① "⏮": The recording will end and the tape will stop at the end in reverse direction, no matter whether recording was started in forward direction or in reverse direction.
- ② "⏪": In recording mode, this is the same as "⏮".
- ③ "⏹": Record stops after having recorded one side of tape.

- If the tape transport direction is opposite to the desired direction, press the play key corresponding to this.

Tape direction indicators of currently selected deck.

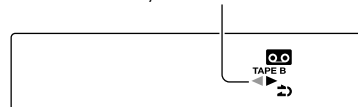

- Start playback the source, then press the **REC/ARM** key.

Lit

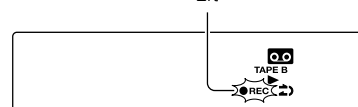

## To pause recording

MAIN UNIT ONLY

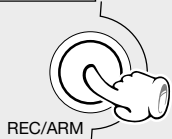

This flashes quickly during ARM and slowly during pause.



- Pressing the key pauses recording after leaving a non-recorded space of about 4 seconds (ARM function).
- If the key is pressed again in less than 4 seconds after it has been pressed, recording resumes from that instant.

## To stop recording

MAIN UNIT

REMOTE

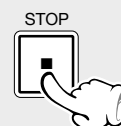



This unit can only use tape for the normal position (Type I).

CD Direct recording is not possible for a DOLBY SURROUND disc. Please switch the listening mode to STEREO and perform normal recording. (See page 52)

With CD Direct recording, an entire CD is recorded and CD and TAPE stop automatically.

## Preparation

See "Preparation" on page 40.

### 1 Select reverse mode

→ 39

MAIN UNIT



### 2 Select tape transport direction, Then press the STOP (■) key.

→ 39

MAIN UNIT

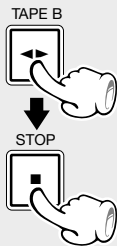

REMOTE

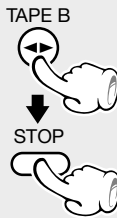

### 3 Press the SMART MENU (S. MENU) key.

MAIN UNIT

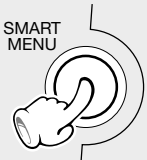

REMOTE



### 4 Select "RECORDING OPTION", then press the SELECT key.

MAIN UNIT

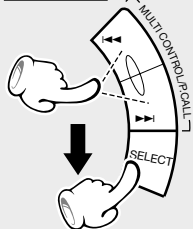

REMOTE

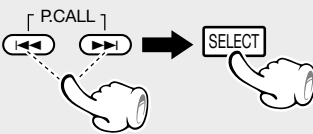

The following items can be selected by pressing the MULTI CONTROL keys.

- "RECORDING OPTION"
- "TAPE DUBBING"
- "AUDIO OPTION"
- "CLOCK OPTION"

### 5 Select "CD DIRECT RECORDING", then press the SELECT key.

MAIN UNIT

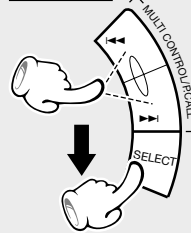

REMOTE

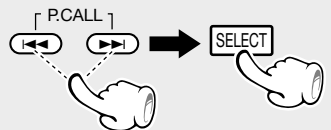

The following items can be selected by pressing the MULTI CONTROL keys or cursor keys on the remote.

- "CD DIRECT RECORDING"
- "TIMER RECORDING"

- PUT TAPE IN DECK B" will be displayed when there is no tape in TAPE B. Please set a tape into TAPE B.

### 6 Select disc number, then press the SELECT key.

MAIN UNIT

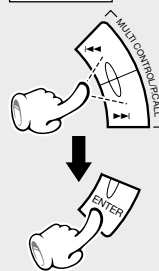

REMOTE

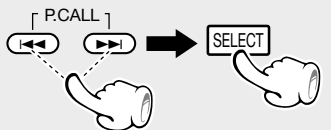

### 7 Press the ENTER key to start recording.

MAIN UNIT



REMOTE



This unit can only use tape for the normal position (Type I).

CD Program recording is not possible for a DOLBY SURROUND disc. Please switch the listening mode to STEREO and perform normal recording. (See page 52)

## Preparation

See "Preparation" on page 40.

### 1 Select reverse mode



MAIN UNIT

REVERSE MODE



### 2 Select tape transport direction, then press the STOP (■) key.



MAIN UNIT

TAPE B



REMOTE

TAPE B

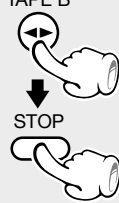

### 3 Playback a disc, then press the STOP (■) key.

MAIN UNIT

DVD/CD



REMOTE

DVD/CD

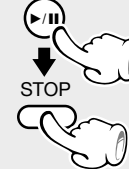

### 4 Edit program

See page 28

REMOTE

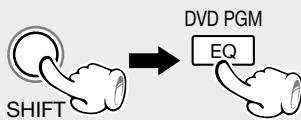

### 5 Press the REC/ARM key

MAIN UNIT

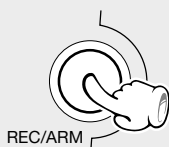

### Each press switches the modes as follows

- ① "↔": The recording will end and the tape will stop at the end in reverse direction, no matter whether recording was started in forward direction or in reverse direction.
- ② "⏪": In recording mode, this is the same as "↔".
- ③ "⏩": Record stops after having recorded one side of tape.

- If the tape transport direction is opposite to the desired direction, press the play key corresponding to this.

Tape direction indicators of currently selected deck.

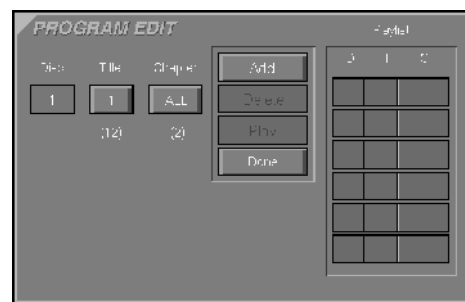
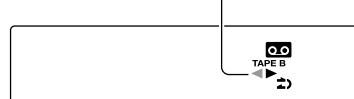

Lit

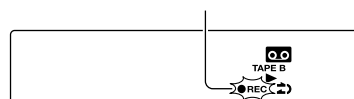

This unit can only use tape for the normal position (Type I).

Tapes can be copied easily using the tape dubbing function.

## 1 Select reverses mode

→ 39

MAIN UNIT

REVERSE MODE



## 2 Press the SMART MENU (S. MENU) key.

MAIN UNIT

REMOTE

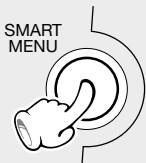

S.MENU



## 3 Select "TAPE DUBBING", then press the SELECT key, then press the SELECT key.

MAIN UNIT

REMOTE

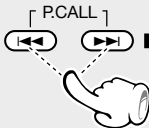
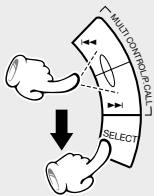

SELECT



The following items can be selected by pressing the **MULTI CONTROL** keys.

- "RECORDING OPTION"
- "TAPE DUBBING"
- "AUDIO OPTION"
- "CLOCK OPTION"

- "PUT TAPE IN DECK A/B" will be displayed when there is no tape in TAPE A/B. Please set a tape into TAPE A and TAPE B.

## 4 Select tape transport direction of TAPE A, then press the SELECT key.

MAIN UNIT

REMOTE

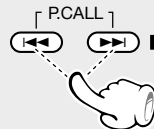
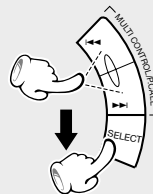

SELECT



The following items can be selected by pressing the **MULTI CONTROL** keys or cursor keys on the remote.

- "DECK A" : forward direction
- "DECK A" : backward direction

## 5 Select tape transport direction of TAPE B, then press the SELECT key.

MAIN UNIT

REMOTE

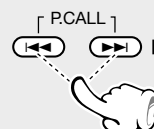

SELECT



The following items can be selected by pressing the **MULTI CONTROL** keys or cursor keys on the remote.

- "DECK B" : forward direction
- "DECK B" : backward direction

## 6 Press the ENTER key to start recording.

MAIN UNIT

REMOTE



ENTER



## Hierarchical structure of VCD menus (P.B.C.)

When an item is selected on the menu screen during playback of a P.B.C.-compatible VCD, another menu with more details items may be displayed. When a number of menus are connected in multiple layers in this way, it is said that the menus have a hierarchical structure. In this structure, the desired scene can be reached by repeating item selections on the menu screens.

### Example for a hierarchical structure

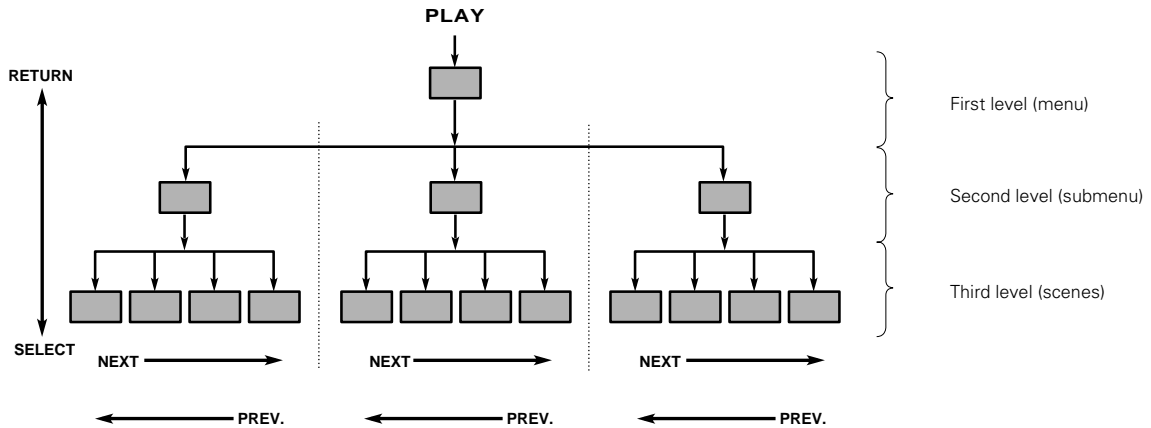

#### Advancing

When an item is selected on the menu screen with the ► key or the numeric keys, advance is made to the next lower menu level. When the advance destination is the "scene" to be played, the contents will be played.

- When several menus (scenes) can be selected in each level, screen switching is possible with the keys ►► and ◀◀.

#### Returning

Each time the RETURN key is pressed, return is made to the next higher menu.

### Examples of operation keys and indications used during VCD playback

Soft jacket indication	▶	Ⓞ	◀◀	▶▶
KENWOOD operation key	▶/	RETURN	SKIP DOWN	SKIP UP

- Depending on the software, the jacket indication may differ from the above.

### Playback without using the menu playback function (In case of a P.B.C.-compatible VCD)

Press the TOP MENU key on the remote control unit.

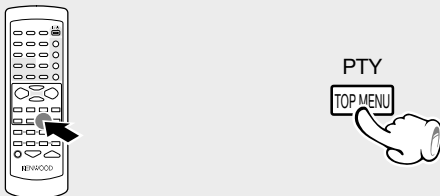

- For the track numbers, refer to the disc jacket or other material.
- P.B.C. off mode : Without using menu playback function.

#### To return to menu playback

Press the TOP MENU key again.

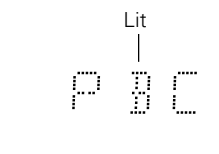

**Software with which this function is available:**



## Start playback

### 1 Load a disc

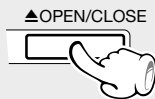

### 2 Connect a microphone

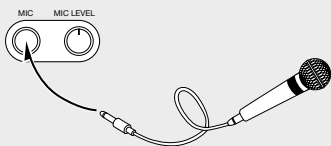

### 3 Start playback

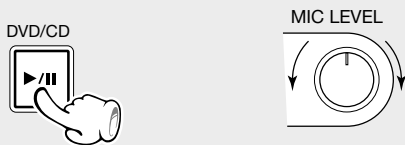

### 4 Press the SHIFT key, then adjust the ECHO level

Remote control unit only

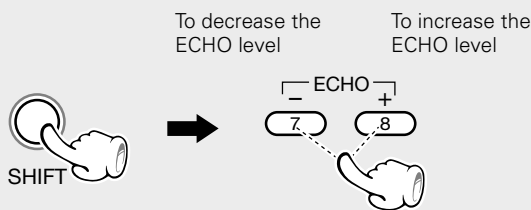

**Karaoke mode operation is possible only when a microphone is connected.**

- Press ►/|| key to start playback
- Adjust volume level of the microphone.

**An echo effect can be applied to the microphone voice to make karaoke singing sound better. The echo effect can be varied from 0 to 9.**

- Press the next key within 5 seconds of pressing the SHIFT key. Within 5 seconds of pressing the next key, operation is possible without pressing the SHIFT key.

## HIT MASTER function

The sound level of the vocal part of the disc is suppressed, so that it can be used in the same way as a KARAOKE disc.

Remote control unit only

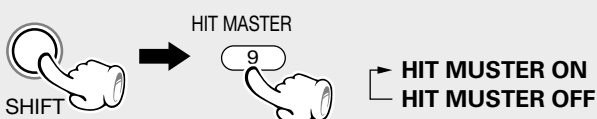

**Depending on the disc, the suppression amount may be smaller.**

## Controlling the key of the music (KEY CONTROL)

**This feature allows to transpose the key of the music according to the key of the singer's voice.**

Remote control unit only

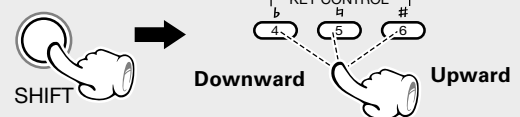

**KEY CONTROL can be varied from -5 to +5.**

## Set up menu

The initial setup of the player, which has been made at the factory, can be changed to the desired setup.

**1** During stop mode, press **MENU** key on the remote.



RDS  
MENU

Current setup menu display appears on the screen.

**2** Press **Cursor up/down (▲/▼)** keys on the remote to select the item, then press the **ENTER** key to access the sub features

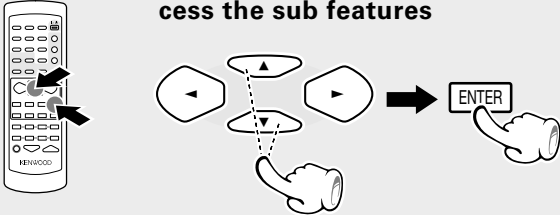
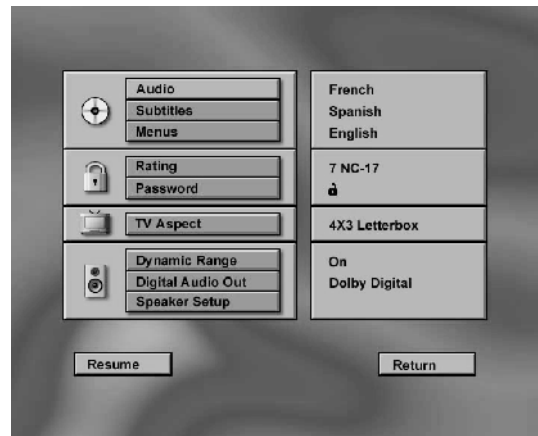
- Return button:** When this is selected and the **ENTER** key is pressed, return will be made to the previous screen.
- Play:** When this button is selected with a stopped disc and the **ENTER** key is pressed, playback will start.
- Resume:** When this button is selected with a disc in resume status and the **ENTER** key is pressed, resume playback will be started.

- Audio / Subtitle (disc languages)** : This sets the language to be used when playing a disc. (If a disc does not contain the recording the selected language, it is played in the priority language set for each disc.)
- Menus** : This sets the initial setup of language as well as the language used in on-screen messages such as "PLAY".
- Rating (Parental Lock)** : This can restrict playback of adult-oriented DVD discs that you do not want to be seen by children. However, even when a DVD disc is marked "Adult-oriented" or so on the label, its viewing cannot be restricted unless the restriction level is recorded in the disc itself.
- Password** : The password for rating setting, change, cancellation, etc. is set.
- TV Aspect** : This sets the screen size (4:3 or 16:9 aspect ratio) according to the connected TV.
- 4 x 3 letterbox** : Choose this setting if you would prefer to see movies in their original aspect ratio. You will see the entire frame of the movie, but it will occupy a smaller portion of the screen. This setting may result in the movie appearing with black bars at the top and bottom of the screen.
  - 4 x 3 Pan Scan** : Choose this setting if you want the movie to fill the entire screen of your TV. You won't see part of the picture (particularly the right and left edge). Some disc produced in a wide screen format can't be cropped in this fashion, which means the black bars would appear at the top and the bottom of the screen.
  - 16 x 9 Widescreen** : Choose this setting if your DVD player is connected to a widescreen TV.
- Dynamic Range** : This is set to ON when the volume change should not become overly large, for example when listening late at night.
- Digital Audio Out** : This sets the Digital audio output mode.
- Speaker Setup** : This is used to select the size of the connected speakers, to adjust the volume, and for setup of the delay time.

### How to use the RETURN key

When the **RETURN** key is pressed, the display returns to the previous screen (STOP mode).



## DVD Select Audio Language

- 1 Press Cursor up/down (▲/▼) keys on the remote to select Audio on the set up menu display, then press the ENTER key.

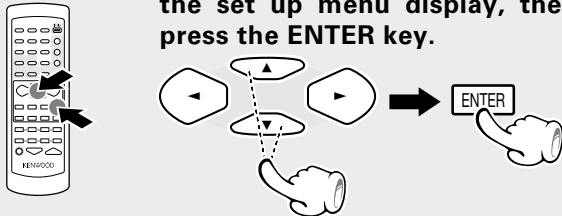

(Audio menu appears.)

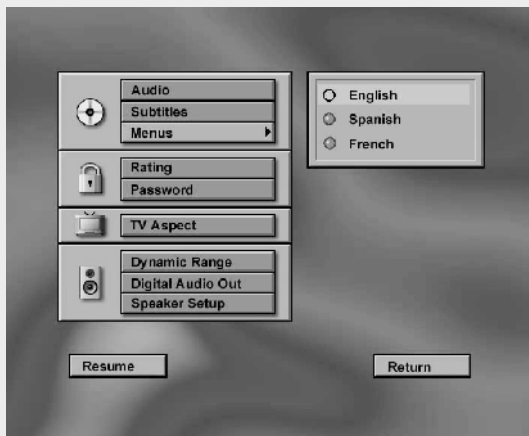

- 2 Press Cursor up/down (▲/▼) keys on the remote to select specific Audio language, then press the ENTER key.

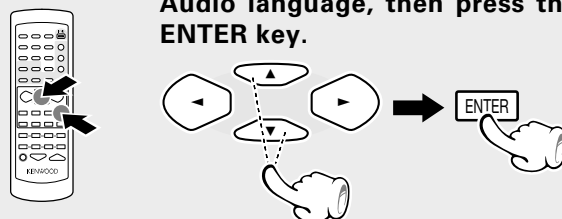

### To select other language

- 1 Select "Other" and press ENTER key



- 2 Input code in the first digit by Press Cursor up/down (▲/▼) keys or numeric keys on the remote and repeat other 3 code with same way.
- 3 Select "OK" icon and press ENTER.

(DVD menu language code list  
- 35 )

- Press PLAY key to resume normal playback.

## DVD Select Subtitle Language

- 1 Press Cursor up/down (▲/▼) keys on the remote to select Subtitle on the set up menu display, then press the ENTER key.

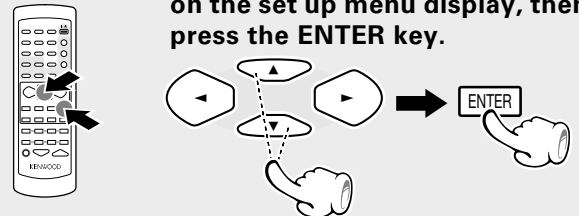

(Subtitle menu appears.)

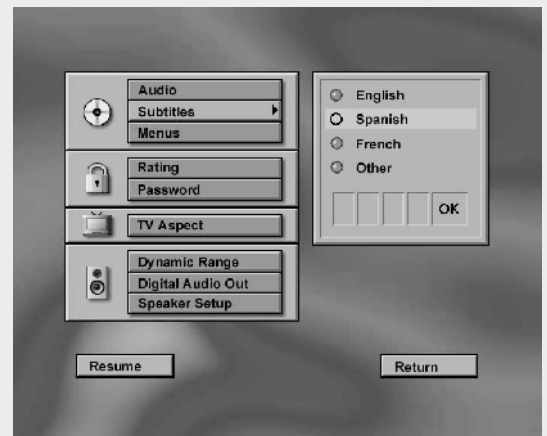

- 2 Press Cursor up/down (▲/▼) keys on the remote to select specific Subtitle language, then press the ENTER key.

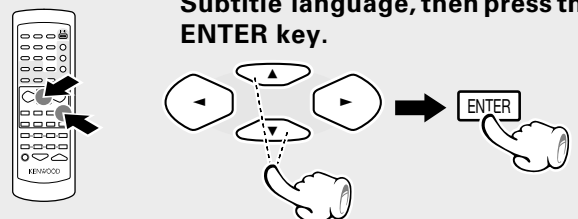

### To select other language

- 1 Select "Other" and press ENTER key



- 2 Input code in the first digit by Press Cursor up/down (▲/▼) keys or numeric keys on the remote and repeat other 3 code with same way.
- 3 Select "OK" icon and press ENTER.

(DVD menu language code list  
- 35 )

- Press PLAY key to resume normal playback.

## DVD Select Menu Language

- ① Press Cursor up/down (▲/▼) keys on the remote to select Menus on the set up menu display, then press the ENTER key.

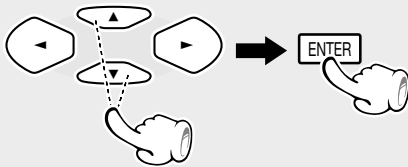

(Menus appears.)

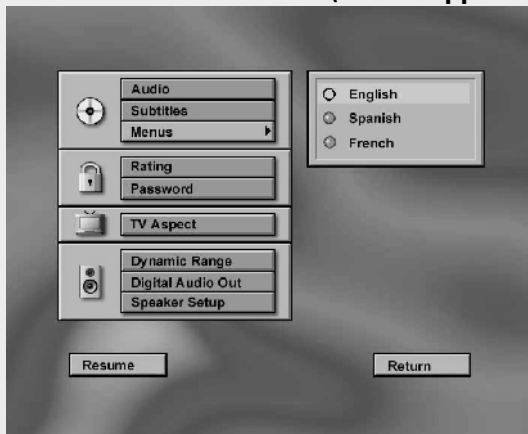

- ② Press Cursor up/down (▲/▼) keys on the remote to select specific Audio language, then press the ENTER key.

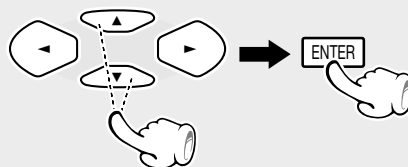

- Press PLAY key to resume normal playback.

## DVD Select Rating (Parental Lock)

This part of DVD rating lets you determine how your player will react discs that contain movies that are rated (in the U.S.A. the Motion Pictures Association of America rates movies as G, PG, PG-13, etc.).

- ① Press Cursor up/down (▲/▼) keys on the remote to select Menus on the set up menu display, then press the ENTER key.

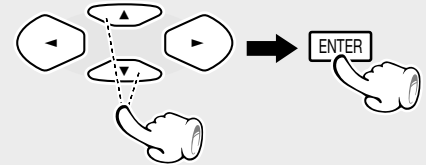

When a password already has been set, the screen for change of the entered password will be displayed. In that case, enter the password. (See page 31.)

(Rating aspect menu appears.)

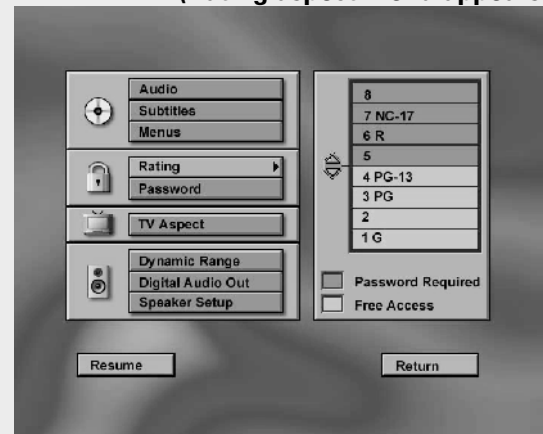

- ② Press Cursor up/down (▲/▼) keys on the remote to highlight rated titles, then press the ENTER key.

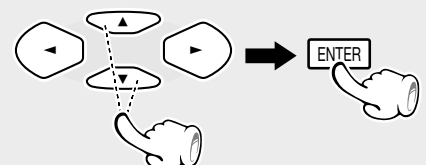
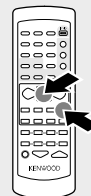

- Press PLAY key to resume normal playback.

### Parental lock level

- Level 8:** All DVDs can be played back. (Factory preset)
- Level 7 to 2:** DVDs for general audiences/children can be played back. (DVDs for adults are prohibited.)
- Level 1:** DVDs for children can be played back. (DVDs for adults/general audiences are prohibited.)



# DVD Password

## Input password

- 1 Press Cursor up/down (▲/▼) keys on the remote to select Password on the set up menu display, then press the ENTER key.

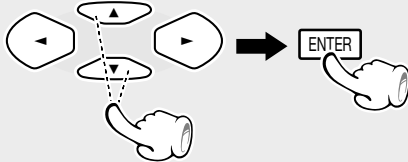
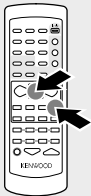

(Password menu appears.)

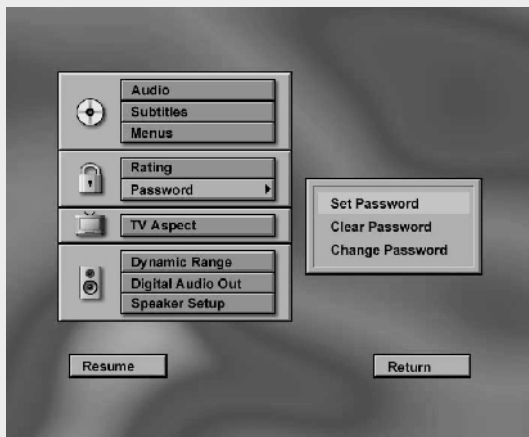

- 2 After select "Set Password", press the ENTER key.

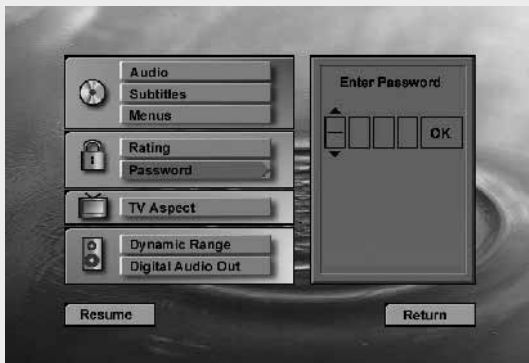
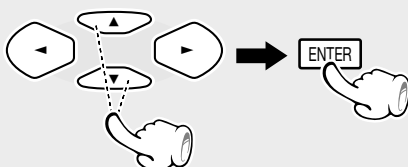
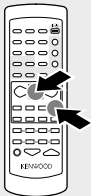

- 3 Press Cursor up/down (▲/▼) keys or numeric keys on the remote to enter password.

- 4 Press ENTER key to finish password input (Confirm Password display appears below Enter Password display).

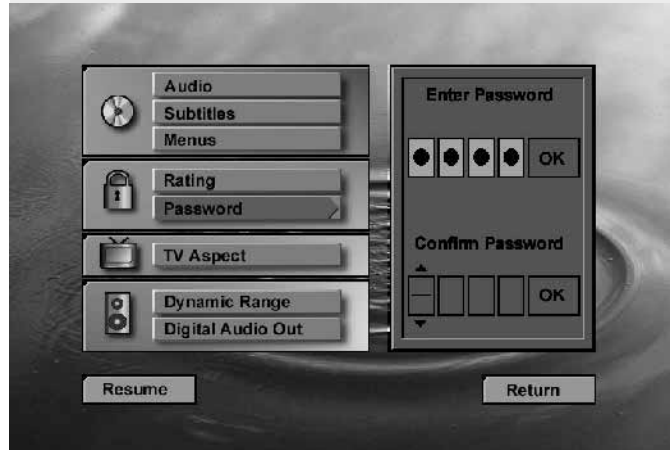

- 5 Press Cursor up/down (▲/▼) keys or numeric keys on the remote to enter again password that you entered, then press the ENTER key.

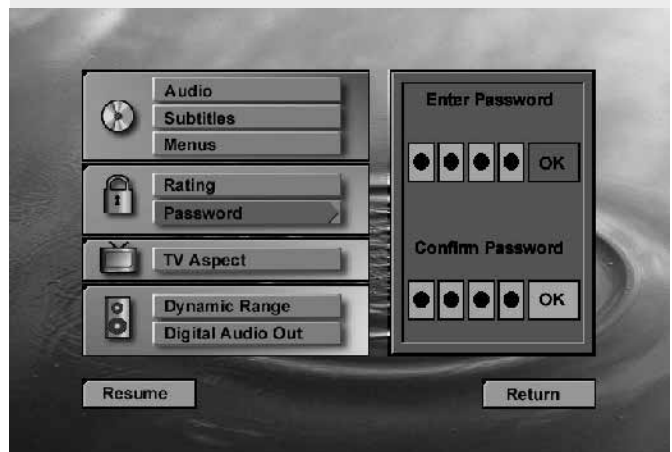
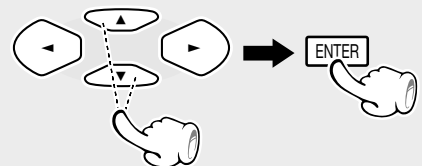
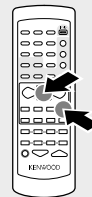

- 6 Select OK and press the ENTER key.



- Press PLAY key to resume normal playback.

## DVD Password (continued)

### Change password

- ① Press Cursor up/down (▲/▼) keys on the remote to select Password on the set up menu display, then press the ENTER key.

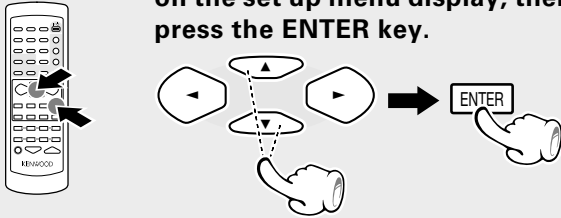

(Enter Password menu appears.)

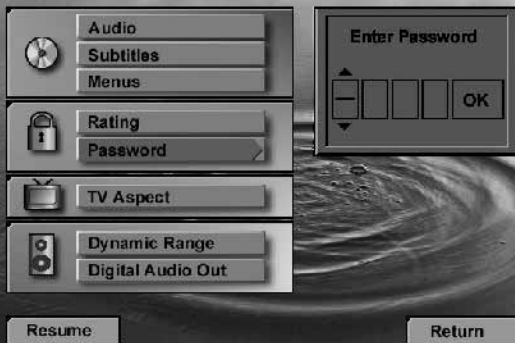

- ② Press Cursor up/down (▲/▼) keys or numeric keys on the remote to enter password. Select OK and press ENTER key.

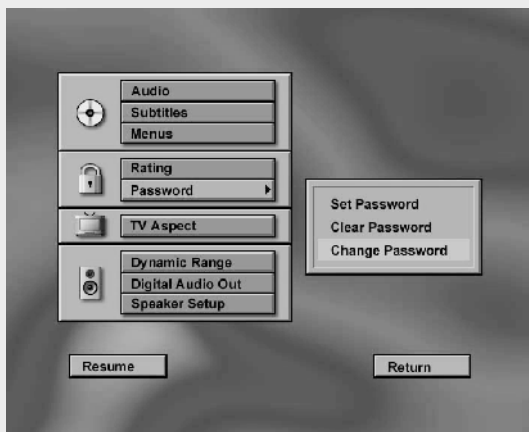
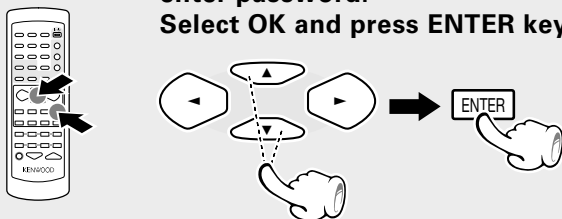

- ③ Press Cursor up/down (▲/▼) keys to select Change Password, then press ENTER key.

- ④ Press Cursor up/down (▲/▼) keys or numeric keys on the remote to enter password.

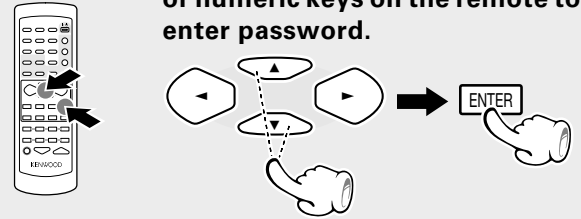

- ⑤ Press ENTER key to finish password input (Confirm Password display appears below Enter Password display).

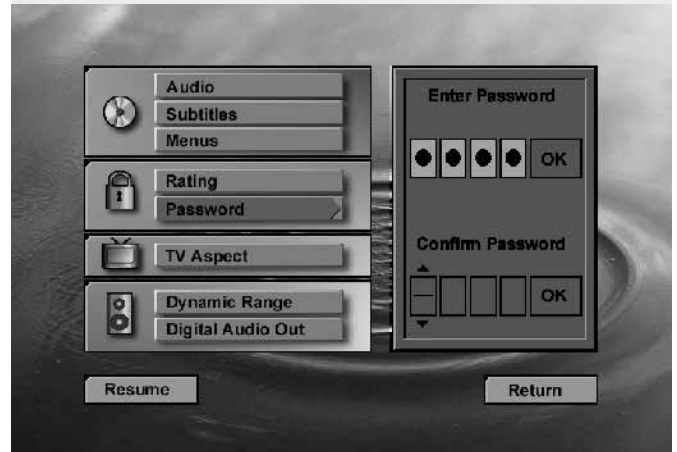

- ⑥ Press Cursor up/down (▲/▼) keys or numeric keys on the remote to enter again password that you entered, then press the ENTER key.

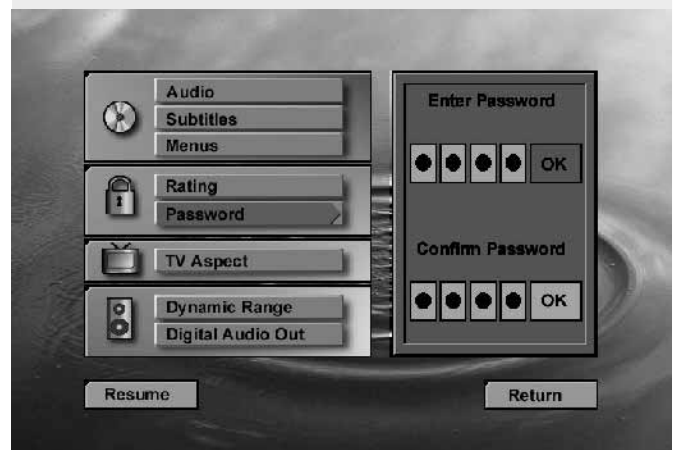
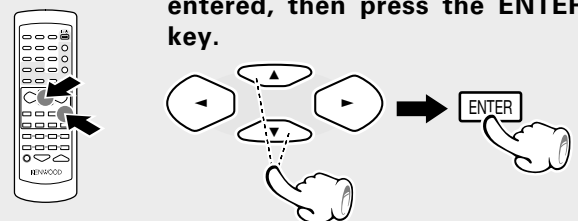

- ⑦ Select OK and press the ENTER key.

## DVD Password (continued)

### Clear password

- 1 Press Cursor up/down (▲/▼) keys on the remote to select Password on the set up menu display, then press the ENTER key.

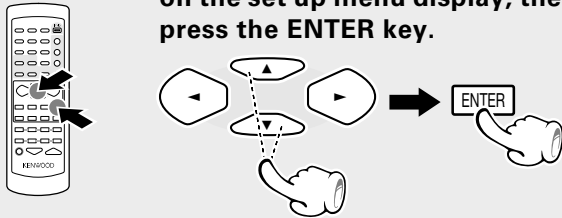

(Enter Password menu appears.)

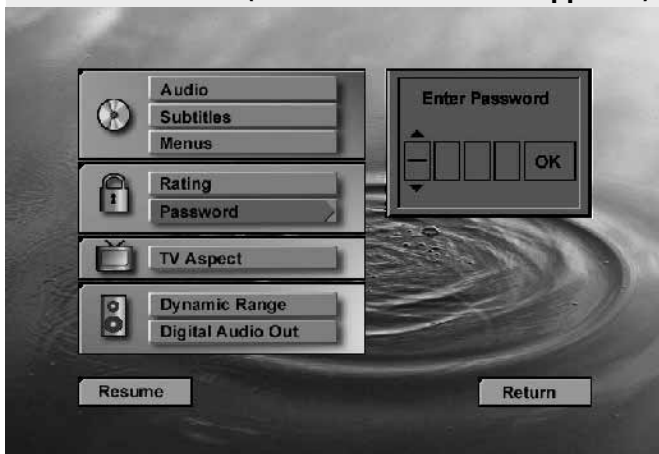

- 2 Press Cursor up/down (▲/▼) keys or numeric keys on the remote to enter password. Select OK and press ENTER key.

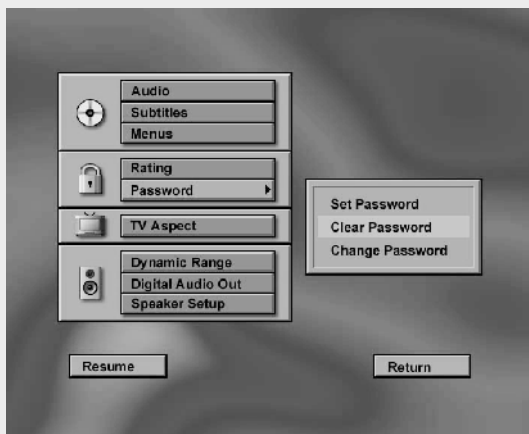
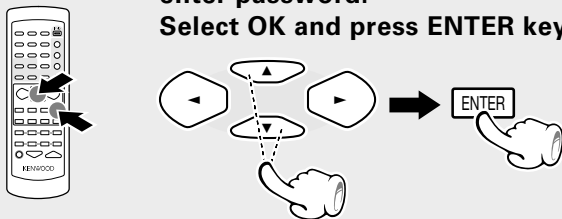

- 3 Press Cursor up/down (▲/▼) keys to select Clear Password, then press ENTER key.

## DVD TV aspect

- 1 Press Cursor up/down (▲/▼) keys on the remote to select TV Aspect on the set up menu display, then press the ENTER key.

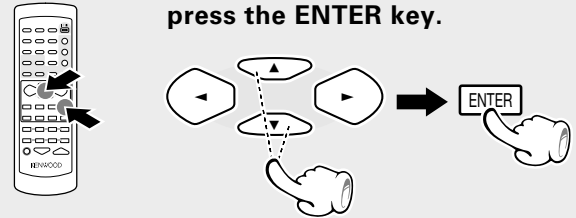

(TV Aspect menu appears.)

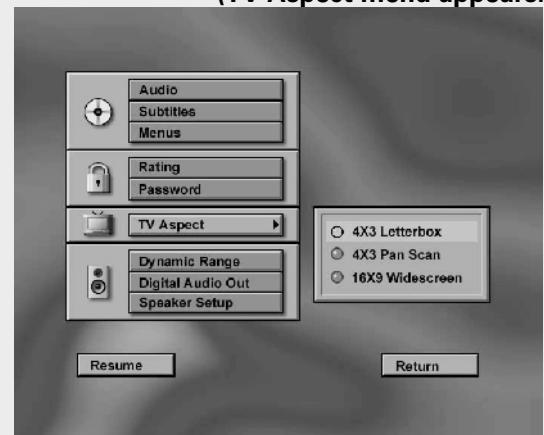

- 2 Press Cursor up/down (▲/▼) keys on the remote to select TV Aspect menu, then press the ENTER key.

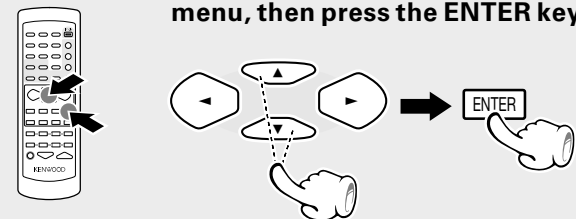

- Press PLAY key to resume normal playback.

## DVD Dynamic Range

- ① Press Cursor up/down (▲/▼) keys on the remote to select Dynamic Range on the set up menu display, then press the ENTER key.

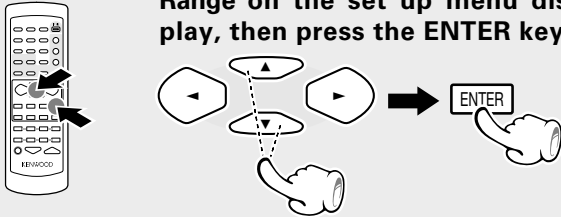

(Dynamic Range menu appears.)

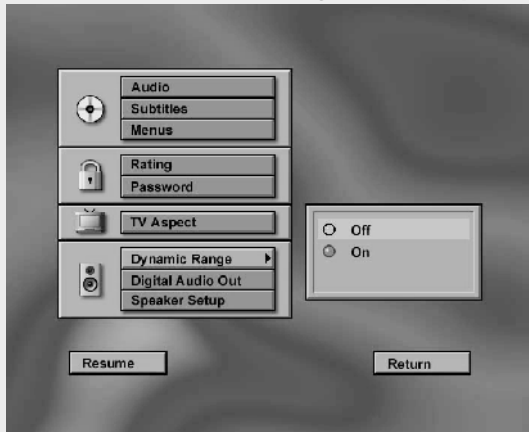

- ② Press Cursor up/down (▲/▼) keys on the remote to select Dynamic Range mode (on or off), then press the ENTER key.

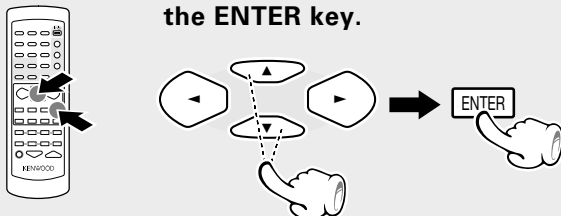

- Press PLAY key to resume normal playback.

## DVD Digital Audio Out

- ① Press Cursor up/down (▲/▼) keys on the remote to select Digital Audio Out on the set up menu display, then press the ENTER key.

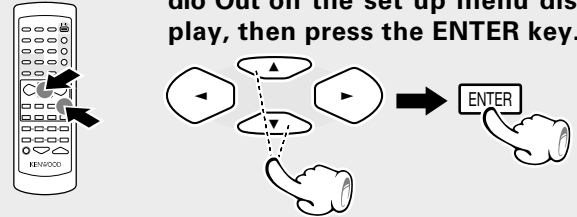

(Digital Audio Out menu appears.)

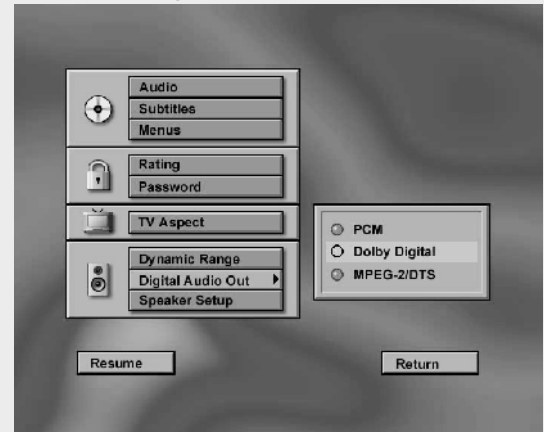

- ② Press Cursor up/down (▲/▼) keys on the remote to select Digital Audio mode, then press the ENTER key.

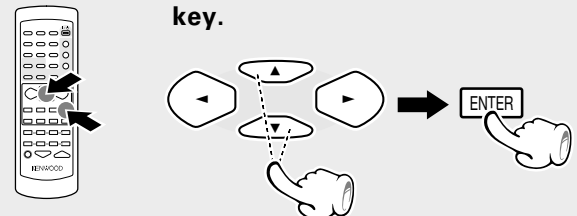

- Press PLAY key to resume normal playback.

## What are surround modes?

You can experience true home-theater sound with your new system. This system incorporates several listen modes to let you enjoy surround sound with a wide variety of program sources. Each produces multiple channels of surround-sound, but each does it differently.

- **Dolby Digital** : Dolby Digital uses an encode/decode process based on its theatrical digital surround sound technology. The five main channels are full-frequency and independent, so sound can completely envelop you or soar anywhere in the room, just like at the movies. (only for XD-DV90 and XD-DV80)

Compared with Dolby Pro Logic, Dolby Digital has more clarity, greater surround envelopment, and more realistic sound movement between channels.

- **Dolby Pro Logic**: Dolby Pro Logic is a decoding process which provides theater-like surround sound from Dolby Surround encoded sources (such as videotape and LaserDisc software that are marked with the Dolby Surround logo). It offers excellent sound movement across the front of the room and a surround ambiance that seems to immerse you in a movie. Your system is equipped with a Dolby Pro Logic surround decoder to let you enjoy the wide variety of currently available Dolby Surround home video software. (only for XD-DV90 and XD-DV80)

- **Virtual surround**: —new—

## To set the surround mode manually

The available surround modes may be restricted depending on the input signal.

Press the LISTN MODE key or L.MODE key.

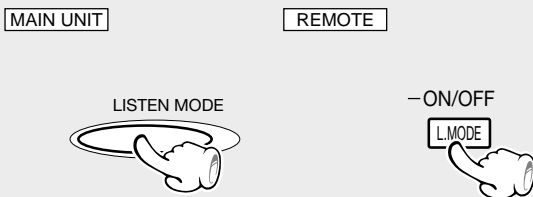

Each press switches the modes as shown below.

An example for model XD-DV90

- ① DOLBY DIGITAL
- ② DOLBY 3 STEREO
- ③ DOLBY PRO LOGIC
- ④ VIRTUAL SURROUND
- ⑤ STEREO

An example for model XD-DV70

- ① STEREO
- ② VIRTUAL SURROUND



Manufactured under license from Dolby Laboratories. "DOLBY", "Pro Logic" and the double-D symbol are trademarks of Dolby Laboratories. Confidential Unpublished Works. ©1992-1997 Dolby Laboratories. All rights reserved.



"DTS" and "DTS Digital Surround" are trademarks of Digital Theater Systems, Inc.

## Positioning the speakers

To achieve the optimum effects obtainable with this SURROUND SOUND system, it is important to position the speakers properly. Refer to the following illustration to find the best location in your room.

### Preparation

- 1 Play a disc marked "Dolby Digital".

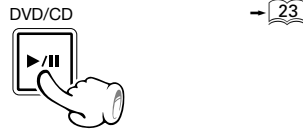

- 2 Stop the playback.

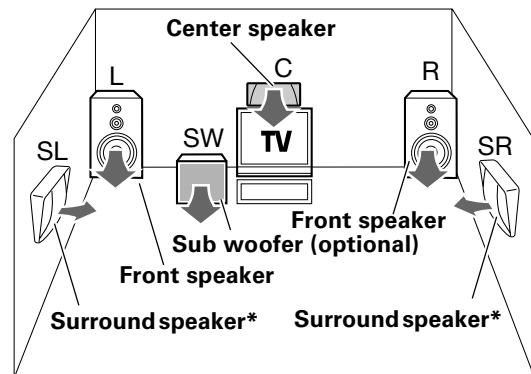
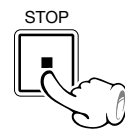

\*Surround speakers: accessories only for XD-DV90/XD-DV80

## SPEAKER SELECT

- 1 Press the MENU key.

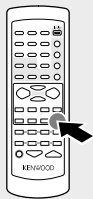

- 2 Press Cursor up/down (▲/▼) keys on the remote to select Speaker Setup menu, then press the ENTER key.

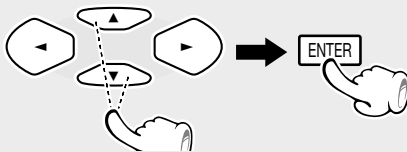
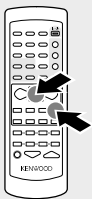

- 4 Press the cursor up/down (▲/▼) key or cursor left/right (◀/▶) to select Front Left (or Right) speaker, then press the ENTER key

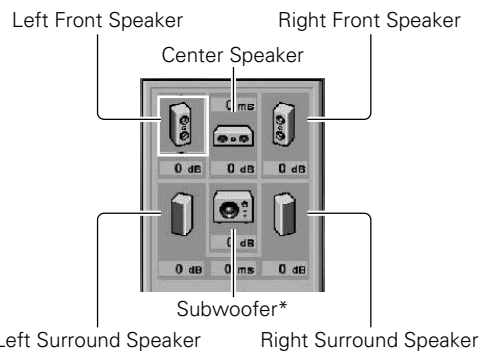
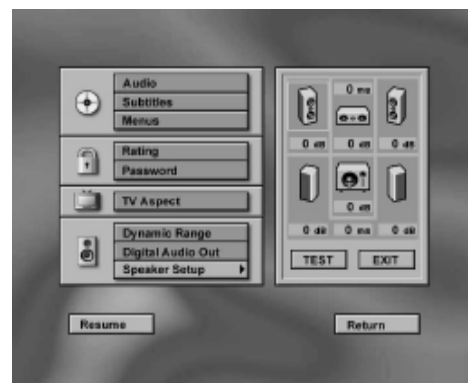
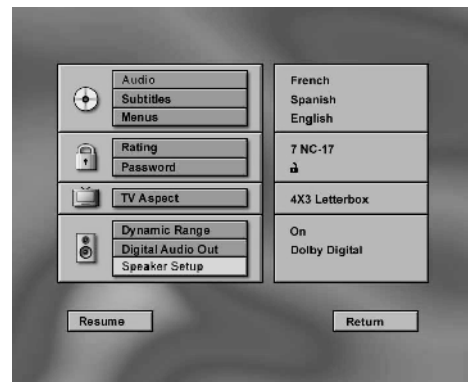
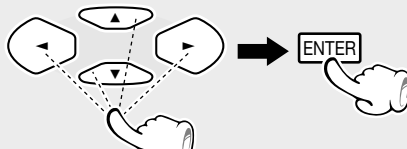

At the time of shipping from the factory, the setting is for no subwoofer (no indication).

**Continued on next page...**

- ⑤ Press the cursor up/down (▲/▼) key to select Large or small, then press the ENTER key

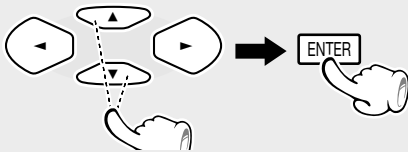
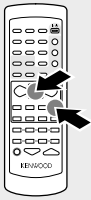

- ④ Press the cursor left/right (◀/▶) key to select center speaker, then press the ENTER key

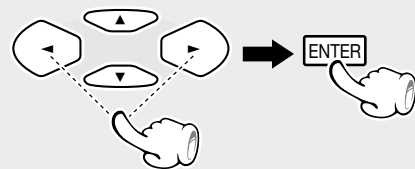
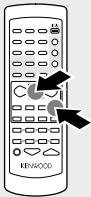

- ⑤ Press the cursor up/down (▲/▼) key to select Large, small or non, then press the ENTER key

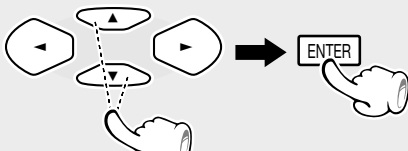
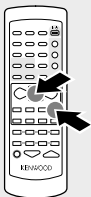

Left front speaker and right front speaker are changed at the same time.

Select in the same way for center speaker, surround speaker and subwoofer.

When only the accessory speakers are to be used, the most suitable setting already has been made. Please do not make any change, but continue to "Delay time setting".

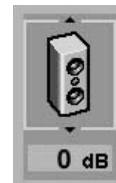

Large icon

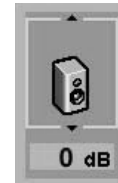

Small icon

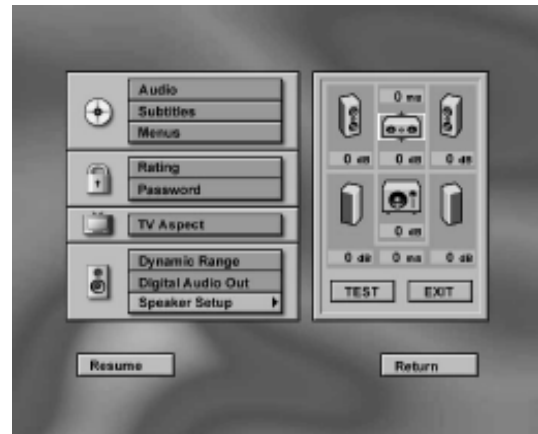

## Delay time setting

The ideal listening position for 6-channel surround playback is the point at equal distance from all speakers. By setting the delay time for the center and surround speakers, this item realizes the ideal listening position virtually. (The center and surround speakers can be set as if they are laid out on the dotted line circle shown below.)

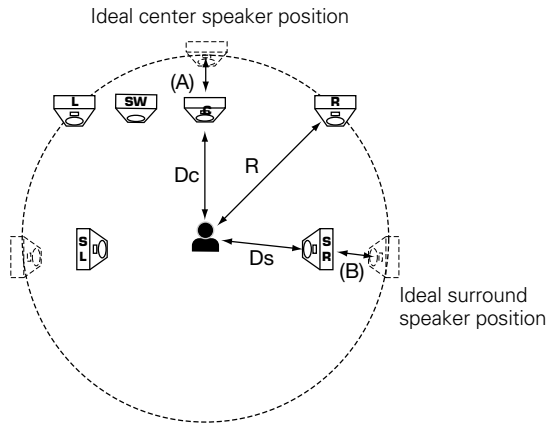

### [Center speaker setting]

$$(A) = R - Dc$$

Distance A	Setting
0 cm	0 ms
Approx. 40 cm	1 ms
Approx. 80 cm	2 ms
Approx. 120 cm	3 ms
Approx. 160 cm	4 ms
Approx. 200 cm	5 ms

### [Surround speaker setting]

$$(B) = R - Ds$$

Distance B	Setting
0 cm	0 ms
Approx. 200 cm	5 ms
Approx. 400 cm	10 ms
Approx. 600 cm	15 ms

- Press Cursor left/right (◀/▶) keys to select center speaker's delay time button on the Speaker Setup menu, then press the ENTER key.

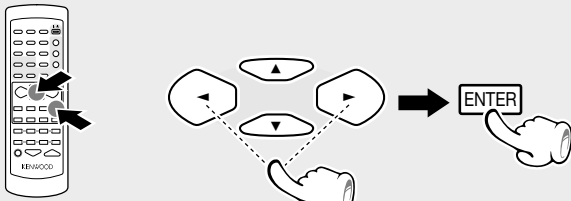

- Press the cursor up/down (▲/▼) keys to select delay time, then press the ENTER key

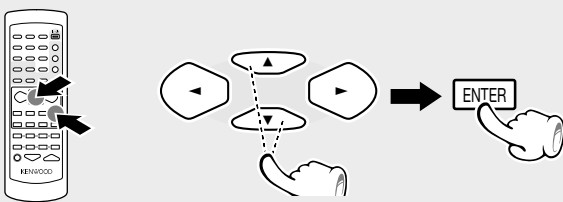

Select the delay time in the same way also for surround. Different settings for left and right surround speaker are not possible.

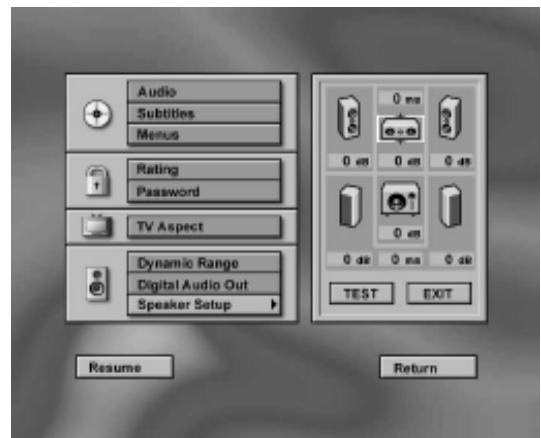

Center speaker delay time button

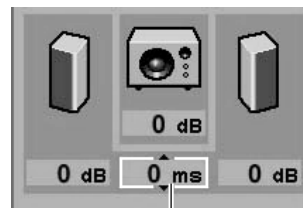
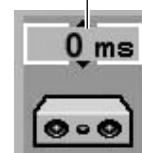

Surround speaker delay time button



## Speaker level setting

- ① Press up/down (▲/▼) keys or cursor left/right (◀/▶) keys to select "TEST" on the Speaker Setup menu, then press the ENTER key.

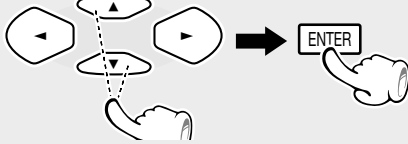

When TEST (test tone) has been selected, test noise is put out sequentially from the speakers, starting with the left front speaker. Check that the test noise can be heard from all speakers and that the same volume is heard from all speakers.

If the volume is different for some speakers, return to the previous step and adjust the level for that speaker.

### Level settings

- ② Press the cursor up/down (▲/▼) keys or cursor left/right (◀/▶) keys to select the desired speaker's Level button, then press the ENTER key.

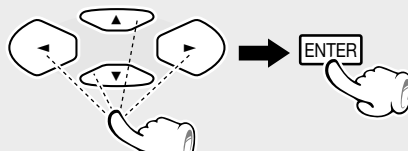

- ③ Press the cursor up/down (▲/▼) keys to select the level, then press the ENTER key.

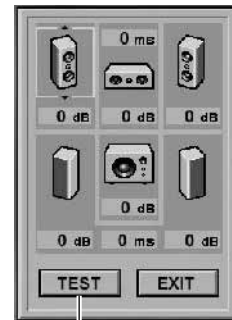
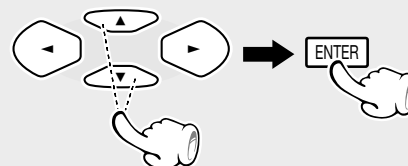

TEST button

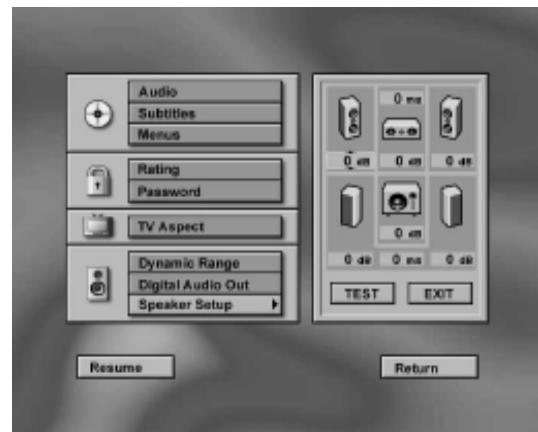

Adjust in the same way so that the sound volume of all speakers, except for the subwoofer (Super woofer) sounds the same. As adjustment of the subwoofer with the test tone is difficult, please adjust it while listening to normal music.

To end the speaker setup, press the EXIT button and press the ENTER key of the remote control unit.

### Sleep timer (SLEEP) :

The unit is turned OFF automatically after the specified period has elapsed.

### Timer playback:

At the set ON time, the power is switched on and playback of the source set in advance starts. The power is switched off at the set OFF time.

### Timer recording:

At the set ON time, the power is switched on and recording of the source (tuner or external input) set in advance starts. The power is switched off at the set OFF time.

## Sleep timer

### 1 Press the SMART MENU key.

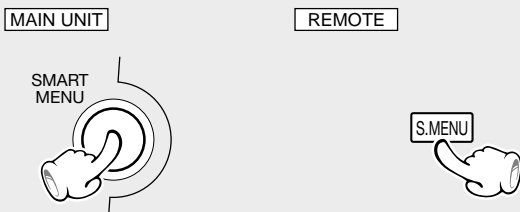

### 2 Select "CLOCK OPTIONS", then press the SELECT key.

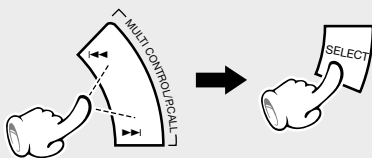

### 3 Select "SLEEP TIMER", then press the SELECT key.

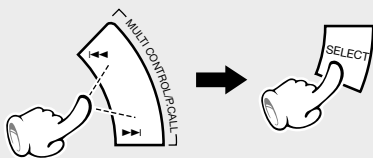

### 4 Select the time until power OFF, then press ENTER key.

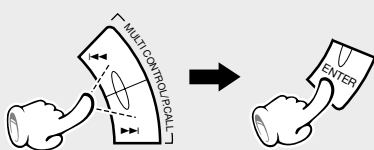

The following items can be selected by pressing the **MULTI CONTROL** keys.

- "RECORDING OPTION"
- "TAPE DUBBING"
- "AUDIO OPTION"
- "CLOCK OPTION"

The following items can be selected by pressing the **MULTI CONTROL** keys.

- "SLEEP TIMER"
- "ADJUST TIME"
- "TIMER PLAY"
- "AUTO POWER SAVE"

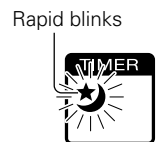

The following items can be selected by pressing the **MULTI CONTROL** keys.

- ① "SLEEP OFF" : sleep timer off
- ② "SLEEP 10" : 10 minutes
- ⋮
- ⑨ "SLEEP 80" : 80 minutes
- ⑩ "SLEEP 90" : 90 minutes

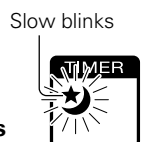

The power is switched off when the set time has passed.

To cancel the SLEEP TIMER select "SLEEP OFF".

# Timer Play

**1** Switching the power ON.

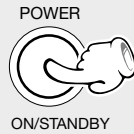

**2** Press the SMART MENU key.

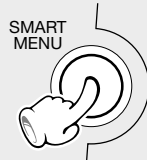

**3** Select "CLOCK OPTIONS", then press the SELECT key.

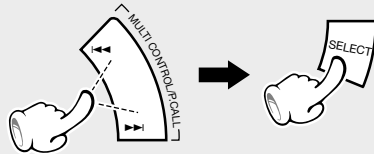

**4** Select "TIMER PLAY", then press the SELECT key.

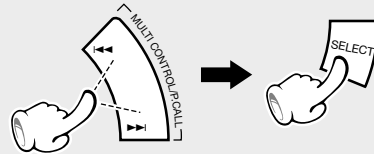

**5** Select desired timer mode, then press the SELECT key.

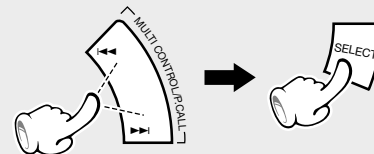

**6** Select ON time.

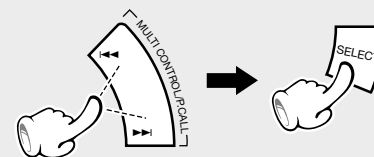

**7** Select OFF mode.

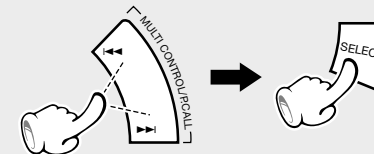

**8** Select the input source.

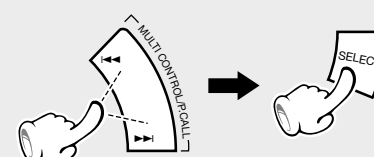

The following items can be selected by pressing the **MULTI CONTROL** keys.

- "RECORDING OPTION"
- "TAPE DUBBING"
- "AUDIO OPTION"
- "CLOCK OPTION"

The following items can be selected by pressing the **MULTI CONTROL** keys.

- "SLEEP TIMER"
- "ADJUST TIME"
- "TIMER PLAY"
- "AUTO POWER SAVE"

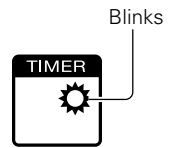

The following items can be selected by pressing the **MULTI CONTROL** keys.

- ① "EVERY DAY" : executing a timer program once every day
- ② "ONE TIME" : executing it only once
- ③ "OFF" : cancelled

- Enter the figure of hour, then press the **SELECT** key and enter the figure of minute.
- Press the **SELECT** key.

- Enter the figure of hour, then press the **SELECT** key and enter the figure of minute.
- Press the **SELECT** key.

The following items can be selected by pressing the **MULTI CONTROL** keys.

- ① "TUNER" (Tuner)
- ② "CD" (Tuner)
- ③ "TAPE"
- ④ "MD/DVD"

Operations

*Continued on next page...*

- 9 Select the preset station (only when tuner is selected above), then press the **SELECT** key

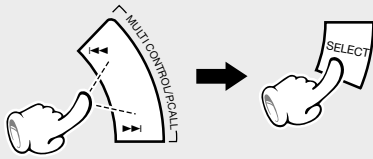

- 10 As the timer setting contents will be displayed, press the **ENTER** key.

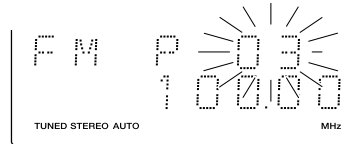

"SET CLOCK" will be displayed when the present time has not been set. In that case, please set the present time. (See page 19)

### Displayed "PRESS ENTER TO SAVE" Switching the power OFF

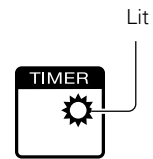
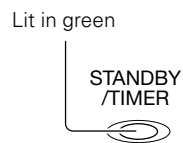

## Timer recording

- 1 Switching the power ON.

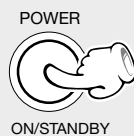

- 2 Press the **SMART MENU** key.

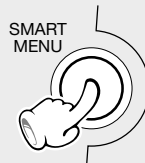

- 3 Select "RECORDING OPTIONS", then press the **SELECT** key.

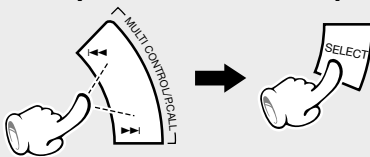

- 4 Select "TIMER RECORDING", then press the **SELECT** key.

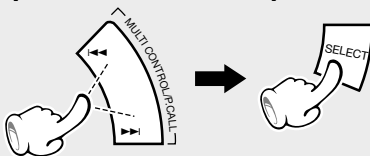

- 5 Select desired timer mode, then press the **SELECT** key.

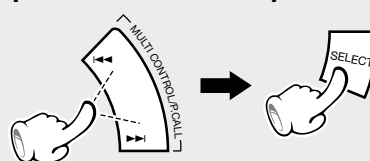

- Load a recordable tape in TAPE B.

→ 39

The following items can be selected by pressing the **MULTI CONTROL** keys.

"RECORDING OPTION"

"TAPE DUBBING"

"AUDIO OPTION"

"CLOCK OPTION"

The following items can be selected by pressing the **MULTI CONTROL** keys or cursor keys on the remote.

"CD DIRECT RECORDING"

"TIMER RECORDING"

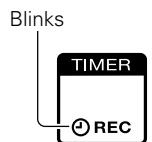

The following items can be selected by pressing the **MULTI CONTROL** keys.

- ① "EVERY DAY" : executing a timer program once every day
- ② "ONE TIME" : executing it only once
- ③ "OFF" : cancelled

*Continued on next page...*

**6 Select ON time.**

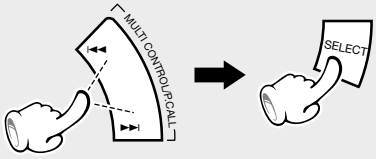

**7 Select OFF mode.**

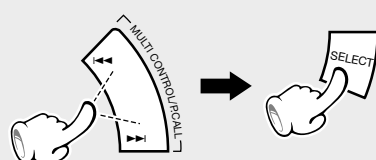

**8 Select the input source.**

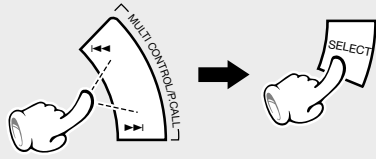

**9 Select the preset station (only when tuner is selected above), then press the SELECT key.**

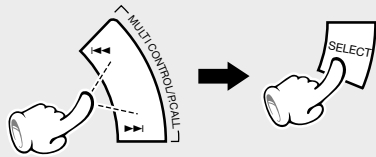

**10 As the timer setting contents will be displayed, press the ENTER key.**



- Enter the figure of hour, then press the **SELECT** key and enter the figure of minute.
- Press the **SELECT** key.

- Enter the figure of hour, then press the **SELECT** key and enter the figure of minute.
- Press the **SELECT** key.

The following items can be selected by pressing the **MULTI CONTROL** keys.

- ① "TUNER"
- ② "VIDEO/AUX"

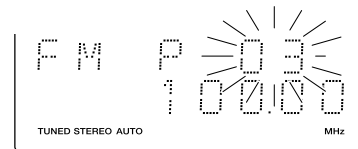

**Displayed "PRESS ENTER TO SAVE" Switching the power OFF**

Lit in green



The mute function operates during timer recording. Turn the **VOLUME** knob a little if you want to listen to the sound.

## AUTO POWER SAVE function

When the power is ON and neither recording nor playback is executed for 30 minutes or more, the power is switched off automatically by this function.

### Using the MULTI CONTROL jog dial.

**1 Switching the power ON.**

**2 Press the SMART MENU key.**

**3 Select "CLOCK OPTIONS", then press the SELECT key.**

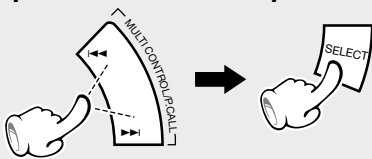

**3 Select "AUTOPOWERSAVE", then press the SELECT key.**

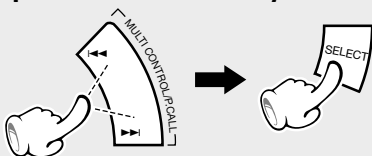

**3 Select "A.P.S. ON" or "A.P.S. OFF", then press the ENTER key.**

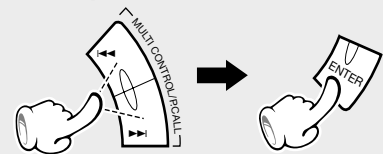

- ① "APS OFF"  
Auto power save is not used.
- ② "APS ON"  
Auto power save is used.

- When the **TUNER** or **VIDEO/AUX** input is selected, this function operates only when the volume is set to zero.

**DVD menu language code list**

Cord No.	Language
6565	Afar
6566	Abkhazian
6570	Afrikaans
6577	Amharic
6582	Arabic
6583	Assamese
6588	Aymara
6590	Azerbaijani
6665	Bashkir
6669	Byelorussian
6671	Bulgarian
6672	Bihari
6678	Bengali; Bangla
6679	Tibetan
6682	Breton
6765	Catalan
6779	Corsican
6783	Czech
6789	Welsh
6865	Danish
6869	German
6890	Bhutani
6976	Greek
6978	English
6979	Esperanto
6983	Spanish
6984	Estonian
6985	Basque
7065	Persian
7073	Finnish
7074	Fiji
7079	Faroese
7082	French
7089	Frisian
7165	Irish
7168	Scots Gaelic
7176	Galician
7178	Guarani
7185	Gujarati
7265	Hausa
7273	Hindi

Cord No.	Language
7282	Croatian
7285	Hungarian
7289	Armenian
7365	Interlingua
7378	Indonesian
7383	Icelandic
7384	Italian
7387	Hebrew
7465	Japanese
7473	Yiddish
7487	Javanese
7565	Geogian
7575	Kazakh
7576	Greenlandic
7577	Cambodian
7578	Kannada
7579	Korean
7583	Kashmiri
7585	Kurdish
7589	Kirghiz
7665	Latin
7678	Lingala
7679	Laothian
7684	Lithuanian
7686	Latvian; Lettish
7771	Malagasy
7773	Maori
7775	Macedonian
7776	Malayalam
7778	Mongolian
7779	Moldavian
7782	Marathi
7783	Malay
7784	Maltese
7789	Burmese
7865	Nauru
7869	Nepali
7876	Dutch
7879	Nowegian
7982	Oriya
8065	Punjabi

Cord No.	Language
8076	Polish
8083	Pashto; Pushto
8084	Portuguese
8185	Quechua
8277	Rhaeto-Romance
8279	Romanian
8285	Russian
8365	Sanskrit
8368	Sindhi
8372	Serbo-Croatian
8373	Singhalese
8375	Slovak
8376	Slovenian
8377	Samoan
8378	Shona
8379	Somali
8381	Albanian
8382	Serbian
8385	Sundanese
8386	Swedish
8387	Swahili
8465	Tamil
8469	Telugu
8471	Tajik
8472	Thai
8473	Tigrinya
8475	Turkmen
8476	Tagalog
8479	Tonga
8482	Turkish
8484	Tatar
8487	Twi
8575	Ukrainian
8582	Urdu
8590	Uzbek
8673	Vietnamese
8679	Volapük
8779	Wolof
8872	Xhosa
8979	Yoruda
9072	Chinese
9085	Zulu

## Maintenance

### Cleaning the head section

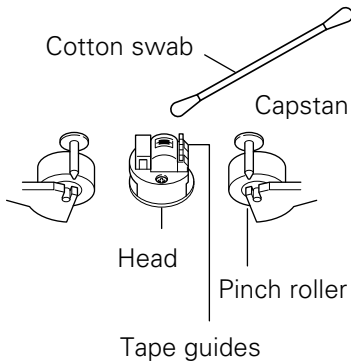

### Cleaning the heads and peripheral components

For maintaining the best condition of the deck and for longer service life, always keep the heads (recording / playback / erase), capstan and pinch roller clean.

To clean them, perform the following:

1. Open the cassette holder.
2. Using a cotton swab dipped in alcohol, clean the head (recording / playback / erase), capstan and pinch roller carefully.

### Demagnetizing the head

When the recording / playback head is magnetized, the sound quality will deteriorate. In such a case, demagnetize the head using a commercially available demagnetizer (head eraser).



There are precisely aligned parts around the heads, including the tape guides. When cleaning, pay special attention so as not to apply shock to them.

### Maintenance of the Set

When the front panel, the case, etc. becomes dirty, wipe with a soft, dry cloth. Do not use thinner, alcohol, etc., as these can cause discoloration.

### In regard to contact cleaners

Do not use contact cleaners because it could cause a malfunction. Be specially careful not to use contact cleaners containing oil, for they may deform the plastic component.

## Reference

### Caution on condensation

Condensation (of dew) may occur inside the unit when there is a great difference in temperature between this unit and the outside.

This unit may not function properly if condensation occurs. In this case, leave the unit for a few hours with the power left ON, and restart the operation after the condensation has dried up.

### Be specially cautious against condensation in a following circumstance:

When this unit is carried from a place to another across a large difference in temperature, when the humidity in the room where this unit is installed increases, etc.

### Note related to transportation and movement

Before transporting or moving this unit, carry out the following operations.

- ❶ Remove the discs and tapes from the unit.
- ❷ Press the ►/II key of the DVD/CD.



- ❸ Wait a few seconds and turn the unit OFF.

### Memory backup function

<b>Stored contents which are cleared immediately when power plug is unplugged from power outlet.</b>	Clock display
<b>Stored contents which are cleared in at least a week after power plug is unplugged from power outlet.</b>	<b>Amplifier section</b> Last input selection Volume control value Surround setting <b>Tuner section</b> Receiving band Frequency Preset stations Tuning mode setting Program timer setting contents <b>Cassette deck unit</b> Transport direction Reverse mode

### WARNING NOTICE:

IN MOST CASES IT IS AN INFRINGEMENT OF COPYRIGHT TO MAKE COPIES OF TAPES OR DISCS WITHOUT THE PERMISSION OF THE COPYRIGHT OWNERS. ANYONE WISHING TO COPY COMMERCIALY AVAILABLE TAPES OR DISC SHOULD CONTACT THE MECHANICAL COPYRIGHT PROTECTION SOCIETY LIMITED OR THE PERFORMING RIGHTS SOCIETY LIMITED.

What seems to be a malfunction is not always so. Before calling for service, check the following table according to the symptom of your trouble.

















### Operation to reset

The microcomputer may fall into malfunction (impossibility to operate, erroneous display, etc.) when the power cord is unplugged while power is ON or due to an external factor. In this case, execute the following procedure to reset the microcomputer and return it to normal condition.

**Set the POWE key to ON. Then press the VIDEO/AUX key while holding the TUNING MODE key down.**

- Please note that resetting the microcomputer clears the contents stored in and returns and to condition when it left the factory.

### Receiver, speakers

Symptom	Cause	Remedy
<b>Sound is not produced.</b>	<ul style="list-style-type: none"> <li>● The speaker cords are disconnected.</li> <li>● The <b>MUTE</b> switch of remote control unit is switched ON.</li> <li>● The headphone plug is inserted into the jack.</li> </ul>	<ul style="list-style-type: none"> <li>● Connect properly referring to "System connection". </li> <li>● Switch <b>MUTE</b> OFF. </li> <li>● Unplug the headphone plug. </li> </ul>
<b>Sound is not produced from the left or right speakers.</b>	<ul style="list-style-type: none"> <li>● The speaker cords are disconnected.</li> </ul>	<ul style="list-style-type: none"> <li>● Connect properly referring to "System connection". </li> </ul>
<b>Demonstration starts suddenly.</b>	<ul style="list-style-type: none"> <li>● The DEMO is set to on.</li> </ul>	<ul style="list-style-type: none"> <li>● This is not malfunction. Press the <b>DISPLAY/DEMO</b> key to cancel the demonstration. </li> </ul>
<b>The clock display is out of order.</b>	<ul style="list-style-type: none"> <li>● There was a power failure.</li> <li>● The power cord was unplugged from the outlet.</li> </ul>	<ul style="list-style-type: none"> <li>● Adjust the present time again. </li> <li>● Adjust the present time again. </li> </ul>
<b>Timer operation is not possible.</b>	<ul style="list-style-type: none"> <li>● The present time has not been adjusted or there was a power failure.</li> <li>● The timer ON time and OFF time have not been set.</li> <li>● The timer execution was not set up.</li> </ul>	<ul style="list-style-type: none"> <li>● Adjust the present time referring to "Clock adjustment". </li> <li>● Set the timer ON time and OFF time. </li> <li>● Execute the timer program. </li> </ul>
<b>Radio stations cannot be received.</b>	<ul style="list-style-type: none"> <li>● The antennas have not been connected.</li> <li>● A proper broadcasting band has not been selected.</li> <li>● The frequency of the station to be received is not tuned.</li> </ul>	<ul style="list-style-type: none"> <li>● Connect antennas. </li> <li>● Select a band. </li> <li>● Tune to the frequency of the desired station. </li> </ul>
<b>Noise interferes.</b>	<ul style="list-style-type: none"> <li>● Car ignition noise.</li> <li>● Influence of an electric appliance.</li> <li>● A TV set is installed near the system.</li> </ul>	<ul style="list-style-type: none"> <li>● Install the outdoor antenna in an apart position from the road. </li> <li>● Switch the suspected electric appliance OFF.</li> <li>● Install the TV or the system at an increased distance between them.</li> </ul>
<b>A station has been preset but it cannot be received by pressing the PCALL key.</b>	<ul style="list-style-type: none"> <li>● The frequency of the preset station is not tunable.</li> <li>● The preset memory has been cleared because the power cord has been unplugged for a long period.</li> </ul>	<ul style="list-style-type: none"> <li>● Preset stations with tunable frequencies. </li> <li>● Preset stations again. </li> </ul>
<b>The STANDBY indicator flashes red.</b>	<ul style="list-style-type: none"> <li>● The speaker connection is abnormal.</li> </ul>	<ul style="list-style-type: none"> <li>● Check the speaker connection.</li> </ul>
<b>No sound from the surround speakers (Only XD-DV70/XD-DV60/XD-DV50/XD-A850DV)</b>	<ul style="list-style-type: none"> <li>● The surround speaker switch on the rear of the unit is set to OFF.</li> </ul>	<ul style="list-style-type: none"> <li>● Set the surround speaker switch on the rear of the unit to ON.</li> </ul>



**Remote control unit**

Symptom	Cause	Remedy
<b>Remote control operation is not possible.</b>	<ul style="list-style-type: none"> <li>● Batteries are exhausted.</li> <li>● The remote control is too far away from the system, the controlling angle is deviated or there is an obstacle in between.</li> <li>● There is no tape or CD set in the component to be played.</li> </ul>	<ul style="list-style-type: none"> <li>● Replace with new batteries. → 15</li> <li>● Operate the unit inside the remote controllable range. → 15</li> <li>● Set a tape or CD in the component to be played. → 19 → 38</li> </ul>

**Cassette deck**

Symptom	Cause	Remedy
<b>Sound cannot be produced by pressing the play key or no operation occurs even when an operation key is pressed.</b>	<ul style="list-style-type: none"> <li>● The head is dirty.</li> <li>● The tape is wound too tight due to irregular winding.</li> <li>● A nonrecorded tape is played.</li> </ul>	<ul style="list-style-type: none"> <li>● Clean the head referring to "Maintenance". → 54</li> <li>● Try another tape.</li> <li>● Play a recorded tape.</li> </ul>
<b>No operation occurs even when an operation key is pressed.</b>	<ul style="list-style-type: none"> <li>● The cassette holder is not closed completely.</li> <li>● A tape is not inserted in the unit.</li> <li>● The tape is wound too tight due to irregular winding.</li> <li>● The tape is fully wound to one of the reels.</li> </ul>	<ul style="list-style-type: none"> <li>● Close the holder completely. → 38</li> <li>● Insert a tape. → 38</li> <li>● Try another tape.</li> <li>● Reverse the tape insertion orientation.</li> </ul>
<b>Sound is harsh or high frequencies are not reproduced.</b>	<ul style="list-style-type: none"> <li>● The head is dirty.</li> <li>● The tape is stretched or shrunk.</li> </ul>	<ul style="list-style-type: none"> <li>● Clean the head referring to "Maintenance". → 54</li> <li>● Try another tape.</li> </ul>
<b>Noise is noticeable.</b>	<ul style="list-style-type: none"> <li>● The tape head is magnetized.</li> <li>● External noise is induced.</li> <li>● A tape recorded with Dolby NR ON is being played on this unit.</li> </ul>	<ul style="list-style-type: none"> <li>● Demagnetize the head referring to "Maintenance". → 54</li> <li>● Install the system at a distance from other electric appliances and TV.</li> <li>● This unit can not play tapes recorded with Dolby NR ON with the correct sound quality</li> </ul>
<b>Sound vibrates.</b>	<ul style="list-style-type: none"> <li>● The capstans or pinch rollers are dirty.</li> <li>● The tape is wound irregularly.</li> </ul>	<ul style="list-style-type: none"> <li>● Clean the head referring to "Maintenance". → 54</li> <li>● Wind the tape again by fast forwarding, rewinding or playing from an end to the other. → 38</li> </ul>
<b>Recording cannot be started by pressing the record key.</b>	<ul style="list-style-type: none"> <li>● The recording protect tab of the cassette has been broken.</li> <li>● The cassette holder is not closed completely.</li> <li>● The tape is fully wound to one of the reels.</li> </ul>	<ul style="list-style-type: none"> <li>● Use a cassette with an unbroken recording protect tab or block the hole. → 9</li> <li>● Close the holder completely. → 39</li> <li>● Reverse the tape insertion orientation. → 39</li> </ul>







1. With some tapes, a squeaky noise is produced when the tape is stopped automatically. This is due to the tape protection function, and not a malfunction.
2. Do not use longer tape than 90 minutes tapes, for the tape is too thin and gets easily tangled.



## DVD / CD player unit

Symptom	Cause	Remedy
<b>Playback does not start when the play (▶/⏮) key is pressed.</b>	<ul style="list-style-type: none"> <li>● There is no disc in the player.</li> <li>● There are no signals recorded on the side of the disc being played.</li> </ul>	<ul style="list-style-type: none"> <li>● Load a disc and press the play (▶/⏮) key. → 19</li> <li>● Turn the disc over and properly place it on the disc tray. → 19</li> </ul>
<b>Playback starts but no image/sound is seen/heard.</b>	<ul style="list-style-type: none"> <li>● The TV is not turned on.</li> <li>● The connection cords are not properly connected.</li> </ul>	<ul style="list-style-type: none"> <li>● Turn on the TV.</li> <li>● Properly reconnect the connection cords. → 12</li> </ul>
<b>The picture is disrupted when the image is fast forwarded or fast reversed.</b>	<ul style="list-style-type: none"> <li>● The picture is slightly disrupted during fast forward and fast reverse operations.</li> </ul>	<ul style="list-style-type: none"> <li>● This is not a malfunction.</li> </ul>
<b>No sound is heard.</b>	<ul style="list-style-type: none"> <li>● The volume control of this set is not adjusted properly.</li> <li>● The player is in a special playback mode.</li> </ul>	<ul style="list-style-type: none"> <li>● Set the sound volume to an appropriate level. → 17</li> <li>● Press the play (▶/⏮) key to resume normal playback mode. → 19</li> </ul>
<b>The picture does not look good or the picture/sound quality is poor.</b>	<ul style="list-style-type: none"> <li>● A nearby device is generating noise.</li> <li>● The disc is dirty.</li> <li>● The disc is damaged.</li> <li>● There is condensation on the optical lens.</li> </ul>	<ul style="list-style-type: none"> <li>● Separate this unit as far as possible from the device you think is generating the noise.</li> <li>● Refer to the "Disc handling precautions" section and wipe dirt from the disc. → 9</li> <li>● Use a new disc.</li> <li>● Refer to the "Caution on condensation" section and evaporate the condensation. → 54</li> </ul>
<b>It takes a while for the disc to start playing.</b>	<ul style="list-style-type: none"> <li>● Time is required for the unit to detect the disc type and size and for the rotation of the motor to stabilize. This is not a malfunction.</li> </ul>	<ul style="list-style-type: none"> <li>● Approximately 10 to 20 seconds are required for a disc to start playing, although the time differs depending on the disc.</li> </ul>
<b>The top and bottom of the screen cannot be seen.</b>	<ul style="list-style-type: none"> <li>● The video format of the disc being played does not match that of the connected TV monitor.</li> </ul>	<ul style="list-style-type: none"> <li>● Refer to the "Examples of TV screen display of each video format" section, and use a disc with the appropriate video format for your TV or a TV with the appropriate video format for the disc. → 6</li> </ul>
<b>A VCD cannot be played using menus.</b>	<ul style="list-style-type: none"> <li>● The VCD disc being played is not compatible with P.B.C.</li> </ul>	<ul style="list-style-type: none"> <li>● Menu playback is available only with VCD discs recorded with P.B.C. → 24</li> </ul>
<b>The subtitle is not displayed.</b>	<ul style="list-style-type: none"> <li>● The DVD disc being played does not contain the recording of subtitles.</li> <li>● The subtitle mode is set to off.</li> </ul>	<ul style="list-style-type: none"> <li>● The subtitle cannot be displayed when the DVD disc being played does not contain the recording of subtitles.</li> <li>● Press the <b>SUB TITLE</b> key to switch on the subtitle mode. → 26</li> </ul>
<b>The voice (or subtitle) language cannot be changed.</b>	<ul style="list-style-type: none"> <li>● The DVD disc being played does not contain the recording of more than one audio (or subtitle) language.</li> </ul>	<ul style="list-style-type: none"> <li>● The voice (or subtitle) language cannot be changed when the DVD disc being played does not contain the recording of more than one voice (or subtitle) language. → 25</li> </ul>
<b>The viewing angle cannot be changed.</b>	<ul style="list-style-type: none"> <li>● The DVD disc being played does not contain the recording of more than one angle.</li> <li>● You are attempting to switch the angle in a DVD section where more than one angle is not recorded.</li> </ul>	<ul style="list-style-type: none"> <li>● The viewing angle cannot be changed when the DVD disc being played does not contain the recording of more than one angle. → 27</li> <li>● More than one viewing angle may be recorded only in limited sections in a disc.</li> </ul>
<b>A disc can not be played although the region code is displayed as [ALL].</b>	<ul style="list-style-type: none"> <li>● Some discs can not be played in all regions even when [ALL] is displayed.</li> </ul>	<ul style="list-style-type: none"> <li>● Play a different disc.</li> </ul>

**DVD / CD player unit**

Symptom	Cause	Remedy
<b>Playback will not start even after a title is selected.</b>	<ul style="list-style-type: none"> <li>● A viewing restriction (Parental level) has been set for the disc.</li> </ul>	<ul style="list-style-type: none"> <li>● Check the viewing restriction level (Parental level) setting. →  32</li> </ul>
<b>The viewing restriction level (RATING) cannot be changed.</b>	<ul style="list-style-type: none"> <li>● You have forgotten the viewing restriction (Parental) password.</li> </ul>	<ul style="list-style-type: none"> <li>● Set the initial setup to the factory setup with the following procedure. Pull the plug from the outlet while holding the ENTER key pressed, and then switch the power on again after a few seconds.</li> </ul>
<b>The voice or subtitle language selected in the initial setting is not played.</b>	<ul style="list-style-type: none"> <li>● The DVD disc being played does not contain the recording of the selected voice or subtitle language.</li> </ul>	<ul style="list-style-type: none"> <li>● Use a DVD disc containing the recording of the selected voice or subtitle language. →  30</li> </ul>
<b>No message appears on the TV screen after a key is pressed.</b>	<ul style="list-style-type: none"> <li>● The function for displaying message on the TV screen is set to off.</li> </ul>	<ul style="list-style-type: none"> <li>● Set Display function to on. →  20</li> </ul>
<b>Menu screen messages are not shown in the desired language.</b>	<ul style="list-style-type: none"> <li>● The menu language function (MENU) is not set.</li> </ul>	<ul style="list-style-type: none"> <li>● Set the disc menu language function (MENU) as required. →  25</li> </ul>
<b>Audio is not reproduced in surround sound.</b>	<ul style="list-style-type: none"> <li>● The surround speakers are set to "Not used" in the speaker mode [SPEAKER SETUP function].</li> </ul>	<ul style="list-style-type: none"> <li>● Set the surround speakers to "Used" in the speaker mode setting of initial setup SPEAKER SETUP. →  46</li> </ul>

**Inhibition icon**

Symptom	Cause	Remedy
 <b>The inhibition icon is displayed and remote control is not possible.</b>	<ul style="list-style-type: none"> <li>● Playback is restricted intentionally by the software producer.</li> </ul>	<ul style="list-style-type: none"> <li>● The operation is inhibited. Please try another operation. →  7</li> </ul>

It is prohibited by laws to duplicate, broadcast, perform in public or rent a disc without the permission of the copyright owners.

This product incorporates copyright protection technology that is protected by method claims of certain U.S. patents and other intellectual property right owned by Macrovision Corporation and other rights owners. Use of this copyright protection technology must be authorized by Macrovision Corporation, and is intended for home and other limited viewing uses only unless otherwise authorized by Macrovision Corporation. Reverse engineering or disassembly is prohibited.

**Main unit****[ Amplifier section ]****XD-DV90**

[for Europe and U.K.]

Rated output power during STEREO operation  
(DIN) 1 kHz, 0.7 % T.H.D. at 6 Ω ..... 68 W + 68 WEffective output power during SURROUND operation  
Front (1 kHz, 10 % T.H.D. at 6 Ω) ..... 80 W + 80 W  
Center (1 kHz, 10 % T.H.D. at 4 Ω) ..... 40 W  
Surround (1 kHz, 10 % T.H.D. at 4 Ω) ..... 40 W + 40 W

[for other countries]

Rated output power during STEREO operation  
1 kHz, 0.7 % T.H.D. at 6 Ω ..... 70 W + 70 WEffective output power during SURROUND operation  
Front (1 kHz, 10 % T.H.D. at 6 Ω) ..... 80 W + 80 W  
Center (1 kHz, 10 % T.H.D. at 4 Ω) ..... 40 W  
Surround (1 kHz, 10 % T.H.D. at 4 Ω) ..... 40 W + 40 W

Input sensitivity / impedance

VIDEO/MD ..... 350 mV / 35 kΩ  
MIC (only some areas) ..... 4.0 mV / 4.7 kΩ

Output level / impedance

VIDEO/MD ..... 350 mV / 6.7 kΩ  
SUPER WOOFER PREOUT ..... 2.0 V / 2.2 kΩ**XD-DV80**

[for Europe and U.K.]

Rated output power during STEREO operation  
(DIN) 1 kHz, 0.7 % T.H.D. at 6 Ω ..... 68 W + 68 WEffective output power during SURROUND operation  
Front (1 kHz, 10 % T.H.D. at 6 Ω) ..... 80 W + 80 W  
Center (1 kHz, 10 % T.H.D. at 4 Ω) ..... 40 W  
Surround (1 kHz, 10 % T.H.D. at 4 Ω) ..... 40 W + 40 W

[for other countries]

Rated output power during STEREO operation  
1 kHz, 0.7 % T.H.D. at 6 Ω ..... 70 W + 70 WEffective output power during SURROUND operation  
Front (1 kHz, 10 % T.H.D. at 6 Ω) ..... 80 W + 80 W  
Center (1 kHz, 10 % T.H.D. at 4 Ω) ..... 40 W  
Surround (1 kHz, 10 % T.H.D. at 4 Ω) ..... 40 W + 40 W

Input sensitivity / impedance

VIDEO/MD ..... 350 mV / 35 kΩ  
MIC (only some areas) ..... 4.0 mV / 4.7 kΩ

Output level / impedance

VIDEO/MD ..... 350 mV / 6.7 kΩ  
SUPER WOOFER PREOUT ..... 2.0 V / 2.2 kΩ**XD-DV70**

[for Europe and U.K.]

Rated output power during STEREO operation  
(DIN) 1 kHz, 0.7 % T.H.D. at 6 Ω ..... 68 W + 68 WEffective output power during SURROUND operation  
Front (1 kHz, 10 % T.H.D. at 6 Ω) ..... 80 W + 80 W  
Center (1 kHz, 10 % T.H.D. at 4 Ω) ..... 40 W  
Surround (1 kHz, 10 % T.H.D. at 4 Ω) ..... 40 W + 40 W

[for other countries]

Rated output power during STEREO operation  
1 kHz, 0.7 % T.H.D. at 6 Ω ..... 70 W + 70 WEffective output power during SURROUND operation  
Front (1 kHz, 10 % T.H.D. at 6 Ω) ..... 80 W + 80 W  
Center (1 kHz, 10 % T.H.D. at 4 Ω) ..... 40 W  
Surround (1 kHz, 10 % T.H.D. at 4 Ω) ..... 40 W + 40 W

Input sensitivity / impedance

VIDEO/MD ..... 350 mV / 35 kΩ  
MIC (only some areas) ..... 4.0 mV / 4.7 kΩ

Output level / impedance

VIDEO/MD ..... 350 mV / 6.7 kΩ  
SUPER WOOFER PREOUT ..... 2.0 V / 2.2 kΩ**XD-DV60**

[for Europe and U.K.]

Rated output power during STEREO operation  
(DIN) 1 kHz, 0.7 % T.H.D. at 6 Ω ..... 68 W + 68 WEffective output power during SURROUND operation  
Front (1 kHz, 10 % T.H.D. at 6 Ω) ..... 80 W + 80 W  
Center (1 kHz, 10 % T.H.D. at 4 Ω) ..... 40 W  
Surround (1 kHz, 10 % T.H.D. at 4 Ω) ..... 40 W + 40 W

[for other countries]

Rated output power during STEREO operation  
1 kHz, 0.7 % T.H.D. at 6 Ω ..... 70 W + 70 WEffective output power during SURROUND operation  
Front (1 kHz, 10 % T.H.D. at 6 Ω) ..... 80 W + 80 W  
Center (1 kHz, 10 % T.H.D. at 4 Ω) ..... 40 W  
Surround (1 kHz, 10 % T.H.D. at 4 Ω) ..... 40 W + 40 W

Input sensitivity / impedance

VIDEO/MD ..... 350 mV / 35 kΩ  
MIC (only some areas) ..... 4.0 mV / 4.7 kΩ

Output level / impedance

VIDEO/MD ..... 350 mV / 6.7 kΩ  
SUPER WOOFER PREOUT ..... 2.0 V / 2.2 kΩ**XD-DV50**

[for Europe and U.K.]

Rated output power during STEREO operation  
(DIN) 1 kHz, 0.7 % T.H.D. at 6 Ω ..... 68 W + 68 WEffective output power during SURROUND operation  
Front (1 kHz, 10 % T.H.D. at 6 Ω) ..... 80 W + 80 W  
Center (1 kHz, 10 % T.H.D. at 4 Ω) ..... 40 W  
Surround (1 kHz, 10 % T.H.D. at 4 Ω) ..... 40 W + 40 W

[for other countries]

Rated output power during STEREO operation  
1 kHz, 0.7 % T.H.D. at 6 Ω ..... 70 W + 70 WEffective output power during SURROUND operation  
Front (1 kHz, 10 % T.H.D. at 6 Ω) ..... 80 W + 80 W  
Center (1 kHz, 10 % T.H.D. at 4 Ω) ..... 40 W  
Surround (1 kHz, 10 % T.H.D. at 4 Ω) ..... 40 W + 40 W

Input sensitivity / impedance

VIDEO/MD ..... 350 mV / 35 kΩ  
MIC (only some areas) ..... 4.0 mV / 4.7 kΩ

Output level / impedance

VIDEO/MD ..... 350 mV / 6.7 kΩ  
SUPER WOOFER PREOUT ..... 2.0 V / 2.2 kΩ**[ Tuner section ]**

FM tuner section

Tuning frequency range ..... 87.5 MHz ~ 108 MHz

AM (MW) Tuner section

Tuning frequency range ..... 531 kHz ~ 1,602 kHz

LW Tuner section (for U.K. only)

Tuning frequency range ..... 153 kHz ~ 279 kHz

**[ Cassette deck section ]**Track ..... 4-track, 2-channel stereo  
Recording system ..... AC bias system  
(Frequency: 105 kHz)

Heads

TAPE A Playback head ..... 1  
TAPE B Playback / recording head ..... 1  
Erasing head ..... 1

Fast winding time ..... Approx. 100 seconds (C-60 tape)

### [ DVD/CD/VIDEO CD player section ]

Laser .....	Semiconductor laser
Wow & Flutter .....	Less than unmeasurable Limit
Video output format .....	NTSC/PAL/SECAM
<b>VIDEO OUTPUT</b>	
Composit video output level/impedance .....	1 Vp-p (75 Ω)
<b>S-video output</b>	
Y output level/impedance .....	1 Vp-p (75 Ω)
<b>C output level/impedance</b>	
NTSC .....	0.286 Vp-p (75 Ω)
PAL .....	0.3 Vp-p (75 Ω)
SECAM .....	0.3 Vp-p (75 Ω)
Compression format .....	MPEG1/MPEG2
Digital output .....	-15 dBm ~ 21 dBm (Wave length 660 mm)

### [ General ]

Power consumption .....	230 W
Dimensions .....	W: 270 mm H: 326 mm D: 360 mm
Weight (net) .....	10.9 kg

### Front Speakers (LS-N90V)

Enclosure .....	Bass-reflex type (Magnetically shielded)
<b>Speaker configuration</b>	
Woofers .....	160 mm, cone type
Tweeters .....	50 mm, cone type
Super Tweeter .....	25 mm, Piezo type
Impedance .....	6 Ω
Maximum input level .....	100 W
Dimensions .....	W: 220 mm H: 330 mm D: 297 mm
Weight (net) .....	4.2 kg (1 piece)

### Front Speakers (LS-N70V)

Enclosure .....	Bass-reflex type (Magnetically shielded)
<b>Speaker configuration</b>	
Woofers .....	130 mm, cone type × 2
Tweeters .....	65 mm, cone type × 2
Super Tweeter .....	25 mm, Piezo type
Impedance .....	6 Ω
Maximum input level .....	100 W
Dimensions .....	W: 235 mm H: 410 mm D: 292 mm
Weight (net) .....	6.6 kg (1 piece)

### Front Speakers (LS-N50V)

Enclosure .....	Bass-reflex type (Magnetically shielded)
<b>Speaker configuration</b>	
Woofers .....	130 mm, cone type × 2
Tweeters .....	65 mm, cone type × 2
Super Tweeter .....	25 mm, Piezo type
Impedance .....	6 Ω
Maximum input level .....	100 W
Dimensions .....	W: 235 mm H: 410 mm D: 292 mm
Weight (net) .....	6.6 kg (1 piece)

### Center Speakers (CRS-N90V)

Enclosure .....	Bass-reflex type (Magnetically shielded)
Speaker configuration .....	100 mm, cone type, Full Range
Impedance .....	4 Ω
Maximum input level .....	40 W
Dimensions .....	W: 261 mm H: 124mm D: 193mm
Weight (net) .....	1.3 kg



1. KENWOOD follows a policy of continuous advancements in development. For this reason specifications may be changed without notice.
2. Sufficient performance may not be possible at very low temperatures (0°C or less).





---

# KENWOOD

***For your records***

Record the serial number, found on the back of the unit, in the spaces designated on the warranty card, and in the space provided below. Refer to the model and serial numbers whenever you call upon your dealer for information or service on this product.

Model \_\_\_\_\_ Serial Number \_\_\_\_\_



## Free Manuals Download Website

<http://myh66.com>

<http://usermanuals.us>

<http://www.somanuals.com>

<http://www.4manuals.cc>

<http://www.manual-lib.com>

<http://www.404manual.com>

<http://www.luxmanual.com>

<http://aubethermostatmanual.com>

Golf course search by state

<http://golfingnear.com>

Email search by domain

<http://emailbydomain.com>

Auto manuals search

<http://auto.somanuals.com>

TV manuals search

<http://tv.somanuals.com>