

KENWOOD

TELEVISION WITH DVD RECEIVER

KVT-920DVD

INSTRUCTION MANUAL

KENWOOD CORPORATION

This player has been designed to play back the DVD software which has been encoded for specific region areas. It cannot play back the DVD software encoded for other region areas than the region areas for which it has been designed.



© PRINTED IN JAPAN B64-1784-10 (E) (DT)

Before Use	4	Operating the Buttons for Basic Function	24
Monitor Control Function	8	<ul style="list-style-type: none"> •Adjusting the Volume •Turning Attenuator On/Off •Switching Source Mode •Inserting Discs •Seeking/ Searching •Fast Forwarding and Reversing Disc Play •Ejecting Discs 	
<ul style="list-style-type: none"> •Opening/ Closing the Monitor •Power Off •Switching the Monitor's Picture •Selecting the TV/Video Screen Mode •Adjusting the Picture Quality/ Slide Position •Turning the Monitor Picture Off •Switching the AV Output •Adjusting the Volume 		Basic Operation for Source Control Screen	25
Menu Function	10	<ul style="list-style-type: none"> •Increasing the volume •Decreasing the volume •Switching to the Next Source Mode •Switching to the Previous Source Mode •Switching to the Menu Screen •Displaying the Quick Effect Control Screen •Switching to the Graphic Screen 	
<ul style="list-style-type: none"> •Switching to the Sound Effect Setting Menu Screen •Switching to the Source Control Screen •Source Icon change •Switching to the Setup Screen •cancelling the Menu Screen 		TV Control Function on the TV pictures	26
Setup Menu Function	11	<ul style="list-style-type: none"> •Selecting the Preset Bands •Selecting the Channels •Displaying the Information 	
<ul style="list-style-type: none"> •Selecting to the RDS Tuner Setup Screen •Selecting to the DAB Tuner Setup Screen •Selecting to the Clock Adjustment Screen •Selecting to the System Setup Screen •Selecting to the TV Area Setting Screen •Selecting to the Code Security Screen •Selecting to the Touch Panel Adjustment Screen •Switching to the DVD Setup Screen •Switching the Setup Page •Cancelling the Setup Screen 		TV Control Function	27
System Setup Function	12	<ul style="list-style-type: none"> •Selecting the Preset Bands •Selecting the Video Inputs •Selecting the Seek Mode •Selecting the Channels •Station Preset Memory •Auto Memory Entry •Recalling a Preset Station •Switching to the TV List Screen •Switching to the Name Set Screen •Switching the List •Recalling a Preset Station •Returning to the Source Control Screen 	
<ul style="list-style-type: none"> •Setting the AV Input-1 Mode •Setting the AV Input-2 Mode •Setting the AV Output Mode •Setting the Dual Zone mode •Selecting the Dual Zone Speaker •Setting the Touch Sensor Tone •Setting the TV Control by Remote On/Off •Setting the Auto Scroll Display Function •Setting the On Screen Display Function •Selecting the Information on the Graphic Screen •Demonstration Function •Selecting the Point Marker Type 		FM/AM Tuner Control Function	29
RDS Setup Function	14	<ul style="list-style-type: none"> •Selecting the FM Bands •Selecting the AM Band •Selecting the Seek Mode •Tuning •Station Preset Memory •Auto Memory Entry •Recalling a Preset Station •Turning the Local Seek Function On/Off •Switching to the PTY Search Screen •Turning the Monaural Reception On/Off •Switching Display for Radio Text •Scrolling the Radio Text •Switching to the FM/AM List Screen •Switching the List •Recalling a Preset Station •Returning to the Source Control Screen •Traffic Information Function •Seeking to a Different Traffic Information Station •Presetting the Volume for Traffic Information/News •Searching the Selected Programme Type •Selecting the Type of Programme to be Received •Returning to the Tuner Control Screen 	
<ul style="list-style-type: none"> •News Bulletin Function with PTY News Timeout Setting •Alternative Frequency Function On/Off •Changing the PTY Display Language to French, Dutch, French, German, Norwegian, Portuguese, Spanish and Swedish •Auto TP Seek Function On/Off •Restricting RDS Region On/Off 		DVD/VCD Control Function on the Pictures	34
DVD, VCD Setup Function	16	<ul style="list-style-type: none"> •Chapters Search •Displaying the Information •Switching the DVD Menu Screen •Switching the Menu Control Screen •Changing the Language for Subtitle •Changing the Language for Voice •Switching the viewing angle •Viewing zoom •cancelling the Menu Screen 	
<ul style="list-style-type: none"> •Setting the Screen Mode •Setting the Priority Language for Menu •Setting the Priority Language for Subtitle •Setting the Priority Language for Voice •Setting the Angle Mark Display •Selecting the Dynamic Range •Setting the Optical Output Mode •Switching to the Rating Level (parental lock) Setting Screen •PBC(Playback Control) Function On/Off for VCD version 2.0 		VCD Control Function on the Pictures	35
Language Select Screen	18	<ul style="list-style-type: none"> •Next Play/ Previous Play •Tracks Search •Displaying the Information 	
<ul style="list-style-type: none"> •Inputting the Language Code •Returning to the Original Language •Returning to the DVD setup Screen 		DVD/VCD/CD Control Function	
Parental Setup Screen	20	DVD(/VCD) Control Screen	36
<ul style="list-style-type: none"> •Setting the password •Setting the Parental Level •Returning to the DVD setup Screen 		<ul style="list-style-type: none"> •Forward search and reverse search •Chapters/Scenes/Tracks Search •Slow playback •Pausing and Restarting Disc Play •Frame-by-frame playback •Stopping playback 	
Click Adjustment Function	21		
<ul style="list-style-type: none"> •Turning the Automatic Time Adjustment On/Off •Adjusting the Time Manually •Setting the Minutes to "00" 			
TV Area Setup Function	22		
<ul style="list-style-type: none"> •Selecting the Preset Bands •Selecting the Reception Area 			
Touch Panel Adjustment Function	22		
Code Security Function	23		

•Selecting the Time Display for Disc	
CD Control Screen	37
•Pausing and Restarting Disc Play	
•Track Search	
•Fast Forwarding and Reversing Disc Play	
•Stopping playback	
•Track Repeat Function	
•Track Scan Function	
•Track Random Play Function	
•To Scroll Manually	
•Selecting the Time Display	
•Switching to the Name Set Screen	
External Disc Control Function.....	39
•Pausing and Restarting Disc Play	
•Track Search	
•Fast Forwarding and Reversing Disc Play	
•Track Repeat Function	
•Track Scan Function	
•Track Random Play Function	
•Disc Search	
•Disc Repeat Function	
•Magazine Random Play Function	
•Selecting the Name or Title Display for Discs	
•To Scroll Manually	
•Selecting the Time Display for Discs	
•Switching to the Name Set Screen	
•Selecting the DNPS or CD Text	
•Changing to the Disc List	
•Selecting the Disc	
•Returning to the Source Control Screen	
Name Set Function	42
Driving Screen Function.....	42
Sound Effect Menu Function	43
•Switching to the Audio Control Screen	
•Switching to the Crossover Network Setting Screen	
•Switching to the Position Setting Screen	
•Switching to the Channel Level Setting Screen	
•Switching to the Digital Effect Setting Screen	
•Switching to the Parametric Equalizer Screen	
•Ending the Sound Effect Menu Screen	
Audio Control Function	
Audio Control Screen.....	44
•Adjusting the Bass Level	
•Adjusting the Treble Level	
•Adjusting the Non-Fading Preout Level	
•Adjusting the Sub Woofer Levels	
•Adjusting the Balance Levels	
•Adjusting the Fader Levels	
•Turning the Loudness On/Off	
•External Amp Control	
•Adjusting the Volume Offset	
•Switching to the Sound Preset Screen	
•Recalling the Kenwood Preset Sound	
•Adjusting the Centre Frequency of the Bass	
•Adjusting the Bass Quality Factor	
•Adjusting the Centre Frequency of the Treble	
•Switching the Bass Extend mode On/Off	
•Setting the Speaker Type	
•Storing Your Sound Settings	
•Ending the Audio Preset Screen	
Crossover Network Screen.....	46
•Adjusting the High-pass filter for Front output	
•Adjusting the High-pass filter for Rear output	
•Adjust the frequency of the Low-pass filter for Non-Fading output.	
•Setting the phase for Non-Fading output	
•Returning to the Sound Effect Menu Screen	
5.1 Channels Surround Processor Control Function	
Digital Effect Setting Function	47
•Selecting the Digital Input Mode	
•Using the DOLBY PRO LOGIC	
•Selecting the Acoustic Image	
•Turning the Centre Output On/Off	
•Turning the Sub Woofer Output On/Off	
•Selecting the Dynamic Range	
•Selecting the Multi Channel	
•Defeat	
•Returning to the Sound Effect Menu Screen	
Position Setting Screen	48
•Selecting the Position Mode	
•Adjusting the Room Size Mode	
•Returning to the Sound Effect Menu Screen	
Channel Level Setting Screen	49
•Test Signal	
•Adjusting the Front Left Speaker	
•Adjusting the Front Right Speaker	
•Adjusting the Rear Left Speaker	
•Adjusting the Rear Right Speaker	
•Adjusting the Centre Speaker	
•Returning to the Sound Effect Menu Screen	
Crossover Network Screen.....	50
•Adjusting the High-pass filter for Rear output	
•Adjusting the High-pass filter for Front output	
•Adjust the frequency of the Low-pass filter for Sub Woofer output	
•Adjusting the High-pass filter for Centre output	
•Setting the phase for Sub Woofer output	
•Storing your settings of the Crossover network/Delay Time	
•Switching to the Delay Time Setting Screen	
•Returning to the Sound Effect Menu Screen	
Delay Time Setting Screen	51
•Adjusting the Front Left Speaker	
•Adjusting the Front Right Speaker	
•Adjusting the Rear Left Speaker	
•Adjusting the Rear Right Speaker	
•Adjusting the Centre Speaker	
•Adjusting the Sub Woofer	
•Ending the Delay Time Setting Screen	
Parametric Equalizer Screen.....	52
•Selecting the Adjust Band	
•Adjusting the Centre Frequency	
•Adjusting the Quality Factor	
•Adjusting the Gain	
•Setting the Speaker Type	
•Recalling the Kenwood Preset Sound	
•Storing Your Sound Settings	
•Returning to the Sound Effect Menu Screen	
Quick Effect Function	53
•Adjusting the Balance Levels	
•Adjusting the Fader Levels	
•Recalling Your Settings of the Crossover Network/Delay	
•Recalling Your Sound Settings	
•External Amp Control	
•Returning to the Source Control Screen	
Remote Control Function	54
Installation	56
Accessories	56
Installation Procedure	56
Installation	57
Connection	60
Troubleshooting Guide	65
Specifications.....	68

The illustrations of the display and the panel appearing in this manual are examples used to explain more clearly how the controls are used. Therefore, what appears on the display in the illustrations may differ from what appears on the display on the actual equipment, and some of the illustrations on the display may represent something impossible in actual operation.

Before Use

The marking of products using lasers (Except for some areas)

**CLASS 1
LASER PRODUCT**

The label is attached to the chassis/case and says that the component uses laser beams that have been classified as Class 1. It means that the unit is utilizing laser beams that are of a weaker class. There is no danger of hazardous radiation outside the unit.

▲ WARNING

To prevent injury and/or fire, take the following precautions:

- Ensure that the unit is securely installed. Otherwise it may fly out of place during collisions and other jolts.
- When extending the ignition, battery or ground cables, make sure to use automotive-grade cables or other cables with an area of 0.75mm² (AWG18) or more to prevent wire deterioration and damage to the wire coating.
- To prevent short circuits, never put or leave any metallic objects (e.g., coins or metal tools) inside the unit.
- If the unit starts to emit smoke or strange smells, turn off the power immediately and consult your Kenwood dealer.
- Do not touch the liquid crystal fluid if the LCD is damaged or broken due to shock. The liquid crystal fluid may be dangerous to your health or even fatal. If the liquid crystal fluid from the LCD contacts your body or clothing, wash it off with soap immediately.

▲ CAUTION

To prevent damage to the machine, take the following precautions:

- Make sure to ground the unit to a negative 12V DC power supply.
- Do not open the top or bottom covers of the unit.
- Do not install the unit in a spot exposed to direct sunlight or excessive heat or humidity. Also avoid places with too much dust or the possibility of water splashing.
- Do not subject the faceplate to excessive shock, as it is a piece of precision equipment.
- When replacing a fuse, only use a new one with the prescribed rating. Using a fuse with the wrong rating may cause your unit to malfunction.
- To prevent short circuits when replacing a fuse, first disconnect the wiring harness.
- Do not use any screws except for the ones provided. The use of improper screws might result in damage to the main unit.
- You cannot view video pictures whilst the vehicle is moving. To enjoy TV/video pictures, find a safe place to park and engage the parking brake.

NOTE

- If you experience problems during installation, consult your Kenwood dealer.
- If the unit does not seem to be working right, try pressing the reset button first. If that does not solve the problem, consult your Kenwood dealer.

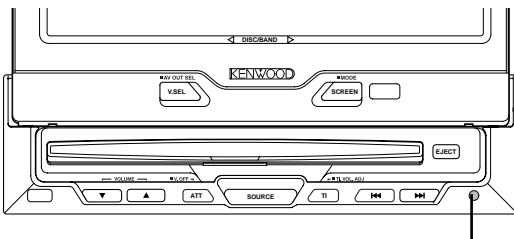

Reset button

Mask key

If you have transmitted the Mask Key's signal once to the unit in advance, you will have to transmit it once again if the unit has been removed from the battery.

▲ CAUTION

Do not loose the "Mask Key". If power is disconnected from the unit, correct operation can only be restored by the "Mask Key's" signal. The "Mask Key" will also be required for service repair.

NOTE

If you send products in for repair that include a mask key, make sure to present the unit together with the mask key.

Cleaning the Unit

If the front panel gets dirty, turn off the power and wipe the panel with a dry silicon cloth or soft cloth.

▲ CAUTION

Do not wipe the panel with a stiff cloth or a cloth dampened by volatile solvents such as paint thinner and alcohol. They can scratch the surface of the panel and/or remove the indicator letters.

Screen brightness during low temperatures

When the temperature of the unit falls such as during winter, the liquid crystal panel's screen will become darker than usual. Normal brightness will return after using the monitor for a whilst.

Loading and Replacing the Batteries for the Remote

▲ CAUTION

Do not set the remote on hot places such as above the dashboard.

1. Use two "AAA" batteries. Slide the cover while pressing downwards to remove it as illustrated.
2. Insert the batteries with the ⊕ and ⊖ poles aligned properly following the illustration inside the case.

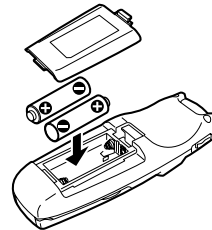

▲ WARNING

Store unused batteries out of the reach of children. Contact a doctor immediately if the battery is accidentally swallowed.

NOTE

- The provided batteries are intended for use in operation checking, and their service life may be short.
- When the remote controllable distance becomes short, replace both of the batteries with new ones.

Cleaning the disc slot

As dust can accumulate in the disc slot, clean it occasionally. Your discs can get scratched if you put them in a dusty disc slot.

Lens Fogging

Right after you turn on the car heater in cold weather, dew or condensation may form on the lens in the disc player of the unit. Called lens fogging, discs may be impossible to play. In such a situation, remove the disc and wait for the condensation to evaporate. If the unit still does not operate normally after a whilst, consult your Kenwood dealer.

Playing a disc that is dirty, scratched or warped can cause the sound to skip and the unit to operate incorrectly, resulting in worsened sound quality. Take the following precautions to prevent your discs from getting scratched or damaged.

Handling discs

- Do not touch the recorded side of the disc (i.e., the side opposite the label) when holding it.

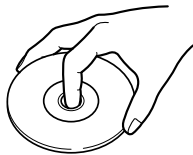

- The reflective film on a CD-R or a CD-RW is more fragile than that on an ordinary music CD, and may peel off if scratched. Fingerprints on a CD-R or CD-RW are also more likely to cause skipping when the disc is played. For these reasons, handle the disc very carefully. Detailed handling instructions will appear on the CD-R or CD-RW package: read this information carefully before using the disc.
- Do not stick tape on either side of the disc.

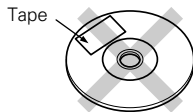

Storing discs

- Do not store discs in areas exposed to direct sunlight (such as a car seat or the dashboard) or other hot places. A CD-R or CD-RW is more susceptible than a music CD to damage from high temperatures and humidity, and in some cases, may become unusable if left in the car for long periods of time.
- Remove discs from the unit when not listening to them for a while, and put them back in their cases. Do not pile up discs that are removed from their cases or prop them against something.

Cleaning discs

If a disc has become dirty, wipe it off gently using a commercially available cleaning cloth or a soft cotton cloth, starting from the centre of the disc and moving outward. Do not clean discs with conventional record cleaners, anti-static formulas, or chemicals such as paint thinner or benzene.

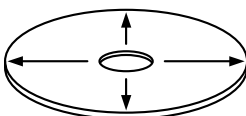

Checking New discs for Burrs

When playing a new disc for the first time, check that there are not any burrs stuck to the perimeter of the disc or in the central hole. Discs with burrs stuck on them may not load properly or may skip whilst playing. Remove burrs using a ballpoint pen or a similar utensil.

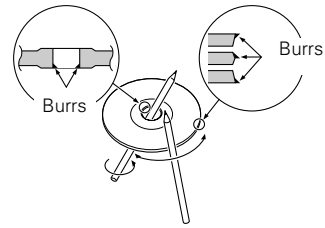

Do Not Load CD Accessories in Slot

Do not use commercially available CD accessories that can be loaded into the CD slot, such as stabilisers, protective sheets, or CD cleaning discs, since they can cause the unit to malfunction.

Removing the disc

Only remove the disc from the machine in a horizontal direction. You may damage the surface of the disc if you try pulling it down as it ejects.

Do Not Use Special Shape Discs

- Be sure to use round shape Discs only for this unit and do not use any special shape Discs. Use of special shape Discs may cause the unit to malfunction.

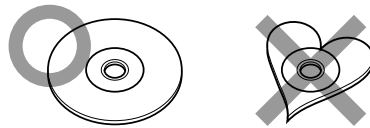

- CD-Rs and CD-RWs which have not undergone finalization processing cannot be played. (For more information on finalization processing, refer to the manual for your CD-R/CD-RW writing software or CD-R/CD-RW recorder.) Additionally, depending on the recording status, it may prove impossible to play certain Discs recorded on CD-R or CD-RW.

Do Not Use discs with Sticker on the Labelled Side

Do not use the disc with the label sticker stuck on it. Using such a disc may cause the disc to be deformed and the sticker to peel off, resulting in malfunction of the unit.

Before Use

Region codes in the world

The DVD players are given a region code according to the country or area it is marketed, as shown in the following map.

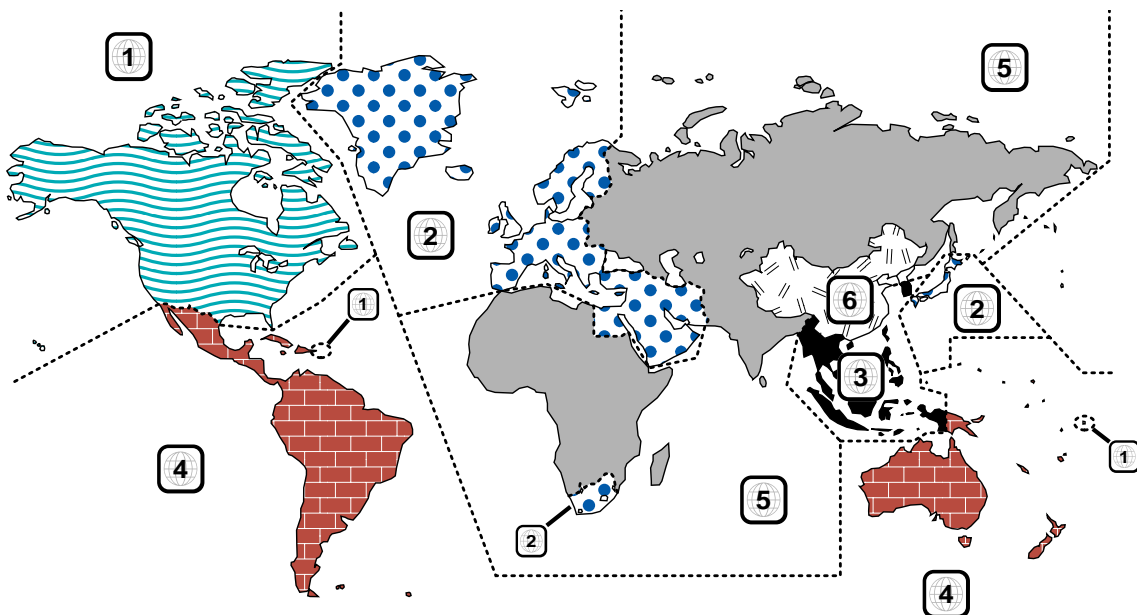

This player has been designed to play back the DVD software which has been encoded for specific region areas. It cannot play back the DVD software encoded for other region areas than the region areas for which it has been designed.

The KVT-920DVD will playback any disc whose region number is 2 (or All).

Restrictions due to difference between discs

Inhibition icon



Some DVD and VCD discs can be played only in certain playback modes according to the intentions of the software producers. As this player plays discs according to their intentions, some functions may not work as intended by you. Please be sure to read the instructions provided with each disc. When an inhibition icon is displayed on the monitor, it indicates that the disc being played is under the restriction as described above.

Unplayable discs

This player cannot play back any of the following discs.

- MP3 recorded CD
- SVCD/HQVCD discs
- VSD discs
- CD-G/CD-EG/CD-EXTRA discs (Only the audio can be reproduced.)
- Photo CD discs (Never attempt to play them.)
- DVD-ROM discs
- DVD-R/DVD-RW/DVD-RAM discs
- DVD discs (Only the audio part can be reproduced.)

Icons on the DVD discs

Icon	Description
	Indicates the region code where the disc can be played.
	Number of voice languages recorded with the audio function. The number in the icon indicates the number of voice languages. (Max. 8 languages)
	Number of subtitle languages recorded with the subtitle function. The number in the icon indicates the number of subtitle languages. (Max. 32 languages)
	Number of angles provided by the angle function. The number in the icon indicates the number of angles. (Max. 9 angles)
	Aspect ratios that can be selected. "LB" stands for Letter Box and "PS" for Pan/Scan. In the example on the left, the 16:9 video can be converted into letter box video.

Glossary

DVD: Digital Versatile Disc

A type of disc which contains recording of audio/video packaged media with high video and audio quality, such as a movie, featuring large recording capacity and digital signal processing capability.

VIDEO CD (VCD)

A type of CD which contains the recording of moving images. It compresses image information by about 1/120 and audio information by about 1/6 and accommodates up to 74 minutes of recording in a disc with the same diameter as ordinary music CD of 12 cm.

Some VCDs do not have the P.B.C. compatibility and are capable of playback only, while some are P.B.C.-compatible and are capable of various special playback control operations. This player can play both of these VCDs.

MPEG: Moving Picture Expert Group (DVD, VCD)

This is an international standard for digital video and audio compression and decompression in media.

Dolby Digital

This is a digital audio compression technology developed by Dolby Laboratories. It is compatible with 5.1-channel surround audio as well as normal stereo (2-channel) audio and can accommodate a large amount of audio data efficiently in a disc.

DTS

Name of a digital surround system developed by Digital Theater Systems, Inc.

Top menu/menu (DVD)

Some DVDs display more than one title in a screen. This screen is referred to as the title menu.

The DVD menu is the item display (menu screen) for use in setting operations. The DVD menu can be recalled any time during playback to perform settings according to the current software, including the audio switching between Dolby Digital and PCM, switching of language used in the subtitles and spoken voice.

Title number (DVD)

The title is the largest unit of video and audio recorded in a DVD. It usually corresponds to a single movie of video software or an album (sometimes a piece of music) of music software. The numbers assigned to individual titles are referred to as the title numbers.

Chapter number (DVD)

The chapter is a section of video and audio recorded in a DVD. A title is composed of several chapters. The numbers assigned to individual chapters are referred to as the chapter numbers.

Subtitles (DVD)

Some DVD discs contains the recording of more than one subtitle language. This player allow you to select one of the recorded subtitle languages during playback. If the subtitle language is set to "Automatic" in the initial setup, subtitles are displayed only when the spoken voice is in other language than the initial set language.

Track number (CD, VCD)

A track is also a section of video and audio recorded in a disc. The numbers assigned to individual tracks are referred to as the track numbers.

With most of music Discs, a track is assigned to a piece of music. However, with a VCD, the sections of the contents do not always correspond to the assigned tracks.

As (special) playback functions such as skipping and programming of ordinary Discs are based on track number data, such playback functions are sometimes impossible with some VCDs.

P.B.C.: Play-Back Control (VCD)

When a VIDEO CD carries "Play Back Control capable" or similar message on the disc or jacket, desired scenes and information can be played back in an interactive manner using a hierarchical structure while viewing the menu screens displayed on the TV screen.

This product incorporates copyright protection technology that is protected by method claims of certain U.S. patents and other intellectual property rights owned by Macrovision Corporation and other rights owners. Use of this copyright protection technology must be authorized by Macrovision Corporation, and is intended for home and other limited viewing uses only unless otherwise authorized by Macrovision Corporation. Reverse engineering or disassembly is prohibited.

Manufactured under license from Dolby Laboratories. "Dolby" and the double-D symbol are trademarks of Dolby Laboratories. Confidential Unpublished Works. ©1992-1997 Dolby Laboratories, Inc. All rights reserved.

"DTS" and "DTS Digital Out" are trademarks of Digital Theater Systems, inc.

Monitor Control Function



Screen Mode

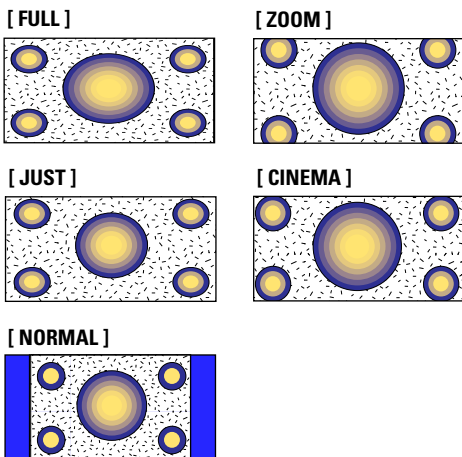

A Opening/ Closing the Monitor

Opening the Monitor

- 1 Set the vehicle's parking brake.
- 2 Press the OPEN button. The monitor will open.
- 3 Once the monitor is fully out, lift it by hand and set it to an easily visible angle.

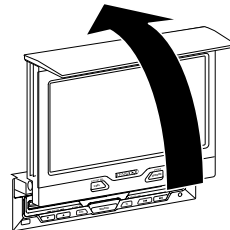

Closing the Monitor

Set the lower the monitor so that it is completely flat. The monitor is then drawn in automatically after one second.

CAUTION

The gear shift lever or other parts may interfere with the monitor when it opens. If so, move the gear shift lever (being sure to do so safely) before operating the set. (The monitor is drawn back in automatically if it cannot be opened normally due to an obstacle.)

NOTE

- The monitor cannot be opened unless the parking brake is set.
- The position to which the monitor slides when the power is turned on can be set. (Refer to the angle control screen(Page 9).

A Power Off

- Hold down the OPEN button for one second or more to turn the set's power off.
- Press the OPEN button to turn the power on.

B Switching the Monitor's Picture

Each time you press the V.SEL button, the monitor's picture switches as follows:

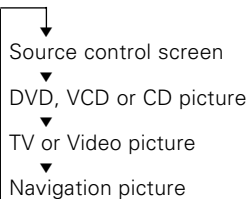

NOTE

When the "AV-IN2" setting to "Back Camera", the switching items become the Back Camera picture. (Refer to system setup screen(page 12))

CAUTION

You cannot view television and video pictures whilst the vehicle is moving. To enjoy television and video pictures, find a safe place to park and engage the parking brake.

E Selecting the TV/Video Screen Mode

Each time you press the SCREEN button for one second or more, the screen mode switches as follows:

- ↓
[FULL] : Full picture mode
- ↓
[JUST] : Just picture mode
- ↓
[CINEMA]: Cinema picture mode
- ↓
[ZOOM]: Zoom picture mode
- ↓
[NORMAL]: Normal picture mode

NOTE

You cannot operate when the navigation picture is displayed.

E Adjusting the Picture Quality/ Slide Position

Press the SCREEN button, the screen control screen to be displayed.

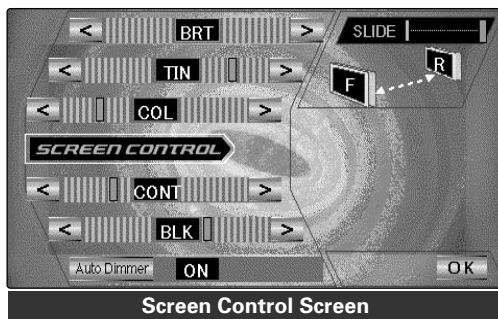

Adjusting the Picture Quality

Each time you touch [<] or [>] to adjust the value.

[BRT]

Touch [>] for a brighter screen.
Touch [<] for a darker screen.

[TIN]

Touch [>] for a stronger red level.
Touch [<] for a stronger green level.

[COL]

Touch [>] for a deeper colour.
Touch [<] for a paler colour.

[CONT]

Touch [>] for a stronger contrast.
Touch [<] for less contrast.

[BLK]

Touch [>] for a stronger black level.
Touch [<] for less black level.

NOTE

- The [TIN] and [COL] cannot be adjusted for the navigation picture, video picture or the control screen.
- The [TIN] cannot be adjusted for the picture of PAL/SECAM.
- Separate picture quality settings can be stored for the television, video 1, video 2, DVD, VCD, graphic screens and navigation screens and for day and night use.

Turning the Auto Dimmer Function On/Off

Touch [Auto Dimmer] to switch the function on and off.

" ON "

Backlight brightness is automatically adjusted according to the surrounding brightness as detected by the auto dimmer sensor of the monitor unit.

" OFF "

Backlight brightness is adjusted using the picture quality adjustment.

Adjusting the Slide Position [SLIDE]

Touch [F] to slide the monitor to the front.
Touch [R] to slide the monitor to the back.

Ending the Screen Control Screen

Touch [OK].

D Turning the Monitor Picture Off

Hold down the ATT button for one second or more to turn the monitor's picture off and on.

NOTE

The picture reappears when the one of the SCREEN or V.SEL buttons is pressed.

B Switching the AV Output

Each time you press the V.SEL button for one second or more, the AV output mode switches as follows:

- ↓
DVD : DVD/VCD/CD Picture/sound
- ↓
TV : Television picture/sound
- ↓
AV-IN1 : Video 1 picture/sound
- ↓
AV-IN2 : Video 2 picture/sound

C Adjusting the Volume

Press the ▲ button to increase the volume.
Press the ▼ button to decrease the volume.

Menu Screen

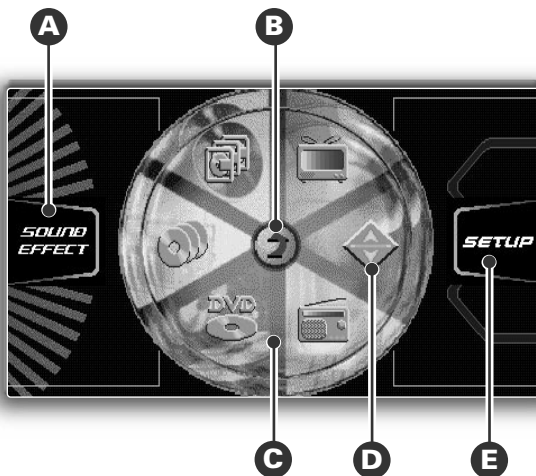

When using for the first time, the menu screen appears.

A Switching to the Sound Effect Setting Menu Screen

Touch [SOUND EFFECT] to switch the sound effect menu screen. <see p.43>

NOTE

You cannot operate when the standby mode is selected.

C Switching to the Source Control Screen

Touch the source icons to switch the source control screen as follows:

 : Switching to the FM/AM tuner control screen.<see p.28>

 : Switching to the TV (or video) control screen.<see p.26>





 : Switching to the built-in DVD/VCD/CD player control screen.<see p.36>

 : Switching to the external CD player control screen.<see p.39>(When the CD player is connected)

 : Switching to the disc(CD) changer control screen.<see p.39>(When the CD changer is connected)

 : Switching to the disc(MD) changer control screen.<see p.39>(When the MD changer is connected)

 : Switching to the DAB tuner control screen. (When the DAB tuner is connected)(Refer to the DAB tuner's instruction manual for DAB controls)

 : Switching to the AUX mode screen.(When the KCA-S210A or CA-1AX is connected)

 : Switching to the standby mode screen.

D Source Icon change

When there are more than 7 sources Items, [] is displayed.

The selectable source icons are switched in order to touch [].

E Switching to the Setup Screen

Touch [SET UP] to switch the setup menu screen. <see p.11>

B Cancelling the Menu Screen

Touch [] to switch to the source control screen for the current source.

Setup Menu Function

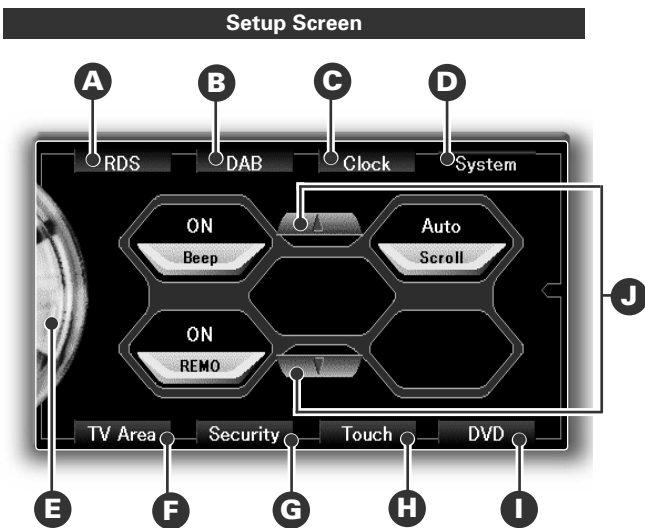

A **Selecting to the RDS Tuner Setup Screen**

Touch [RDS] to switch the RDS Tuner Setup Screen. <see p.14>

B **Selecting to the DAB Tuner Setup Screen**

Touch [DAB] to switch the DAB Tuner Setup Screen.
<When the DAB tuner is connected>
(Refer to the DAB tuner's instruction manual for DAB tuner controls.)

C **Selecting to the Clock Adjustment Screen**

Touch [Clock] to switch the Clock Adjustment Screen. <see p.21>

D **Selecting to the System Setup Screen**

Touch [System] to switch the System Setup Screen. <see p.12>

F **Selecting to the TV Area Setting Screen**

Touch [TV Area] to switch to the TV Area Setting Screen (Page 22).

G **Selecting to the Code Security Screen**

Touch [Security] to switch to the Code Security Screen. <see p.23>

H **Selecting to the Touch Panel Adjustment Screen**

Touch [Touch] to switch to the Touch Panel Adjustment screen. <see p.22>

I **Selecting to the DVD Setup Screen**

Touch [DVD] to switch to the DVD/VCD Setup Screen. <see p.16>

NOTE

Cannot be operated while the DVD/VCD is being operated. If you want to change the setting, do it from the DVD/VCD control screen (page 36) in stop state.

J **Switching the Setup Page**

Touch [▼] to switch to the next page.
Touch [▲] to switch to the previous page.

NOTE

If there is only one setup page it is not displayed.

E **Cancelling the Setup Screen**

Touch this icon to return to the menu screen.

System Setup Screen-1

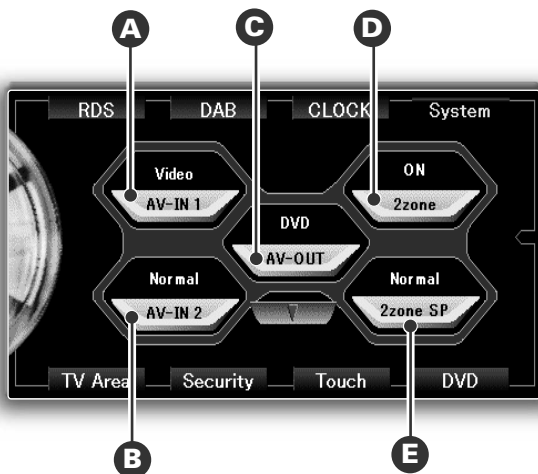

System Setup Screen-2

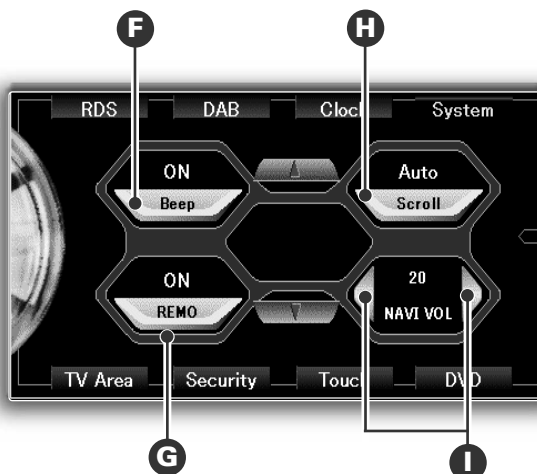

A Setting the AV Input-1 Mode

Each time you touch [AV-IN1], the mode switches as follows:

" Navigation "

When the Navigation unit is connected to the AV-INPUT1 terminal.

" Video "

When the Video Deck is connected to the AV-INPUT1 terminal.

B Setting the AV Input-2 Mode

Each time you touch [AV-IN2], the mode switches as follows:

" Back Camera "

When the Back Camera unit is connected to the AV-INPUT2 terminal.

" Normal "

When the Video Deck is connected to the AV-INPUT2 terminal.

C Setting the AV Output Mode

Each time you touch [AV-OUT], the mode switches as follows:

" DVD "

Picture/sound from DVD/VCD/CD.

" TV "

Picture/sound from television.

" AV-IN1 "

Picture/sound from AV-IN1 terminals.

" AV-IN2 "

Picture/sound from AV-IN2 terminals.

D Setting the Dual Zone mode

<When the 5.1 ch DSP unit is connected>

The following operation allows separate sound sources to control the output of the front and rear speakers.

Each time you touch [2zone], the mode switches as follows:

" ON "

The dual zone system function is on.

" OFF "

The dual zone system function is off.

E Selecting the Dual Zone Speaker

<When the 5.1 ch DSP unit is connected>

You can select whether to output AV-OUT sound from the rear or from the front.

Each time you touch [2zone SP], the mode switches as follows:

" Normal "

AV-OUT sound send to the rear front speaker.

" Reverse "

AV-OUT sound send to the front speaker.

NOTE

No display [2zone SP] when the "2zone" is set to "OFF".

F Setting the Touch Sensor Tone

Each time you touch [Beep], the mode switches as follows:

" ON "

Touch sensor tone is turned on

" OFF "

Touch sensor tone is turned off

G Setting the TV Control by Remote On/Off

If this unit also runs when operating other units with different Kenwood remote controls, its remote control function can be turned off.

Each time you touch [REMO], the mode switches as follows:

" ON "

Remote control function is on

" OFF "

Remote control function is off

H Setting the Auto Scroll Display Function

This function permits the text to be scrolled and the entire text to be displayed. Switching between manual scrolling and automatic scrolling is permitted.

Each time you touch [Scroll], the mode switches as follows:

" Auto "

Automatic scrolling

" Manual "

Manual scrolling

System Setup Screen-3

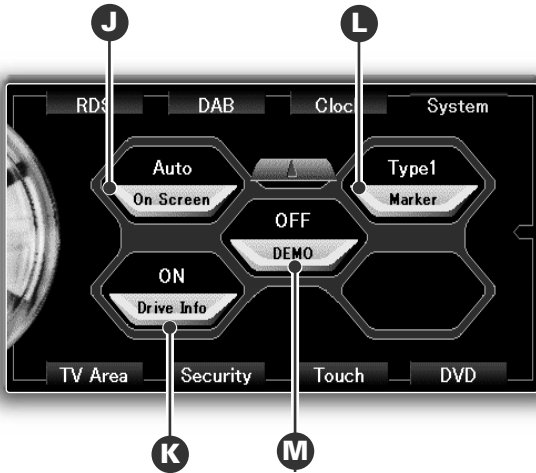

I Adjusting the Navigation Sound Level

If the guide etc., sound from the navigation system interrupts, the sound level can be adjust.

Touch [▶] to increase the level.
Touch [◀] to decrease the level.

NOTE

This function available when the KENWOOD navigation unit is connected.

J Setting the On Screen Display Function

Each time you touch [On Screen], the mode switches as follows:

" Auto "

When a button on the main unit or remote control unit is pressed, or the disc track is changed, the information is temporarily superimposed on the picture.

" Manual "

When the lower centre of the screen is touched whilst a TV/video picture is displayed, the information is temporarily superimposed on the picture.

K Setting the Information on the Graphic Screen

You can set whether or not to display the information on the graphic screen.

Each time you touch [Drive Info], the mode switches as follows:

" ON "

Information function is on

" OFF "

Information function is off

M Demonstration Function

Each time you touch [DEMO], the mode switches as follows:

" ON "

The graphic screen's background mode switches repeatedly.

" OFF "

the demonstration function is off.

L Selecting the Point Marker Type

Each time you touch [Marker], the mode switches as follows:

" Type 1 "

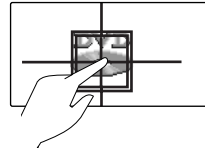

" Type 2 "

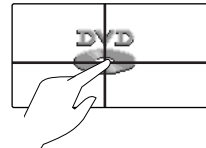

" OFF "

No display the pointer marker.

RDS Setup Screen

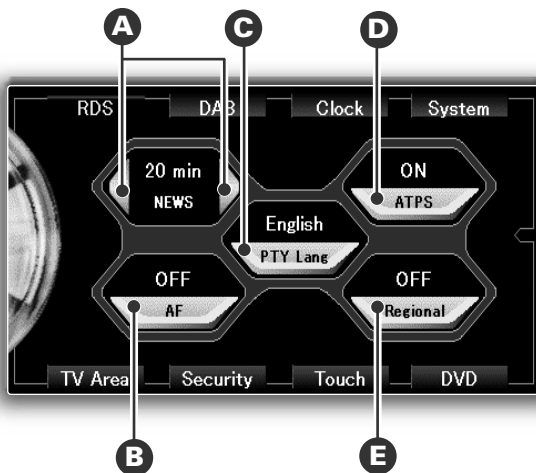

A RDS (Radio Data System)

RDS is a digital information system that lets you receive signals besides those of regular radio programmes, such as network information being transmitted from radio stations.

When listening to an RDS station (ie, a station with RDS capability), the programme service name of the station is displayed along with the frequency, advising you quickly which station is being received.

RDS (Radio Data System) stations also transmit frequency data for the same station. When you are making long trips, this function automatically switches to the particular frequency with the best reception for the particular network of stations that you want to listen to. The data is automatically stored, allowing you to switch quickly to another RDS stations, broadcasting the same programme, that has better reception. These include stations stored in the station preset memory that you often listen to.

Enhanced Other Network

Stations that offer <Enhanced Other Network> also transmit information about other RDS stations that have traffic information. When you are tuned to a station that is not transmitting traffic information, but another RDS station starts transmitting a traffic bulletin, the tuner automatically switches to the other station for the duration of the bulletin.

Alarm

When an emergency transmission (announcing disasters, etc.) is sent, all current functions are interrupted to allow the warning to be received.

A News Bulletin Function with PTY News Timeout Setting

You can arrange to have news bulletins interrupt your current listening source, including other radio stations. When the News Bulletin function is on, the PTY News Timeout setting allows you to set the interval during which further news interruption cannot take place. You can adjust the PTY news interruption period from 10 to 90 minutes for each journey.

Changing the Function Setting:

Touch [◀] or [▶] repeatedly until the desired setting is displayed.

Touch [▶] to increase the interval, and the [◀] to decrease it.

OFF ↔ 00min ↔ 10min ↔ 20min ↔ 30min ↔ 40min ↔ 50min ↔ 60min ↔ 70min ↔ 80min ↔ 90min (min= minutes)

When you select the news interruption timeout interval, the News function turns on and the NEWS indicator is displayed.

NOTE

- If you choose the " 20min " setting, further news bulletins will not be received for 20 minutes once the first news bulletin is received. Setting the interval at the "OFF" factory default indicates no News Timeout will be made, meaning that additional news bulletins will continue to be searched for.
- This function is only available if the desired station sends PTY-code for news bulletin or belongs to <Enhanced Other Network> sending PTY-code for news bulletin.

B Alternative Frequency Function On/Off

When poor reception is experienced, automatically switch to another frequency broadcasting the same programme in the same RDS network with better reception. The AF indicator is displayed when the AF function is turned on.

Each time you touch [AF], the mode switches as follows:

" ON "

AF function is turned on

" OFF "

AF function is turned off

NOTE

When no other stations with stronger reception are available for the same programme in the RDS network, you may hear the incoming broadcast in bits and snatches. Turn off the AF function in such a case.

C ***Changing the PTY Display Language to Dutch, French, German, Norwegian, Portuguese, Spanish and Swedish***

Each time you touch [Language] to change the language.

D ***Auto TP Seek Function On/Off***

When the TI function is on and poor reception conditions are experienced when listening to a traffic information station, another traffic information station with better reception will be searched for automatically. This function is on, when unit is first powered on.

Each time you touch [ATPS], the mode switches as follows:

" ON "

Auto TP seek function is turned on

" OFF "

Auto TP seek function is turned off

E ***Restricting RDS Region On/Off***

You can choose whether or not to restrict the RDS channels, received with the AF function for a particular network, to a specific region.

Each time you touch [Regional], the mode switches as follows:

" ON "

Region restrict function is turned on

" OFF "

Region restrict function is turned off

NOTE

Sometimes stations in the same network broadcast different programmes or use different programme service names.

DVD Setup Screen-1

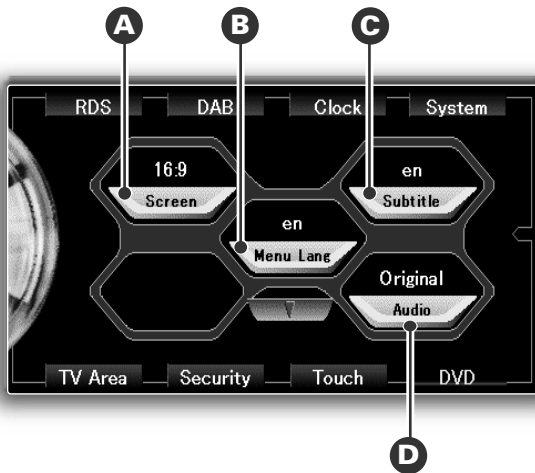

DVD Setup Screen-2

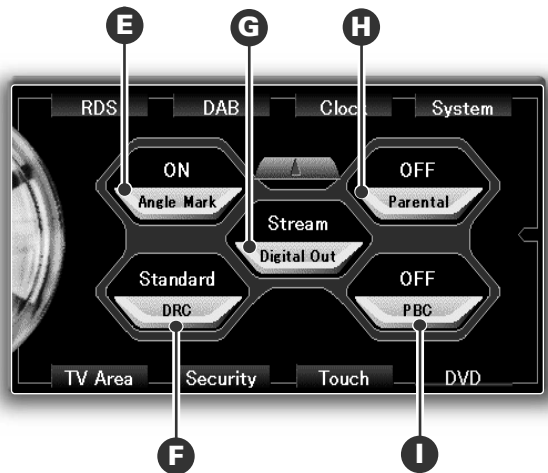

A Setting the Screen Mode

Use the procedure described below to set the output screen.

Each time you touch [Screen], the mode switches as follows:

" 4:3 LB "

Wide-screen software with pan & scan specification is played in a letter box screen (with black stripes on the top and bottom).

" 4:3 PS "

Wide-screen software with pan & scan specification is played in a panned & scanned screen (with the left and right sides cut off).

" 16:9 "

Set the picture mode of the wide-screen monitor to "FULL"

B Setting the Priority Language for Menu

Set the language used for the menus (title menu, etc.).

Touch [Menu Lang] to switch the language select screen. <see p.18>

C Setting the Priority Language for Subtitle

Set the language of the subtitles displayed on the screen.

Touch [Subtitle] to switch the language select screen. <see p.18>

NOTE

The language selected in the initial setup is used immediately after turning power on or replacing disc. If the initially set language does not exist in the disc, the priority language defined for each disc is used.

D Setting the Priority Language for Voice

Set the audio language produced from the speakers.

Touch [Audio] to switch the language select screen. <see p.18>

NOTE

The language selected in the initial setup is used immediately after turning power on or replacing

disc. If the initially set language does not exist in the disc, the priority language defined for each disc is used.

E Setting the Angle Mark Display

With DVDs on which images photographed from multiple angles are recorded, the angle can be switched during playback.

Each time you touch [Angle Mark], the mode switches as follows:

" ON "

Angle mark is displayed.

" OFF "

Angle mark is not displayed.

F Selecting the Dynamic Range

Each time you touch [DRC], the mode switches as follows:

" Standard "

For more powerful sound at regular volumes

" Midnight "

For powerful sound at low volumes

" OFF "

For the regular sound

NOTE

This select can be made when the Dolby Digital signal is inputted.

" 4:3 LB "

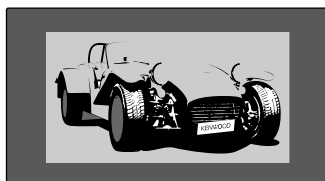

" 4:3 PS "

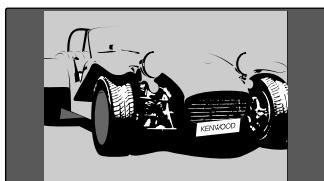

" 16:9 "

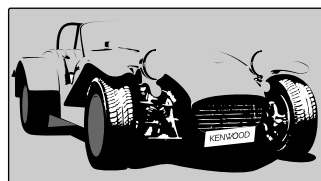

G **Setting the Optical Output Mode**

Converts linear PCM (LPCM) voice signals recorded on the DVD disc to down sampling 48 kHz digital signals and outputs them from the optical cable.

Each time you touch [Digital Out], the mode switches as follows:

Audio recording format	Optical audio output	
	"Stream"	"PCM"
Dolby Digital	Dolby Digital	PCM48 kHz /16 bit
LPCM(96 kHz) LPCM(48 kHz)	With copy grade:PCM 48 kHz /16 bit With out copy grade: PCM 48 kHz /24,20,16 bit	
MPEG	PCM 48/44.1kHz /16 bit	
DTS	DTS	Not output

CAUTION

When playing DTS-encoded (CDs), excessive noise may be exhibited from the analog stereo outputs. To avoid possible damage to audio system, the consumer should take proper precautions when the analog stereo outputs of the DVD player is connected to an amplification system. To enjoy DTS Digital Surround (TM) playback, an external 5.1 channel DTS Digital Surround (TM) decoder (KDS-P900) system must be connected to the digital output (S/PDIF, AES/EBU, or TosLink) of the DVD player.

H **Switching to the Rating Level (parental lock) Setting Screen.**

Use this function to restrict the viewing of movies to children of appropriate age levels only.

Touch [Parental] to switch to rating level setup screen. <see p.20>

I **PBC(Playback Control) Function On/Off for VCD version 2.0**

Each time you touch [PBC], the mode switches as follows:

" ON "

PBC function is turned on

" OFF "

PBC function is turned off

Language Select Screen

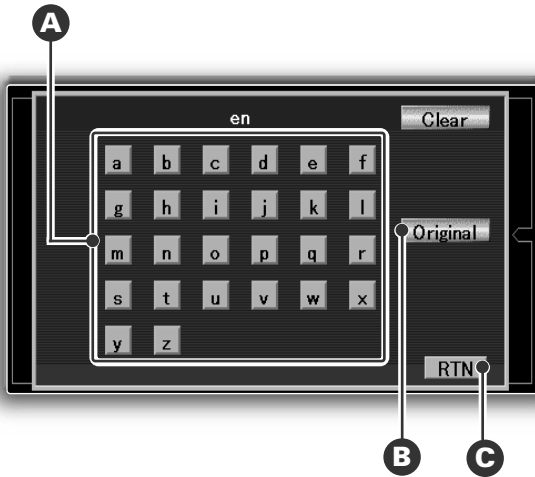

A *Inputting the Language Code*

Touch [a] - [b] and input the language code.

NOTE

If you enter the wrong letter, touch [Clear]. The last entered letter is cleared.

B *Returning to the Original Language*

<Audio language only>

Touch [Original] or to return to the original language.

C *Returning to the DVD setup Screen*

Touch [RTN] to return to the DVD setup screen.

List of language codes

Code	Language	Code	Language	Code	Language
aa	Afar	iw	Hebrew	sl	Slovenian
ab	Abkhazian	ja	Japanese	sm	Samoan
af	Afrikaans	ji	Yiddish	sn	Shona
am	Amharic	jw	Javanese	so	Somali
ar	Arabic	ka	Georgian	sq	Albanian
as	Assamese	kk	Kazakh	sr	Serbian
ay	Aymara	kl	Greenlandic	ss	Siswati
az	Azerbaijani	km	Cambodian	st	Sesotho
ba	Bashkir	kn	Kannada	su	Sundanese
be	Byelorussian	ko	Korean	sv	Swedish
bg	Bulgarian	ks	Kashmiri	sw	Swahili
bh	Bihari	ku	Kurdish	ta	Tamil
bi	Bislama	ky	Kirghiz	te	Telugu
bn	Bengali, Bangla	la	Latin	tg	Tajik
bo	Tibetan	ln	Lingala	th	Thai
br	Breton	lo	Laotian	ti	Tigrinya
ca	Catalan	lt	Lithuanian	tk	Turkmen
co	Corsican	lv	Latvian, Lettish	tl	Tagalog
cs	Czech	mg	Malagasy	tn	Setswana
cy	Welsh	mi	Maori	to	Tongan
da	Danish	mk	Macedonian	tr	Turkish
de	German	ml	Malayalam	ts	Tsonga
dz	Bhutani	mn	Mongolian	tt	Tatar
el	Greek	mo	Moldavian	tw	Twi
en	English	mr	Marathi	uk	Ukrainian
eo	Esperanto	ms	Malay	ur	Urdu
es	Spanish	mt	Maltese	uz	Uzbek
et	Estonian	my	Burmese	vi	Vietnamese
eu	Basque	na	Nauru	vo	Volapuk
fa	Persian	ne	Nepali	wo	Wolof
fi	Finnish	nl	Dutch	xh	Xhosa
fj	Fiji	no	Norwegian	yo	Yoruba
fo	Faroese	oc	Occitan	zh	Chinese
fr	French	om	(Afan) Oromo	zu	Zulu
fy	Frisian	or	Oriya		
ga	Irish	pa	Punjabi		
gd	Scots Gaelic	pl	Polish		
gl	Galician	ps	Pashto, Pushto		
gn	Guarani	pt	Portuguese		
gu	Gujarati	qu	Quechua		
ha	Hausa	rm	Rhaeto-Romance		
hi	Hindi	rn	Kirundi		
hr	Croatian	ro	Romanian		
hu	Hungarian	ru	Russian		
hy	Armenian	rw	Kinyarwanda		
ia	Interlingua	sa	Sanskrit		
ie	Interlingue	sd	Sindhi		
ik	Inupiak	sg	Sangho		
in	Indonesian	sh	Serbo-Croatian		
is	Icelandic	si	Singhalese		
it	Italian	sk	Slovak		

Parental Setup Screen

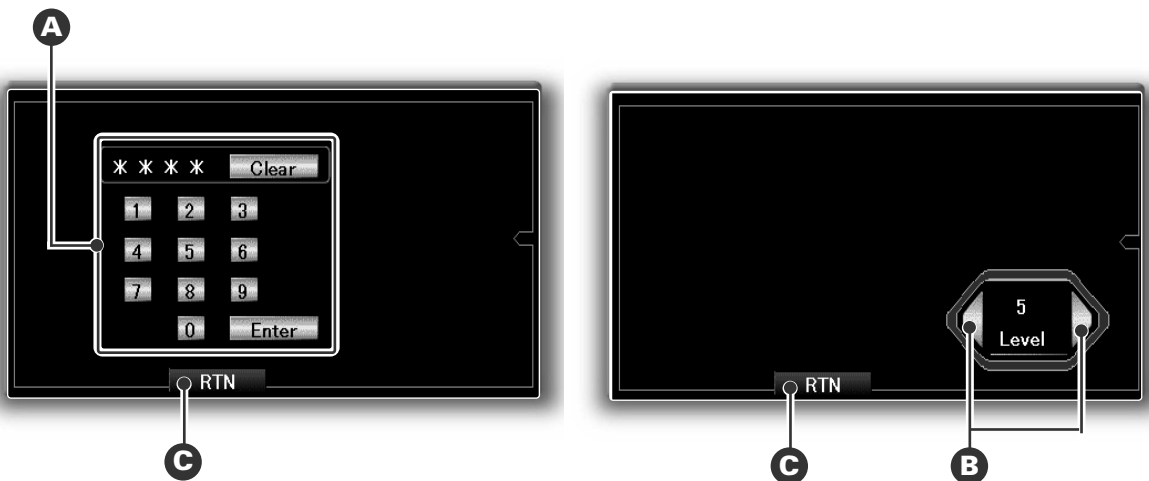

A Setting the password

- 1 Touch the number [1] - [0] and enter your password (4-digit).

Input numbers are displayed " * " .

NOTE

If you enter the wrong number, touch [CLEAR].
The entered number is cleared.

- 2 Touch [Enter].

NOTE

- Registered number can be used as a password.
- Pressing the Reset button erases the password.

B Setting the Parental Level

Touch [◀] or [▶] to change the parental set level.

" OFF "

Cancelling the parental lock.

" 8 "

Plays any software (including adult-, general- and children-oriented).

" 7 " - " 2 "

Plays general- and children-oriented DVD software.

- Restricts playback of adult-oriented DVD software.

" 1 "

Plays children-oriented software.

- Restricts playback of adult and general-oriented DVD software.

NOTE

Parental level varies with the discs.

C Returning to the DVD setup Screen

Touch [RTN] to return to the DVD setup screen.

NOTE

- Some discs may request that you change the rating level set in the default settings during playback. In this case, the rating level setup screen is displayed, if you do not input the correct password either playback does not continue or a picture for a different rating level is played.
- Write down the password on a piece of paper and store the piece of paper somewhere in case you forget it.
- On undated DVDs, playback will not be restricted even if the rating level is set.
- Once set, this rating level remains in memory until changed. To enable the play of discs of higher rating levels or to cancel the parental lock, the setting must be changed.
- Not all DVDs provide a Parental Lock feature. If you are unsure about a DVD, play it first to confirm. Do not leave DVDs accessible to young children for whom you deem them inappropriate.

Clock Adjustment Function

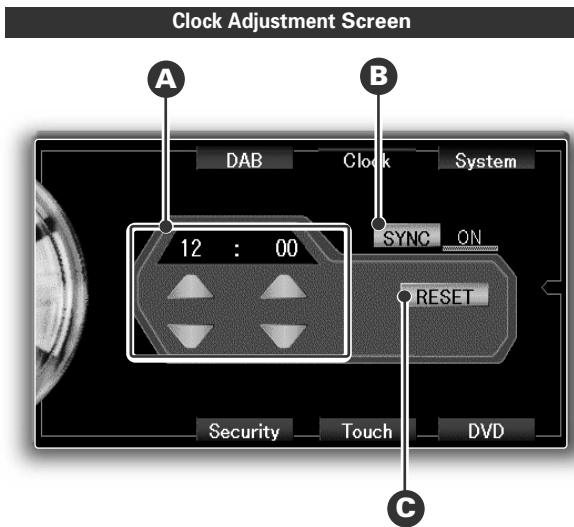

B Turning the Automatic Time Adjustment On/Off

With automatic time adjustment, you can set the clock time automatically according to time data sent from RDS stations (after receiving RDS signals for several minutes). You can also set the time manually if the automatic time adjustment function is turned off. The factory default is automatic time adjustment.

Touch [SYNC] to switch the function on and off. " ON "

Tune into an RDS station for 3 or 4 minutes. The time adjusts automatically to the correct local time " OFF "

Manual adjusting

NOTE

The time is not adjusted when the RDS station you are tuned to be not transmitting a time signal. Choose another RDS station in such a case.

A Adjusting the Time Manually

Touch [▲] to advance the hours.

Touch [▲] to advance the minutes.

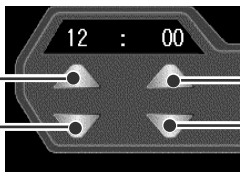

Touch [▼] to make the hours go back.

Touch [▼] to make the minutes go back .

NOTE

No display when the "SYNC" is set to "ON".

C Setting the Minutes to "00"

Touch [RESET] to set the minutes to "00".

NOTE

Touch [RESET] whilst the minute is below "30" rounds it off, and whilst the minute is "30" or more rounds it up.

TV Area Setup Screen

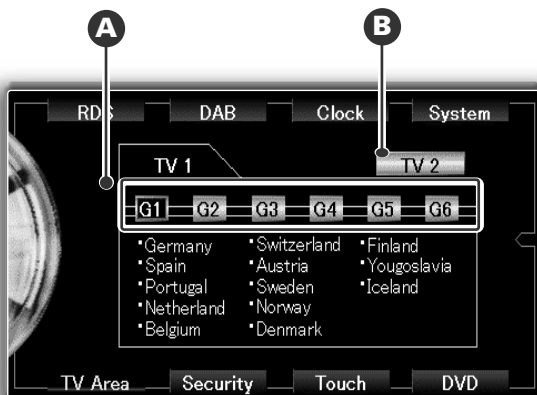

Touch Panel Adjustment Screen

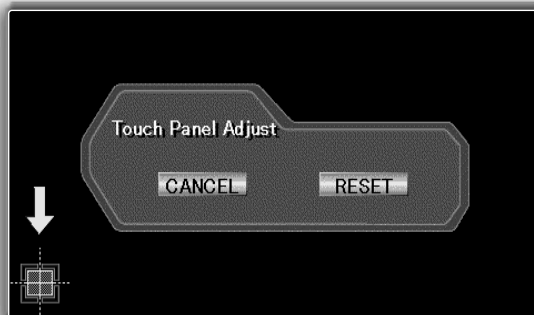

Select the area for TV broadcast viewing.

B Selecting the Preset Bands

Touch [TV 1] or [TV 2]. The preset band switches between TV1 and TV2.

A Selecting the Reception Area

Touch [G 1] - [G 6] to select the channel setting for your country as follows.

(G1)	Germany Spain Portugal Netherlands Belgium Switzerland Austria Sweden Norway Denmark Finland Yugoslavia Iceland	PAL-B/G
(G2)	Italy Albania	
(G3)	United Kingdom Ireland	PAL-I
(G4)	France	SECAM-L
(G5)	Russia Poland Hungary Czech Slovakia Bulgaria Roumania	SECAM-D/K
(G6)	Greece	SECAM-B/G

NOTE

The reception area can be set for two separate preset bands, TV1 and TV2.

Adjusting the Touch Position

The touch panel can be adjusted if the position touched and the operation performed do not match.

- 1 Accurately touch the mark at the lower left.
- 2 Accurately touch the mark at the upper right.

When the mark at the upper right is touched, the adjustment is completed and the system setup menu screen reappears.

NOTE

- If [CANCEL] is touched without touching the button at the lower left, the adjustment is cancelled and the screen that was set before switching to the system setup menu reappears.
- If [CANCEL] is touched after touching the button at the lower left, the button at the lower left reappears.
- If [RESET] is touched, the settings are reset to the factory defaults and the setup menu screen reappears.

Code Security Screen



Mask Key

If you have transmitted the Mask Key's signal once to the unit in advance, you will have to transmit it once again if the unit has been removed from the battery. This function helps prevent theft.

When using the unit for the first time:

- 1 Hold down the transmit button on the Mask key until the full transmit level indicator lights up in the display. "1st" will be displayed.

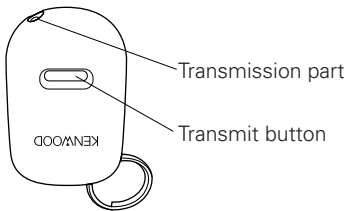

NOTE

Keep the Mask Key close to the signal sensor when you transmit the Mask Key signal.

- 2 Hold down the transmit button on the Mask key until the full transmit level indicator lights up in the display. "2nd" will be displayed.

"OK" will appear in the display, with the Mask Key function turning on.

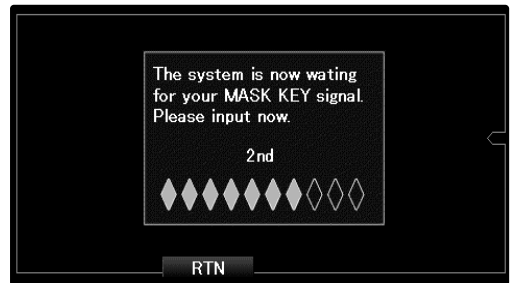

If you press the RESET button or remove the battery:

The first time you turn the unit on again, "The system is now waiting for your MASK KEY signal. Please input now." will appear in the display, indicating the setting mode has been entered. Repeat steps 1 and 2 above, and transmit the signal.

You can start operating the unit again when "OK" appears in the display.

A Cancelling the Code Security Screen

Touch [RTN] to return to the setup screen.

Operating the Buttons for Basic Function

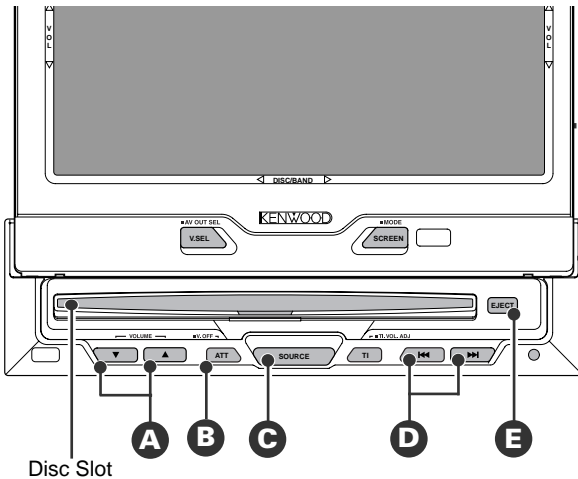

A Adjusting the Volume

Press the ▲ button to increase the volume.
Press the ▼ button to decrease the volume.

B Turning Attenuator On/Off

This function allows you to turn down the volume quickly.

Press the ATT button to switch the attenuator on and off.

When the attenuator is on, the ATT indicator is displayed.

When the attenuator is off, the volume returns to the original level.

NOTE

Turning the volume up, or turning it all the way down deactivates the attenuator function.

C Switching Source Mode

Each time you press the SOURCE button to switch source mode.

Inserting Discs

Holding the disc with the labelled side facing up, insert it in the disc slot. The disc will start playing.

CAUTION

- Do not insert other disks when a disk is already inserted. It may damage the disk.
- When inserting a disc, be careful that the disc does not touch the bottom of the monitor or the mechanism. If it does, it may be scratched.
- Do not attempt to insert a disc into the slot if another one is already there.
- The unit can only play 12-cm (5-inch) CDs. If you insert an 8-cm (3-inch) CD, it will get stuck inside and can cause the unit to malfunction.

D Seeking / Searching

In Tuner Mode

Press the ◀◀ button to make decreasing seeks.
Press the ▶▶ button to make increasing seeks.

In Disc Mode

Press the ◀◀ button to search through the chapters/tracks backwards.

Press the ▶▶ button to search through the

chapters/tracks forwards.

D Fast Forwarding and Reversing Disc Play

Fast Forwarding Disc Play

Hold down on the ▶▶ button.
Release your finger to play the disc at that point.

Reversing Disc Play

Hold down on the ◀◀ button.
Release your finger to play the disc at the point.

E Ejecting Discs

Press the EJECT button.

The disc stops playing and ejects from the slot.

NOTE

When you load a disc and eject it right away, the next time you try to insert the disc may not load. In such a situation, take the disc out for a moment and then reinsert it.

Basic Operation for Source Control Screen

Source Control Screen

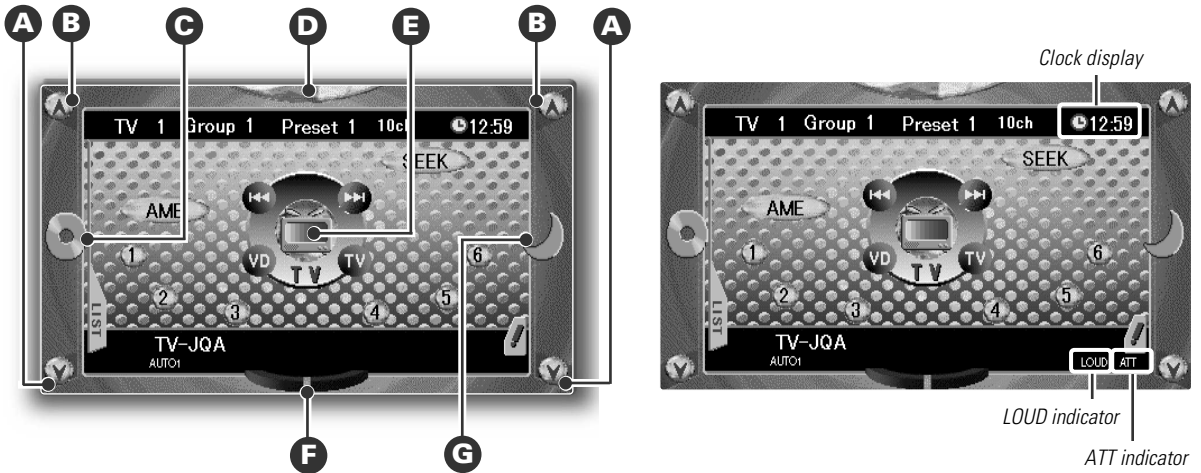

A The common controls are explained from each source screen. For the other functions, refer to each control screen.

B **Increasing the volume**
Touch [^] to increase the volume.

A **Decreasing the volume**
Touch [v] to decrease the volume.

G **Switching to the Next Source Mode**
Touch the source icon to switch to the next source control screen.

C **Switching to the Previous Source Mode**
Touch the source icon to switch to the previous source control screen.

D **Switching to the Menu Screen**
Touch this icon to switch to the menu screen.

F **Displaying the Quick Effect Control Screen**
Touch this icon to switch to the quick effect control screen to be displayed on the source control screen.

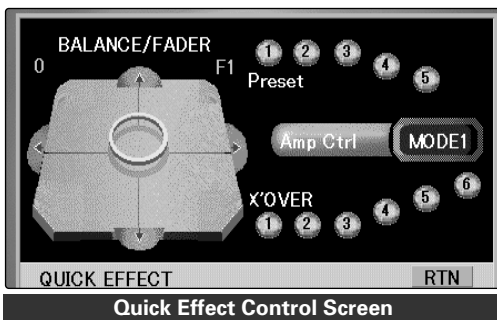

NOTE

Refer to page 53 for the quick effect control

screen operation.

E **Switching to the Graphic Screen**
The necessary minimum limit screen. The screen display pattern (graphic pattern) can be switched on this screen.

Touch centre source icon to switch to the graphic screen.

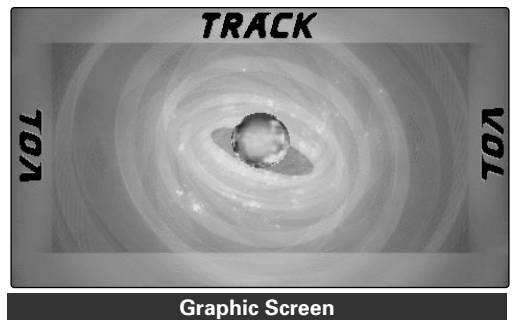

NOTE

Refer to page 42 for the graphic screen operation.

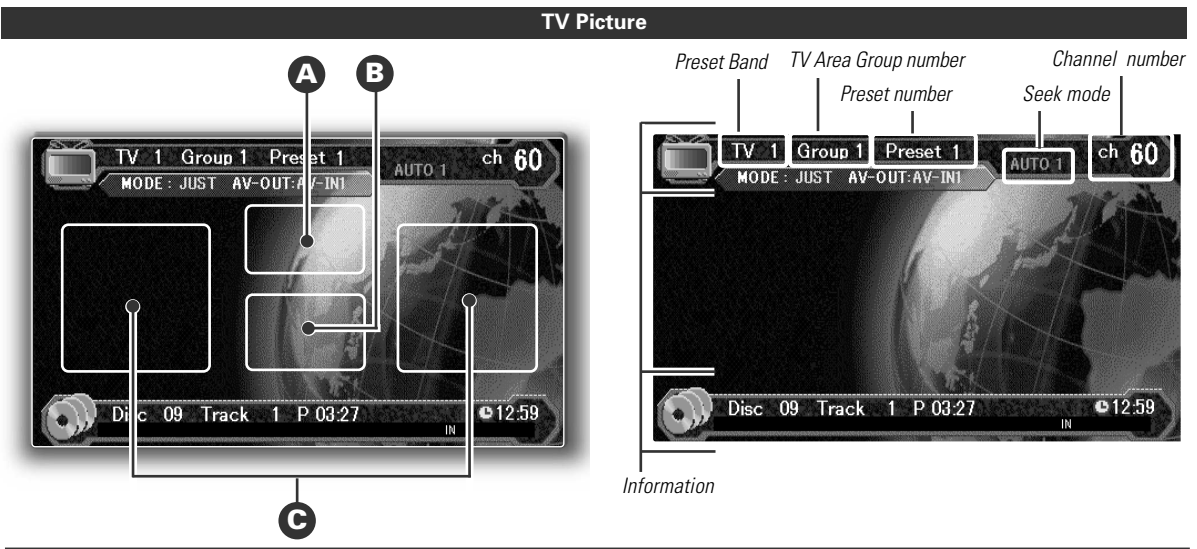

Displaying the TV Picture

Press the V.SEL button.(see page 8)

A Selecting the Preset Bands

Each time you touch the upper centre part, the preset band switches between the TV1 and TV2.

C Selecting the Channels

Auto Seek Mode (AUTO1)

- Touch the right side part to seek for channels up the band.
- Touch the left side part to seek for channels down the band.

Preset station Seek Mode (AUTO2)

- Touch the right side part to move to the next preset station.
- Touch the left side part] to move to the last preset station.

Manual Seek Mode (MANU)

- Touch the right side part to increase the channel by one step.
- Touch the left side part to decrease the channel by one step.

B Displaying the Information

Touch the lower centre part to display the information for current state.

TV Control Function

TV Control Screen

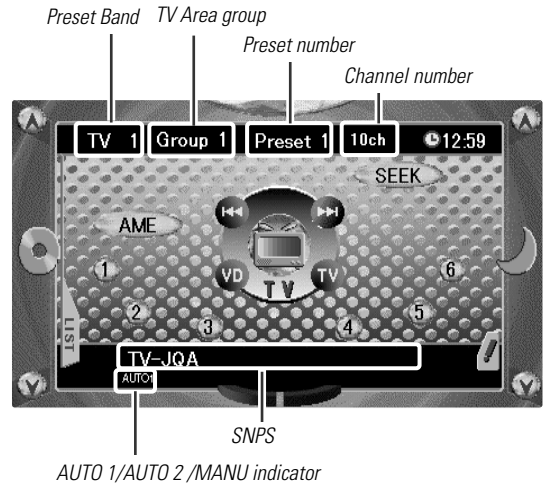
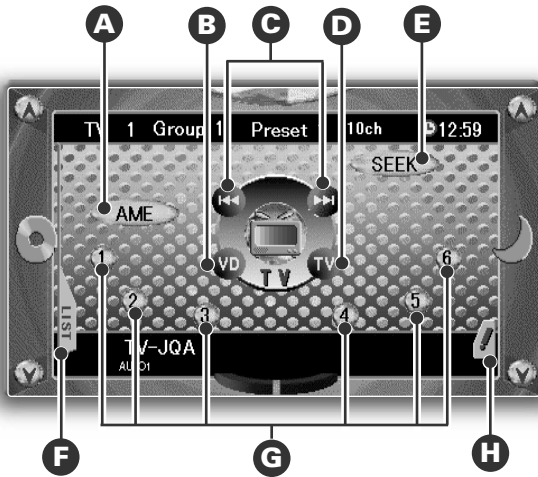

D Selecting the Preset Bands

Touch [TV] to select the TV preset band. Each time you touch [TV], the preset band switches between the TV1 and TV2.

B Selecting the Video Inputs

Each time you touch [VD], the video input switches between the video 1 and video 2.

NOTE

No display for TV control icons when touch [VD].

E Selecting the Seek Mode

You can choose from three seek modes: auto seek, preset station seek, and manual seek.

Each time you touch [SEEK], the mode switches as follows:

- AUTO 1: Auto Seek Tuning
- AUTO 2: Preset Station Seek Tuning
- MANU: Manual Tuning

C Selecting the Channels

Auto Seek Mode (AUTO1)

- Touch [►►] to seek for channels up the band.
- Touch [◀◀] to seek for channels down the band.

Preset station Seek Mode (AUTO2)

- Touch [►►] to move to the next preset station.
- Touch [◀◀] to move to the last preset station.

Manual Seek Mode (MANU)

- Touch [►►] to increase the channel by one step.
- Touch [◀◀] to decrease the channel by one step.

G Station Preset Memory

Store the channel of the station currently being look to. You can then recall that station with a single touch of a button.

- 1 Select the band/ station that you want to store.
- 2 Hold down preset station number [P1] - [P6] on which you want to store the station, for two seconds or more.

NOTE

You can store 6 stations in each of the TV1 and TV2 preset bands.

A Auto Memory Entry

You can automatically store all the receivable channels in the band currently being look to, and then recall them with the touch of a button later. This function is especially useful when you are travelling and do not know what stations are available. Up to 6 stations can be stored this way.

- 1 Select the band for auto memory entry.
- 2 Touch [AME].
- 3 Touch [◀◀] or [►►] to start auto memory entry.

The preset station numbers [1] - [6] are shown in order.

When all the stations on a certain band have been stored in the preset memory, the auto memory entry stops. The tuner then plays the last station received.

G Recalling a Preset Station

Touch the preset station number [1] - [6] for the desired station. The number of the recalled station is displayed.

F Switching to the TV List Screen

Touch [LIST] to switch to the TV list screen (see p.28).

TV Control Function

TV Control Screen

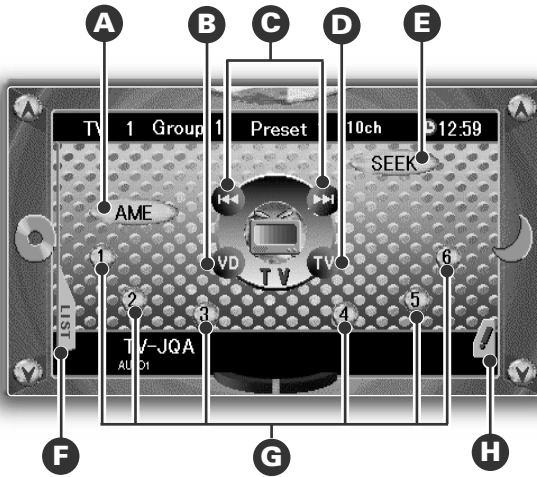

TV List Screen

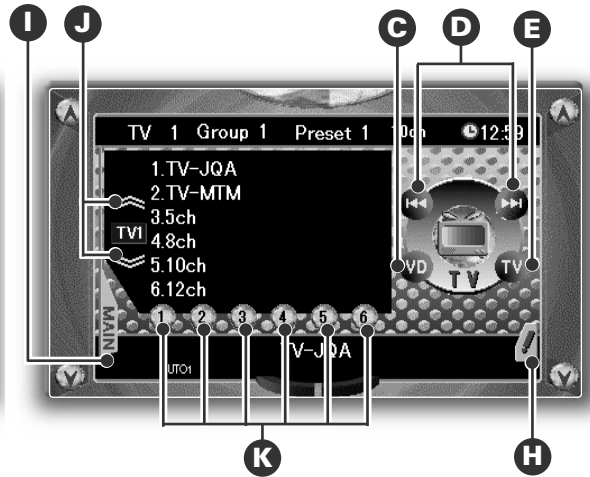



H Switching to the Name Set Screen

Touch [] for at least two seconds to switch to the name set screen.(see P.42)

NOTE

You cannot operate unless the parking brake is set.

J Switching the List

Each time you touch [] or [], the list switches between the TV1 and TV2 bands.

K Recalling a Preset Station

Touch the preset station number [1] - [6] for the desired station. The number of the recalled station is displayed.

I Returning to the Source Control Screen

Touch [MAIN] to return to the TV control screen .

FM/AM Tuner Control Function

FM/AM Tuner Control Screen

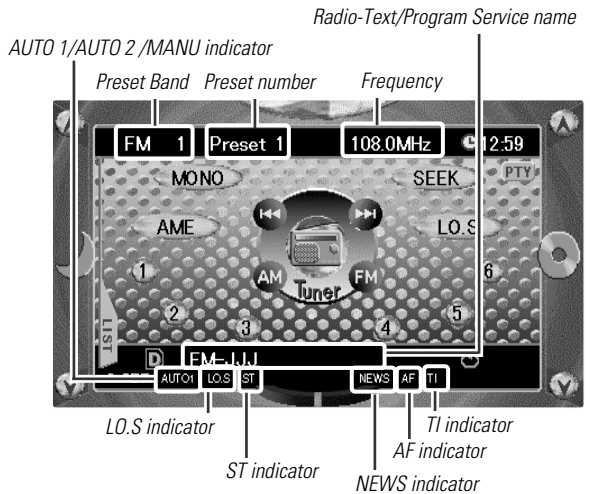
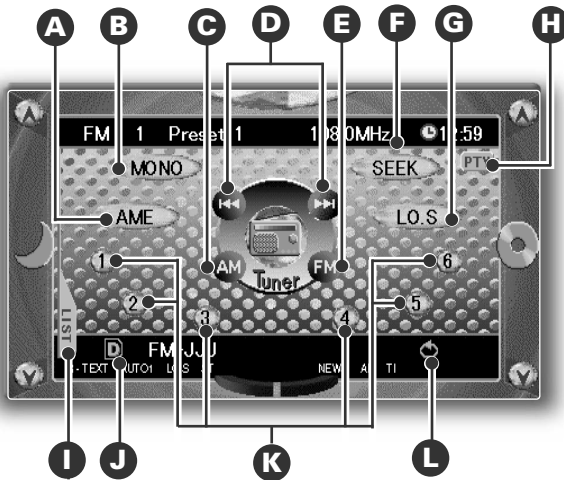

E Selecting the FM Bands

Touch [FM] to select the FM band. Each time you touch [FM], the band switches between the FM1, FM2 and FM3.

C Selecting the MW/LM Band

Touch [AM] to select the MW/LW band.

F Selecting the Seek Mode

You can choose from three seek modes: auto seek, preset station seek, and manual seek.

Each time you touch [SEEK], the mode switches as follows:

- AUTO 1: Auto Seek Mode
- AUTO 2: Preset Station Seek Mode
- MANU: Manual Seek Mode

D Tuning

Auto Seek Mode (AUTO1)

- Touch [►►] to seek increasing frequencies.
- Touch [◄◄] to seek decreasing frequencies.

Preset Station Seek Mode (AUTO2)

- Touch [►►] to move to the next preset station.
- Touch [◄◄] to move to the last preset station .

Manual Seek Mode (MANU)

- Touch [►►] to increase the frequency by one step.
- Touch [◄◄] to decrease the frequency by one step.

NOTE

The ST indicator is displayed when stereo broadcasts are being received.

K Station Preset Memory

Store the frequency of the station currently being listened to. You can then recall that station with a single touch of a button.

- 1 Select the band/station that you want to have stored.
- 2 Hold down preset station number [1] - [6] that you want to use for the station, for two seconds or more.

NOTE

You can store 6 stations in each of the FM1, FM2, FM3, and AM(MW/LW) band.

A Auto Memory Entry

You can automatically store all the receivable frequencies in the band currently being listened to, and then recall them with the touch of a button later. This function is especially useful when you are travelling and do not know what stations are available. Up to 6 frequencies can be stored this way.

- 1 Select the band for auto memory entry.
- 2 Touch [AME].
- 3 Touch [◄◄] or [►►] to start auto memory entry.

The preset station numbers [1] - [6] are shown in order.

When all the stations in a certain band are stored in the preset memory, the auto memory entry stops. The tuner then plays the last station received.

NOTE

- When the AF function is turned on whilst auto memory entry takes place, only RDS stations (i.e., stations with RDS capability) are stored. RDS stations that have been preset for FM1 cannot also be preset in FM2 or FM3.
- When the local seek function is turned whilst auto memory entry takes place, stations with poor reception are not stored.
- When the Traffic Information function is on, only the local traffic information station frequency will be stored.

FM/AM Tuner Control Function

FM/AM Tuner Control Screen

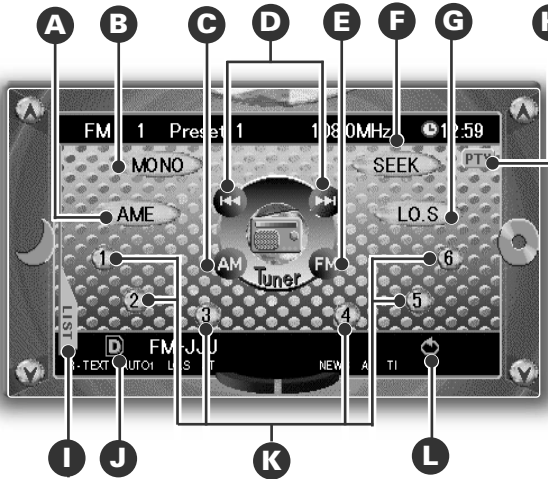

FM/AM List Screen

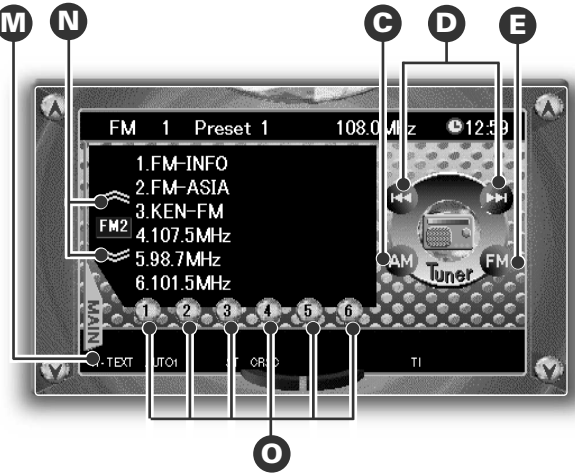

K Recalling a Preset Station

Touch the preset station number [1] - [6] for the desired station. The number of the recalled station is displayed.

G Turning the Local Seek Function On/Off

With the local seek function turned on, auto seek tuning skips stations with relatively poor reception.

Touch [LO.S] to switch the local seek function on and off.

The LO.S indicator is displayed when the local seek function is on.

H Switching to the PTY Search Screen

Touch [PTY] to switch the PTY search screen. (Page 32)

B Turning the Monaural Reception On/Off

When poor stereo reception is experienced, this function will reduce noise and improve listening conditions.

Touch [MONO] to switch the monaural reception on and off.

The MONO indicator is displayed when monaural reception is on.

J Switching Display for Radio Text

Touch [D] switches the display as follows.

Programme Service name

Radio text

L Scrolling the Radio Text

This function permits the text to be scrolled and the entire text to be displayed. The scrolling method differs depending on the setting of scrolling in the system.

Touch [⏪] results in one scrolling display of the text.

I Switching to the FM/AM List Screen

Touch [LIST] to switch to the FM/AM list screen.

N Switching the List

Each time you touch [⏶] or [⏷], the list switches between the FM1, FM2, FM3 and AM bands.

O Recalling a Preset Station

Touch the preset station number [1] - [6] for the desired station. The number of the recalled station is displayed.

M Returning to the Source Control Screen

Touch [MAIN] to return to the tuner control screen.

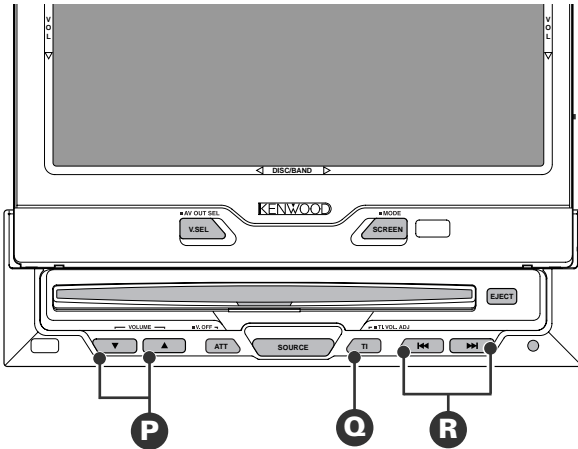

Q Traffic Information Function

You can listen to traffic information. If you are listening to discs, they will continue playing until a traffic bulletin is broadcast.

Turning TI function On/Off

Press the [TI] button to turn the function on and off. When the function is on, the TI indicator is displayed.

If you are listening to a disc when a traffic bulletin begins, playback will be interrupted. When the bulletin ends or poor reception causes signal losses, the disc will continue to play again.

function during tuner reception. The volume is only set when it is louder than the listening volume of the tuner.

- You can arrange only to listen to traffic information or news bulletins with at preset volume with the volume set at minimum.

R Seeking to a Different Traffic Information Station

Use the [◀▶] / [▶▶] button to make an auto seek of the TI stations in a certain band.

NOTE

- When you are listening to a disc, you cannot change to another TI station.
- When the auto TP seek function is turned on and reception starts to weaken, the tuner automatically seeks stations with better reception.
- If you are tuned to a station that is not a traffic information station itself but which provides <Enhanced Other Network> services, you can still have traffic information received.

P Presetting the Volume for Traffic Information/News

Q Preset the volume level to be used for traffic information and news broadcasts.

- 1 Tune into the station for which you want to set the volume.
- 2 Adjust the volume to the desired level.
- 3 Hold down the [TI] button for two seconds or more.

The volume level that has now been stored. Future traffic information/news broadcasts are heard at the preset level.

NOTE

- The volume cannot be lowered by this

PTY Search Screen

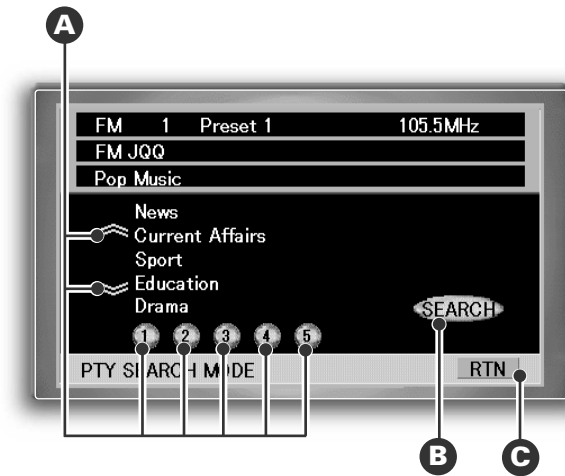

Programme Type (PTY) Function

Conduct auto seek tuning only on those stations with selected kinds of programmes.



NOTE

You cannot use this function whilst the traffic information function is turned on.

B Searching the Selected Programme Type

Touch [SEARCH] to make a seek of frequencies with your selected type of programme. If your selected type of programme is found, the name of the station is displayed and the station is tuned into.

A Selecting the Type of Programme to be Received

- 1 Touch either [] or [], repeatedly to select the type of programme in the list.
- 2 Touch [1] - [5] to select the type of programme you want to listen to.

C Cancelling the PTY Search Screen

Touch [RTN] to return to the tuner control screen.

News	News	S
Current Affairs	Current Affairs	S
Information	Information	S
Sport	Sports	S
Education	Education	S
Drama	Drama	S
Culture	Culture	S
Science	Science	S
Varied Speech	Varied Speech	S
Pop Music	Pop Music	M
Rock Music	Rock Music	M
Easy Listening M	Easy Listening Music	M
Light Classic M	Light Classics Music	M
Serious Classics	Serious Classics	M
Other Music	Other Music	M
Weather & Metr	Weather & Metr	S
Finance	Finance	S
Children's Prog	Children's programs	S
Social Affairs	Social Affairs	S
Religion	Religion	S
Phone In	Phone In	S
Travel & Touring	Travel & Touring	S
Leisure & Hobby	Leisure & Hobby	S
Jazz Music	Jazz Music	M
Country Music	Country Music	M
National Music	National Music	M
Oldies Music	Oldies Music	M
Folk Music	Folk Music	M
Documentary	Documentary	M
All Speech	All Speech	S
All Music	All Music	M

(S: Speech, M: Music)

DVD Picture

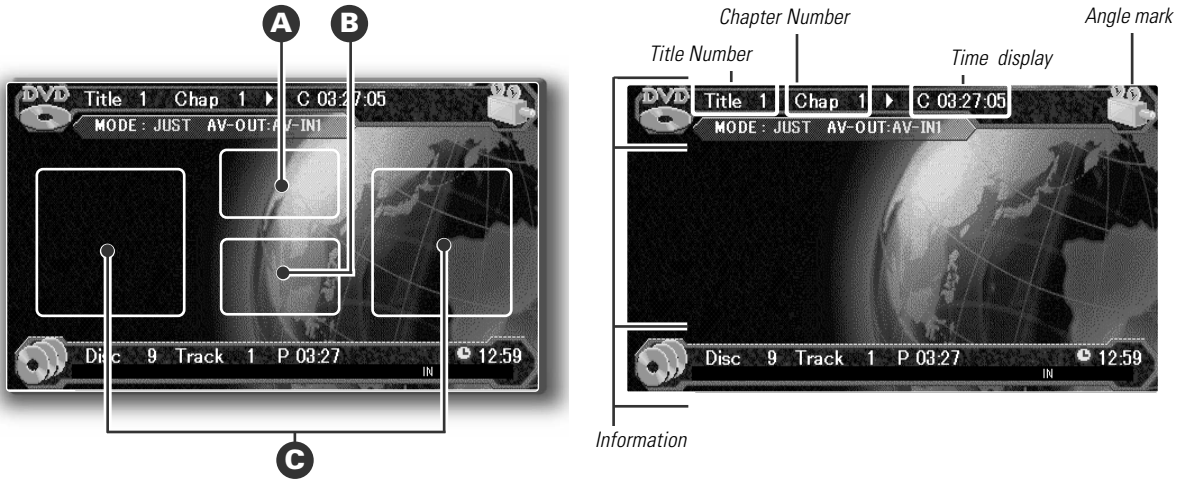

Displaying the DVD Picture

Press the V,SEL button.(see page 8)

C Chapter Search

Search forwards or backwards through the chapters on the disc until you reach the one that you want to look to.

Making a Forward Search

Touch the right part once to fast forward to the next chapter, twice to fast forward to the chapter after that, and so forth.

Making a Reverse Search

Touch the left part once to search back to the beginning of the current chapter, twice to search back to the beginning of the previous chapter, and so forth.

B Displaying the Information

Touch the lower centre part to display the information for current state.

A Displaying the DVD Menu Screen

Touch the upper centre part to display the DVD menu screen.

D Displaying the Menu Control Screen

Touch [MENU CONT.] to display the menu control screen.

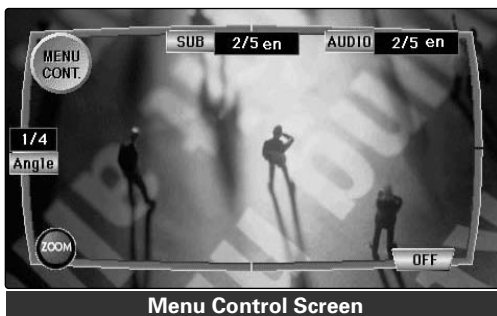

Displaying the menu

Touch [MENU].

Selecting the item

Touch [Δ], [▽], [◀], [▶].

Setting the item

Touch [ENT].

Returning to the menu

Touch [RTN].

NOTE

- The display, operation method and usable keys of the menu screen are variable depending on software. For details, read the instructions provided with the played software.
- When the menu has a hierarchical structure, the menu at the lower level appears.

Switching to the top menu

Touch [TOP].

Returning to the DVD menu screen

Touch [MAIN].

F Changing the Language for Subtitle

Set the language of the subtitles displayed on the screen.

Touch [SUB] to select the language.

G Changing the Language for Voice

Set the audio language produced from the speakers.

Touch [AUDIO] to select the language.

E Switching the Viewing Angle

When the DVD disc being played contains the scenes recorded from multiple viewing angles, the angle can be switched while the angle mark is displayed.

Each time you touch [Angle] to switch the viewing angle.

NOTE

Depending on the disc, the angle may switch in one of two ways.

- Seamless:
The angle switches smoothly.
- Non-seamless:
When the angle is switched, a still picture is displayed first, after which the angle switches.

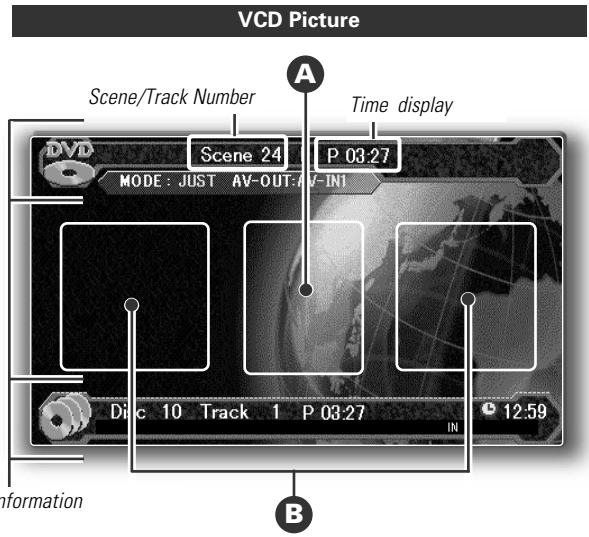
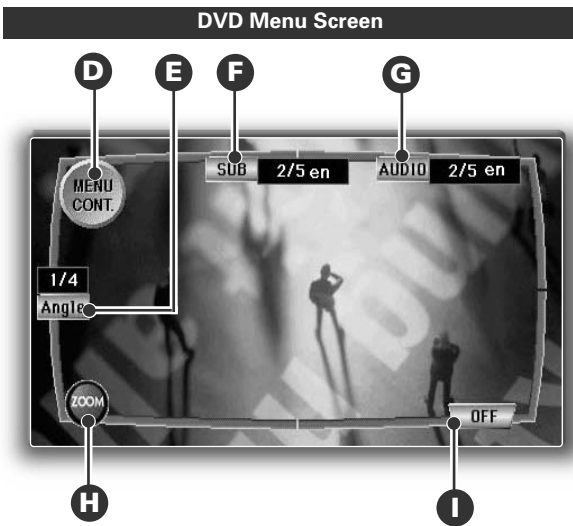

H Viewing Zoom
 1/4 of the image can be zoomed and viewed.
 Touch [ZOOM] to display the zoom control screen.

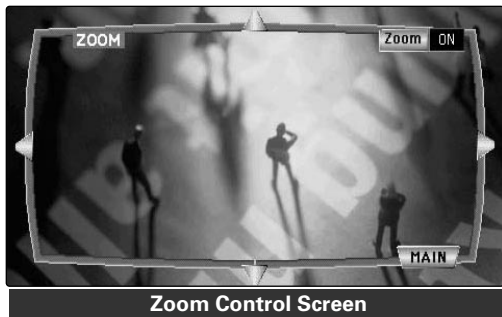

Zooming the image
 Each time the [zoom] is touched the image switches between zoom (ON) and normal (OFF).

Scrolling the image
 When you touch [<], [>], [Δ] or [∇], the image scrolls in the direction of the touched arrow. If you retouch the arrow, the scroll is stopped.

Returning to the DVD menu screen
 Touch [MAIN].

NOTE

According to the play point, there are cases when the Zoom will not work.

I Cancelling the Menu Screen
 Touch [OFF] to end the menu screen.

Displaying the VCD Picture

Press the V,SEL button.(see page 8)

B Next Play/ Previous Play
 (When the PBC function is set to [ON])

- To Next Play**
Touch the right part.
- To Previous Play**
Touch the left part.

B Track Search
 (When the PBC function is set to [OFF])
Search forwards or backwards through the tracks on the disc until you reach the one that you want to listen to.

- Making a Forward Search**
Touch the right part once to fast forward to the next track, twice to fast forward to the track after that, and so forth.
- Making a Reverse Search**
Touch the left part once to search back to the beginning of the current track, twice to search back to the beginning of the previous track, and so forth.

A Displaying the Information
 Touch the centre part to display the information for current state.

Inhibition icon



Restrictions due to difference between discs

Some DVD and VCD discs can be played only in certain playback modes according to the intentions of the software producers. As this player plays discs according to their intentions, some functions may not work as intended by you. Please be sure to read the instructions provided with each disc. When an inhibition icon is displayed, it indicates that the disc being played is under the restriction as described above.

DVD(/VCD) Control Screen

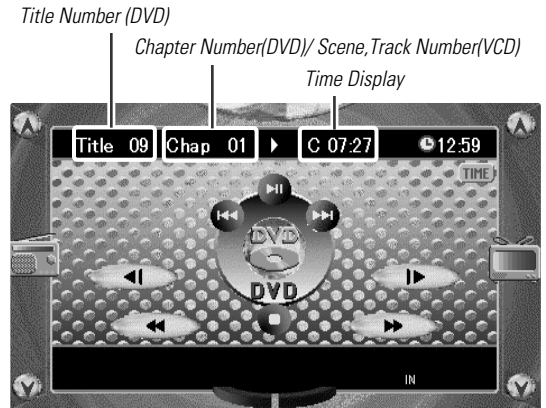
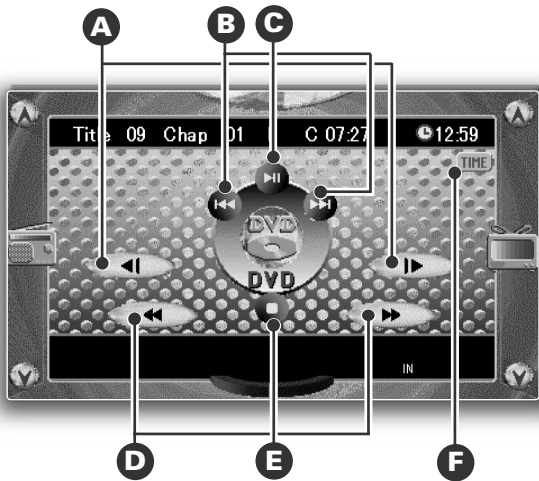

D Forward /Reverse Search Disc Play

C Forward search

Touch [►►].

Reverse search

Touch [◀◀].

Cancelling the search

Touch [►||] to resume normal playback.

NOTE

- Touch once to start and continue forward or reverse search at a low speed. Each time you touch, the search speed goes from 1 times (x 1) to 2 times (x 2) to 3 times (x 3).
- Audio is not output during forward or reverse search. (DVD, VCD)
- The video may be disturbed during forward or reverse search.
- When [◀◀] or [►►] is touched during menu playback of a VCD, the screen may sometimes return to the menu screen.

B Chapter/Track Search

Making a Forward Search

Touch [►►|] once to fast forward to the next chapter/track, twice to fast forward to the chapter/track after that, and so forth.

Making a Reverse Search

Touch [◀◀|] once to search back to the beginning of the current chapter/track, twice to search back to the beginning of the previous chapter/track, and so forth.

A Slow playback

C Slow playback is possible in 3 speed steps.

Forward slow playback

Touch [►].

Reverse slow playback

Touch [◀].

Cancelling the slow playback

Touch [►||] to resume normal playback.

NOTE

- Touch once to start and continue forward or reverse search at a high speed. Each time you touch, the search speed goes from 1 times (x 1)

to 1/2 times (x 2) to 1/3 times (x 3).

- Reverse slow playback is not available with a VCD.

C Pausing and Restarting Disc Play

Touch [►||] to make the disc pause.

Touch [►||] again to start play again.

NOTE

The following operation may not be available with certain discs.

C Frame-by-frame playback

1 Touch [►||] during pause.

2 Each time you touch [►|] advances to the next frame.

Cancelling the frame-by-frame playback

Touch [►||] to resume normal playback.

NOTE

According to the screen, there are times when the Menu or background image etc., will not operate.

E Stopping playback

- Touch [■] once during playback stops it and the position where it is stopped is stored in memory. (When the [R] indicator is displayed)
- Touch [■] twice to cancel playback.

F Selecting the Time Display for Disc

Each time you touch [TIME], the time display during disc play switches as follows:

DVD

C : Chapter time < > T : Title time

NOTE

The chapter time is not displayed depending on software.

VCD

P : Elapsed time of track being played < >

A : Elapsed time of entire disc

NOTE

[TIME] is not displayed when the PBC function is set to "ON". (see P.16)

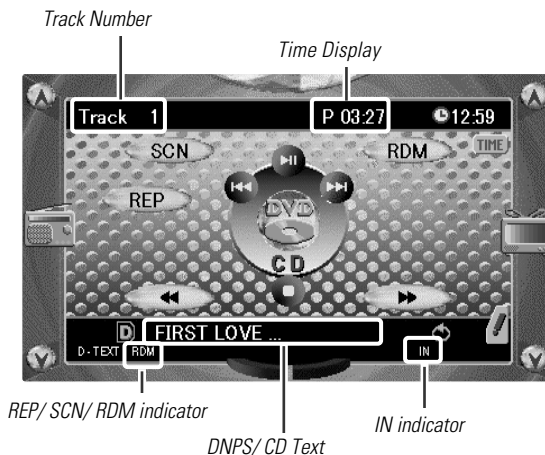
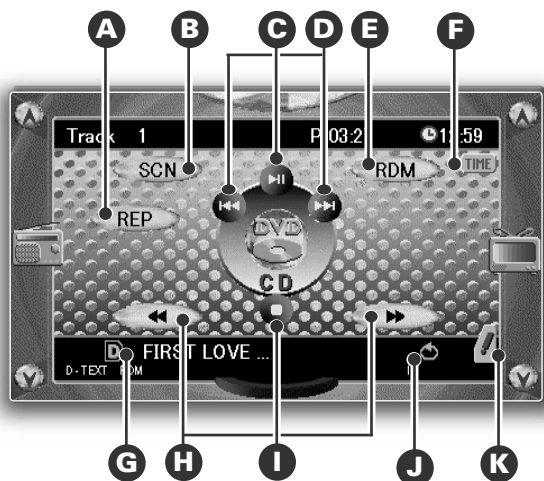

C Pausing and Restarting Disc Play

Touch [PAUSE] to make the disc pause.
Touch [PAUSE] again to start play again.

D Track Search

Search forwards or backwards through the tracks on the disc until you reach the one that you want to listen to.

Making a Forward Search

Touch [FAST FORWARD] once to fast forward to the next track, twice to fast forward to the track after that, and so forth.

Making a Reverse Search

Touch [FAST REVERSE] once to search back to the beginning of the current track, twice to search back to the beginning of the previous track, and so forth.

H Forward /Reverse Search Disc Play

C Forward search

Touch [FAST FORWARD].

Reverse search

Touch [FAST REVERSE].

Cancelling the search

Touch [PAUSE] to resume normal playback.

I Stopping playback

- Touch [STOP] once during playback stops it and the position where it is stopped is stored in memory.
- Touch [STOP] twice to cancel playback.

A Track Repeat Function

Repeat playing the current track.

Touch [REP] to switch the track repeat play function on and off.

The REP indicator is displayed when the track repeat play function is turned on.

NOTE

Repeat play is cancelled when you eject the disc.

B Track Scan Function

Successively play the beginning of each track on a disc until you find the one that you want to listen to.

Turning Track Scan Function On/Off

Touch [SCN] to switch the track scan function on and off.

The SCN indicator is displayed when the track scan function is turned on.

The first 10 seconds of each track are played, and the tracks are played in order.

Stopping to Listen to the Track Being Scanned

Touch [PAUSE] or [SCN] again to stop the scan and keep on listening to a track normally.

NOTE

- Scan play is cancelled when you eject the disc.
- The track scan function only scans each track on a disc once.

E Track Random Play Function

Play all the tracks on the current disc in random order.

- 1 Touch [RDM] to switch the random play function on and off.

The RDM indicator is displayed when the random play function is turned on.

The display of the track number changes continuously as the next track is being selected.

When the track has been selected, play starts.

- 2 To change the track being heard, touch [FAST FORWARD]. Another track is selected and played.

NOTE

Random play is cancelled when you eject the disc.

CD Control Screen

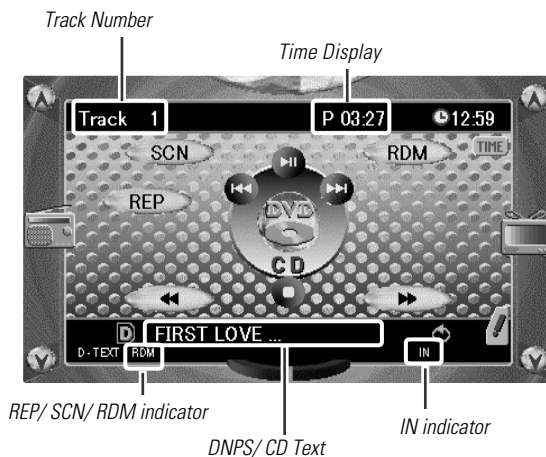
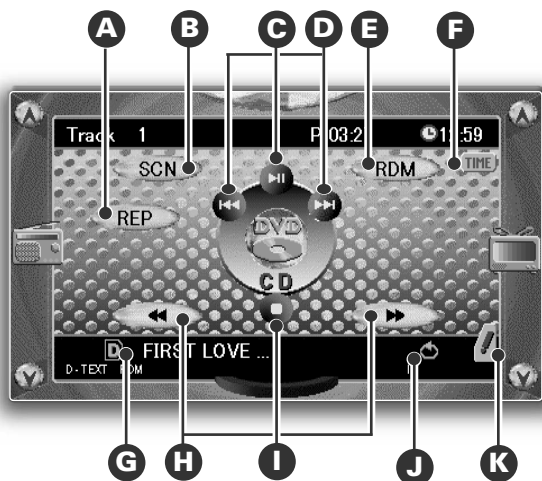

G Selecting the Name or Title Display for Discs

Each time you touch [D], the display during disc play switches as follows:

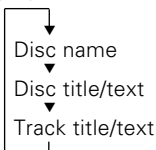

NOTE

- You can give names to discs through the presetting disc name function.
- If you try to display the name of a disc that does not have one, "No Name" is displayed instead.
- If you try to display the title of a disc that does not have one, "No Text" is displayed instead.

J To Scroll Manually

Touch [⏪] to display the disc title or the track title. The titles will be displayed in one scrolling display.

F Selecting the Time Display

Each time you touch [TIME], the time display during disc play switches as follows:

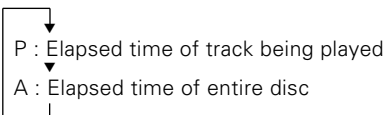

K Switching to the Name Set Screen

Touch [⏸] for at least two seconds to switch to the name set screen.(see P.42)

NOTE

You cannot operate unless the parking brake is set.

External Disc Control Function

External CD Player Control Screen

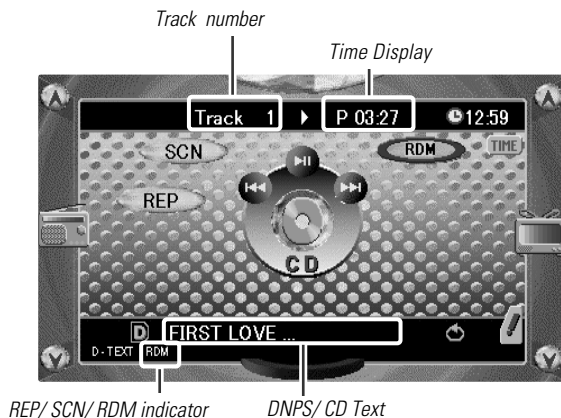
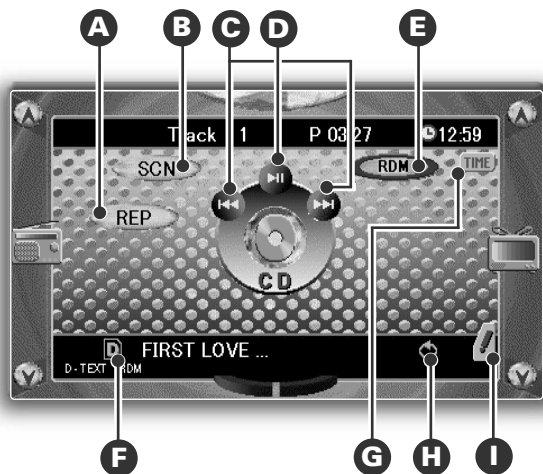

D Pausing and Restarting Disc Play

Touch [▶||] to make the disc pause.
Touch [▶||] again to start play again.

NOTE

When one disc has finished playing its last track, the next disc in the changer starts playing. When the last disc in the changer has finished, the player returns to the first disc and starts playing it.

C Track Search

Search forwards or backwards through the tracks on the disc until you reach the one that you want to listen to.

Making a Forward Track Search

Touch [▶▶] once to fast forward to the next track, twice to fast forward to the track after that, and so forth.

Making a Reverse Track Search

Touch [◀◀] once to search back to the beginning of the current track, twice to search back to the beginning of the previous track, and so forth.

C Fast Forwarding and Reversing Disc Play

Fast Forwarding Disc Play

Hold down on [▶▶].
Release your finger to play the disc at that point.

Reversing Disc Play

Hold down on [◀◀].
Release your finger to play the disc at the point.

A Track Repeat Function

Repeat playing the current track.

Touch [REP] to switch the track repeat play function on and off.
The REP indicator is displayed when the track repeat play function is turned on.

NOTE

Repeat play is cancelled when you eject the disc.

B Track Scan Function

Successively play the beginning of each track on a disc until you find the one that you want to listen to.

Turning Track Scan Function On/Off

Touch [SCN] to switch the track scan function on and off.

The SCN indicator is displayed when the track scan function is turned on.

The first 10 seconds of each track are played, and the tracks are played in order.

Stopping to Listen to the Track Being Scanned

Touch [▶||] or [SCN] again to stop the scan and keep on listening to a track normally.

NOTE

- Scan play is cancelled when you eject the disc.
- The track scan function only scans each track on a disc once.

E Track Random Play Function

Play all the tracks on the current disc in random order.

- 1 Touch [RDM] to switch the random play function on and off.

The RDM indicator is displayed when the random play function is turned on.

The display of the track number changes continuously as the next track is being selected.

When the track has been selected, play starts.

- 2 To change the track being heard, touch [▶▶].
Another track is selected and played.

NOTE

Random play is cancelled when you eject the disc.

External Disc control Function

Disc Changer Control Screen

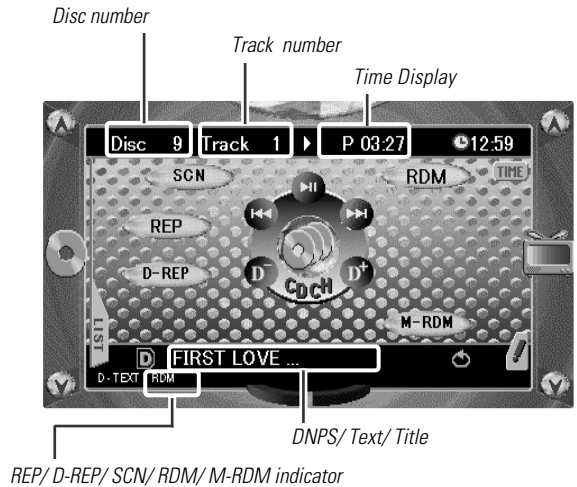
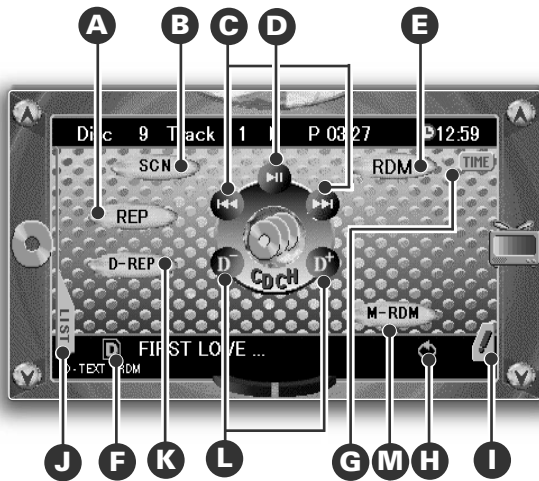

L Disc Search (Function of disc changers)
Search forwards or backwards through the discs in a disc changer until you reach the one that you want to listen to.

Making a Forward Disc Search

Touch [D +] to display the desired disc number. Each time [D +] is touched, the displayed disc number increases by one. Play starts at the beginning of the displayed disc.

Making a Reverse Disc Search

Touch [D -] to display the desired disc number. Each time [D -] is touched, the displayed disc number decreases by one. Play starts at the beginning of the displayed disc.

NOTE

- "Disc loading..." is displayed when discs are being exchanged on the disc changer.
- The 3+1MD changer cannot be operated when 4 disks are inserted.

K Disc Repeat Function
 (Function of disc changers)

Repeat playing the current disc.

Touch [D-REP] to switch the disc repeat play function on and off. The D-REP indicator is displayed when the disc repeat play function is turned on.

NOTE

- Repeat play is cancelled when you eject the disc.
- The 3+1MD changer cannot be operated when 4 disks are inserted.

M Magazine Random Play Function
 (Function of disc changers)

Play the tracks on all the discs in the disc changer in random order.

1 Touch [M-RDM] to switch the magazine random play function on and off. The M-RDM indicator is displayed when the magazine random play function is turned on. The display of the disc and track numbers change continuously as the next track is being selected.

When the disc/track has been selected, play starts.

2 To change the track being heard, touch [>>>|]. Another disc/track is selected and played.

NOTE

- Random play is cancelled when you eject the disc.
- The time needed for random selection depends on the number of discs loaded in the disc magazine.
- The 3+1MD changer cannot be operated when 4 disks are inserted.

F Selecting the Name or Title Display for Discs

Each time you touch [D], the display during disc play switches as follows:

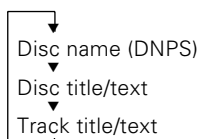

NOTE

- You can give names to discs through the presetting disc name function.
- If you try to display the name of a disc that does not have one, "No Name" is displayed instead.
- If you try to display the title of a disc that does not have one, "No Text" / "No Title" is displayed instead.

H To Scroll Manually

Touch [⏪] to display the disc title or the track title. The titles will be displayed in one scrolling display.

G Selecting the Time Display for CDs

Each time you touch [TIME], the time display during disc play switches as follows:

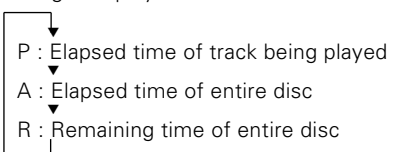

Disc List Screen

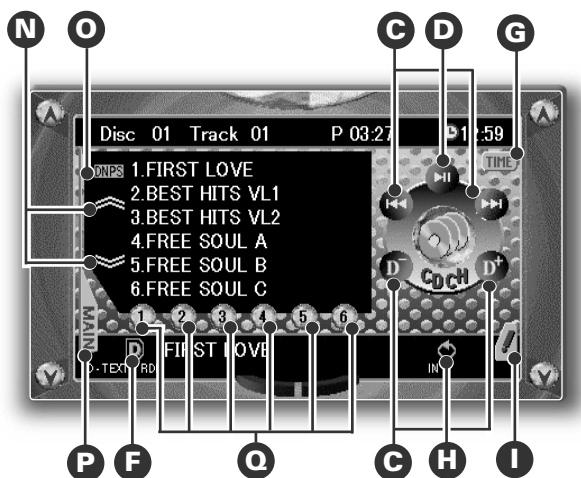

I Switching to the Name Set Screen

(Function of CD player/ CD changers)

Touch [] for at least two seconds to switch to the name set screen.(see P.42)



NOTE

You cannot operate unless the parking brake is set.

J Switching to the Disc List Screen

Touch [LIST] to switch the disc list screen.

N Changing the Disc List

Each time you touch [] or [], the disc list switches between the disc1-6 and disc 7-10.

O Switching the Display for Discs

Each time you touch [DNPS] or [TEXT] to the list switches between the DNPS and CD text.

Q Selecting the Disc

Touch the disc number [1] - [10] in the list for the desired disc. The number of the changed disc is displayed.

NOTE

The 3+1MD changer cannot be operated when 4 disks are inserted.

P Returning to the Source Control Screen

Touch [MAIN] to return to the source control screen .



Station Name Preset (SNPS) /Disc Name Preset (DNPS)

- 1 If the cursor is in the desired character input position, go on to step 4. If not touch either [◀] or [▶] to move the cursor to the desired position. Touching [◀] moves the cursor to the left and touching [▶] moves it to the right.
- 2 Touch [↖] or [↘] to switch the character lists.
- 3 Touch a character.
- 4 Continue steps 1 and 3 until all the characters have been input for the name.

NOTE

- You can enter up to 16 characters for each name.
 - To enter a space, touch [SPACE]. A blank is inserted and the cursor moves to the right.
- 5 Touch [RTN] to finish name entry and leave the name preset mode.

NOTE

- If you want to change the name of a station, first display the name of the station (following step 1), then change the letter(s) that you by following steps 2, and 3.
- You can assign names for up to 20 TV stations.
- You can only store names for up to 100 CDs. 101st Disc Name Preset is made, the oldest disc name will be automatically erased to make room for the new setting.
- CDs are identified by their total length and number of tracks. If you play another CD that happens to have exactly the same specifications as another CD whose name is stored, the wrong name may be displayed.

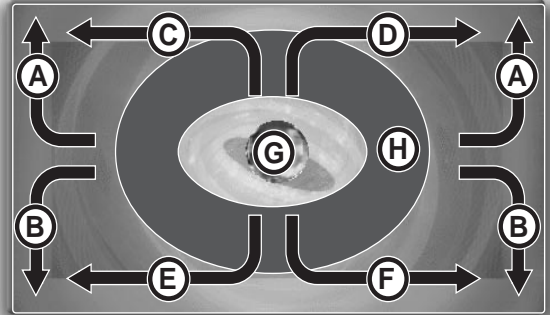

A When you drag in the direction of (A)

Increase the volume.

B When you drag in the direction of (B)

Decrease the volume.

D When you drag in the direction of (D)

- **In TV,FM/AM tuner mode**
Seek up.
- **In Disc mode**
Chapter/Scene/Track search up.

C When you drag in the direction of (C)

- **In TV,FM/AM tuner mode**
Seek down.
- **In Disc mode**
Chapter/Scene/Track search down.

E When you drag in the direction of (E)

- **In TV tuner mode**
Changing the preset band TV1,TV2 and video1 video2.
- **In FM/AM tuner mode**
Changing the preset band FM1,FM2,FM3 and AM.
- **In Disc Changer mode**
Making a forward disc search

F When you drag in the direction of (F)

- **In TV tuner mode**
Changing the preset band TV1,TV2 and video1 video2.
- **In FM/AM tuner mode**
Changing the preset band FM1,FM2,FM3 and AM.
- **In Disc Changer mode**
Making a reverse disc search

H Touch the part (H)

Each time you touch the part (H), the graphic mode changing six patterns.

G Touch the part (G)

Touch the part (G) to return to the source control screen.

Sound Effect Menu Function

Sound Effect Menu Screen

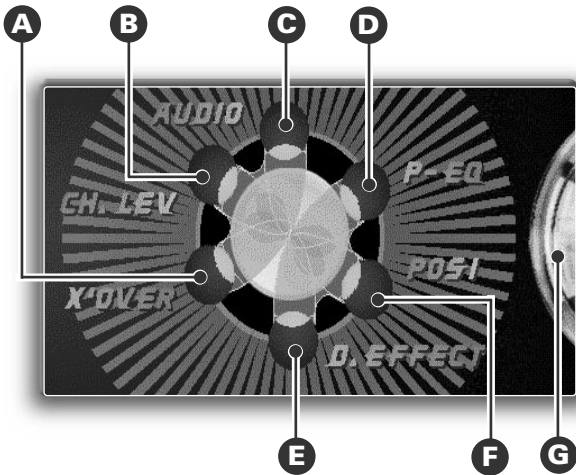

CAUTION

You cannot operate the Digital Effect Setting Screen, Position Setting Screen, Crossover Network Setting Screen and Parametric Equaliser Screen when the "2zone" function is set to "ON" on the System Setup Screen (see page 12) or the "Noise" function is set to "ON" on the Channel Level Setting Screen (see page 49).

C Switching to the Audio Control Screen

Touch [Audio] to switch to the Audio Control Screen (Page 44).

A Switching to the Crossover Network Setting Screen

Touch [X'OVER] to switch to Crossover Network Setting Screen (Page 46).

A Switching to the Crossover Setting Screen

<When the KDS-P900 is connected>

Touch [X'OVER] to switch to Crossover Network Setting Screen (Page 50).

F Switching to the Position Setting Screen

<When the KDS-P900 is connected>

Touch [POSI] to switch to the Position Setting Screen (Page 48).

B Switching to the Channel Level Setting Screen

<When the KDS-P900 is connected>

Touch [CH.LEV] to switch to the Channel Level Setting screen (Page 49).

E Switching to the Digital Effect Setting Screen

<When the KDS-P900 is connected>

Touch [D.EFFECT] to switch to the Digital Effect Setting Screen (Page 47).

D Switching to the Parametric Equaliser Screen

<When the KDS-P900 is connected>

Touch [P-EQ] to switch to the Parametric Equaliser Screen (Page 52).

G Ending the Sound Effect Menu Screen

Touch this icon to return to the Menu Screen.

Audio Control Function

Audio Control Screen

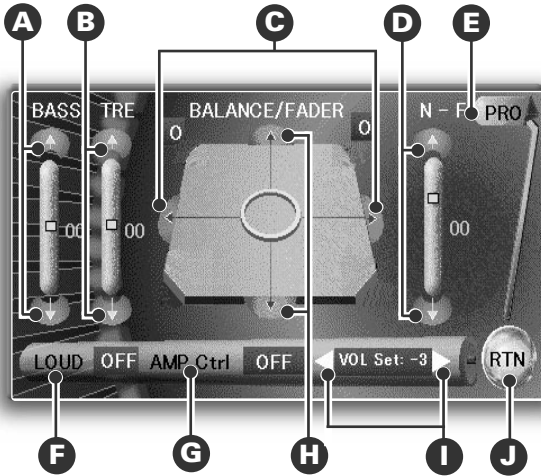

Sound Preset Screen

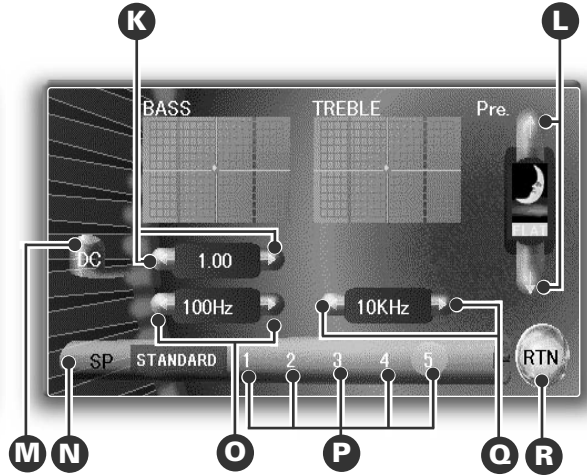

A Adjusting the Bass Level

- Each time you touch [↑], the bass level is increased.
- Each time you touch [↓], the bass level is decreased.

NOTE

No display this item when the KDS-P900 is connected.

B Adjusting the Treble Level

- Each time you touch [↑], the treble level is increased.
- Each time you touch [↓], the treble level is decreased.

NOTE

No display this item when the KDS-P900 is connected.

C Adjusting the Balance Levels

- Each time you touch [←](L), the sound in the left channel is emphasised.
- Each time you touch [→](R), the sound in the right channel is emphasised.

D Adjusting the Non-Fader Levels <N-F> <When the KDS-P900 is not connected>

- Each time you touch [↑], the non-fader level is increased.
- Each time you touch [↓], the non-fader level is decreased.

D Adjusting the Sub Woofer Levels <SUB> <When the KDS-P900 is connected>

- Each time you touch [↑], the sub woofer level is increased.
- Each time you touch [↓], the sub woofer level is decreased.

NOTE

You cannot operate when the "Sub Woofer" is set to "OFF" on the digital effect setting Screen (see.P.47).

H Adjusting the Fader Levels

- Each time you touch [↑](F), the sound in the front channel emphasised.
- Each time you touch [↓](R), the sound in the rear channel emphasised.

F Turning the Loudness On/Off

This function amplifies low and high tones when the volume is turned down. The LOUD indicator is displayed on the source control screen, when the loudness function is on.

Each time you touch [LOUD] to switch the function on and off.

NOTE

No display this item when the KDS-P900 is connected.

G External Amp Control

Adjust the bass boost level of the external amplifier using the main unit.

Each time you touch [Amp Ctrl] to switch the Bass boost level as follows:

" OFF "

Bass boost level is flat.

" MODE1 "

Bass boost level is low (+6dB).

" MODE2 "

Bass boost level is high (+12dB).

NOTE

As of December 2000, the power amplifiers controllable by the main unit are as follows:
KAC-X501F/PS501F/X401M/PS401M/X301T/
PS301T/X201T/PS201T

I Adjusting the Volume Offset

Set the sound level of the each source selected by adjusting the level difference between the basic sound level and the required level.

- Each time you touch [►], the level is increased.
- Each time you touch [◀], the level is decreased.

J **Ending the Audio Control Screen**

Touch [RTN] to return to the sound effect menu screen.

E **Switching to the Sound Preset Screen**

Touch [PRO] to switch to the Sound preset screen.

NOTE

No display [PRO] when the KDS-P900 is connected.

L **Recalling the Kenwood Preset Sound**

Each time you touch [↑] or [↓], the preset sound setting switches between the "Flat", "Easy", "Jazz", "Pops(Top40)" and "Rock".

O **Adjusting the Centre Frequency of the Bass**

Each time you touch [←] or [→] to switch the centre frequency of the bass as follows:

60 / 70 / 80 / 100 Hz (Only when the bass quality factor is set to 1.00, 1.25 or 1.50) / 150 Hz (Only when the bass quality factor is set to 2.00)

K **Adjusting the Bass Quality Factor**

Each time you touch [←] or [→] to switch the Bass quality factor as follows:

1.00 / 1.25 / 1.50 / 2.00

O **Adjusting the Centre Frequency of the Treble**

Each time you touch [←] or [→] to switch the centre frequency of the treble as follows

10.0 / 12.5 / 15.0 / 17.5 kHz

M **Switching the Bass Extend mode On/Off**

Each time you touch [DC] to switch the function on and off.

When the function is on, the [DC] icon to indicate to amber and low frequency response is extended by 20%.

N **Setting the Speaker Type**

Using this function to set the diameter of the speaker optimizes the sound quality to the speaker diameter.

Each time you touch [SP] to select the speaker type as follows:

" STANDARD "

Speaker with a general diameter

" NARROW "

Speaker with small diameter

" WIDE "

Woofer with a large diameter

" MIDDLE "

Woofer with a small diameter

NOTE

This function fine-tunes the settings for bass centre frequency, bass level, bass quality factor, bass extension, treble centre frequency, and treble level which are recalled by Sound preset under Audio control.

P **Storing Your Sound Settings**

Hold down a [1] - [5] for two seconds or more except during the bass centre frequency, bass level, bass quality factor, bass extension, treble centre frequency, and treble level adjust mode.

Recalling your sound settings

Touch [1] - [5] except during the bass centre frequency, bass level, bass quality factor, bass extension, treble centre frequency, and treble level adjust mode.

R **Ending the Sound Preset Screen**

Touch [RTN] to return to the audio control screen.

Audio Control Function

Crossover Network Setting Screen

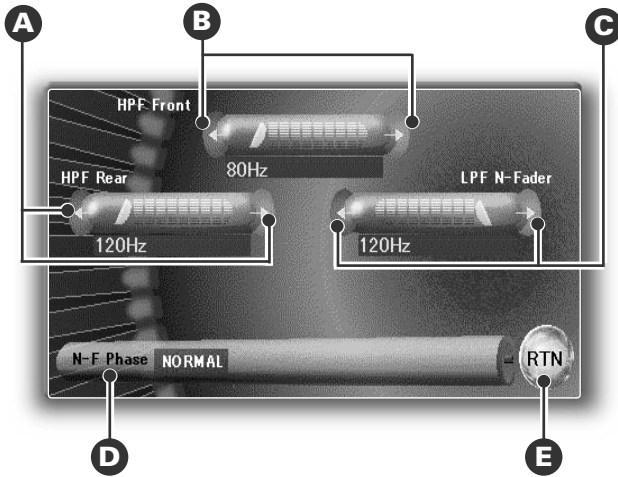

A Adjusting the High-pass filter for Rear output

Adjust the frequency of the High-pass filter

Each time you touch [←] or [→] to adjust the frequency as follows:

THR (through) / 40Hz / 60Hz / 80Hz / 100Hz / 120Hz / 150Hz / 180Hz / 220Hz

B Adjusting the High-pass filter for Front output

Adjust the frequency of the High-pass filter

Each time you touch [←] or [→] to adjust the frequency as follows:

THR (through) / 40Hz / 60Hz / 80Hz / 100Hz / 120Hz / 150Hz / 180Hz / 220Hz

C Adjust the frequency of the Low-pass filter for Non-Fading output.

Adjust the frequency of the Low-pass filter

Each time you touch [←] or [→] to adjust the frequency as follows:

50 Hz / 80 Hz / 120 Hz / THR (through)

D Setting the phase for Non-Fading output

Each time you touch [N-F Phase] to switch the phase as follows:

" NORMAL "

0°

" REVERSE "

180°

E Returning to the Sound Effect Menu Screen

Touch [RTN] to return to the sound effect menu screen.

5.1 Channels Surround Processor Control Function

Digital Effect Setting Screen

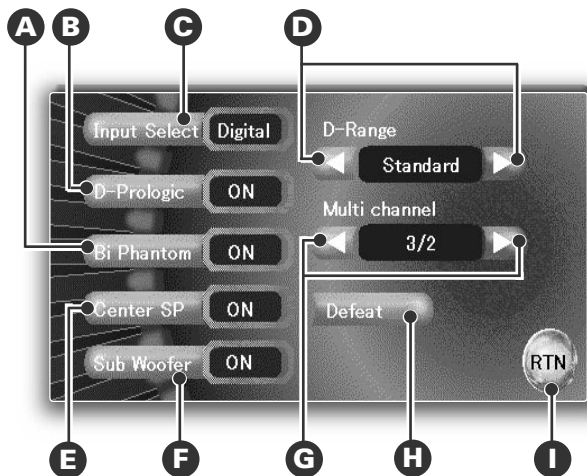

C Selecting the Digital Input Mode

Each time you touch [Input Select] to switch the digital input mode as follows:

" Digital "

Optical digital input.

" Analog "

Analog input.

CAUTION

When playing DTS-encoded (CDs, DVDs), excessive noise may be exhibited from the analog stereo outputs. To avoid possible damage to audio system, the consumer should take proper pre-cautions when the analog stereo outputs of the DVD player is connected to an amplification system.

B Using the DOLBY PRO LOGIC

Dolby Pro Logic is a technology developed by Dolby Laboratories for the active decoding of Dolby Surround encoded source.

Each time you touch [D-Prologic] to select Dolby Prologic on and off .

A Selecting the Acoustic Image

Each time you touch [Bi Phantom] to select the acoustic image on and off .

NOTE

You cannot operate when "D-Prologic" is set to "OFF".

E Turning the Centre Output On/Off

Each time you touch [Center SP] to select centre speaker output on and off.

NOTE

This select can be made when the 2 ch PCM signal.

F Turning the Sub Woofer Output On/Off

Each time you touch [Sub Woofer] to select sub woofer output on and off.

D Selecting the Dynamic Range

Select the dynamic range for Dolby Digital sound.

Each time you touch [D-Range], the dynamic range switches as follows:

" Standard "

For more powerful sound at regular volumes.

" OFF "

For regular sound.

G Selecting the Multi Channel

Select the sound output speaker for Multi channel PCM sound.

Each time you touch [◀] or [▶] to select the speaker output as follows:

" 3/2 "

Centre, Front and Rear speaker

" 2/2 "

Front and Rear speaker

" 3/0 "

Centre and Front speaker

" 2/0 "

Front speaker only

NOTE

You cannot operate when "D-Prologic" is set to "OFF".

H Defeat

Returns all of the DSP settings to the factory default.

Touch [Defeat] it returns to the factory default.

I Returning to the Sound Effect Menu Screen

Touch [RTN] to return to the sound effect menu screen.

5.1 Channels Surround Processor Control Function

Position Setting Screen

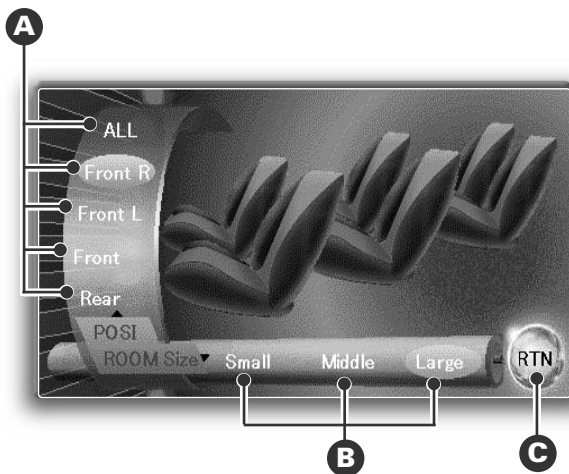

A *Selecting the Position Mode*

Touch [ALL], [Front R], [Front L], [Front] or [Rear], the listening position will be switched as follows:

" ALL "

Centre of the passenger cabin

" Front R "

Centred on the front right seat

" Front L "

Centred on the front left seat

" Front "

Centred on the front seat

" Rear "

Centred on the rear seat

B *Setting the Room Size Mode*

Touch the [Small], [Middle] or [Large], the room size can be adjusted as follows:

" Small "

For compact cars where front and rear speakers are close to each other

" Middle "

For sedans

" Large "

For large vans or RVs where front and rear speakers are far apart from each other

NOTE

Room size cannot be adjusted when position select mode is set to "ALL".

C *Returning to the Sound Effect Menu Screen*

Touch [RTN] to return to the sound effect menu screen.

Channel Level Setting Screen

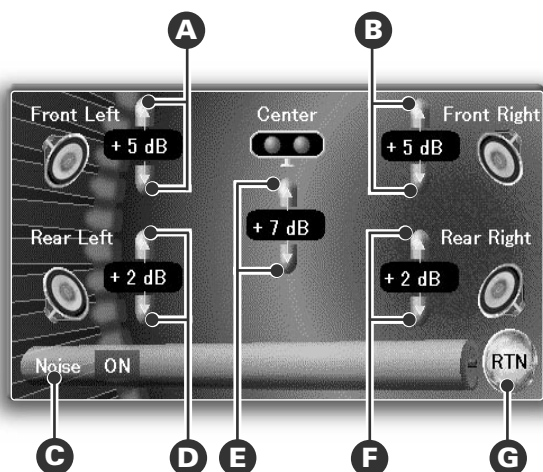

Setting the Channel Balance

This item allows you to adjust the output level of each type of speaker using the built-in test signal. The output level must be adjusted from the listening position. The factory setup is "0 dB" for all types of speakers.

C Test Signal

This item allows you to output the built-in test signal from the speakers. Use the test signal for setting the balance between channels.

Each time you touch [Noise] to switch the test signal function on and off.

A Adjusting the Front Left Speaker

Each time you touch [↑] or [↓] to adjust the front left output level.

B Adjusting the Front Right Speaker

Each time you touch [↑] or [↓] to adjust the front right output level.

D Adjusting the Rear Left Speaker

Each time you touch [↑] or [↓] to adjust the rear left output level.

NOTE

You cannot operate when the "Multi channel" is set to "3/0" or "2/0" (see P 47) <When playing with multi-channels>.

F Adjusting the Rear Right Speaker

Each time you touch [↑] or [↓] to adjust the rear right output level.

NOTE

You cannot operate when the "Multi channel" is set to "3/0" or "2/0" (see P 47) <When playing with multi-channels>.

E Adjusting the Centre Speaker

Each time you touch [↑] or [↓] to adjust the centre output level.

NOTE

- You cannot operate when the "Center SP" is set to "OFF" (see P 47) <When playing with multi-channels>.
- You cannot operate when the "Multi channel" is set to "2/2" or "2/0" (see P 47).

G Returning to the Sound Effect Menu Screen

Touch [RTN] to return to the sound effect menu screen.

5.1 Channels Surround Processor Control Function

Crossover Network Setting Screen

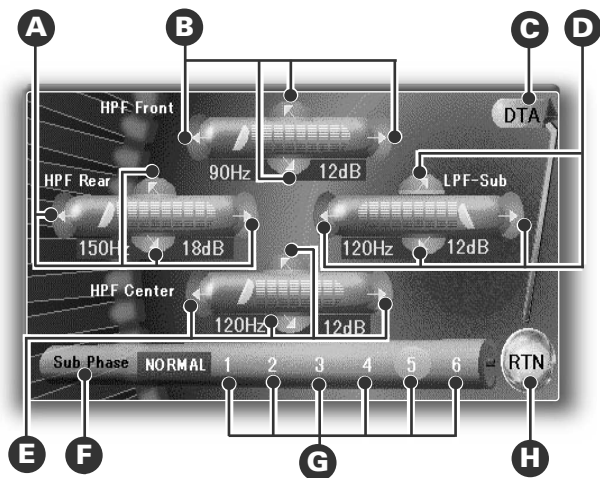

NOTE (A)(B)(C)(D)(E)

You cannot operate when the "Sub Woofer" is set to "OFF" (see P.47).

NOTE (A)

You cannot operate when the "Multi channel" is set to "3/0" or "2/0" on the digital effect setting screen (see P 47) <When playing with multi-channels>.

NOTE (E)

- You cannot operate when the "Center SP" is set to "OFF" (see P 47) <When playing with multi-channels>.
- You cannot operate when the "Multi channel" is set to "2/2" or "2/0" (see P 47) <When playing with multi-channels>.

A Adjusting the High-pass filter for Rear output

Adjust the frequency

Each time you touch [←] or [→] to adjust the frequency as follows:

THR (through) / 30Hz / 60Hz / 90Hz / 120Hz / 150Hz / 180Hz / 250Hz

Adjust the slope

Each time you touch [↖] or [↘] to adjust slope (12dB, 18dB and 24dB).

B Adjusting the High-pass filter for Front output

Adjust the frequency

Each time you touch [←] or [→] to Adjust the frequency as follows:

THR (through) / 30Hz / 60Hz / 90Hz / 120Hz / 150Hz / 180Hz / 250Hz

Adjust the slope

Each time you touch [↖] or [↘] to adjust the slope (12dB, 18dB and 24dB).

D Adjust the frequency of the Low-pass filter for Sub Woofer output.

Adjust the frequency of the Low-pass filter

Each time you touch [←] or [→] to adjust the frequency as follows:

30Hz / 60Hz / 90Hz / 120Hz / 150Hz/ 180Hz / 250Hz

Adjust the slope

Each time you touch [↖] or [↘] to adjust the slope (12dB, 18dB and 24dB).

E Adjusting the High-pass filter for Centre output

Adjust the frequency

Each time you touch [←] or [→] to adjust the frequency as follows:

THR (through) / 30Hz / 60Hz / 90Hz / 120Hz / 150Hz / 180Hz / 250Hz

Adjust the slope

Each time you touch [↖] or [↘] to adjust the slope (12dB, 18dB and 24dB).

F Setting the phase for Sub Woofer output

Each time you touch [Sub Phase] to switch the phase as follows:

"NORMAL "

0°

"REVERSE "

180°

G Storing Your Settings of the Crossover network/Delay time

Touch [1] - [6] for at least two seconds.

Recalling your settings of the Crossover network/delay time

Touch [1] - [6] for the desired crossover network and delay time setting.

C Switching to the Delay Time Setting Screen

Touch [DTA] to switch to the delay time setting screen.(see p.51)

H Returning to the Sound Effect Menu Screen

Touch [RTN] to return to the sound effect menu screen.

Delay Time Setting Screen

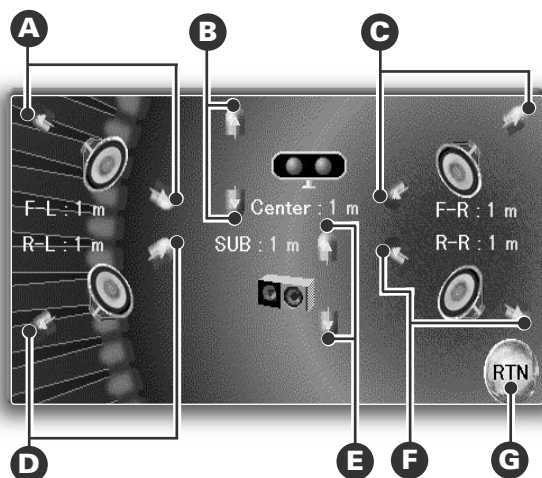

The ideal listening position for 5.1-channel surround playback is the point at equal distance from all speakers.

By setting the delay time for the centre and surround speakers, this item realises the ideal listening position virtually.

A Adjusting the Front Left Speaker

Touch the [↖] or [↗] to adjust the delay time for front left output.

C Adjusting the Front Right Speaker

Touch the [↘] or [↙] to adjust the delay time for front right output .

D Adjusting the Rear Left Speaker

Touch the [↘] or [↙] to adjust the delay time for rear left output.

NOTE

You cannot operate when the "Multi channel" is set to "3/0" or "2/0" (see P 47) <When playing with multi-channels>.

F Adjusting the Rear Right Speaker

Touch the [↖] or [↗] to adjust the delay time for rear right output.

NOTE

You cannot operate when the "Multi channel" is set to "3/0" or "2/0" (see P 47) <When playing with multi-channels>.

B Adjusting the Centre Speaker

Touch the [↑] or [↓] to adjust the delay time for centre output.

NOTE

- You cannot operate when the "Center SP" is set to "OFF" (see P 47) <When playing with multi-channels>.
- You cannot operate when the "Multi channel" is set to "2/2" or "2/0"(see P 47) <When playing with multi-channels>.

E Adjusting the Sub Woofer

Touch the [↑] or [↓] to adjust the delay time for non-fading output.

NOTE

You cannot operate when the "Sub Woofer" is set to "OFF" (see P 47).

G Ending to the Delay Time Setting Screen

Touch [RTN] to return to the crossover network screen.

5.1 Channels Surround Processor Control Function

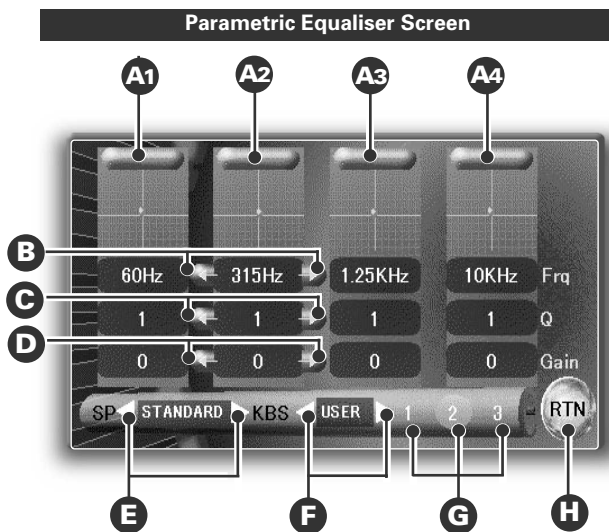

A Selecting the Adjust Band

Touch the each box to select the band.

B Adjusting the Centre Frequency

- Each time you touch [→], the frequency is increased.
- Each time you touch [←], the frequency is decreased.

A1: 60Hz/ 80Hz/ 100Hz/ 120Hz/ 160Hz/ 200Hz/ 250Hz
 A2: 315Hz/ 400Hz/ 500Hz/ 630Hz/ 800Hz/ 1kHz
 A3: 1.25kHz/ 1.6kHz/ 2kHz/ 2.5kHz/ 3.15kHz/ 4kHz
 A4: 5kHz/ 6.3kHz/ 8kHz/ 10kHz/ 12.5kHz/ 16kHz

C Adjusting the Quality Factor

Each time you touch [←] or [→] to switch the Bass quality factor as follows:

1(0.25) / 2(0.5)/ 3(1.0) /4(2.0)

D Adjusting the Gain

- Each time you touch [→], the gain is increased.
- Each time you touch [←], the gain is decreased.

E Setting the Speaker Type

Using this function to set the diameter of the speaker optimizes the sound quality to the speaker diameter.

Each time you touch [←] or [→] to switch the speaker type as follows

" STANDARD "

Speaker with a general diameter

" NARROW "

Speaker with small diameter

" WIDE "

Woofer with a large diameter

" MIDDLE "

Woofer with a small diameter

F Recalling the Kenwood Preset Sound

Each time you touch [◀] or [▶], the preset sound setting switches between the "FLAT", "POPS"(TOP40), "ROCK", "DANCE", "VOCAL" and "CLASSIC".

G Storing Your Sound Settings

Touch a [1] - [3] that you want to use for the equaliser curve for at least two seconds.

Recalling Your Sound Settings

Touch a [1] - [3] for the desired equaliser curve.

H Returning to the Sound Effect Menu Screen

Touch [RTN] to return to the sound effect menu screen.

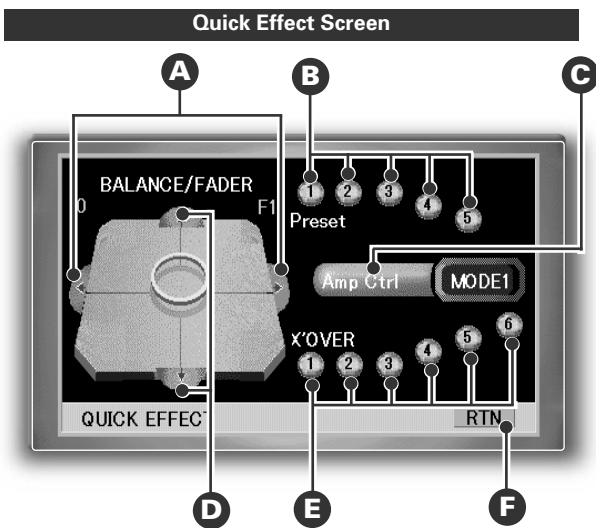

A Adjusting the Balance Levels

- Each time you touch [←], the sound in the left channel is emphasised.
- Each time you touch [→], the sound in the right channel is emphasised.

D Adjusting the Fader Levels

- Each time you touch [↑], the sound in the front channel emphasised.
- Each time you touch [↓], the sound in the rear channel emphasised.

E Recalling Your Settings of the Crossover Network/Delay time

<When the KDS-P900 is connected>

Touch [1]-[6] for the desired Crossover network and delay time setting.

B Recalling Your Sound Settings

<When the KDS-P900 is not connected>

Touch [1]-[5] for the desired sound preset setting.

<When the KDS-P900 is connected>

Touch [1]-[3] for the desired parametric equaliser setting.

C External Amp Control

Adjust the bass boost level of the external amplifier using the main unit.

Each time you touch [Amp Ctrl] to switch the Bass boost level as follows

" OFF "

Bass boost level is flat.

" MODE1 "

Bass boost level is low (+6dB).

" MODE2 "

Bass boost level is high (+12dB).

NOTE

As of December 2000, the power amplifiers controllable by the main unit are as follows:
KAC-X501F/PS501F/X401M/PS401M/X301T
/PS301T/X201T/PS201T

F Returning to the Source Control Screen

Touch [RTN] to return to the Source Control Screen.

Remote Control Function

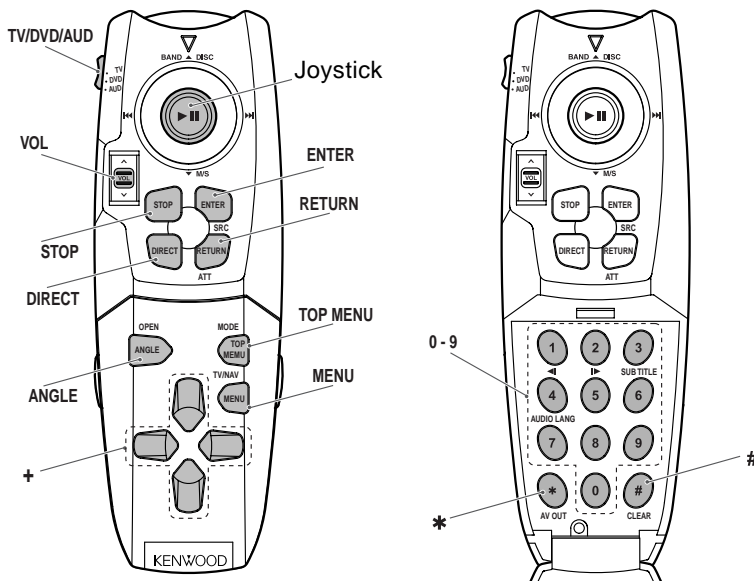

▶ TV/DVD/AUD button

When Controlling the Monitor/Television

Switching to the TV position.

When Controlling the DVD/VCD

Switching to the DVD position.

When Controlling the audio source (External Disc, FM/AM tuner)

Switching to the AUD position.

CAUTION

When "REMO" is set "OFF" in the System Setup Screen, TV-related operation cannot be done. (See page 13 for configuration of "REMO.")

Basic Source Control Function

▶ Switching the audio source mode <TV/AUD position>

Each time you press the [SRC] button to switch the audio source mode.

▶ Volume <TV/DVD/AUD position>

Each time you press the VOL button to ▲ side to increase the volume.

Each time you press the VOL button to ▼ side to decrease the volume.

▶ Turning Attenuator On/Off <TV/AUD position>

Press the [ATT] button to turn down the volume quickly. To return the volume to its original level, press the button again.

Monitor Control Function < TV or AUD position >

▶ Switching the monitor's picture

Each time you press [MENU] button to switch the monitor's picture.

▶ Switching the TV/Video Screen Mode

Each time you press [TOP MENU] button to switch the screen mode.

▶ Switching the AV Output Mode

Each time you press the [*] button to switch the AV out picture/sound.

TV Control Function < TV position >

▶ Selecting the Preset Bands and Video Input

Each time you move the Joystick to front side to switch between the TV1, TV2, video1 and video2.

▶ Selecting the Channels

- Move the Joystick to right side to seek up.
- Move the Joystick to left side to see down.

▶ Selecting the Tuning Mode

Each time you press the Joystick, the tuning mode switches to auto 1, auto 2 and manual.

▶ Recalling Preset Station

Press either [1] - [6] for the desired station.

▶ Direct Search

- 1 Press the [DIRECT] button to switch the direct search mode.
- 2 Press the [0] - [9] buttons and enter the channel number.

FM/AM Control Function < AUD position >

▶ Selecting the Preset Bands

- Each time you move the Joystick to front side to switch between the FM1, FM2 and FM3 bands.
- Move the Joystick to back side switch the AM band.

▶ Selecting the Station

- Move the Joystick to right side to seek up.
- Move the Joystick to left side to seek down.

▶ Selecting the PTY Search Screen

Each time you press the Joystick, the PTY Search Screen can be displayed and cancelled.

▶ Recalling Preset Station

Press either [1] - [6] for the desired station.

▶ Direct Search

- 1 Press the [DIRECT] button to switch the direct search mode.
- 2 Press the [0] - [9] buttons and enter the frequency.

DVD/VCD/CD Control Function < DVD position >

► Pausing and Restarting Disc Play

- Press the Joystick to make the disc pause.
- Press the Joystick to start play again.

► Manual Search

Forward search

Move the Joystick to front side.

Reverse search

Move the Joystick to back side.

NOTE (DVD/VCD)

Each time you move the Joystick, the search speed goes from 1 times(x1) to 2 times(x2) to 3 times(x3).

► Chapter/Track Search

Forward search

Move the Joystick to right side.

Reverse search

Move the Joystick to left side.

► Slow playback (DVD/VCD)

- Press the [2 (►)] button, forward slow playback. (DVD/VCD)
- Press the [1 (◀)] button, reverse slow playback.(DVD)

NOTE

Each time you press the buttons, the search speed goes from 1 times(x1) to 1/2 times(x2) to 1/3 times(x3).

► Frame-by-frame playback

- 1 Press the Joystick to make the disc pause.
- 2 Move the Joystick to right side to the next frame.

Canceling the frame-by-frame playback

Press the Joystick.

► Stopping playback

- Press the [STOP] button once during playback stops it and the position where it is stopped is stored in memory.
- Press the [STOP] button twice to cancel playback.

► Switching the Menu Screen (DVD)

Press the [MENU(MODE)] to display the menu.

Selecting the menu item

Press the each the [+] buttons to select the menu item.

Setting the menu item

Press the [ENTER] button.

Switching the top menu item

Press the [TOP MENU] button.

Returning to the menu

Press the [RETURN] button.

► Selecting the sub title language (DVD)

Each time you press the [3(SUB TITLE)] button to change the sub title language.

► Selecting the audio language (DVD)

Each time you press the [4(AUDIO LANG)] button to change the voice language.

► Switching Multiple Audio Mode (VCD)

The audio output mode switches in the following order when the [4(AUDIO LANG)] is pressed while playing CDs.



► Chapter, Title, Time and Number Search(DVD)

- 1 Each time you press the [DIRECT] button the direct search mode switches between the chapter, title, time and number.
- 2 Press the [0] - [9] buttons and enter the number or time.
- 3 Press the [ENTER] button to start the search for chapter, title and number search.

► PBC (VCD)

Use the [ENTER] / [RETURN] buttons and Joystick (left / right)

Direct Number Search

- 1 Press the [DIRECT] button to display the menu.
- 2 Press the [0] - [9] buttons and enter the number .
- 3 Press the [ENTER] button to start the search.

► Direct Track Search (CD)

- 1 Press the [DIRECT] button to switch the direct track search mode.
- 2 Press the [0] - [9] buttons and enter the track number.
- 3 Move the Joystick to right or left side to start the track search.

External Disc Control Function < AUD position >

► Pausing and Restarting Disc Play

- Press the Joystick to make the disc pause.
- Press the Joystick to start play again.

► Track Search

- Move the Joystick to left side to search through the tracks backwards.
- Move the Joystick to right side to search through the tracks forwards.

► Disc Search

- Move the Joystick to back side to search through the discs backwards.
- Move the Joystick to front side to search through the discs forwards.

► Direct Track Search

- 1 Press the [0] - [9] buttons and enter the track number.
- 2 Move the Joystick to right or left side to start the track search.



► Direct Disc Search

- 1 Press the [0] - [9] buttons and enter the disc number.
- 2 Move the Joystick to front or back side to start the disc search.

Accessories

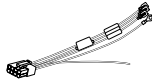

External view

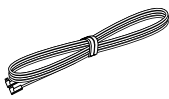
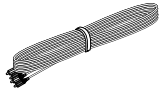
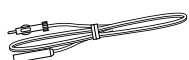
..... Number of items

(A)	1
(B)	1
(C)	1
(D)	1
(E)	1
(F)	1



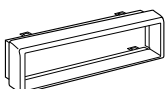
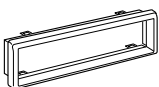
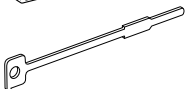

External view

..... Number of items

(G)	1
(H)	1
(I)	1
(J)	2
(K)	2
(L)	2

External view

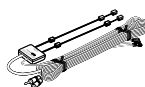
..... Number of items

(M)	4
(N)	4
(O)	2
(P)	1
(Q)	6

CAUTION

The use of any accessories except for those provided might result in damage to the unit. Make sure only to use the accessories shipped with the unit, as shown above.

Installation Procedure

1. To prevent short circuits, remove the key from the ignition and disconnect the \ominus terminal of the battery.
2. Make the proper input and output cable connections for each unit.
3. Connect the speaker cables of the wiring harness.
4. Take Connector B on the wiring harness and connect it to the speaker connector in your vehicle.
5. Take Connector A on the wiring harness and connect it to the external power connector on your vehicle.
6. Install the unit in your car.
7. Reconnect the \ominus terminal of the battery.
8. Press the reset button.

CAUTION

- If your car is not prepared for this special connection-system, consult your KENWOOD dealer.
- Only use antenna conversion adapters (ISO-JASO) when the antenna cord has an ISO plug.
- Make sure that all cable connections are securely made by inserting jacks until they lock completely.
- If your vehicle's ignition does not have an ACC position, or if the ignition cable is connected to a power source with constant voltage such as a battery cable, the power will not be linked with the ignition (i.e., it will not turn on and off along with the ignition). If you want to link the unit's power with the ignition, connect the ignition cable to a power source that can be turned on and off with the ignition key.
- If the fuse blows, first make sure that the cables have not caused a short circuit, then replace the old fuse with one with the same rating.
- Do not let unconnected cables or terminals touch metal on the car or anything else conducting electricity. To prevent short circuits do not remove the caps from unused terminals or from the ends of the unconnected cables.
- Connect the speaker cables correctly to the terminals to which they correspond. The unit may receive

damage or fail to work if you share the \ominus cables and/or ground them to any metal part in the car.

- After the unit is installed, check whether the brake lamps, blinkers, wipers, etc. on the car are working properly.
- Insulate unconnected cables with vinyl tape or other similar material.
- During use, the surface temperature of this unit will become high, therefore it should not be mounted where anything sensitive to the heat, such as people or resins, would come into contact with it.
- Do not install the unit under the carpet. Otherwise heat build-up occurs and the unit may be damaged.
- Install this unit in a location which allows heat to easily dissipate. Once installed, do not place any object on top of the unit.
- Install the unit securely in a location that does not interfere with driving.
- Mount the monitor unit so that the mounting angle is 30° or less.

Installation for Monitor Unit

⚠ CAUTION

When mounting the main unit after checking the operation, close the monitor first.

NOTE

Make sure that the unit is installed securely in place. If the unit is unstable, it may malfunction.

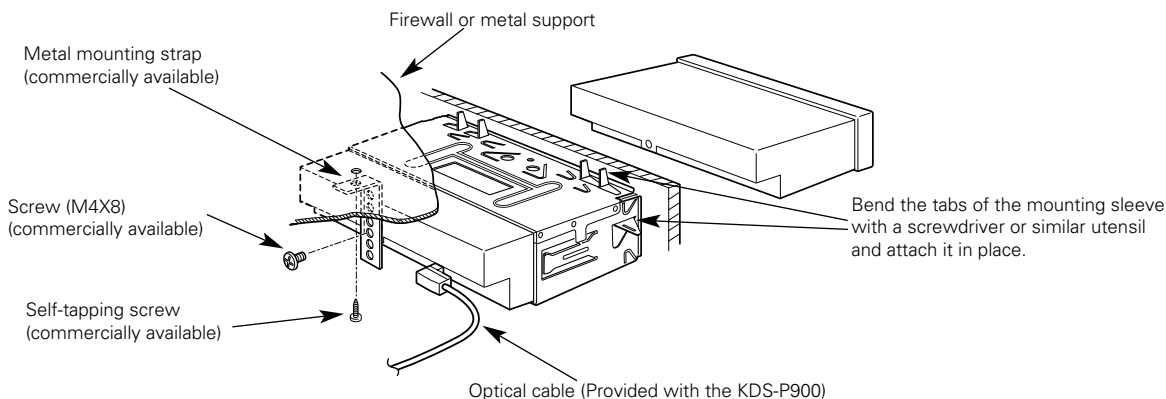

⚠ CAUTION

When handling an optical cable for wiring, use care not to exceed the minimum cable bend radius of 30 mm. If you exceed the minimum bend limit, optical fibers within the optical cable may be damaged. When installing the DVD player unit on the vehicle, ensure that the optical cable is not stuck between the DVD player unit and vehicle parts.

NOTE

- Move the fittings on both sides to suit the installation chassis and select the embedding position from among the 3 positions. (● : Fixing screw)
- When the fittings are set closest to the front (i.e., the embedding position is farthest back), use the hard rubber frame (Accessory ①).

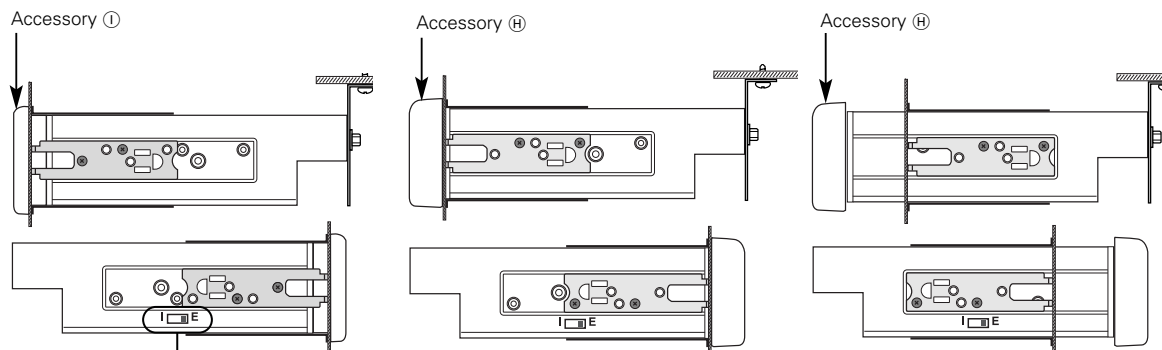

NOTE Language Switch

You can select the language for the TV control.
Position E : English
Position I : Italian

Installation for Receiver unit

■ Securing to audio board

- 1 Attach the installation brackets to the sides of the hideaway unit using the sems bolts (M4 × 8 mm).
- 2 Use the tapping screw (ø4 × 16 mm) to secure the hideaway unit to the audio board.

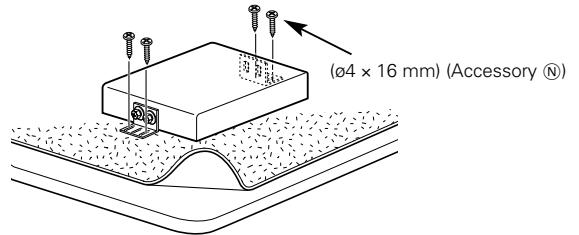
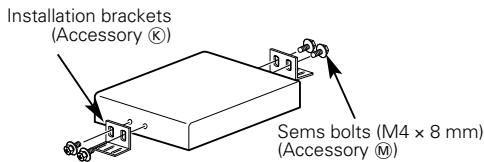

■ Securing to pile carpet

Peel the protective strips off of the velcro strips, attach them to the bottom of the hideaway unit, and secure to the pile carpet.

▲ CAUTION

Please do not install the unit near the dashboard, the rear tray, or other important components. Doing so could lead to injury or accident should the unit come off due to a shock and strike a person or an important component.

Tapping screws should be used for mounting. (Attachment with velcro strips, although easy, can come off with a shock.)

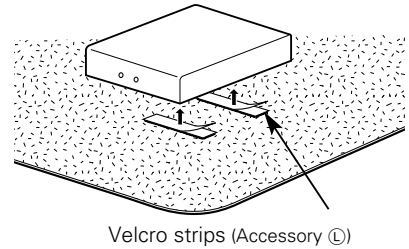

Removing Monitor Unit

■ Removing the Hard Rubber Frame

- 1 Engage the catch pins on the removal tool and remove the two locks on the lower level. Lower the frame and pull it forward as shown in the figure.
- 2 When the lower level is removed, remove the upper two locations.

NOTE

The frame can be removed from the top side in the same manner.

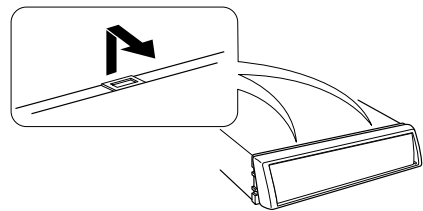
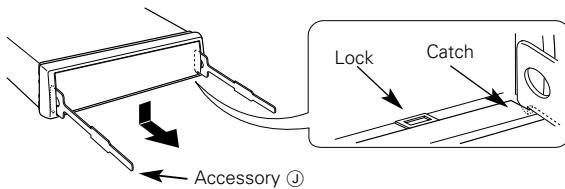

■ Removing the Unit

- 1 Refer to the section "Removing the Hard Rubber Frame" and then remove the hard rubber frame.
- 2 Remove the Hex-head screw with integral washer (M4×6) on the back panel.
- 3 Insert the two removal tools deeply into the slots on each side, as shown.
- 4 Lower the removal tool toward the bottom, and pull out the unit halfway while pressing towards the inside.

▲ CAUTION

Be careful to avoid injury from the catch pins on the removal tool.

- 5 Pull the unit all the way out with your hands, being careful not to drop it.

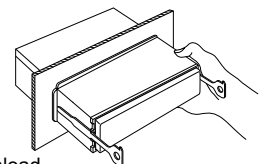
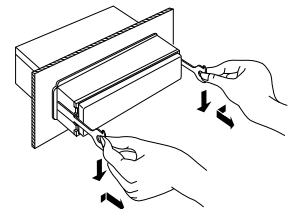
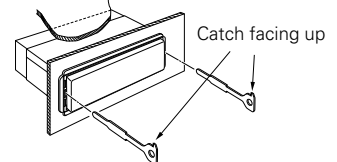

Installing the Antenna Units

- Attach the antenna to the inner glass surface of the rear window using double-sided tape. Carefully check the installation location as the tape can only be stuck on once.
- If the surface temperature of the glass of the rear window is low, warm it by turning on the power of the rear defogger. A cold window glass surface will weaken the adhesive strength of the double-sided tape. Also, if installation inside the cabin is performed on a day with high humidity or when it is raining, the high humidity level will weaken the adhesive strength of the double-sided tape.
- Do not install the antenna in a location where it may obstruct the field of view during driving, such as on the windshield.

- 1 Check the location where the antenna is to be attached. Clean off any grease or dirt from the installation location using the supplied glass cleaner (Accessory ②), clean the area with water and allow to dry.

▲ CAUTION

Clean the glass thoroughly as failure to clean the glass can not only weaken the adhesive strength of the double-sided tape, but may also cause it to come loose.

- 2 Remove the protective strips from the antenna parts and the back of the antenna unit.
- 3 Attach the double-sided tape of the antenna parts and the antenna unit to the rear windshield glass. Attach the double-sided tape by firmly pressing down from the top. Secure cables using the supplied clampers.
- 4 After attaching the antenna with the double-sided tape, allow it to sit undisturbed for 24 hours. Take care not to apply force to the antenna or allow it to get wet during this time.
- 5 Cable the antenna cable to receiver unit.

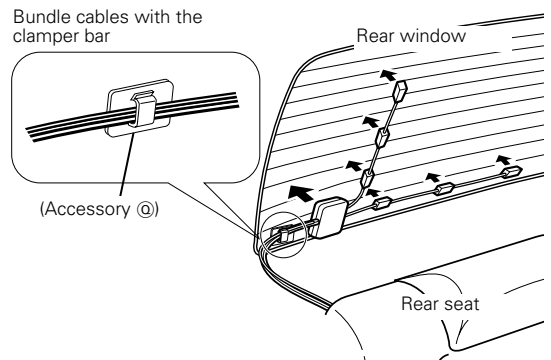
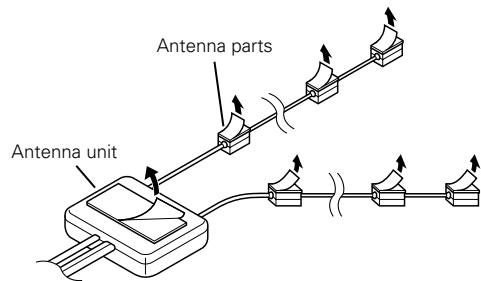

Booster switch

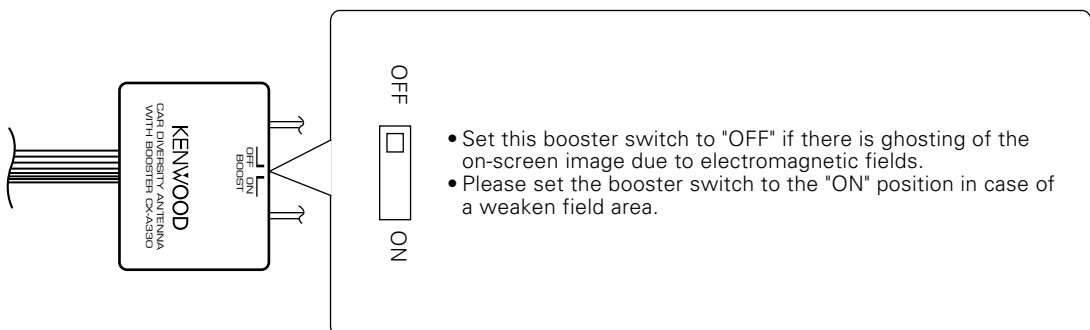

Installation

Connection

⚠ WARNING

If you connect the ignition cable (red) and the battery cable (yellow) to the car chassis (ground), you may cause a short circuit, that in turn may start a fire. Always connect those cables to the power source running through the fuse box.

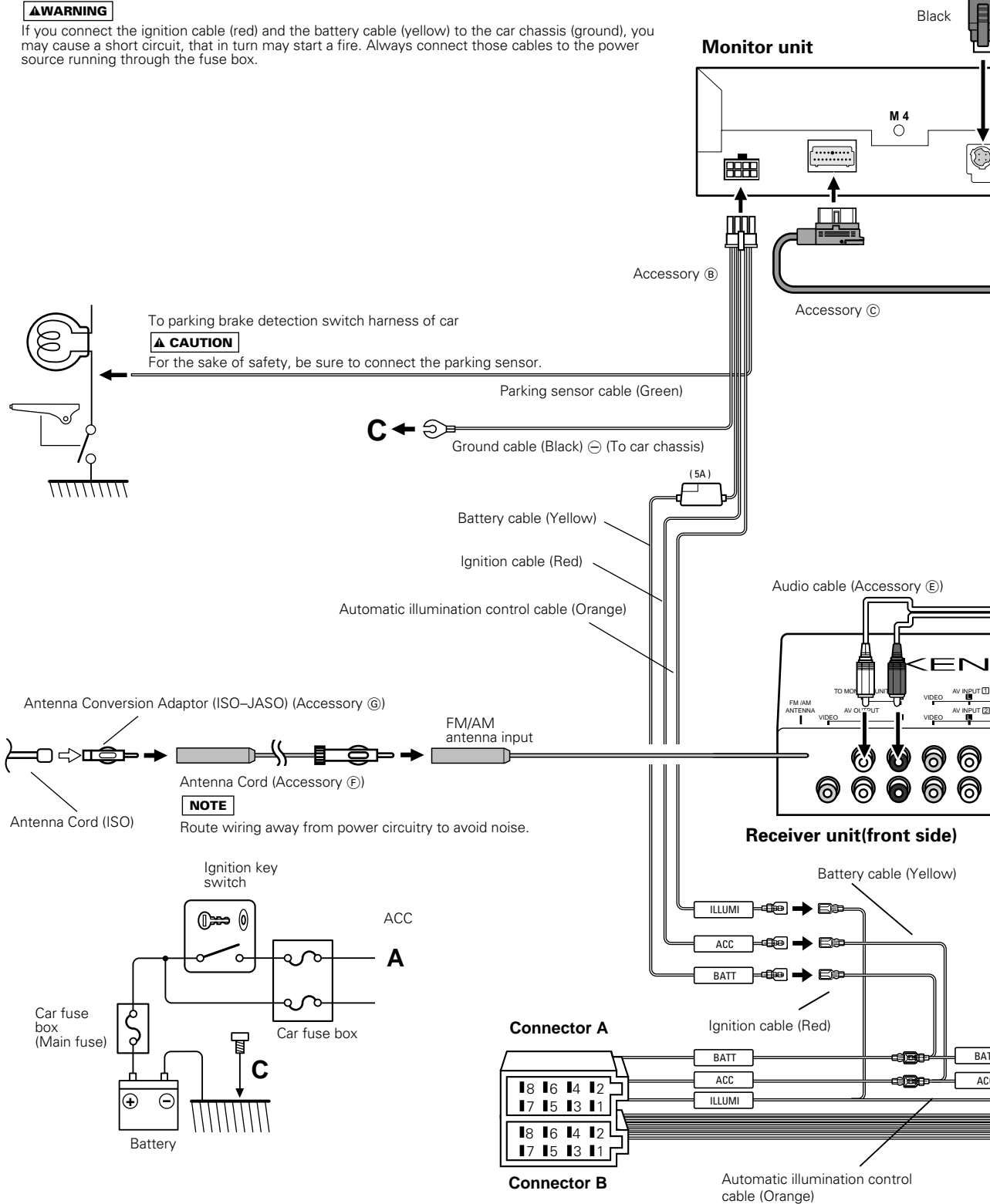

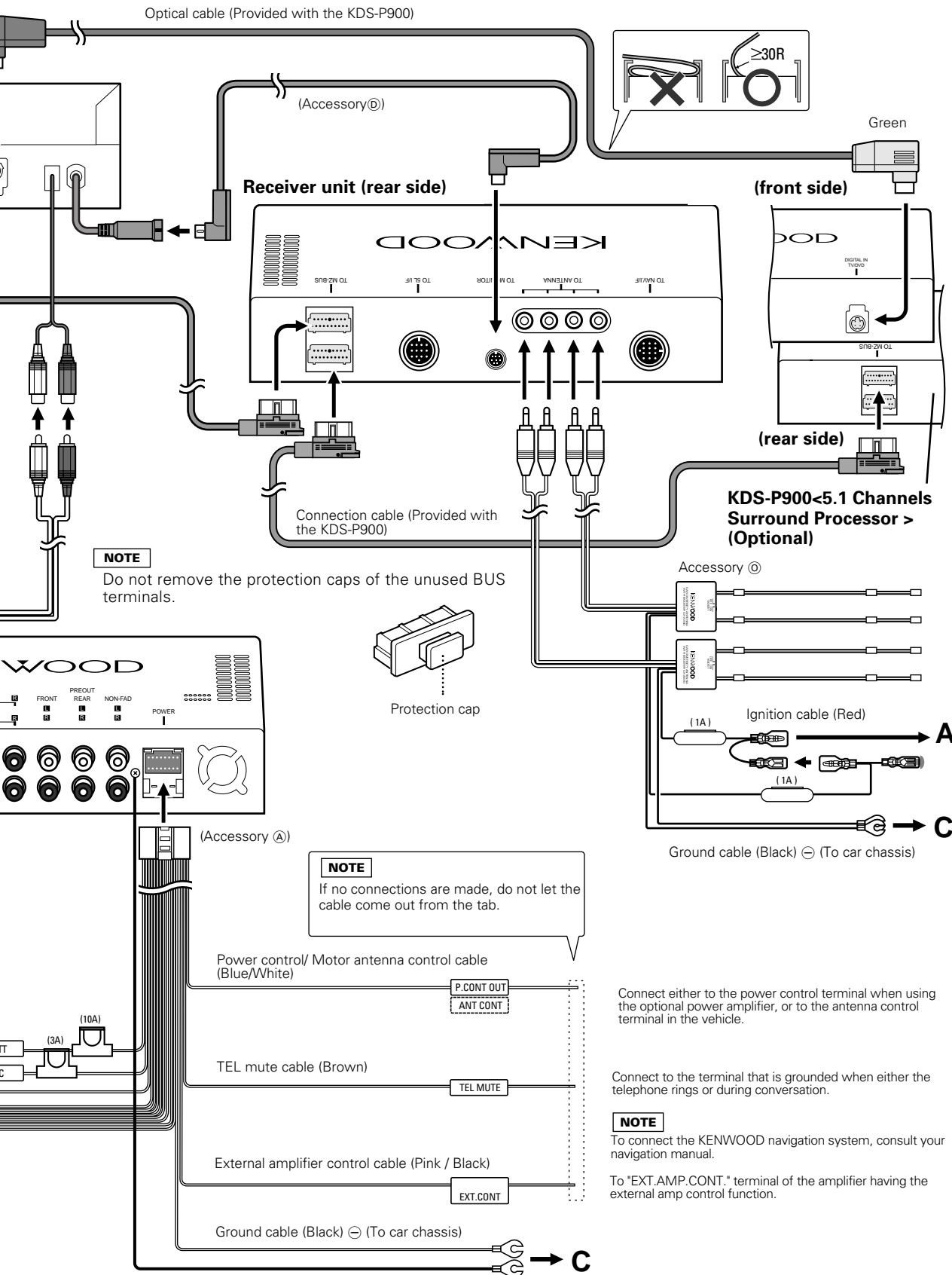

Installation

⚠WARNING Connecting the ISO Connector

The pin arrangement for the ISO connectors depends on the type of vehicle you drive. Make sure to make the proper connections to prevent damage to the unit.

The default connection for the wiring harness is described in **1** below. If the ISO connector pins are set as described in **2** or **3**, make the connection as illustrated.

- 1** (Default setting) The A-7 pin (red) of the vehicle's ISO connector is linked with the ignition, and the A-4 pin (yellow) is connected to the constant power supply.

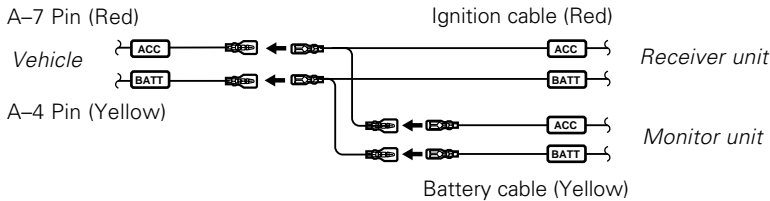

- 2** The A-7 pin (red) of the vehicle's ISO connector is connected to the constant power supply, and the A-4 pin (yellow) is linked to the ignition.

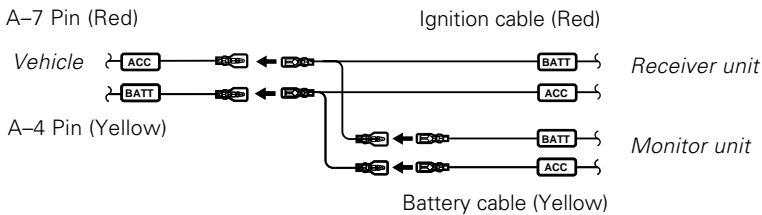

- 3** The A-7 pin (red) of the vehicle's ISO connector is not connected to anything, whilst the A-4 pin (yellow) is connected to the constant power supply (or both the A-7 (red) and A-4 (yellow) pins are connected to the constant power supply).

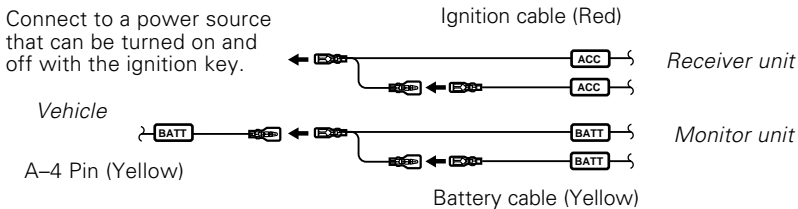

Connector Function Guide

Pin Numbers for ISO Connectors	Cable Colour	Functions
External Power Connector		
A-4	Yellow	Battery
A-5	Blue/White	Power Control
A-6	Orange	Dimmer
A-7	Red	Ignition (ACC)
Speaker Connector		
B-1	Purple	Rear Right (+)
B-2	Purple/Black	Rear Right (-)
B-3	Gray	Front Right (+)
B-4	Gray/Black	Front Right (-)
B-5	White	Front Left (+)
B-6	White/Black	Front Left (-)
B-7	Green	Rear Left (+)
B-8	Green/Black	Rear Left (-)

Connection for AV Equipments

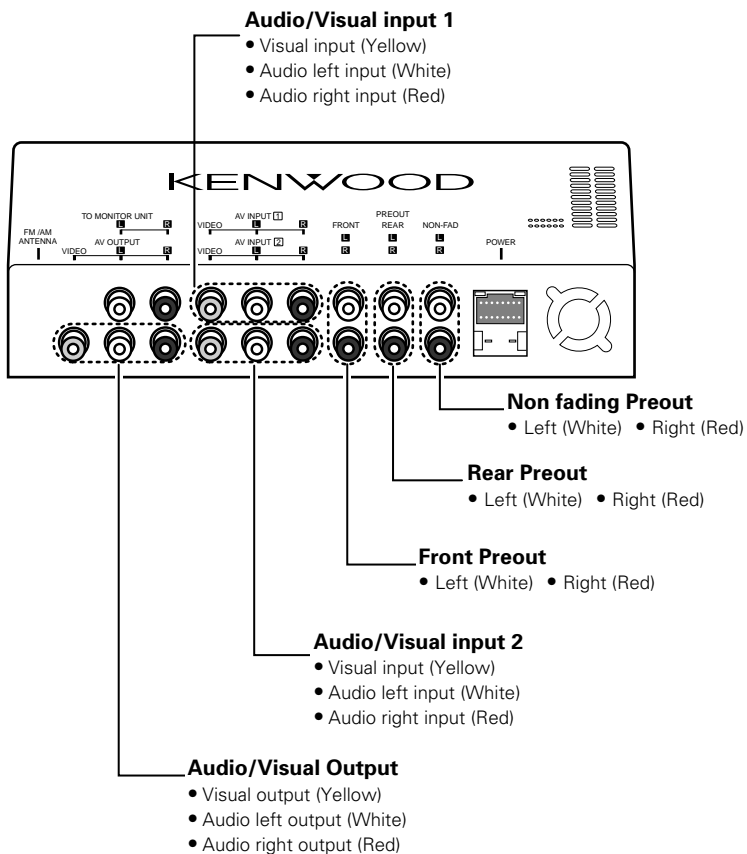

Connection for Disc Changer and Disc Player

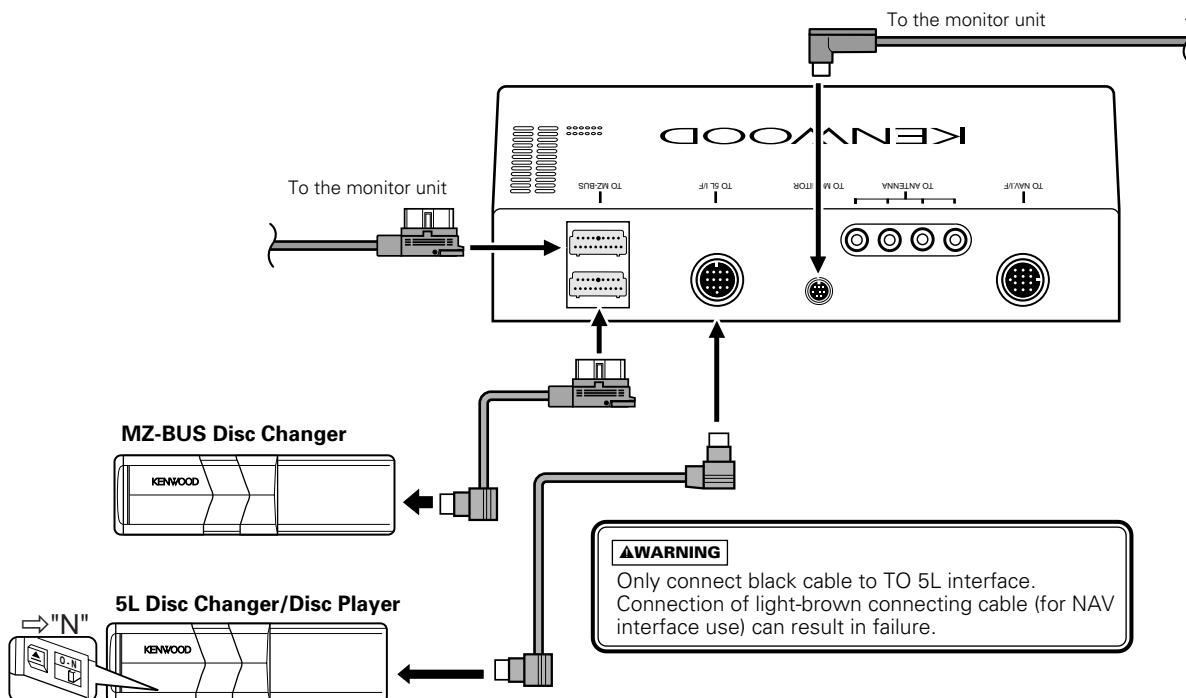

Installation

■ When two CD/MD changers are interconnected

The disk changers are distinguished by source select disk-changer 1 and disk-changer 2.

NOTE

If the relevant connected device has a PROTOCOL SWITCH or O-N SWITCH, be sure to set the switch to "N".

Example 1

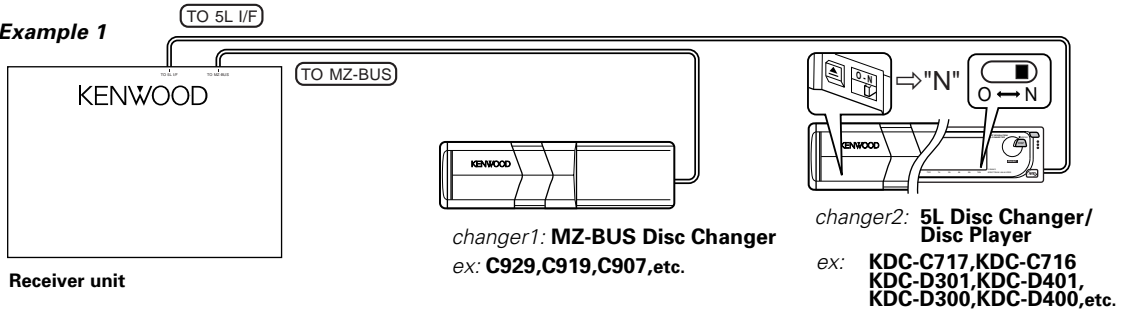

Example 2

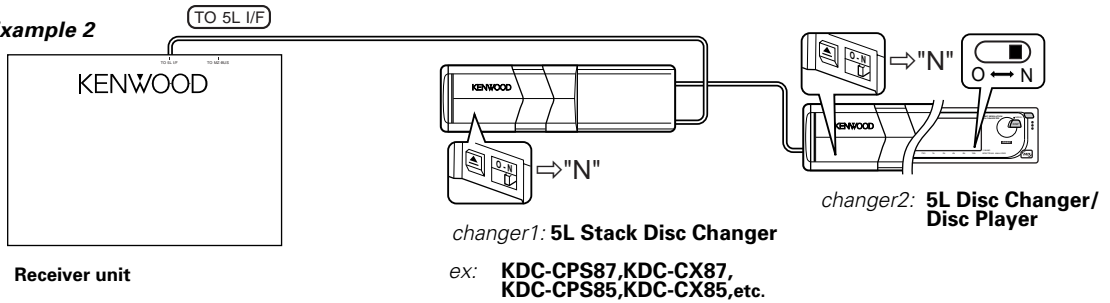

Example 3

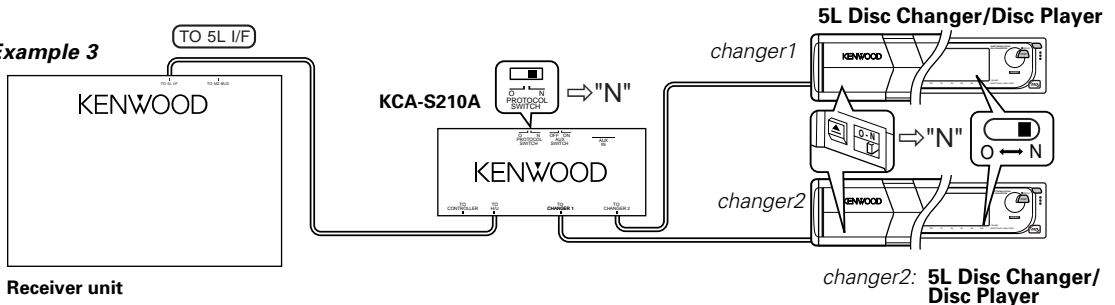

Troubleshooting Guide

What might appear to be a malfunction in your unit may just be the result of slight misoperation or miswiring. Before calling service, first check the following table for possible problems.

PROBLEM	POSSIBLE CAUSE	SOLUTION
The power does not turn on.	The fuse has blown.	After checking for short circuits in the wires, replace the fuse with one having the same rating.
	No ACC position on vehicle ignition.	Connect the same wire to the ignition as the battery wire.
Nothing happens when the buttons are pressed.	The computer chip in the unit is not functioning normally.	Press the reset button on the unit (See page 4).
The monitor does not open/close.	The parking brake is not engaged.	For safety reasons, the monitor does not open while the vehicle is moving. Engaging the parking brake.
No television/video image appears.	The unit is not connected to the parking brake detection switch.	Make proper connections according to "Connections" (See page 60).
	The parking brake is not engaged.	For safety reasons no television/video images are displayed while the vehicle is moving. Engaging the parking brake will cause images to be displayed.
The screen is dark.	The unit is in a location where temperature is low.	If the temperature of the monitor unit drops, the screen may appear darker when power is first turned on due to the characteristics of a liquid crystal panel. Wait a while after turning power on for the temperature to rise. Normal brightness will return.
The screen does not darken when the vehicle's lights are turned on	The unit is set to auto dimmer.	When the unit is set to auto dimmer, it is not linked to the vehicle's light switch.
	The illumination wire has not been connected. (If manual dimmer is set)	Make proper connections according to "Connection" (See page 60).
AM/FM radio reception is poor and/or there is noise.	The TV antenna and vehicle's radio antenna are too close.	<ul style="list-style-type: none"> • Separate the two antennas as far as possible. • Turn off the main unit.
No sound can be heard, or the volume is low.	Attenuator is turned on.	Turn off Attenuator.
	The fader or balance settings are set all the way to one side.	Reconnect the input/output wires or the wiring harness correctly. See the section on "Connecting Wires to Terminals".
	The input/output wires or wiring harness are connected incorrectly.	Reconnect the input/output wires or the wiring harness correctly. See the section on "Connection".
The sound quality is poor or distorted.	One of the speaker wires is being pinched by a screw in the car.	Reset the fader and/or balance settings.
	The speakers are not wired correctly.	Reconnect the speaker wires so that each output terminal is connected to a different speaker.
Radio reception is poor.	The car antenna is not extended.	Pull the antenna out all the way.
	The antenna control wire is not connected.	Connect the wire correctly, referring to the section on "Connection".
The memory is erased when the ignition is turned off.	The battery wire has not been connected to the proper terminal.	Connect the wire correctly, referring to the section on "Connection".
	The ignition and battery wire are incorrectly connected.	Connect the wire correctly, referring to the section on "Connection".

Troubleshooting Guide

PROBLEM	POSSIBLE CAUSE	SOLUTION
The TEL mute function does not work.	The TEL mute wire is not connected properly.	Connect the wire correctly, referring to the section on "Connection".
The TEL mute function turns on even though the TEL mute wire is not connected.	The TEL mute wire is touching a metal part of the car.	Pull the TEL mute wire away from the metal part of the car.
The sound/picture skips on a DVD/VCD/CD.	The disc is scratched or dirty.	Clean the disc, referring to the section on "Cleaning discs" (see p. 5).
A track will not play.	Random play has been selected.	Turn off random play.
Cannot play CD-R or CD-RW	Finalization processing is not being conducted for CD-R/CD-RW.	Conduct finalization processing with CD recorder.
A VCD cannot be played using menus.	The VCD disc being played is not compatible with P.B.C.	Menu playback is available only with VCD discs recorded with P.B.C.
The subtitle is not displayed.	The DVD disc being played does not contain the recording of subtitles.	The subtitle cannot be displayed when the DVD disc being played does not contain the recording of subtitles.
The voice (or subtitle) language cannot be changed.	The DVD disc being played does not contain the recording of more than one audio (or subtitle) language.	The voice (or subtitle) language cannot be changed when the DVD disc being played does not contain the recording of more than one voice (or subtitle) language.
The viewing angle cannot be changed.	The DVD disc being played does not contain the recording of more than one angle.	The viewing angle cannot be changed when the DVD disc being played does not contain the recording of more than one angle.
	You are attempting to switch the angle in a DVD section where more than one angle is not recorded.	More than one viewing angle may be recorded only in limited sections in a disc.
Playback will not start even after a title is selected.	A viewing restriction (RATING) has been set for the disc.	Check the viewing restriction level (RATING) setting.
The voice or subtitle language selected in the initial setting is not played.	The DVD disc being played does not contain the recording of the selected voice or subtitle language.	Use a DVD disc containing the recording of the selected voice or subtitle language.

External disc control mode

PROBLEM	POSSIBLE CAUSE	SOLUTION
The disc control mode cannot be selected.	No cable has been connected to the disc changer input terminal on the unit.	Connect the cable to the disc changer input terminal on the unit.
The specified disc does not play, but another one plays instead.	The specified CD is very dirty.	Clean the CD.
	The CD is upside-down.	Load the CD with the labelled side up.
	The disc is loaded in a different slot from that specified.	Eject the disc magazine and check the number for the specified disc.
	The disc is severely scratched.	Try another disc instead.
The sound skips.	Something is touching the disc changer.	Remove whatever is touching it.
	The CD is scratched or dirty.	If skipping happens at the same place when the car is stopped, something is wrong with the CD. Clean the CD.
The display shows that the changer is being played, but no sound can be heard.	The computer chip in the unit is not functioning normally.	Press the reset button on the unit (see page 4).
The specified track does not play.	Random play or magazine random play has been selected.	Turn off the random play or magazine random play function.
Track repeat, disc repeat, track scan, random play, and magazine random play start by themselves.	The setting is not cancelled.	The settings for these functions remain on until the setting to off or the disc ejected, even if the power is turned off or the source changed.
Cannot play CD-R or CD-RW	Finalization processing is not being conducted for CD-R/CD-RW.	Conduct finalization processing with CD recorder.
	A non-compatible CD changer is being used to play the CD-R/CD-RW.	Use a CD changer compatible with CD-R/CD-RW to play.

The following messages are displayed when certain problems are occurring in your system. Take the recommended actions.

BUS-E50	More than two center units are connected.
BUS-E11	More than two DSP/EQUALIZER units are connected.
Hot Error	The protective circuit in the unit activates when the temperature inside the unit exceeds 60°C (140°F), stopping all operation. ⇒ Cool down the unit by opening the windows or turning on the air conditioner. As the temperature falls below 60°C (140°F), the disc will start playing again.
Mecha Error	The disc player is malfunctioning. ⇒ Eject the disc and try inserting it again. Contact the Kenwood dealer if this indicator continues blinking or the disc cannot be ejected.
Disc Error	The unplayable discs is inserted
Read Error	The disc is upside-down. ⇒ Load the disc with the labeled side up. The disc is quite dirty. ⇒ Clean the disc, referring to the section on "Cleaning discs" (see p. 5).
Region code Error	The DVD software encoded for other region code.
Parental level Error	The parental level is set to high levels.
Error 07 Error 17 Error 27 Error 37 Error 47 Error 57 Error 67	The unit is malfunctioning for some reason. ⇒ Press the reset button on the unit. If the "E- ##" code does not disappear, consult your nearest service center.

Specifications

Specifications subject to change without notice.

Monitor Section

Picture size.....	6.5 inches wide
	142.6(W) x 80.7(H) mm
Display system	Transparent TN LCD panel
Drive system	TFT active matrix system
Number of pixels	336.960 pixels (480 H x 234 V x RGB)
Effective pixels	99.99%
Pixel arrangement	RGB striped arrangement
Back lighting.....	Cold cathode tube

DVD Player Section

D/A conversion	24 Bit
Wow and flutter	Below measurable limit
Total harmonic distortion	0.003 % (1 kHz)
Signal to noise ratio	115 dB (DVD 96 kHz)
Dynamic range.....	95 dB (DVD 96 kHz)
Frequency response	
Sampling frequency; 44.1 kHz (CD)	20 Hz - 20 kHz
Sampling frequency; 48 kHz.....	20 Hz - 22 kHz
Sampling frequency; 96 kHz.....	20 Hz - 44 kHz
Oversampling	
.....	8 fs (Sampling frequency; 44.1, 48 kHz)
.....	4 fs (Sampling frequency; 96 kHz)
Optical out format.....	Dolby Digital/DTS/PCM

FM tuner section

Frequency range (50 kHz space)	
.....	87.5 MHz – 108.0 MHz
Usable sensitivity (S/N = 26dB)	9.3 dBf (0.7 μ V/75 Ω)
Quieting Sensitivity (S/N = 46dB)	
.....	15.2 dBf (1.6 μ V/75 Ω)
Frequency response (\pm 3.0 dB).....	30 Hz – 15 kHz
Signal to Noise ratio (MONO)	70 dB
Selectivity (\pm 400 kHz)	\geq 80 dB
Stereo separation (1 kHz).....	35 dB

MW tuner section

Frequency range (9 kHz space)	531 kHz – 1611 kHz
Usable sensitivity	28 dB μ

LW tuner section

Frequency range	153 kHz – 281 kHz
Usable sensitivity	28 dB μ

TV Tuner Section

Colour system	PAL/SECAM(TV)
	NTSC/PAL(Video)
Channel selection system	
.....	PLL frequency synthesiser system
Television system	
.....	PAL-B/G, PAL-I, SECAM-L, SECAM-D/K, SECAM-B/G
Channel converge	
VHF	
(PAL-B/G).....	2 - 12 ch/A - H ch
(PAL-I)	A - J ch
(SECAM-L).....	2 - 12 ch
(SECAM-D/K).....	1 - 2 ch
(SECAM-B/G).....	2 12 ch
UHF.....	14 - 69 ch
Demodulation system	Split carrier system
Antenna input	4-ch diversity (75 Ω /3.5 ϕ minijack)
External video input level	1 Vp-p/75 Ω
External audio input level	1 V/22 K Ω

Audio section

Maximum output power	45 W x 4
Output power (DIN 45324, +B=14.4 V).....	28 W x 4
Tone action	
Bass:	100 Hz \pm 10 dB
Treble:	10 kHz \pm 10 dB
Preout level / Load	4500mV/10k Ω (disc)
Preout impedance	\leq 600 Ω

General

Operating voltage.....	14.4 V DC (11 to 16 V)
Consumed current.....	10 A
Operational temperature range.....	-10°C to +60°C
Storage temperature range.....	-20°C to +85°C
Size	
(Monitor unit)	180(W) x 50(H) x 185(D) mm
(Receiver unit).....	225(W) x 50(H) x 168(D) mm
Installation size (Monitor unit)	
.....	178(W) x 50(H) x 165(D) mm
Mass	
(Monitor unit)	2.0 kg
(Receiver unit)	1.4 kg

TV Antenna Unit

Output impedance.....	75 Ω /3.5 ϕ miniplug
Operating voltage.....	14.4 V DC (11 to 16 V)
Consumed current	1.0 A
Cable length	5 m
Size.....	50(W) x 14.5(H) x 500(D) mm
Mass	300 g (x2)

Although the effective pixels for the liquid crystal panel is given as 99.99% or more, 0.01% of pixels may not light or may light incorrectly.

Free Manuals Download Website

<http://myh66.com>

<http://usermanuals.us>

<http://www.somanuals.com>

<http://www.4manuals.cc>

<http://www.manual-lib.com>

<http://www.404manual.com>

<http://www.luxmanual.com>

<http://aubethermostatmanual.com>

Golf course search by state

<http://golfingnear.com>

Email search by domain

<http://emailbydomain.com>

Auto manuals search

<http://auto.somanuals.com>

TV manuals search

<http://tv.somanuals.com>