



Assembly Instructions

Kid's Wheelbarrow
Model # 8411-182

Picture Similar



Tools Required:
Outils nécessaires:
Herramientas
necesarias:

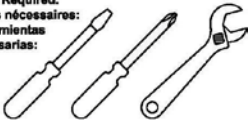

KETTLER® International Inc. · 1355 London Bridge Road · Virginia Beach, VA 23453 USA
www.kettlerusa.com / parts@kettlerusa.com / 866-804-0440

Read these instructions carefully before assembling the product or using it for the first time. They contain important information for your safety and for the correct use and maintenance of this product. Keep the instructions in a safe place for information or for ordering spare parts.

⚠ WARNING –*TO AVOID SERIOUS INJURY* Adult supervision required.
Never use near steps, slopes, driveways, hills, roadways, alleys, or swimming pool areas. Always wear shoes. Never use near motor vehicles. Never allow more than one rider. The use of protective gear and safety helmet is highly recommended. Riders should always wear a properly fitted helmet that complies with Consumer Product Safety Commission (CPSC) Standard 16 CFR 1203. Adult assembly required.

⚠ Caution! Adult Assembly Required. This package contains small parts. Keep away from children until assembled.

This product has been designed in accordance with the latest standards of safety and subjected to constant quality monitoring. The data gained from this quality process is then incorporated in the development of our products. For this reason, we reserve the right to make changes in design and technology in order to offer our customers products of the highest standard of quality at all times.

For your safety

- This toy should be used for its intended purpose only, i.e. one (1) child only. It should not be used in any other way, as this may be dangerous. The manufacturer cannot be held liable for damage or injury caused by incorrect use.
- This product is a toy and is not suitable for use in traffic or on public roads.
- Always keep a watchful eye on your child in order to avoid risks by thoughtless and hasty movements.
- Please care for the fact that this toy is only used on safe ground.
- This product is suitable for children between 3-7 years.
- The wheelbarrow bucket can haul up to 30 lbs. Excessive weight may cause a hazardous or unstable condition.
- The toy is an unlighted play implement. Its use in the dark is dangerous.
- This toy is designed only for private use (no commercial or public use).
- The wheelbarrow must not be connected with other vehicles, sports or similar devices and not be driven/pulled by them.
- Damaged components may endanger the safety of your child or shorten the lifespan of the product. Inspect it at regular intervals to ensure that none of the components are damaged and that none of the bolts or other joints have worked loose.

- Replace worn or damaged parts immediately and ensure that the product is not used again until this has been done. If any parts require replacement, use only original spares manufactured by KETTLER®.

Use of the Toy

- Ensure that the toy is not used until it has been properly assembled and checked by an adult person.
- Instruct your child how to use the wheelbarrow correctly and draw attention to possible sources of danger.
- Although dangerous situations are unlikely to occur if the wheelbarrow is used correctly, children at play should, if possible, be supervised.
- When children are at play, situations may arise which cannot be predicted by the manufacturer and for which he cannot be held responsible.
- Keep this unit clean and dry. Wipe off dirt, moisture, and oil with a clean soft cloth. Never use corrosive or abrasive substances to clean the toy. Never use substances which may cause pollution of the environment.

Assembly of the wheelbarrow

- Please ensure that the wheelbarrow will only be used for playing when assembly has been carried out correctly, and checked, by an adult.
- The toy must be assembled carefully by an adult person. Study the assembly instructions carefully before beginning work. This is essential for the safe function and use of the wheelbarrow.
- Please note that there is always a danger of injury when working with tools or doing manual work. Therefore please be careful when assembling this product.
- Ensure that your working area is free of possible sources of danger, for example don't leave any tools lying around. Always dispose packaging material in such a way that it may not cause any danger. There is always a risk of suffocation if children play with plastic bags!
- Bolt all the parts together loosely at first, and check that they have been assembled correctly. Tighten the locknuts by hand until resistance is felt, then use wrench to finally tighten nuts completely against resistance (locking device). Then check that all screw connections have been tightened firmly. Attention: once locknuts have been unscrewed they no longer function correctly (the locking device is destroyed), and must be replaced.
- Please keep original packaging of this article, so that it may be used for transport at a later date, if necessary.
- For technical reasons, we reserve the right to carry out preliminary assembly work (e.g. addition of tubing plugs).

List of spare parts page 7

When ordering spare parts, always state the full article number, spare-part number, and the quantity required.

Example order: Model # 8427-182/ spare-part no. 8427-182#01 / 1 piece

Please keep original packaging of this article, so that it may be used for transport at a later date, if necessary. Goods may **only** be returned after prior arrangement and in (internal) packaging, which is safe for transportation, in the original box if possible.

It is important to provide a detailed defect description / damage report! **Important:** spare part prices do not include fastening material; if fastening material (bolts, nuts, washers etc.) is required, this should be clearly stated on the order by adding the words **“with fastening material”**.

Waste Disposal

KETTLER products are recyclable. At the end of its useful life please dispose of this article correctly and safely (local refuse sites).

KETTLER International Inc. · 1355 London Bridge Road · VA 23453 USA
www.kettlerusa.com

 **LIMITED WARRANTY**











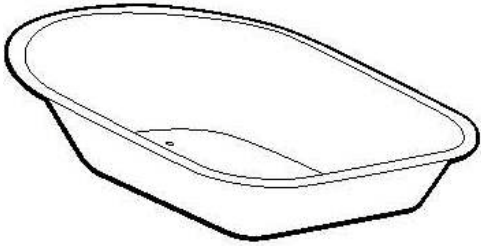

THERE ARE NO WARRANTIES, EXPRESSED OR IMPLIED, MADE BY EITHER THE DISTRIBUTOR OR THE MANUFACTURER ON KETTLER® PRODUCTS, EXCEPT THE MANUFACTURER’S LIMITED WARRANTY AGAINST DEFECTS IN MATERIAL SET OUT BELOW:

This KETTLER® Limited Warranty applies to products sold through the KETTLER® Authorized Dealer Network to the original retail purchaser and authenticated by proof of purchase from a retailer located in the United States. Any shipments made under this warranty will be shipped to the United States only. Any shipment outside of the United States will be at the sole cost of the customer. This KETTLER® Limited Warranty is a manufacturer’s warranty and is not changed or modified by additional warranties extended by individual retailers at the point of sale. Manufacturer warrants this product to be free from defects in material at the time of the product’s tender of delivery for a period of 1 year for residential use. This Limited Warranty is not transferable and does not cover normal wear and tear (including, but not limited to, damage and wear to tires, power shocks, drive belts and other non-durable parts). The liability of the manufacturer under this Limited Warranty shall not include any liability for direct, indirect, or consequential damages resulting from the defect. This Limited Warranty is void if the product is damaged by accident, unreasonable use, improper service, failure to follow instructions provided, modification from its original state, or other causes determined not arising out of defects in material.

This warranty gives you specific legal rights. Should this product become defective due to material within the warranty period, contact KETTLER® Parts & Service Dept. by phone at 866.804.0440, fax at 757.563.9273, or e-mail at parts@kettlerusa.com.

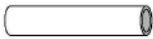
THIS LIMITED WARRANTY IS EXPRESSLY IN LIEU OF ANY OTHER WARRANTIES, EXPRESSED OR IMPLIED, INCLUDING ANY IMPLIED WARRANTY OF MERCHANTABILITY OR FITNESS FOR A PARTICULAR PURPOSE, AND OF ANY OTHER OBLIGATIONS OR LIABILITY ON THE PART OF THE MANUFACTURER. KETTLER® NEITHER ASSUMES NOR AUTHORIZES ANY OTHER PERSON TO ASSUME FOR IT ANY OTHER LIABILITY IN CONNECTION WITH SUCH PRODUCTS.

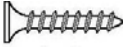
PARTS & HARDWARE LIST

	1		1
Steel Tub		Wheel	
	2		2
Upper Handle Arm		M6X40	
	2		2
Lower Handle Arm		M6X42	
	2		1
Support Bracket		M8X90	
	1		2
Front Wheel Sleeve		M6x10	
			4
		4x20 Screws	
			6
		M6 Hex Nut	
			1
		M8 Hex Nut	

ASSEMBLY

Step 1

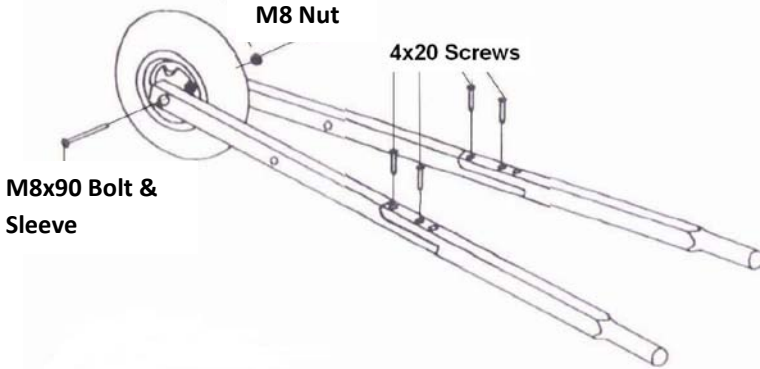

Step 2

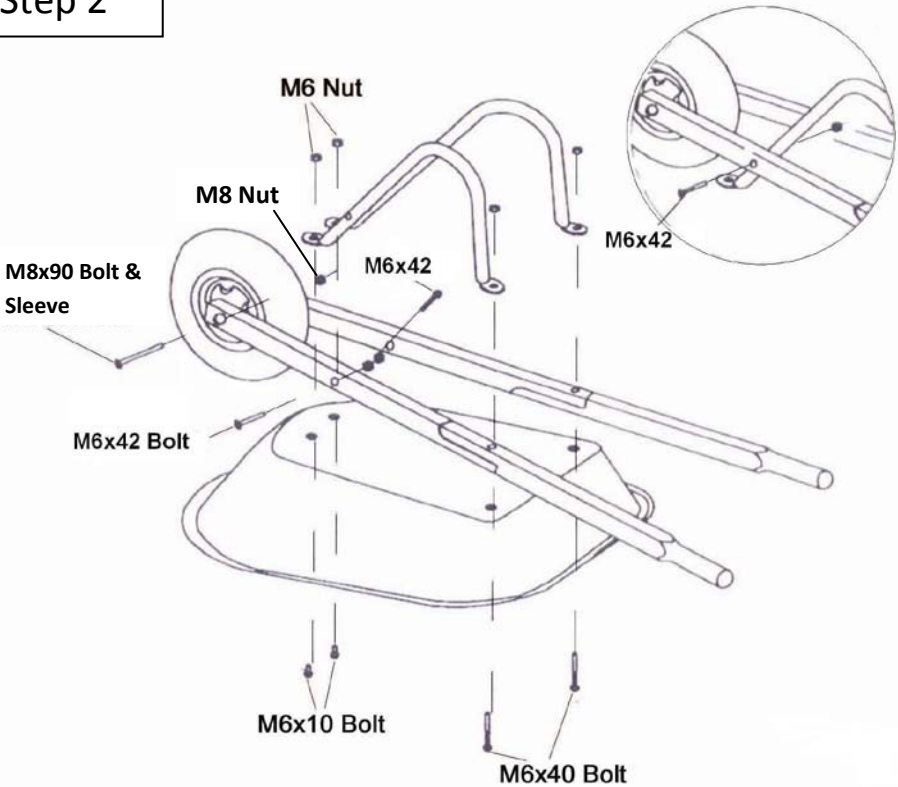

Spare Parts Drawing and List for 8411-182 Classic Flyer by Kettler Wheelbarrow

Pos.	Description	QTY	Part #
1	Bucket,Red	1	8410-182#01
2	Wheel	1	2385.02.04
3	Leg	2	8410-182#03
4	Handle	2	8410-182#04
5	Arm	2	8410-182#05
6	Hardware Bag (not illustrated)	1	HDWRBAG8410-182

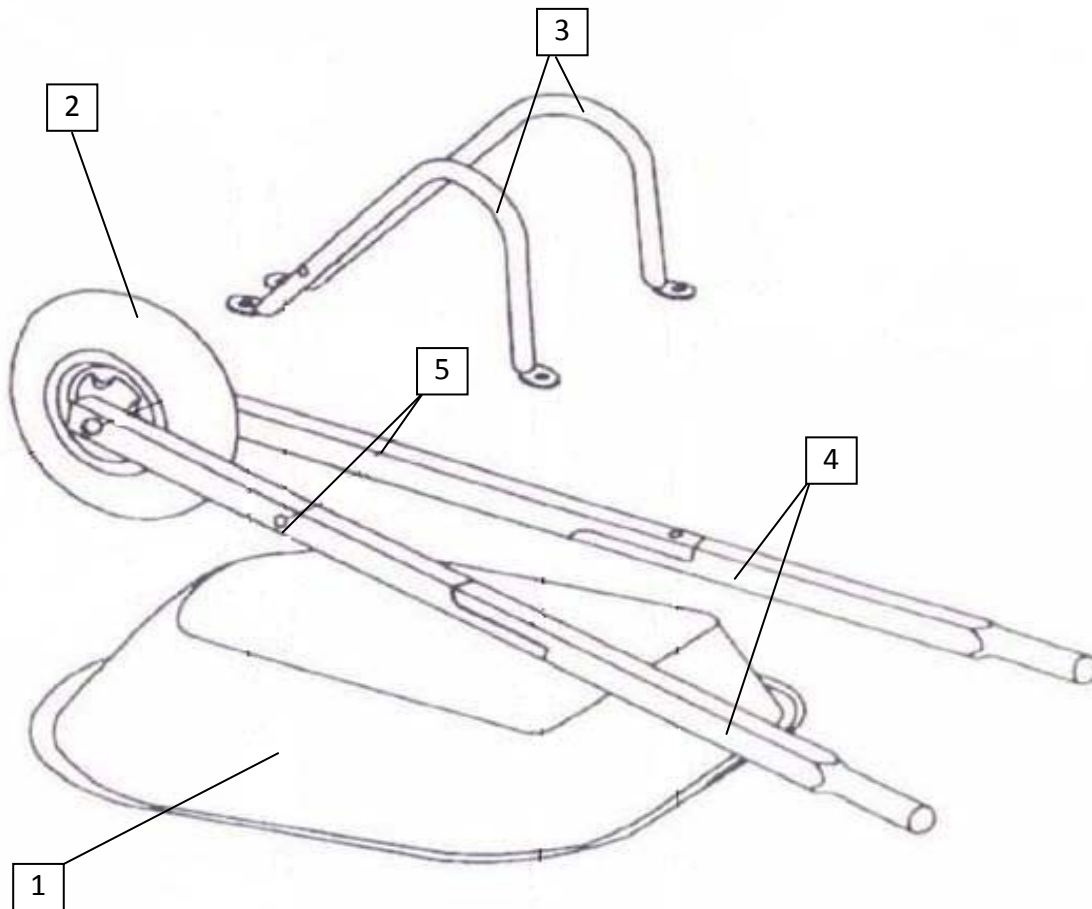

©2010 KETTLER®. All rights reserved. No part of this manual may be reproduced, stored in a retrieval system, or transmitted in any form, or by any means, such as electronic, mechanical, photocopying or otherwise, without the prior written permission of KETTLER®.

docu 05/26/10

Free Manuals Download Website

<http://myh66.com>

<http://usermanuals.us>

<http://www.somanuals.com>

<http://www.4manuals.cc>

<http://www.manual-lib.com>

<http://www.404manual.com>

<http://www.luxmanual.com>

<http://aubethermostatmanual.com>

Golf course search by state

<http://golfingnear.com>

Email search by domain

<http://emailbydomain.com>

Auto manuals search

<http://auto.somanuals.com>

TV manuals search

<http://tv.somanuals.com>