

# KETTLER®

## Match 5.0 Table Tennis Table Models 7136-000-500 & 7176-000-090-500

Adult Assembly Required

Made in Germany



Picture Similar

Printed on recycled paper.

KETTLER® International Inc. • 1355 London Bridge Road • Virginia Beach, VA 23453 USA

[www.kettlerusa.com](http://www.kettlerusa.com)

[info@kettlerusa.com](mailto:info@kettlerusa.com)

Please do not return this product to the store. Contact KETTLER® for parts and service: call toll free 866.804.0440 or send email to [parts@kettlerusa.com](mailto:parts@kettlerusa.com). Please visit our web site [www.kettlerusa.com](http://www.kettlerusa.com) to view a video demonstration of product assembly.

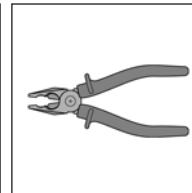

## Before Assembly

Before assembling or using the table tennis table, please read the following instructions carefully. They contain important information for use and maintenance of the equipment as well as for your personal safety. Keep these instructions in a safe place for maintenance purposes or for ordering spare parts.

All KETTLER® products are designed in accordance with the latest safety regulations and undergo a constant process of quality control during manufacturing. The knowledge gained in this process is used to constantly improve and develop our products. In order to offer our customers the very best in product quality, we reserve the right to make technical changes at any time. In spite of this, should you have any cause for complaint, please contact KETTLER®.

### **Note on Safety**

- The table tennis table should be used only for its intended purpose, i.e. for playing with suitable table tennis racquets and balls.
- All other uses are prohibited and may be dangerous. The manufacturer cannot be held liable for damage or injury caused by improper use of the table.
- Damaged or worn components may endanger your safety or shorten the lifespan of the table tennis table. Replace worn or damaged components immediately and remove the table from use until this has been done. Use only spare parts manufactured by KETTLER®.
- The table tennis table complies with all safety regulations. Incorrect repairs, alterations to the design (removal of original parts, addition of other components etc.) may endanger the safety of the user.
- Instruct other persons (in particular children) using the table in its correct use, and draw their attention to any potential source of danger, especially when setting up or dismantling the table.
- Caution: During assembly, keep all items out of children's reach (choking hazard - contains small parts).
- When setting up or dismantling the table, stay clear of its folding radius.
- When folded up, the table tennis table presents a large surface to the wind. For this reason, ensure that it is stored in a sheltered position.
- The table tennis table may be pushed only in the transport position otherwise there is a risk of injury.
- The unit complies with the standard EN 4468-1:2004.
- Regularly check all screws, bolts etc. to ensure they are in good condition.
- Warning: Children should not attempt to fold/unfold table. May result in injury

### **Handling the Equipment**

- Do not use the table tennis table until it has been fully and correctly assembled and checked.
- Ensure that indoor table tennis tables are not exposed to dampness or rain. Keep them well away from direct sources of heat. Should the surface become warped, lay the table on a level surface for a few days.
- Set the table up on a level surface.
- Do not cover it with a tarp, which can result in condensation forming. We recommend the weatherproof KETTLER® cover, part number 7032-400. Cover should only be used when table is in folded position.
- For practicing without a partner, the table halves can be folded up individually.
- Do not use corrosive or abrasive materials to clean the equipment. Ensure that such materials are not allowed to pollute the environment. In most cases, a slightly dampened cloth is sufficient.
- Waste Disposal: KETTLER® products are recyclable. At the end of its useful life, please dispose of correctly and safely complying with your local facilities and guidelines.
- Store table in folded position when not in use.

## Before Assembly (continued)

### General Assembly Instructions

- The equipment must be assembled with care by two adults.
- Separate all the parts including the hardware. Compare quantities with the package contents section and that all items are undamaged. If there are any problems, please contact KETTLER®.
- Before assembling the equipment, study the drawings and photos carefully then assemble in the order shown.
- Please note that there is always a danger of injury when working with tools or doing manual work. Therefore, please be careful during assembly.
- Ensure that your working area is free of possible sources of danger, for example don't leave any tools lying around. Always dispose of packaging material in such a way that it may not cause any danger. There is always a risk of suffocation if children play with plastic bags!
- The fastening items required for each assembly step are shown at the beginning of the step. Use the fastening items exactly as instructed.
- Bolt all the parts together loosely at first, and check that they have been assembled correctly. Then use spanner for final tightening. Then check that all screw connections have been tightened firmly.
- For technical reasons, we reserve the right to carry out preliminary assembly work (e.g. addition of tubing plugs).
- Please keep original packaging, so that it may be used for transport at a later date, if necessary. Goods may only be returned after prior arrangement and in packaging that is safe for transportation ( in the original box if possible). It is important to provide a detailed defect description/damage report.

## Package Contents

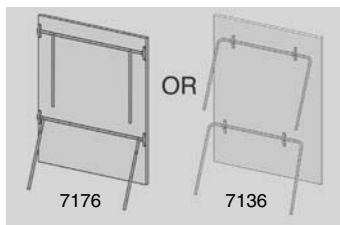

Number Included - 2

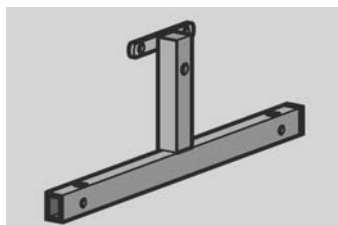

Number Included - 2



Number Incl - 4 non locking



Number Incl - 4 locking

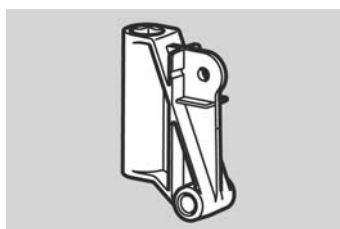

Number Included - 2



Number Included - 2

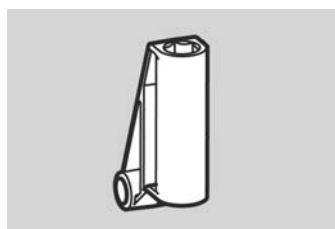

Number Included - 2



Number Included - 2

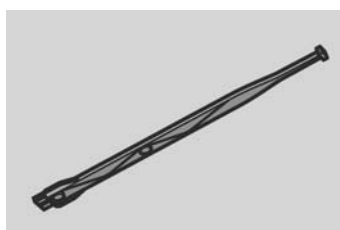

Number Included - 2

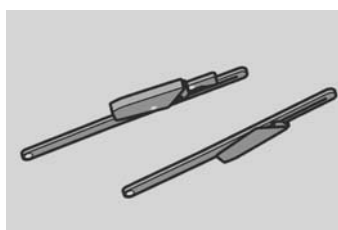

Number Included - 2 pairs

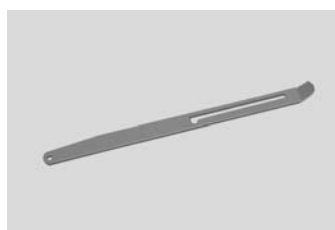

Number Included - 2

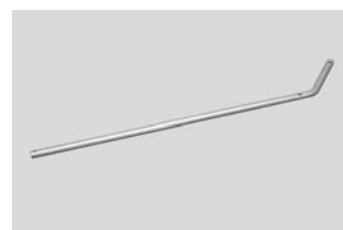

Number Included - 4

# Package Contents (continued)

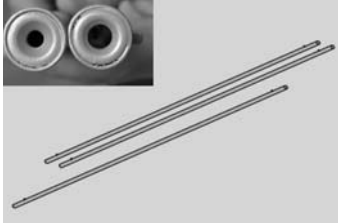

Number Incl. - 1-6mm, 2-8mm

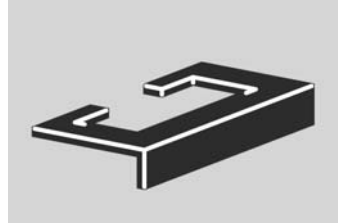

Number Incl. - 2 (outdoor only)



Number Included - 2



Number Included - 2



Number Included - 1

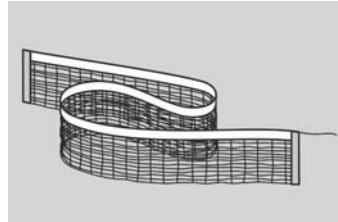

Number Included - 1

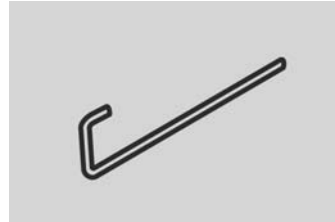

Number Included - 2



Number Included - 2

Items below are shown at actual size



Number Included - 4  
m8x125



Number Included - 4  
m8x110

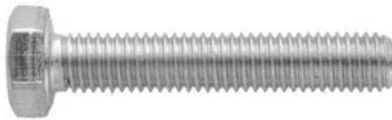

Number Included - 4  
m8x45



Number Included - 2  
4.8x25



Number Included - 4  
m6x60



Number Included - 6  
3.9x25



Number Included - 4  
m6x50



Number Included - 8  
3.9x13



Number Included - 4  
m6x49



Number Included - 2



Number Included - 2  
m6x37



Number Included - 26  
dia 12x6



Number Included - 28  
dia 16x8



Number Included - 2  
m6x30



Number Included - 4  
m6x25



Number Included - 4  
dia 25x8



Number Included - 4  
dia 30x8

## Package Contents (continued)

Items below are shown at actual size

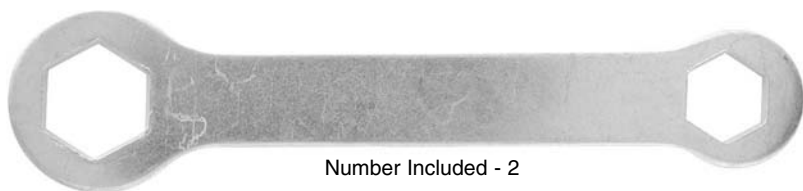

Number Included - 2



Number Included - 18  
m6



Number Included - 8  
m8



Number Included - 4



Number Included - 8  
m12x6x3



Number Included - 8



Number Included - 4  
m26x19x6



Number Included - 2  
m16x8x3



Number Included - 2



Number Included - 4  
m12x6x15



Number Included - 8



Number Included - 2



Number Included - 4



Number Included - 4



Number Included - 2

# Assembly

Begin the assembly of your table by carefully removing the plastic wrap and all of the loose contents. Separate the two table tops by removing the four plastic corner protectors and the plastic side strips.

## Step 1



2 Required

Align footlock with stemtube.

Insert drift pin. There are two footlocks and stemtubes. Assemble both as shown.



# Assembly

## Step 2

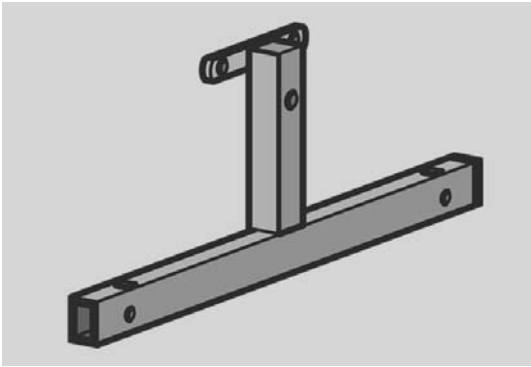

Paying attention to position of wheelbase, assemble the stemtubes to base in order shown.

Insert endcaps.

Assemble two wheelbase assemblies.



4 Required



End view and perspective view  
8 Required



4 Required



4 Required  
dia 25x8



4 Required  
m8x125



8 Required  
dia 16x8



4 Required  
m8

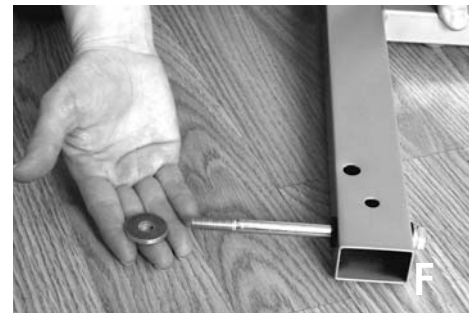
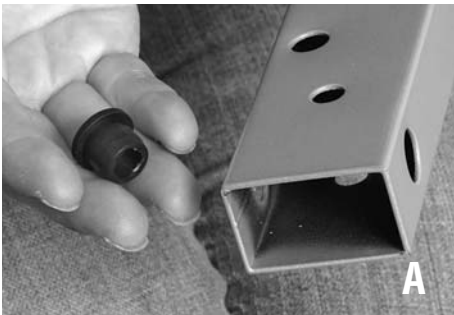

## Assembly

### Step 2 (continued)

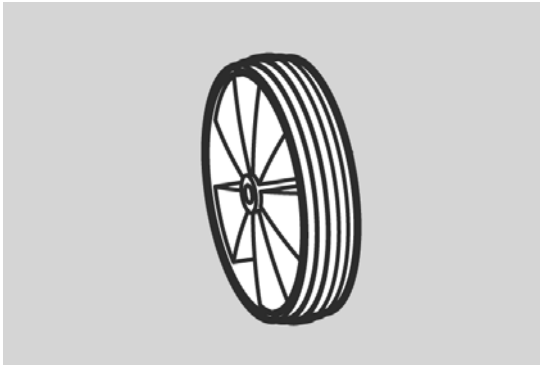

Photo K shows the non locking stemtube being installed. Step E to step J are the same for the locking and non locking stemtube.



# Assembly

## Step 3



Install non-locking wheels.

Do not over torque; wheels should roll smoothly.

Install non-locking wheels on both wheelbase assemblies.



8 Required  
dia 16x8



2 Required  
8m



2 Required  
m8x110

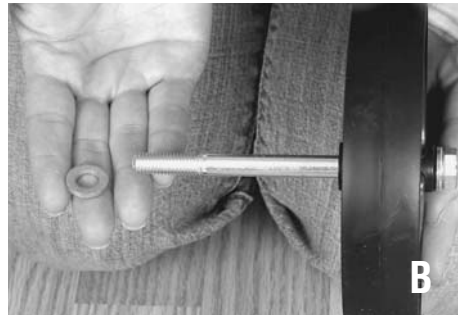

# Assembly

## Step 4

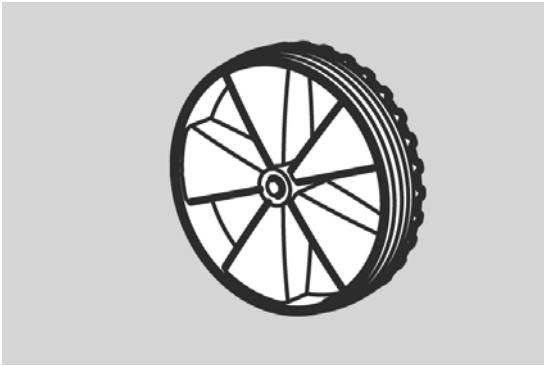

Install locking wheels.

The grooves of wheels should face inward.

Again, do not over torque; wheels should roll smoothly.

Push down foot lock to lock the wheels. Install non-locking wheels on both wheelbase assemblies.



8 Required  
dia 16x8



2 Required  
m8



2 Required  
m8x110



A



B



C



D



E

# Assembly

## Step 5

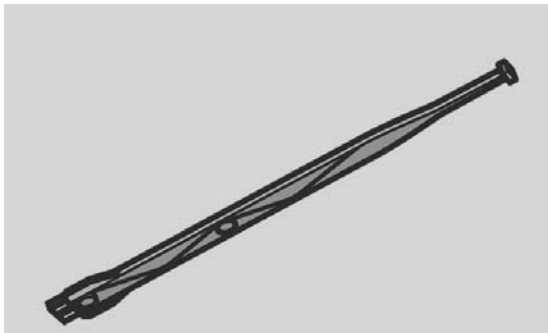

Paying attention to position of wheelbase, snap alignment struts into place.

Bolt locking struts to base. Bolt the locking strut with thumb latch to the same side as locking wheels. Bolt strut without latch to the side of non-locking wheels.

Assemble two identical wheelbase assemblies with wheels and struts.



4 Required  
m6x25



4 Required  
dia 12x6



4 Required  
m6

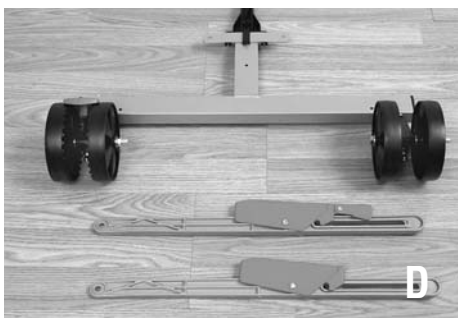

# Assembly

## Step 6

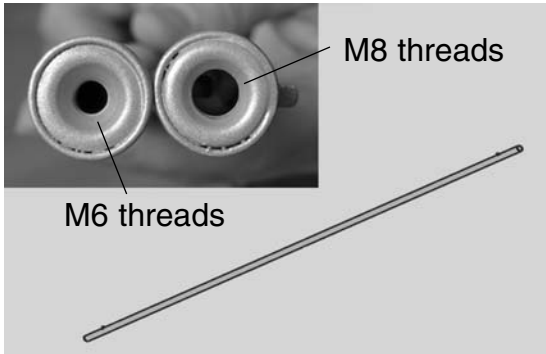

2 Required  
m8x45

Bolt one M8 crossbar between each wheelbase. This crossbar is being assembled temporarily to create a support base and will be removed at a later step.

For outdoor tables only: slide the shimpad onto wheelbase (steps B, C, and D).

The assembly thus far should match photo E.

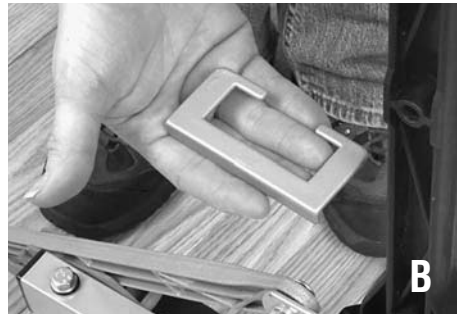

# Assembly

## Step 7

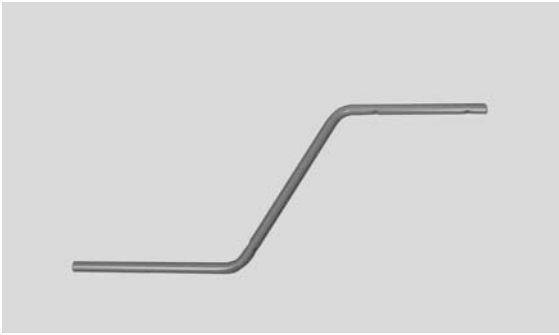

Insert endcap into the bottom of netpost bar.

Using M6 crossbar, assemble crossbar and netpost bars to alignment struts.

The netpost bar installation is repeated on the other wheelbase assembly. Fastener quantities include installation on both wheelbase assemblies.

The assembly thus far should match photo G.



2 Required



4 Required  
m6x50



6 Required  
dia 12x6



2 Required  
m6



# Assembly

## Step 8

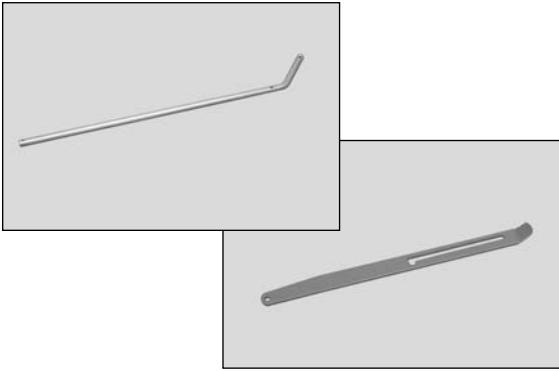

Screw eyelets to four Jbars.

Assemble safety levers to two of the Jbars.

Slide handgrip onto safety lever.

Note the orientation of the slot in the safety lever and the Jbar as shown in photo E.



4 Required



4 Required  
dia 12x6



2 Required  
m6



2 Required  
m6x30



4 Required  
3.9x13



2 Required



A



B



C

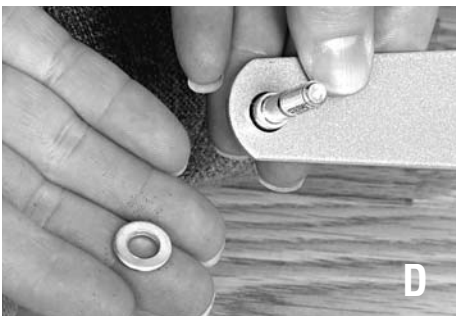

D

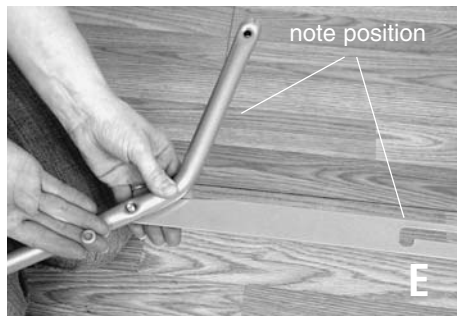

E



F



G

# Assembly

## Step 9

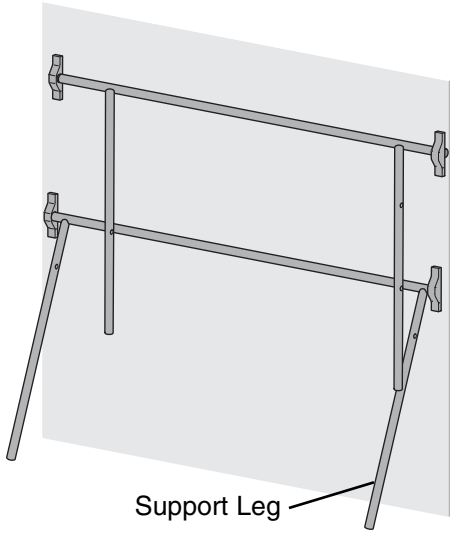

Screw eyelets to support leg on table-top half.  
Repeat for second table-top half.



# Assembly

## Step 10

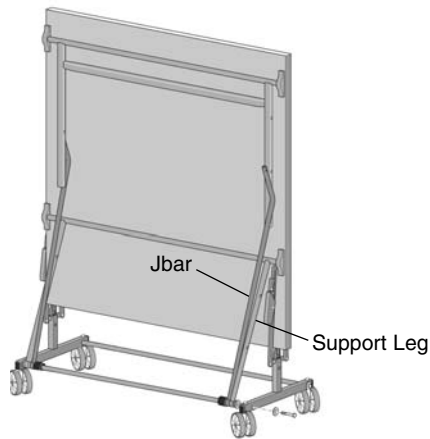

Important: have two people complete steps 10-12. With assistance, lift one table top onto the wheelbase; the legs will be facing outward. Have one person support the top while it is resting on the base while the other completes assembly.

Assemble crossbar to Jbars and support leg in the order shown. Note: a Jbar with safety lever should be assembled on the right side (side with non locking wheels) and a Jbar without lever on the left side (side with locking wheels). The support leg is always assembled closest to the wheelbase. You may need to lower table slightly to line up the bolt holes. Do not fully tighten the bolts until both ends are assembled.



2 Required  
m8x45



2 Required  
dia 16x8



2 Required  
m26x19x6



2 Required  
dia 30x8

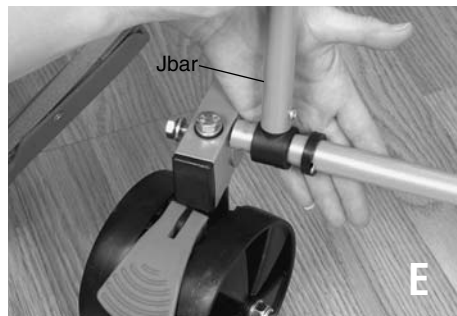
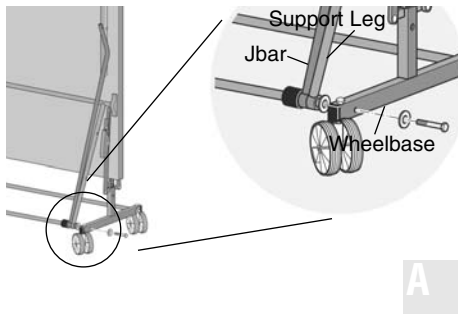



# Assembly

## Step 11

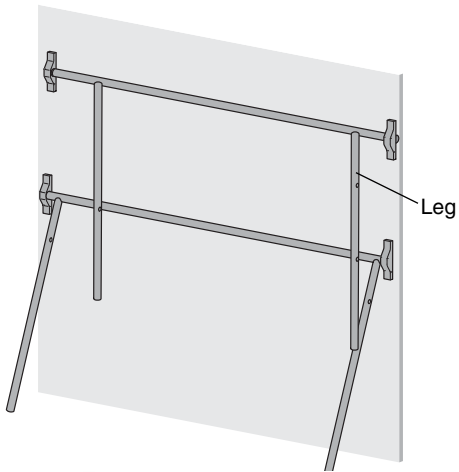

1 Required  
m6x37

Raise safety lever up straight. Bolt the safety lever to leg.  
Bolt the Jbars to leg.  
Insert footcaps.



2 Required  
m6x60



4 Required  
m 12x6x3



End view and side view shown - 2 Required  
m12x6x15



2 Required  
dia 12x6



3 Required  
m6



1 Required  
m 16x8x3



2 Required

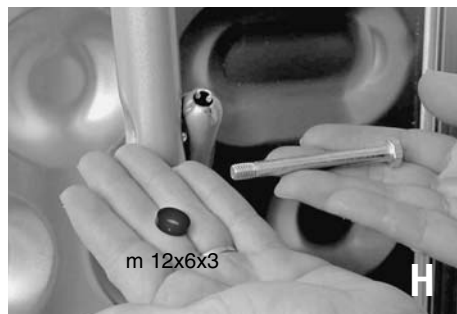
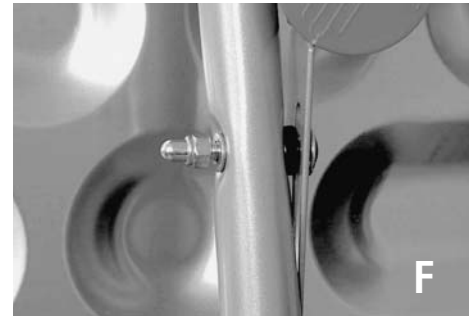
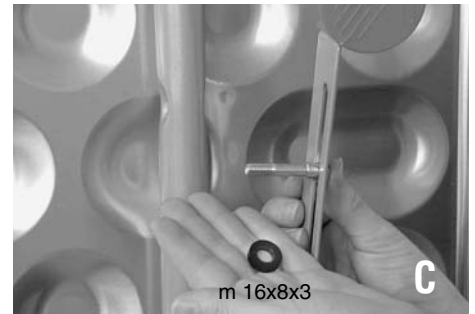
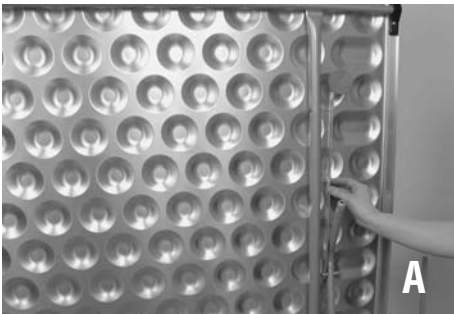

# Assembly

## Step 11 continued

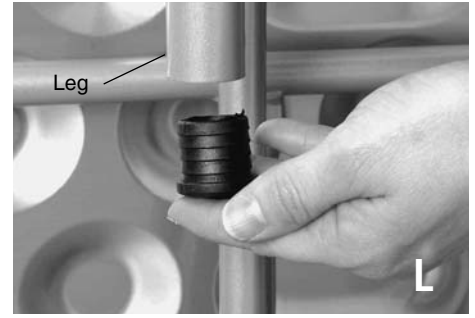
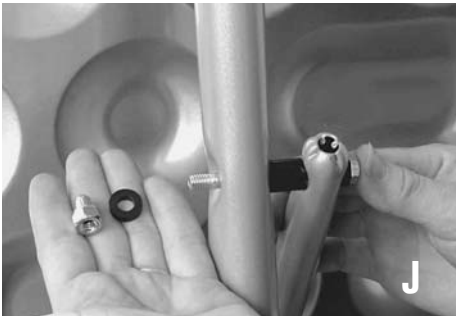

## Step 12



Bolt locking struts to support leg.



2 Required  
m6x49



4 Required  
m12x6



2 Required  
m6

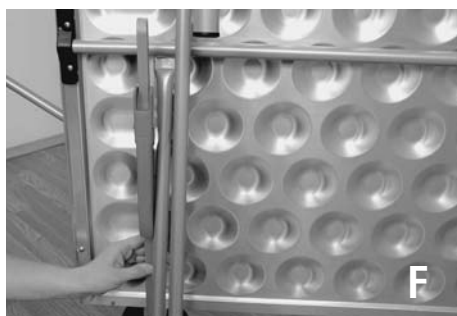
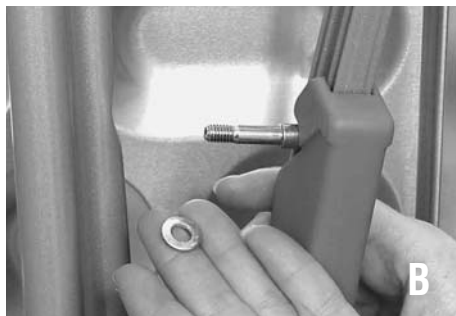

Now, remove the temporary crossbar assembled in step 6. Carry out steps 10-12 again for the other side.

## Assembly

### Open Table Top to Complete Assembly

To properly open table into playing position: lock wheels (H), push the thumb latch down on the left locking strut. Squeeze the strut on the right side and lower table into playing position. Support the table as you lower it; never allow it to drop down.



# Assembly

## Step 13

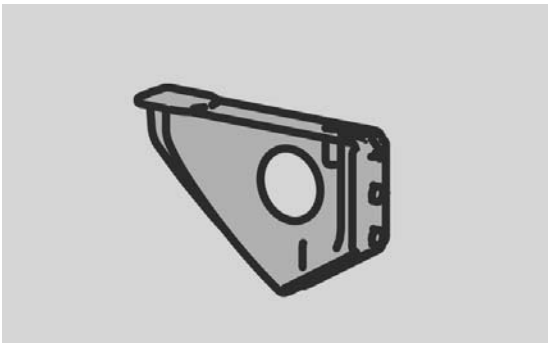

Slide net post onto netpost bar and screw into place.  
Insert guide plug.  
Repeat on other side of table.



2 Required  
4.8x25



2 Required



## Step 14

Attach ball/racquet holder to netpost.



# Assembly

## Step 15



Screw sideshroud into place.

Repeat installation of second shroud on opposite side wheelbase assembly.



6 Required  
3.9x25



# Assembly

## Net Assembly

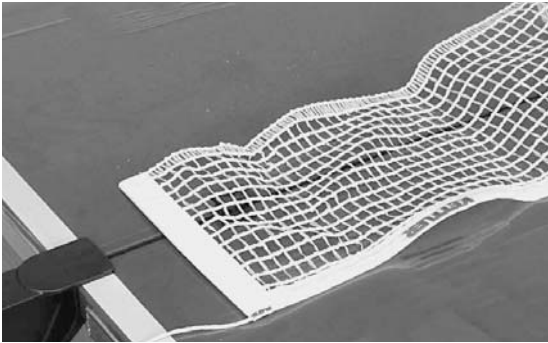

Net assembly:

Slide Jpin through net.. Place Jpin in designated slots. Tie string to tension tab. Place string in slots over Jpin and net post. Adjust net tension by adjusting tension tab.

Remove protective plastic film from table surface.

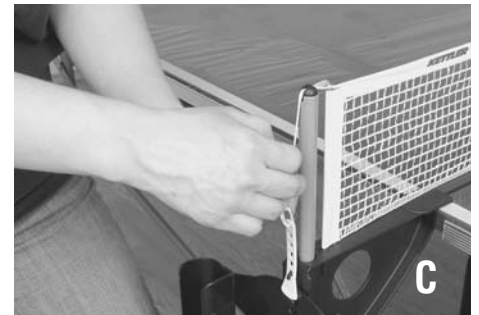
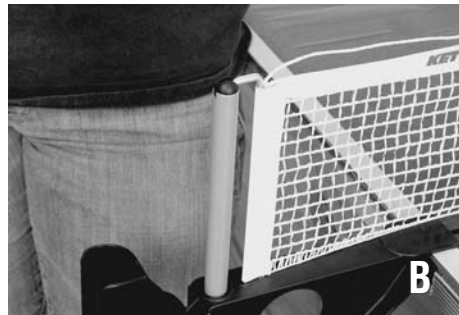
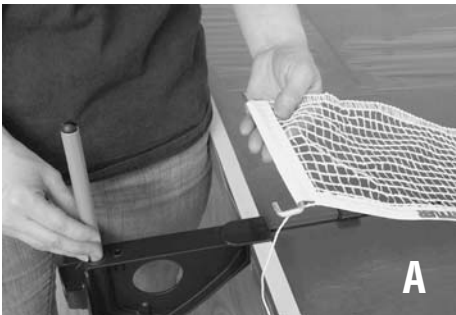

## Assembly

### Remove Film

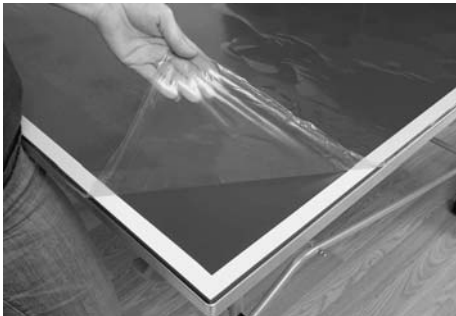

Remove protective plastic film from table surface.

### Folding Table



Folding Table:

To properly fold the table, lock the wheels, press the safety lever up and lift top. Once the top is halfway up you can release lever and continue to fold the top.



## Limited Warranty

**THERE ARE NO WARRANTIES, EXPRESSED OR IMPLIED, MADE BY EITHER THE DISTRIBUTOR OR THE MANUFACTURER ON KETTLER® PRODUCTS, EXCEPT THE MANUFACTURER'S LIMITED WARRANTY AGAINST DEFECTS IN MATERIAL SET OUT BELOW:**

This KETTLER® Limited Warranty applies to products sold through the KETTLER® Authorized Dealer Network to the original retail purchaser and authenticated by proof of purchase from a retailer located in the United States. Any shipments made under this warranty will be shipped to the United States only. Any shipment outside of the United States will be at the sole cost of the customer. This KETTLER® Limited Warranty is a manufacturer's warranty and is not changed or modified by additional warranties extended by individual retailers at the point of sale. Manufacturer warrants this product to be free from defects in material at the time of the product's tender of delivery for a period of 3 years for residential use and 1 year for commercial use. This Limited Warranty is not transferable and does not cover normal wear and tear (including, but not limited to, damage and wear to tires, power shocks, drive belts and other non-durable parts). The liability of the manufacturer under this Limited Warranty shall not include any liability for direct, indirect, or consequential damages resulting from the defect. This Limited Warranty is void if the product is damaged by accident, unreasonable use, improper service, failure to follow instructions provided, modification from its original state, or other causes determined not arising out of defects in material.

This warranty gives you specific legal rights. Should this product become defective due to material within the warranty period, contact KETTLER® Parts & Service Dept. by phone at 866.804.0440, fax at 757.563.9273, or e-mail at [parts@kettlerusa.com](mailto:parts@kettlerusa.com).

**THIS LIMITED WARRANTY IS EXPRESSLY IN LIEU OF ANY OTHER WARRANTIES, EXPRESSED OR IMPLIED, INCLUDING ANY IMPLIED WARRANTY OF MERCHANTABILITY OR FITNESS FOR A PARTICULAR PURPOSE, AND OF ANY OTHER OBLIGATIONS OR LIABILITY ON THE PART OF THE MANUFACTURER. KETTLER® NEITHER ASSUMES NOR AUTHORIZES ANY OTHER PERSON TO ASSUME FOR IT ANY OTHER LIABILITY IN CONNECTION WITH SUCH PRODUCTS.**



# Limited Warranty

## Ordering Spare Parts

When ordering spare parts, always state the full model number, spare part number, the quantity required and the serial number.

**Example order:** Model 7136-500/spare part number 70130761/qty 1/serial number...

**Important:** Spare part prices do not include fastening materials; if fastening material (bolts, nuts, washers, etc.) is required, this should be clearly stated on the order by adding the words **“with fastening material.”**

**Contact:** KETTLER®International Inc., 1355 London Bridge Road, Virginia Beach, VA 23453 USA

Online: [www.kettlerusa.com](http://www.kettlerusa.com) • E-mail: [info@kettlerusa.com](mailto:info@kettlerusa.com) • For parts/service: call 866-804-0440 or e-mail [parts@kettlerusa.com](mailto:parts@kettlerusa.com)

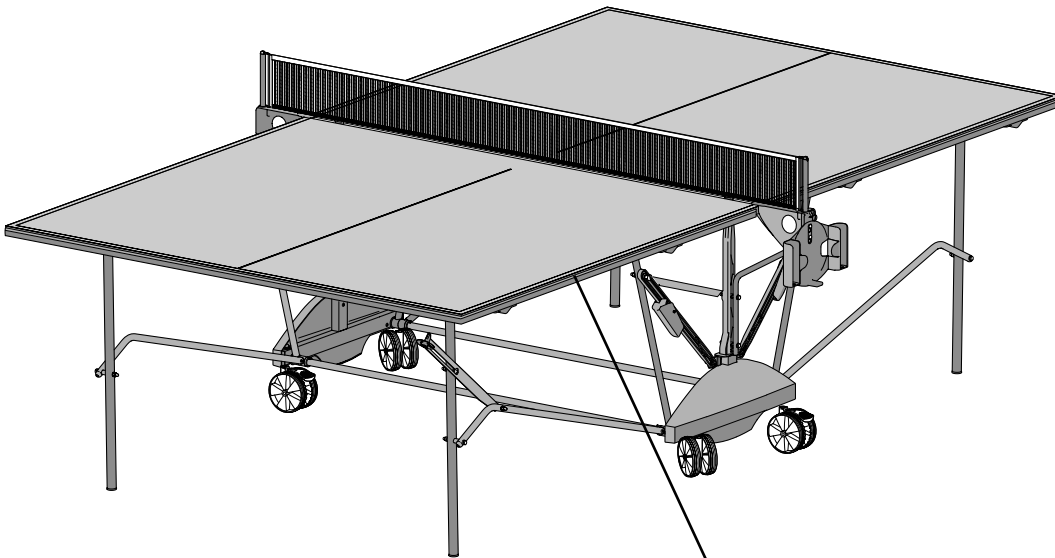

**FREIZEIT MARKE KETTLER**  
HEINZ KETTLER GmbH & Co. KG  
D-59469 Ense-Parsit

Art.-Nr. 07044-000  
1-334 O - 1801 00001  
geprüft nach prEN 14468-1, -2  
Klasse C, Typ 4  
Made in Germany

Serial Number

# Spare Parts

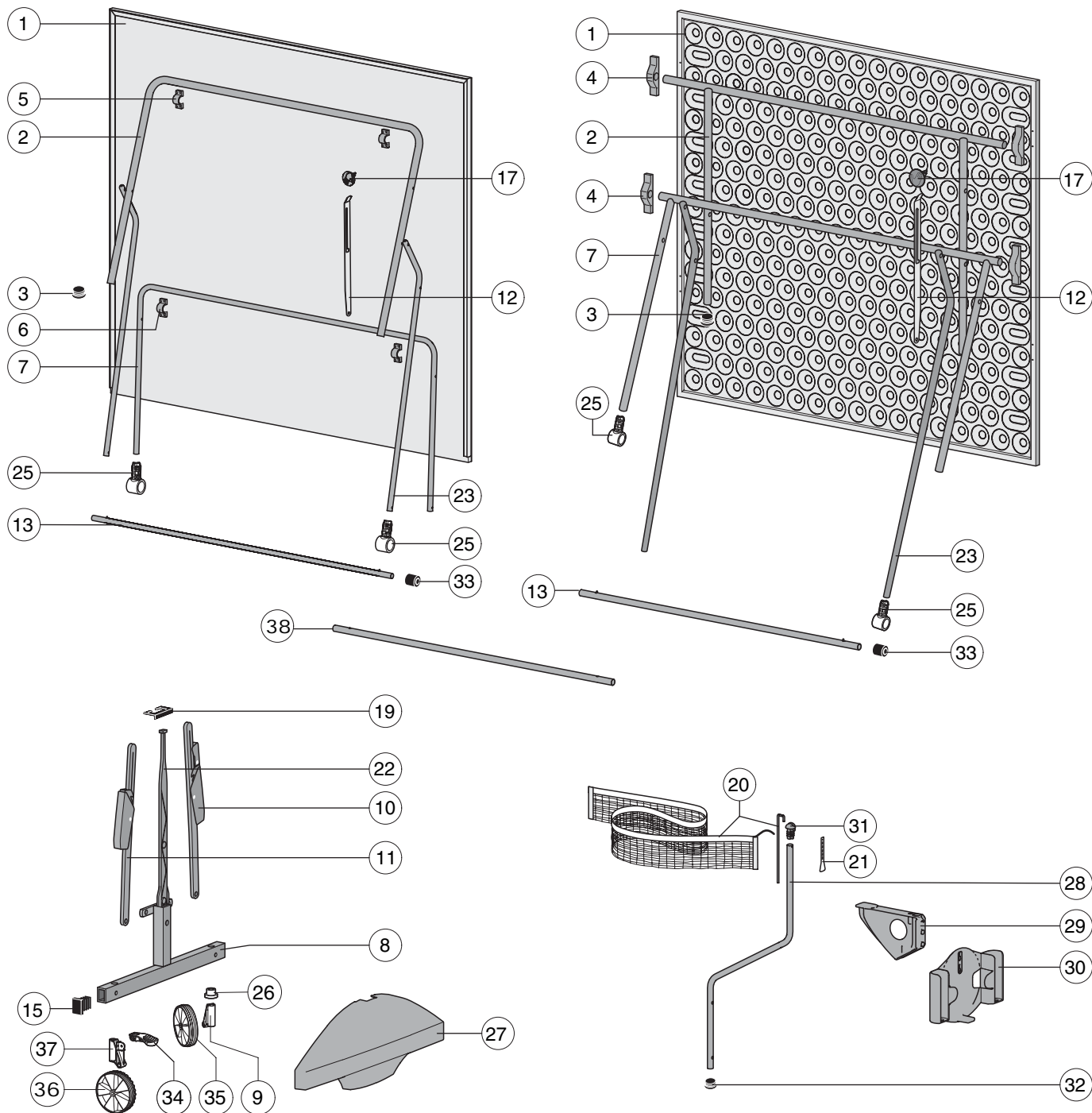

## Spare Parts

Number	Description	Number Required	Spare Part Number for 7136-500 Indoor	Spare Part Number for 7176-500 Outdoor
1	Top	2	94130117	94130125
2	Leg	2	94111138	94111129
3	Footcap	4	70130540	70130540
4	Clamp (outdoor table)	8		10128028
5	Clamp 25mm (indoor table)	4	94110341	
6	Clamp 18mm (indoor table)	4	94110192	
7	Support Leg	2	94111139	94111130
8	Wheelbase	2	94111142	94111142
9	Stemtube for non-locking wheel (3437)	2	70130812	70130812
10	Locking Strut with thumb latch	2	94111137	94111137
11	Locking Strut without thumb latch	2	94111136	94111136
12	Safety Lever	2	94111120	94111120
13	Crossbar M8	2	94111055	94111055
15	Endcap 40x25mm	4	10100009	10100009
17	Handgrip	2	70130532	70130532
18	Hardware Bag (not illustrated)	1	94180323	94180323
19	Shimpad (pair) (outdoor table)	1		94180271
20	Net	1	94180274	94180274
21	Tension Tab	2	10128002	10128002
22	Alignment Strut	2	70130604	70130604
23	Jbar	4	94111132	94111132
25	Eyelet	8	70130830	70130830
26	Bushing	8	10116011	10116011
27	Sideshroud	2	70115017	70115017
28	Netpost Bar	2	94111080	94111080
29	Netpost	2	70130518	70130518
30	Ball and Racquet Holder	1	70130522	70130522
31	Guide plug (4439)	2	70130519	70130519
32	Endcap	2	10100096	10100096
33	Washer 26x19x6	4	10107067	10107067
34	Footlock (3507)	2	70130816	70130816
35	Non-locking Wheel	4	70130762	70130762
36	Locking Wheel	4	70130761	70130761
37	Stemtube for locking wheel (3508)	2	70130815	70130815
38	Crossbar M6	1	94111056	94111056

Number	Description	Number Required	Spare Part Number for 7136-000 Indoor	Spare Part Number for 7176-000 & -090 Outdoor
1	Top	2	94130098	94130003



©2011 KETTLER® All rights reserved. No part of this manual may be reproduced, stored in a retrieval system, or transmitted in any form, or by any means, such as electronic, mechanical, photocopying or otherwise, without the prior written permission of KETTLER®.

KETTLER®International Inc., 1355 London Bridge Road, Virginia Beach, VA 23453 USA

[www.kettlerusa.com](http://www.kettlerusa.com) • E-mail: [info@kettlerusa.com](mailto:info@kettlerusa.com)

For parts/service: call 866-804-0440 or e-mail [parts@kettlerusa.com](mailto:parts@kettlerusa.com)

## Free Manuals Download Website

<http://myh66.com>

<http://usermanuals.us>

<http://www.somanuals.com>

<http://www.4manuals.cc>

<http://www.manual-lib.com>

<http://www.404manual.com>

<http://www.luxmanual.com>

<http://aubethermostatmanual.com>

Golf course search by state

<http://golfingnear.com>

Email search by domain

<http://emailbydomain.com>

Auto manuals search

<http://auto.somanuals.com>

TV manuals search

<http://tv.somanuals.com>