



USING **YOUR BREWER**

OWNER'S MANUAL: Getting the most from your new
B31 MINI PLUS Keurig® Brewer



IMPORTANT SAFEGUARDS

Safe Operation & Use



When using electrical appliances, basic safety precautions should be followed, including the following:

1. Read all instructions before using.
2. Do not touch hot surfaces. Use handle and knobs when available.
3. This appliance must be properly installed and located in accordance with these instructions before it is used.
4. The use of accessory attachments is not recommended by the appliance manufacturer and may result in fire, electrical shock or injury to persons.
5. Do not place on or near a hot gas or electric burner, or in a heated oven.
6. Do not use outdoors.
7. To protect against fire, electric shock and injury, do not immerse cords, plugs or the appliance in water or any other liquid.
8. Do not overfill the Cold Water Reservoir.
9. Use **only water** in this appliance! Do not put any other liquids or foods in the Cold Water Reservoir, except as instructed in the Cleaning Instructions in this guide.
10. Turn off and unplug the Brewer before cleaning or maintenance. Allow to cool before putting on or taking off parts and before cleaning the appliance.
11. For best operation, plug the appliance into its own electrical outlet on a dedicated circuit to prevent flickering of lights, blowing of fuses or tripping a circuit breaker.
12. Do not operate any appliance with a damaged cord or plug, or after the appliance malfunctions or is damaged in any manner. Contact Keurig Customer Service to report any malfunction or damage to the Brewer.
13. Do not let the cord hang over the edge of the table or counter, or touch hot surfaces.
14. To disconnect, press the Power Button on the front right side of the Brewer—this will turn the power off. Then, remove the plug from the wall outlet.
15. Close supervision is necessary when any appliance is used by or near children.
16. **Do not lift the Brewer Handle while brewing is in progress, scalding may occur.**
17. Always keep the Cold Water Reservoir Lid closed unless you are refilling it.
18. This appliance is equipped with a power cord having a grounding wire with a grounding plug. The appliance must be grounded using a 3-hole, properly grounded outlet. In the event of an electrical short circuit, grounding reduces the risk of electrical shock.
19. If the outlet is a standard 2-prong wall outlet, it is your personal responsibility and obligation to have it replaced with a properly grounded 3-prong wall outlet.
20. Do not, under any circumstances, cut or remove the third (ground) prong from the power cord or use an adapter.
21. Consult a qualified electrician if the grounding instructions are not completely understood or if doubt exists as to whether the appliance is properly grounded.
22. Do not use the appliance for any reason other than its intended use.

SAVE THESE INSTRUCTIONS.



CAUTION: There are two sharp needles that puncture the K-Cup® portion pack, one above the K-Cup Holder and the other in the bottom of the K-Cup Holder. To avoid risk of injury, do not put your fingers in the K-Cup Assembly Housing.

CAUTION: There is extremely hot water in the K-Cup Holder during the brew process. To avoid risk of injury, do not lift the Brewer Handle or open the K-Cup Assembly Housing during the brewing process.

SHORT CORD INSTRUCTIONS: A short power supply cord is provided to reduce the risk of becoming entangled in or tripping over a longer cord.

If an extension cord is used, (1) the marked electrical rating of the cord set or extension cord should be at least as great as the electrical rating of the appliance; (2) the cord should be arranged so that it will not drape over the countertop or tabletop where it can be pulled on by children or tripped over unintentionally; and (3) the extension cord must include a 3-prong grounding plug.

THIS PRODUCT IS FOR **HOUSEHOLD USE ONLY.**

WARNING KEEP ALL PLASTIC BAGS AWAY FROM CHILDREN.

WARNING THIS PRODUCT CONTAINS CHEMICALS, INCLUDING LEAD, WHICH IS KNOWN TO THE STATE OF CALIFORNIA TO CAUSE CANCER, BIRTH DEFECTS OR OTHER REPRODUCTIVE HARM.

WARNING TO USERS AND PARENTS

- 1. DO NOT** permit children to use Brewer without adult supervision. Brewer dispenses very hot water.
- 2. SPECIAL NOTICE FOR HOT COCOA USERS: IMMEDIATELY AFTER USING A HOT COCOA K-CUP, RUN a Hot Water Brew Cycle** without a K-Cup to avoid the possibility of clogging the exit needle. **DO NOT** assume the next user will do this.

<p>WARNING RISK OF FIRE OR ELECTRIC SHOCK DO NOT OPEN</p>  	<p>WARNING: TO REDUCE THE RISK OF FIRE OR ELECTRIC SHOCK, DO NOT REMOVE THE BOTTOM COVER. NO USER SERVICEABLE PARTS ARE INSIDE. REPAIR SHOULD BE DONE BY AUTHORIZED SERVICE PERSONNEL ONLY.</p>
---	--

TABLE OF CONTENTS

KEURIG® GOURMET SINGLE CUP HOME BREWING SYSTEM
Model B31 MINI PLUS **Using Your Brewer**

SECTION 1—Brewer Overview.....	4
SECTION 2—Helpful Hints.....	6
SECTION 3—Buttons & Indicators.....	7
SECTION 4—Set-up & Operation Initial Cleansing & First Brew.....	8
SECTION 5—Cleaning & Maintenance Cleaning External Parts.....	12
Cleaning the K-Cup® Portion Pack Holder Assembly.....	12
Cleaning the Cold Water Reservoir.....	14
Emptying the Internal Hot Water Tank.....	14
Storage.....	14
Storing the Power Cord.....	14
De-Scaling Your Brewer.....	15
SECTION 6—Troubleshooting.....	16
SECTION 7—Warranty.....	18

Record your Brewer Serial Number here.

Removing the serial number label from the Brewer will void warranty.

SECTION 1 Brewer Overview

- A Cold Water Reservoir Lid**
- B Cold Water Reservoir**
- C BREW Button**
- D Add Water/Brewer Handle Indicator**
- E Power Button**
- F Power Cord**
- G Drip Tray Base**
- H Drip Tray**
- I Drip Tray Plate**
- J Drip Tray Overflow Indicator**
- K K-Cup Portion Pack Assembly Housing**
- L Brewer Handle**
- M Water Level Guide** (Inside Cold Water Reservoir)
- N K-Cup Portion Pack Holder**
- O Funnel**
- P K-Cup Portion Pack Holder Assembly**

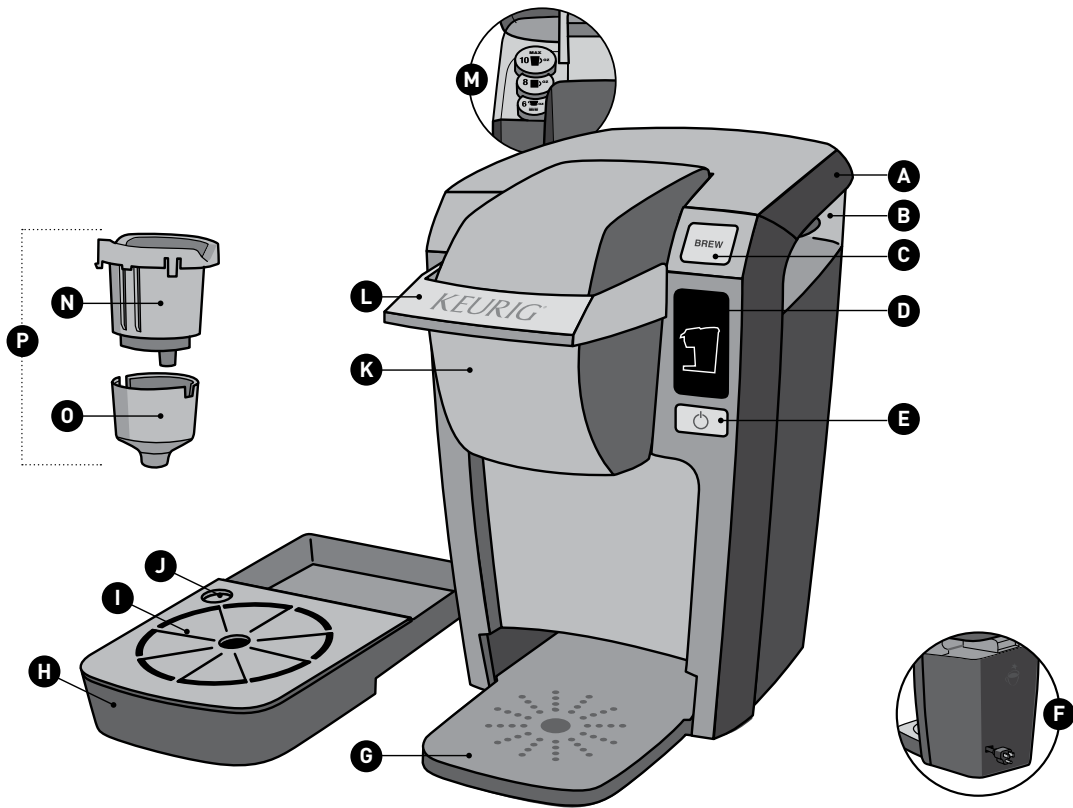

For replacement parts, please call 1.866.901.BREW [2739].

SECTION 2 Helpful Hints

Plug Brewer into its own grounded outlet — If the electric circuit is overloaded with other appliances, your Brewer may not function properly. The Brewer should be operated on its own circuit, separate from other appliances.

Initial Cleansing Brew — Before you use your Brewer for the first time, perform an initial cleansing brew by running clean water through the brew cycle without using a K-Cup® portion pack.

One Cup at a Time — Your new Brewer makes one fresh beverage at a time. You'll need to add fresh water each time you brew. Unlike other Keurig Brewers, the B31 does not store water in the reservoir.

The Right Water Makes a Difference — For the best tasting gourmet coffee, tea or hot cocoa, Keurig recommends using bottled or filtered water. We do not recommend using distilled or reverse osmosis water. Water quality varies from place to place. If you notice an undesirable taste in your cup of coffee such as chlorine or other mineral taste, we recommend you consider using bottled water or water from a filtration system.

Customize your Size, Flavor & Brew — With the choice of over 200 varieties of K-Cups and multiple fill levels, your Brewer gives you endless options to customize the size, flavor and strength that's perfect for you. For a strong, intense cup, select an Extra Bold K-Cup (with up to 30% more ground coffee than regular varieties) and brew size that's right for you. The less water you use, the more intense flavor in your cup. The more water you use, the less intense flavor in your cup.

To guide you, the Brewer includes a Water Level Guide located inside the Cold Water Reservoir. The Water Level Guide is removable to make cleaning easy.

Brewing into a tall mug — To brew into a tall mug, simply remove the Drip Tray Assembly and place the tall mug on the Drip Tray Base.

The Drip Tray — Any liquid overflow (from your cup or the Cold Water Reservoir) will be caught in the Drip Tray. Be sure to empty the Drip Tray when the red Drip Tray Overflow Indicator pops up. The Drip Tray has a snug fit to ensure it stays put in transit.

Automatic Shut Off — Your Brewer will shut off automatically when it is idle for longer than 90 seconds. Simply press the Power Button to restart.

Clean Your Brewer Regularly — To keep your Brewer looking and performing its best, be sure to clean the external and internal components on a regular basis. See page 12 for more information.

De-Scaling — Mineral content in water varies from place to place. Depending on the mineral content of the water in your area, calcium deposits or scale may build up in your Brewer. Scale is non-toxic, but left unattended, it can hinder Brewer performance. De-scaling your Brewer helps maintain the heating element and other internal parts of the Brewer that come in contact with water. See page 15 for more information.

Storing — When storing your Brewer, carefully empty the Drip Tray and make sure both the Cold Water Reservoir and Internal Hot Water Tank are empty. Store your Brewer upright in a safe, dry, frost-free environment. See page 14 for more information.

SECTION 3 Buttons & Indicators



Power Button

The Power Button turns your Brewer On and Off.



Add Water Indicator

Flashing Blue — Indicates you should fill the Cold Water Reservoir.



Brewer Handle Indicator

Flashing Blue — Indicates the minimum amount of water (6 oz.) has been poured into the Cold Water Reservoir and you're ready to insert a K-Cup. Lift the Brewer Handle, insert a K-Cup, then lower the Brewer Handle completely and firmly to close.



BREW Button Indicators

Flashing Blue — Indicates you are ready to brew your beverage. Press the BREW Button once to start the brewing process.

Flashing Red — Indicates the water is heating.

Solid Red — Indicates brewing has begun.

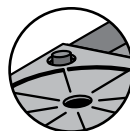

Drip Tray Overfill Indicator

A red float will appear when the Drip Tray is almost full. Carefully slide the Drip Tray out and empty its contents.

Your Next Brew

When the brewing process is complete, your Brewer is ready for the next beverage. Begin the process again, adding fresh water and a new K-Cup.

★ *Your Brewer will shut off automatically when it is idle for longer than 90 seconds. Simply press the Power Button to restart.*

SECTION 4 Set-up & Operation

Initial Cleansing & First Brew

Before
you
Brew

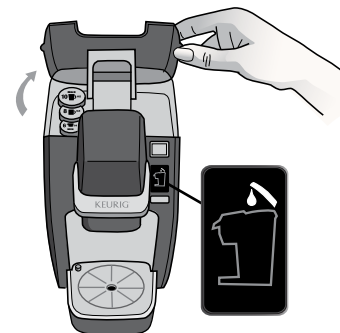
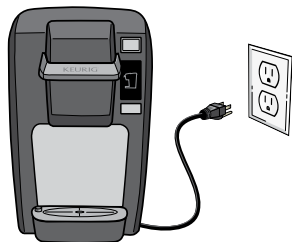

1

Before making your first beverage, perform an initial cleansing brew. Follow these steps, **skipping numbers 9 and 10**. The initial cleansing brew is performed without a K-Cup® portion pack.

2

Plug the Brewer into its own grounded outlet. If the electric circuit is overloaded with other appliances, your Brewer may not function properly. The Brewer should be operated on its own circuit, separate from other appliances.

3

Press the Power Button found on the front of the Brewer.

4

The Add Water Indicator will flash blue. Lift the Cold Water Reservoir Lid to open.

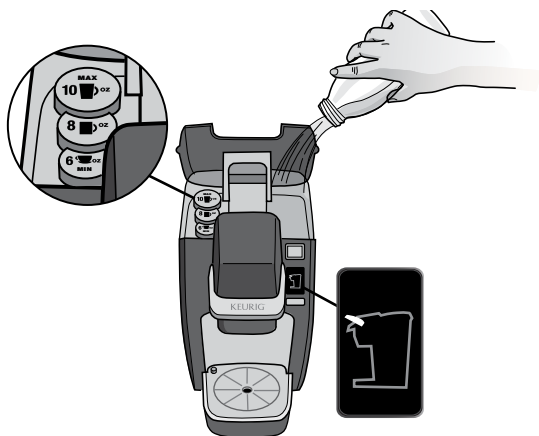

5

Fill the Cold Water Reservoir to the desired fill level with filtered or bottled water. (We do not recommend distilled or reverse osmosis water.) The Brewer Handle Indicator will flash blue when the minimum water level (6 oz.) is reached.

★ *The Brewer has three fill levels – 6 oz., 8 oz. and 10 oz. For precise measuring, make sure the Brewer Handle is closed completely.*

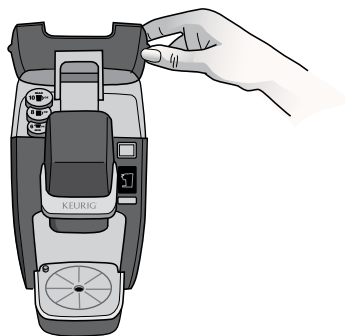

6

Close the Cold Water Reservoir Lid.

★ *If you should happen to over-fill the Cold Water Reservoir, the overflow will be caught in the Drip Tray.*



7

Place a mug on the Drip Tray Plate.
NOTE: The Drip Tray is not dishwasher safe.

★ *The Drip Tray slides out so you can fit a taller mug!*

SECTION 4 Set-up & Operation (continued)



CAUTION: There are two sharp needles that puncture the K-Cup, one above the K-Cup Holder and the other in the bottom of the K-Cup Holder. To avoid risk of injury, do not put your fingers in the K-Cup Assembly Housing.



8

Lift the Brewer Handle to open.
Water will exit the Cold Water Reservoir
and enter the Brewer.



9

Select a K-Cup® portion pack.
Do not remove the foil lid or puncture
the K-Cup.

**Skip Steps 9 and 10 for the initial
cleansing brew.**



10

Place the selected K-Cup into the K-Cup
Holder Assembly.

★ *Ensure all of the water has left the Cold Water Reservoir and drained into the Brewer before proceeding to Step 11.*

CAUTION: There is extremely hot water in the K-Cup Holder during the brew process. To avoid risk of injury, do not lift the Brewer Handle or open the K-Cup Assembly Housing during the brewing process.



11

Lower the Brewer Handle completely and firmly to close.

★ *Ensure all of the water has left the Cold Water Reservoir and drained into the Brewer before lowering the Brewer Handle.*



12

The BREW Button will flash blue. Press the BREW Button. It will then flash red while the water is heating, and turn solid red when brewing begins.

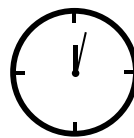

2 Min

13

The water will reach the correct temperature in approximately 2 minutes. The BREW Button will turn solid red and your beverage will start to dispense.



14

If you are performing an initial cleansing brew, discard the water from the mug and begin at Step 4 to brew your first beverage.

If you have previously completed an initial cleansing brew, enjoy your beverage.

★ *Your Brewer is now ready for the next beverage. Begin the process again, adding fresh water and a new K-Cup.*

SECTION 5 Cleaning & Maintenance

Cleaning External Parts

IMPORTANT: Make sure the Brewer is unplugged before cleaning.

Regular cleaning of the Brewer's external components is recommended.

1. Never immerse the Brewer in water or other liquids. The Brewer housing and other external components should be cleaned with a damp, non-abrasive, lint-free cloth.
2. The Drip Tray and Drip Tray Plate should be periodically inspected and cleaned with a damp, non-abrasive, lint-free cloth. The Drip Tray and Drip Tray Plate should not be put into the dishwasher. To remove the Drip Tray, simply slide it toward you. Remember, when the red Drip Tray Overfill Indicator appears, the Drip Tray is almost full. Carefully remove the Drip Tray and discard its contents.

★ *The Drip Tray has a snug fit to ensure it stays put in transit.*

Cleaning the K-Cup® Portion Pack Holder Assembly

1. **Cleaning the Parts** — The K-Cup Holder Assembly can be placed onto the top shelf of a dishwasher. **NOTE: Use low temperature cycles in the dishwasher.** To remove the K-Cup Holder Assembly from the Brewer, lift the Brewer Handle to open. Grasp the top of the K-Cup Holder with one hand. With the other hand, push up on the bottom of the K-Cup Holder until it releases (fig. 1). After cleaning, align the K-Cup Holder with the opening using the two front ribs as a guide, and snap into place from the top (fig. 2).



2. **Cleaning the Funnel** — The Funnel can be removed from the K-Cup Holder by pulling on it until it snaps off (fig. 3). The Funnel can be placed on the top shelf of a dishwasher. **NOTE: Use low temperature cycles in the dishwasher.** To replace the Funnel, just snap it back onto the K-Cup Holder Assembly.
3. **Cleaning the Exit Needle** — The Exit Needle is located on the inside bottom of the K-Cup Holder Assembly. Should a clog arise due to coffee grinds, it can be cleaned using a paper clip or similar tool. Remove K-Cup Holder Assembly and detach Funnel. Insert the paper clip (fig. 4) into the Exit Needle to loosen the clog and push it out. The K-Cup Holder can be placed on the top shelf of a dishwasher. **NOTE: Use low temperature cycles in the dishwasher. The Entrance Needle does not require cleaning.**

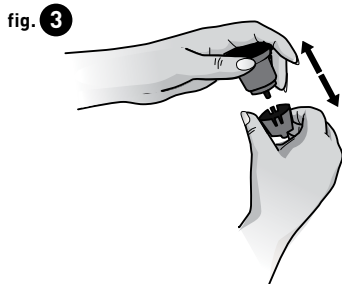

CAUTION: There are sharp needles that puncture the K-Cup above the K-Cup Holder and in the bottom of the K-Cup Holder. To avoid risk of injury, do not put your fingers in the K-Cup Assembly Housing.

NOTE: Over time, discoloration, spotting or staining may appear in the Cold Water Reservoir. This is normal and will vary depending on the mineral content of the bottled or filtered water used. This will not affect the operation of the Brewer. However, be sure to clean the Cold Water Reservoir regularly to minimize build-up (see page 14).

SECTION 5 Cleaning & Maintenance (continued)

Cleaning the Cold Water Reservoir

To access the Cold Water Reservoir, lift the Cold Water Reservoir Lid. Remove the Water Level Guide (fig. 5), then clean the inside of the reservoir with a damp, lint-free cloth as necessary (fig. 6). Replace the Water Level Guide and close the Cold Water Reservoir Lid when finished. **NOTE: The Water Level Guide is not dishwasher safe.**

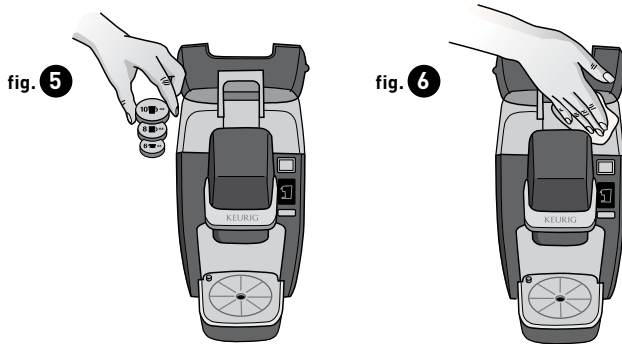

Emptying the Internal Hot Water Tank

1. Brewer must be powered off and plugged in.
2. Ensure that the Cold Water Reservoir Lid is closed.
3. Place a mug on the Drip Tray, then press and hold the BREW Button until all the water has been dispensed. **NOTE: There will be a delay of 3–4 seconds before water begins to dispense.**

Storage

Empty the Internal Hot Water Tank and Cold Water Reservoir before storing. Ensure that you store your Brewer in a safe and frost-free environment, and in an upright position. Storing the Brewer in cold temperatures may cause condensation to freeze inside the Brewer and cause damage.

Before using your Brewer after storage, wipe the Cold Water Reservoir with a damp, lint-free cloth and run three cleansing brews without a K-Cup® portion pack. See page 8 for more information.

If your Brewer has been in an environment below freezing, allow the Brewer to rest at room temperature for at least 2 hours before powering on.

Storing the Power Cord

Behind the Brewer is a convenient compartment that will hold the Power Cord (fig. 7). This makes the Brewer both easier to store and easier to take on the go.

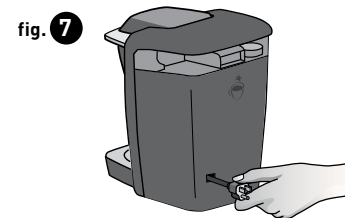

De-Scaling Your Brewer

Depending on the mineral content of the water, calcium deposits or scale may build up in your Brewer. Scale is non-toxic but left unattended, it can hinder Brewer performance. De-scaling your Brewer helps maintain the heating element and other internal parts of the Brewer.

The Brewer should be de-scaled every 3-6 months to ensure optimal performance or when there are white deposits in the Cold Water Reservoir. It is possible for calcium deposits to build up faster, making it necessary to de-scale more often.

A. PREPARE

You will need 20 oz. of undiluted white vinegar, a 12 oz. ceramic mug (do not use a paper cup) and access to a sink.

B. FILL AND CLEAN

Step 1: Fill the Cold Water Reservoir with 10 oz. of undiluted white vinegar to the 10 oz. mark on the Water Level Guide.

Step 2: Place the ceramic mug on the Drip Tray Plate. Lift and lower the Brewer Handle completely and perform a brew without adding a K-Cup. Empty the contents of the ceramic mug into the sink.

CAUTION: Be careful as contents will be hot.

Step 3: Place the ceramic mug back on the Drip Tray Plate. Pour the remaining 10 oz. of vinegar into the Cold Water Reservoir. Start a brew, but power off the Brewer just after it starts to dispense. Allow it to sit for at least 30 minutes.

C. RINSE

Step 1: After the prescribed period of time (at least 30 minutes), turn your Brewer on and place the ceramic mug on the Drip Tray Plate. Lift and lower the Brewer Handle completely and perform a brew without adding a K-Cup. Empty the contents of the ceramic mug into the sink.

CAUTION: Be careful as contents will be hot.

Step 2: Fill the Cold Water Reservoir with 10 ounces of fresh water, place the ceramic mug on the Drip Tray Plate and perform a brew without adding a K-Cup.

Step 3: Repeat Step 2 three times to cleanse the Brewer plumbing and get rid of any residual taste from the vinegar. The Brewer is now ready for normal use again.

Service

Beyond these recommended cleaning and maintenance procedures, this Brewer is not user serviceable. For service, please refer to the Warranty section in this guide.

SECTION 6 Troubleshooting

SITUATION	SOLUTION
Brewer does not have power	<ul style="list-style-type: none">• Make sure the Power Button is pressed. The Add Water Indicator should flash blue after pushing the Power Button.• Plug Brewer into an independent outlet.• Check to be sure that it is plugged in securely.• Plug into a different outlet.• Reset your home's circuit breaker if necessary.
Brewer will not brew when used for the first time	<ul style="list-style-type: none">• Brewer may be cold or frozen. Let Brewer rest at room temperature for at least 2 hours before powering on.
Brewer will not brew	<ul style="list-style-type: none">• Make sure the Brewer has power (see above).• Press the Power Button. If the Add Water Indicator flashes blue, add water and attempt to brew. If the Add Water Indicator does not flash blue, make sure the Brewer has power (see above). If the Brewer still does not operate, contact Customer Service.• If the BREW Button flashes red longer than 3 minutes, contact Customer Service.

SITUATION	SOLUTION
Brewer only brews a partial brew	<ul style="list-style-type: none"> • The Exit Needle may be clogged (see page 13). • Clean the K-Cup® Portion Pack Holder Assembly if necessary (see page 12). • De-scale the Brewer (see page 15). • If you have repeated the de-scale procedure two times, and the Brewer still does not function properly, contact Customer Service.
Brewer shuts off automatically	<ul style="list-style-type: none"> • In normal operation, the Brewer will shut off when it is idle for longer than 90 seconds. Just press the Power Button to restart. • If the Brewer shuts off in the middle of a brew, contact Customer Service.
There is water in the Drip Tray	<ul style="list-style-type: none"> • Remember that any liquid overflow (from your cup or the Cold Water Reservoir) will be caught in the Drip Tray. • When the Drip Tray is almost full, the red Drip Tray Overflow Indicator will appear. Carefully remove the Drip Tray and empty its contents into the sink.
Red Indicator appears in Drip Tray	<ul style="list-style-type: none"> • This means the Drip Tray is almost full. Carefully remove the Drip Tray and empty its contents into the sink.

Should other issues arise with your Brewer, please call Keurig Customer Service at 1.866.901.BREW (2739).

SECTION 7 Warranty

Limited One Year Warranty

Keurig® warrants that your Brewer will be free of defects in materials or workmanship under normal use for one year from the date of purchase. It is recommended that you fill out and return the warranty card enclosed with your Brewer so that your purchase information will be stored in our system. Keurig will, at its option, repair or replace the Brewer without charge upon its receipt of proof of the date of purchase. If a replacement Brewer is necessary to service this warranty, the replacement Brewer may be new or reconditioned. If a replacement Brewer is sent, a new limited one year warranty will be applied to the replacement Brewer.

This warranty only applies to Brewers operated in the United States and Canada. This warranty gives you specific legal rights, and you may also have other rights that vary from state to state and, in the case of Canada, from province to province.

What is not covered by the limited warranty?

THIS WARRANTY DOES NOT COVER CONSEQUENTIAL OR INCIDENTAL DAMAGES SUCH AS PROPERTY DAMAGE AND DOES NOT COVER INCIDENTAL COSTS AND EXPENSES RESULTING FROM ANY BREACH OF THIS WARRANTY, EVEN IF FORESEEABLE. Some states or provinces do not allow the exclusion or limitations of incidental or consequential damages, so the above limitation or exclusion may not apply to you depending on the state or province of purchase.

Nor does this warranty cover damages caused by services performed by anyone other than Keurig or its authorized service providers, use of parts other than genuine Keurig parts, or external causes such as abuse, misuse, inappropriate power supply or acts of God.

Other limitations

THIS WARRANTY IS EXCLUSIVE AND IS IN LIEU OF ANY OTHER EXPRESS WARRANTY, WHETHER WRITTEN OR ORAL. IN ADDITION, KEURIG HEREBY SPECIFICALLY DISCLAIMS ALL OTHER WARRANTIES WITH RESPECT TO YOUR B31 BREWER, INCLUDING ANY IMPLIED WARRANTY OF MERCHANTABILITY OR FITNESS FOR ANY PARTICULAR PURPOSE. Some states or provinces do not allow disclaimers of such implied warranties or limitations on how long an implied warranty lasts, so the above limitation may not apply to you depending on the state or the province of purchase.

How do you obtain warranty service?

Keurig Brewers are high-quality appliances and, with proper care, are intended to provide years of satisfying performance. However, should the need arise for warranty servicing, simply call Keurig Customer Service at our toll free phone number 1.866.901.BREW (2739). Please do not return your Brewer for servicing without first speaking to Keurig Customer Service to obtain an Authorization to Return number (ATR). Keurig Brewers returned without an ATR number will be returned to the sender without servicing.

Keurig, Incorporated
55 Walkers Brook Drive
Reading, MA 01867
1.866.901.BREW (2739)

Keurig, Incorporated
55 Walkers Brook Drive
Reading, MA 01867

Keurig, Incorporated is a wholly-owned subsidiary of
Green Mountain Coffee Roasters, Inc.

CLICK, CALL OR SHOP | www.keurig.com | 1.866.901.BREW | At over 17,000 stores in the U.S. and Canada



FOR HOUSEHOLD USE ONLY

Covered by U.S. Patent Number 7,165,488 and
other U.S. and foreign patents pending.

Made and printed in China



© 2009 Keurig, Incorporated
All rights reserved.

Free Manuals Download Website

<http://myh66.com>

<http://usermanuals.us>

<http://www.somanuals.com>

<http://www.4manuals.cc>

<http://www.manual-lib.com>

<http://www.404manual.com>

<http://www.luxmanual.com>

<http://aubethermostatmanual.com>

Golf course search by state

<http://golfingnear.com>

Email search by domain

<http://emailbydomain.com>

Auto manuals search

<http://auto.somanuals.com>

TV manuals search

<http://tv.somanuals.com>