

# Cuisinart®

## INSTRUCTION BOOKLET



**Single Serve Brewing System**

**SS-700**

For your safety and continued enjoyment of this product, always read the instruction book carefully before using.

---

# IMPORTANT SAFEGUARDS

When using electrical appliances, basic safety precautions should always be followed to reduce the risk of fire, electric shock and/or injury to persons, including the following:

1. **READ ALL INSTRUCTIONS.**
2. Do not touch hot surfaces. Use handles and knobs.
3. To protect against electric shock, do not place cord, plug, or base unit in water or other liquids.
4. Close supervision is necessary when any appliance is used by or near children.
5. Always unplug from outlet when not in use and before cleaning. Allow to cool before putting on or taking off parts and before cleaning the appliance.
6. Do not operate any appliance with a damaged cord or plug or after the appliance malfunctions or has been dropped or damaged in any manner. Return appliance to the nearest Cuisinart Repair Center for examination, repair, or electrical or mechanical adjustment.
7. The use of accessory attachments not recommended by Cuisinart may cause injuries, fire, electric shock or injury to persons.
8. Do not use outdoors.
9. Do not let cord hang over edge of table or counter, or touch hot surfaces.
10. Do not place on or near a hot gas or electric burner, or in a heated oven.
11. Always fill water reservoir first, then plug cord into the wall outlet. To disconnect, turn controls to Off, then remove plug from wall outlet.
12. Do not use appliance for other than intended use.
13. Do not lift handle to open the lid of the brewer while brewing is in progress.
14. Do not overfill the water reservoir with water. Use **ONLY WATER** in this appliance! Do not put any other liquids or foods in the water reservoir except as instructed in the cleaning instructions in this guide.
15. Do not clean drip tray with cleansers, steel wool pads, or other abrasive materials.
16. **WARNING: TO REDUCE THE RISK OF FIRE OR ELECTRIC SHOCK, DO NOT REMOVE THE BASE PANEL. NO USER-SERVICEABLE PARTS ARE INSIDE. REPAIR SHOULD BE DONE ONLY BY AUTHORIZED PERSONNEL.**

## SAVE THESE INSTRUCTIONS.

## FOR HOUSEHOLD USE ONLY

### WARNING: RISK OF FIRE OR ELECTRIC SHOCK



The lightning flash with arrowhead symbol within an equilateral triangle is intended to alert the user to the presence of uninsulated dangerous voltage within the product's enclosure that may be of sufficient magnitude to constitute a risk of fire or electric shock to persons.



The exclamation point within an equilateral triangle is intended to alert the user to the presence of important operating and maintenance (servicing) instructions in the literature accompanying the appliance.

## SPECIAL CORD SET INSTRUCTIONS

A short power-supply cord is provided to reduce the risks resulting from becoming entangled in or tripping over a longer cord.

Longer extension cords are available and may be used if care is exercised in their use.

If a long extension cord is used, the marked electrical rating of the extension cord must be at least as great as the electrical rating of the appliance. The extension cord should be a grounding-type 3-wire cord, and the longer cord should be arranged so that it will not drape over the countertop or tabletop where it can be pulled on by children or tripped over.

### NOTICE

If you have a diecast metal unit, for your protection, it is equipped with a 3-conductor cord set that has a molded 3-prong grounding-type plug, and should be used in combination with a properly connected grounding-type outlet as shown in Figure A.

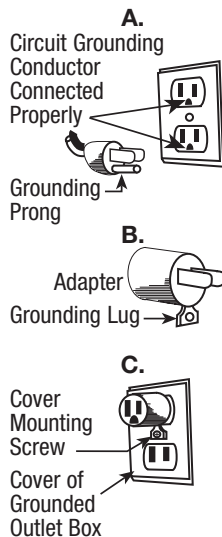

If a grounding-type outlet is not available, an adapter, shown in Figure B, may be obtained so that a 2-slot wall outlet can be used with a 3-prong plug. As shown in Figure C, the adapter must be grounded by attaching its grounding lug under the screw of the outlet cover plate.

**NOTE: Do not remove the grounding prong.**

**CAUTION: Before using an adapter, it must be determined that the outlet cover plate screw is properly grounded. If in doubt, consult a licensed electrician. Never use an adapter unless you are sure it is properly grounded.**

**Note: Use of an adapter is not permitted in Canada.**

## IMPORTANT UNPACKING INSTRUCTIONS

1. Place the box on a large, sturdy, flat surface.
2. Remove the instruction book and any other literature.
3. Turn the box so that the backside of the Brewer is down and slide the coffeemaker from the box.
4. After the Brewer has been removed, place the box out of the way and take the packing materials away.
5. Remove the polybag covering the Brewer.

We suggest you save all packing materials in the event that future shipping of the machine is needed. Keep all plastic bags away from children.



# Contents

Important Safeguards . . . . .	2
Important Unpacking Instructions . . . . .	3
The Quest for the Perfect Cup . . . . .	5
Features and Benefits. . . . .	6
Set-Up & First Brew . . . . .	8
Setting Up Your Brewer . . . . .	8
Charcoal Water Filter . . . . .	9
Brewing. . . . .	10
Hot Water/Rinse . . . . .	12
Brewing with the My K-Cup® Accessory. . . . .	13
Stopping the Brew Process . . . . .	14
Adding Water . . . . .	14
Purging the Brewer. . . . .	14
Programming . . . . .	15
Setting the Clock. . . . .	15
Programming On/Off Features . . . . .	15
Programming Brew Temperature . . . . .	17
Programming Your Brew Size . . . . .	18
Cleaning & Maintenance. . . . .	18
Cleaning External Parts . . . . .	18
Cleaning the My K-Cup® Filter. . . . .	18
Cleaning the K-Cup® Holder . . . . .	19
Cleaning the Water Reservoir and Lid. . . . .	19
De-Scaling Your Brewer . . . . .	20
Troubleshooting . . . . .	21
Warranty . . . . .	22

## The Quest for the Perfect Cup of Coffee

### Element 1:

#### **WATER**

Any hot beverage is made up primarily of water. Often overlooked, the quality of the water is as important as the quality of the coffee, tea or cocoa. A good rule of thumb is that if your water doesn't taste good from the tap, it won't taste any better in your beverage. That's why the Cuisinart® Single Serve Brewing System has added a charcoal water filter that removes chlorine, bad tastes and odors, for the purest cup every time.

### Element 2:

#### **COFFEE**

While the bulk of the liquid is water, all of the flavor should be from the coffee, tea or cocoa. To achieve the same great quality you receive at coffee bars, you need to use the same quality ingredients. By using the K-Cup®, brought to you by some of the most premium brands on the market, you can be assured that you're getting the finest, freshest gourmet product with every cup you brew. If you choose to use your own coffee in the included My K-Cup®, make sure all your ingredients are at their freshest.

### Element 3:

#### **GRIND**

The grind of coffee and cocoa, or the refinement of your tea leaves, is critical for proper flavor extraction. With the pre-measured, pre-ground ingredients found in every K-Cup®, you can rest easy knowing that it'll brew perfectly each and every time, locking in maximum flavor and freshness.

### Element 4:

#### **PROPORTION**

No matter which cup size you choose, the Cuisinart® Single Serve Brewing System, working in conjunction with K-Cup®, always produces the perfect cup every time. When grinding your own coffee and using it in the included My K-Cup®, remember to add the amount of ground coffee that corresponds to the number of ounces being brewed.



## Features and Benefits

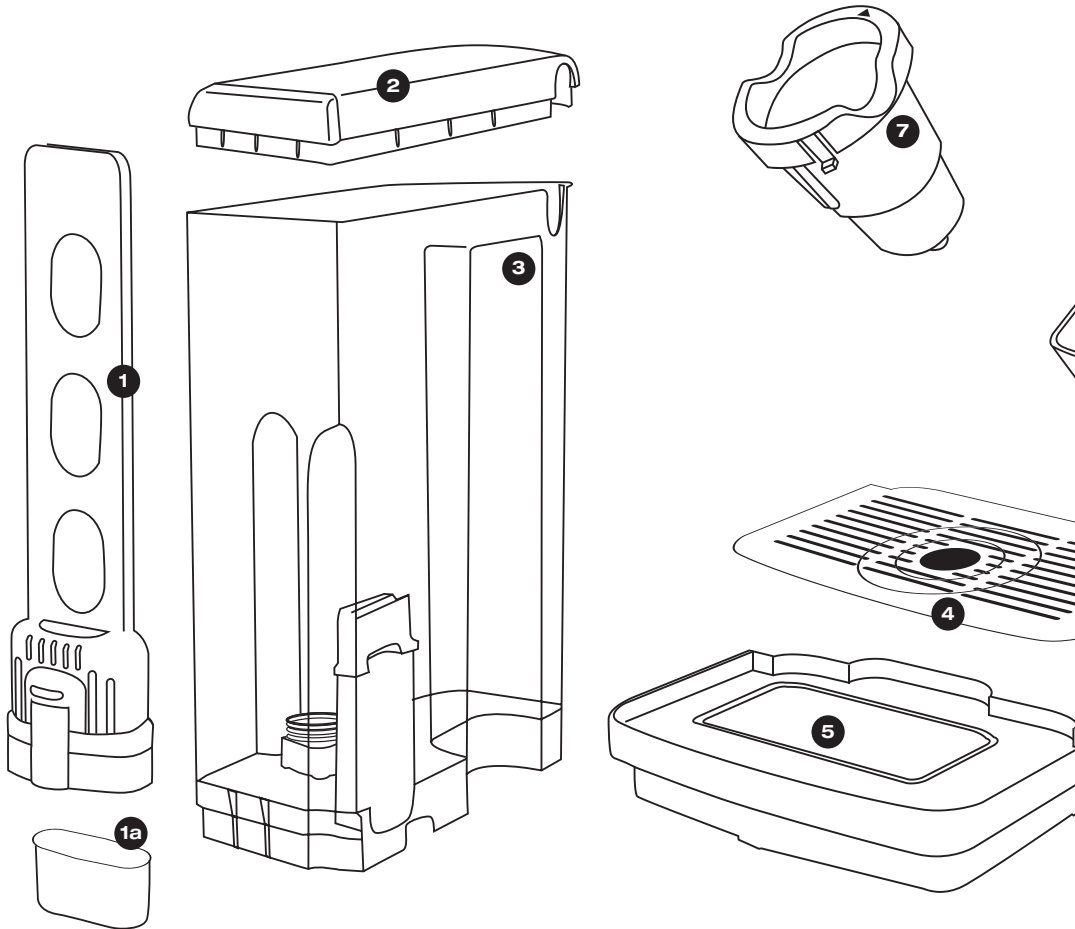

**1. Charcoal Filter Holder**

**1a. Charcoal Water Filter**

**2. Water Reservoir Lid**

Removes for easy filling.

**3. Removable 80-oz.  
Water Reservoir**

Offers extra-large capacity, eliminating the need for frequent refills.

**4. Removable Drip Tray Plate**

Allows extra space for travel mugs.

**5. Drip Tray**

**6. Drip Tray Base**

**7. Removable K-Cup® Holder**

**8. Handle**

Easy grip prevents slips.

**9. Brewing Head**

**10. Brewing Chamber**

Holds My K-Cup® or the K-Cup® Holder.

**11. Housing**

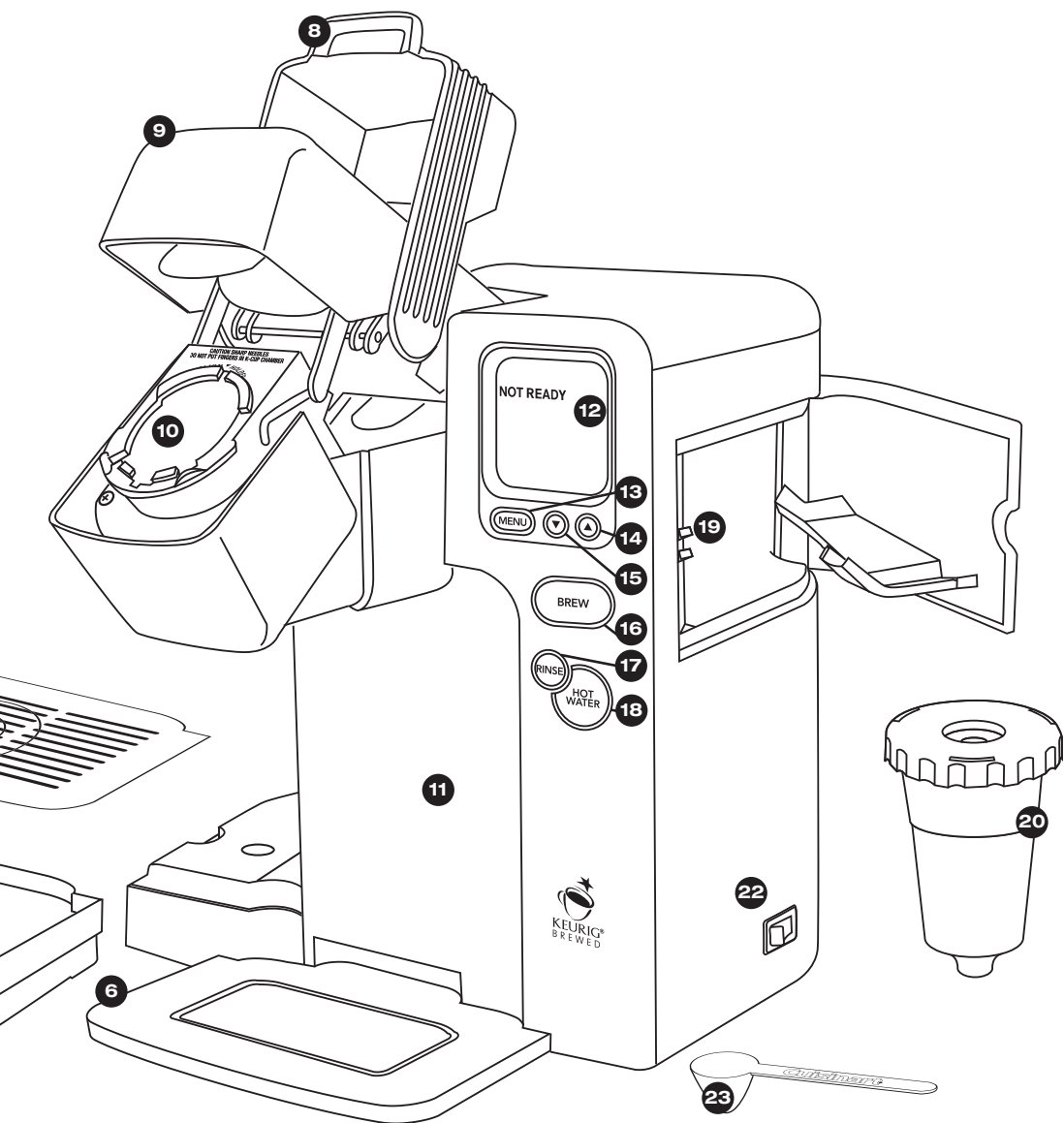

- |                             |  |
|-----------------------------|--|
| <b>12. Control Panel</b>    | <b>19. My K-Cup® Compartment</b><br>Conveniently stores My K-Cup®. |
| <b>13. Menu Button</b>      | <b>20. My K-Cup® Reusable<br/>Coffee Filter</b>                    |
| <b>14. Up Button (▲)</b>    | <b>21. Power Cord</b><br>(not shown)                               |
| <b>15. Down Button (▼)</b>  | <b>22. Power Switch</b><br>(located rear side of Brewer)           |
| <b>16. Brew Button</b>      | <b>23. Coffee Scoop</b>  |
| <b>17. Rinse Button</b>     |  |
| <b>18. Hot Water Button</b> |  |

## Set-Up & First Brew

**IMPORTANT:** Do not attempt to use your Cuisinart® Single Serve Brewing System until it has been set up for its first use as outlined below.

**NOTE:** If Brewer has been exposed to temperatures below freezing, wait at least two hours for Brewer to reach room temperature before brewing. An extremely cold Brewer will not operate.

## Setting Up Your Brewer

1. Unwrap cord and plug the Brewer into a grounded outlet. Make sure to remove packing tape, clear plastic sticker from control panel, and sticker from water reservoir. Also be sure to remove the polybag from the My K-Cup® located in the compartment on the right side of the brewer.
2. Place a large cup or mug (10 oz. minimum) on the drip tray.
3. Remove lid from reservoir, then lift reservoir straight up and away from the Brewer. Wash the reservoir with warm soapy water.
4. Fill reservoir with water to the max fill line and return with lid to unit (see figure 1).

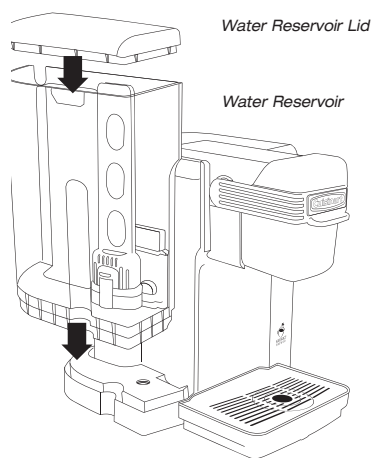

figure 1

5. Press the power switch located on the rear right side of the Brewer. The switch is spring-loaded and will return to original position automatically.

6. The Brewer will automatically fill the internal tank with water and heating will begin. This will take approximately 4 minutes. During the heating period, NOT READY will be displayed on the control panel (see figure 2).

Heating Mode



figure 2

**Note:** It is normal to see small amounts of water dripping into the water reservoir during this and subsequent heatings.

Once the water is heated, OPEN HEAD will be displayed.

7. When the control panel displays OPEN HEAD (see figure 3), open and close the brewing chamber. READY and brew size icons will be displayed with the default size shown as a solid mug (see figure 4).

Idle Mode

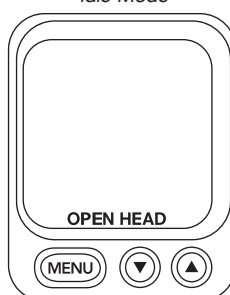

figure 3

Ready Mode



figure 4



8. Making sure your mug is in place, press the Brew button to start a cleansing cycle (unit will dispense approximately 8 oz. of water). The control panel will display BREWING, as well as the factory default brew size (see figure 5). When cycle is complete, dispose of the hot water.

**Note:** Do not use a K-Cup® for this cycle.

**The one-time set-up process is complete.**



figure 5

## Charcoal Water Filter

Your coffeemaker comes with a charcoal water filter that eliminates chlorine, bad tastes and odors from tap water.

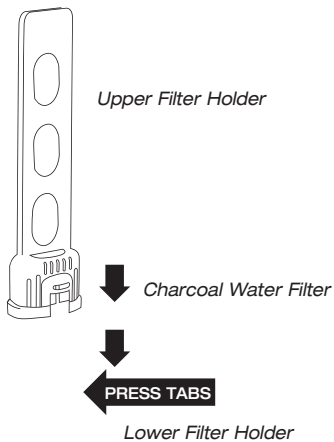

figure 6

## Inserting the Water Filter

1. Remove the filter and filter holder from the polybags.
2. Soak the filter, fully immersed in cold tap water, for 15 minutes.
3. Remove lower portion of filter holder by pressing the tabs on the sides and pulling apart. Rinse with fresh water.
4. Insert the charcoal filter into the upper filter holder, then attach the lower portion by pressing on tabs and pushing until it locks into place (see figure 6).

5. Flush filter by running fresh water through lower portion of the filter holder.
6. Allow the filter to drain completely.
7. Place the assembled water filter holder into the water reservoir, pushing it down to fit into place (see figure 7).

**Note:** We recommend changing the water filter every 60 days or after 60 uses, and more often if you have hard water. Replacement filters can be purchased in stores, by calling Cuisinart Customer Service, or at [www.cuisinart.com](http://www.cuisinart.com).

## Brewing

1. The control panel will display OPEN HEAD while in idle mode.
2. Place a cup or mug on the drip tray. The drip tray can be removed to accommodate travel mugs.
3. Lift the handle. The brewing chamber will open toward you.
4. Select a K-Cup® Portion Pack®.  
**Note:** Do not remove the foil lid or puncture the K-Cup®.
5. Place a K-Cup® in the brewing chamber (see figure 8).

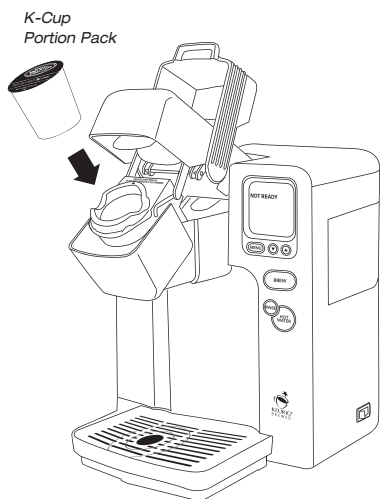

figure 8

**Caution:** There are two sharp needles that puncture the K-Cup®, one above and one below. To avoid risk of injury, do not put your fingers in the K-Cup® brewing chamber.

6. Lower the handle to close the brewing chamber. When closed completely, the control panel will indicate READY (see figure 9).

**Note:** If not used within 60 seconds, the unit will return to Idle mode and OPEN HEAD will be displayed on the control panel. To restart the process, open and close the handle and control panel will display READY again.



figure 9

7. All brew size icons will be displayed with the default size shown as a solid mug. To choose a different size, use the ▼ or ▲ buttons. Choose from 4-oz. (iced beverage), 6-oz., 8-oz., 10-oz., and 12-oz. brew sizes.

**Note:** The 8-oz. serving is the factory-set default brew size. To program your favorite brew size, see Programming Your Brew Size on page 18.

- a. Once a size is chosen, press Brew. Only the Brew button will be lit. The control panel will now display BREWING, as well as the serving size you selected (see figure 10).



figure 10

- b. To use the iced beverage setting, place a tall glass filled with ice on the drip tray. Use your favorite K-Cup®, select the iced beverage brew size (4 oz.) and press the Brew button. Once brewing is complete, add more ice; add cream and sugar if desired.

**Note:** There may be a short pause before the brewing process begins. The entire brew process lasts approximately 1 minute and ends with a burst of air to remove all liquid from the K-Cup®.

**Caution:** There is very hot water in the K-Cup® chamber during the brew process. To avoid risk of injury, do not lift the handle or open the K-Cup® chamber during the brew process.

8. Lift the handle, then remove and dispose of the used K-Cup®. Close the brewing head.

**Caution:** K-Cup® will be hot.

Following the brew, your Brewer will automatically fill and heat in preparation for the next brew. Your Brewer will display NOT READY. When water reaches default temperature, OPEN HEAD will be displayed on the control panel and your unit will return to Idle mode, and will be ready for your next brew.

**Enjoy your cup of gourmet coffee, tea, or hot cocoa!**

## Hot Water/Rinse

Your Brewer is equipped to dispense hot water to make hot chocolate, tea, soup, and more. Your Brewer is also equipped with a Rinse cycle to flush out residual flavors. The Rinse cycle will dispense about 4 oz. of hot water.

**Note:** We suggest to running the Rinse cycle before using hot water to flush out any residual coffee, tea or hot cocoa flavor.

### To Rinse:

1. Place a cup or mug on the drip tray. If you've just completed a Rinse or Hot Water cycle, proceed to step 4.
2. Lift the handle. The brewing chamber will open towards you; check to make sure there is no K-Cup® inserted.
3. Lower the handle to close the brewing chamber. When closed completely, the control panel will indicated READY.
4. Press Rinse. During the Rinse cycle, only the Rinse button will be lit. The control panel will display the word RINSE (see figure 11).

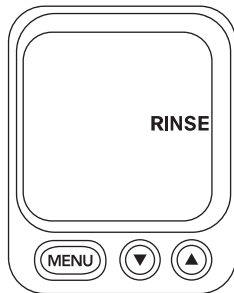

figure 11

Following the Rinse cycle, your Brewer will automatically fill and heat in preparation for the next cycle. Once the heat cycle is completed, the RINSE and HOT WATER buttons will remain lit for one minute. While buttons are lit, you can perform another Rinse cycle or dispense Hot Water without opening the brew chamber.

**Note:** To BREW directly after a Rinse cycle open the brewing head, insert a K-Cup and brew as normal.

### To make Hot Water:

1. Place a cup or mug on the drip tray. If you've just completed a Rinse or Hot Water cycle proceed to step 4.
2. Lift the handle. The brewing chamber will open towards you; check to make sure there is no K-Cup® inserted.
3. Lower the handle to close the brewing chamber. When closed completely, the control panel will indicated READY.
4. All brew-size icons will be displayed with your default size shown as a solid mug. To choose a different size, use the ▼ or ▲ buttons.
5. Press Hot Water. While the Hot Water cycle is in progress, only the Hot Water button will be lit. The control panel will display the words HOT WATER, as well as the serving size you selected (see figure 12).

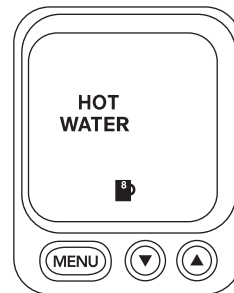

figure 12

Following the cycle, your Brewer will automatically fill and heat in preparation for the next cycle. After the heating cycle is completed, you can perform a Rinse or another Hot Water cycle immediately for up to one minute. The RINSE and HOT WATER buttons will be lit. After this time the unit will return to Idle mode and OPEN HEAD will be displayed.

**Note:** To BREW directly after a Hot Water cycle open the brewing head, insert a K-Cup and brew as normal.

# Brewing with the My K-Cup® Reusable Coffee Filter

The Cuisinart® Single Serve Brewing System comes with a My K-Cup® reusable coffee filter, which allows you to use your own ground coffee. The dishwasher-safe, My K-Cup® conveniently stores in the easy-open compartment.

1. Open the storage compartment located on the right side of the Brewer by pressing the finger indent. Remove the My K-Cup® (see figure 13).

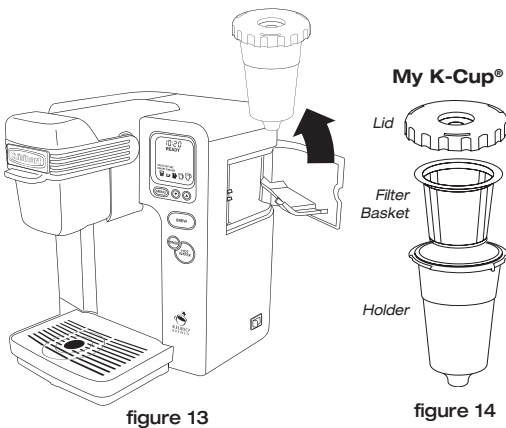

2. Disassemble the My K-Cup® by turning the lid from the holder in a counter-clockwise direction. Remove the filter basket from the holder (see figure 14).
3. Wash the My K-Cup® lid, filter basket and holder in warm soapy water prior to use, making sure to rinse and dry thoroughly. All My K-Cup® parts are dishwasher safe.
4. Insert the filter basket into the holder.
5. Fill the filter basket with ground coffee making sure not to fill past the top of the mesh. Adjust the amount to your personal preference. Do not tamp the grinds. Ensure there are no grinds remaining on the upper rim of the filter basket. Turn the lid clockwise to seal.
6. Raise the handle and the brew chamber will open toward you.

7. Remove the K-Cup® holder from the brewing chamber by pulling toward you. (If you would like, store the K-Cup® holder in the My K-Cup® storage compartment.)
8. Drop the assembled My K-Cup® into the brewing chamber. (No need to snap it into place). See figure 15.

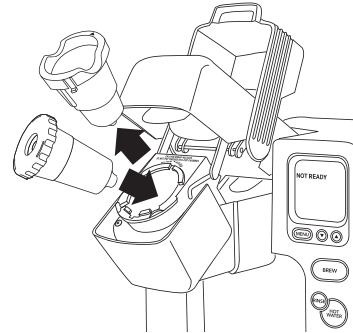

figure 15

**CAUTION: There are two sharp needles that puncture the K-Cup®, one above and one below. To avoid risk of injury, do not put your fingers in the K-Cup® brewing chamber.**

9. Follow Brewing instructions on page 10.
10. Following brewing raise the handle and remove the My K-Cup®. **Use caution as the My K-Cup® will be hot.**
11. Disassemble the My K-Cup® by turning the lid from the holder in a counter-clockwise direction. Remove the filter basket from the holder, discard the grounds and rinse out the filter basket and holder.
12. Replace the K-Cup® holder, ensuring the arrow on K-Cup® rim aligns with the arrow on the brewing chamber. Gently push the K-Cup holder to snap into place (see figure 16).

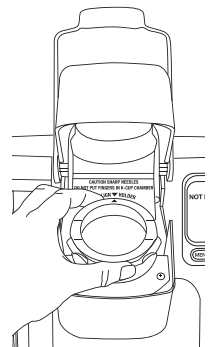

figure 16

---

## Stopping the Brew Process

If for any reason you need to stop brewing after the process has started, press the power switch on the rear right side of the Brewer to turn the Brewer off. The flow of coffee, tea or hot cocoa will stop, the heater will shut off, and the blue lights illuminating the control panel and reservoir will turn off.

**Note:** You may get less coffee, tea or hot cocoa in your cup during your next brew. In order for your next brew to be the volume you have selected, we recommend that you perform a rinse cycle after a terminated brew.

## Adding Water

The Control Panel will indicate when the water level in your reservoir is low or if the Reservoir has been removed by displaying the words "ADD WATER". The blue light in the Reservoir will also blink when water needs to be added. When "ADD WATER" is displayed, the Brewer will not allow you to brew.

### The Water Reservoir can be filled in two ways:

1. Lift off the Reservoir Lid and pour water directly into the Reservoir while it is still attached to the Brewer, then replace the Lid.
2. Remove the Reservoir from Brewer by first removing the Lid from the Reservoir then lifting the Reservoir straight up and away from Brewer. Fill with water, place the Reservoir back on the Brewer, and replace the Lid.

**IMPORTANT:** Do not remove the Water Reservoir during the brewing process.

## Purging the Brewer

If your Brewer has not been used for more than one week, we suggest purging the water from the inner tank.

1. If there is water in the reservoir, discard the water, then rinse and refill with fresh water. Place the reservoir back on the Brewer and replace the lid. (If there is no water in the reservoir, simply fill.)
2. Be sure the Brewer is turned on. Raise and lower the handle on the Brewer **without** inserting a K-Cup®.
3. When the control panel displays READY, dispense 12 oz. of hot water by selecting the 12-oz. cup size and hot water.
4. Repeat this process two more times to completely replace the water in the inner tank.

# Programming

## Setting the Clock

Setting the clock is optional. When the clock is set, the time will appear on the control panel. **Note:** You must set the clock if you plan on using the ON/OFF TIME SET programming feature.

1. Press the Menu button. Programming options will appear on the control panel with CLOCK flashing. The word OFF will appear at the top of the control panel to indicate that the clock is not set (see figure 17).

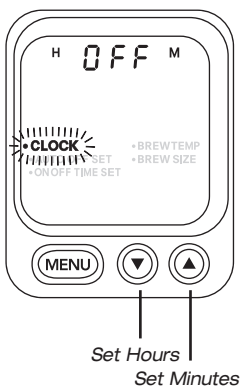

figure 17

2. Press or hold the ▼ button to scroll through the hours until you have reached the appropriate hour. Be sure the PM indicator is on if a PM time is desired.
3. Press or hold the ▲ button to scroll through the minutes until you have reached the desired minutes.
4. When you have reached the correct time, press the Menu button to set the time. Continue pressing Menu to scroll through the remaining programming functions to exit the programming mode.
5. The correct time should now be displayed on top of the control panel (see figure 18).

Clock set in READY Mode



figure 18

**Note:** Depending upon the Brewer's current mode, other icons will be displayed as well.

**Note:** If power is interrupted to the Brewer, the clock will need to be reset. Follow the procedure above to reset the clock.

## Programming On/Off Features

The Brewer provides three ways for you to enjoy gourmet coffee, tea or hot cocoa on your own schedule. It will take the Brewer approximately 3½ minutes to warm up from room temperature.

### 1. Leave it on all the time.

The Brewer can be left on all the time so that it is always ready to brew a fresh cup of gourmet coffee, tea or hot cocoa.

To turn the Brewer off at any time, simply press the power switch located on the right side of the Brewer.

**Note:** Although the clock remains on, if set, you cannot brew a cup of coffee, tea or hot cocoa if the brewer is off. Press the power switch to restore power to the Brewer. You will have to wait for the water to heat up before the Brewer is ready to brew.

## 2. Set the Brewer to AUTO OFF.

This will automatically shut the Brewer off after a specified period of time from the last brew.

- Press the Menu button until AUTO OFF SET flashes (see figure 19).

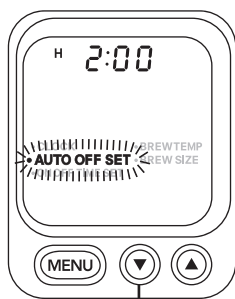

Set Hours  
figure 19

- Press or hold the ▼ button to advance one hour at a time, up to 9 hours.
- After setting the desired AUTO OFF TIME, press the Menu button to set the AUTO OFF TIME. Continue pressing Menu to scroll through the remaining programming functions to exit the programming mode.
- AUTO OFF SET will be displayed on the control panel, indicating that it has been successfully set (see figure 20).

*AUTO OFF Set in Ready Mode*



figure 20

**Note:** Depending upon the Brewer's current mode, other icons will be displayed as well.

- To turn off the AUTO OFF feature, press the Menu button until AUTO OFF SET flashes. Press the ▼ button to advance one hour at a time until OFF appears. Press the Menu button to scroll through the remaining programming functions to exit the programming mode.

## 3. Program your Brewer for a specific ON and/or OFF TIME.

By programming your Brewer to turn on each morning, you will never have to wait for the Brewer to warm up in order to brew a gourmet cup of coffee.

**Note:** To use this feature, the clock must be set to the correct time.

**Also Note:** the brewer must be turned off for the On Time to function.

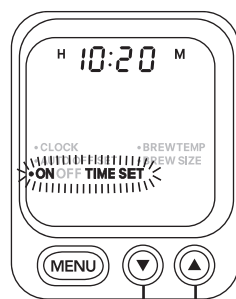

Set Hours  
Set Minutes  
figure 21

- Press the Menu button until ON TIME SET flashes (see figure 21).
- Press or hold the ▼ or ▲ button to scroll through the hours and minutes to your desired ON TIME. The ▼ button is used for hours and the ▲ button is used for minutes.
- After setting the desired ON TIME, press the Menu button once to save your selected ON TIME. You will now be in the OFF TIME SET MODE (see figure 22).



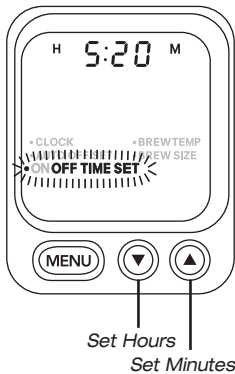

figure 22

- d. If you want to set an OFF TIME, Use the ▼ or ▲ buttons as above. If not, continue to Step e.
- e. To complete the process, press the Menu button to set the OFF TIME. Continue pressing to scroll through the remaining programming options to exit the programming mode.
- f. The ON TIME and OFF TIME functions operate independently from one another. The control panel will display ON TIME SET if the ON TIME has been set. The control panel will display OFF TIME SET if the OFF TIME has been set and the control panel will display ONOFF TIME SET if both the On and Off times have been set (see figure 23).

ON OFF TIME SET  
in Ready Mode



figure 23

**Note:** Depending upon the Brewer's current mode, other icons will be displayed as well.

- g. To turn off the ONOFF TIME SET feature, press the Menu button until ONOFF TIME SET flashes. Use the ▼ button to scroll through. The control panel will display OFF after 11 pm.

**Note:** The AUTO OFF timer and the OFF TIME programming options operate independently. If both are set, the unit will turn off at whichever time comes first.

## Programming Brew Temperature

The Brewer brews at a pre-set temperature of 192°F. If you prefer a cooler cup of coffee, hot water, tea, or cocoa, you may adjust this temperature down by 5 degrees. Simply follow the instructions below.

1. Press the Menu button until BREW TEMP flashes on the control panel (see figure 24).

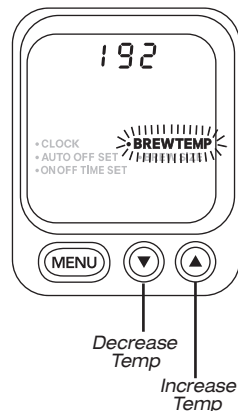

figure 24

2. The initial set temperature of 192°F will be displayed at the top of the control panel. Use the ▼ to lower or ▲ to raise the temperature one degree at a time.

**Note:** If at maximum temperature (192°F), only the ▼ button will work, and if at minimum (187°F) temperature, only the ▲ arrow will work.

3. Once you have reached your optimal brew temperature, press the Menu button to set your default brew temperature. Continue pressing Menu to scroll through the remaining

programming options to exit the programming mode.

**Note:** At high altitudes (over 5,000 feet) use the temperature adjustment to lower the temperature.

## Programming Your Brew Size

The Brewer's default brew size preset is 8 oz. The default brew size lets you choose the brew size most often used.

To change the default brew size to your desired brew size:

1. Press the Menu button until BREW SIZE flashes (see figure 25).
2. Use ▼ or ▲ buttons to select your default brew size.
3. Once the desired default brew size is selected, press the Menu button to set your default brew size and exit the programming mode.

The control panel will display your selected default brew size.

**Note:** You can always select another size prior to brewing.

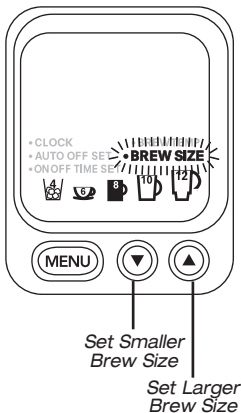

figure 25

## Cleaning & Maintenance

### Cleaning External Parts

We recommend regular cleaning of the Brewer's external components.

1. Never immerse the Brewer in water or other liquids. The housing and other external components may be cleaned with a soapy, damp, non-abrasive cloth.
2. To remove the drip tray, simply slide it toward you, keeping it level at all times in order to prevent spills. The drip tray and drip tray plate are dishwasher safe.

### Cleaning the My K-Cup® Reusable Coffee Filter

1. Open the storage compartment located on the right side of the Brewer by pressing the finger indent. Remove the My K-Cup®.
2. Disassemble the My K-Cup® by turning the lid from the holder in a counter-clockwise direction. Remove the filter basket from the holder (see figure 26).
3. Wash the My K-Cup® lid, filter basket and holder in warm soapy water making sure to rinse and dry thoroughly. All My K-Cup® parts are dishwasher safe.

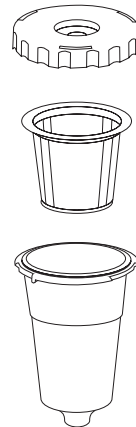

figure 26

## Cleaning the K-Cup® Holder

1. The K-Cup® holder is top-shelf dishwasher safe (use low temperature cycles in the dishwasher). To remove, lift the handle to open the brewing chamber. Grasp the top of the K-Cup® holder and pull towards you. After cleaning, replace the K-Cup® holder, being sure to align the arrow on the K-Cup® holder rim with the arrow on the brewing chamber.
2. Cleaning the Funnel – The Funnel can be removed from the K-Cup Holder by pulling on it until it pops off (see figure 27). The Funnel is top-rack dishwasher safe. To replace it, just snap it back onto the K-Cup Holder Assembly.

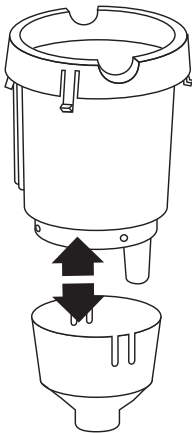

figure 27

3. Cleaning the Exit Needle – The Exit Needle is located on the inside bottom of the K-Cup Holder Assembly. Should a clog arise due to coffee grinds, it can be cleaned using a paper clip or similar tool. Remove K-Cup Holder (as shown in figure 27). Insert the paper clip (see figure 28) to loosen the clog and push it out.

**CAUTION:** There are sharp needles that puncture the K-Cup above and below. To avoid risk of injury, do not put your fingers in the K-Cup Assembly Housing.

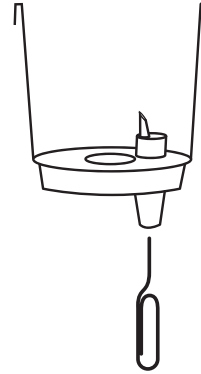

figure 28

## Cleaning the Water Reservoir & Lid

Neither the reservoir lid nor the reservoir should be put into the dishwasher. Clean them with a damp, soapy, non-abrasive cloth and rinse thoroughly. Do not dry the inside of the water reservoir with a cloth, as lint may remain.

**Caution: Rinse the water reservoir thoroughly after cleaning to ensure that no cleaners or cleaning solutions remain in this area, as they may contaminate the Brewer's water supply.**

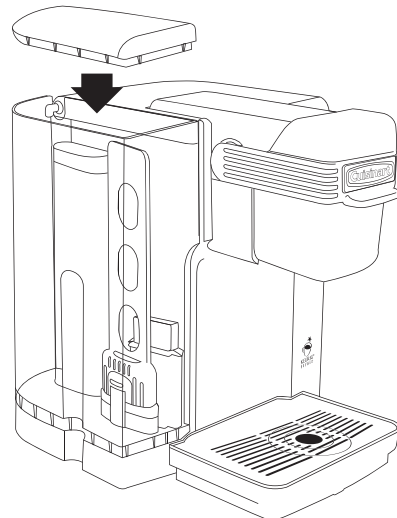

figure 29

## De-Scaling your Brewer

Mineral content in water varies from place to place. Depending on the mineral content of the water in your area, calcium deposits or scale may build up in your Brewer. Though scale is non-toxic, it can hinder Brewer performance. De-scaling your Brewer will help maintain the heating element and other Brewer parts that come in contact with water.

For optimal performance, de-scale your Brewer every 3 to 6 months. It is possible for calcium deposits to build up faster, making it necessary to de-scale more often.

This Brewer is equipped with sensors to detect when scale buildup is interfering with the performance of the Brewer. When this is detected, DE-SCALE will be displayed on the control panel (see figure 30), at which point you should promptly de-scale. However, even if DE-SCALE is not displayed, it is still advisable that you de-scale your Brewer regularly.



figure 30

**Note:** Though the Brewer will continue to function even when DE-SCALE is displayed, not de-scaling at that point could damage the Brewer. If this occurs, DE-SCALE will begin to flash on the control panel to alert you to potential damage if you do not de-scale immediately.

## Follow these steps to de-scale your unit:

1. Empty the reservoir.
2. Disable the AUTO OFF and OFF TIME features.
3. Making sure there is no K-Cup in the brewing chamber, fill the reservoir with 60 oz. of undiluted white vinegar.
4. Place a large mug on the drip tray and run a Hot Water cycle. Select the 12 oz. brew size. Discard contents of mug.
5. Repeat the hot water process until ADD WATER is displayed on the control panel and the reservoir lights will flash.
6. Let the Brewer stand for at least four hours while still on.
7. Rinse the water reservoir thoroughly and fill with fresh water.
8. Run another Hot Water cycle. Discard contents of large mug.
9. Repeat hot water process until ADD WATER is displayed on the control panel and the reservoir lights will flash.
10. You may need to perform additional Hot Water cycles if you detect any residual vinegar taste.

**Note:** If DE-SCALE is still displayed on the control panel after completing the procedure, repeat the de-scaling procedure above.

# Troubleshooting

<b>Problem:</b>	<b>Solution:</b>
Brewer does not have power.	Plug Brewer into an independent outlet.
	Make sure the Brewer is securely plugged in.
	Plug into a different outlet.
	Reset your home's circuit breaker.
	Confirm the power has been turned on and the LCD is illuminated.
Brewer will not brew.	Every once in a while an air bubble may get trapped in the water path. Lift off the reservoir, then put it back into place.
	Turn off and unplug the brewer for 30 seconds or more. When you plug the brewer back in, be sure to turn the power back on.
	Make sure the water reservoir is properly in place, and perform a Rinse cycle.
	After placing the K-Cup® in the K-Cup® Holder, make sure the handle is pushed down securely and the LCD control panel reads READY. The ▼ and ▲ buttons, Brew, Hot Water, and Rinse buttons will be illuminated. Then press any of the lit buttons.
	If the LCD control panel indicates ADD WATER, check to make sure the water reservoir is properly filled. If not, add water. If so, make sure the water reservoir is properly seated in its base.
	If the LCD control panel indicates ADD WATER even after refilling and checking the base, contact Customer Service at 1-800-726-0190.
	The exit needle may be clogged (refer to page 19).
Chlorine or mineral taste in coffee.	Consider using bottled water, filtered water or the Cuisinart Charcoal Water Filter.
Doesn't brew a full cup.	Every once in a while an air bubble may get trapped in the water path. Lift off the reservoir, then put it back into place.
	Turn off and unplug the brewer for 30 seconds or more. When you plug the brewer back in, be sure to turn the power back on.
	The exit needle may be clogged (refer to "Cleaning & Maintenance" page 18).
	Clean the K-Cup® holder brewing chamber (refer to "Cleaning & Maintenance" page 18).
	Make sure the water reservoir is properly in place, and perform a Rinse cycle.
	De-scale the Brewer (refer to page 20).
	If you have repeated the de-scale procedure two times and it is still only brewing a partial cup, contact Customer Service at 1-800-726-0190.
The time is not displayed on the LCD control panel.	You must set the clock (refer to page 15) in order for the time to be displayed on the LCD.
	If power is interrupted to the Brewer, you will need to re-set the clock (refer to page 15).
Brewer shuts off, or turns on, automatically.	Make sure the Auto Off and the On/Off time features have not been set. To do this, press the Menu button and scroll through the programming options. OFF should be displayed for Auto Off timer and On/Off. If OFF is not displayed, you must reset (refer to page 15).
The blue light in the water reservoir is flashing.	This indicates the water level in the reservoir is low and water must be added (refer to page 14) in order to brew a full cup.
Coffee is too weak or watery.	Reduce the brew size for a stronger-tasting cup of coffee (refer to "Programming Your Brew Size" on page 18). Try an Extra Bold K-Cup®. It has 30% more ground coffee in each portion pack.

---

## WARRANTY

### LIMITED THREE-YEAR WARRANTY

This warranty is available to consumers only. You are a consumer if you own a Cuisinart® Single Serve Brewing System that was purchased at retail for personal, family or household use. Except as otherwise required under applicable law, this warranty is not available to retailers or other commercial purchasers or owners.

We warrant that your Cuisinart® Single Serve Brewing System will be free of defects in materials and workmanship under normal home use for 3 years from the date of original purchase.

We recommend that you visit our website, [www.cuisinart.com](http://www.cuisinart.com) for a fast, efficient way to complete your product registration. However, product registration does not eliminate the need for the consumer to maintain the original proof of purchase in order to obtain the warranty benefits. In the event that you do not have proof of purchase date, the purchase date for purposes of this warranty will be the date of manufacture.

If your Cuisinart® Single Serve Brewing System should prove to be defective within the warranty period, we will repair it, or if we think necessary, replace it. To obtain warranty service, simply call our toll-free number, 1-800-726-0190, for additional information from our Customer Service Representatives, or send the defective product to Customer Service at Cuisinart, 150 Milford Road, East Windsor, NJ 08520.

To facilitate the speed and accuracy of your return, please enclose \$10.00 for shipping and handling of the product.

Please pay by check or money order (California residents need only supply proof of purchase and should call 1-800-726-0190 for shipping instructions).

**NOTE:** For added protection and secure handling of any Cuisinart product that is being returned, we recommend you use a traceable, insured delivery service. Cuisinart cannot be held responsible for in-transit damage or for packages that are not delivered to us. Lost and/or damaged products are not covered under warranty. Please be sure to include your return address, daytime phone number, description of the product defect, product model number (located on bottom of product), original date of purchase, and any other information pertinent to the product's return.

Your Cuisinart® Single Serve Brewing System has been manufactured to the strictest specifications and has been designed for use with the authorized accessories and replacement parts.

This warranty expressly excludes any defects or damages caused by accessories, replacement parts, or repair service other than those that have been authorized by Cuisinart.

This warranty does not cover any damage caused by accident, misuse, shipment or other ordinary household use.

This warranty excludes all incidental or consequential damages. Some states do not allow the exclusion or limitation of these damages, so these exclusions may not apply to you.

#### **CALIFORNIA RESIDENTS ONLY:**

California law provides that for In-Warranty Service, California residents have the option of returning a nonconforming product (A) to the store where it was purchased or (B) to another retail store that sells Cuisinart products of the same type.

The retail store shall then, at its discretion, either repair the product, refer the consumer to an independent repair facility, replace the product, or refund the purchase price less the amount directly attributable to the consumer's prior usage of the product. If the above two options do not result in the appropriate relief to the consumer, the consumer may then take the product to an independent repair facility if service or repair can be economically accomplished. Cuisinart and not the consumer will be responsible for the reasonable cost of such service, repair, replacement, or refund for nonconforming products under warranty.

California residents may also, according to their preference, return nonconforming products directly to Cuisinart for repair, or if necessary, replacement, by calling our Customer Service Center toll-free at 1-800-726-0190.

Cuisinart will be responsible for the cost of the repair, replacement, and shipping and handling for such products under warranty.

#### **BEFORE RETURNING YOUR CUISINART PRODUCT**

If you are experiencing problems with your Cuisinart product, we suggest that you call our Customer Service Center at 1-800-726-0190 before returning the product to be serviced. If servicing is needed, a representative can confirm whether the product is under warranty and direct you to the nearest service location.

**Important:** If the nonconforming product is to be serviced by someone other than Cuisinart's Authorized Service Center, please remind the servicer to call our Customer Service Center at 1-800-726-0190 to ensure that the problem is properly diagnosed, the product serviced with the correct parts, and the product is still under warranty.

---

---

# Cuisinart®

SAVOR THE GOOD LIFE®



Coffeemakers



Food Processors



Toasters



Blenders



Cookware



Ice Cream Makers

Cuisinart offers an extensive assortment of top quality products to make life in the kitchen easier than ever. Try some of our other countertop appliances and cookware, and Savor the Good Life®.

**[www.cuisinart.com](http://www.cuisinart.com)**

©2010 Conair Corporation  
Cuisinart® is a registered  
trademark of the Conair Corporation

Cuisinart  
150 Milford Road  
East Windsor, NJ 08520

Printed in China

Any trademarks or service marks of third parties used herein are the trademarks or service marks of their respective owners.

10CE13186

Keurig, the Cup and Star logo, Keurig Brewed, Quiet-Brew Technology, and K-Cup are trademarks or registered trademarks of Keurig, Incorporated. Covered by U.S. patents numbered 7,165,488; 7,398,726; 7,347,138; 7,377,162 and 7,360,418; and other U.S. and foreign patents and patents pending.

G IB-9178B



Version no : IB-9178B

Fold Size: 228MMX152MM Saddle Stitched 24PP

Material: Cover: 157gsm matt art Paper

Inside: 120gsm gloss art Paper

Coating: Gloss Varinishing In Cover

Color (Front): Cover: 4C(CMYK)+1C(BK)

(Back): Inside: 1C(BK)+1C(BK)

Date: APR-12-2010 Co-ordinator : Scias Liu

### Hugo Description

PDF version : SS700 IB-9178B(0,1) BOOK

Hugo Code : SMT0022IB-1B1

Color Series: Non Operator : Kin

Remark: Quality request(1)

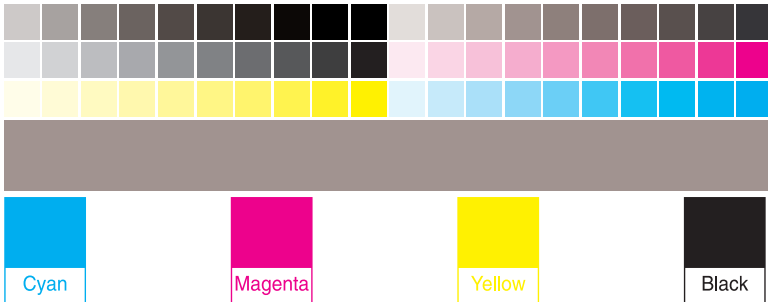

## Free Manuals Download Website

<http://myh66.com>

<http://usermanuals.us>

<http://www.somanuals.com>

<http://www.4manuals.cc>

<http://www.manual-lib.com>

<http://www.404manual.com>

<http://www.luxmanual.com>

<http://aubethermostatmanual.com>

Golf course search by state

<http://golfingnear.com>

Email search by domain

<http://emailbydomain.com>

Auto manuals search

<http://auto.somanuals.com>

TV manuals search

<http://tv.somanuals.com>