



ENCORE 1350/3350HR TREADMILL

OWNER'S MANUAL

Model Name: _____

Serial Number _____

Purchase Date _____

Write down for future reference.
Model Name & Serial Number located
on frame opposite the power cord.

Keys Technical Service, (888) 340-0482

Proudly made in the USA by:

KEYS Fitness Products, LP

P.O. Box 551239

Dallas, Texas 75239

PART# 15-0115



Table of Contents



Information	Page #
Table of Contents	2
Specification Sheet	3
Important Safety Information	4
Before You Start	5
Warm Up Exercises	6
Assembly Instructions	7
Power Requirements	8
Console Functions and Descriptions	9
Program and Operating Instructions	10, 11, & 12
Program Descriptions and Profiles	13
Belt Adjustments and Tension	14
Change to MPH or Km/H	15
Maintenance Instructions	16
Troubleshooting Guide	17
Parts and Diagrams	18
Parts List	19
Warranty Registration (Mail In Form)	20

	<u>EC1350</u>	<u>EC3350HR</u>
◆Horsepower (Continuous)	2.0hp	2.0hp
◆Display Type	5 Window LED	5 Window LED
◆ Electronics	Push Button	Push Button
◆Pre-Set Programs	4	4
◆Semi-Custom Programs	8	8
◆User Programs	2	2
◆Heart Rate Program	0	1
◆Heart Rate Interactive	No	Yes
◆Power Incline	12%	12%
◆Roller Diameter	1.9"	1.9"
◆Cushioned Deck	Yes	Yes
◆Speed Range	0-10mph	0-10mph
◆Walking Belt	18 x 51"	18 x 51"
◆Side Hand Rails	Yes	Yes
◆Foot Print	29 x 67"	29 x 67"
◆Warranty Motor	10 Years	10 Years
◆Warranty Parts	2 Years	3 Years
◆Warranty Labor	2 Year	2 Year
◆Warranty Frame	Lifetime	Lifetime

- 1) **WARNING!** Before using this treadmill or starting any exercise program, consult your physician. This is especially important for persons over the age of 35 and/or persons with pre-existing health problems. The manufacturer or distributor assumes no responsibility for personal injury or property damage sustained by or through the use of this product.
- 2) **WARNING!** To reduce the risk of electrical shock, burns, fire, or other possible injuries to the user, it is important to review this manual and the following precautions *before* operation.

SAFETY PRECAUTIONS AND TIPS

- ◆ It is the owner's responsibility to ensure that all users of this treadmill have read the Owner's Manual and are familiar with warnings and safety precautions.
- ◆ This treadmill has a user maximum capacity of 275 pounds.
- ◆ The treadmill should only be used on a level surface and is intended for indoor use only. The treadmill should not be placed in a garage, patio, or near water and should never be used while you are wet. KEYS recommends a treadmill mat be placed under the treadmill to protect floor or carpet and for easier cleaning.
- ◆ Follow safety information in regards to plugging in your treadmill. Keep the power cord away from the incline wheels and do not run the power cord underneath your treadmill. Do not operate the treadmill with a damaged or frayed power cord.
- ◆ Wear comfortable, good-quality walking or running shoes and appropriate clothing. Do not use the treadmill with bare feet, sandals, socks or stockings.
- ◆ Always straddle the belt and allow it to start moving before stepping onto the belt.
- ◆ Hold on to handrails when adjusting speed, incline, or other controls.
- ◆ Always examine your treadmill before using to ensure all parts are in working order.
- ◆ Allow the belt to fully stop before dismounting.
- ◆ Pets should never be allowed near or on the treadmill.
- ◆ Do not leave children unsupervised near or on the treadmill.
- ◆ Never operate the treadmill where oxygen is being administered, or where aerosol products are being used.
- ◆ Never insert any object or body parts into any opening.
- ◆ For safety and to prevent damage to your treadmill, no more than one person should use the treadmill at a time.
- ◆ Always unplug the treadmill before cleaning and/or servicing. Service to your treadmill should only be performed by an authorized service representative, unless authorized and/or instructed by the manufacturer. Failure to follow these instructions will void the treadmill warranty.
- ◆ Never leave the treadmill unattended while it is running.

Before You Start



Thank you for purchasing a KEYS treadmill! This quality product you have chosen was designed to meet your needs for cardiovascular exercise.

Before you start, please read the Owner's Manual and become familiar with the operation of your new treadmill.

- ◆ **Remember to take the time to perform the stretching exercises provided to avoid injury.**
- ◆ Do not stand on the walking belt while pressing the Power button or Start/Stop button.
- ◆ Always adjust the speed of the treadmill in small increments as this treadmill is capable of high speeds.
- ◆ If you are taking medication, consult your physician to see if the medication will affect your exercise heart rate.
- ◆ If you have heart problems, you are not active, and/or are over the age of 35 years, do not use the pre-set treadmill programs or start an exercise program without first contacting and receiving approval from your physician.
- ◆ To avoid the risk of electrical shock, always keep the console dry. Do not spill liquids on the console. KEYS recommends a sealed water bottle for beverages consumed while using the treadmill.
- ◆ **Please review the following drawing below to familiarize yourself with the listed parts. This manual covers several treadmills, so the one pictured below may not be identical to your particular model.**

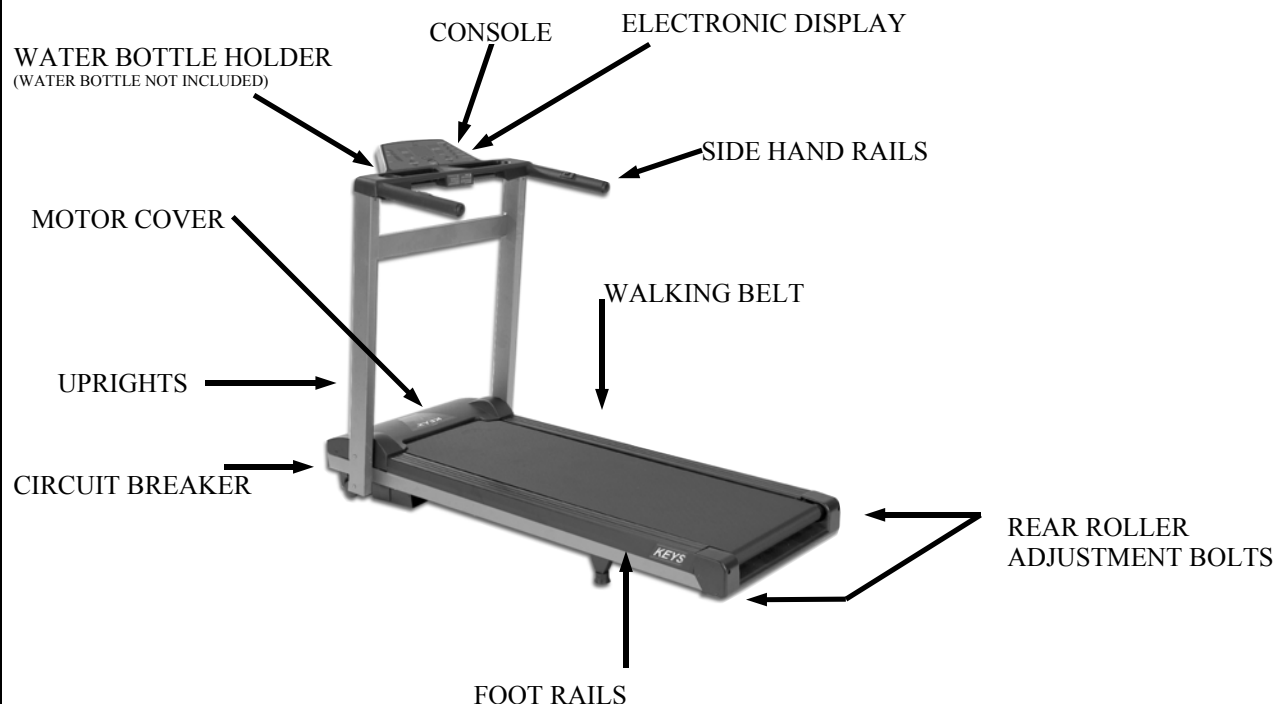

EXERCISE GUIDELINES

WARNING! Before beginning this or any exercise program, you should consult your physician. This is especially important for individuals over the age of 35 or individuals with pre-existing health problems.

Warming up prepares the body for the exercise by increasing circulation, supplying more oxygen to the muscles and raising body temperature. Begin each workout with 5 to 10 minutes of stretching and light exercise to warm up. The photos on this page show several forms of basic stretching you may perform before your workouts. In order to achieve an adequate warm-up, perform each stretch three times.

TOE TOUCH STRETCH

Stand bending your knees slightly and slowly bend forward from your hips. Allow your back and shoulders to relax as you reach down toward your toes as far as possible. Hold for 15 counts, then relax. This will stretch your hamstrings, back of knees, and back.



HAMSTRING STRETCH

Sit with one leg extended. Bring the sole of the opposite foot toward you and rest it against the inner thigh of your extended leg. Reach toward your toes as far as possible. Hold for 15 counts, then relax. This will stretch your hamstrings, lower back, and groin.



CALF/ACHILLES STRETCH

With one leg in front of the other, reach forward and place your hands against a wall. Keep your back leg straight and your back foot flat on the floor. Bend your front leg, lean forward and move your hips toward the wall. Hold for 15 counts, then relax. To cause further stretching of the Achilles tendon, bend your back leg as well. This will stretch your calves, Achilles tendons, and ankles.



QUADRICEPS STRETCH

With one hand against a wall for balance, reach back and grasp one foot with your other hand. Bring your heel as close to your buttocks as possible. Hold for 15 counts, then relax. This will stretch your quadriceps and hip muscles.



INNER THIGH STRETCH

Sit with the soles of your feet together and your knees outward. Pull your feet toward your groin area as far as possible. Hold for 15 counts, then relax. This will stretch your quadriceps and hip muscles.

KEYS treadmills are shipped in three pieces to make assembly easy. After opening the box, remove any packing materials from the treadmill. You should find a rear endcap (large plastic piece that fits over the rear roller area), and owner's manual packet with bolts and screws for assembly. Do not throw away any packing materials until the unit is working properly. Place the base on a clean, level surface. Make sure the electrical cord will easily reach an electrical outlet.

Figure 1 – Assembly for main uprights

- 1) Have a second person raise the console to the upright position and hold.
- 2) Insert 3/4" Button Head Bolt into upright bracket and tighten loosely. Repeat for opposite side.
- 3) Insert the TUBE SPACER inside the upright frame and line up with the bottom hole. Hold tube spacer while inserting the 1 1/2" Button Head Bolt and lightly tighten. Repeat for opposite side.
- 4) After completing opposite side, tighten all four assembled bolts and the two other button head bolts that were present before starting. Assembly is now complete.
- 5) Be sure to attach the RED SAFETY KEY before turning the power on.

Figure 2 – Assembly for rear end cap

To attach the rear end cap:

- 1) Place plastic rear end cap over exposed rear roller area.
- 2) Align holes in plastic end cap with pre-drilled holes in frame.
- 3) Loosely tighten each screw until all four screws are lined up.
- 4) Tighten all four screws snugly.

CAUTION: DO NOT OPERATE TREADMILL WITHOUT SECURING REAR ROLLER HOUSING!!!

Be sure the treadmill is level to the floor. The rear feet can be adjusted to level the treadmill. Assembly is now complete!

Figure 1

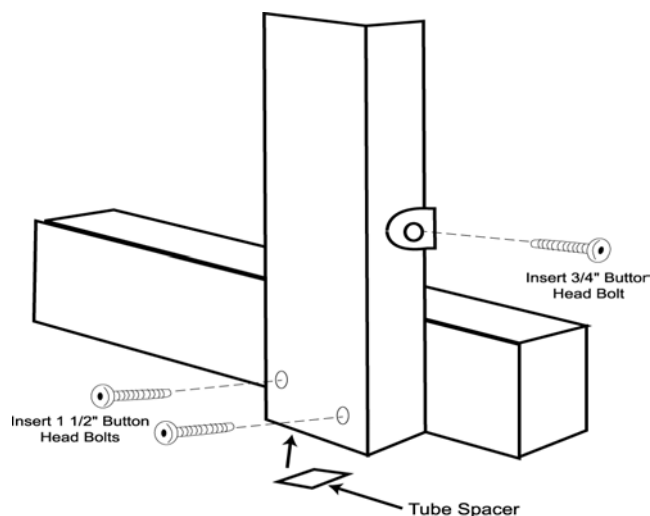
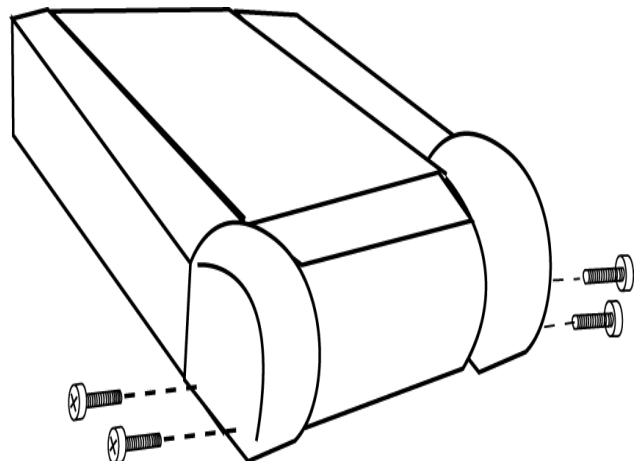

Figure 2



Power Requirements



IMPROPER CONNECTION OF THE EQUIPMENT GROUNDING CONNECTOR CAN RESULT IN A RISK OF AN ELECTRIC SHOCK. CHECK WITH A QUALIFIED ELECTRICIAN OR SERVICE MAN IF YOU ARE IN DOUBT AS TO WHETHER THE PRODUCT IS PROPERLY GROUNDED. DO NOT MODIFY THE PLUG PROVIDED WITH THE PRODUCT IF IT WILL NOT FIT THE OUTLET. HAVE A PROPER OUTLET INSTALLED BY A QUALIFIED ELECTRICIAN.

This treadmill can be seriously damaged by sudden voltage changes in your home's electrical power. Voltage spikes, surges, and noise interference can result from weather conditions or from other appliances being turned on or off. To reduce the possibility of treadmill damage, always use a surge protector (not included) with your treadmill.

Surge protectors can be purchased at most hardware stores. The manufacturer recommends a single outlet surge protector with UL 1449 rating as a Transient Voltage Surge Suppressor (TVSS) with UL suppressed voltage rating of 400V or less and an electrical rating of 120VAC, 15 amps.

This treadmill must be grounded to reduce the risk of electrical shock. Grounding provides a path of least resistance for electric current should the treadmill malfunction. This treadmill comes with an electrical cord with an equipment-grounding conductor and a grounding plug. Always plug the power cord into a surge protector, and plug the surge protector into an appropriate outlet that is properly installed and grounded in accordance with all local codes and ordinances.

This product is for use on a nominal 120-volt circuit and has a grounding plug that looks like the plug illustrated in the drawing below.

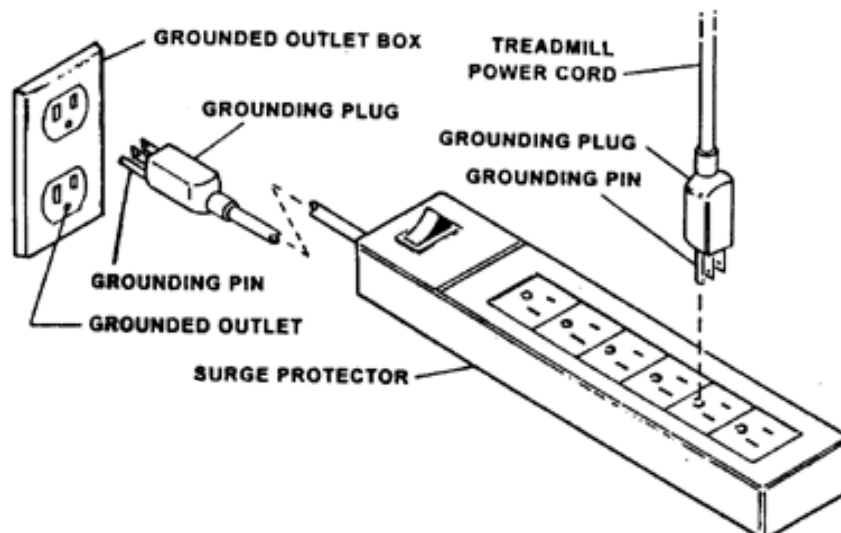

Console Functions and Descriptions



There are five display windows on the control panel to provide feedback information.

WORKOUT TIME

- ◆ **TIME:** Indicates elapsed time after pressing start in minutes and seconds (0-99 minutes, 0-59 seconds)
- ◆ **INTERVAL TIME:** Indicates countdown in seconds to the next interval starting at 5 seconds and counting to 0 seconds

SPEED WINDOW

- ◆ **SPEED:** Indicates MPH (miles per hour) or KMH (kilometer per hour) in .1 increments

DISTANCE / CALORIES WINDOW

- ◆ **DISTANCE:** Indicates Miles or Kilometers traveled in .01 increments up to 9.99 and .1 increments starting at 10.0
- ◆ **CALORIES:** Indicates estimated calories used based on 150 lb. person at the indicated speed, incline, and time

INCLINE WINDOW

- ◆ **INCLINE:** Indicates incline in percent of grade 0-12% in 0.5 increments

CENTER BRICKYARD WINDOW

- ◆ Displays quarter mile track in Manual mode. Indicates position on track by a blink. In program mode, shows the change in speed profile across the interval range (1-10) and shows position with a blinking action.
- ◆ In Program mode, the treadmill will display the name of the program selected This is shown on the left hand side of the window. In Manual mode, the LAP counter will appear in the top center of the window, counting each 1/4 mile lap in sequence of completion (1, 2, 3, etc.)

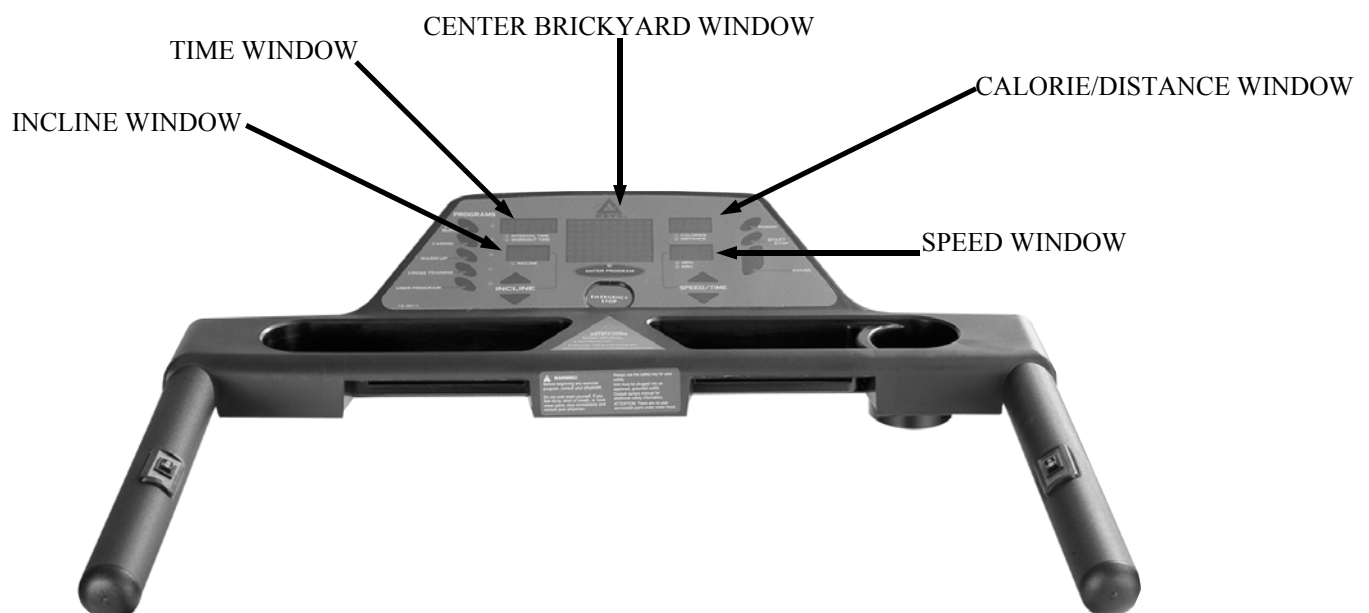

Program and Operating Instructions



QUICK START / MANUAL MODE

- ◆ Plug into a standard wall outlet (110-Volt AC, 15-amp circuit).
- ◆ Attach RED Safety Key to the center of treadmill console.
- ◆ Stand on the treadmill and straddle belt.
- ◆ Press POWER button. There will be an eight (8) second delay after pressing the POWER button before data can be entered. The TIME window will flash.
- ◆ Press START/STOP button. Belt will begin to move after 4 seconds. Step on belt slowly after the belt starts moving. Speed or incline may be adjusted by using the appropriate + (increase) or – (decrease) buttons.
- ◆ **To end your workout**, press START/STOP button. Belt will gradually slow to zero.
- ◆ **To pause your workout**, press PAUSE.
- ◆ **To re-start after pausing**: Press the PAUSE button. **WARNING**: The treadmill belt will resume at the speed the treadmill was moving before pausing.
- ◆ **Countdown Time, Preset Speed and/or Incline**: Time, Speed, and Incline may be preset prior to getting started. After pressing the POWER button, the time window will blink. Use the SPEED/TIME + or – arrows to select your workout time, then press the ENTER PROGRAM button. The SPEED/TIME window will now be flashing. Using the same + or – arrows, select the speed for your workout, then press ENTER PROGRAM. Now the INCLINE window will be flashing. Use the INCLINE + or – arrows to set your workout incline, then press ENTER PROGRAM. To start, press the START/STOP button.

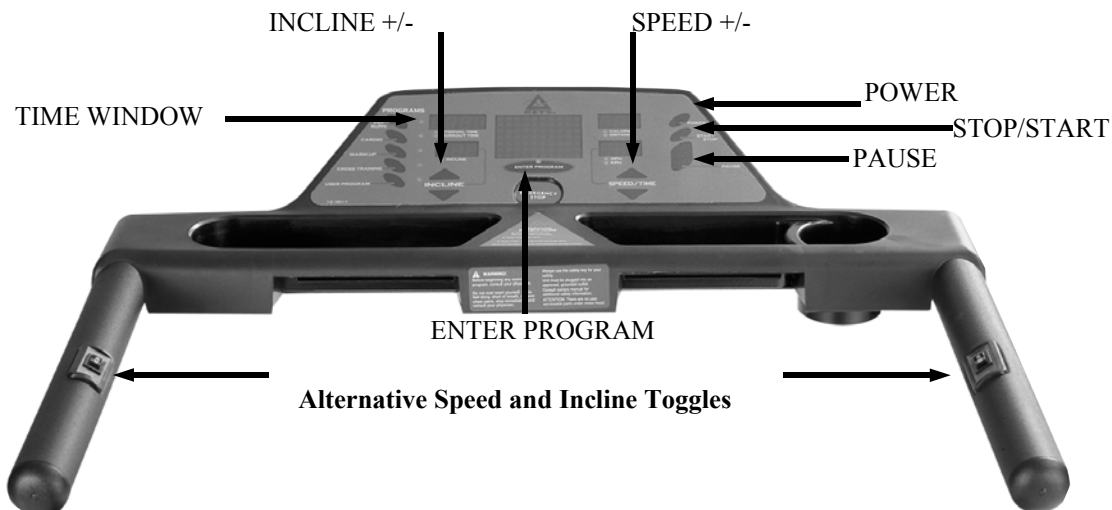

PROGRAM MODE-FOR THE EC1350

- ◆ Plug treadmill into a surge protector outlet . Attach RED Safety Key to treadmill console.
- ◆ Stand on the treadmill and straddle belt. Attach safety key clip to your clothes.
- ◆ Press POWER button. There will be an eight (8) second delay before data can be entered. The TIME window will flash.
- ◆ There are four (4) pre-set and eight (8) custom pre-set programs on the EC1350 and EC3350HR. The treadmills include FAT BURN, CARDIO, WARM-UP, and CROSS TRAINING programs. Select the program by pressing the appropriate button.
- ◆ Press START/STOP button. Belt will begin to move after 4 seconds. Step on belt slowly after the belt starts moving.
- ◆ Each of the pre-set programs can also be customized for your particular workout.
- ◆ **CUSTOMIZING PROGRAMS in P1 and P2 Mode:** Each pre-set program(Fat Burn, Cardio, Warm-up, Cross Training) can be customized in the P1 or P2 mode. After making the program selection, the Calorie window will read “OP.” The ”OP” refers to “original program” and is preset. The program name you select will display to the left of the “OP”. Press the same program button once more and the Calorie window will read P1. The “P1” mode is now accessed. You can now program the Time, Speed, and Incline in P1 mode, which will be saved for future workouts.
 - 1) The TIME window will blink. Use the SPEED/TIME + or – arrows to select your workout time. Press ENTER PROGRAM.
 - 2) The SPEED/TIME window will then blink. Use the same + or – arrows to select the speed for your workout. Press ENTER PROGRAM.
 - 3) The INCLINE window will then blink. Use the INCLINE + or – arrows to set your workout incline. Press ENTER PROGRAM.To start, press the START/STOP button. To access P2 mode, press the selected program button three times (once for OP, twice for P1, three times for P2). Follow the above steps 1-3 to customize P2 settings.
- ◆ **TO CHANGE A PREVIOUSLY PROGRAMMED P1, P2, or user program:** Once you have programmed the P1 or P2 modes, you will need to use the PAUSE button to change the program you previously entered. For instance to change to a new setting in P1-FAT BURN, press the FAT BURN button twice to access P1. Then press the PAUSE button to get the TIME window to flash. Follow the directions above to continue to change the program.

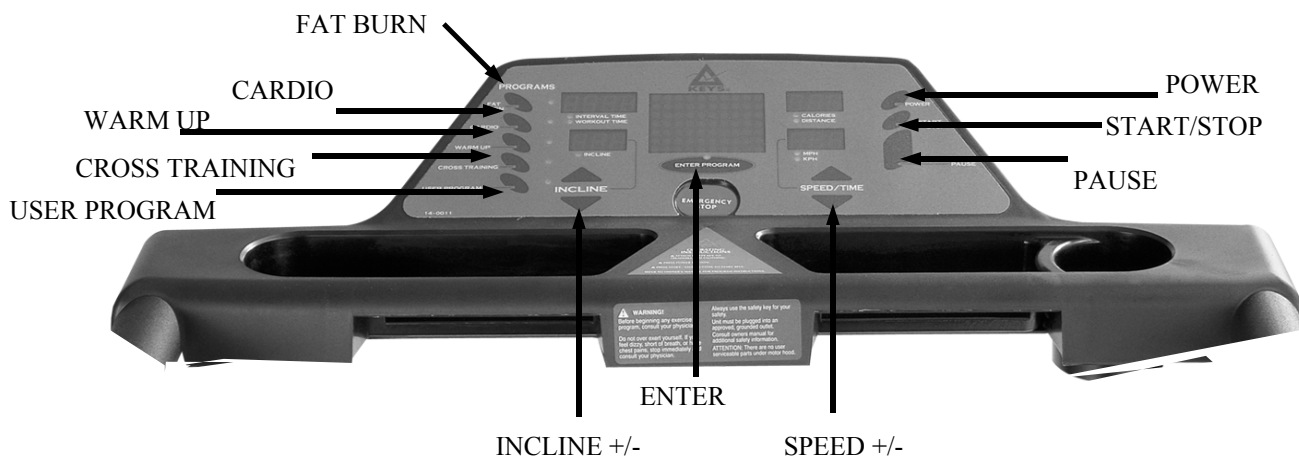

◆ Heart Rate Control Instructions (EC3350 only)

◆ HEART RATE PROGRAM MODE

- ◆ The Heart Rate program is designed to keep your heart rate a desired level of “beats per minute” by automatically adjusting the incline. For example, if you have programmed in a desired heart rate of 105 beats per minute and your heart rate is only 95 beats per minute (you must be wearing Heart Rate Transmitter), the incline will automatically increase to intensify the work load, and increase you heart rate to the 105 beats per minute you programmed.
- ◆ If your heart rate is above your programmed amount of beats per minute the incline will automatically decrease to lower your heart rate. You may at any time during the Heart Rate Program adjust/override the speed and or incline by simply pressing the correct corresponding buttons. You may change your “Target Heart Rate” at any time during the program by pressing the TARGET + or TARGET – buttons.
- ◆ Plug into a standard wall outlet (110-Volt AC, 15-amp circuit). Attach RED Safety Key to console
- ◆ Place the Heart Rate transmitter strap across chest against the skin. Stand on the treadmill and straddle belt.
- ◆ Press POWER button. There will be an eight (8) second delay after pressing the POWER button before data can be entered. The TIME window will flash. The “Heart” shape on the treadmill will be flashing if the Heart Rate Transmitter is transmitting. Adjust the strap on the chest until the console is picking up a signal.
- ◆ For Quick Start, press START/STOP button. Belt will begin to move after 4 seconds. Step on belt slowly after the belt starts moving. Speed or incline may be adjusted by using the appropriate + (increase) or – (decrease) buttons. Heart rate will read out in the Incline window.
- ◆ To select the Heart Rate Control program, press the “Heart Rate Program” button.
- ◆ The incline window will flash “125”, which is the default program target heart rate.
- ◆ Adjust Target Heart Rate to desired level with the TARGET + or – buttons.
- ◆ Press START/STOP button, or continue instructions below to program Time, and Speed.
- ◆ You can now program the Time and Speed. The time window will blink. Use the SPEED + or – arrows to select your workout time, then press the ENTER PROGRAM button. The SPEED window will now be flashing. Using the SPEED + or – arrows, select the maximum speed for your workout, then press ENTER PROGRAM. To start, press the START/STOP button.

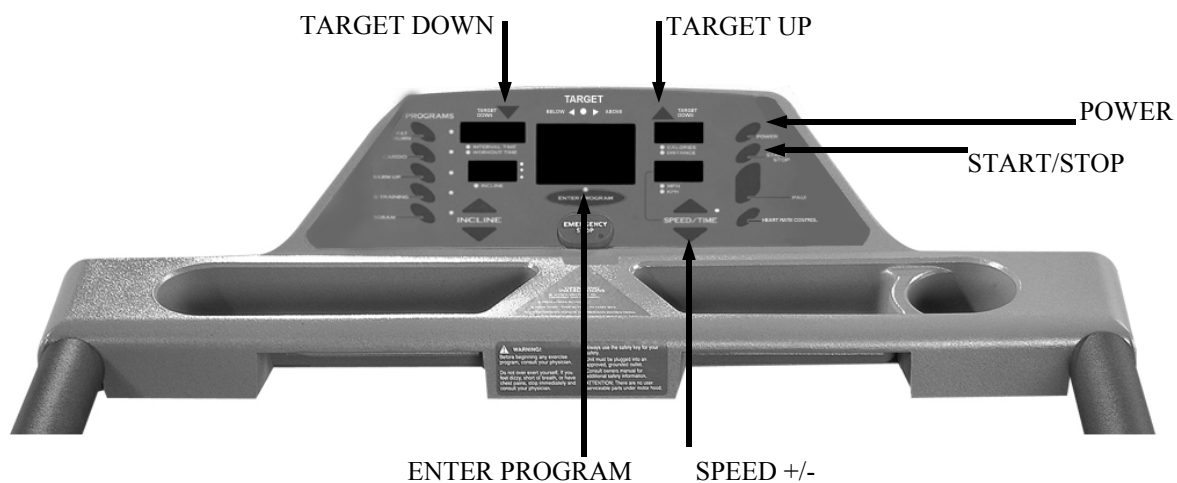

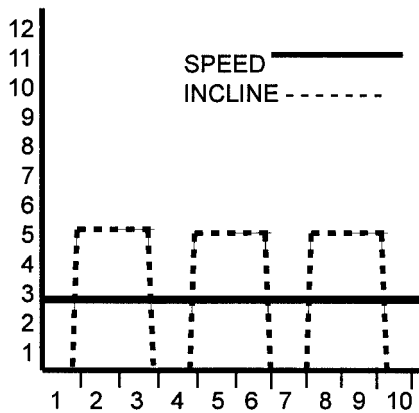

The Fat Burn Program is designed to vary treadmill elevation while maintaining a constant walking belt speed.

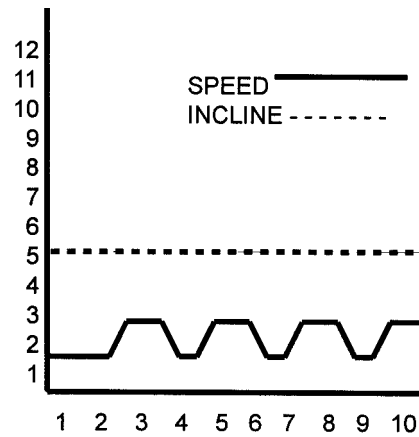

The Cardio Program is designed to vary treadmill speed while maintaining a constant elevation.

Each program contains 10 segments or intervals. For instance, a 30 minute program will have 10 three-minute segments (30 minutes divided by 10). Also, each preset program may be customized for speed, incline, or both. Please see "Program and Operating Instructions" to customize each program.

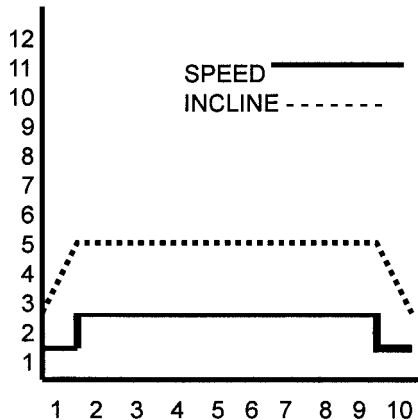

The Warm Up Program is designed to gradually increase treadmill Speed and elevation in the first segment (warm up), and gradually decrease speed and elevation in the last segment (cool down).

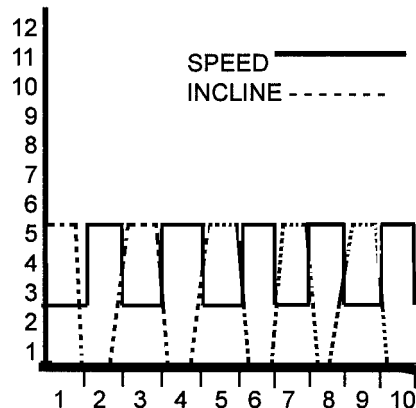

The Cross Training Program is designed to alternate between the programmed speed and incline. The program will alternate between: 1) the full programmed incline and half the programmed speed, to 2) zero incline and the maximum programmed speed.

Belt Adjustment and Tension

WARNING! Do not overtighten rollers! This will cause premature roller bearing failure!

Belt adjustment and tension performs two functions: adjustment for tension and centering. Your new treadmill comes pre-adjusted from the factory for tension and centering. Please follow the procedures below if the belt shifts to the left or right while walking:

WALKING BELT IS SHIFTING TO THE LEFT (Diagram 1)

First, turn treadmill on to run at 1 mph. Using the hex key provided, turn the left rear roller adjustment bolt $\frac{1}{4}$ turn in the clockwise direction. Next, run the treadmill at 2.5 mph. You should see the belt start to correct itself by moving back towards the center. Repeat the above procedure until the walking belt is centered. It may be necessary to set walking belt tension once you have completed this procedure if the belt feels like it is slipping while walking. Refer below to the “Walking Belt Slipping” instructions.

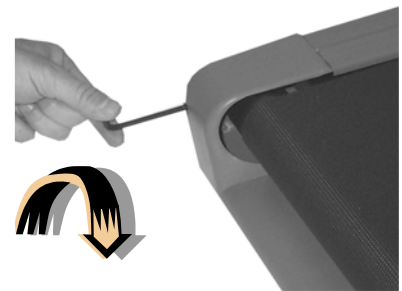

WALKING BELT IS SHIFTING TO THE RIGHT (Diagram 2)

First, turn the treadmill on to run at 1 mph. Using the hex key provided, turn the right rear roller adjustment bolt $\frac{1}{4}$ turn in the clockwise direction. Next, run the treadmill at 2.5 mph. You should see the belt start to correct itself, moving back towards the center. Repeat the above procedure until the walking belt is centered. It may be necessary to set walking belt tension once you have completed this procedure if the belt feels like it is slipping while walking. Refer below to the “Walking Belt Slipping” instructions.



WALKING BELT IS SLIPPING DURING USE (Diagram 3)

First, unplug the power cord from the surge protector. Using the hex key provided, turn both left and right rear roller adjustment bolts the same distance, usually a $\frac{1}{4}$ turn in the clockwise direction. Plug the power cord back into the surge protector and run the treadmill at 2.5 mph. You should now walk on the belt to determine if the belt is still slipping. Repeat the above procedure until the walking belt is not slipping. The tension should be just tight enough not to slip.

- Turning the hex key counter clockwise brings the rear rollers and belt towards you.
- Turning the hex key clockwise pushes the rear roller and belt away from you.

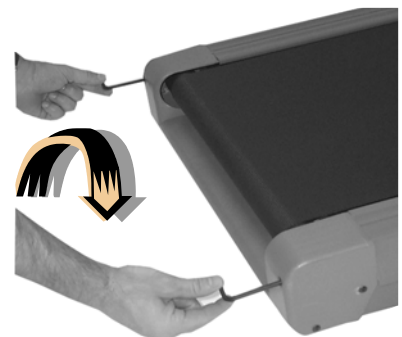

Change Miles per hour to Kilometers per hour



Your treadmill will operate in British Units (miles per hour) or International Units (kilometers per hour). All treadmills are calibrated at the factory for British Units (miles per hour). To change the display to read in kilometers, follow the steps described here:

- 1) Turn power OFF on the console. (Do not unplug treadmill) Attach the magnet safety key to the console.
- 2) Activate the calibration mode switch by inserting the eraser end of a pencil into the opening in the backside of the console (see diagram below).
- 3) Depressing the calibration mode switch ONCE; CL11 should appear in the TIME window.
- 4) Pressing the SPEED +/- button will activate your choice.
- 5) To accept the setting, press the POWER button.



WARNING! Before performing any maintenance to your treadmill, always unplug the power cord from the surge protector.

CLEANING: Routine cleaning of your treadmill will extend the life of your treadmill. **WARNING!** To prevent electrical shock, be sure the power to the treadmill is OFF and the unit unplugged from the wall electrical outlet before attempting any cleaning or maintenance.

AFTER EACH WORKOUT: Wipe off the console and other treadmill surfaces with a clean, water dampened soft cloth to remove excess perspiration. **USE NO CHEMICALS.**

WEEKLY: Use of a treadmill mat is recommended for ease of cleaning. Dirt from your shoes contacts the belt and eventually makes it to underneath the treadmill. Vacuum underneath treadmill once a week.

DECK LUBRICATION: The walking belt has been pre-lubricated at the factory. However, it is recommended that the walking board be checked periodically for lubrication to ensure optimal treadmill performance. Your treadmill should not have to be lubricated usually within the first year or 500 hours of use. If you have questions, call us at (888) 340-0482.

Every 30 days or 30 hours of operation, lift the sides of the walking belt and feel the top surface of the walking board as far under as you can reach. If you feel signs of silicone, no further lubrication is required. If it feels dry to the touch, follow the instructions below.

Please use Lube 'N Walk (can be purchased from your dealer or call the number on the front of the manual), or a non-petroleum based silicone such as "Napa 8300" (available at most stores).

TO APPLY LUBRICANT TO THE WALKING BOARD

- 1) Position the walking belt so that the seam is located on top and in the center of the center of the walking board.
- 2) Insert the spray nozzle into the spray head of the lubricant can.
- 3) While lifting the side of the walking belt, position the spray nozzle between the walking belt and the board approximately 6" from the front of the treadmill. Apply the silicone spray to the walking board, moving from the front of the treadmill to the rear. Repeat this on the other side of the belt. Spray approximately 4 seconds on each side.
- 4) Allow the silicone to 'set' for one minute before using the treadmill.

WARNING: Do not overlubricate the walking board. Excess lubricant should be wiped off with a clean towel.

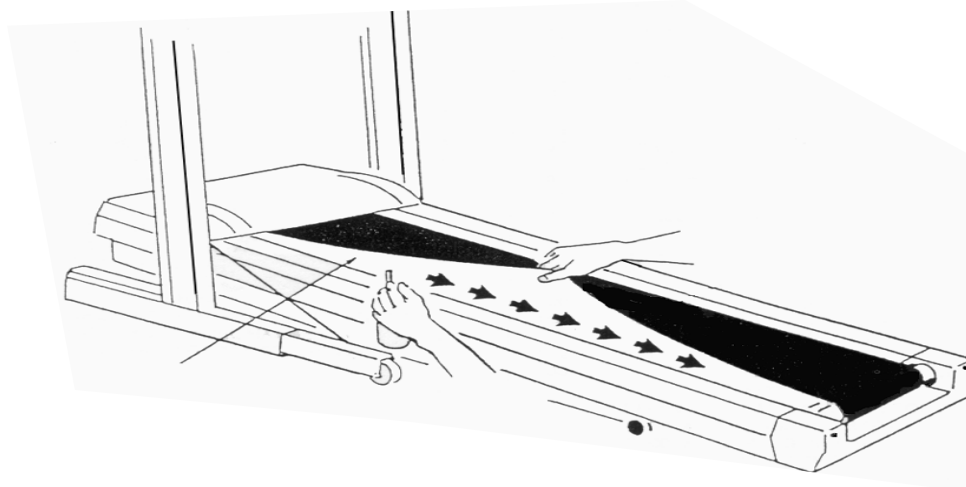

Treadmill will not start.

- 1) Is the RED Safety Key Attached to the Console?
- 2) Make sure the power cord is plugged into a surge protector, the surge protector is plugged into a properly grounded outlet, and the surge protector is turned on. (Refer to “Power Requirements”)
- 3) Check the circuit breaker located on the front of the treadmill. If the switch protrudes, it has tripped. Wait five minutes and then press the switch back in.
- 4) Check the house electrical breaker box and the circuit breaker for the room the treadmill is located in. If it has tripped, reset or have an electrician replace the breaker in home.
- 5) Have an electrician check for inadequate voltage at the outlet.

Treadmill loses power during use.

- 1) Check the circuit breaker located on the front of the treadmill. If the switch protrudes, it has tripped. Wait five minutes and then press the switch back in.
- 2) Check the house electrical breaker box and the circuit breaker for the room the treadmill is located in. If it has tripped, reset or have an electrician replace the breaker in home.
- 3) If treadmill still will not operate, please call Keys Technical Service at (888) 340-0482.

Treadmill walking belt slows during use.

- 1) Check to make sure the treadmill is securely plugged into an UL-listed surge protector, rated at 15 amps, with a 14-gauge cord of five feet or less and the surge protector is securely plugged into the outlet.
- 2) If treadmill still will not operate, please call Keys Technical Service at (888) 340-0482.

Treadmill walking belt slips or is not centered on rear roller.

- 1) Refer to “Belt Adjustment and Tension” section.
- 2) Need help? Call Keys Technical Service at (888) 340-0482.

Treadmill Error Messages.

2) Your treadmill is equipped with a software package that enables error messages to be displayed when there is a problem. **To avoid possible damage to the treadmill and the possibility of injury, do not operate the treadmill until the problem is corrected. Call Keys Technical Service at (888) 340-0482.**

1. 05-0020-Extrusion side board deluxe/left
2. 05-0019-Extrusion side board deluxe/right
3. 04-0012-Belt walk spliced 18 x 113" P33
4. 09-0012-Front roller assembly
5. 09-0013-Rear roller assembly
6. 03-0012-Walkboard
7. ??-????-End cap
8. 12-0022-Actuator 400lb Maytech
9. 06-0132-Motor base pan
10. 06-0080-Small motor fan
11. 12-0032-Motor MC#2917
12. 04-0004-Poly V belt 190J8
13. 06-0131-Motor cover w/wings
14. 10-0020-Foam grips
15. & 16. *EC1350-24-0108* Console assembly
15. & 16. *EC3350HR-??-????*-Console assembly
17. *EC1350-08-0050*-Motor controller
17. *EC3350HR-08-0050*-Motor controller

•Please review the following drawing below to familiarize yourself with the listed parts. This manual covers several treadmills, so the one pictured below may not be identical to your particular model.

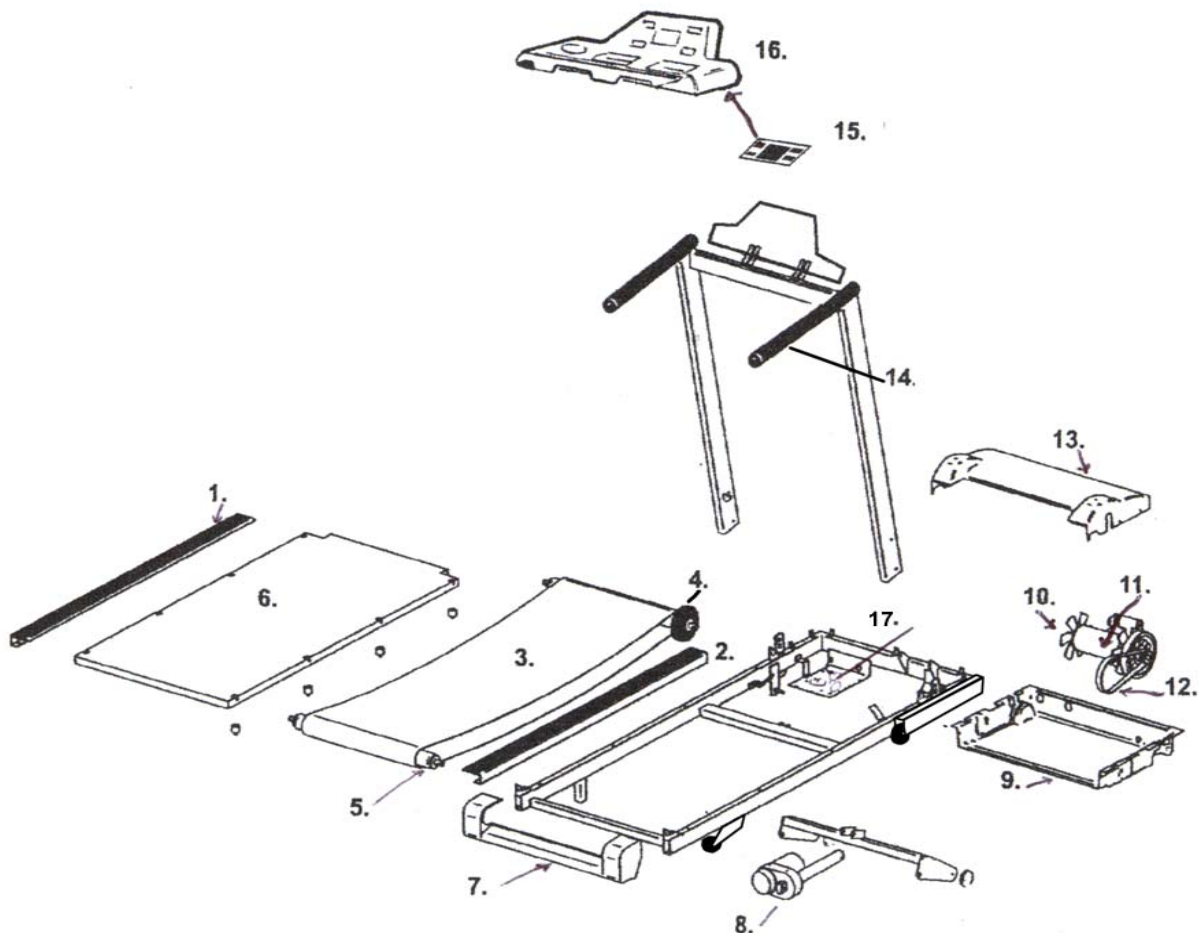

EC1350C/EC3350HR- Parts List



PART #	DESCRIPTION	QTY	PART #	DESCRIPTION	QTY	PART #	DESCRIPTION
02-0004	SCREW-8x5/8 PHIL PH AB BLACK	24	06-0022	GUIDE-RESET TUBE	1	17-0042	RECT 1x3x16GAx25 7/16
02-0005	SCREW-8x5/8 PPH HILO BLACK TPB	8	06-0024	CLIP-ALLEN WRENCH	2	17-0055	RECT-1x2x16GAx153 1/4"
02-0006	BOLT-HEX 5/16-18x5 1/2 GRADE 5-ZP	1	06-0039	WHEEL-KEYS SERIES-2.5"	2	17-0061	RECT 1 1/2x4x16Ax42 3/4"
02-0007	NUT 5/16-18 NYLOCKZP	5	06-0080	FAN 5"X8mm BORE SCREW ON	2	18-0006	SPRING-MOTOR TENSION-PRESET
02-0008	BOLT-CARRIAGE 5/16-18x3/4"GRADE 2-ZP	3	06-0088	SLEEVE-MOTOR TENSION 1/4"	2	18-0008	ROD 3/8x1 1/2"
02-0009	NUT-HEX 5/16 WIZ-FL-LK-ZP	3	06-0084	BAG-PLASTIC 12x12 3MIL-INST PACKET	1	19-0003	BRK-FRONT ROLLER
02-0013	WASHER LOCK 1/4"	8	06-0117	SWITCH HOUSING ROUND GRAY	2	19-0004	BRKT-REAR ROLLER
02-0014	BOLT-HEX 1/4-20x2 1/2" GRADE 5 ZP	9	06-0130	PULLEY MOLDED PLASTIC 1/9"	1	19-0007	BRKT-MOTOR TENSION
02-0015	WASHER-SPRING	2	06-0131	COVER FOR MOTOR-NON SES-VO	1	19-0012	BRKT-CONSOLE MOUNTING
02-0016	BOLT-HEX 3/8-16x2 1/2" GRADE 5	1	06-0132	PAN BOTTOM CONV VO	1	19-0015	BRACKET-MOTOR COVER
02-0017	NUT-NYLOCK HEX 3/8-16	2	07-0030	ELECTRONICS LED-5WIN-HRC	1	19-0019	GUIDE BELT GLAVANIZED
02-0018	NUT-PUSH 3/8 HAT BLACK 375012	2	08-0004	BREAKER-CIRCUIT-15AMP	1	19-0023	BRKT-UNIVERSAL
02-0020	SCREW-SHCS 1/4-20x2 1/2"	2	08-0027	SWITCH-REMOTE-W/HARNESS	2	19-0073	BRKT-ELEVATION PIVOT
02-0021	WASHER 9/32 5/8 1/8THICK ZP	2	08-0047	ENCODER-OPTICAL-ALEPH	1	19-0074	BRKT-ACTUATOR MOUNTING
02-0022	NUT-NYLOCK HEX 10-24	4	08-0050	CONTROLLER-REPLACES 08-0013	2	19-0076	BRKT-CONTROLLER
02-0024	CARRIAGE BOLT 5/16x1 GRADE 5 ZP	4	08-0077	CORE-ERRITE	1	19-0077	BRACE-CONTROLLER FRONT ELEVATION
02-0026	NUT-PUSH PZ 001996	1	09-0012	ROLLER-FRONT-20MM SHAFT	1	19-0079	BRKT-BELT GUIDE
02-0027	NUT-T HF 14209H-DB	8	09-0013	ROLLER-REAR-20MM SHAFT	1	19-0097	BRKT-ENCODER-McMILLAN
02-0028	SWITCH-MAGNETIC KILL-YIHAN	1	10-0006	TIP-CRUTCH 1" CNV	2	19-0105	BRKT-REAR LEG COVER
02-0030	SCREW-HEX TRILOBE 8-32x1/2"	1	10-0020	GRIP MOLDED ROUND	2	19-0106	BRK-LOWER ELEV GUSSET
02-0031	BOLT-HEX 3/8-16x1 3/4" GRADE 5ZP	1	10-0024	TAPE-ADHEISIVE 1'X108ft ST567	1	19-0134	BRKT-MORTO MOUNT
02-0033	WASHER-10# EXTERNAL STAR	1	10-0028	ISOLATOR BOARD 3/4"W/LG STUD	8	19-0143	BRKT LEFT STRAIGHT U/R
02-0036	SCREW-PPH 8x5/8 GREEN HEAD	1	11-0002	BUSHING-REAR ELEVAION	2	19-0144	BRKT RIGHT STRAIGHT U/R
02-0038	WRENCH-ALLEN 3/16 SHAFT ARM	1	11-0014	SPACER STEEL TUBE 1.343"	2	19-0147	BRKT FRONT ELEV-REWORK 19-0075
02-0040	RETAINER-GUIDE TUBE	1	11-0016	FYWHEEL 10MPH MCM	1	19-0159	BRKT MTOR SUPPORT REVISED 19-0005
02-0042	SCREW#8x5/8 SD BLACK	2	12-0022	ACTUATOR 400 LB-MAYTECK	1	19-0187	BRKT FRONT ELEV REVISED
02-0050	NUT-NYLOCK HEX 1/4-20	4	12-0023	MOTOR-MC#2917-10MPH-8MM SHAFT	1	20-0063	PROC-PUNCHED FRAMES LONGER17-0055
02-0053	SCREW-SHCS 1/4-20x3/4"	2	13-0003	HARNESS-ENCODER	1	20-0083	PROC RT U/R 17-00671
02-0054	SCREW-HWH MACH 8-32x3/8"LT HAND	1	13-0007	WIRE-BREAKER 6"	1	20-0084	PROC LT U/R 17-0061
02-0068	WASHER-FLAT SAE 5/16	2	13-0011	CORD-POWER-90"	1	20-0111	PROC H-BAR 17-0035
02-0082	SCREW-BUTTN HEAD 5/16-18x2 1/2'	2	13-0040	HARNESS CONTROL PANEL +6"	1	21-0001	FRAME BRACE-PUNCHED
06-0001	CONSOLE-LED	1	14-0019	OVERLAY CONSOLE LED-EC2500-GRY/TEAL/RE	1	21-0017	ACTUATOR X-TB-CORNERS CLIPPED(17-0031)
02-0092	SCREW-PHTR #8x3/4" AB BLACK	4	14-0026	DECAL-WARNING CONSOLE-ALL GRAY	1	21-0020	STIFFNER FOR CURVED U/R NOTCHED
02-0099	WASHER -SFW 3/8X7/8X1/8" THICK	1	14-0027	DECAL-EMERGENCY STOP-RED	1	22-0016	ACTUATOR X-TB SUB-ASSEMBLY
02-0103	BOLT-CARRIAGE 10-24x3/4"	4	14-0171	STICKER-MOTOR HR 2.0	1	22-0036	EXTENDED DECK FRAM ASSEMBLY 4"
02-0105	INDRTY-5/16-18 HEAVY WAL AVK	2	14-0028	DECAL CIRCUIT BREAKER ALL	1	22-0036	EXTENDED DECK FRAME ASSEMBLY 4"
02-0113	SCREW-HWH SLOTTED 8-18x3/4" AB ZP	1	14-0201	DECAL-CAUTION-OPER INST	1	22-0063	U/R SUB-ASSM
02-0123	WASHER-FENDER 1/4x1"	1	14-0204	DECAL CAUTION OPER INST	1	23-0050	FRONT ELEVATION ASSEMBLY
02-0125	SCREW-5/16-18x3/4"BUTTON HD BLACK	2	14-0205	DECAL DISCONNECT-MOTOR COVER	1	23-0067	EXTENDED DECK FRAME&REAR LEG ASSEM
02-0133	NUT RIV 5/16-18 AVKALS4-518-150	2	14-0321	DECAL-10YR MOTOR WARRANTY	1	23-0086	U/R ASSM W/STIFFNER TUBE
02-0137	PLUG PUSH-IN	2	14-0351	DECAL SPEED SERIGRAPH	1	24-0108	CONSOLE ASSEMBY-EC2500/EC1350C
03-0012	WLKBOARD KORETRON 4"LONGER W/OUT	1	14-0352	DECAL INCLINE SERIGRAPH	1	26-0099	INST PACKET EC1350C
04-0004	BELT-POLY V-190J8	1					
04-0012	WALKBELT-18"x113"-P33 1 PLY	1	14-0369	DECAL MTR COVER EC1350C	1		
05-0011	EXTRUSION-END CAP JOINT	1	15-0028	DIAGRAM-WIRING-McMILLAN	1		
05-0019	EXTRUSINS-RT SIDE BRD-DLX LONGER	1	15-0115	INST MANUAL EC 1350C/EC3350C	1		
05-0020	EXTRUSION-LT SIDE BRD-DLS-LONGER	1	17-0003	RECT 1x1x18GAx22.44	1		
06-0008	ENDCAP	1	17-0030	RECT 1x1x18GAx3 PUNCHED	2		
06-0014	BUSHING-STRAIN RELIEF #1237	1	17-0031	RECT 1x2x14GAx22 7/16	1		
06-0016	TIES-WIRE	1	17-0032	RECT 1x2x14GAx211/2	1		
06-0021	CLAMP WIRE 3367 7/16	1	17-0035	RND 1 1/2x16GAx42 3/4"	2		

KEYS 4000 Treadmill KEYS FITNESS PRODUCTS, LP – LIMITED WARRANTY

PLEASE CONSULT YOUR PHYSICIAN BEFORE USING THIS PRODUCT.

This Limited Warranty applies in the United States and Canada to products manufactured or distributed by Keys Fitness Products, LP ("Keys") under the KEYS brand name. The warranty period to the original purchaser on both the EC1350 and EC3350HR is (lifetime) on the frame, on the EC1350 is (10) years on the motor, (2) years on parts, and (2) years labor. The EC3350HR carries (10) years on the motor, (3) years on parts, and (2) years labor.

Keys warrants that the Product you have purchased for non-commercial, personal, family, or household use from Keys or from an authorized Keys reseller is free from defects in materials or workmanship under normal use during the warranty period. Your sales receipt, showing the date of purchase of the Product, is your proof of the date of purchase. This warranty only extends to you, the original purchaser. It is not transferable to anyone who subsequently purchases the Product from you. It excludes expendable parts. This Limited Warranty becomes VALID ONLY if the treadmill is assembled/installed by a Keys Fitness authorized dealer/technician unless otherwise authorized by Keys Fitness in writing (if anyone other than a Keys Fitness authorized dealer/technician assembles a Keys Fitness treadmill the warranty will be void unless accompanied by written authorization by Keys Fitness).

During the warranty period Keys will at no additional charge, repair or replace (at Keys' option) the product if it becomes defective, malfunctions, or otherwise fails to conform with this Limited Warranty under normal non-commercial, personal, family or household use. In repairing the Product, Keys may replace defective parts, or at the option of Keys, serviceable used parts that are equivalent to new parts in performance. All exchanged parts and Products replaced under this warranty will become the property of Keys. Keys reserves the right to change manufacturers of any part to cover any existing warranty.

To obtain warranty service, you must contact a Keys authorized service technician or Keys Fitness at our phone numbers located in this manual. Any parts determined to be defective must be returned to Keys to obtain warranty service. You must prepay any shipping charges, export taxes, custom duties and taxes, or any other charges associated with transportation of the parts or Product. In addition, you are responsible for insuring any parts or Product shipped or returned. You assume the risk of loss during shipment. You must present Keys with proof-of-purchase documents (including the date of purchase). Any evidence of alteration, erasing or forgery of proof-of-purchase documents will be cause to void this Limited Warranty.

This warranty does not extend to any product not purchased from Keys or from an authorized Keys reseller. This Limited Warranty does not extend to any Product that has been damaged or rendered defective; (a) as a result of accident, misuse, or abuse; (b) by the use of parts not manufactured or sold by Keys; (c) by modification of the Product or normal wear and tear; (d) operation on incorrect power supplies; or (e) as a result of service by anyone other than Keys, or an authorized Keys warranty service provider. Product on which the serial number has been defaced or removed is not eligible for warranty service. Should any Product be submitted for warranty service be found ineligible therefore, an estimate of repair cost will be furnished and the repair will be made if requested by you upon Keys' receipt of payment or acceptable arrangements for payment.

EXCEPT AS EXPRESSLY SET FORTH IN THIS WARRANTY, KEYS MAKES NO OTHER WARRANTIES, EXPRESSED OR IMPLIED, INCLUDING ANY IMPLIED WARRANTIES OF MERCHANTABILITY AND FITNESS FOR A PARTICULAR PURPOSE. KEYS EXPRESSLY DISCLAIMS ALL WARRANTIES NOT STATED IN THIS LIMITED WARRANTY. ANY IMPLIED WARRANTIES THAT MAY BE IMPOSED BY LAW ARE LIMITED TO THE TERMS OF THIS LIMITED WARRANTY. NEITHER KEYS NOR ANY OF ITS AFFILIATES SHALL BE RESPONSIBLE FOR INCIDENTAL OR CONSEQUENTIAL DAMAGES. SOME STATES DO NOT ALLOW LIMITATIONS ON HOW LONG AN IMPLIED WARRANTY LASTS OR THE EXCLUSION OR LIMITATION OF INCIDENTAL OR CONSEQUENTIAL DAMAGES, SO THE ABOVE LIMITATIONS OR EXCLUSION MAY NOT APPLY TO YOU. This Limited Warranty gives you specific legal rights and you may also have other rights that may vary from state to state. This is the only express warranty applicable to Keys-branded products. Keys neither assumes nor authorizes anyone to assume for it any other express warranty.

PLEASE SEND IN THE ATTACHED WARRANTY CARD WITHIN TEN (10) DAYS OF PURCHASE TO REGISTER YOUR TREADMILL WITH KEYS FITNESS PRODUCTS, LP. MADE IN THE USA. **Thank you for your business!** PLEASE MAIL WARRANTY CARD TO: KEYS FITNESS PRODUCTS, PO BOX 551239, DALLAS, TX 75355, Or register online at www.keysfitness.com.

KEYS FITNESS TREADMILL WARRANTY REGISTRATION			TELEPHONE	
FIRST	M.I.	LAST	<input type="text"/>	<input type="text"/>
<input type="text"/>	<input type="text"/>	<input type="text"/>	<input type="text"/>	<input type="text"/>
ADDRESS			APT. NO.	
<input type="text"/>			<input type="text"/>	
CITY		STATE	ZIP	
<input type="text"/>		<input type="text"/>	<input type="text"/>	
DATE OF PURCHASE		MODEL NO.	SERIAL NO.	
<input type="text"/>		<input type="text"/>	<input type="text"/>	
Name of store or company where purchased:	Where did you learn about treadmills? TV___ Radio___ Friend___	How important are each feature: Least Most		Other Comments:
How do you plan to use the treadmill? Walk___ Run___ Both___	In Store Display___ Salesperson___	Unique Features <input type="checkbox"/>	<input type="checkbox"/>	<input type="text"/>
Who will use the treadmill? Male___ Female___ Both___	Print ad/flyer___ Internet___	Horsepower <input type="checkbox"/>	<input type="checkbox"/>	
How many family members? ___	Why did you purchase a treadmill? Dr.'s Orders___ Loose Weight___	Warranty <input type="checkbox"/>	<input type="checkbox"/>	
AGE: 15-24___ 25-34___	In-home convenience___	Price <input type="checkbox"/>	<input type="checkbox"/>	
35-44___ 45-54___	Improve Cardiovascular Fitness___	Look/Design <input type="checkbox"/>	<input type="checkbox"/>	
55-64___ 65+___	Safety from outdoors___	Folding Feature <input type="checkbox"/>	<input type="checkbox"/>	KEYS FITNESS respects the rights of your privacy. Our company will not sell or distribute to others the information above. This information is used to track our product quality and to contact you in the event of a product safety concern. It may be used to offer you future Keys products only through the mail. Please check here if wish not to receive any additional information on Keys products. <input type="checkbox"/>
	Other ___			

Free Manuals Download Website

<http://myh66.com>

<http://usermanuals.us>

<http://www.somanuals.com>

<http://www.4manuals.cc>

<http://www.manual-lib.com>

<http://www.404manual.com>

<http://www.luxmanual.com>

<http://aubethermostatmanual.com>

Golf course search by state

<http://golfingnear.com>

Email search by domain

<http://emailbydomain.com>

Auto manuals search

<http://auto.somanuals.com>

TV manuals search

<http://tv.somanuals.com>