



**Alliance 855 / 888HR TREADMILL  
WITH ORTHOPEDIC BELT**

**OWNER'S MANUAL**

Model Name _____
Serial Number _____
Purchase Date _____
Fill in for future reference.

For Service, Please call (888) 340-0482

**Alliance Fitness Treadmills**

Manufactured in the USA by:

**KEYS Fitness Products, LP**  
P.O. Box 551239  
Dallas, Texas 75239  
(214) 340-8888



Information	Page #
-------------	--------

Table of Contents	2
Specification Sheet	3
Important Safety Information	4
Before You Start	5
Warm Up Exercises	6
Assembly Instructions	7
Power Requirements	8
Console Functions and Descriptions	9, 10, & 11
Program and Operating Instructions	12, 13, & 14
Program Descriptions and Profiles	15
Belt Adjustments and Tension	16
Change to MPH or KM	17
Troubleshooting Guide	18
Parts and Exploded View	19
Parts List	20
Warranty Registration (Mail In Form)	21

# Specification Sheet



	<u>ALL855</u>	<u>ALL888HR</u>
◆Horsepower (Continuous)	2.0hp	3.0hp
◆Display Type	5 Window LED <i>Green Display w/Pace</i>	5 Window LED <i>Green Display w/Pace</i>
◆Electronics	One-Touch	One-Touch
◆Pre-Set Programs	4	4
◆Custom Programs	10	10
◆Heartrate Programs	0	2
◆Speed/Incline Toggles	Yes	Yes
◆Speed/Incline Speed bar	Yes	Yes
◆Power Incline	0-15%	0-15%
◆Roller Diameter	2.5"	2.5"
◆Cushioned Deck	Yes	Yes
◆Speed Range	0-10mph	0-12mph
◆Ortho-Belt Size	20x56 "	20x56"
◆Side Hand Rails	Yes	Yes
◆Foot Print	29x71"	29x71"
◆Warranty Motor	10 Years	10 Years
◆Deck and Belt	5 Years	5 Years
◆Warranty Parts	3 Years	3 Years
◆Warranty Labor	1 Year	1 Year
◆Warranty Frame	Lifetime	Lifetime

◆ **WARNING!** Before using this treadmill or starting any exercise program, consult your physician. This is especially important for persons over the age of 35 and/or persons with pre-existing health problems. The manufacturer or distributor assumes no responsibility for personal injury or property damage sustained by or through the use of this product.

◆ **WARNING!** To reduce the risk of electrical shock, burns, fire, or other possible injuries to the user, it is important to review this manual and the following precautions *before* operation.

## ◆ SAFETY PRECAUTIONS AND TIPS

- ◆ It is the owner's responsibility to ensure that all users of this treadmill have read the Owner's Manual and are familiar with warnings and safety precautions.
- ◆ This treadmill has a user maximum capacity of 400 pounds.
- ◆ The treadmill should only be used on a level surface and is intended for indoor use only. The treadmill should not be placed in a garage, patio, or near water and should never be used while you are wet. KEYS recommends a treadmill mat be placed under the treadmill to protect floor or carpet and for easier cleaning.
- ◆ Follow safety information in regards to plugging in your treadmill. Keep the power cord away from the incline wheels and do not run the power cord underneath your treadmill. Do not operate the treadmill with a damaged or frayed power cord.
- ◆ Wear comfortable, good-quality walking or running shoes and appropriate clothing. Do not use the treadmill with bare feet, sandals, socks or stockings.
- ◆ Always straddle the belt and allow it to start moving before stepping onto the belt.
- ◆ Hold on to handrails when adjusting speed, incline, or other controls.
- ◆ Always examine your treadmill before using to ensure all parts are in working order.
- ◆ Allow the belt to fully stop before dismounting.
- ◆ Pets should never be allowed near or on the treadmill.
- ◆ Do not leave children unsupervised near or on the treadmill.
- ◆ Never operate the treadmill where oxygen is being administered, or where aerosol products are being used.
- ◆ Never insert any object or body parts into any opening.
- ◆ For safety and to prevent damage to your treadmill, no more than one person should use the treadmill at a time.
- ◆ Always unplug the treadmill before cleaning and/or servicing. Service to your treadmill should only be performed by an authorized service representative, unless authorized and/or instructed by the manufacturer. Failure to follow these instructions will void the treadmill warranty.
- ◆ Never leave the treadmill unattended while it is running.

Thank you for purchasing a KEYS treadmill! The ALLIANCE 855 and 888 treadmill was designed to meet your needs for cardiovascular exercise.

Before you start, please read the Owner's Manual and become familiar with the operation of your new treadmill.

- ◆ **Remember to take the time to perform the stretching exercises provided on Page 6 to avoid injury.**
- ◆ Do not stand on the walking belt while pressing the Power button or Start/Stop button.
- ◆ Always adjust the speed of the treadmill in small increments as this treadmill is capable of high speeds.
- ◆ If you are taking medication, consult your physician to see if the medication will affect your exercise heart rate.
- ◆ If you have heart problems, you are not active, and/or are over the age of 35 years, do not use the pre-set treadmill programs or start an exercise program without first contacting and receiving approval from your physician.
- ◆ To avoid the risk of electrical shock, always keep the console dry. Do not spill liquids on the console. KEYS recommends a sealed water bottle for beverages consumed while using the treadmill.
- ◆ **Please review the following picture below to familiarize yourself with the listed parts. This manual covers several treadmills, so the one pictured below may not be identical to your particular model.**

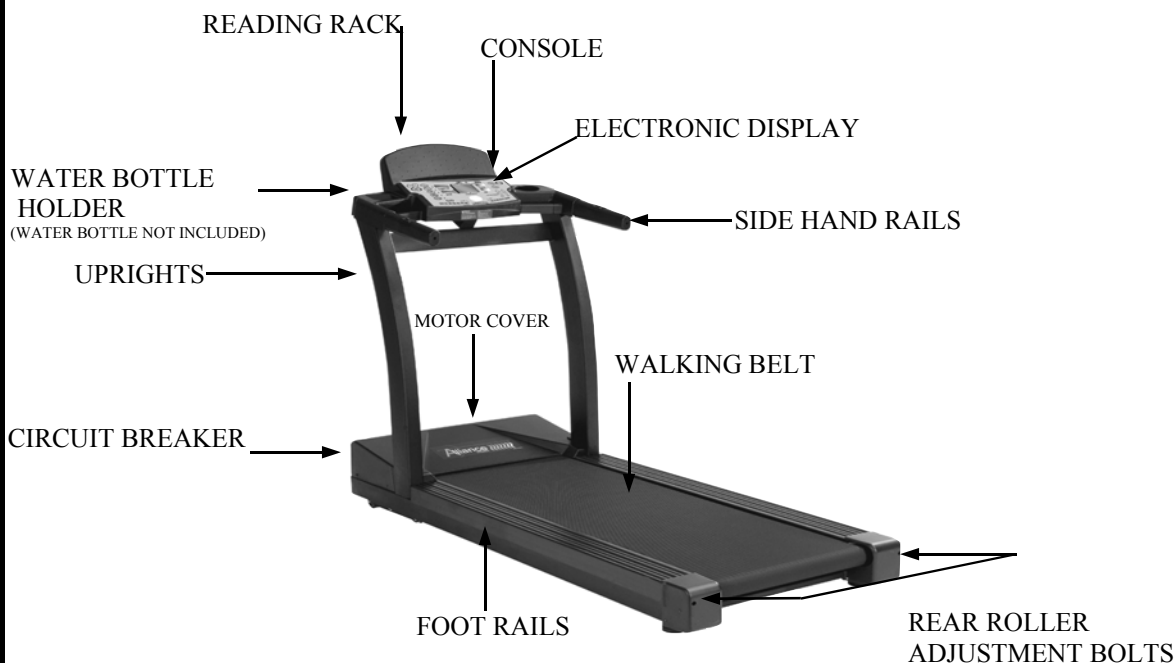

## EXERCISE GUIDELINES

**WARNING!** Before beginning this or any exercise program, you should consult your physician. This is especially important for individuals over the age of 35 or individuals with pre-existing health problems.

Warming up prepares the body for the exercise by increasing circulation, supplying more oxygen to the muscles and raising body temperature. Begin each workout with 5 to 10 minutes of stretching and light exercise to warm up. The photos on this page show several forms of basic stretching you may perform before your workouts. In order to achieve an adequate warm-up, perform each stretch three times.

### TOE TOUCH STRETCH

Stand bending your knees slightly and slowly bend forward from your hips. Allow your back and shoulders to relax as you reach down toward your toes as far as possible. Hold for 15 counts, then relax. This will stretch your hamstrings, back of knees, and back.



### HAMSTRING STRETCH

Sit with one leg extended. Bring the sole of the opposite foot toward you and rest it against the inner thigh of your extended leg. Reach toward your toes as far as possible. Hold for 15 counts, then relax. This will stretch your hamstrings, lower back, and groin.



### CALF/ACHILLES STRETCH

With one leg in front of the other, reach forward and place your hands against a wall. Keep your back leg straight and your back foot flat on the floor. Bend your front leg, lean forward and move your hips toward the wall. Hold for 15 counts, then relax. To cause further stretching of the Achilles tendons, bend your back leg as well. This will stretch your calves, Achilles tendons, and ankles.



### QUADRICEPS STRETCH

With one hand against a wall for balance, reach back and grasp one foot with your other hand. Bring your heel as close to your buttocks as possible. Hold for 15 counts, then relax. This will stretch your quadriceps and hip muscles.



### INNER THIGH STRETCH

Sit with the soles of your feet together and your knees outward. Pull your feet toward your groin area as far as possible. Hold for 15 counts, then relax. This will stretch your quadriceps and hip muscles.

## Minor Assembly Required!

**ALLIANCE 855/888HR** treadmill is shipped in two pieces: the console upright assembly, and the base assembly. After opening the box, remove any packing materials from the treadmill. Do not throw away any packing materials until the unit is working properly. The treadmill box contains a package that includes the Owners Manual, a RED SAFETY KEY, and a belt adjustment tool. The 888HR will also contain the heart rate chest strap. **The treadmill will not operate without the Red Safety Key.**

The console upright assembly is attached to the base assembly. Place the unit on a clean, level surface near an electrical outlet (extension cords are not recommended).

### See Figure 1

1. Raise the console into an upright position. Loosely install both 3/4" buttonhead screws on each side of the upright. Install and tighten each 3 1/2" x 5/16" bolt (2) with washers from the bottom of the base frame through the upright lock (diag. 1).
2. Now tighten the buttonhead screws securely from step 1.
3. Install motor hood cover using 5/8" phillips head screws (8 screws).

Be sure the treadmill is level to the floor. The rear feet can be adjusted to level the treadmill.  
Assembly is now complete!

Figure 1

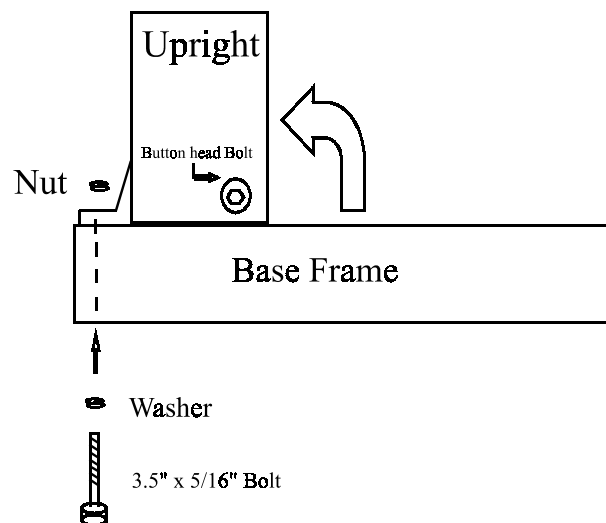

# Power Requirements



IMPROPER CONNECTION OF THE EQUIPMENT GROUNDING CONNECTOR CAN RESULT IN A RISK OF AN ELECTRIC SHOCK. CHECK WITH A QUALIFIED ELECTRICIAN OR SERVICE MAN IF YOU ARE IN DOUBT AS TO WHETHER THE PRODUCT IS PROPERLY GROUNDED. DO NOT MODIFY THE PLUG PROVIDED WITH THE PRODUCT, IF IT WILL NOT FIT THE OUTLET, HAVE A PROPER OUTLET INSTALLED BY A QUALIFIED ELECTRICIAN.

This treadmill can be seriously damaged by sudden voltage changes in your home's electrical power. Voltage spikes, surges, and noise interference can result from weather conditions or from other appliances being turned on or off. To reduce the possibility of treadmill damage, always use a surge protector (not included) with your treadmill.

Surge protectors can be purchased at most hardware stores. The manufacturer recommends a single outlet surge protector with a UL 1449 rating as a Transient Voltage Surge Suppressor (TVSS) with a UL suppressed voltage rating of 400V or less and an electrical rating of 120VAC, 15 amps.

This treadmill must be grounded to reduce the risk of electrical shock. Grounding provides a path of least resistance for electric current, should the treadmill malfunction. This treadmill comes with an electrical cord having an equipment-grounding conductor and a grounding plug. Always plug the power cord into a surge protector, and plug the surge protector into an appropriate outlet that is properly installed and grounded in accordance with all local codes and ordinances.

This product is for use on a nominal 120-volt circuit and has a grounding plug that looks like the plug illustrated in the drawing below.

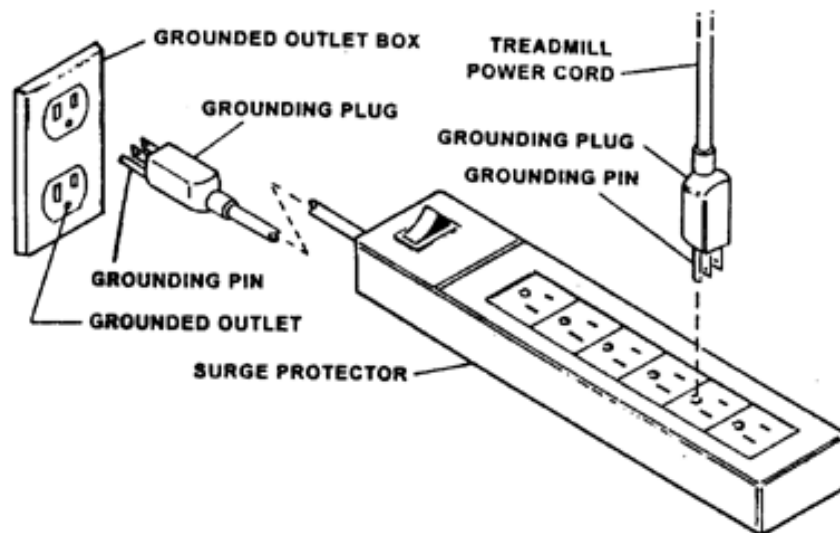



# Console Functions and Descriptions



**PROGRAM BUTTONS** - These buttons are used to access each of the four programs: Fat Burn, Cardio, Warm Up, and Cross Training. Each program has one preset program, and two additional custom programs in the P1 and P2 mode. See the "Program and Operating Instructions" on page 12.

**START/STOP** - This button starts the treadmill belt moving. There is a 4 second countdown built in as a safety feature to let you know the treadmill belt is about to start moving. Use the START/STOP button also to stop your treadmill after your workout. The belt will gradually come to a stop after pressing the button.

**POWER** - Press to on. Allow 6-8 seconds while the electronics perform a self check prior to pressing other buttons.

**ENTER** - Use the Enter button while setting program time, speed, and incline options. See page 12 for complete instructions.

**PAUSE** - Press to temporarily pause your workout while in use. The treadmill is designed with an automatic power off feature after 5 minutes in the pause mode.

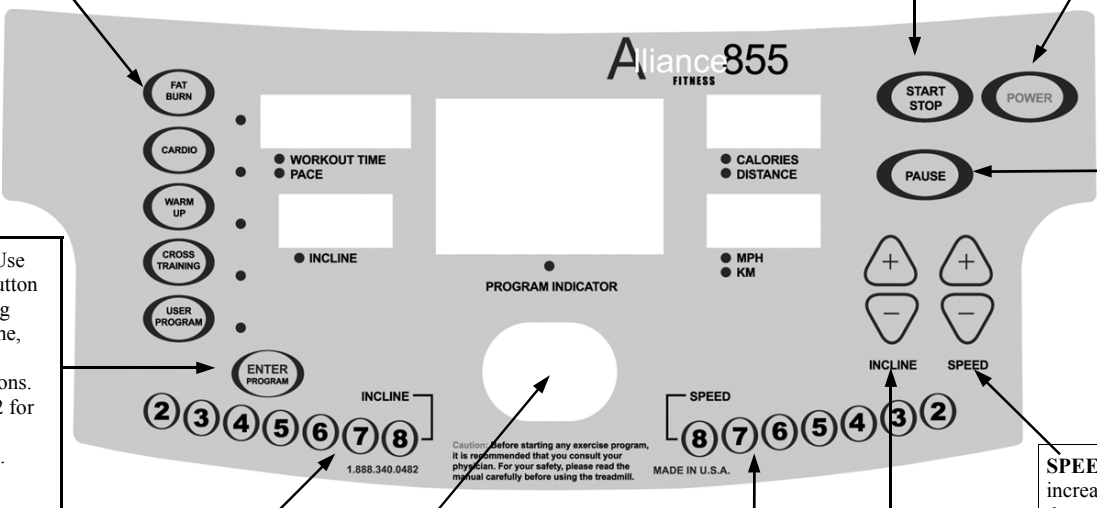

**CONSOLE SAFETY KEY** - Place the RED Safety Key here prior to turning power on. THE TREADMILL WILL NOT OPERATE WITHOUT THE SAFETY KEY ATTACHED. The safety key is equipped with a string and clip that will clip to your clothing. This is an important safety feature that will automatically turn the power off if you should trip or fall while using the treadmill.

**ONE TOUCH INCLINE BAR** - Use to either increase or decrease the incline. Each number indicates percent of grade. Pressing one of the buttons will gradually increase or decrease the incline to the new setting.

**INCLINE** - Use to either increase (UP arrow) or decrease (DOWN arrow) the incline. These buttons are also used while programming INCLINE.

**SPEED** - Use to either increase (UP arrow) or decrease (DOWN arrow) the speed. These buttons are also used while programming SPEED and TIME.

**ONE TOUCH SPEED BAR** - Use to either increase or decrease the speed. Each number indicates MPH. Pressing one of the buttons will gradually increase or decrease the speed to the new setting.

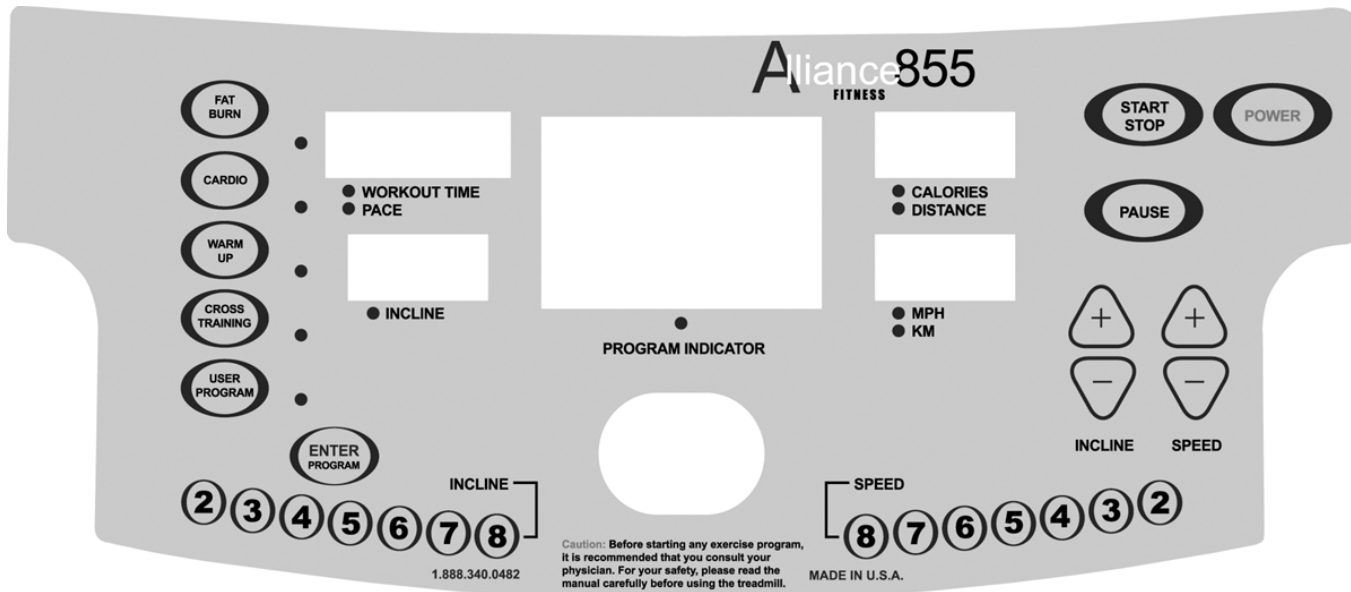

There are five display windows on the control panel to provide feedback information.

## WORKOUT TIME/PACE WINDOW

- ◆ **TIME:** Indicates elapsed time after pressing start in minutes and seconds (0-99 minutes, 0-59 seconds)
- ◆ **INTERVAL TIME:** Indicates countdown in seconds to the next interval starting at 5 seconds and counting to 0 seconds
- ◆ **PACE:** Indicates amount of time required to complete 1 mile at current speed.

## SPEED WINDOW

- ◆ **SPEED:** Indicates MPH (miles per hour) or KMH (kilometer per hour) in .1 increments

## DISTANCE / CALORIES WINDOW

- ◆ **DISTANCE:** Indicates Miles or Kilometers traveled in .01 increments up to 9.99 and .1 increments starting at 10.0
- ◆ **CALORIES:** Indicates estimated calories used based on 150 lb. person at the indicated speed, incline, and time

## INCLINE WINDOW

- ◆ **INCLINE:** Indicates incline in percent of grade 0-12% in .5 increments

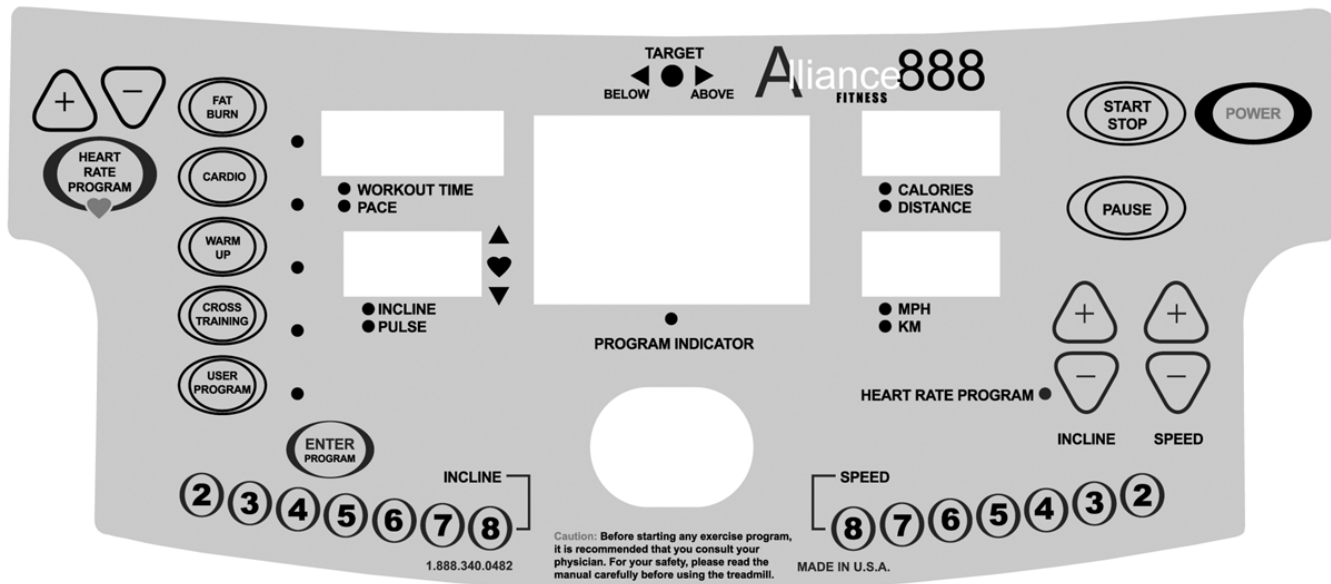

## INCLINE WINDOW

- ◆ **INCLINE:** Indicates incline in percent of grade 0-12% in 1 increments
- ◆ **PULSE** (888HR Model Only): Indicates current heart rate
- ◆ **HEART** ❤️ (888HR Model only): Indicates control panel is receiving a signal from heart rate transmitter. Heart will blink on and off if receiving signal from Heart Rate Transmitter chest strap.
- ◆ **CENTER BRICKYARD WINDOW**
  - ◆ Displays quarter mile track in Manual mode. Indicates position on track by a blink. In program mode, shows the change in speed profile across the interval range (1-10) and shows position with a blinking action.
  - ◆ The 880HR will display the name of the program selected, showing on the left hand side of the window. The LAP counter will appear in manual mode in the center of the window.
- ◆ **SPEED & INCLINE “ONE-TOUCH” BUTTONS**
  - ◆ Easy One-Touch buttons for Speed and Incline have been added to the console. To increase or decrease the speed, simply choose the desired setting (each number 2 through 8 represents Miles per Hour). To increase or decrease the amount of incline, simply choose the desired setting (each number 2 through 8 represents percent grade).

# Program and Operating Instructions



## ◆ QUICK START / MANUAL MODE

- ◆ Plug into a standard wall outlet (110-Volt AC, 15-amp circuit).
- ◆ **ATTACH THE RED SAFETY KEY TO CENTER OF CONSOLE.**
- ◆ Stand on the treadmill and straddle belt.
- ◆ Press POWER button. The TIME window will flash.
- ◆ Press START/STOP button. Belt will begin to move after 4 seconds. Step on belt slowly after the belt starts moving. Speed or incline may be adjusted by using the appropriate UP (increase) or DOWN (decrease) buttons. Speed and Incline can also be adjusted using the “One Touch” buttons labeled 2 through 8, or by using the toggle switches located on the handlebars. For speed and incline adjustments while using the treadmill, try the convenient handlebar toggles switches. The left handlebar switch is for incline, while the right handlebar switch adjusts the speed.
- ◆ **To end your workout**, press START/STOP button. Belt will gradually slow to zero.
- ◆ **To pause your workout**, press PAUSE. The treadmill will automatically shut off after five (5) minutes.
- ◆ **To re-start after pausing**: Press the PAUSE button. **WARNING**: The treadmill belt will resume at the speed the treadmill was moving before pausing.
- ◆ **Countdown Time, Preset Speed and/or Incline**: Time, Speed, and Incline may be preset prior to getting started. After pressing the POWER button, the time window will blink. Use the SPEED UP or DOWN arrows to select your workout time, then press the ENTER PROGRAM button located on the left hand side of the console below the program buttons. The SPEED window will now be flashing. Using the same + or – arrows, select the speed for your workout, then press ENTER PROGRAM. Now the INCLINE window will be flashing. Use the INCLINE + or – arrows to set your workout incline, then press ENTER PROGRAM. To start, press the START/STOP button.

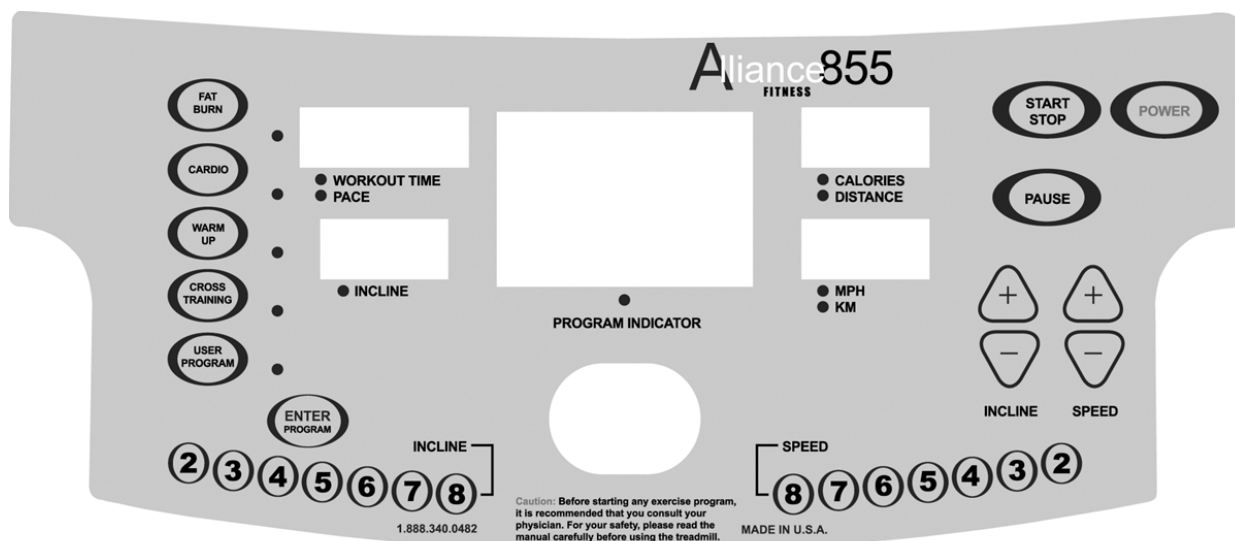

## ◆PROGRAM MODE

- ◆ Plug into a standard wall outlet (110-Volt AC, 15-amp circuit).
- ◆ **ATTACH THE RED SAFETY KEY TO THE CENTER OF THE CONSOLE.**
- ◆ Stand on the treadmill and straddle belt.
- ◆ Press POWER button. The TIME window will flash.
- ◆ There are three (4) pre-set programs on the 855 and 888HR. Both include Fat Burn, Cardio, and Warm Up programs. Select the program by pressing the appropriate button.
- ◆ Press START/STOP button. Belt will begin to move after 4 seconds. Step on belt slowly after the belt starts moving.
- ◆ **Each of the pre-set programs (4) can also be customized. Follow the instructions below for your particular model.**
- ◆ **Customizing programs in P1 and P2 Mode:** Each pre-set program can be customized in the P1 or P2 mode. After making the program selection, the CALORIE/DISTANCE window will read "OP." "OP" refers to "original program" and is preset. Press the same program button once more, and the CALORIE/DISTANCE window will read P1. The "P1" mode is now accessed. You can now program the Time, Speed, and Incline in P1 mode, which will save your entered information for future use. The time window will blink. Use the SPEED UP or DOWN arrows to select your workout time, then press the ENTER PROGRAM button located on the left hand side of the console below the program buttons. The SPEED window will now be flashing. Using the SPEED UP or DOWN arrows, select the speed for your workout, then press the ENTER PROGRAM button. Now the INCLINE window will be flashing. Use the INCLINE UP or DOWN arrows to set your workout incline, then press the ENTER PROGRAM button. To start, press the START/STOP button. To access P2 mode, press the selected program button three times (once for OP, twice for P1, three times for P2). Follow the above procedure to customize.
- ◆ **TO CHANGE A PREVIOUSLY PROGRAMMED P1, P2, or user program:** Once you have programmed the P1 or P2 modes, you will need to use the PAUSE button to change the program you previously entered. For instance, if P1 in Fat Burn has been programmed, to change to a new setting, press the Fat Burn button twice to access P1. Then press the PAUSE button to get the TIME window to flash. Follow the directions above to continue to change the program.

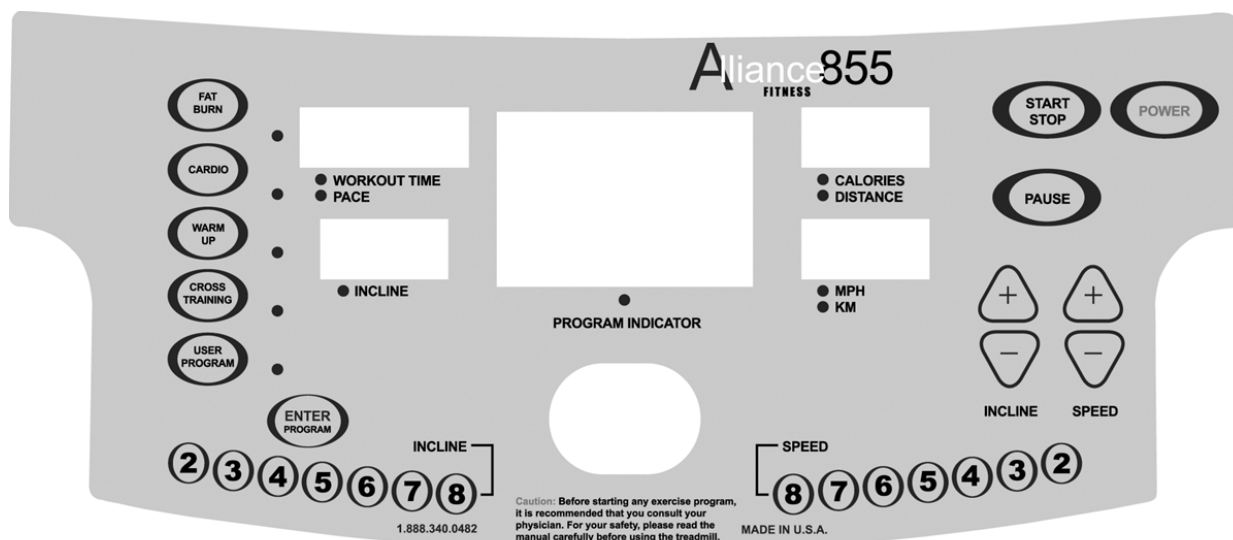

## ◆ Heart Rate Control Instructions (888HR only)

### ◆ HEART RATE PROGRAM MODE

- ◆ The Heart Rate program is designed to keep your heart rate a desired level of “beats per minute” by automatically adjusting the incline. For example, if you have programmed in a desired heart rate of 105 beats per minute and your heart rate is only 95 beats per minute (you must be wearing Heart Rate Transmitter), the incline will automatically increase to intensify the work load, and increase you heart rate to the 105 beats per minute you programmed.
- ◆ If your heart rate is above your programmed amount of beats per minute the incline will automatically decrease to lower your heart rate. You may at any time during the Heart Rate Program adjust/override the speed and or incline by simply pressing the correct corresponding buttons. You may change your “Target Heart Rate” at any time during the program by pressing the TARGET + or TARGET – buttons.
- ◆ Plug into a standard wall outlet (110-Volt AC, 15-amp circuit). Attach Safety Key to console
- ◆ Place the Heart Rate transmitter strap across chest against the skin. Stand on the treadmill and straddle belt.
- ◆ Press POWER button. There will be an eight (8) second delay after pressing the POWER button before data can be entered. The TIME window will flash. The “Heart” shape on the treadmill will be flashing if the Heart Rate Transmitter is transmitting. Adjust the strap on the chest until the console is picking up a signal.
- ◆ For Quick Start, press START/STOP button. Belt will begin to move after 4 seconds. Step on belt slowly after the belt starts moving. Speed or incline may be adjusted by using the appropriate + (increase) or – (decrease) buttons. Heart rate will read out in the Incline window.
- ◆ To select the Heart Rate Control program, press the “Heart Rate Program” button.
- ◆ The incline window will flash “125”, which is the default program target heart rate.
- ◆ Adjust Target Heart Rate to desired level with the TARGET + or – buttons.
- ◆ Press START/STOP button, or continue instructions below to program Time, and Speed.
- ◆ You can now program the Time and Speed. The time window will blink. Use the SPEED + or – arrows to select your workout time, then press the ENTER PROGRAM button. The SPEED window will now be flashing. Using the SPEED + or – arrows, select the maximum speed for your workout, then press ENTER PROGRAM. To start, press the START/STOP button.

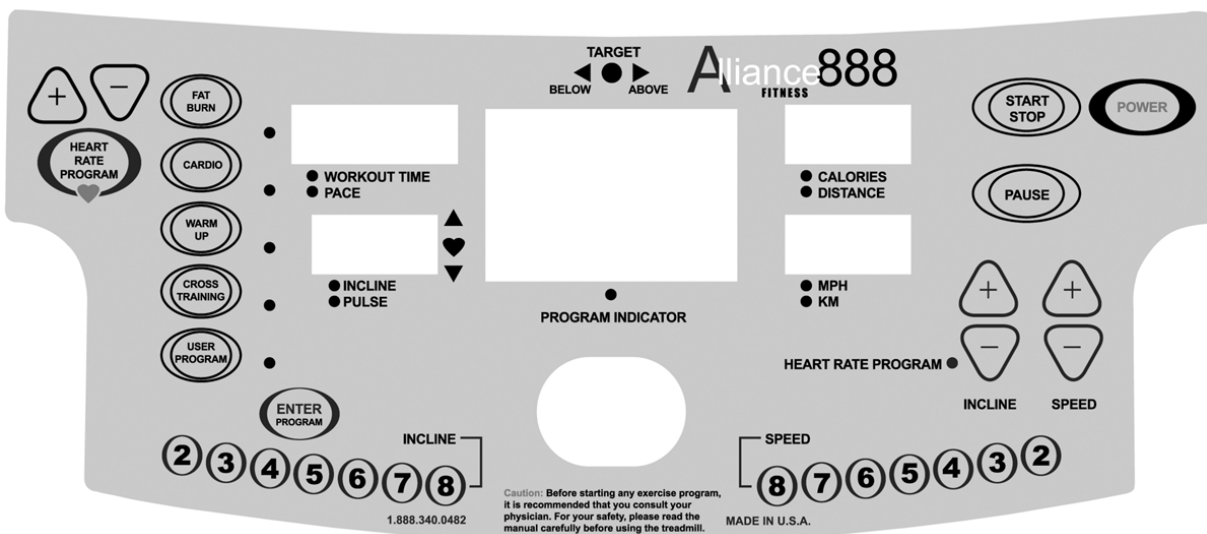

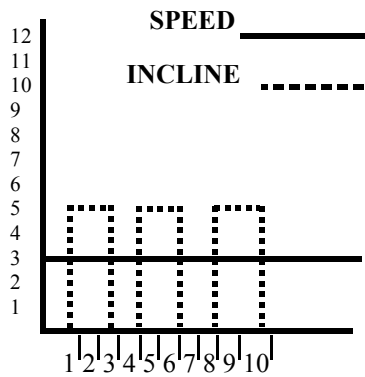

The **Fat Burn Program** is designed to vary the treadmill elevation, while maintaining a constant walking belt speed.

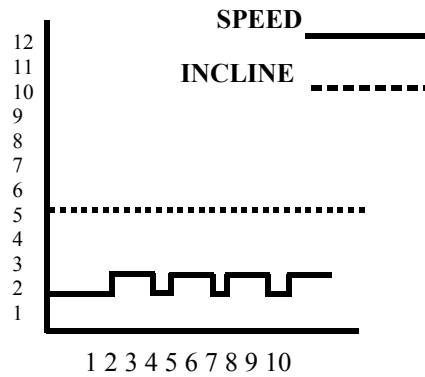

The **Cardio Program** is designed to vary the treadmill Speed, while maintaining a constant Elevation.

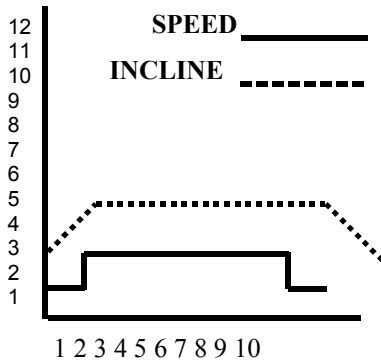

The **Warm Up Program** is designed to gradually increase the treadmill Speed and Elevation in the first segment (warm up) and gradually decrease the treadmill Speed and Elevation in the last segment (cool down). This is also known as a Plateau program.

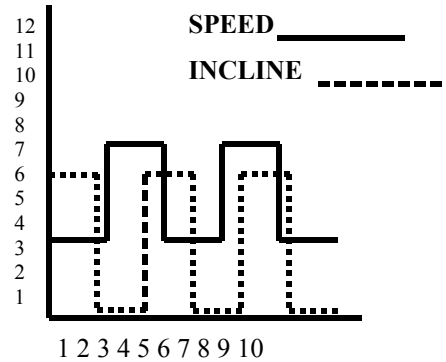

The **Cross Training Program** is designed to control the walking belt speed and elevation inversely in alternating segments.

# Belt Adjustment and Tension



**WARNING! Do not overtighten rollers! This will cause premature roller bearing failure!**

Belt adjustment and tension performs two functions: adjustment for tension and centering. Your new treadmill comes pre-adjusted from the factory for tension and centering. Please follow the procedures below if the belt shifts to the left or right or while walking:

## WALKING BELT IS SHIFTING TO THE LEFT (Diagram 1)

First, turn treadmill on to run at 1 mph. Using the hex key provided, turn the left rear roller adjustment bolt  $\frac{1}{4}$  turn in the clockwise direction. Next, run the treadmill at 2.5 mph. You should see the belt start to correct itself, moving back towards the center. Repeat the above procedure until the walking belt is centered. It may be necessary to set walking belt tension once you have completed this procedure if the belt feels like it is slipping while walking. Refer below to the “Walking Belt Slipping” instructions.



## WALKING BELT IS SHIFTING TO THE RIGHT (Diagram 2)

First, turn the treadmill on to run at 1 mph. Using the hex key provided, turn the right rear roller adjustment bolt  $\frac{1}{4}$  turn in the clockwise direction. Next, run the treadmill at 2.5 mph. You should see the belt start to correct itself, moving back towards the center. Repeat the above procedure until the walking belt is centered. It may be necessary to set walking belt tension once you have completed this procedure if the belt feels like it is slipping while walking. Refer below to the “Walking Belt Slipping” instructions.



## WALKING BELT IS SLIPPING DURING USE (Diagram 3)

First, unplug the power cord from the surge protector. Using the hex key provided, turn both left and right rear roller adjustment bolts the same distance, usually a  $\frac{1}{4}$  turn in the clockwise direction. Plug the power cord back into the surge protector and run the treadmill at 2.5 mph. You should now walk on the belt to determine if the belt is still slipping. Repeat the above procedure until the walking belt is not slipping. The tension should be just tight enough not to slip.



Turning the hex key counter clockwise brings the rear rollers and belt towards you. Turning the hex key clockwise pushes the rear roller and belt away from you.



# Change Miles per hour to Kilometers per hour



Your treadmill will operate in British Units (miles per hour) or International Units (kilometers per hour). All treadmills are calibrated at the factory for British Units (miles per hour). To change the display to read in kilometers, follow the steps described here:

- 1) Turn power OFF on the console. (Do not unplug treadmill) Attach the magnet safety key to the console.
- 2) Activate the calibration mode switch by inserting the eraser end of a pencil into the opening in the backside of the console (see diagram below).
- 3) Depressing the calibration mode switch ONCE; CL11 should appear in the TIME window.
- 4) Pressing the SPEED +/- button will activate your choice.
- 5) To accept the setting, press the POWER button.



## Treadmill will not start.

- 1) Is the RED Safety Key Attached to the Console?
- 2) Make sure the power cord is plugged into a surge protector, the surge protector is plugged into a properly grounded outlet, and the surge protector is turned on. (Refer to “Power Requirements”)
- 3) Check the circuit breaker located on the front of the treadmill. If the switch protrudes, it has tripped. Wait five minutes and then press the switch back in.
- 4) Check the house electrical breaker box and the circuit breaker for the room the treadmill is located in. If it has tripped, reset or have an electrician replace the breaker in home.
- 5) Have an electrician check for inadequate voltage at the outlet.

## Treadmill loses power during use.

- 1) Check the circuit breaker located on the front of the treadmill. If the switch protrudes, it has tripped. Wait five minutes and then press the switch back in.
- 2) Check the house electrical breaker box and the circuit breaker for the room the treadmill is located in. If it has tripped, reset or have an electrician replace the breaker in home.
- 3) If treadmill still will not operate, please call Keys Technical Service at (888) 340-0482.

## Treadmill walking belt slows during use.

- 1) Check to make sure the treadmill is securely plugged into an UL-listed surge protector, rated at 15 amps, with a 14-gauge cord of five feet or less and the surge protector is securely plugged into the outlet.
- 2) If treadmill still will not operate, please call Keys Technical Service at (888) 340-0482.

## Treadmill walking belt slips or is not centered on rear roller.

- 1) Refer to “Belt Adjustment and Tension” section.
- 2) Need help? Call Keys Technical Service at (888) 340-0482.

## Treadmill Error Messages.

2)Your treadmill is equipped with a software package that enables error messages to be displayed when there is a problem. **To avoid possible damage to the treadmill and the possibility of injury, do not operate the treadmill until the problem is corrected. Call Keys Technical Service at (888) 340-0482.**

# Parts & Exploded View



	Part #		Part #		
1	Left Side Extrusion Rail	05-0028	12	Front Wheel (2)	06-0039
2	Right Side Extrusion Rail	05-0028	13	Uprights for Console (2)	various
3	Treadmill Belt	04-0014	14	Motor Hood Cover Top	06-0040
4	Front Roller Assembly	24-0106	15	Motor Drive Belt	04-0007
5	Rear Roller	09-0009	16	Motor (855)	12-0004
				Motor (888HR)	12-0026
6	Treadmill Deck	03-0008	17	Elevation Motor (acuator)	12-0026
7	Left End Cap	06-0043	18	Console Assembly (855)	24-0191
8	Right End Cap	06-0042	19	Console Assembly (888HR)	24-0192
9	Rear Adjustable Foot (2)	10-0008	20	Handlebars	various
10	Main Frame	various	21	Toggle switches (2)	08-0027
11	Bottom Motor Pan	06-0041	22	Lower Electronics M/Control P/Supply (855)	08-0050
			22	Lower Electronic M/Control P/Supply (888HR)	08-0016

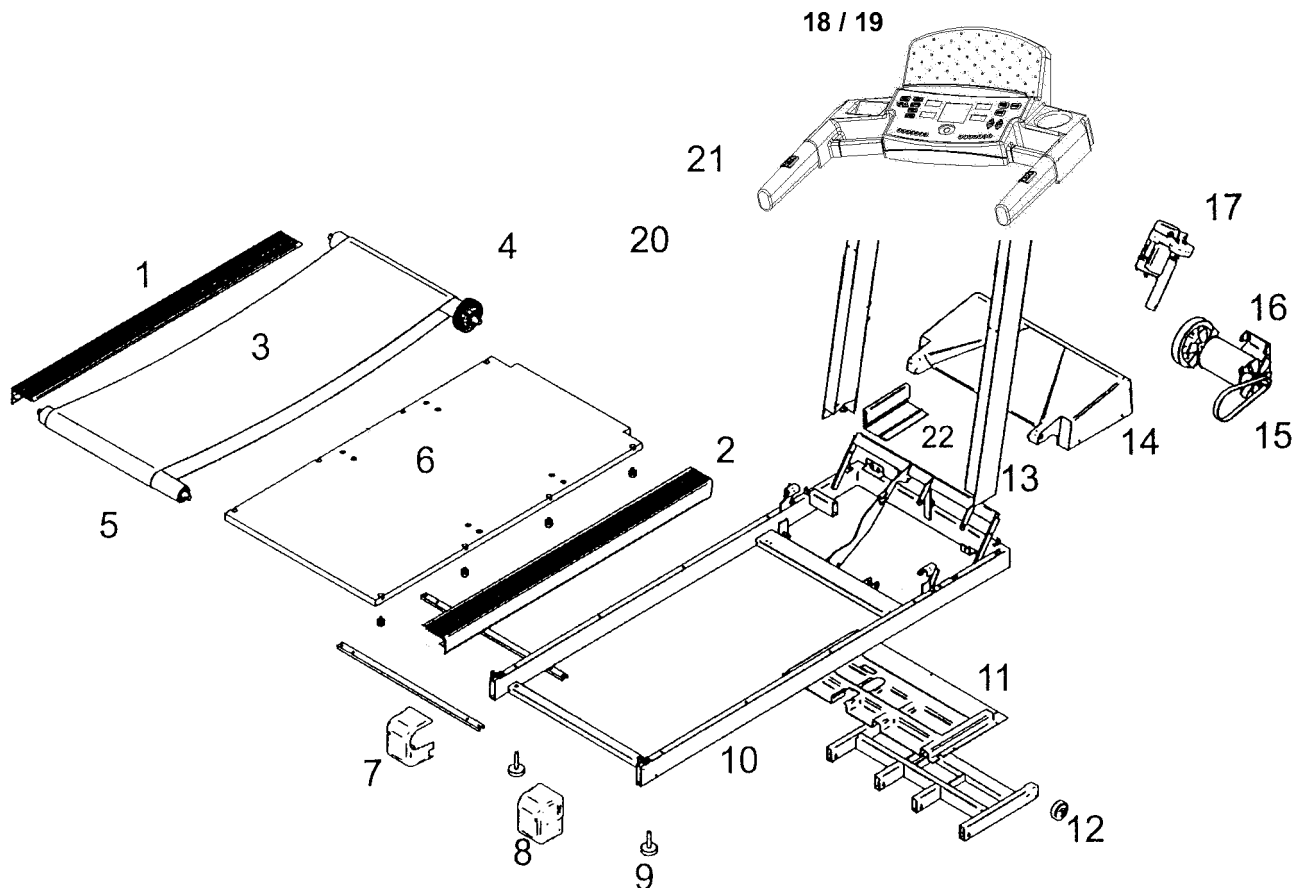

# ALL855OB- Parts List



PART #	DESCRIPTION	QTY	PART #	DESCRIPTION	QTY	PART #	DESCRIPTION
02-0004	SCREW-8x5/8 PHIL PH AB BLACK	9	08-0004	BREAKER-CIRCUIT-15AMP	1	19-0015	BRACKET-MOTOR COVER
02-0005	SCREW-8x5/8 PPH HILO BLACK TPB	11	08-0112	MEBRANE LED FOR WEDGE CONSOLE	1	19-0019	GUIDE BELT GLAVANIZED
02-0007	NUT 5/16-18 NYLOCKZP	2	08-0088	MEMBRANE-LED/LCD OWER	1	19-0030	SPACER-ENCODER
02-0009	NUT-HEX 5/16 WIZ-FL-LK-ZP	4	08-0027	SWITCH-REMOTE-W/HARNESS	2	19-0042	BRKT-SIDE FRAME ACTUATOR
02-0013	WASHER LOCK 1/4"	16	08-0047	ENCODER-OPTICAL-ALEPH	1	19-0043	BRKT-MOTOR MOUNT
02-0014	BOLT-HEX 1/4-20x2 1/2" GRADE 5 ZP	2	08-0077	CORE-ERRITE	1	19-0044	BRKT-ACTUATOR SUPPORT
02-0016	BOLT-HEX 3/8-16x2 1/2" GRADE 5	1	08-0050	CONTROLLER-REPLACES 08-0013	1	19-0047	BRKT-ELEVATION ACTURATOR
02-0017	NUT-NYLOCK HEX 3/8-16	2	09-0008	ROLLER-DRIVE .5:-8800/8500	1	19-0048	BRKT-REAR ROLLER
02-0019	BOLT-CARRIAGE 10-24x1 1/2	4	09-0009	ROLLER-IDLER 2.5"-8800/8500	1	19-0050	BRKT-ACTUATOR BRACE
02-0021	WASHER 9/32 5/8 1/8THICK ZP	2	10-0002	ISOLATOR-BOARD 3/4"	8	19-0052	BRKT-ELEVATION ACTURATOR
02-0022	NUT-NYLOCK HEX 10-24	4	10-0008	FOOT-REAR-KEYS SERIES	2	19-0057	BRKT-CHANNEL SUPPORT BOSS
02-0023	CLIP-ROTO HW12	2	10-0017	TAPE-FOAM-1"X75ft	1	19-0062	BRKT-ACTUATOR
02-0024	CARRIAGE BOLT 5/16x1 GRADE 5 ZP	4	10-0021	MOLDED GRIP OVAL NEW	2	19-0064	BRKT-STRAIN RELIER/BREAKER
02-0027	NUT-T HF 14209H-DB	16	11-0002	BUSHING-REAR ELEVAION	4	19-0065	BRKT-UPRIGHT BRACE
02-0028	SWITCH-MAGETIC KILL-YIHAN	1	11-0012	FLYWHEEL 5.88 10J-1.250 REPLACES 11-	1	19-0079	BRKT-BELT GUIDE
02-0030	SCREW-HEX TRILOBE 8-32x1/2"	1	12-0004	MOTOR-MAGNETEK 2.0HP-223526	1	19-0089	PLATE CONTROLLER KEYS8500
02-0031	BOLT-HEX 3/8-16x1 3/4" GRADE 5ZP	1	12-0026	ACTUATOR-600# BOSS	1	19-0101	BRKT-CONSOLE BRACE
02-0036	SCREW-PPH 8x5/8 GREEN HEAD	3	13-0011	CORD-POWER-90"	1	19-0107	SLUG-EMERGENCY STOP RED
02-0038	WRENCH-ALLEN 3/16 SHAFT ARM	1	13-0014	WIRE-JUMPER 12"-220V-KEYS SERIES	1	19-0128	BRKT-RIGHT STABILIZER
02-0042	SCREW#8x5/8 SD BLACK	2	13-0020	HARNESS CONTROLLER 80"	1	19-0129	BRKT-LEFT STABILIZER
02-0050	NUT-NYLOCK HEX 1/4-20	4	13-0034	WIRE-MOTOR LEAD EXTENSION 8"	1	19-0130	PLATE-CONSOLE ALLI-14GA-EC850/880
02-0082	SCREW-BUTTON HEAD 5/16-18x2 1/2'	2	13-0040	HARNESS CONTROL PANEL +6"	1	19-0131	BRKT-RIGHT FILLER
02-0084	BOLT-CARRIAGE 5/16x:RADE 5	2	14-0026	DECAL-WARNING CONSOLE-ALL GRAY	1	19-0132	BRKT-LEFT FILLER
02-0085	HEX NUT 1/2-13	4	14-0027	DECAL-EMERGENCY STOP-RED	1	19-0151	BRKT-RT U/R STIFFENER
02-0090	HEX BOLT 1/4-20x1 3/4 HC	2	14-0354	OVERLAY CONSOLE ALL855-OB	1	19-0152	BRKT RT U/R & FRT ROLLER
02-0095	SCREW-BUTTON HD 5/16-18x1" HSC BLK	2	14-0205	DECAL DISCONNECT-MOTOR COVER	1	19-0153	BRKT LT U/R & FRT ROLLER
02-0099	WASHER -SFW 3/8X7/8X1/8" THICK	1	14-0226	DECAL-SIDE FRAME-EC850	2	19-0154	BRKT MOTOR SHELF REVISED 19-0088
02-0100	BOLT HEX 5/16-18x3 1/2"GRADE 8	2	14-0321	DECAL-10YR MOTOR WARRANTY	1	19-0160	BRKT MOTOR COVER SUPPORT
02-0105	INDRTY-5/16-18 HEAVY WAL AVK	2	14-0336	DECAL MTR COVER ALL ALLIANCE	3	20-0019	PROC-BELT GUIDE TB 17-0017
02-0119	HEX SCREW HD 1/4-20x3 1/4"	8	14-0351	DECAL SPEED SERIGRAPH	1	20-0020	PROC-FRAME TUBE 17-0018
02-0125	SCREW-5/16-18x3/4"BUTTON HD BLACK	2	14-0352	DECAL INCLINE SERIGRAPH	1	20-0023	PROC-LOWER ELEVATION END TB 17-0021-OBS
02-0131	HEX NUT 5/16-18	3	15-0029	DIAGRAM-WIRING-MAGNETEK	1	20-0027	PROC-FRAME BRACE 17-0016
02-0137	PLUG PUSH-IN	2	15-0080	MANUAL-EC880HR-EC850	1	20-0060	PROC-RT CURVED U/R 17-0052
02-0141	PUSH NUT BLACK.112 SHAFT	6	16-0018	BOX-BOTTOM-KEYS SERIES	1	20-0061	PROC-LT CURVED U/R 17-0052
02-0143	HEX BOLT 1/4-20x1"	8	16-0017	BOX-TOP KEYS/SCIFIT	1	20-0066	PJROC OVAL HBAR NEW 17-0040
03-0008	WALKBOARD KEYS SERIES NOTCHED	1	16-0020	PAD-TOP TRAY-KEYS SERIES	1	20-0102	PROC LOWER ELEV END TB REVISED
04-0007	BELT-POLY V-260J10-KEYS SERIES	1	16-0033	ANGLE FOAM-6FT PIECES-CUT INTO 9PCS	1	21-0012	ELEVATION X-TB-NOTCHED BOTH ENDS
04-0014	WALKBELT ORTHO 19.75x116.5-P7 2 PLY	1	16-0039	PAD END EC850/880	2	21-0028	RT CURVED UPRIGHT-WELD TAB
05-0028	EXTRUSION SIDE BOARD LT&RT	2	16-0040	PAD SIDES EC850/880	2	21-0029	LT CURVED UPRIGHT-WELD TAB
06-0014	BUSHING-STRAIN RELIEF #1237	1	16-0041	PAD HANDRAILS EC850/880	1	21-0030	UPRIGHT STIFFENER
06-0016	TIES-WIRE	7	16-0043	BOX-TOP INVERTED 16-0017	1	21-0031	STRAIGHT U/R SAW CUT TO 2 PIECES
06-0021	CLAMP WIRE 3367 7/16	1	16-0061	ANGLE BOARD 6"	4	21-0031	STRAIGHTENED U/R SAW CUT TO 2 PIECES
06-0024	CLIP-ALLEN WRENCH	1	16-0062	ANGLE BOARD 33 3/4"	4	22-0013	LOWER ACTUATOR SUB-ASSEMBLY
06-0038	PULLEY-KEY SERIES-4.5"	1	17-0015	RECT 1x1 1/2x11GAx25 15/16	1	22-0026	UPPER ACTUATOR ASSEMBLY
06-0039	WHEEL-KEYS SERIES-2.5"	2	17-0016	RECT 1x1 1/2x12GAx26 7/16	1	22-0051	99"CONSOLE ASSEMBLY
06-0040	MOTOR COVER	1	17-0017	RECT 1x3x12GAx26 7/16	1	22-0059	RT U.R BRKT SUB-ASSEMBLY
06-0041	PAN-BOTTOM	1	17-0018	RECT 1x3x12GAx166	1	22-0060	LT U/R BRKT SUB-ASSEMBLY
06-0042	ENDCAP-RIGHT	1	17-0020	RECT 1x2x12GAx4 7/16-PUNCHED	2	23-0038	DECK FRAME ASSEMBLY
06-0043	ENCAP-LEFT	1	17-0021	RECT 1x2x12GAx3 9/16	2	23-0066	UPRIGHT ASSEMBLY-ALLIANCE/BOSS
06-0071	FAN 5"-5/8" ID	2	17-0022	RECT 1x2x12GAx23 7/8	1	24-0106	FRONT ROLLER ASSEMBLY-LEYS8800/8500
06-0084	BAG-PLASTIC 12x12 3MIL-INST PACKET	1	17-0040	OVAL 1.094x2x16GAx17.25	2	24-0191	CONSOLE ASSEMBLY ALL855-OB
06-0118	PLASTIC SWITCH HOUSING BLK FOR OVAL	2	17-0046	TUBE-RESET GUIDE	1	26-0059	INST PACKET-EC850
06-0140	INSERT LED FOR CONSOLE	1	17-0052	RECT-2x4x14GAx100"	1		
06-0160	CONSOLE ALLIANCE SHELL LED/LCD	1	17-0053	RECT-1x3x16GAx24 7/16"	1		
07-0050	ELECTRONICS 5 WIN LED GREEN	1					

# ALL888HR-OB- Parts List



PART #	DESCRIPTION	QTY	PART #	DESCRIPTION	QTY	PART #	DESCRIPTION
02-0004	SCREW-8x5/8 PHIL PH AB BLACK	9	08-0004	BREAKER-CIRCIT-15AMP	1	17-0053	RECT-1x3x16GAx24 7/16"
02-0005	SCREW-8x5/8 PPH HILO BLACK TPB	11	08-0016	CONTROLLER-MOTOR 3525HE	1	19-0019	GUIDE BELT GLAVANIZED
02-0007	NUT 5/16-18 NYLOCKZP	2				19-0030	SPACER-ENCODER
02-0009	NUT-HEX 5/16 WIZ-FL-LK-ZP	4	08-0027	SWITCH-REMOTE-W/HARNESS	2	19-0042	BRKT-SIDE FRAME ACTUATOR
02-0013	WASHER LOCK 1/4"	16	08-0047	ENCODER-OPTICAL-ALEPH	1	19-0043	BRKT-MOTOR MOUNT
02-0014	BOLT-HEX 1/4-20x2 1/2" GRADE 5 ZP	2	08-0077	CORE-ERRITE	1	19-0044	BRKT-ACTUATOR SUPPORT
02-0016	BOLT-HEX 3/8-16x2 1/2" GRADE 5	1	08-0052	CONTROLLER-REPLACES 08-0016	1	19-0047	BRKT-ELEVATION
02-0017	NUT-NYLOCK HEX 3/8-16	2	08-0089	MEMBRANE-LED/LCD POWER	1	19-0048	BRKT-REAR ROLLER
02-0019	BOLT-CARRIAGE 10-24x1 1/2	4	08-0111	BUSS WIRE 20GA	1	19-0050	BRKT-ACTUATOR BRACE
02-0021	WASHER 9/32 5/8 1/8THICK ZP	6	08-0123	MEMBRANE 5WIN LED FROG WEE/ALL	1	19-0052	BRKT-ELEVATION ACTURATOR
02-0022	NUT-NYLOCK HEX 10-24	4	09-0008	ROLLER-DRIVE 2.5"- 8800/8500	1	19-0057	BRKT-CHANNEL SUPPORT BOSS
02-0023	CLIP-ROTO HW12	2	09-0009	ROLLER-IDLER 2.5"-8800/8500	1	19-0062	BRKT-ACTUATOR
02-0024	CARRIAGE BOLT 5/16x1 GRADE 5 ZP	4	10-0002	ISOLATOR-BOARD 3/4"	8	19-0064	BRKT-STRAIN RELIER/BREAKER
02-0027	NUT-T HF 14209H-DB	16	10-0008	FOOT-REAR-KEYS SERIES	2	19-0065	BRKT-UPRIGHT BRACE
02-0028	SWITCH-MAGNETIC KILL-YIHAN	1	10-0017	TAPE-FOAM-1"X75ft (20FT)	1	19-0079	BRKT-BELT GUIDE
02-0030	SCREW-HEX TRILOBE 8-32x1/2"	1	10-0021	MOLDED GRIP OVAL NEW	2	19-0101	BRKT-CONSOLE BRACE
02-0031	BOLT-HEX 3/8-16x1 3/4" GRADE 5ZP	1	11-0002	BUSHING-REAR ELEVAION	4	19-0107	SLUG-EMERGENCY STOP RED
02-0036	SCREW-PPH 8x5/8 GREEN HEAD	3	11-0008	FLYWHEEL-KEYS SERIES	1	19-0128	BRKT-RIGHT STABILIZER
02-0038	WRENCH-ALLEN 3/16x7/8x1/8x1" HSC	2	11-0009	PULLEY-DRIVE-KEYS-SERIES	1	19-0129	BRKT-LEFT STABILIZER
02-0042	SCREW#8x5/8" SD BLACK	2	12-0013	MOTOR-MAGNETEK 3.0HP-223615 BOSS	1	19-0130	PLATE-CONSOLE ALLI-14GA-EC850/880
02-0050	NUT-NYLOCK HEX 1/4-20	6	12-0026	ACTUATOR-600# BOSS	1	19-0131	BRKT-RIGHT FILLER
02-0058	WASHER-FLAT NYLON 3/8	2	13-0011	CORD-POWER-90"	1	19-0132	BRKT-LEFT FILLER
02-0065	SCREW-SHCS 1/4-20x1 3/4"	2	13-0014	WIRE-JUMPER 12"-220V-KEYS SERIES	1	19-0151	BRKT-RT U/R STIFFENER
02-0079	SCREW-BUTTON HD#14-14x1" 5/32 SH AB	1	13-0017	HARNESS-TELCO-HRC	1	19-0152	BRKT RT U/R & FRT ROLLER
02-0082	SCREW-BUTTON HEAD 5/16-18x2 1/2'	2	13-0020	HARNESS CONTROLLER 80"	1	19-0153	BRKT LT U/R & FRT ROLLER
02-0084	BOLT-CARRIAGE 5/16x:RADE 5	4	13-0040	HARNESS CONTROL PANEL +6"	1	19-0154	BRKT MOTOR SHELF REVISED 19-0088
02-0085	HEX NUT 1/2-13	4	14-0026	DECAL-WARNING CONSOLE-ALL GRAY	1	19-0160	BRKT MOTOR COVER SUPPORT
02-0090	HEX BOLT 1/4-20x1 3/4 HC	2	14-0027	DECAL-EMERGENCY STOP-RED	1	20-0019	PROC-BELT GUIDE TB 17-0017
02-0095	SCREW-BUTTON HD 5/16-18x1" HSC BLK	2	14-0355	OVERLAY CONSOLE ALL888HR-OB	1	20-0020	PROC-FRAME TUBE 17-0018
02-0099	WASHER -SFW 3/8X7/8X1/8" THICK	2	14-0205	DECAL DISCONNECT-MOTOR COVER	1	20-0023	PROC-LOWER ELEVATION END TB 17-0021-OBS
02-0100	BOLT-HEX 5/16-18x3 1/2" GRADE 8	2	14-0225	DECAL-SIDE FRAME-EC888HR	2	20-0027	PROC-FRAME BRACE 17-0016
02-0105	INSERT-5/16-18 HEAVY WAL AVK	2	14-0321	DECAL-10YR MOTOR WARRANTY	1	20-0060	PROC-RT CURVED U/R 17-0052
02-0119	HEX SCREW HD 1/4-20x3 1/4"	8	14-0336	DECAL MTR COVER ALL ALLIANCE	3	20-0061	PROC-LT CURVED U/R 17-0052
02-0125	SCREW-5/16-18x3/4"BUTTON HD BLACK	2	14-00351	DECAL SPEED NEW OVAL GRIPS	1	20-0066	PJROC OVAL HBAR NEW 17-0040
02-0131	HEX NUT 5/16-18	2	14-0352	DECAL INCLINE NEW OVAL GRIPS	1	20-0102	PROC LOWER ELEV END TB REVISED
02-0137	PLUG PUSH-IN	2	14-0289	STICKER HEART RATE ACUMEN	1	21-0012	ELEVATION X-TB-NOTCHED BOTH ENDS
02-0143	HEX BOLT 1/4-20x1"	8	15-0029	DIAGRAM-WIRING-MAGNETIK	1	21-0028	RT CURVED UPRIGHT-WELD TAB
03-0008	WALKBOARD KEYS SERIES NOTCHED	1	15-0080	MANUAL-EC880HR-EC850	1	21-0029	LT CURVED UPRIGHT-WELD TAB
04-0007	BELT-POLY V-260J10-KEYS SERIES	1	16-0018	BOX-BOTTOM-KEYS SERIES	1	21-0030	UPRIGHT STIFFENER
04-0014	WALKBELT ORTHO 19.75x116.5-P7 2 PLY	1	16-0017	BOX-TOP KEYS/SCIFIT	1	21-0031	STRAIGHTENED U/R SAW CUT TO 2 PIECES
05-0028	EXTRUSION SIDE BOARD LT&RT	2	16-0020	PAD-TOP TRAY-KEYS SERIES	1	22-0026	UPPER ACTUATOR ASSEMBLY
06-0014	BUSHING-STRAIN RELIEF #1237	1	16-0039	PAD END EC850/880	2	22-0051	99"CONSOLE ASSEMBLY
06-0016	TIES-WIRE	7	16-0040	PAD SIDES EC850/880	2	22-0059	RT U/R BRKT SUB-ASSEMBLY
06-0024	CLIP-ALLEN WRENCH	1	16-0041	PAD HANDRAILS EC850/880	1	22-0060	LT U/R BRKT SUB-ASSEMBLY
06-0038	PULLEY-KEY SERIES-4.5"	1	16-0043	BOX-TOP INVERTED 16-0017	1	23-0017	DECK FRAME ASSEMBLY
06-0039	WHEEL-KEYS SERIES-2.5"	2	16-0061	ANGLE BOARD 6"	4	23-0048	ELEVATION ASSEMBLY
06-0040	MOTOR COVER	1	16-0062	ANGLE BOARD 33 3/4"	4	24-0106	FRONT ROLLER ASSEMBLY-LEYS8800/8500
06-0041	PAN-BOTTOM	1	17-0015	RECT 1x1 1/2x11GAx25 15/16	1	24-0191	CONSOLE ASSEMBLY ALL855-OB
06-0042	ENDCAP-RIGHT	1	17-0016	RECT 1x1 1/2x12GAx26 7/16	1	24-0192	CONSOLE ASSEMBLY ALL888HR-OB
06-0043	ENCAP-LEFT	1	17-0017	RECT 1x3x12GAx26 7/16	1	26-0055	INST PACKET-EC880HR
06-0058	SUPPORT-PC BOARD HRC	2	17-0018	RECT 1x3x12GAx166	1		
06-0071	FAN 5"-5/8" ID	2	17-0020	RECT 1x2x12GAx4 7/16-PUNCHED	2		
06-0084	BAG-PLASTIC 12x12 3MIL-INST PACKET	1	17-0021	RECT 1x2x12GAx3 9/16	2		
06-0118	PLASTIC SWITCH HOUSING BLK FOR OVAL	2	17-0022	RECT 1x2x12GAx23 7/8	1		
06-0140	INSERT LED FOR CONSOLE	1	17-0033	RECT 1x2x16GAx4 1/4-PUNCHED	1		
06-0160	CONSOLE ALLIANCE SHELL LED/LCD	1	17-0040	OVAL 1.094x2x16GAx17.25	2		
07-0020	RECEIVER-DISCRETE-LED HRC	1	17-0046	TUBE-RESET GUIDE	1		

**Alliance 855 and 888HR Treadmills manufactured by KEYS FITNESS PRODUCTS, LP – LIMITED WARRANTY**

**PLEASE CONSULT YOUR PHYSICIAN BEFORE USING THIS PRODUCT.**

This Limited Warranty applies in the United States and Canada to products manufactured or distributed by Keys Fitness Products, LP ("Keys") under the ALLIANCE brand name. The warranty period to the original purchaser is (lifetime) on the frame, (10) years on the motor, (5) years on the walking belt, and deck, (3) years on parts, and (1) year labor. This warranty does not cover wear and tear, only manufacturer defects for the periods specified.

Keys warrants that the Product you have purchased for non-commercial, personal, family, or household use from Keys or from an authorized Keys reseller is free from defects in materials or workmanship under normal use during the warranty period. Your sales receipt, showing the date of purchase of the Product, is your proof of the date of purchase. This warranty only extends to you, the original purchaser. It is not transferable to anyone who subsequently purchases the Product from you. It excludes expendable parts. This Limited Warranty becomes VALID ONLY if the treadmill is assembled/installed by a Keys Fitness authorized dealer/technician unless otherwise authorized by Keys Fitness in writing (if anyone other than a Keys Fitness authorized dealer/technician assembles a Keys Fitness treadmill the warranty will be void unless accompanied by written authorization by Keys Fitness). Select models do not require assembly, and the original purchaser

During the warranty period Keys will at no additional charge, repair or replace (at Keys' option) the part or product if it becomes defective, malfunctions, or otherwise fails to conform with this Limited Warranty under normal non-commercial, personal, family or household use. In repairing the Product, Keys may replace defective parts, or at the option of Keys, serviceable used parts that are equivalent to new parts in performance. All exchanged parts and Products replaced under this warranty will become the property of Keys. Keys reserves the right to change manufacturers of any part to cover any existing warranty.

To obtain warranty service, you must contact a Keys authorized service technician or Keys Fitness at our phone numbers located in this manual. Any parts determined to be defective must be returned to Keys to obtain warranty service. You must prepay any shipping charges, export taxes, custom duties and taxes, or any other charges associated with transportation of the parts or Product. In addition, you are responsible for insuring any parts or Product shipped or returned. You assume the risk of loss during shipment. You must present Keys with proof-of-purchase documents (including the date of purchase). Any evidence of alteration, erasing or forgery of proof-of-purchase documents will be cause to void this Limited Warranty.

This warranty does not extend to any product not purchased from Keys or from an authorized Keys reseller. This Limited Warranty does not extend to any Product that has been damaged or rendered defective; (a) as a result of accident, misuse, or abuse; (b) by the use of parts not manufactured or sold by Keys; (c) by modification of the Product or normal wear and tear; (d) operation on incorrect power supplies; or (e) as a result of service by anyone other than Keys, or an authorized Keys warranty service provider. Product on which the serial number has been defaced or removed is not eligible for warranty service. Should any Product be submitted for warranty service be found ineligible therefore, an estimate of repair cost will furnished and the repair will be made if requested by you upon Keys' receipt of payment or acceptable arrangements for payment.

EXCEPT AS EXPRESSLY SET FORTH IN THIS WARRANTY, KEYS MAKES NO OTHER WARRANTIES, EXPRESSED OR IMPLIED, INCLUDING ANY IMPLIED WARRANTIES OF MERCHANTABILITY AND FITNESS FOR A PARTICULAR PURPOSE. KEYS EXPRESSLY DISCLAIMS ALL WARRANTIES NOT STATED IN THIS LIMITED WARRANTY. ANY IMPLIED WARRANTIES THAT MAY BE IMPOSED BY LAW ARE LIMITED TO THE TERMS OF THIS LIMITED WARRANTY. NEITHER KEYS NOR ANY OF ITS AFFILIATES SHALL BE RESPONSIBLE FOR INCIDENTAL OR CONSEQUENTIAL DAMAGES. SOME STATES DO NOT ALLOW LIMITATIONS ON HOW LONG AN IMPLIED WARRANTY LASTS OR THE EXCLUSION OR LIMITATION OF INCIDENTAL OR CONSEQUENTIAL DAMAGES, SO THE ABOVE LIMITATIONS OR EXCLUSION MAY NOT APPLY TO YOU. This Limited Warranty gives you specific legal rights and you may also have other rights that may vary from state to state. This is the only express warranty applicable to Keys-branded products. Keys neither assumes nor authorizes anyone to assume for it any other express warranty.

PLEASE SEND IN THE ATTACHED WARRANTY CARD WITHIN TEN (10) DAYS OF PURCHASE TO REGISTER YOUR TREADMILL WITH KEYS FITNESS PRODUCTS, LP. MADE IN THE USA. **Thank you for your business!** PLEASE MAIL WARRANTY CARD TO: KEYS FITNESS PRODUCTS, PO BOX 551239, DALLAS, TX 75355.

<b>KEYS FITNESS TREADMILL WARRANTY REGISTRATION</b>			<b>TELEPHONE</b>																					
<b>FIRST</b>	<b>M.I.</b>	<b>LAST</b>	<input type="text"/>	<input type="text"/>																				
<input type="text"/>	<input type="text"/>	<input type="text"/>	<input type="text"/>	<input type="text"/>																				
<b>ADDRESS</b>			<b>APT. NO.</b>																					
<input type="text"/>			<input type="text"/>																					
<b>CITY</b>		<b>STATE</b>	<b>ZIP</b>																					
<input type="text"/>		<input type="text"/>	<input type="text"/>																					
<b>DATE OF PURCHASE</b>		<b>MODEL NO.</b>	<b>SERIAL NO.</b>																					
<input type="text"/>		<input type="text"/>	<input type="text"/>																					
Name of store or company where purchased:  How do you plan to use the treadmill? Walk ___ Run ___ Both ___	Where did you learn about treadmills? TV ___ Radio ___ Friend ___  In Store Display ___ Salesperson ___  Print ad/flyer ___ Internet ___	How important are each feature: <table style="width: 100%; border-collapse: collapse;"> <tr> <td></td> <td style="text-align: center;">Least</td> <td style="text-align: center;">Most</td> </tr> <tr> <td>Unique Features</td> <td style="text-align: center;"><input type="checkbox"/></td> <td style="text-align: center;"><input type="checkbox"/></td> </tr> <tr> <td>Horsepower</td> <td style="text-align: center;"><input type="checkbox"/></td> <td style="text-align: center;"><input type="checkbox"/></td> </tr> <tr> <td>Warranty</td> <td style="text-align: center;"><input type="checkbox"/></td> <td style="text-align: center;"><input type="checkbox"/></td> </tr> <tr> <td>Price</td> <td style="text-align: center;"><input type="checkbox"/></td> <td style="text-align: center;"><input type="checkbox"/></td> </tr> <tr> <td>Look/Design</td> <td style="text-align: center;"><input type="checkbox"/></td> <td style="text-align: center;"><input type="checkbox"/></td> </tr> <tr> <td>Folding Feature</td> <td style="text-align: center;"><input type="checkbox"/></td> <td style="text-align: center;"><input type="checkbox"/></td> </tr> </table>		Least	Most	Unique Features	<input type="checkbox"/>	<input type="checkbox"/>	Horsepower	<input type="checkbox"/>	<input type="checkbox"/>	Warranty	<input type="checkbox"/>	<input type="checkbox"/>	Price	<input type="checkbox"/>	<input type="checkbox"/>	Look/Design	<input type="checkbox"/>	<input type="checkbox"/>	Folding Feature	<input type="checkbox"/>	<input type="checkbox"/>	Other Comments:  _____ _____ _____
	Least	Most																						
Unique Features	<input type="checkbox"/>	<input type="checkbox"/>																						
Horsepower	<input type="checkbox"/>	<input type="checkbox"/>																						
Warranty	<input type="checkbox"/>	<input type="checkbox"/>																						
Price	<input type="checkbox"/>	<input type="checkbox"/>																						
Look/Design	<input type="checkbox"/>	<input type="checkbox"/>																						
Folding Feature	<input type="checkbox"/>	<input type="checkbox"/>																						
Who will use the treadmill? Male ___ Female ___ Both ___  How many family members? ___	Why did you purchase a treadmill?  Dr.'s Orders ___ Loose Weight ___ In-home convenience ___ Improve Cardiovascular Fitness ___ Safety from outdoors ___  Other _____	KEYS FITNESS respects the rights of your privacy. Our company will not sell or distribute to others the information above. This information is used to track our product quality and to contact you in the event of a product safety concern. It may be used to offer you future Keys products only through the mail. Please check here if wish not to receive any additional information on Keys products. <input type="checkbox"/>																						
AGE:    15-24 ___ 25-34 ___ 35-44 ___ 45-54 ___ 55-64 ___ 65 + ___																								

## Free Manuals Download Website

<http://myh66.com>

<http://usermanuals.us>

<http://www.somanuals.com>

<http://www.4manuals.cc>

<http://www.manual-lib.com>

<http://www.404manual.com>

<http://www.luxmanual.com>

<http://aubethermostatmanual.com>

Golf course search by state

<http://golfingnear.com>

Email search by domain

<http://emailbydomain.com>

Auto manuals search

<http://auto.somanuals.com>

TV manuals search

<http://tv.somanuals.com>