



**KICKER®**  
**WARHORSE REMOTE CONTROL**

**WXRC**



### WXRC Remote Control Owner's Manual

### WXRC Remote Control

Model: **WXRC**

#### Congratulations on your KICKER purchase!

Please record your purchase information and keep your sales receipt for validation of warranty.

Authorized Kicker Dealer: \_\_\_\_\_

Purchase Date: \_\_\_\_\_

Model Number: **WXRC**

FEATURES

The WXRC is a component we envisioned from the start to compliment your KICKER Warhorse amplifier. That is why all Warhorse amplifiers have been built from day one with the ability to be controlled remotely...and now you have the tool to do so, the WXRC. The WXRC gives you complete access to up to 16 KICKER Warhorse amplifiers and incorporates the latest in microprocessor technology which allows you to group and control each Warhorse amplifier in your system. The WXRC puts all of your amplifier controls at your fingertips from the driver's seat...plus a whole lot more! Please read this manual so you have a thorough understanding of the capabilities, installation and operation of your WXRC.

#### Features

**ISIS Display** Indicate Status & Input Settings  
ISIS is a VFD (Vacuum Fluorescent Display), 5-way soft-touch keypad and 4 memory presets that allows you to view any current settings and make changes to your WXRC and the connected amplifiers.

**WXRC Name** The name of the WXRC is displayed in the default screen scrolling menu. Name is 'WXRC' by default but can be changed by you to any name using up to 10 characters.

**Digital Remote Volume Control (DRVC)**  
Allows instant control of the output level of selected amplifiers. The current setting of the digital remote volume control is displayed in the default screen scrolling menu.

**Number Of Units Under WXRC Control**  
The number of amplifiers currently being controlled by the WXRC is displayed in the default screen scrolling menu.

**Real Time Calendar & Clock** The WXRC is capable of displaying the current date and time and is user adjustable.

**Amplifier Temperature Display** Selected amplifier's current temperature is displayed in the default screen scrolling menu.

**Amplifier Voltage Display** Selected amplifier's current voltage is displayed in the default screen scrolling menu.

**Amplifier Adjustment** Allows you to individually select and adjust any setting on any amplifier controlled by the WXRC.

**Amplifier Grouping & Group Adjustment**  
Allows you to build groups of amplifiers which can then share similar settings and be adjusted all at once.

**WXRC Setup** Allows you to setup and adjust many options for the WXRC like ISIS display brightness, lock codes, amp names, memory names, etc. See details further in the manual.

**Security Mode** Allows you to 'Lock' and 'Unlock' your WXRC and connected WX amplifiers to prevent un-authorized adjustments.

**Global Memory Presets** Allows you to store and recall up to 4 memory settings for all amplifiers connected to the WXRC.

**DIN Sized Control Head** The controller for the WXRC is very thin and includes hardware to be mounted in a standard DIN sized opening.

#### Included Parts and Components

**WXRC Control Head** This is the DIN sized unit used to control the WXRC and your WX amplifiers. It includes an attached 1 meter long 4-pin DIN cable. This cable is also referred to as a PS2 cable and you can use an extension (Male to Female) cable to lengthen the cable if required (not included).

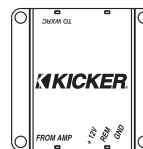
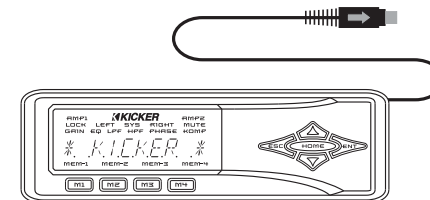

**WXRC Interface Box** This small enclosure provides the power connections for the WXRC as well as being the communication bridge between the Control Head and your WX Series amplifiers.

**Metal DIN Mounting Cage** This cage is designed to mount into a standard DIN sized opening and provide a solid mounting for your WXRC.

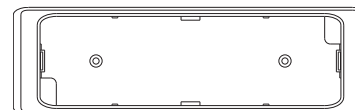
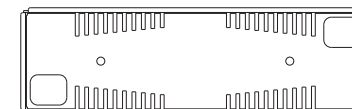

**Plastic Cosmetic Trim Ring** This ring trims out the DIN Mounting Cage and provides a professional finished look to your install.

**R-Tool** Tool used to assist in removing the WXRC Control Head from the Plastic Cosmetic Trim Ring.



**Mounting Hardware** Includes Four (4) sheet metal screws for mounting the Interface Box and two (2) M3 flathead screws to mount the Cosmetic Trim Ring to the DIN Mounting Cage. Four (4) rubber mounting washers are included to protect the mounting flange on the Interface Box.

**Two (2) 4-pin DIN Network Cables** are included. One 5-Meter Cable to connect your interface box to your first Warhorse amplifier and additional 2-meter cable to connect additional Warhorse amplifiers to the WXRC Communications Network.

#### ISIS (Indicate Status & Input Settings) System

The ISIS (Indicate Status & Input Settings) system consists of the VFD (Vacuum Fluorescent Display) and nine soft touch buttons that make up the Keypad. The ISIS allows you to view and adjust the settings of your WXRC and all of the WX Series amplifiers connected to it.

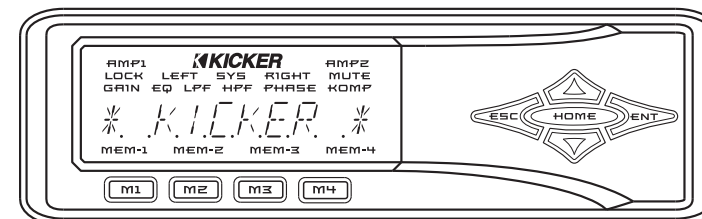

INCLUDED COMPONENTS

## Vacuum Fluorescent Display (VFD)

Here is a brief description of the indicators found on the VFD:

**LOCK** - Indicates the WXRC and/or WX Series amplifier controls are locked out and not usable.

**SYS** - Indicates you are in the System Menu

**MUTE** - Indicates you are in the mute menu or the mute function is active.

**GAIN** - Indicates you are in the gain menu.

**EQ** - Indicates you are in the equalizer menu.

**LPF** - Indicates you are in the low pass filter menu.

**HPF** - Indicates you are in the high pass filter menu.

**PHASE** - Indicates you are in the phase menu.

**LIMITER** - Indicates you are in the LIMITER menu.

**MEM-1** - Memory preset 1 activated or stored.

**MEM-2** - Memory preset 2 activated or stored.

**MEM-3** - Memory preset 3 activated or stored.

**MEM-4** - Memory preset 4 activated or stored.

## KEYPAD

Here is a brief description of the soft touch buttons.

**M1** - Used to select memory preset 1 or to store current settings into memory preset 1.

**M2** - Used to select memory preset 2 or to store current settings into memory preset 2.

**M3** - Used to select memory preset 3 or to store current settings into memory preset 3.

**M4** - Used to select memory preset 4 or to store current settings into memory preset 4.

**ESC** - Used to exit the current menu.

**ENT** - Used to enter the selected menu.

**HOME** - Used to return to the Main Menu and other functions explained later in this manual.

**UP** - Used to advance up through menu selections and/or adjust WXRC and amplifier controls.

**DOWN** - Used to advance down through menu selections and/or adjust WXRC and amplifier controls.

Using the existing DIN opening or the one you just created, slide the Metal DIN Mounting Cage into the opening. Secure the Cage by bending the Mounting Tabs on the sides, top and bottom of the Cage using a small flat-blade screwdriver. Use only the tabs that will secure the Cage to the Mounting Surface.

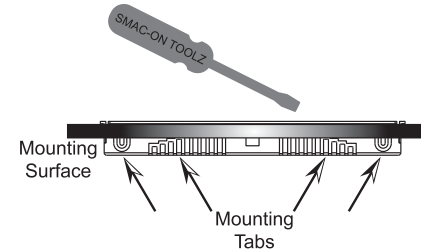
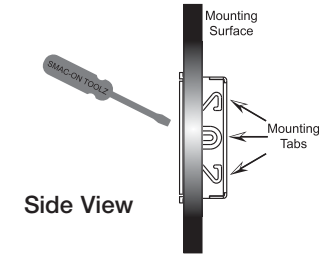

Top and Bottom View

Next, place the Plastic Cosmetic Trim Ring into the Metal DIN Mounting cage. There are two plastic retainers in the Trim Ring (one on top and one on bottom) that will snap into place.

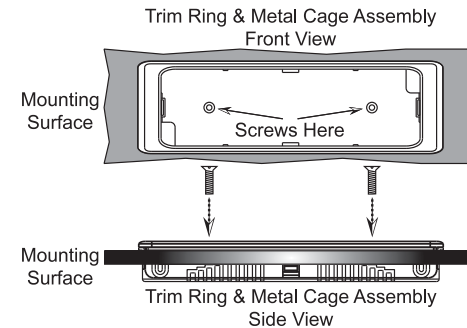
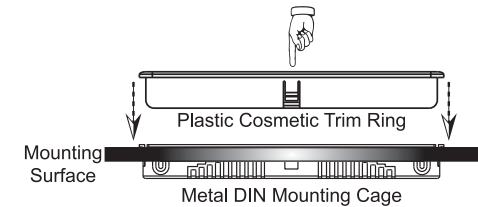

Once in place, use the 2 supplied M3 flathead screws to secure the Trim Ring to the Metal Cage.

The WXRC Control Head is held in place by two clips (one on each side) of the Plastic Trim Ring.

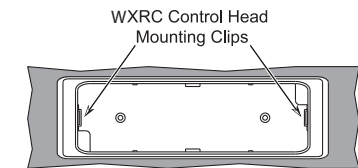

Route the WXRC Control Head cable through one of the openings in the Trim Ring/Metal Cage assembly to your WXRC Interface Box location.

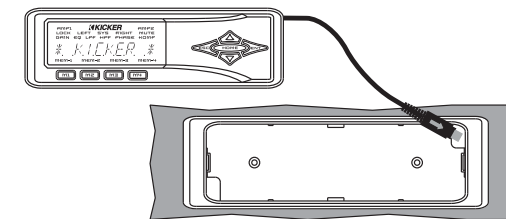

Press the WXRC control head in to the assembly until it locks into place. Your WXRC Control Head is now mounted and you can move on to the wiring section of this manual

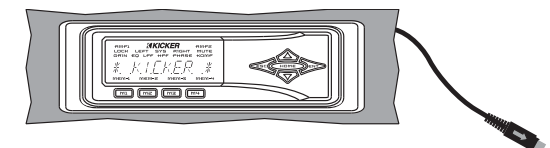

These controls and their usage will be explained later with more detail in each menu usage section

## Mounting

### DIN Mounting

Using the supplied hardware you can mount the WXRC into a standard DIN sized opening.

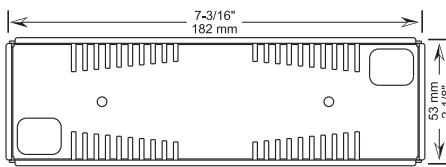

Be sure you will have a minimum of 2" (51 mm) clearance depth behind your mounting surface panel to mount the WXRC.

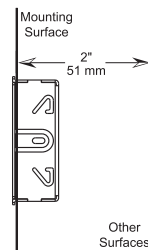

If not using an existing DIN opening, you will first need to cut an opening that is 7-3/16" (182 mm) by 2-1/8" (53 mm) into your mounting surface panel.

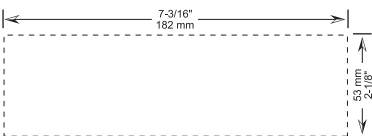

It is VERY important that you DO NOT make the hole any larger than the specified dimensions. If you make the opening too large then the mounting cage will not work properly.

## Surface Mounting With Screws

The WXRC Control Head can also be surface mounted if you do not have a spare DIN opening in your dash or do not want to cut one into an existing panel.

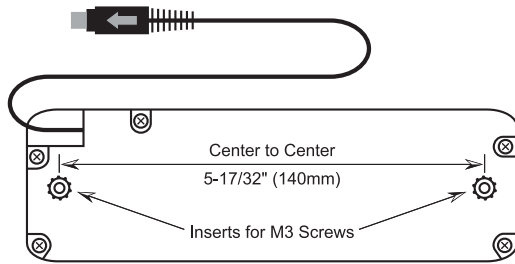

The back of the WXRC Control Head has two metal inserts designed to work with M3 screws.

Find a suitable location and drill two 1/8 inch (3 mm) holes to secure the WXRC Control Head. The holes should be 5-17/32" (140 mm) apart from center to center.

**NOTE:** You will need to have access to the area behind the mounting surface to install the mounting screws.

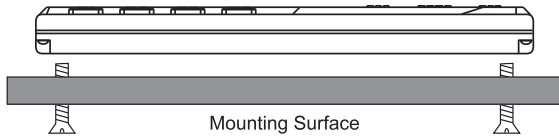

Once your holes are drilled you can use the two supplied M3 screws to secure the WXRC Control Head to your mounting surface. If the supplied screws are not long enough to reach the WXRC Control Head you can supply your own M3 screws of the required length to secure the WXRC.

**NOTE!!!** Whether using the supplied M3 screws from the WXRC kit or your own, the screws can not enter into the WXRC more than 5/16" (4 mm). If you attempt to insert the screw any deeper than this into the WXRC Control Head you will run the risk of damaging the unit.

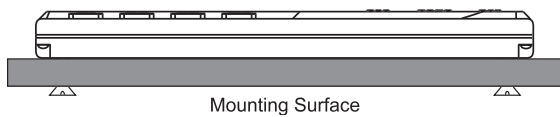
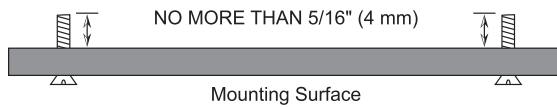

Route the WXRC Control Head cable to your WXRC Interface Box location. Your WXRC Control Head is now mounted and you can move on to the wiring section of this manual.

## Surface Mounting With Velcro

If you do not want to cut any openings or drill any holes you can use a material such as Velcro™ to secure your WXRC Control Head to your dashboard or other mounting surface. Velcro™ is not supplied with your WXRC but can be obtained from any local fabric or retail store.

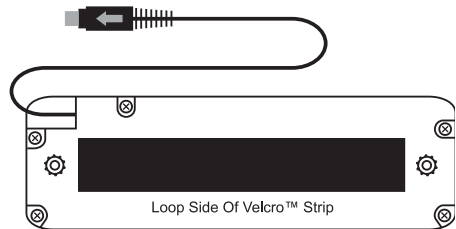

Place a 5" (127 mm) strip of the loop half on the WXRC.

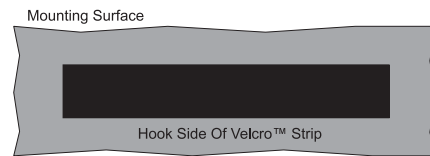

Place a 5" (127 mm) strip of the hook half on the mounting surface.

## Using the R-Tool

The included R-Tools are used to remove the WXRC Control Head from the Trim Ring/Metal Cage assembly. The R-Tools simply slide into the notched area on both sides of the Plastic Cosmetic Trim Ring and will release the clips holding the WXRC Control Head.

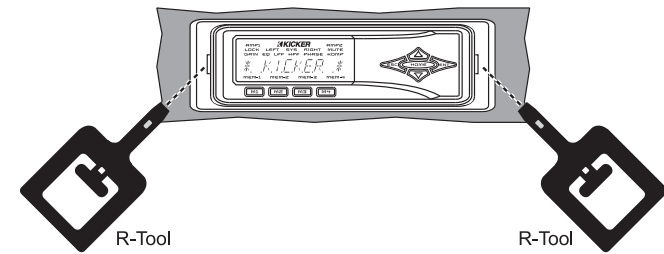

## Wiring

Now that you have mounted your WXRC Control Head it is time to do some wiring. The first step is to plug your WXRC Control Head into the WXRC Interface Box.

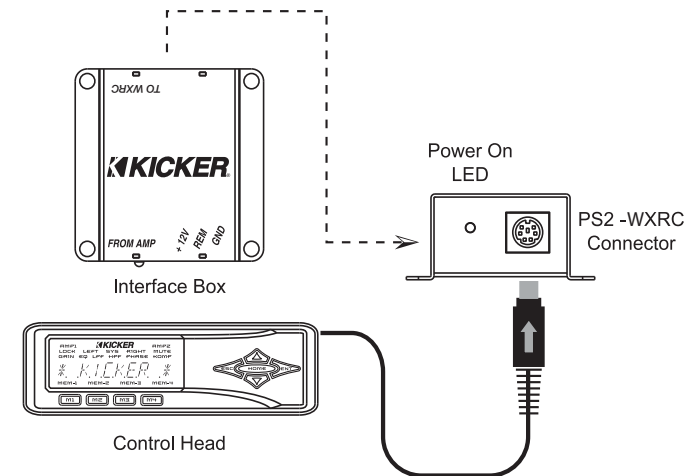

Next, run a fused (5 amp) constant 12 volt, ground and remote turn on to the WXRC Interface Box. Connect the wiring to the removable power plug by loosening the set screws, inserting the stripped wire and then tightening the set screw.

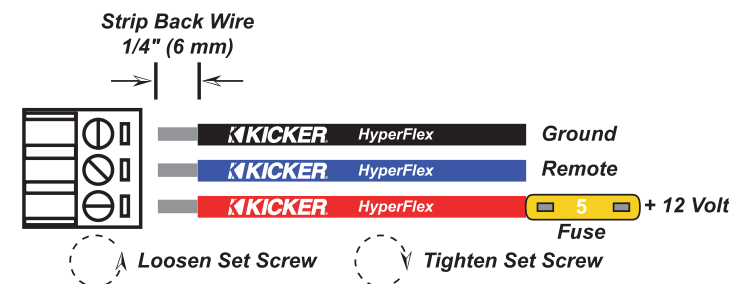

Now insert the removable power plug into the WXRC Interface Box. You should have something resembling this picture at this point. The Control Head plugged in and the power plug wired correctly and plugged in.

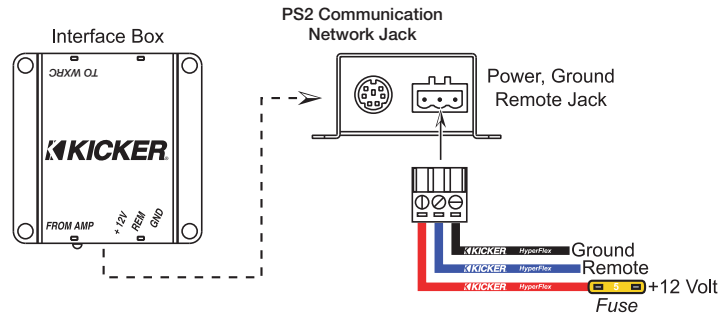

### WXRC Network Cables

Now we can run the Network Cables from the WXRC Interface Box to your WX Series amplifiers to create the WXRC Communications Network.

Run the supplied 5-meter Network Cable from the Interface Box to the REMOTE IN jack of your first WX Series amplifier.

Run the supplied 2-meter Network Cable from the first WX Series amplifier's REMOTE OUT jack to the REMOTE IN jack of the second amplifier.

You can continue adding amplifiers (16 total) by following this setup and supplying your own Network Cables.

The WXRC is supplied with 2 4-pin DIN Network Cables, one 5-meter and one 2-meter. This is enough to connect 2 WX Series amplifiers to the WXRC Interface Box. You can connect up to 16 WX Series amplifiers to the WXRC by supplying additional cables.

If you need additional cables or need to use custom lengths, you can purchase pre-made 4-pin DIN (S-Video) cables at any computer or electronics store.

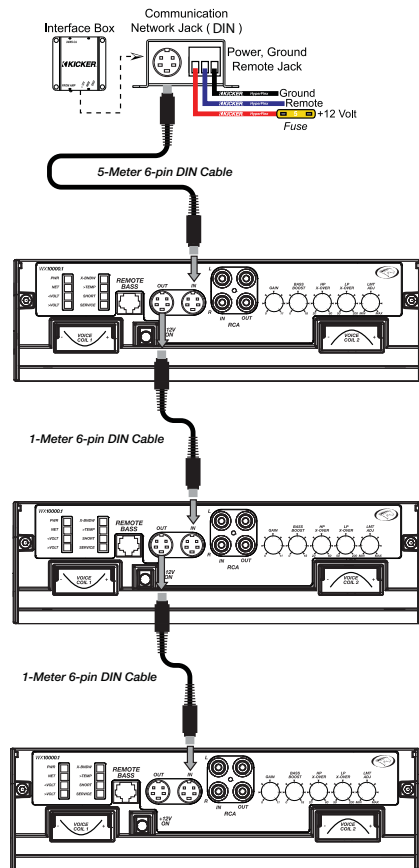

### Navigation

Your KICKER WXRC uses the latest in microprocessor technology control to provide you with operational information about your amplifiers, full control over amplifier settings, global memory presets and amplifier group control capability.

The menu system is designed in layers. There is a starting point and you simply keep drilling down until you get to the menu item you want to view or change. This menu tree gives you an example of how the WXRC menu structure is set up.

**NOTE:** Not all menus and menu items shown.

### DEFAULT SCREEN

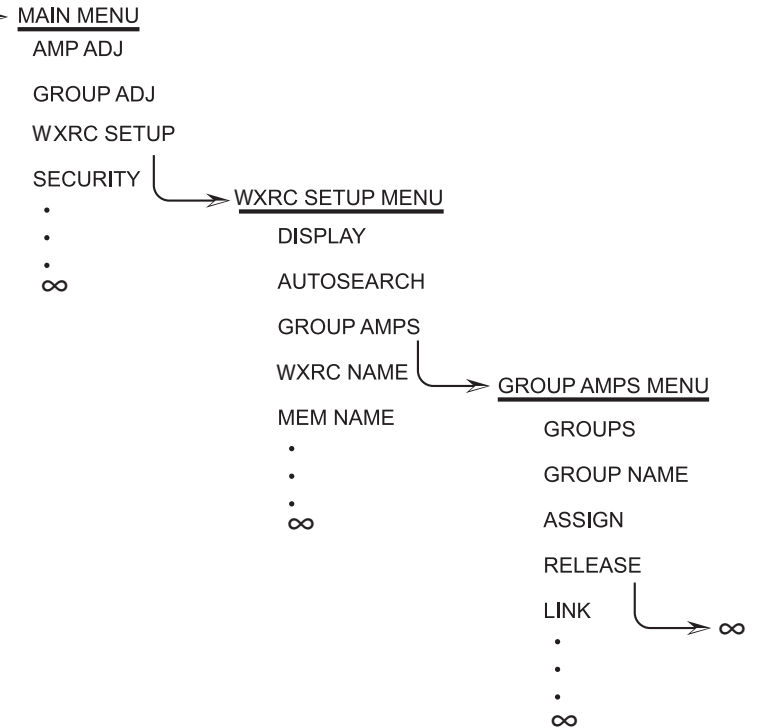

Navigating the menu structure is very easy using the 5-way keypad.

You use the **UP** and **DOWN** keys to scroll through the available menu items. The **ENT** key is used to select that menu item. The **ESC** key backs you up one menu level from where you are, and the **HOME** key can return you all the way to MAIN MENU by pressing and holding it for 1.5 seconds.

This is how you view information and change settings in your WXRC Remote Control.

## Menu System

Here are the descriptions of each menu item, its function and how to operate it.

**DEFAULT** - This menu is displayed when your WXRC is first powered up and operating. If you are in another menu making adjustments, the WXRC will time-out and return to the DEFAULT menu automatically after 3 minutes of no key press activity.

The following information is scrolled through the ISIS display one after the other and repeats.

- » \* **KICKER** \* - Your friend wants to know who makes that wicked sick remote sitting in your dash...we put it right here for you! Plus...it is quicker than a Google™ search!
- » **-WXRC-** - The name of the remote control. You can change this name to whatever you like. See the WXRC SETUP section of the manual.
- » **XX.X VOLTS** - Displays the current voltage at the selected amplifier's ( **INFO AMP** ) + 12 volt battery terminal. Selecting the **INFO AMP** is described in the WXRC SETUP section of the manual.
- » **XX.X DEG F** or **XX.X DEG C** - Displays the current temperature of the selected amplifier ( **INFO AMP** ) in fahrenheit or celsius. Selecting the **INFO AMP** is described in the WXRC SETUP section of the manual.
- » **MEMORY NAME** - The name of the current Global Memory Preset in use, if any are currently selected.
- » **VOL = 00.0 DB** - The current setting of the Digital Remote Volume Control. You can select which amplifiers are controlled by this function. See the WXRC SETUP section of the manual.
- » **XX UNITS** - How many WX Series amplifiers are currently connected to the WXRC. If you have 4 but it only says 3...time to troubleshoot...or go fishing. Your choice.
- » **DATE DISPLAY** - Displays the current date in month-day-year format. Requires initial setup by you and then is kept up-to-date with internal backup battery. Described later in the WXRC SETUP section of the manual.
- » **TIME DISPLAY** - Displays the current time in 12 hour am/pm format. Requires initial setup by you and then is kept up-to-date with internal backup battery. Described later in the WXRC SETUP section of the manual.

You can freeze the scrolling display on any item in the DEFAULT menu by simply pressing the **HOME** key.



Once you freeze the scrolling display you can manually select any item to view by pressing the **ESC** key. Each press brings up the next item in the DEFAULT menu.

If you want the display to start scrolling again, simply press the **HOME** key



You can change the Digital Remote Volume Control (DRVC) at any time when you are in the DEFAULT menu. Simply press the **UP** key to increase the volume level or press the **DOWN** key to decrease the volume level.

When you press either the **UP** or **DOWN** key to change the DRVC level, the display will instantly show the current Remote Volume Level.



The Digital Remote Volume Control has an operating range of 0.0 dB to -26.0 dB. Each press of the **UP** key will increase the DRVC level .5 dB and each press of the **DOWN** key decreases the DRVC level .5 dB.



Pressing and holding either the **UP** or **DOWN** key will cause the DRVC level to change rapidly.



The WXRC will pause on the DRVC level for 2 seconds after you have made your adjustment and then return to the previous DEFAULT menu item that was being displayed before you adjusted the DRVC.

### MAIN MENU

This is the first menu you access from the DEFAULT menu and is the gateway to all the settings and information display on your WXRC.

To enter the MAIN menu simply press the **ENT** key while in the DEFAULT menu.

The available selections in the MAIN menu are:

- » **AMP ADJ**
- » **GROUP ADJ**
- » **WXRC SETUP**
- » **SECURITY**

Use the **UP** and **DOWN** arrow keys to scroll through the available selections in the MAIN menu.



When you have the menu item selected that you want to view or adjust simply press the **ENT** key to select it.



**AMP ADJ MENU** - This menu item lets you select each individual amplifier connected to the WXRC and view or adjust any of its settings.



Once you select the **AMP ADJ** menu a list of all the amplifiers connected to the WXRC will be available. The list will show the current name of the WX Series amplifier.



Use the **UP** and **DOWN** keys to scroll through the list of available amplifiers. If you have several of the same model of amplifier installed and did not change the name prior to installing the WXRC then you will see the same name when you press the **UP** or **DOWN** keys on the WXRC. In other words it appears like nothing changed. It did...just read on.

To help you identify which amp you are currently viewing simply press and hold the **ENT** key and the Remote Address of the amplifier will be displayed. This will aid you in determining which amp you are currently viewing when you have multiple amps of the same make.



Changing the amplifiers name (coming up later in the manual) will help you here. Once you have found the amplifier you wish to adjust simply press the **ENT** key to select it.

Once the amplifier you want to adjust is selected you will be able to choose from the following items. Some of these functions may not be available depending on if the amplifier is assigned to a Group and what LINK property the group has set. This is described in more detail in the WXRC SETUP menu.

- » GAIN
- » EQ
- » LO-PASS
- » HI-PASS
- » PHASE
- » MUTE
- » LIMITER
- » GAIN RANGE
- » NOISE GENERATOR
- » REMOTE VOL

Use the **UP** and **DOWN** keys to scroll through the selections above and press the **ENT** key to select.

**GAIN MENU** - Here is where you adjust the selected amplifier's gain controls. The WX Series amplifiers' UltraMatch™ gain structure features both a digital input gain attenuator with Gain Ranges AND 12dB of "tweakable" Gain adjustment in each range! This super wide adjustment range allows WX amplifiers to operate flawlessly with any source unit, pre-amplifier, or line driver.

Now use the **UP** and **DOWN** keys to increase or decrease the gain of the selected channel(s) in .5 dB increments from 0 dB to +30 dB. (0.0 to 30.0)



When you are done adjusting the gain on this amplifier press the **ESC** key to return to the AMP ADJ menu and choose another function to adjust.

**EQ MENU** - Here is where you adjust the selected amplifier's single band parametric equalizer.

Use the **UP** and **DOWN** keys to scroll through **FREQUENCY**, **BOOST** and **BANDWIDTH** and then press the **ENT** key to select.



**FREQUENCY** selects the center frequency of the equalizer and can be set at 20 Hz to 200 Hz in 1 Hz Steps.

Use the **UP** and **DOWN** keys to select your frequency. Press the **ESC** key to save your setting and return to the **FREQUENCY**, **BOOST**, **BANDWIDTH** options menu. You can now select another equalizer option to adjust on this amplifier if desired.



**BANDWIDTH** (better known as Q) can be set from 0 to 10 in .5 increments. In simple terms, lower Q effects more frequencies around the center frequency while higher Q effects fewer frequencies around the center frequency.

As an example, if our center frequency is 100 HZ, a Q of .5 (area in gray) effects many more frequencies around 100 Hz than a Q of 10 (area in black) There is no right or wrong Q, you use whatever fits the needs of the system or personal taste. KICKER uses a default Q of 3.

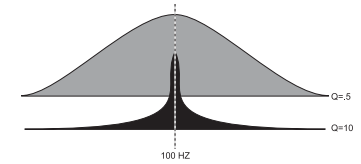

Use the **UP** and **DOWN** keys to select your bandwidth (Q) value and press the **ESC** to save your setting and return to the **FREQUENCY**, **BOOST**, **BANDWIDTH** options menu. You can now select another equalizer option to adjust on this amplifier if desired.

**BOOST** is where you boost the equalizer and has a range of  $\pm 18$  dB in .5 dB steps. Keep in mind that for every 3 dB of boost you are requiring the amplifier to use twice as much power in that equalized area. The default setting from KICKER is **FLAT** (No boost or cut).

Use the **UP** and **DOWN** keys to adjust your boost or cut and press the **ESC** key to save your setting and return to the **FREQUENCY**, **BOOST**, **BANDWIDTH** options menu. You can now select another equalizer option to adjust on this amplifier if desired.



When you are done adjusting the equalizer on this amplifier press the **ESC** key while in the **FREQUENCY**, **BOOST**, **BANDWIDTH** options menu to return to the AMP ADJ menu and choose another function to adjust.



**NOTE:** While you are in the EQ menu the EQ indicator on the ISIS display is lit. This indicates you are making adjustments in the EQ menu.



**LO-PASS MENU** - Here is where you adjust the selected amplifier's low pass crossover.

Use the **UP** and **DOWN** keys to scroll through **FREQUENCY** and **SLOPE** and then press the **ENT** key to select.



**FREQUENCY** selects the crossover point and can be set at 20Hz to 200 Hz in 1 Hz steps.

Use the **UP** and **DOWN** keys to select your frequency. Press the **ESC** key to save your setting and return to the **FREQUENCY** and **SLOPE** options menu. You can now select another low pass crossover option to adjust on this amplifier if desired.



**SLOPE** selects the roll-off of the crossover and can be set from 6 dB to 48 dB in 6 dB Steps.

Use the **UP** and **DOWN** keys to select your low pass crossover slope. Press the **ESC** key to save your setting and return to the **FREQUENCY** and **SLOPE** options menu. You can now select another low pass crossover option to adjust on this amplifier if desired.



When you are done adjusting the low pass crossover on this amplifier press the **ESC** key while in the **FREQUENCY** and **SLOPE** options menu to return to the AMP ADJ menu and choose another function to adjust.



**NOTE:** While you are in the LO-PASS menu the LPP indicator on the ISIS display is lit. This indicates you are making adjustments in the LO-PASS menu.



The KICKER WXRC monitors and prevents any low pass crossover point from being set any closer than 1/3 octave from the high pass crossover point. If you cannot set the low pass crossover where you want then check the ISIS display and see if the *LPF* is lit and the *HPF* indicator is flashing. If it is then you need to go to the HI-PASS menu and lower the high pass crossover point.



This is done as a safety precaution to prevent a notch filter condition.

**HI-PASS MENU** - Here is where you adjust the selected amplifier's high pass crossover.

Use the **UP** and **DOWN** keys to scroll through *FREQUENCY* and *SLOPE* and then press the **ENT** key to select.



*FREQUENCY* selects the crossover point and can be set at any 1/12th octave spaced frequency from 15 Hz to 159 Hz in 1 Hz steps.

Use the **UP** and **DOWN** keys to select your frequency. Press the **ESC** key to save your setting and return to the *FREQUENCY* and *SLOPE* options menu. You can now select another high pass crossover option to adjust on this amplifier if desired.



*SLOPE* selects the roll-off of the crossover and can be set in 6 dB steps. WX.1 Series is 6 dB to 24 dB in 6 dB Steps.

Use the **UP** and **DOWN** keys to select your high pass crossover slope. Press the **ESC** key to save your setting and return to the *FREQUENCY* and *SLOPE* options menu. You can now select another high pass crossover option to adjust on this amplifier if desired.



When you are done adjusting the high pass crossover on this amplifier press the **ESC** key while in the *FREQUENCY* and *SLOPE* options menu to return to the AMP ADJ menu and choose another function to adjust.



**NOTE:** While you are in the HI-PASS menu the *HPF* indicator on the ISIS display is lit. This indicates you are making adjustments in the HI-PASS menu.



The KICKER WXRC monitors and prevents any high pass crossover point from being set any closer than 1/3 octave from the low pass crossover point. If you cannot set the high pass crossover where you want then check the ISIS display and see if the *HPF* is lit and the *LPF* indicator is flashing. If it is then you need to go to the LO-PASS menu and raise the low pass crossover point.

This is done as a safety precaution to prevent a notch filter condition.

**PHASE MENU** - Here is where you can switch the polarity of the output between 0 or 180 degrees.

Use the **UP** or **DOWN** keys to select from *0 DEGREE* or *180 DEGREE*. Press the **ESC** key to save your setting and exit the PHASE menu.

**NOTE:** While you are in the PHASE menu the *PHASE* indicator on the ISIS display is lit. This indicates you are making adjustments in the PHASE menu. By default, all amplifiers are set to 0 Degree.

**MUTE MENU** - Here is where you can mute the the output on the amplifier for setup or testing purposes.

Use the **UP** or **DOWN** keys to select from *MUTE ON* or *MUTE OFF*. Press the **ESC** key to save your setting and return to the AMP ADJ menu and choose another function to adjust.



**NOTE:** While you are in the MUTE menu the *MUTE* indicator on the ISIS display is lit. This indicates you are making adjustments in the MUTE menu.

If you exit the MUTE menu the amplifier muted (*MUTE ON*), the *MUTE* indicator in the ISIS VFD will begin flashing to indicate this.



The *MUTE* indicator will stop flashing once you un-mute the amplifier.

**LIMITER MENU** - Here you can adjust the limiter on the WX amplifier.

While in the LIMITER ADJ Menu, use the **UP** arrow to increase the WX amplifier's RMS output in a range from 0 dB to -10 dB. This controls the power consumption of the amplifier to operate within the limitations of your vehicle's charging system. Using the **DOWN** arrow will reduce the RMS output and also the power consumption of the amplifier.



Press the **ESC** key to save your setting and return to the AMP ADJ menu. You can now choose another function to adjust.



**NOTE:** The limiter is a very special feature of the Warhorse amplifier. It is included to make your high powered stereo system more enjoyable. The expression "it takes power to make power" has never been truer than it is with our 10,000 Watt masterpiece. If you don't have enough output capacity from your alternators to maintain full power from your Warhorse the battery bank will drop in voltage. If your Warhorse doesn't get enough power then it shuts off showing the <Volt LED. This is very frustrating. To avoid this situation you can turn up the Limiter. Apply a higher setting to the Limiter until the Warhorse can play without going into low voltage protection.

Decreasing the RMS output with the limiter does cut down on power consumption, but it allows continuous use. The only way to get more power out of the Warhorse is to supply more charging system power. This may involve a larger alternator or adding a second alternator. More battery capacity will work for short term usage, but the actual power ultimately comes from the alternator(s).

**GAIN RANGE MENU** - Here you can select the WX Series amplifiers' UltraMatch™ digital input gain range. The UltraMatch™ gain structure features four selectable Gain Ranges (1-2-5-10 volt).



In "Gear-Head" terms, the Gain Range and Gain adjustments can be compared to the gear box and gas pedal of a race car. The Gain Range represents what gear you're in and the Gain represents stepping on the gas. In this menu you are adjusting the gear box. THE GAIN RANGE OF YOUR AMPLIFIER NEEDS TO BE CORRECTLY ADJUSTED TO PROVIDE MAXIMUM PERFORMANCE!

Use the **UP** and **DOWN** keys to scroll through *1V RANGE*, *2V RANGE*, *5V RANGE* or *10V RANGE*.





Press the **ESC** key to save your setting and return to the AMP ADJ menu to select another function to adjust.

**NOTE:** While you are in the GAIN RANGE menu the *SYS* and *GAIN* indicators on the ISIS display are lit. This indicates you are making adjustments in the GAIN RANGE menu.

The GAIN RANGE function is a SYSTEM menu function and that is why the *SYS* indicator and the *GAIN* are lit while adjusting the GAIN RANGE function.

**NOISE GEN MENU** - Here you can activate the integrated pink noise generator of the selected WX Series amplifier and is very useful for testing and troubleshooting your system.

Pink noise is a sound made up of equal energy at all 1/3 octaves from 20 Hz to 200 Hz and sounds like the static between radio stations.

When activated, pink noise is generated by the WX amplifier's DSP.

Use the **UP** or **DOWN** keys to scroll through *NOISE OFF* and *NOISE ON*.



Press the **ESC** key to save your setting and return to the AMP ADJ menu to select another function to adjust.



**NOTE:** When the pink noise is activated (*NOISE ON*) the *LEFT* and *RIGHT* indicators on the ISIS display will begin blinking. This indicates that the PINK NOISE generator is active.



If you exit the PINK NOISE menu with the generator on (*NOISE ON*) the *LEFT* and *RIGHT* indicators in the ISIS display will stay flashing to indicate this.

The *LEFT* and *RIGHT* indicators will stop flashing once you turn off (*NOISE OFF*) the pink noise generator.



**REMOTE VOL MENU** - Here you can choose to have the selected WX Series amplifier's output level controlled by the Digital Remote Volume Control (DRVC).

Use the **UP** or **DOWN** keys to scroll through *REMOTE ON* and *REMOTE OFF*.



Press the **ESC** key to save your setting and return to the AMP ADJ menu to select another function to adjust.

**NOTE:** While you are in the REMOTE VOL menu the *SYS* indicator on the ISIS display is lit. This indicates you are making adjustments in the REMOTE VOL menu.



## Group Adjustment

**GROUP ADJ MENU** - This menu item lets you select each amplifier group (up to 10 can be created in the WXRC SETUP menu) connected to the WXRC and view or adjust any of its settings.



This section describes how to adjust the settings in each group. See the WXRC SETUP section later in the manual for a complete description on amplifier group setup.

When a group is created from the WXRC SETUP menu it can be set as a LINK ON or a LINK OFF group. All of the GROUP ADJ functions are described in this section but what you can adjust for the group will vary based on this setting.

A LINK ON group allows you to adjust each of the following settings and they are shared for each amplifier in the group:

- »GAIN
- »EQ
- »LO-PASS
- »HI-PASS
- »PHASE
- »MUTE
- »LIMITER
- »GAIN RANGE
- »NOISE GEN

A LINK OFF group allows you to adjust each of the following settings and they are shared for each amplifier in the group:

- »GAIN
- »MUTE
- »LIMITER
- »NOISE GEN

Look for more details and explanations on grouping amplifiers and setting them up in the WXRC SETUP menu of this manual.

Once you select the **GROUP ADJ** menu a list of all the groups created by the WXRC will be available. The list will show the current name of the selected group. This will either be the default name from KICKER (*GROUP-01* through *GROUP-10*) or any name you may have assigned to the group.



Use the **UP** and **DOWN** keys to scroll through the list of available groups.



Once you have found the group you wish to adjust simply press the **ENT** key to select it.

**NOTE:** If the ISIS display reads *N/A* when you enter the GROUP ADJ menu, this signifies that no amplifier groups have been created.



Once the group you want to adjust is selected you will be able to choose from the following items (depending on LINK setting).

- » GAIN
- » EQ
- » LO-PASS
- » HI-PASS
- » PHASE
- » MUTE
- » LIMITER
- » GAIN RANGE
- » NOISE GEN

Use the **UP** and **DOWN** keys to scroll through the selections above and press the **ENT** key to select.

**GAIN MENU** - Here is where you adjust the selected group's gain controls. All amplifiers in the group will be adjusted up or down when you adjust the gain control. If each amplifier has different gain settings, the WXRC will display the gain level of the highest amplifier in the group. It also monitors and maintains any differences between channels or individual amplifiers that you may have set separately. If you can not adjust a group up or down, then it means the channel differences are being maintained and there is no where to go. You will need to adjust each amplifier individually or set each amplifier's gain to a similar setting.

Here is an example:

Group-01 has two amplifiers in it, amp 1 has both channels gain set at 12.0 while amp 2 is at 0.0. When you select this group to adjust the gain you will see 12.0 in the display, the highest gain setting of the group.

When you try to increase or decrease the gain setting of this group, nothing will happen. Since the gain range is 12 dB (0.0 dB to 12.0 dB) there is no way to increase or decrease the gain and maintain 12 dB of difference between the amplifiers. The WXRC is maintaining the differences you set between the amplifiers.

**EQ MENU** - Here is where you adjust the selected group's EQ controls. All amplifiers in the group will be adjusted.

Use the **UP** and **DOWN** keys to scroll through **FREQUENCY**, **BOOST** and **BANDWIDTH** and then press the **ENT** key to select.

**FREQUENCY** selects the center frequency of the equalizer and can be set at any 1/12th octave spaced frequency from 20 Hz - 200Hz. (20 Hz to 200 Hz)

Use the **UP** and **DOWN** keys to select your frequency. Press the **ESC** key to save your setting and return to the **FREQUENCY**, **BOOST**, and **BANDWIDTH** options menu. You can now select another equalizer option to adjust on this group if desired.

**BANDWIDTH** (better known as Q) can be set from .5 to 10 in .5 increments. In simple terms, lower Q effects more frequencies around the center frequency while higher Q effects fewer frequencies around the center frequency.

Use the **UP** and **DOWN** keys to select your bandwidth (Q) value and press the **ESC** to save your setting and return to the **FREQUENCY**, **BOOST**, **BANDWIDTH** options menu. You can now select another equalizer option to adjust in this group if desired.



**BOOST** is where you boost or cut the equalizer and has a range of 0 dB to +18 dB in .5 dB steps. Keep in mind that for every 3 dB of boost you are requiring the amplifier to use twice as much power in that equalized area. The default setting from KICKER is **FLAT** (No boost or cut).

Use the **UP** and **DOWN** keys to adjust your boost or cut and press the **ESC** key to save your setting and return to the **FREQUENCY**, **BOOST**, **BANDWIDTH** options menu. You can now select another equalizer option to adjust in this group if desired.

When you are done adjusting the equalizer in this group press the **ESC** key while in the **FREQUENCY**, **BOOST**, **BANDWIDTH** options menu to return to the **GROUP ADJ** menu and choose another function to adjust.

**NOTE:** While you are in the EQ menu the **EQ** indicator on the ISIS display is lit. This indicates you are making adjustments in the EQ menu.



**LO-PASS MENU** - Here is where you adjust the selected group's low pass crossover controls. All amplifiers in the group will be adjusted.

Use the **UP** and **DOWN** keys to scroll through **FREQUENCY** and **SLOPE** and then press the **ENT** key to select.

**FREQUENCY** selects the crossover point and can be set at 20 Hz to 200 Hz in 1 Hz steps.

Use the **UP** and **DOWN** keys to select your frequency. Press the **ESC** key to save your setting and return to the **FREQUENCY** and **SLOPE** options menu. You can now select another low pass crossover option to adjust in this group if desired.

**SLOPE** selects the roll-off of the crossover and can be set from 6 to 48 dB/OCT in 6 dB steps.

Use the **UP** and **DOWN** keys to select your low pass crossover slope. Press the **ESC** key to save your setting and return to the **FREQUENCY** and **SLOPE** options menu. You can now select another low pass crossover option to adjust in this group if desired.

When you are done adjusting the low pass crossover in this group press the **ESC** key while in the **FREQUENCY** and **SLOPE** options menu to return to the **GROUP ADJ** menu and choose another function to adjust.

**NOTE:** While you are in the LO-PASS menu the **LPF** indicator on the ISIS display is lit. This indicates you are making adjustments in the LO-PASS menu.

The KICKER WXRC monitors and prevents any low pass crossover point from being set any closer than 1/3 octave from the high pass crossover point. If you cannot set the low pass crossover where you want then check the ISIS display and see if the **LPF** is lit and the **HPF** indicator is flashing. If it is then you need to go to the **GROUP ADJ**. **HI-PASS** menu and lower the high pass crossover point. This is done as a safety precaution to prevent a notch filter condition.

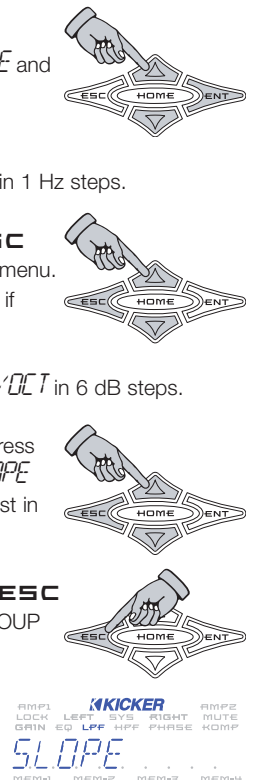

**PHASE MENU** - Here is where you can adjust the selected group's polarity output between 0 or 180 degrees. All amplifiers in the group will be adjusted.

Use the **UP** or **DOWN** keys to select from *0 DEGREE* or *180 DEGREE*. Press the **ESC** key to save your setting



When you are done adjusting the phase in this group press the **ESC** key to return to the GROUP ADJ menu and choose another function to adjust.

**NOTE:** While you are in the PHASE menu the *PHASE* indicator on the ISIS display is lit. This indicates you are making adjustments in the PHASE menu.

By default, all channels in all amplifiers are set to 0 Degree.

**MUTE MENU** - Here is where you can mute the output in the selected group for setup or testing purposes.

Use the **UP** or **DOWN** keys to select from *MUTE ON* or *MUTE OFF*. Press the **ESC** key to save your setting and return to the GROUP ADJ menu and choose another function to adjust.



**NOTE:** While you are in the MUTE menu the *MUTE* indicator on the ISIS display is lit. This indicates you are making adjustments in the MUTE menu.

If you exit the MUTE menu with the amplifier muted (*MUTE ON*), the *MUTE* indicator in the ISIS display will begin flashing to indicate this.



The *MUTE* indicator will stop flashing once you un-mute the amplifier.



**LIMITER MENU** - Here you can adjust the selected group's Limiter settings. The function will vary depending on if this is a LINK ON or LINK OFF group. Both functions are described below.

#### LINK ON

In a LINK ON group, each amplifier in the group shares the exact same Limiter setting.

Use the **UP** or **DOWN** keys to adjust the RMS Output on the Warhorse Amplifier. Pressing the UP arrow increases RMS output on all of the amplifiers in the group, while pressing the DOWN arrow reduces the RMS output of all the amplifiers in the group.



Press the **ESC** key to save your setting and return to the GROUP ADJ menu and choose another function to adjust.



#### LINK OFF

In a LINK OFF group, each amplifier in the group has its own unique Limiter setting that has been selected from the AMP ADJ menu. Here you can, as a group, turn the Limiter OFF or ON, ON being the individual setting you selected from the AMP ADJ menu.

Use the **UP** or **DOWN** keys to scroll through *OFF* and *ON*.

Press the **ESC** key to save your setting and return to the GROUP ADJ menu and choose another function to adjust.



**NOTE:** While you are in the Limiter menu the *LIMITER* indicator on the ISIS display is lit. This indicates you are making adjustments in the Limiter menu.

See the operation page in this manual for a brief description for setting the Limiter.

**GAIN RANGE MENU** - Here you can adjust the selected group's UltraMatch™ digital input gain range. The UltraMatch™ gain structure features four selectable Gain Ranges (1 volt, 2 volt, 5 volt, 10 volt).

In "Gear-Head" terms, the Gain Range represents what gear you're in and the Gain adjustment represents stepping on the gas. In this menu you are adjusting the gear box. This group adjustment sets the Gain Range of all the amplifiers in the group to the same setting. **THE GAIN RANGE OF YOUR AMPLIFIER NEEDS TO BE CORRECTLY ADJUSTED TO PROVIDE MAXIMUM PERFORMANCE!**

Use the **UP** and **DOWN** keys to scroll through *1V RANGE*, *2V RANGE*, *5V RANGE*, *10V RANGE*.



Press the **ESC** key to save your setting and return to the GROUP ADJ menu to select another group function to adjust.



**NOTE:** While you are in the GAIN RANGE menu the *SYS* and *GAIN* indicators on the ISIS display are lit. This indicates you are making adjustments in the GAIN RANGE menu.

The GAIN RANGE function is a SYSTEM menu function and that is why the *SYS* and the *GAIN* indicators are lit while adjusting the GAIN RANGE function.



**NOISE GEN MENU** - Here you can activate the selected group's integrated pink noise generator for testing and troubleshooting your system. Pink noise is a sound made up of equal energy at all 1/3 octaves from 20 Hz to 20 kHz and sounds like the static between radio stations. When activated, pink noise is generated by all the WX Series amplifier's in this selected group.

Use the **UP** or **DOWN** keys to scroll through *NOISE OFF* and *NOISE ON*. Press the **ESC** key to save your setting and return to the GROUP ADJ menu and choose another function to adjust.



**NOTE:** When the pink noise is activated (*NOISE ON*) the *LEFT* and *RIGHT* indicators on the ISIS display will begin blinking. This indicates that the PINK NOISE generator is active.

If you exit the PINK NOISE menu with the generator on (*NOISE ON*) the *LEFT* and *RIGHT* indicators in the ISIS display will stay flashing to indicate this.

The *LEFT* and *RIGHT* indicators will stop flashing once you turn off (*NOISE OFF*) the pink noise generator.



## WXRC Setup

**WXRC SETUP MENU** - This menu item lets you select and adjust many operating parameters for your WXRC, create amplifier groups, change names, change lock codes. A lot of very powerful tools and functions are built into your WXRC.

Here is a list of the menu items contained in the WXRC SETUP menu:

» DISPLAY	» AMP NAME
» GROUP AMPS	» LOCK CODE
» WXRC NAME	» RESET WXRC
» MEM NAME	» ABOUT

Use the **UP** and **DOWN** arrow keys to scroll through the available selections in the WXRC SETUP menu.



When you have the menu item selected that you want to view or adjust simply press the **ENT** key to select it.

**DISPLAY MENU** - Here you can adjust the items displayed in the DEFAULT menu as well as customize the display to fit your use.

Here is a list of the menu items contained in the DISPLAY menu:

» BRIGHTNESS	» SET TIME
» TEMP. C/F	» INFO AMP
» HOLD TIME	» LED ON LVL
» SCREENSAVER	» LED DIM LVL
» SET DATE	» LED TIME

Use the **UP** and **DOWN** arrow keys to scroll through the available selections in the DISPLAY menu.



When you have the menu item selected that you want to view or adjust simply press the **ENT** key to select it.

**BRIGHTNESS MENU** - Here you can adjust the intensity level of the ISIS display from 1 of 5 different levels.

Use the **UP** and **DOWN** arrow keys to scroll through the available settings:  
**MAXIMUM, HIGH, MEDIUM, LOW, MINIMUM.**



Press the **ESC** key to save your setting and return to the DISPLAY menu to select another display function to adjust.

**TEMP C/F MENU** - Here you can select in which format, Celsius or Fahrenheit, the temperature readings are displayed.

Use the **UP** or **DOWN** arrow keys to scroll through the available settings:  
**FAHRENHEIT** and **CELSIUS.**



Press the **ESC** key to save your setting and return to the DISPLAY menu to select another display function to adjust.

**HOLD TIME MENU** - Here you can select how long each item in the DEFAULT menu pauses (1 to 11 seconds) before scrolling continues. The default setting for this 2 seconds.

Use the **UP** and **DOWN** arrow keys to scroll through the available settings:  
**1 SEC.** to **11 SEC.** in 1 second increments.

Press the **ESC** key to save your setting and return to the DISPLAY menu to select another display function to adjust.

**SCREENSAVER MENU** - Here you can turn on (**AUTO**) or off (**OFF**) the built in screensaver function for the ISIS display. If turned on, the display will power down and go blank after 90 seconds with no key press activity. Pressing any key on the WXRC will wake up the screen.

Use the **UP** or **DOWN** arrow keys to scroll through the available settings:  
**OFF** and **AUTO.**



Press the **ESC** key to save your setting and return to the DISPLAY menu to select another display function to adjust.

**SET DATE MENU** - Here is where you can set the proper date (Month, Day, Year) that is displayed in the scrolling DEFAULT menu. The WXRC contains a backup battery good for 5 years to maintain this setting even if power is removed from the unit.

The month will begin blinking when you enter the menu. Use the **UP** and **DOWN** arrow keys to scroll through and set the month. Press the **ENT** key to save the month setting and advance to the day.



The day will begin blinking, use the **UP** and **DOWN** arrow keys to scroll through and set the day. Press the **ENT** key to save the day setting and advance to the year.

The year will begin blinking, use the **UP** and **DOWN** arrow keys to scroll through and set the year. Press the **ENT** key to save the year setting and return to the month.



**PRESS & HOLD** When you have set the month, day and year correctly then press and hold the **HOME** key for 1.5 seconds to save your settings and return to the DISPLAY menu.

When saved the display will return to the DISPLAY menu.

**NOTE:** After 3 minutes without any key press activity, the WXRC will save the current date settings and return to the scrolling DEFAULT menu.

**SET TIME MENU** - Here is where you can set the proper time in am/pm format that is displayed in the scrolling DEFAULT menu. It is also protected by the backup battery.



The hour will begin blinking when you enter the menu. Use the **UP** and **DOWN** arrow keys to scroll through and set the hour. Press the **ENT** key to save the hour setting and advance to the minutes.

The minutes will begin blinking, use the **UP** and **DOWN** arrow keys to scroll through and set the minutes. Press the **ENT** key to save the minutes setting and advance to the am/pm selection.



The am/pm indicator will begin blinking, use the **UP** and **DOWN** arrow keys to select *Am* or *Pm*. Press the **ENT** key to save the am/pm setting and advance to the hour.



When you have set the time correctly then press and hold the HOME key for 1.5 seconds to save your settings and return to the DISPLAY menu.



**NOTE:** After 3 minutes without any key press activity, the WXRC will save the current time settings and return to the scrolling DEFAULT menu.

**LED ON LVL MENU** - The backlit keys on the WXRC have two intensity modes, On and Dim. When the keys are pressed and in use they will brighten to the level set in this menu. The default setting from KICKER is 11.



Use the **UP** and **DOWN** arrow keys to scroll through the available settings: 11 (Brightest) to 3 (Off)

Press the **ESC** key to save the setting and return to the DISPLAY menu.



**NOTE:** As you lower the brightness level of the LED ON LVL you may not be able to reach the 0 setting. This is because the On level can not be set any lower than the current Dim level. So...if the Dim level (discussed next) is set to 3, you would only be able to lower the On level to 3. If you want to use a lower value for the On level you will need to lower the value of the Dim level.

**LED DIM LVL MENU** - The backlit keys on the WXRC have two intensity modes, On and Dim. When the keys are not being used they will dim to the level set in this menu. The default setting from KICKER is 3.



Use the **UP** and **DOWN** arrow keys to scroll through the available settings: 11 (Brightest) to 0 (Off)

Press the **ESC** key to save the setting and return to the DISPLAY menu.



**NOTE:** As you raise the brightness level of the LED DIM LVL you may not be able to reach the 11 setting. This is because the Dim level can not be set any higher than the current On level. So...if the On level (discussed previously) is set to 7, you would only be able to raise the Dim level to 7. If you want to use a higher value for the Dim level you will need to raise the value of the On level.

**LED TIME MENU** - The backlit keys on the WXRC have two intensity modes, On and Dim. This menu lets you select how long the WXRC waits when there is no button press activity before switching from the On level to the Dim level. The default is 90 seconds.



Use the **UP** and **DOWN** arrow keys to scroll through the available settings: 1 SEC (shortest delay) to 240 SEC (longest delay)



Press the **ESC** key to save the setting and return to the DISPLAY menu.

**NOTE:** This menu item works hand-in-hand with the LED ON LVL and LED DIM LVL menu items. Use this menu setting to determine how long your ISIS keys stay brightly lit after making your WXRC adjustments.



At this point you have explored all the settings in the DISPLAY menu. Press the **ESC** key to return to the WXRC SETUP menu.

**GROUP AMPS MENU** - Here you can create and customize amplifier groups in the WXRC. This is one of the most powerful and fun functions of the WXRC. Once you assign an amplifier to a group, it and all the other amplifiers in its' group can be adjusted in unison from the GROUP ADJ menu. All amplifiers in a group still maintain the ability to be adjusted individually in the AMP ADJ menu even when they are grouped...just what functions are accessible will vary based on the group setup.

The complete list of what functions can be controlled together (*GROUP ADJ*) or separately (*AMP ADJ*) are described in the LINK menu a little bit later in the manual.

The WXRC has 10 groups (*GROUP-01* through *GROUP-10*) for you to use. Each of these groups is capable of having up to 16 amplifiers assigned to it. No more than 16 amps total can be controlled by the WXRC. So if you have 16 amplifiers connected to the WXRC and you assign all 16 to Group-01, you can not create any more groups.

**Example** You have multiple amplifiers driving your subwoofer(s) and want to control all of them at the same time. Change a setting and have it changed in all of the amplifiers simultaneously.

Here is a list of the menu items contained in the GROUP AMPS menu.

- » GROUPS
- » GROUP NAME
- » ASSIGN
- » RELEASE
- » LINK
- » REMOTE VOL

Use the **UP** and **DOWN** arrow keys to scroll through the available selections in the GROUP AMPS menu.



When you have the menu item selected that you want to view or adjust simply press the **ENT** key to select it.



**RELEASE MENU** - Here you can remove any amplifier(s) from a group it is currently assigned to.

Use the **UP** or **DOWN** keys to select which group you want to release an amplifier(s) from and press the **ENT** key to select it.



If the display shows *N/A* then there are no amplifiers currently assigned to that group.

If there are amps assigned to the group then use the **UP** or **DOWN** keys to scroll through the list of amplifiers.



If you have multiple amps of the same make or name you can check its' Remote Address to help you identify which amp you are currently viewing. Simply press and hold the **ENT** key and the Remote Address of the amplifier will be displayed.



Press **ENT** to remove the selected amplifier from the current selected group.



The display will flash **RELEASED** to confirm the amplifier has been removed. Once an amplifier is removed from a group it is added back to the list of available amplifiers in the **ASSIGN** menu.



Continue releasing the amplifiers you want removed from this group by using the **UP** or **DOWN** keys to select the amp and the **ENT** key to select it.



When you are done releasing amplifiers from this group, press the **ESC** key to return to the **RELEASE** menu's group selection screen. You can then select another group to release amplifiers from.



**NOTE:** While selecting amplifiers to remove from a group, If you remove all the amplifiers the display will read *N/A* letting you know there are no more amplifiers assigned to this group.



**LINK MENU** - Here you can set the Link property of the selected group to Link On or Link Off. By default all groups have the Link property set to Link Off.

The Link property sets a group to have certain characteristics depending on the setting (Link On or Link Off). By adjusting this one setting you completely change what settings and adjustments are shared between amplifiers in the group, what settings you can select to adjust in the **AMP ADJ** and **GROUP ADJ** menus and how certain settings act once they are selected. You have all ready seen an example of this in the **GROUP ADJ** menu when adjusting the Limiter.

**Link Off - AMP ADJ** If you set the group's Link property to Link Off each amplifier in the group can have these items adjusted from the **AMP ADJ** menu.

- » *GAIN*
- » *EQ*
- » *LO-PASS*
- » *HI-PASS*
- » *PHASE*
- » *MUTE*
- » *LIMITER*
- » *GAIN RANGE*
- » *NOISE GEN*

#### Link Off - GROUP ADJ

If you set the group's Link property to Link Off each amplifier in the group can have these items adjusted from the **GROUP ADJ** menu.

- » *GAIN*
- » *MUTE*
- » *LIMITER*
- » *NOISE GEN*

#### Link On - AMP ADJ

If you set the group's Link property to Link On each amplifier in the group can have these items adjusted from the **AMP ADJ** menu.

- » *GAIN*
- » *MUTE*

#### Link On - GROUP ADJ

If you set the group's Link property to Link On each amplifier in the group can have these items adjusted from the **GROUP ADJ** menu.

- » *GAIN*
- » *EQ*
- » *LO-PASS*
- » *HI-PASS*
- » *PHASE*
- » *MUTE*
- » *LIMITER*
- » *GAIN RANGE*
- » *NOISE GEN*

Wow...things do change up quite a bit. But why? Glad you asked! The following example shows why this happens and why the Link function exists...but we know there are many more.

**Example** You have four Warhorse amplifiers driving four SoloX Woofers. You would want to control all of these amplifiers together and share many settings between them the same since they are all on bass duty.

You would select a group and assign each of your four Warhorse amplifiers to this group. For this example we will assume you also changed the name of the group to **BIG BASS**.

Next select the **BIG BASS** group from the **LINK** menu and set its Link Property to Link On.

Now you would be able to set the gain range, gain, equalizer, low pass crossover, high pass crossover, Limiter, etc. for all four amplifiers at the same time using the **BIG BASS** group you created. Each amplifier would share these important settings and you don't have to adjust four amplifiers, just adjust the **BIG BASS** group from the **GROUP ADJ** menu and that's it.

The only options you would be able to adjust from the **AMP ADJ** menu would be each amplifiers individual gain setting and mute function.

The gain setting allows you to level match each amplifier in the group independently in case one channel or amp needs to be tweaked to match the rest.

The mute function is for muting individual channels or entire amplifiers for setup and testing purposes.

Once you select the **LINK** menu, a list of all 10 groups controlled by the WXRC will be displayed in a scrolling list. The list will either display the names you have created or the default names if you have not re-named them.



Use the **UP** or **DOWN** keys to scroll through the list of groups and press the **ENT** key to select.

Use the **UP** or **DOWN** keys to select **LINK ON** or **LINK OFF** for the group.



When done selecting the current group's Link property, press the **ESC** key to save the setting and return to the list of groups.

You can now select another group to view or adjust by using the **UP** or **DOWN** keys and select it by pushing the **ENT** key.



OR



Press the **ESC** key to return to the GROUP AMPS menu and select another function.

**REMOTE VOL MENU** - Here you can choose to have the selected group's output level controlled by the Digital Remote Volume Control (DRVC).

If you wish to use the DRVC as a master volume control, raising and lowering the output level of all the amplifiers, select all the groups and set to them **REMOTE ON**. By default, all groups are set to **REMOTE OFF**.

Use the **UP** or **DOWN** keys to scroll through the list of groups and press the **ENT** key to select.



Use the **UP** or **DOWN** keys to scroll through **REMOTE ON** and **REMOTE OFF**.

When done selecting the current group's Remote Vol setting, press the **ESC** key to save the setting and return to the list of groups.



**WXRC NAME MENU** - Here you can change the default name of the WXRC controller ("WXRC") to any 10 character name you want. This is the name that scrolls in the DEFAULT menu.



Use the **ESC** and **ENT** keys to move the blinking cursor left or right to select which character you want to change.

Use the **UP** and **DOWN** keys to change the selected character. (A B C ... 1 2 3 ...etc.)



**PRESS & HOLD**

When you are finished press and hold the **HOME** key for 1.5 seconds to save your new WXRC name. You are now back in the WXRC SETUP menu.

**MEM NAME MENU** - Here you can change the default name of each of the four global memories (**MEMORY-1** to **MEMORY-4**) to any 10 character name you want. Very useful for identifying a preset by its purpose (**SPL**, **SOUND Q**, **ROCK**, **RAP**, etc).



Use the **UP** or **DOWN** keys to scroll through the available memories (**MEMORY-1** through **MEMORY-4**)



When you have the memory selected that you want to name simply press the **ENT** key to select it.

You can now use the **ESC** and **ENT** keys to move the blinking cursor left or right to select which character you want to change.



Use the **UP** and **DOWN** keys to change the selected character. (A B C ... 1 2 3 ...etc.)



When you are finished press and hold the **HOME** key for 1.5 seconds to save your new group name.



**PRESS & HOLD**

You can now select another Memory Name to re-name or press the **ESC** key to return to the WXRC SETUP menu.

**AMP NAME MENU** - Here you can change the default name of each WX Series amplifier to any 10 character name you want.

Use the **UP** or **DOWN** keys to scroll through the amplifiers connected to the WXRC.



When you have the amplifier selected that you want to re-name simply press the **ENT** key to select it.

You can now use the **ESC** and **ENT** keys to move the blinking cursor left or right to select which character you want to change.



Use the **UP** and **DOWN** keys to change the selected character. (A B C ... 1 2 3 ...etc.)

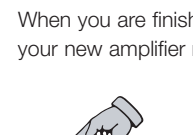

When you are finished press and hold the **HOME** key for 1.5 seconds to save your new amplifier name.



**PRESS & HOLD**

You can now select another amplifier to re-name or press the **ESC** key to return to the WXRC SETUP menu.

**LOCK CODE MENU** - Here you can change the default security lock code used for the WXRC Security function. This code is used to unlock the WXRC after it has been locked to prevent un-authorized use. The default lock code is *123*.

Use the **ESC** and **ENT** keys to move the blinking cursor left or right to select which character you want to change.



Use the **UP** and **DOWN** keys to change the selected character. (A B C... 1 2 3...etc.)

When you are finished press and hold the **HOME** key for 1.5 seconds to save your new security lock code. You are now back in the WXRC SETUP menu.



**NOTE:** Please write down your lock code and keep it in a safe place. If you lock the WXRC you will need this code to un-lock the unit. If you have lost your lock code you will have to ask a KICKER tech what magic he may be able to work for you.

**RESET WXRC MENU** - Sometimes things just go wacky and the only way to fix things is to start fresh. Or perhaps you just want to start with a clean new slate. Either way, RESET WXRC works for us.

The WXRC is designed to handle the automotive electrical system and all its wonderful peculiarities but extreme low voltage conditions in your car, jump starting, voltage spikes, etc. could cause glitches or errors in your WXRC settings. If this ever happens here is where you can fix it.

Use the **UP** or **DOWN** arrow keys to select *SKIP RESET* or *DO RESET* and press the **ENT** key to select.



The WXRC will perform a complete reset back to factory defaults...

## WXRC Security

**SECURITY MENU** - Want to keep your friends from adjusting your system to their tastes instead of yours? The WXRC lets you do it! Here you get to lock out the controls and prevent tampering with your system settings.

When the WXRC is locked down you will still see all of the DEFAULT menu items scrolling through the display, you can freeze and un-freeze the scrolling and you can adjust the Digital Remote Volume Control. These are the only controls accessible when the WXRC is locked.

Use the **UP** or **DOWN** arrow keys to scroll through the selections and press the **ENT** key to select.



**DON'T LOCK** does just that. It skips the entire locking function and returns to the MAIN menu.

**LOCK WXRC** locks out all the WXRC controls.

**UNLOCK** unlocks the controls on all WX Series amplifiers connected to the WXRC.

If you select any of the Lock functions, the WXRC will flash LOCKED in the display to verify the lock has completed successfully.

Once the WXRC is locked it will return to the DEFAULT menu and the **LOCK** indicator will be lit in the ISIS display.



From the DEFAULT menu press the **ENT** key to unlock the WXRC.



The display will show **UNLOCK**. Press the **ENT** key again to enter the UNLOCK menu and enter your code.

Use the **ESC** and **ENT** keys to move the blinking cursor left or right to select which character you want to change.



Use the **UP** and **DOWN** keys to change the selected character.

(A B C... 1 2 3...etc.)



When you are finished press and hold the **HOME** key for 1.5 seconds to enter your unlock code.



If the code is correct the WXRC will unlock and return to the MAIN menu. If this did not happen, then read on...





If you enter the wrong code the display will flash the message **BAD CODE** and return you to the UNLOCK menu.

Press the **ENT** key to enter your lock code again. Enter your code again making sure to place the correct character in the correct position in the display. Blank spaces count as part of the code so be sure you are entering your code correctly.



If you have tried entering your code several times with no success (several is defined as more than 3...less than 10) then you probably have forgotten your lock code.

You will need to call KICKER directly at (405) 624-8583 and speak to a tech to handle this situation. You will need to have your amplifier's serial number AND your receipt by the phone as the guys and gals answering the phone will need this information from you to be of assistance.

Take the time right now to fill out the first page in this manual and staple your receipt to it. That way if you ever need service (like forgetting your lock code) you will have all the information you need right here with the manual.

### Memory Presets

There are four global memory presets built into the WXRC, each with its own indicator in the ISIS display and a dedicated memory key to activate it.

Each memory preset stores all the values shown at the right for each amplifier connected to the WXRC. This gives you the ability to dial in four completely different system settings and store them in the memory presets for instant recall at any time.

- » GAIN
- » EQ
- » LO-PASS
- » HI-PASS
- » PHASE
- » MUTE
- » LIMITER
- » REMOTE VOL

**STORING A PRESET:** To store the current amplifier or group settings in the WXRC into a memory preset simply press and hold the desired memory key until the ISIS display flashes **STORED** and then release the memory key.



**RECALLING A PRESET:** To recall a memory preset simply press and release the desired memory key. The matching indicator in the ISIS display will light up and the WXRC will display **LOADING** while it loads all the settings stored in that preset into each WX Series amplifier.



### WXRC Specifications

Operating Voltage:	9-16 volts DC
Remote Turn-On Voltage:	9-16 volts DC
Maximum Amplifiers:	16 units
DRVC Range:	30 dB
Power, Ground, Remote Terminals:	Removable plug will accept up to 12 gauge wire.
Mounting Hardware:	Standard DIN 7-3/16 x 2-1/8 (182mm x 53mm)

### Troubleshooting

If your WXRC does not appear to be working, check obvious things first such as blown fuses, poor or incorrect wiring connections, cables and connectors not fully seated, etc.

There is a Green LED located on one end of the WXRC Interface Box. This LED indicates the WXRC is receiving power and is turned on.

#### ○ Green LED off:

- ↻ Verify the external fuse to the Interface Box is good.
- ↻ Verify the power plug is fully seated in the Interface Box.
- ↻ Verify the wiring is correct at the power plug.
- ↻ With a Volt Ohm Meter's (VOM) negative probe attached to chassis ground check:
  - ☑ +12 volt power terminal (should read +12V to +16V)
  - ☑ Remote turn-on terminal (should read +12V to +16V)
  - ☑ Ground terminal (should read 0V)

#### ○ Green LED on, no display on WXRC Control Head:

- ↻ Verify the cable from the Control Head is plugged securely into the Interface Box.
- ↻ If using an extension cable between the Interface Box and the Control Head, Verify the connectors are plugged in securely on both ends.
- ↻ If using an extension cable between the Interface Box and the Control Head, Verify the cable is a 6 conductor PS2 type cable.
- ↻ If using an extension cable between the Interface Box and the Control Head, the cable or connectors on it may be bad, try bypassing the extension cable and plugging the Control Head directly into the Interface Box. If this works, then try a new cable.

#### ○ Green LED on, garbage characters in display:

- ↻ Power cycle your system (turn off, wait 3 seconds, turn on).
- ↻ Reset the WXRC from the WXRC SETUP menu.
- ↻ Verify all cables are securely plugged into the Interface Box.
- ↻ Verify all Network Cables are securely plugged in at the Interface Box and WX Series amplifiers.
- ↻ Verify all Network Cables are good. If you made these cables check that they are properly wired and terminated.

#### ○ Green LED on, STARTING \* displayed for a long time, amplifiers not responding:

- ↻ Go back and double check your Communications Network cables and make sure they are inserted properly and 'snapped' into place.
- ↻ If you have purchased different cables, double check that they are 4 Pin S-Video DIN.
- ↻ If you have made your own cables double check them for secure and proper termination.
- ↻ Power cycle your system (turn off, wait 3 seconds, turn on).
- ↻ Reset the WXRC from the WXRC SETUP menu.

#### ○ WXRC displays

- ↻ Autosearch function has failed due to a catastrophic failure, loss of communication network, loss of power during software update.
  - ✓ Go back and double check your Communications Network cables and make sure they are inserted properly and 'snapped' into place.
  - ✓ If you have purchased different cables, double check that they are 4 Pin S-Video DIN.
  - ✓ If you have made your own cables double check them for secure and proper termination.

○ **Everything powers up and looks great, just no sound:**

- ☞ Is the *MUTE* indicator blinking in the WXRC display?. Turn off mute for all amplifiers.
- ☞ Use the Pink Noise function to test system for audio output. The pink noise function injects its signal directly into the amplifier after the DSP processor. This helps to determine if the problem is before the DSP and amplifier or after.
  - ✓ If you have pink noise from all your speakers then check your :
    - Gain Range settings.
    - Gain settings.
    - Crossover settings.
    - RCA cables and connections.
    - Head unit fader, balance and volume controls.
  - ✓ If you don't have pink noise from all your speakers then check your :
    - Speakers.
    - Speaker cables and connections.
    - Amplifier power and speaker connections.

○ **Other problem, I am lost, I don't know, Help:**

- ☞ Contact your local Authorized KICKER Dealer where you purchased your unit for assistance.
- ☞ Contact KICKER Technical Services for assistance.

**CAUTION:** When jump starting the vehicle, be sure that connections made with the jumper cables are correct. Improper connections (+ to - & - to +) will result in blown fuses as well as failure to other systems in the vehicle.

If you have questions about the installation and operation of your new KICKER WXRC Remote Control, see the Authorized KICKER Dealer in your area or contact KICKER Technical Services directly at (405)624-8583.

Use this fill-in-the-blank chart to keep track of your WX Series amplifier's remote address and name. This is very helpful for setting up your WXRC.

Amplifier	Name
Amplifier 1	_____
Amplifier 2	_____
Amplifier 3	_____
Amplifier 4	_____
Amplifier 5	_____
Amplifier 6	_____
Amplifier 7	_____
Amplifier 8	_____
Amplifier 9	_____
Amplifier 10	_____
Amplifier 11	_____
Amplifier 12	_____
Amplifier 13	_____
Amplifier 14	_____
Amplifier 15	_____
Amplifier 16	_____

It is going to happen, you will change your mind or change your system. Just for that need, here is a spare chart. Photocopy this page and you can have all the charts you need.

Amplifier	Name
Amplifier 1	_____
Amplifier 2	_____
Amplifier 3	_____
Amplifier 4	_____
Amplifier 5	_____
Amplifier 6	_____
Amplifier 7	_____
Amplifier 8	_____
Amplifier 9	_____
Amplifier 10	_____
Amplifier 11	_____
Amplifier 12	_____
Amplifier 13	_____
Amplifier 14	_____
Amplifier 15	_____
Amplifier 16	_____

## Manual Contents

Features	p. 2-4	<b>WXRC Setup</b>	<b>p. 22-30</b>
Included Components	p. 3	WXRC Setup Menu	p. 22
ISIS Display	p. 3-4	Display Menu	p. 22
<b>Mounting</b>	<b>p. 4-6</b>	Brightness Menu	p. 22
<b>Wiring</b>	<b>p. 7-8</b>	Temp Menu	p. 22-23
<b>Menu System</b>	<b>p. 9-16</b>	Hold Time Menu	p. 23
Navigation	p. 9	Screensaver Menu	p. 23
Main Menu	p. 10-11	Set Date Menu	p. 23
Amp Adjust Menu	p. 11-12	Set Time Menu	p. 24
Gain Menu	p. 12	LED ON Level Menu	p. 24
EQ Menu	p. 12	LED DIM Level Menu	p. 24
LO Pass Menu	p. 13	LED Time Menu	p. 25
HI Pass Menu	p. 14	Group Amps Menu	p. 25
Phase Menu	p. 14-15	Release Menu	p. 26
Limiter Menu	p. 15	Link Menu	p. 26-28
Gain Range Menu	p. 15-16	Remote Vol Menu	p. 28
Noise Generator Menu	p. 16	WXRC Name Menu	p. 28
<b>Group Adjustment</b>	<b>p. 17-21</b>	Mem Name Menu	p. 29
Group Adjust Menu	p. 17	Amp Name Menu	p. 29
Gain Menu	p. 18	Lock Code Menu	p. 30
EQ Menu	p. 18-19	Reset WXRC Menu	p. 30
LO Pass Menu	p. 19	<b>WXRC Security</b>	<b>p. 31</b>
Phase Menu	p. 20	<b>Memory Presets</b>	<b>p. 32</b>
Mute Menu	p. 20	<b>Specifications</b>	<b>p. 32</b>
Limiter Menu	p. 20-21	<b>TroubleShooting</b>	<b>p. 33-35</b>
Gain Range Menu	p. 21	<b>Warranty Information</b>	<b>p. 38-39</b>
Noise Generator Menu	p. 21		

## Electronics Limited Warranty

Kicker warrants this product to be free from defects in material and workmanship under normal use for a period of THREE (3) MONTHS from date of original purchase with receipt. When purchased from an Authorized KICKER Dealer it is warranted for TWO (2) YEARS from date of original purchase with receipt. In all cases you must have the original receipt. Should service be necessary under this warranty for any reason due to manufacturing defect or malfunction during the warranty period, Kicker will repair or replace (at its discretion) the defective merchandise with equivalent merchandise at no charge. Warranty replacements may have cosmetic scratches and blemishes. Discontinued products may be replaced with more current equivalent products.

This warranty is valid only for the original purchaser and is not extended to owners of the product subsequent to the original purchaser. Any applicable implied warranties are limited in duration to a period of the express warranty as provided herein beginning with the date of the original purchase at retail, and no warranties, whether express or implied, shall apply to this product thereafter. Some states do not allow limitations on implied warranties; therefore these exclusions may not apply to you. This warranty gives you specific legal rights; however you may have other rights that vary from state to state.

### WHAT TO DO IF YOU NEED WARRANTY OR SERVICE

Defective merchandise should be returned to your local Authorized Stillwater Designs (Kicker) Dealer for warranty service. Assistance in locating an Authorized Dealer can be found at [www.kicker.com](http://www.kicker.com) or by contacting Stillwater Designs directly. You can confirm that a dealer is authorized by asking to see a current authorized dealer window decal.

If it becomes necessary for you to return defective merchandise directly to Stillwater Designs (Kicker), call the Kicker Customer Service Department at (405) 624-8510 for a Return Merchandise Authorization (RMA) number. Package all defective items in the original container or in a package that will prevent shipping damage, and return to:

Stillwater Designs, 3100 North Husband Road, Stillwater, OK 74075

The RMA number must be clearly marked on the outside of the package. Please return only defective components. The return of functioning items increases your return freight charges. Non-defective items will be returned freight-collect to you.

Include a copy of the original receipt with the purchase date clearly visible, and a "proof-of-purchase" statement listing the Customer's name, Dealer's name and invoice number, and product purchased. Warranty expiration on items without proof-of-purchase will be determined from the type of sale and manufacturing date code. Freight must be prepaid; items sent freight-collect, or COD, will be refused.

### WHAT IS NOT COVERED?

This warranty is valid only if the product is used for the purpose for which it was designed.

It does not cover:

- o Damage due to improper installation
- o Subsequent damage to other components
- o Damage caused by exposure to moisture, excessive heat, chemical cleaners, and/or UV radiation
- o Damage through negligence, misuse, accident or abuse. Repeated returns for the same damage may be considered abuse
- o Any cost or expense related to the removal or reinstallation of product
- o Speakers damaged due to amplifier clipping or distortion
- o Items previously repaired or modified by any unauthorized repair facility
- o Return shipping on non-defective items
- o Products with tampered or missing barcode labels
- o Products returned without a Return Merchandise Authorization (RMA) number
- o Freight Damage
- o The cost of shipping product to Kicker
- o Service performed by anyone other than Kicker

### HOW LONG WILL IT TAKE?

Kicker strives to maintain a goal of 72-hour service for all electronics (amplifiers, crossovers, equalizers, etc.) returns. Delays may be incurred if lack of replacement inventory or parts is encountered.

Failure to follow these steps may void your warranty. Any questions can be directed to the Kicker Customer Service Department at (405) 624-8510.

Note: To get the best performance from your new Kicker Amplifier, we recommend using genuine Kicker Accessories and Wiring. All specifications and performance figures are subject to change. Please visit the [www.kicker.com](http://www.kicker.com) for the most current information.

## International Warranty

Contact your International Kicker dealer or distributor concerning specific procedures for your country's warranty policies.

WARNING: KICKER products are capable of producing sound levels that can permanently damage your hearing! Turning up a system to a level that has audible distortion is more damaging to your ears than listening to an undistorted system at the same volume level. The threshold of pain is always an indicator that the sound level is too loud and may permanently damage your hearing. Please use common sense when controlling volume.

### GARANTÍA INTERNACIONAL VersiónEspañol

Comuníquese con su concesionario o distribuidor Kicker internacional para obtener información sobre procedimientos específicos relacionados con las normas de garantía de su país.

ADVERTENCIA: Los excitadores Kicker son capaces de producir niveles de sonido que pueden dañar permanentemente el oído. Subir el volumen del sistema hasta un nivel que produzca distorsión es más dañino para el oído que escuchar un sistema sin distorsión al mismo volumen. El dolor es siempre una indicación de que el sonido es muy fuerte y que puede dañar permanentemente el oído. Sea precavido cuando controle el volumen.

La frase "combustible para vivir la vida Livin' Loud™ a todo volumen" se refiere al entusiasmo por la vida que la marca Kicker de estéreos de automóvil representa y a la recomendación a nuestros clientes de que vivan lo mejor posible ("a todo volumen") en todo sentido. La línea de altavoces y amplificadores Kicker es la mejor del mercado de audio de automóviles y por lo tanto representa el "combustible" para vivir a todo volumen en el área de "estéreos de automóvil" de la vida de nuestros clientes. Recomendamos a todos nuestros clientes que obedezcan todas las reglas y reglamentos locales sobre ruido en cuanto a los niveles legales y apropiados de audición fuera del vehículo.

### INTERNATIONALE GARANTIE DeutscheVersion

Nehmen Sie mit Ihren internationalen Kicker-Fachhändler oder Vertrieb Kontakt auf, um Details über die Garantieleistungen in Ihrem Land zu erfahren.

WARNUNG: KICKER-Treiber können einen Schallpegel erzeugen, der zu permanenten Gehörschäden führen kann! Wenn Sie ein System auf einen Pegel stellen, der hörbare Verzerrungen erzeugt, schadet das Ihren Ohren mehr, als ein nicht verzerrtes System auf dem gleichen Lautstärkepegel. Die Schmerzschwelle ist immer eine Anzeige dafür, dass der Schallpegel zu laut ist und zu permanenten Gehörschäden führen kann. Seien Sie bei der Lautstärkeeinstellung bitte vernünftig!

Der Slogan "Treibstoff für Livin' Loud" bezieht sich auf die mit den Kicker-Autostereosystemen assoziierte Lebensfreude und die Tatsache, dass wir unsere Kunden ermutigen, in allen Aspekten ihres Lebens nach dem Besten ("Livin' Loud") zu streben. Die Lautsprecher und Verstärker von Kicker sind auf dem Markt für Auto-Soundsysteme führend und stellen somit den "Treibstoff" für das Autostereoerlebnis unserer Kunden dar. Wir empfehlen allen unseren Kunden, sich bezüglich der zugelassenen und passenden Lautstärkepegel außerhalb des Autos an die örtlichen Lärmvorschriften zu halten.

### GARANTIE INTERNATIONALE VersionFrançaise

Pour connaître les procédures propres à la politique de garantie de votre pays, contactez votre revendeur ou distributeur International Kicker.

AVERTISSEMENT: Les haut-parleurs Kicker ont la capacité de produire des niveaux sonores pouvant endommager l'ouïe de façon irréversible ! L'augmentation du volume d'un système jusqu'à un niveau présentant une distorsion audible endommage davantage l'ouïe que l'écoute d'un système sans distorsion au même volume. Le seuil de la douleur est toujours le signe que le niveau sonore est trop élevé et risque d'endommager l'ouïe de façon irréversible. Réglez le volume en faisant preuve de bon sens !

L'expression "carburant pour vivre plein pot" fait référence au dynamisme de la marque Kicker d'équipements audio pour véhicules et a pour but d'encourager nos clients à faire le maximum ("vivre plein pot") dans tous les aspects de leur vie. Les haut-parleurs et amplificateurs Kicker sont les meilleurs dans le domaine des équipements audio et représentent donc pour nos clients le "carburant pour vivre plein pot" dans l'aspect "installation audio de véhicule" de leur vie. Nous encourageons tous nos clients à respecter toutes les lois et réglementations locales relatives aux niveaux sonores acceptables à l'extérieur des véhicules.



**stillwaterdesigns**

P.O. Box 459 • Stillwater, Oklahoma 74076 • U.S.A. • (405) 624-8510



©2008 Stillwater Designs

## Free Manuals Download Website

<http://myh66.com>

<http://usermanuals.us>

<http://www.somanuals.com>

<http://www.4manuals.cc>

<http://www.manual-lib.com>

<http://www.404manual.com>

<http://www.luxmanual.com>

<http://aubethermostatmanual.com>

Golf course search by state

<http://golfingnear.com>

Email search by domain

<http://emailbydomain.com>

Auto manuals search

<http://auto.somanuals.com>

TV manuals search

<http://tv.somanuals.com>