

Pool FROG®

Mineral HyBrid Operations Manual

IMPORTANT:

This manual must be given to the homeowner to ensure warranty coverage.

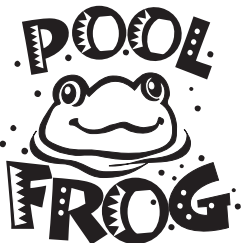
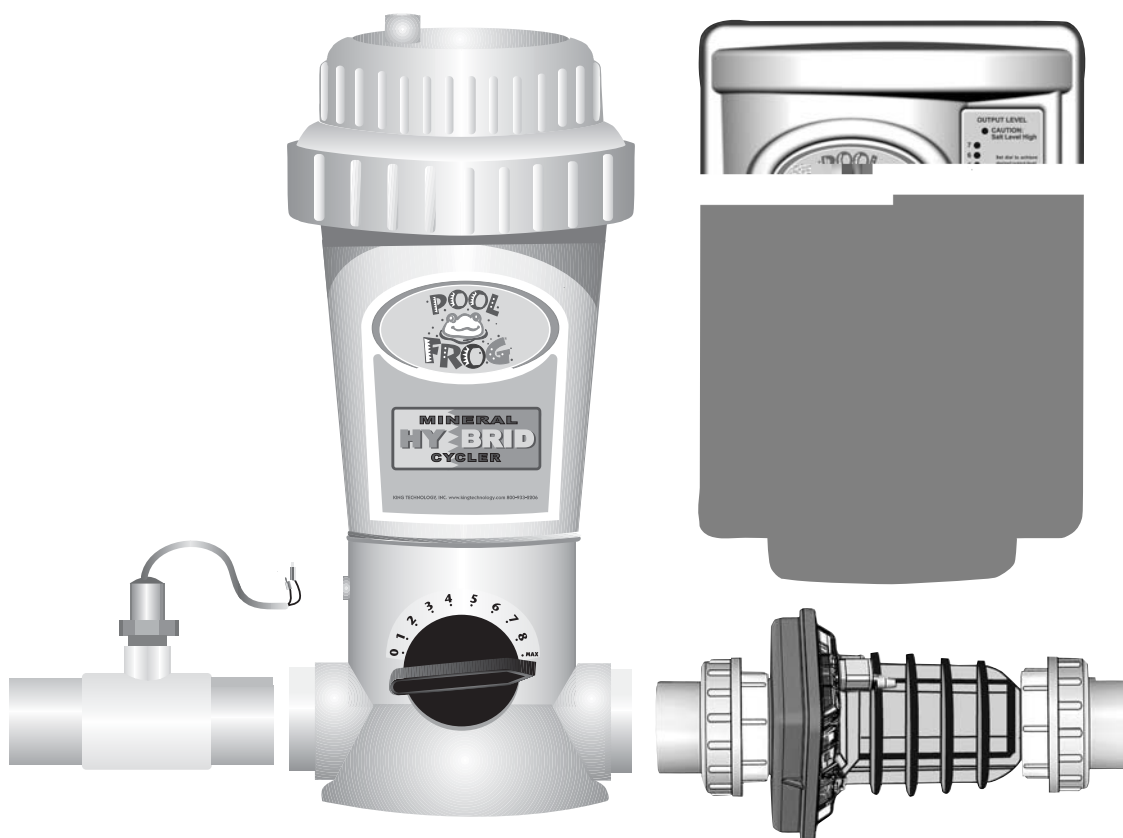

Customer Service 800-222-0169

www.kingtechnology.com

WARNING — SAFETY FIRST

When installing and using this electrical equipment, basic safety precautions should always be followed, including the following:

- It is recommended that a licensed electrician or certified electrical contractor perform the electrical connections.
- DO NOT OPEN THE GENERATOR CONTROL PANEL – NOT A SERVICABLE UNIT.
- READ AND FOLLOW ALL INSTRUCTIONS.
- Disconnect all AC power before installation.
- WARNING – To reduce the risk of injury, do not permit children to use this product.
- Always adhere to all local and national regulatory installation requirements.
- The control panel must be mounted vertically on a flat surface and a minimum of 5 ft (1.5m) horizontal distance (or more, if local codes require) from the pool/spa.
- In Canada and some other regions, local codes require the unit be connected only to a circuit that is protected by a ground-fault circuit-interrupter (GFCI). The installer should provide this GFCI requirement. The GFCI should be tested on a regular basis by pushing the test button. If the GFCI fails to operate correctly, there is ground current flowing indicating the possibility of an electric shock. Do not use this unit. Disconnect unit and have a qualified professional correct the problem before using.
- The power cable must be hardwired to the time clock so that the system cannot operate without the pump.
- A build-up of flammable fumes can result in a hazardous condition if the cell is allowed to operate without flow. This machine must be operated only with an approved in-line flow sensor.
- The flow sensor must be installed immediately before the POOL FROG® Mineral Hybrid Cyler followed by the POOL FROG® Mineral Hybrid Cell.
- When cleaning the cell or adjusting pH, ALWAYS ADD ACID TO WATER, NEVER WATER TO ACID.
- SAVE THESE INSTRUCTIONS.

TABLE OF CONTENTS

| | |
|---|--------------|
| Warning-Safety First | 2 |
| Introduction | 4 |
| Start-up | 5 |
| Adding Salt to the Pool | 6 |
| Inserting POOL FROG® Mineral Reservoir | 7 |
| Basic Operation | 8 |
| Controls | 9 |
| Easy Maintenance | 10 |
| POOL FROG® Mineral Hybrid Cell Cleaning | 11 |
| Winterizing | 12 |
| Troubleshooting | 13-15 |
| Saturation Index | 16 |
| Glossary | 17 |
| POOL FROG® Mineral Hybrid Cyclers Parts List | 18 |
| Warranties | 19-20 |

**For information on King Technology's entire product line,
visit our website at www.kingtechnology.com**

POOL FROG®

Welcome to easier pool care courtesy of POOL FROG®. With POOL FROG® Mineral Hybrid, your pool water will look and feel better without a lot of work or a lot of chlorine. This system controls bacteria using a combination of minerals and reduced chlorine levels—up to 50%* less. There are 4 parts to the POOL FROG® Mineral Hybrid: The In Ground POOL FROG® Mineral Hybrid Cyclier, the POOL FROG® Mineral Reservoir, the POOL FROG® Mineral Hybrid Generator Control Panel and the POOL FROG® Mineral Hybrid Generator Cell.

Part 1 POOL FROG® Mineral Hybrid Cyclier

The water treatment center that controls the flow of water through the system.



For In Ground Pools
up to 40,000 gallons.

Part 3 POOL FROG® Mineral Hybrid Generator Control Panel

Controls the generation of chlorine to maintain a low 0.5 ppm.



Part 4 POOL FROG® Mineral Hybrid Generator Cell

Innovative technology with "Shake Plates" to prevent calcium build up while being super charged with power direct to every other plate. The result is fewer cell cleanings are required than other products and the cell lasts longer with a 7-year limited warranty.

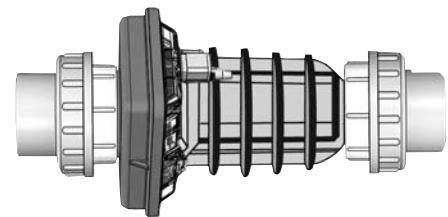

Part 2 POOL FROG® Mineral Reservoir

Holds the minerals and fits inside the POOL FROG® Mineral Hybrid Cyclier, allowing you to reduce your chlorine generated by up to 50%*

REMEMBER TO REPLACE POOL FROG® MINERAL RESERVOIR EVERY 6 MONTHS OR AFTER ONE POOL SEASON, WHICHEVER IS SHORTER.

*Compared to the minimum EPA recommended chlorine level of 1.0 ppm for a stabilized swimming pool.



Start-up

Do not turn generator power on until start-up is complete and the proper amount of salt has been added to the pool (see page 6).

1.

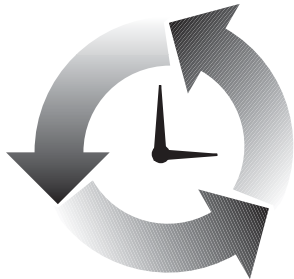

• Make sure the pool has adequate circulation. The pool water must completely circulate through the pump and filter at least 1 1/2 to 2 times per day. Check with your dealer for the proper circulation time for your pool.

2.

• Before beginning with any pool care program, you must first balance your pool water. Take a water sample to your local pool professional or use a complete test kit that will test for the below important elements.

New pools especially may contain undesirable matter. These pools need extra care to properly balance before using POOL FROG® Mineral Hybrid.

3.

Cu
Mg **Fe**

• If your fill water is high in metals, use a sequestering agent or metal out product at start-up only before using the POOL FROG® Mineral Reservoir. See your local dealer for details on using these products and always follow manufacturers directions carefully.

4



• Add a stabilizer or conditioner to the pool at the beginning of the season if the stabilizer level is below 40 ppm. This will prevent chlorine burn off. Follow manufacturer's directions carefully.

5.



• Shock the pool with chlorine to rid the water of all contaminants before beginning with POOL FROG® Mineral Hybrid. Follow manufacturer's directions carefully.

• THIS STEP IS VERY IMPORTANT TO START-UP. USE CHLORINE SHOCK ONLY.

| WATER BALANCE GUIDELINES | | | |
|--------------------------|---------|---------------|---------|
| | Minimum | Ideal | Maximum |
| pH: | 7.2 | 7.4 – 7.6 | 7.8 |
| Total Alkalinity: | 60 ppm | 80 – 100 ppm | 120 ppm |
| Calcium Hardness: | 150 | 200 – 300 | 400 |
| Total Dissolved Solids: | | <1500 | |
| Stabilizer: | 20 ppm | 40 – 60 ppm | 80 ppm |
| Free Chlorine: | 0.5 ppm | 0.5 – 1.0 ppm | 1.0 ppm |

Use the Saturation Index on page 16 to ensure proper water balance.

Adding Salt to the Pool

BEFORE ADDING THE SALT

CALCULATING THE SIZE OF THE POOL

| | Gallons | Dimensions are in feet |
|-------------|-------------------------------------|------------------------|
| Rectangular | Length x Width x Average Depth | |
| Round | Diameter x Diameter x Average Depth | |
| Irregular | Length x Width x Average Depth | |

ACCEPTABLE SALTS

The best salt is an evaporated, granulated, food grade salt. Water softener salt pellets may be used but will not dissolve.

99% pure salt.
"Solar" salt.

DETERMINE SALT AMOUNT

The table below is based on a salt concentration of 4000 ppm (e.g. 4000 ppm) and is for very small bodies of water (1000 ppm). Then look at the size of your pool. That number is the number of pounds of

Inserting **POOL FROG®** Mineral Reservoir

(POOL FROG® Mineral Reservoirs **MUST** be Replaced Every Season)

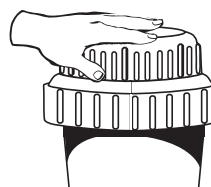
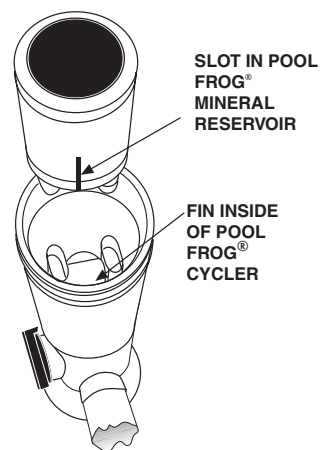
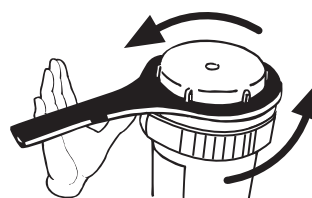

Basic Operation

|

Periodically test your water and always maintain the following readings.

(Use Saturation Index on page 16 to ensure proper balance.)

Salt Level: 3000 - 4500 ppm

Chlorine Level: 0.5 - 1.0 ppm

pH: 7.2 - 7.8

IMPORTANT: At least once a month have a professional test your water. Make sure there are no Nitrates or Phosphates in the water as they will deplete chlorine levels.

Controls

1. OUTPUT LEVEL—The lights marked 1-7 indicate the system's chlorine output. The higher number indicates higher chlorine production. Turning the control knob clockwise increases chlorine production and should increase the chlorine output reading. To turn system off, turn knob all the way counterclockwise until power light turns off.

2. SALT LEVEL—The lights marked 1-7 also indicate adequate or inadequate salt levels.

To check the salt level, turn the control knob all the way up (clockwise) and check the light reading.

- A) If light number 7 is lit, the salt level is sufficient. (Return the control knob to the desired chlorine production setting.)
- B) If any number less than 7 is lit, the salt level could be low or the cell is worn or calcified. Check the cell to ensure the plates are in good condition and not coated with calcium buildup (a white chalky coating on the plates inside the cell). Cleaning the cell is recommended if it is calcified or if the readout seems questionable (see page 11). Before adding salt, it is advisable to have the salt level professionally checked by your dealer.
- C) If lights 1-7 go up and down quickly or the salt-level high light is solid, the salt level is extremely high and should be reduced immediately by draining a significant amount of pool water and refilling the pool. (Please check with your local pool professional prior to draining the pool.)

3. IF THE CAUTION: SALT-LEVEL HIGH LIGHT IS FLASHING—The salt level in the pool is on the high side. This does not harm the POOL FROG® Mineral Hybrid Generator, but is provided as a cautionary notice to the user not to add more salt to the pool. Operation at very high levels (i.e. above 5500 ppm) is not recommended. Return the control knob to the desired chlorine production setting. If this light is solid red, see 2C above.

4. POWER LIGHT—When the system is turned on and the pump is operating, the green power light should be illuminated indicating that power is reaching the control panel.

5. CAUTION: LOW-WATER FLOW LIGHT—Red light should NOT be illuminated during normal operation. When first turning on the circulation pump, the red light may turn on and off until the air is pushed out of the pump lines and sufficient water flow is achieved. This is normal and ensures that the generator automatically shuts off if the pump fails to prime or a blockage occurs. See troubleshooting section if red light remains on.

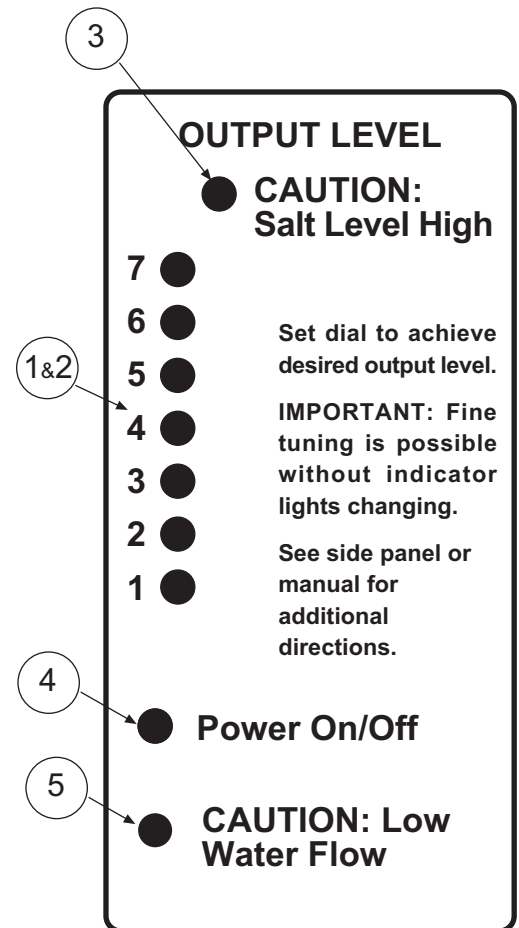

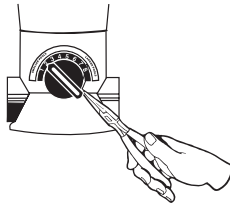

Easy Maintenance

Replacing the Control Dial O-Rings Kit

1.  • Using a needle nose pliers, find the snap ring tail located at approximately the five o'clock position under the control dial.

2.  • Pull down and out of the groove.

3.  • Using a large screwdriver, loosen the control dial. Carefully pry the dial until it pulls out.

4.  • Carefully replace the rubber o-ring without stretching it. Apply silicone lubricant, that came with your POOL FROG® Mineral Hybrid Cyler, on o-ring. **DO NOT USE** petroleum based lubricants.

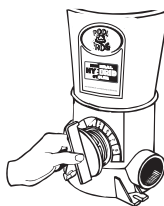
5.  • Push control dial completely into the housing and turn the dial to setting 2.

6.  • Insert the non-lipped end of snap ring into the groove opening beginning at the 5 o'clock position and push it up so that it threads itself around the control dial.

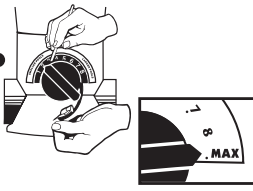
7.  • Using a small screwdriver or pointed tool to help guide it, make sure the snap ring stays in the groove as it is inserted. Turn the dial back to MAX.

Replacing Cap O-Ring

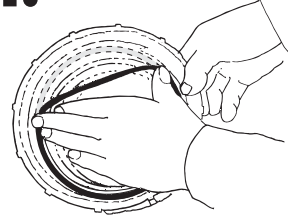
1.  • Hold cap in front of you upside down with the o-ring groove facing up. Place one end of o-ring into cap groove at the point closest to you. Hold o-ring down with the thumb and forefinger of one hand.

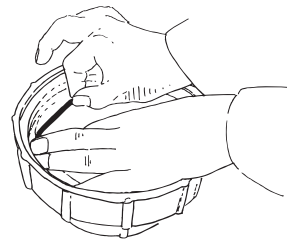
2.  • Take hold of the far end of the o-ring with the thumb and index finger of the other hand. Roll o-ring slightly back towards you as you stretch the o-ring into the remainder of the cap groove.

3.  • Lubricate o-ring often with silicone lubricant that came with your POOL FROG® Mineral Hybrid. **DO NOT USE** petroleum based lubricants.

Replacing Knob

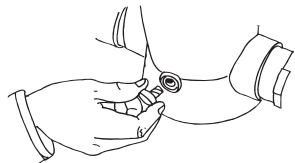
 • Replace knob in back of POOL FROG® Mineral Hybrid Cyler by unscrewing old one and screwing in new one.

Cleaning POOL FROG® Mineral Hybrid Cell

Our clear cell allows for easy regular inspections for calcium build up. Visually check the cell periodically, and clean it as necessary (1 to 2 times per year). Advanced self-cleaning with shake plates helps the cell stay cleaner than other self-cleaning cells, but minimal biannual cleanings are required.

→Do not use metal or other hard objects to clean the cell as this could scratch the precious coating on the plates and void the warranty.

→CAUTION: Always add acid to water, NOT water to acid. Diluted muriatic acid solution = 10 parts water to 1 part acid. Note: Follow the instructions of the acid manufacturer.

→CAUTION: Always use protective eyewear and protective clothing.

Cleaning With Optional Cleaning Cap:

1. Before removing cell, turn off power to pump and control panel of generator. Make sure to note in which direction the cell was installed so it can be replaced correctly.

2. Remove the cell from the line by undoing the electrical connections from the cell and the barrel unions from the cell ends.

3. Remove the black o-rings on the ends of the cell.

4. Attach the cell Cleaning Cap to one end of cell.

5. Put on rubber gloves and goggles.

6. Pour into cell, either undiluted white distilled vinegar, or a solution of diluted muriatic acid (10 parts water to 1 part muriatic acid).

7. Wait for foaming to stop (5-10 minutes when using muriatic acid – vinegar takes longer).

8. Safely dispose of muriatic acid by pouring it into your pool only. If using vinegar dispose of by pouring down your kitchen drain.

9. Rinse cell with water hose. Avoid contact with skin or clothes.

10. Put the o-rings back in place and re-install the cell in the line making sure the water flows into the square blue end of the cell first.

11. Reconnect the electrical wires, being sure to **tighten the screws on the electrical wires firmly**. See cell wiring diagram.

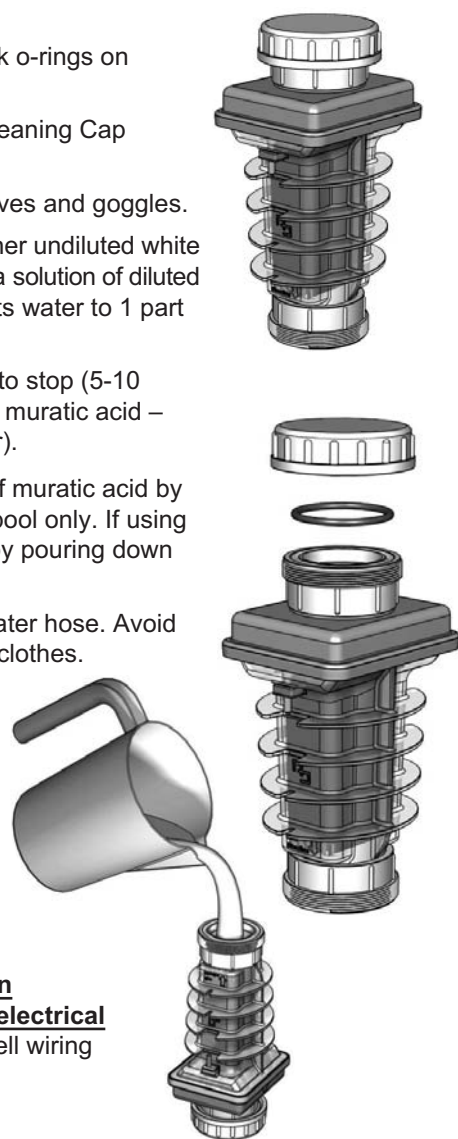

Cleaning Without Optional Cleaning Cap:

1. Remove the cell from the line by undoing the electrical connections from the cell and the barrel unions from the cell ends.

2. Remove the black o-rings on the ends of the cell.

3. Put on rubber gloves and goggles.

4. Soak entire cell either in undiluted white distilled vinegar or in a solution of diluted muriatic acid (10 parts water to 1 part muriatic acid).

5. Wait for foaming to stop (5-10 minutes when using muriatic acid – vinegar takes longer).

6. Safely dispose of muriatic acid by pouring it into your pool only. If using vinegar dispose of by pouring down your kitchen drain.

7. Rinse cell with water hose. Avoid contact with skin or clothes.

8. Put the o-rings back in place and re-install the cell in the line making sure the water flows into the square blue end of the cell first.

9. Reconnect the electrical wires, being sure to **tighten the screws on the electrical wires firmly**. See cell wiring diagram.

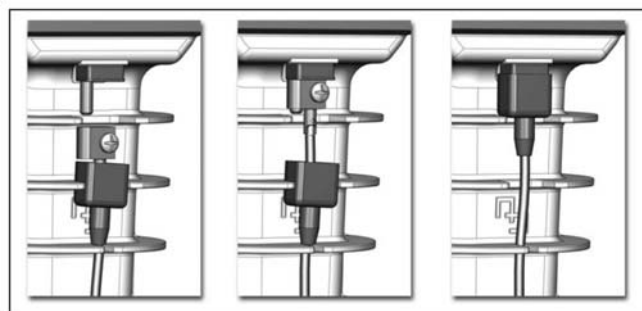
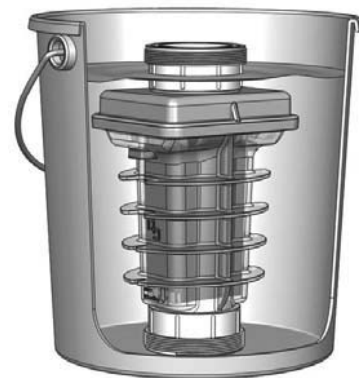

CELL WIRING DIAGRAM

Optional

1. Lubricating the o-rings with the silicone lubricant that came with your POOL FROG® Mineral Hybrid helps improve the seal of the fittings, but be sure not to use silicone glue, petroleum jelly (such as Vaseline), or other agents that could deteriorate the o-rings.

2. Smear the two electrical connections on the outside of the cell with electrical lubricant.

Control Panel Maintenance

There is no regular maintenance required on the control panel other than checking that the wiring running from the control panel to the cell and flow sensor is securely in place. It is beneficial to keep the control panel clean, dry and out of the sun.

Winterizing

• Turn off the

• Remove the POOL FROG® Mineral Reservoir and discard in trash. Even if you hear spent minerals inside, it is no longer effective. Replace with a new



• Unscrew knob of POOL FROG Hybrid Cycler. Allow water to drain.

Troubleshooting

Note: evaluating the possible causes for each problem from top to bottom (first to last) will avoid extra labor.

| PROBLEM | POSSIBLE CAUSES | WHAT TO DO |
|--|---|--|
| 1. Chlorine Level Low | System is turned off. | Turn control knob to the desired setting. Check fuse and breaker. |
| | Control knob is set too low in relation to chlorination demand (e.g. higher number of bathers, warmer weather, increased debris in pool). | Turn control knob higher (clockwise) and/or increase pump operation time. |
| | Low salt. | Check the salt level. See "Adding Salt To The Pool" page 6. |
| | Pump operation time too short. | Run pump at least 8 hours per day (1.5 turnovers of all the pool water). |
| | Low stabilizer (Cyanuric Acid). | Check water chemistry; stabilizer should be between 40-80 ppm. If low, add stabilizer. See "Start-up" page 5. |
| | Chemical imbalance - could be Nitrates or Phosphates are present in the pool. | Make sure water is balanced according to the chart on page 5. Take your water to a dealer to check for Nitrates and Phosphates and follow dealer directions for removal. |
| 2. Power Light is Off: No Power | System is turned off. | Turn control knob clockwise to the desired setting. |
| | Main fuse blew. | Check the main fuse on the bottom of the control panel and replace if necessary with a 6.3 AMP 250VAC 6x32mm Slow Blow fuse. One extra fuse is supplied with the system. |
| | Breaker tripped. | Check the breaker leading to the pool control. |
| | Power wires cut, disconnected, or incorrectly wired. | Check for correct wiring. |
| | Very high salt levels in the pool have shut down the generator. It will no longer produce chlorine until the situation is rectified. | Drain part of the water and refill the pool. It is also recommended to periodically test the salt level by a professional. If above 5500 ppm, check with your dealer about draining part of the pool water and refilling with fresh water. |
| | Other malfunction in control panel. | Contact warranty hotline. |
| 3. CAUTION: Low Flow Light Turning On and Off | This is normal at initial start-up or if air bubbles are in pipes. | Wait a few minutes for air to clear. If continuous, see troubleshooting section "Flow Light is Solid Red" below. |
| 4. CAUTION: Low Flow Light is Solid Red | Insufficient water flow from pump to flow sensor and cell. | This is normal for a few minutes at initial startup or if air is in the lines. Clean filters and strainers. Check for closed valves, faulty pump, etc. |
| | Obstruction or scale buildup in cell. | Clean cell according to instructions on page 11. |
| | Flow sensor was not installed in the correct direction. | Turn flow sensor so arrow faces direction of water flow. |
| | Flow sensor is not fully threaded into the "T" connector. | Fully thread the flow sensor into the T connector being careful not to damage the wires or sensors. |
| | Cut wires or insufficient wire connections. | Check the connection to ensure proper wire contact. |
| | Dirty filter causing insufficient flow. | Clean or backwash the filter. |

| PROBLEM | POSSIBLE CAUSES | WHAT TO DO |
|--|---|--|
| 5. Output Light #7 is not lit when turning control knob all the way up. | Dirty cell. | Check the cell to ensure the plates are in good condition and not coated with calcium buildup. Cleaning the cell is recommended if it is calcified or if the readout seems questionable. See "Cell Cleaning" page 11. |
| | Loose connection with the cell's connection pegs. | Ensure the connectors are pushed completely over the pegs and tighten connections with a screwdriver. See cell-wiring diagram page 11. |
| | Not enough salt due to heavy rain, splash out, initial miscalculation, etc. | Add salt into the pool. See "Adding Salt" on page 6. It is also recommended to periodically test the salt level by a professional and adjust according to the "Salinity Demand Table" on page 6. |
| | Worn cell. | If none of the above resolutions worked, the cell may be worn out and must be replaced. |
| 6. Salt Level High A. Red caution light is flashing. B. Red caution light is solid or output lights 1-7 go up and down quickly. | Salt level is on the high side. | This does no harm to the generator. Slowly turn down the control knob to return to desired output setting. It is also recommended to periodically test the salt level by a professional. |
| | Salt level is very high. The generator could completely turn off and no longer produce chlorine until the situation is rectified. | Drain part of the water and refill the pool. It is also recommended to periodically test the salt level by a professional. If above 5500 ppm, check with your dealer about draining the pool water and refilling with fresh water. |
| 7. Output Level Lights Not Responding, but Power Light is On | Control knob set too low. | Turn control knob up (clockwise). |
| | Improper salt level. The system automatically shuts down the output level when the salt level is extremely low or extremely high. | Check salt level using a test kit or your local pool professional. See Salt Level Low or Salt Level High instructions above. Adjust accordingly. |
| | Wires from control panel to cell are loose or the screws to the connectors are not tight. | Check the connection. Wires should be slid over the pegs on the cell and the screws tightened firmly. See cell-wiring diagram page 11. |
| 8. Scale Buildup Inside Cell | Standard occurrence that needs to be cleaned approximately twice per year. | Clean cell as instructed on page 11. |
| | Chemical imbalance. | Balance chemicals. (Focus mostly on the "Saturation Index" on page 16.) |
| 9. White Flakes In Water | Normal occurrence when cell cleans itself. | Keeping the water well balanced reduces this. (Focus mostly on the "Saturation Index" on page 16.) |
| 10. Cloudy Water | May be due to chemical imbalance or low water flow. | <ol style="list-style-type: none"> 1. Make sure your filtration system is working properly (i.e. clean filter and/or skimmer). 2. Make sure circulation time is adequate – increase pump time if not. 3. Make sure total alkalinity is within 60-120 ppm. Adjust with acid if needed. 4. Shock the water to eliminate build up of any organic matter. 5. Make sure pool has a free chlorine reading of 0.5 to 1.0 ppm. 6. Check with your dealer for more information. |

| PROBLEM | POSSIBLE CAUSES | WHAT TO DO |
|--------------------------|--|---|
| 11. Colored Water | <ul style="list-style-type: none"> • Metals in the fill water may have been oxidized. • Algae may be trying to form. • Chlorine level may be low. | <p>Have dealer test the pool water. If high in metals use a Metal Out or Sequestering product at start-up only.</p> <p>Increase circulation time if needed and clean the filter.</p> <p>See "Chlorine Level Low" on page 13.</p> <p>Check with your dealer for more information.</p> |
| 12. Algae | <p>May be due to low chlorine levels or a chemical imbalance.</p> | <p>Have your water tested for chlorine levels, pH, phosphates and nitrates.</p> <p>Use a nonmetallic (polyquat) algaecide per the directions on the bottle and brush the sides of the pool often.</p> <p>Clean the filter and shock the pool with chlorine daily until water clarity returns.</p> <p>See "Chlorine Level Low" on page 13.</p> <p>Check with your dealer for more information.</p> |

Our contact information is found on the front cover of this manual. Please feel free to contact us with any questions or comments. Our Customer Service Department is open from 8:00 AM to 5:00 PM Central Standard Time, Monday through Friday. Please have the following information ready:

1. Model and serial # of all components.
2. Date of installation.
3. Installing company or dealer.
4. Current salt level, chlorine level and water balance data.
5. Proof of purchase (bill of sale, cancelled check or some other appropriate payment record).

Saturation Index

Test the water for pH, Alkalinity, Calcium Hardness and Temperature, then follow the simple steps below:

1. Write your pool's pH level here: → pH: _____

2. Find your Alkalinity level in the chart below, and write the corresponding Alkalinity Factor here: → Alkalinity Factor: _____

| | | | | | | | | | |
|-----------------|-----|-----|-----|-----|-----|-----|-----|-----|-----|
| Pool Alkalinity | 5 | 25 | 50 | 75 | 100 | 150 | 200 | 300 | 400 |
| Factor | 0.7 | 1.4 | 1.7 | 1.9 | 2.0 | 2.2 | 2.3 | 2.5 | 2.6 |

3. Find your Calcium level in the chart below, and write the corresponding Calcium Factor here: → Calcium Factor: _____

| | | | | | | | | | |
|--------------------------------------|-----|-----|-----|-----|-----|-----|-----|-----|-----|
| Pool Calcium (CaCO ₃) | 5 | 25 | 50 | 75 | 100 | 150 | 200 | 300 | 400 |
| Factor | 0.3 | 1.0 | 1.3 | 1.5 | 1.6 | 1.8 | 1.9 | 2.1 | 2.2 |

4. Find your pool water temperature in the chart below, and write the corresponding Temperature Factor here: → Temperature Factor: _____

| | | | | | | | | | | |
|---------------|-----|-----|-----|-----|-----|-----|-----|-----|-----|-----|
| Pool Temp (F) | 32 | 37 | 46 | 53 | 60 | 66 | 76 | 84 | 94 | 105 |
| Factor | 0.0 | 0.1 | 0.2 | 0.3 | 0.4 | 0.5 | 0.6 | 0.7 | 0.8 | 0.9 |

5. Add the results from steps 1 through 4 above and write the result here: Total of above: _____

- 12.2

6. Subtract 12.2 from step 5 and write the result here: → Saturation Index = _____

→ If the Saturation Index above is between -0.3 and +0.3, the water is well balanced.

→ If the Index is more than 0.3, the water will tend to cause scaling or get cloudy. Alkalinity and pH should be reduced accordingly, but maintained within recommended levels.

→ If the Index is less than -0.3, the water will tend to be aggressive toward the pool surface, equipment and bathers. Alkalinity and pH should be increased accordingly, but maintained within recommended levels.

Glossary

Salt: To ensure maximum benefits with the use of the system, the ideal salt level is 4000 ppm (parts per million). A low concentration of salt can hinder the generator's effectiveness. A concentration of salt above 5500 ppm may cause corrosion damage to the pool fixtures. See Adding Salt on page 6.

Total Dissolved Solids (TDS) are different from the salt level of the pool, although TDS levels rise with the addition of salt. This does not harm the pool water chemistry or clarity. To determine an accurate TDS, subtract the salt level from the TDS reading.

Free Chlorine v. Combined Chlorine: The unpleasant smells and side effects often associated with chlorine are actually caused by combined chlorine (i.e. chloramines). Combined chlorine is a chlorine molecule that has combined with a contaminant and needs to be burned off with a shock treatment to free up the chlorine again. With the POOL FROG® Mineral Hybrid depending on pump-run time per day, the combined chlorine is burned off at the point of the cell which reduces the need to shock. The free chlorine level in the pool should be maintained at 0.5 to 1.0 ppm.

pH is a measure of how acidic or basic a solution is. A scale of 0 to 14 is used to measure pH. Pure water has a pH of 7 (neutral), acid solutions have a pH of less than 7, and basic (alkali) solutions have a pH of more than 7. The recommended range is 7.2 to 7.8; chlorine is more effective within this range and the water is most comfortable for bathers. Water with very high pH levels can cause scaling in the pool, on the walls and in pipes. Low pH levels cause the water to be aggressive to the pool walls, equipment and bathers.

To lower pH, add muriatic acid or dry acid, and to raise pH, add soda ash (sodium carbonate). Be sure to read and follow the respective manufacturer's instructions.

Total Alkalinity mitigates changes in pH. It is often referred to as the "big brother of pH." Keeping proper levels of total alkalinity will help reduce unwanted fluctuations in pH levels. Total alkalinity is also used to offset high or low levels of calcium hardness (see Saturation Index on previous page). Add muriatic acid or dry acid to lower total alkalinity and add baking soda (sodium bicarbonate) to raise total alkalinity. Be sure to read and follow the respective manufacturer's instructions.

Stabilizer (cyanuric acid) is necessary in most outdoor pools to prevent chlorine reduction from the sun's ultraviolet rays. Chlorine stabilizer should be maintained at 40 ppm to offset the harmful effect of the sun while maintaining the effectiveness of the chlorine.

Nitrates and Phosphates, generally associated with fertilizer thrown or sprayed on nearby grass, can put very high demands on chlorine; most often nitrates and phosphates will bring the chlorine level down to zero (0). You can have your water tested for nitrates and phosphates by the local pool professional. **No nitrates or phosphates should be in your pool.** To reduce phosphate levels, use a phosphate remover from your local pool professional. To reduce nitrate levels, the pool must be partially or fully drained, but be sure to consult your local professional before draining your pool.

Metals (certain metals) can cause loss of chlorine and can stain your pool. If a water test reveals the presence of metals, refer to your local pool professional for recommended methods of removal prior to using the POOL FROG® Mineral Reservoir.

New Pool Water in recently filled or newly refinished pools may contain undesirable matter. The ability of the POOL FROG® Mineral Hybrid Generator to maintain your pool sanitation could be hindered by this matter so it is best to balance the pool water first.

Calcium Hardness, like pH and alkalinity, affects the water's tendency to be aggressive or scale forming. Lower levels of calcium hardness improve the chlorine generator's performance and provide softer silkier water for the swimmers.

Saturation Index determines whether the pool water is balanced, aggressive or scale forming by comprehensively taking into account all the relevant factors, including pH level, alkalinity level, calcium hardness and temperature. These factors should be tested then plugged into the worksheet on the previous page to verify the proper balance of the pool and make adjustments as necessary.

POOL FROG® Mineral Hybrid Cyclers Parts List

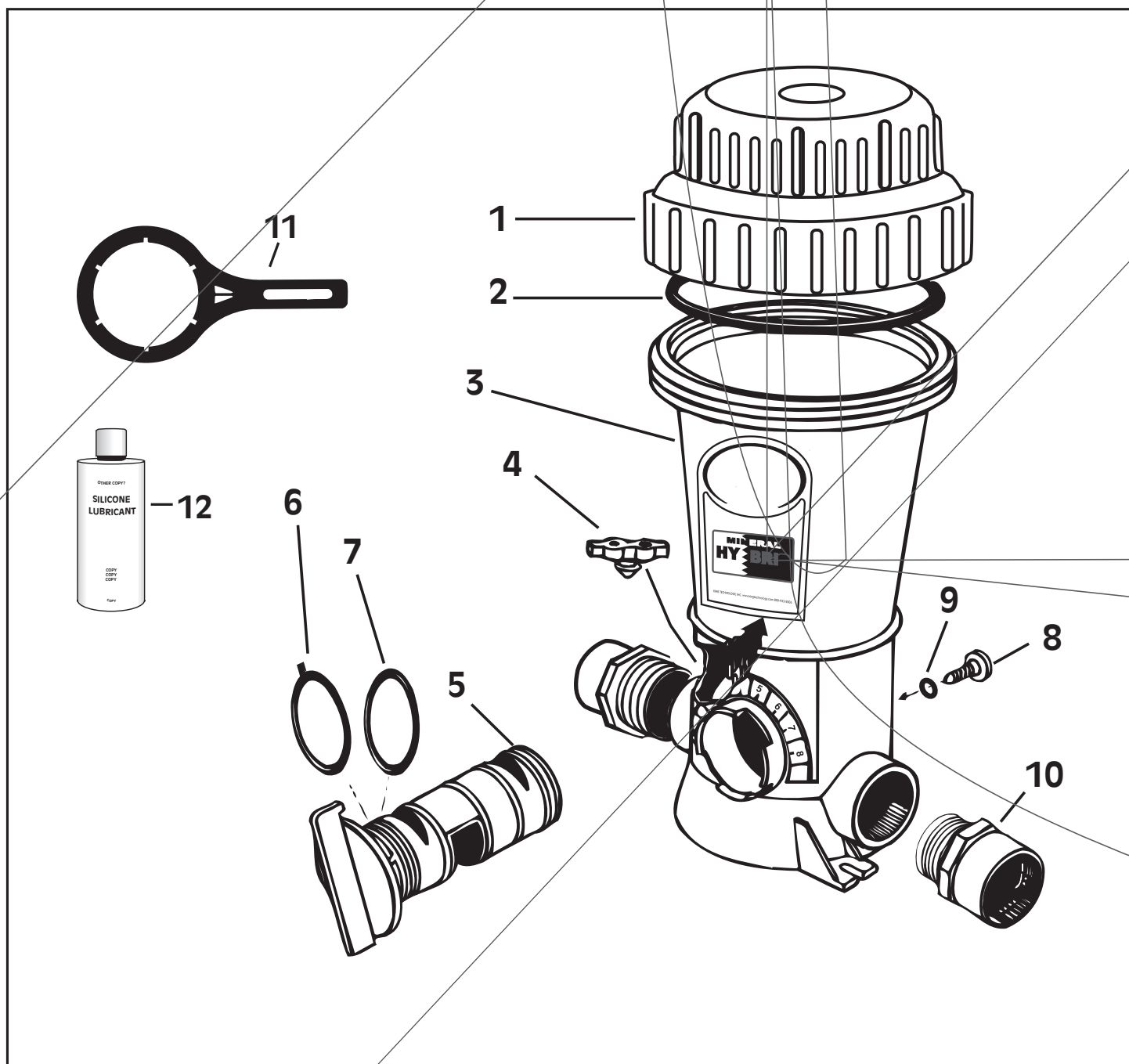

DIAGRAM/PARTS LIST

| REF. # | PART No. | DESCRIPTION | QTY. REQ. |
|---------|------------|--------------------------------|-----------|
| 1 & 2 | 01-22-9412 | Cap w/O-Ring | 1 |
| 2 | 01-22-9920 | Cap O-Ring | 1 |
| 3 | N/A | Body | 1 |
| 4 | 01-22-9480 | Pressure Relief Valve | 1 |
| 5, 6, 7 | 01-22-9440 | Control Dial with Assembly Kit | 1 |
| 6 & 7 | 01-22-9450 | Control Dial O-Ring Kit | 1 |
| 8 & 9 | 01-22-9940 | Knob with O-Ring | 2 |
| 10 | 01-22-9490 | 2" Male Adapter | 2 |
| 11 | 01-22-8870 | Cap/Control Dial Tool | 1 |
| 12 | 01-22-9971 | Silicone Lubricant | 1 |

Parts for the POOL FROG® Mineral Hybrid Generator will be provided as needed by our warranty stations after a conversation with our customer service department.

POOL FROG® Mineral Hybrid Cyclor Two-Year Limited Warranty

King Technology, Inc. warrants to the original purchaser this unit will be free from any defects in workmanship and/or material, for a period of two (2) years from the date of original purchase. This warranty covers body, cap and control dial, but specifically excludes o-rings. King Technology at its option may replace any defective parts or the entire unit without charge after it is determined what is needed to correct any deficiency. Replacement parts with the exception of o-rings are warranted for the remainder of the original warranty. To extend the limited warranty from two years to ten years, simply complete the warranty card that came with your unit and return it to King Technology within 30 days of purchase and installation.

1. To obtain warranty service, you must deliver the unit to King Technology or its nearest authorized dealer. Shipping expenses are the purchaser's responsibility. The name of the nearest authorized dealer can be obtained by writing or calling King Technology at the address and telephone number provided on back page. Proof of purchase is required when requesting warranty service. Purchaser must present the sales receipt or other documentation verifying proof of purchase.

2. This warranty does not cover defects caused by: Modification, alteration, repair or service of the unit contrary to the accompanying instructions; physical abuse to or misuse of the product or operation or installation in a manner contrary to the accompanying instructions. This warranty also excludes all costs arising from the installation, adjustment, removal or replacement of defective units or parts. This warranty also excludes any and all claims arising out of the chemicals used in the product or their characteristics.

3. CAUTION - Read carefully – Failure to follow these instructions will void the warranty. Do not add shock in or near skimmer.

A. This unit is not designed for shock treatment of pools. See your pool dealer or distributor for further information concerning shock treatments.

B. Misuse or failure to use the proper POOL FROG® Mineral Reservoir may cause damage to equipment or personal injury. This warranty will be null and void, if this unit is not used with the recommended POOL FROG® Mineral Reservoir.

4. This warranty is the exclusive warranty for the POOL FROG® Mineral Hybrid Cyclor. This warranty is not transferable. **KING TECHNOLOGY MAKES NO REPRESENTATION OR WARRANTY OF ANY KIND, EXPRESS OR IMPLIED, AS TO MERCHANTABILITY, FITNESS FOR A PARTICULAR PURPOSE OR ANY OTHER MATTER CONCERNING THE POOL FROG® MINERAL HYBRID CYCLOR.** Any express warranty not provided herein, and any remedy for breach of contract but which for this provision might arise by implication or operation of law is hereby excluded and disclaimed. THE EXCLUSIVE REMEDY FOR ANY CUSTOMER IS THE REPAIR OR REPLACEMENT OF THE UNIT, AND THE RECOVERY OF DAMAGES WILL NOT EXCEED THE PURCHASE PRICE OF THE UNIT. IN NO EVENT WILL KING TECHNOLOGY BE LIABLE FOR ANY INCIDENTAL, CONSEQUENTIAL, SPECIAL OR PUNITIVE DAMAGES FROM ANY CAUSE.

5. Under no circumstance shall King Technology be liable to purchaser or any other person for any damage or loss incurred because of any chemicals used in the product or their physical characteristics, or interruption of service of the product, or any resulting special, incidental or consequential damages or losses. Some states do not allow the exclusion or limitation of incidental consequential damages, so the above limitation or exclusion may not apply to you.

POOL FROG® Mineral Hybrid Generator Seven-Year Limited Warranty

This warranty applies to the chlorine generator and their factory-supplied components (the generator) when purchased from an authorized dealer and used for residential swimming pools or spas. King Technology, Inc. warrant the generator to be free from defects in materials and workmanship in the manufacturing process for a period of seven (7) years from the purchase date, when properly installed and operated in accordance with the relevant manuals. For three (3) years after the generator's original purchase date, should the generator exhibit a manufacturing defect, King Technology, Inc. will install comparable replacement parts **without charge for parts or labor**. For the subsequent 4 years, if a part with a manufacturing defect is delivered freight prepaid to King Technology, Inc., a comparable replacement part will be sent back for a charge of 60% of the latest list price plus the cost of shipping.

EXCEPTIONS & LIABILITY LIMITATIONS

This warranty is the exclusive warranty for the generator. This warranty is not transferable. **KING TECHNOLOGY MAKES NO REPRESENTATION OR WARRANTY OF ANY KIND, EXPRESS OR IMPLIED, AS TO MERCHANTABILITY, FITNESS FOR A PARTICULAR PURPOSE OR ANY OTHER MATTER CONCERNING THE GENERATOR.** Any express warranty not provided herein, and any remedy for breach of contract but which for this provision might arise by implication or operation of law is hereby excluded and disclaimed. YOUR EXCLUSIVE REMEDY IS THE REPAIR OR REPLACEMENT OF THE UNIT, AND IN NO EVENT SHALL IT EXCEED THE PURCHASE PRICE OF THE UNIT. IN NO EVENT WILL KING TECHNOLOGY BE LIABLE FOR ANY INCIDENTAL, CONSEQUENTIAL, SPECIAL OR PUNITIVE DAMAGES FROM ANY CAUSE.

Labor coverage is applicable only for installations within a 50-mile radius of an authorized dealer. King Technology, Inc., and their suppliers, dealers, and distributors SHALL NOT BE LIABLE FOR DAMAGE OF ANY SORT OR NATURE RESULTING FROM ABUSE, MISUSE, NEGLIGENCE, LIGHTNING, ABNORMAL WEATHER CONDITIONS, OR ACT OF GOD; OR DAMAGE CAUSED BY IMPROPER OR UNAUTHORIZED INSTALLATION OR REPAIR. This warranty applies only to components supplied by the factory and only where such components have been installed and maintained in compliance with the respective installation and operation manuals and instructions and applicable ordinances and codes. In no event shall the liability exceed the purchase price of the product. THE CONSUMER SHALL BE LIABLE AT STANDARD RATES FOR ANY SERVICE VISIT WHERE NO MANUFACTURING DEFECT WAS PRESENT AND FOR ALL SERVICE VISITS REQUESTED AFTER THE THIRD YEAR FOLLOWING THE ORIGINAL PURCHASE DATE.

PROOF OF PURCHASE

The consumer is responsible for establishing the original purchase date and the purchaser's identity for warranty purposes. We recommend that a bill of sale, canceled check, or some other appropriate payment record be kept for that purpose. The express warranty above constitutes the sole and complete warranty and takes precedence over all other warranties, whether expressed or implied, including a warranty for fitness for a particular purpose. No sales representative, dealer, distributor, or other person is authorized to give any warranty on behalf of King Technology, Inc.



Manufactured by: **KING TECHNOLOGY, INC.**
530 11th Avenue South, Hopkins, MN 55343 U.S.A.
952-933-6118 · 800-222-0169 · FAX 952-933-2206 www.kingtechnology.com

*Assembled from components made in the U.S.A. and Israel.
Covered by one or more of the following U.S. Patent Numbers: 4,662,387;
5,076,315; 5,218,983; 6,190,547; 6,210,566; 6,217,892; 6,383,507; 6,544,415;
6,551,609; 6,652,871 and other U.S. and Foreign Patents Pending.*

PN #20-48-0162
553090643R2N

Owner's Registration Form

Owner's Name _____ Signature _____

Street Address _____

City _____ State _____ Zip _____

Phone # _____ E-Mail _____

Authorized Dealer _____ Sales Rep _____

City _____ State _____ Zip _____

Model FROG® 6425 Model FROG® 6440 Control Panel Serial # _____

(Check one - see label on blue end of cell)

(Located on side of the control panel mounted to wall.)

Cycler Serial # _____ (Located on side of cycler above port opening.) Date Installed _____

Comments _____

IN ORDER TO ACTIVATE YOUR WARRANTY PLEASE RETURN THIS PORTION TO:

KING TECHNOLOGY, INC., 530 11th Avenue South, Hopkins, MN 55343

or fax to 952-646-4300 or register online at www.kingtechnology.com

Free Manuals Download Website

<http://myh66.com>

<http://usermanuals.us>

<http://www.somanuals.com>

<http://www.4manuals.cc>

<http://www.manual-lib.com>

<http://www.404manual.com>

<http://www.luxmanual.com>

<http://aubethermostatmanual.com>

Golf course search by state

<http://golfingnear.com>

Email search by domain

<http://emailbydomain.com>

Auto manuals search

<http://auto.somanuals.com>

TV manuals search

<http://tv.somanuals.com>