



**KitchenAid™**

**EXTRA CAPACITY  
DRYERS**

**ELECTRIC MODEL  
KEYE800S**

**GAS MODEL  
KGYE800S**

---

## **USE & CARE GUIDE**

---

# CONTENTS

	Page
<b>BEFORE USING YOUR DRYER</b>	2
<b>SAFETY FIRST</b> .....	2
<b>PARTS AND FEATURES</b> .....	3
<b>SETTING A SELECTION AND STARTING YOUR DRYER</b> ....	4
1. Select AUTO or TIME DRY	4
2. Push a CUSTOM DRY or TIME DRY SELECTION ..	4
3. Push a CYCLE/TEMPERATURE SELECTION .....	5
4. Push START	
Changing a Selection .....	5
Indicator Lights .....	6
<b>OPTIONS</b> .....	6
<b>FEATURES</b> .....	7
<b>DRYING TIPS</b> .....	9
<b>LINT SCREEN</b> .....	9
<b>LINT REMOVAL</b> .....	10
<b>CARING FOR YOUR DRYER</b> ..	10
<b>IF YOU NEED SERVICE OR ASSISTANCE</b> .....	13
<b>KITCHENAID™ WARRANTY</b> ..	15

## BEFORE USING YOUR DRYER

**Read this “USE & CARE GUIDE” and your “DRYER GUIDE” carefully for important use and safety information.**

**You are personally responsible for making sure that your dryer:**

- Is installed by a qualified installer.
- Is properly installed and leveled in a well ventilated room\* on a floor that can support the weight.
- Is connected to the right outlet, electric supply and grounding.\*
- Is properly connected to fuel and exhaust systems.\*
- Is used only for jobs normally expected of home automatic dryers.
- Is properly maintained.
- Is protected from the weather and kept where the temperature is above 45°F (7.2°C).

- Is not run where there may be explosive fumes.
- Is not used by children or anyone unable to operate it properly.

**\*See the “INSTALLATION INSTRUCTIONS” for complete information.**

## SAFETY FIRST

**ALWAYS** unplug the power supply cord or turn off the electrical power before attempting to service the dryer. **Shut off the GAS VALVE** if yours is a gas dryer.

**ALWAYS** shut off the gas valve before leaving on vacation.

**NEVER** use flammable fluids (dry cleaning solvents, gasoline, kerosene) in or near your dryer.

**ALWAYS** hand launder or air dry fabrics treated with flammable fluids before putting them into your dryer.

**NEVER** dry items containing wax or paint in the dryer. The fumes can create a FIRE HAZARD.

**FIRE HAZARD** and **DAMAGE** to some materials can result from:

- drying heat sensitive materials with heat.
- operating the dryer with the lint screen loose, damaged or missing.
- allowing lint to build up inside the dryer.

**NEVER** allow children to operate, play with, or crawl inside the dryer.

**NEVER** operate the dryer if:

- It is not working right.
- It is damaged.
- Parts are missing.
- All panels are not in place.

**DO NOT** let dust, lint, paper, rags, chemicals, etc., pile up around or under the dryer. **DO NOT** install against drapes or curtains.

- **SAVE THESE INSTRUCTIONS** •

## FOR YOUR SAFETY

### IF YOU SMELL GAS:

1. OPEN THE WINDOWS.
2. DON'T TOUCH ELECTRICAL SWITCHES.
3. EXTINGUISH ANY OPEN FLAME.

4. IMMEDIATELY CALL YOUR GAS SUPPLIER.

DO NOT STORE OR USE GASOLINE OR OTHER FLAMMABLE VAPORS AND LIQUIDS IN THE VICINITY OF THIS OR ANY OTHER APPLIANCE.

## PARTS AND FEATURES

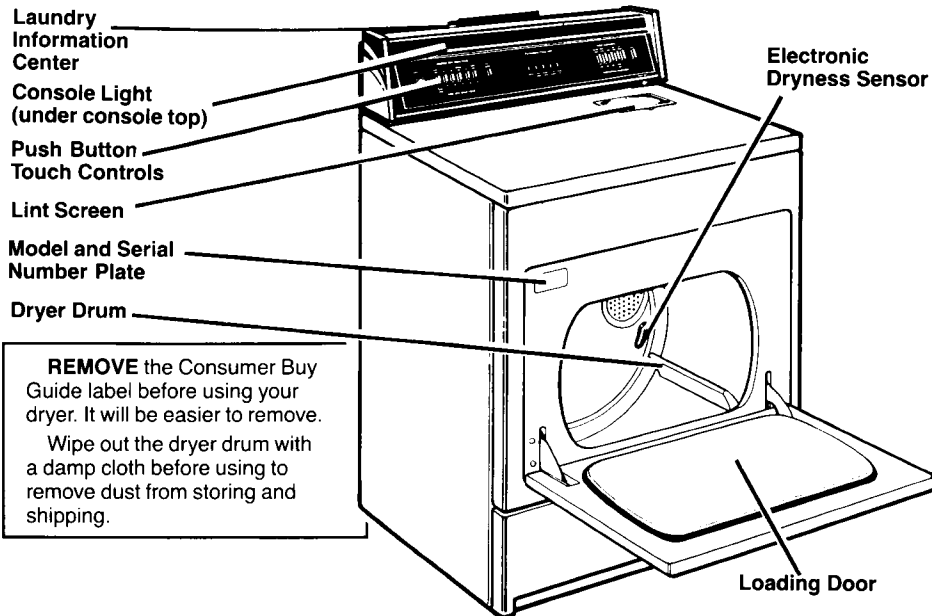

### Copy Your Model and Serial Numbers Here

When you need service or call with a question, have this information ready:

1. **Complete** Model and Serial Numbers (from plate located as shown).

2. Purchase date from sales slip.

Copy this information in these spaces. Keep this book in the Laundry Information Center with your "Dryer Guide" and sales slip.

**Please complete and mail the Owners Registration Card furnished with this product.**

\_\_\_\_\_

Model Number

\_\_\_\_\_

Serial Number

\_\_\_\_\_

Purchase Date

\_\_\_\_\_

Service Company Phone Number

# SETTING A SELECTION AND STARTING YOUR DRYER

**Before starting your dryer, be sure laundry is sorted and loaded properly (see the "Dryer Guide"). Be sure the door is tightly closed.**

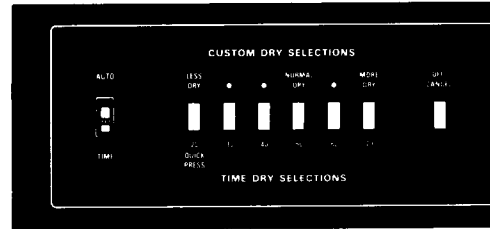

## 1. Select AUTO or TIME DRY

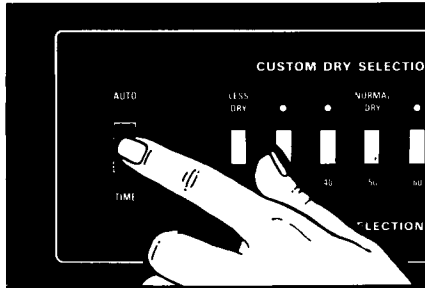

- Set the switch for AUTO or TIME DRY selections.

## 2. Push a CUSTOM DRY or TIME DRY SELECTION

### CUSTOM DRY

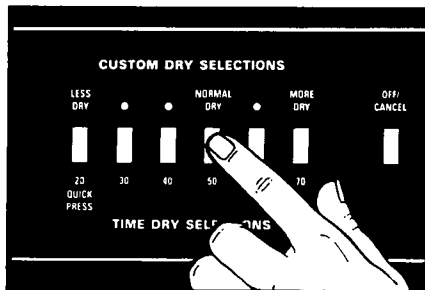

- Touch the CUSTOM DRY Selection that describes the dryness you want for the load.

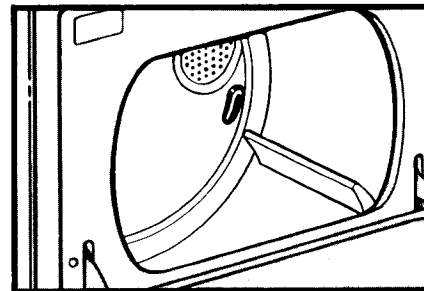

A sensor on the back of the dryer drum senses the moisture in the load. When the selected dryness has been reached, the dryer automatically shuts off. **If dryness is not what you expected, use the following as a guide:**

- For the first few loads, use NORMAL DRY. When finished, check the load for desired dryness.
- If the load is not dry enough, use MORE DRY or the setting between NORMAL and MORE.
- If the load is too dry, use LESS DRY or one of the settings between NORMAL and LESS.
- If you plan to iron the clothes after drying, use LESS DRY.

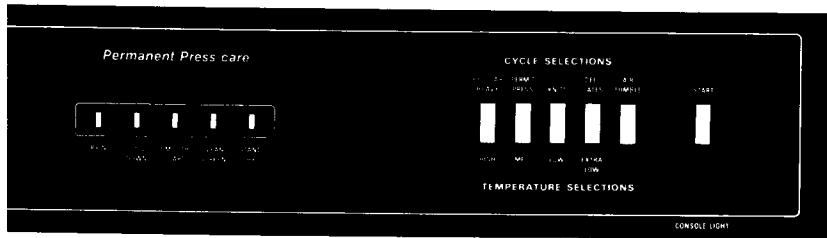

## TIME DRY

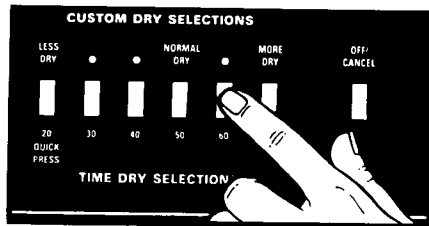

- Touch a TIME DRY Selection for any load you want to dry by time.

The TIME DRY Selection is good for very small loads or large bulky items.

## 3. Push a CYCLE/TEMPERATURE SELECTION

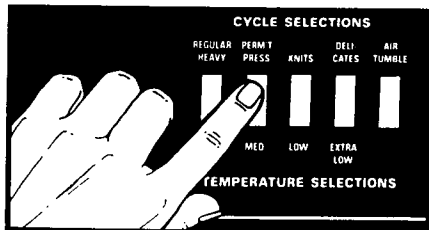

- Touch a CYCLE Selection that matches the load type you want to dry. The dryer selects the correct temperature for the load type selected.

**CAUTION: Drying plastic or rubber items with heat may damage the items or be a FIRE HAZARD.**

## 4. Push START Button

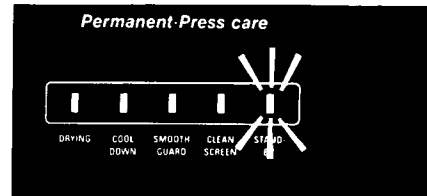

- After the START button is pushed you will hear a clicking sound until the selections are found. **NOTE:** The STAND BY Light and clicking sound also appears between each cycle phase.

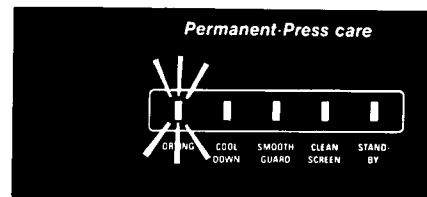

- When the clicking stops, the DRYING Indicator Light will come on. The dryer will tumble for the time and temperatures you selected.

**IMPORTANT: If the load you have finished drying is not dry enough:**

1. Touch OFF/CANCEL.
2. Set TIME DRY for 20 minutes.
3. Touch a CYCLE/TEMPERATURE for the load type.

**Remember to select a different dryness setting for the next similar load.**

## Changing a Selection

To change a **CUSTOM or TIME DRY Selection** while dryer is running, follow these steps:

- **Press new selection** – the cycle sentry will buzz, the **STAND BY** indicator light will come on and you will hear a clicking sound until the dryer shuts off.
- After the dryer has stopped, **press the START button**.

To change a **CYCLE or TEMPERATURE Selection** while the dryer is running:

- **Press new selection** – the dryer will automatically adjust selections.

## The Indicator Lights

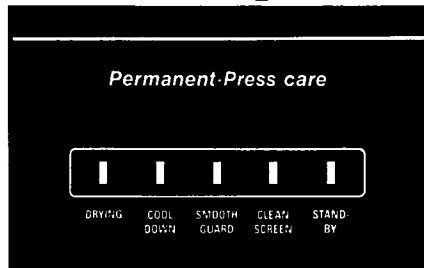

The indicator lights show what portion of the drying cycle the dryer is in: **DRYING**, **COOL DOWN**, **SMOOTH GUARD**, **STAND BY**.

**DRYING** indicates any drying time with heat.

**COOL DOWN** indicates that the dryer is in the last 10 minutes of any drying cycle. This portion of the drying cycle is without heat.

**SMOOTH GUARD** indicates that the dryer is in the **SMOOTH GUARD** cycle. (See page 7 for more **SMOOTH GUARD** information.)

**STAND BY** comes on when the **OFF/CANCEL** button has been pushed. When the **STAND BY** light goes off, the dryer can be restarted.

**CLEAN SCREEN** indicates that the lint screen is full of lint and needs to be cleaned.

# OPTIONS

## QUICK PRESS Selection

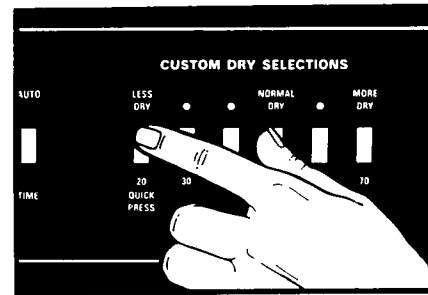

This selection is useful for removing wrinkles from items which have been packed in suitcases or closets. Pushing the **QUICK PRESS** Button automatically gives you 15 minutes of tumbling at the medium fabric temperature and 5 more minutes of cool-down without heat.

For best results, **QUICK PRESS** only a few items at a time. Put them on hangers or fold them as soon as the dryer stops.

## AIR TUMBLE Selection

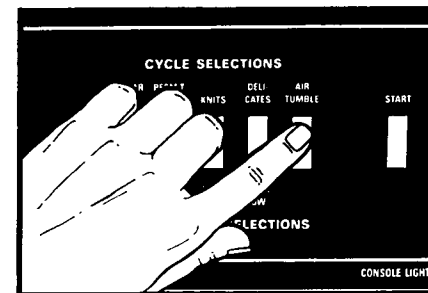

**CAUTION: Drying plastic or rubber items with heat may damage the items or be a FIRE HAZARD.**

# FEATURES

## OFF/CANCEL Button

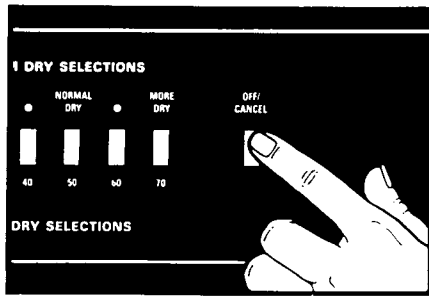

The OFF/CANCEL Button allows you to stop the dryer to check the load, clean the lint screen, or to change the drying selection.

When OFF/CANCEL is pressed, the STAND-BY Indicator Light will come on while the timer advances to OFF. You will hear clicking any time the dryer advances between cycles. When the dryer shuts off, the light also goes off.

## SMOOTH GUARD

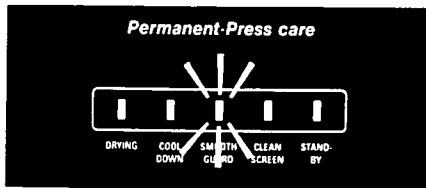

SMOOTH GUARD takes over automatically when the dry cycle is completed with a CUSTOM DRY Selection only.

SMOOTH GUARD tumbles the load, without heat, every 5 minutes to prevent wrinkles that set in when the load remains in the dryer. It continues up to 45 minutes or until the door is opened to remove the clothes.

- SMOOTH GUARD Indicator Light will stay on as long as the dryer is running. Remember that SMOOTH GUARD is selected automatically with a CUSTOM DRY Selection.

- If the door is opened during the SMOOTH GUARD cycle, the dryer will shut off and cancel SMOOTH GUARD.

## CYCLE SENTRY Signal

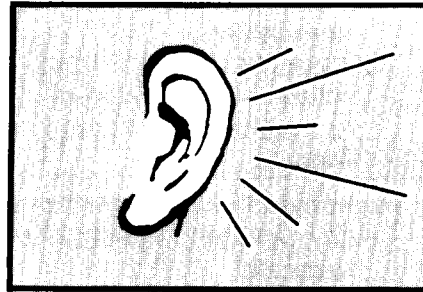

The dryer will buzz to let you know when the cycle is finished. It will also buzz after each SMOOTH GUARD tumbling. The signal is automatic with a non-adjustable volume.

The signal is helpful when you are drying permanent press, synthetics and other items that should be taken out as soon as the dryer stops.

## Cushioned Heat

The dryer automatically reduces the heat settings in REGULAR HEAVY and PERM'T PRESS cycles. During the last 7 minutes of each of these cycles the dryer temperature gradually reduces to a lower setting. **COOL DOWN takes over automatically after Cushioned Heat is finished.** This helps prevent overdrying.

## Cool Down Times

In all cycles, the heat shuts off before the dryer stops tumbling. This cool down time helps:

- Keep wrinkles from setting in.
- Make handling the hot load items easier.

**This chart suggests fabric loads and cycle selections.**

TYPE OF LOAD	CYCLE SELECTION
<p><b>Cottons and Linens</b>            EXTRA HEAVY – Bedspreads, mattress pads, quilts.            HEAVYWEIGHT FABRICS – Towels, jeans, corduroys, work clothes.            MEDIUMWEIGHT COTTONS – Sheets, pillowcases, cotton underwear, diapers.            LIGHTWEIGHT COTTONS – Batistes, organdies, lingerie.</p>	<p><b>REGULAR/ HEAVY</b></p>
<p><b>Permanent Press, Synthetics and Blends</b>            HEAVYWEIGHT FABRICS – Work clothes, jackets, raincoats.            MEDIUMWEIGHT FABRICS – Shirts, play clothes, sheets, slacks.            LIGHTWEIGHT FABRICS – Lingerie, blouses, dresses.</p>	<p><b>PERM'T PRESS</b></p>
<p><b>Knits</b>            HEAVYWEIGHT – Cottons, rayons, blends, t-shirts, slacks, shirts.            LIGHTWEIGHT – Synthetics (polyester, acrylic, etc.) and blend, lingerie, blouses, dresses.</p>	<p><b>KNITS</b></p>
<p><b>Lightweight and Delicate Fabrics</b>            Sheer curtains (2 or 3 panels).            Gauze, lace, etc.</p>	<p><b>DELICATES</b></p>
<p><b>Rubber, Plastic, Heat-Sensitive Fabrics</b>            FOAM RUBBER – Pillows, bras, stuffed toys.            PLASTICS – Shower curtains, tablecloths.            RUBBER-BACKED RUGS – Fluff bedding or dust drapes.</p> <p><b><i>WARNING: Drying heat-sensitive materials with heat can damage them or be a FIRE HAZARD.</i></b></p>	<p><b>AIR TUMBLE</b></p>



# DRYING TIPS

## Mixed Loads

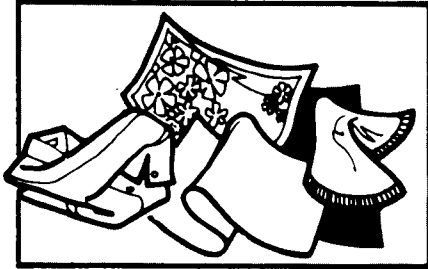

When drying a load with different kinds and weights of fabrics, use the setting suggested for the lightest fabrics.

**NOTE:** Overdrying can cause shrinkage, static cling and damage to some fabrics.

**To help reduce wrinkling**, take the load from the dryer as soon as tumbling stops. This is very important for permanent press, knits and synthetic fabrics.

## Drying Times



- Drying times will vary depending on one or more of the following:
- Amount of moisture in the clothes.
  - Type and weight of the fabric.
  - Size of the load.
  - Room temperature around the dryer.
  - Temperature of the wash/rinse water.
  - Amount of lint in the lint screen.
  - Dryer temperature selection.

See your "DRYER GUIDE" for more information.

## LINT SCREEN

**Clean the lint screen before each load.** A screen blocked by lint can increase drying time and may be a FIRE HAZARD.

**WARNING: DO NOT run the dryer with the lint screen loose, damaged or missing. Doing so can cause overheating, can damage fabrics and can be a FIRE HAZARD.**

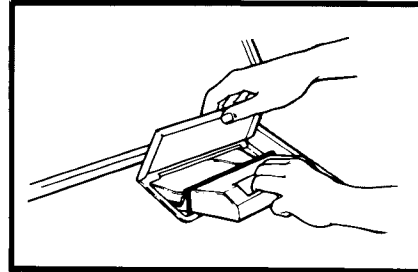

1. Open the lid and pull the lint screen straight out.

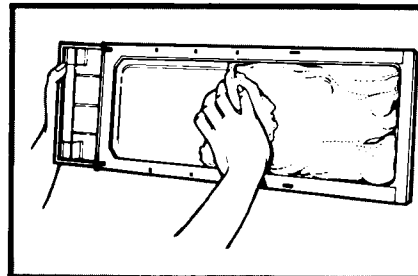

2. **ROLL** the lint off the screen with your fingers. **Do Not rinse or wash the screen.**
3. Push the screen firmly back into place.

# LINT REMOVAL

Lint can gather inside the dryer and create a fire hazard. **This lint should be removed every 2 to 3 years, or more often, depending on dryer usage.**

## WARNING:

- **Avoid electrical shock hazard. Unplug the power supply cord or turn off the electrical power.**
- **Avoid injury or damage. Do not put hands inside the cabinet.**
- **Make sure the dryer is cool.**

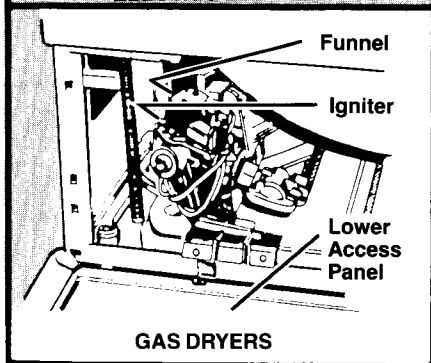
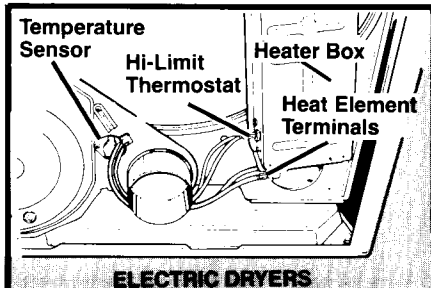

**Cleaning should be done by a qualified person.**

1. Remove back panel (electric) or lower access panel (gas).
2. Avoid damaging wires, thermostats, funnel or igniter.
3. Remove lint from shaded area with a soft brush or vacuum cleaner.
4. Replace panel, reconnect and re-level dryer.

# CARING FOR YOUR DRYER

## The Console Light

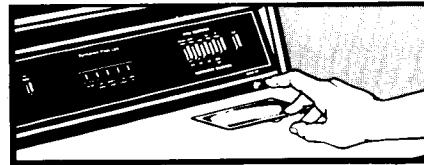

The fluorescent console light is under the console top. The **Console Light** switch is on the bottom right side of the console. To turn on the light, push in the switch and hold it for a second or two. Push the switch again to turn the light off.

## Replacing the Console Light

**WARNING: To avoid possible shock hazard, unplug dryer power cord or turn off electrical power at the main power supply.**



1. Flip up the console top by grasping it with both hands near each end and lifting the front edge up.

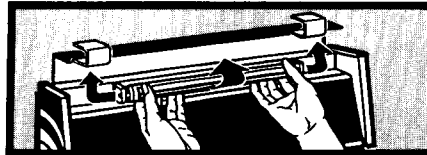

2. Remove lamp socket safety cover at both ends of fluorescent tube.
3. Grasp fluorescent tube at both ends. Turn tube away from you until both ends come out of the receptacles. Replace with a 15-watt cool-white (#F15T8) fluorescent tube. Close the console top.
4. Replace lamp socket safety covers.
5. Plug in the dryer power cord or turn the electrical power back on at the main power supply.

## The Drum Light

The Drum Light automatically comes on inside the dryer drum when the dryer loading door is opened.

### Replacing the Drum Light

**WARNING:** To avoid possible shock hazard, unplug the dryer power cord or turn off the electrical power at the main power supply.

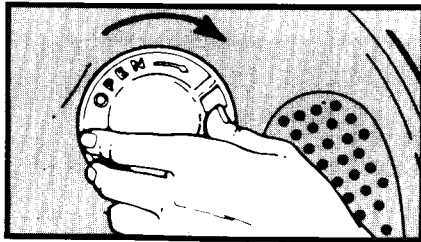

1. Open the dryer door and remove light bulb cover by turning it clockwise.

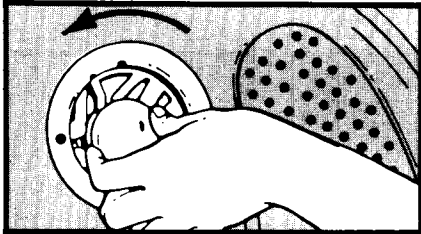

2. Remove the light bulb by turning it counterclockwise.
3. Replace the bulb with a 40-watt appliance bulb only.
4. Replace the light bulb cover and lock it in place by turning counterclockwise.

**CAUTION:** The bulb cover must be securely in place during dryer operation to prevent overheating and possible damage to fabrics. Operating the dryer with the bulb cover removed can cause the dryer to fail or create a FIRE HAZARD.

## Dryer Care

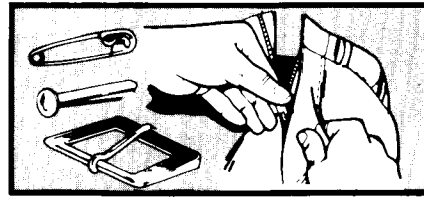

**REMOVE LOOSE AND SHARP OBJECTS** (such as pins, buckles, etc.) from clothing before drying. Close metal zippers.

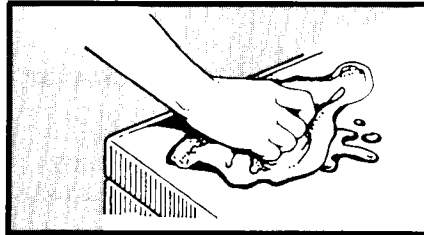

**WIPE OFF ALL SPILLS** with a damp, soft cloth. Spills allowed to remain may dull or damage the finish.

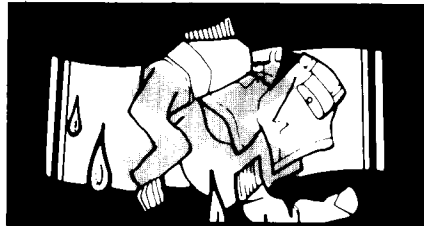

**NEVER** leave wet or damp laundry in your dryer.

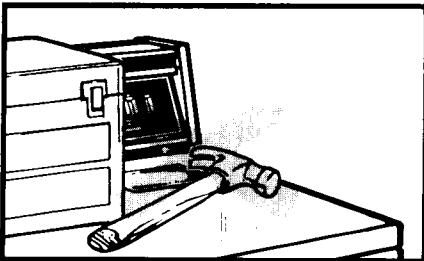

**SHARP OR HEAVY OBJECTS** should never be put on or in the dryer. Check pockets for bolts, nuts, etc.

**continued on next page**



**SOME PRETREATMENT PRODUCTS** can damage the dryer buttons, consoles and finishes. Do not use these products on or near your dryer.

### Cleaning the Dryer Interior

**WARNING:** Before cleaning interior, unplug power supply cord or turn off electrical power to avoid electrical hazard.

Garments which contain unstable dyes, such as denim blue jeans or brightly colored cotton items, may discolor the dryer interior. If the interior is discolored, clean with one of the following methods to avoid staining later load items.

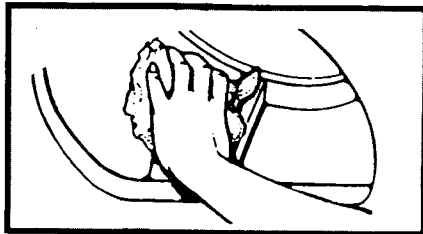

#### **Powdered laundry detergent and very warm water**

Make a paste with detergent and very warm water. Apply paste to a soft cloth and scrub area until all excess dye is removed. Wipe thoroughly with a damp cloth. Tumble a load of rags. **—OR—**

#### **Liquid spray household cleaner**

Spray on stained area. Rub with a cloth until all excess dye is removed. Tumble a load of rags.

### Vacation Care

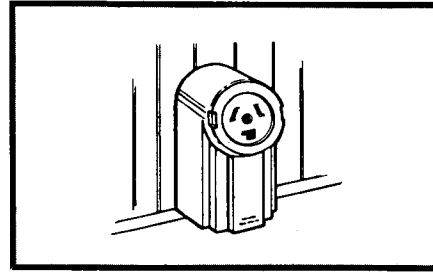

1. Unplug the power cord or turn off the electrical power.

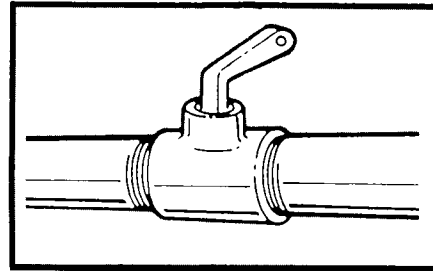

2. For gas dryers, close the gas valve.

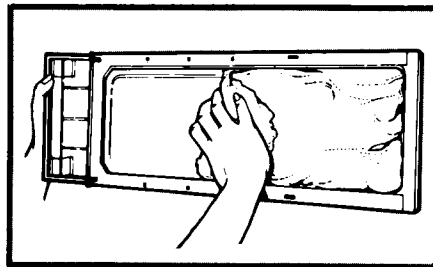

3. Clean the lint screen.

# IF YOU NEED SERVICE OR ASSISTANCE

## Follow These Steps

1. If your dryer should fail to operate, review the following list before calling your dealer. You could save the cost of a service call.



### If your dryer does not run:

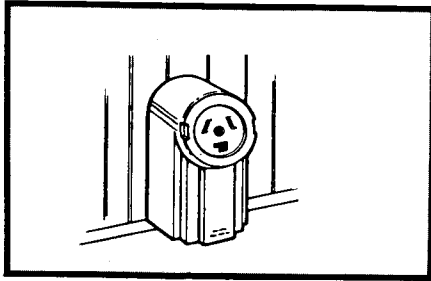

- Is the power supply cord plugged into a live circuit with the proper voltage?
- Is the door closed tightly?

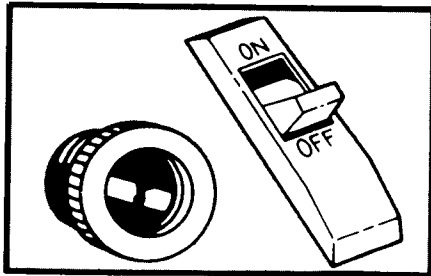

- Have you checked your home's main fuses or circuit breaker box?
- Did you push a **CYCLE SELECTION**?

### If your dryer does not heat:

- The **AIR TUMBLE** Selection is without heat.
- The last minutes of heating in all selections are without heat.

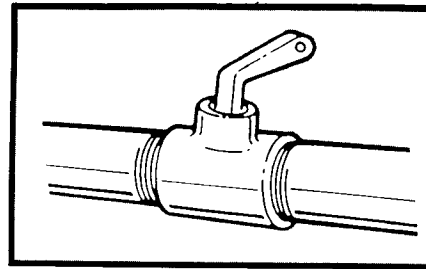

- Is the gas turned on? If not, Push **OFF/CANCEL** and wait for dryer to shut off. Turn on the gas. Wait 5 minutes, then reset control to start.
- An electric dryer requires two fuses or a circuit breaker. If one fuse is blown, the dryer may run, but not heat.

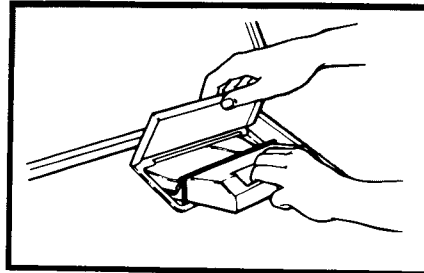

### If drying times seem too long:

- Is the lint screen clean?
- See page 6 of your "DRYER GUIDE."

### IF YOUR DRYER STOPS DURING A CYCLE AND STARTS CLICKING:

- Remember, the dryer pauses briefly between each portion of every drying cycle. These pauses are normal. The clicking is the dryer timer.

**continued on next page**

- 2.** If the problem is not due to one of the above items, first call your dealer or repair service he recommends.
  - All service should be handled locally by the dealer from whom you purchased the unit or an authorized KitchenAid servicer.
- 3.** In the event you are unable to obtain the name of a local authorized KitchenAid servicer, call KitchenAid Consumer Affairs, TOLL FREE: 1-800-422-1230
  - A Consumer Affairs representative can recommend a qualified service company in your area.
- 4.** If you are not satisfied with the action taken, contact the Major Appliance Consumer Action Panel (MACAP). MACAP is a group of independent consumer experts that voices consumer views at the highest levels of the major appliance industry. Contact them only when the dealer, authorized servicer or KitchenAid, Inc., have failed to resolve your problem.

Major Appliance Consumer  
Action Panel  
20 North Wacker Drive  
Chicago, Illinois 60606

MACAP will in turn inform us of your action.

If you must call or write, please provide: Model Number, Serial Number, Date of Purchase and complete description of the problem.

Write to:

KitchenAid Consumer Affairs  
KitchenAid, Inc.  
3800 Space Drive  
Dayton, Ohio 45414



# KitchenAid<sup>TM</sup>

## DRYER WARRANTY

LENGTH OF WARRANTY:	KITCHENAID WILL PAY FOR:	KITCHENAID WILL NOT PAY FOR:
<b>ONE YEAR FULL WARRANTY FROM DATE OF PURCHASE.</b>	Replacement parts and repair labor to correct defects in materials or workmanship. Service must be provided by an authorized KitchenAid servicing outlet.	A. Service calls to: <ol style="list-style-type: none"> <li>1. Correct the installation of the dryer.</li> <li>2. Instruct you how to use the dryer.</li> <li>3. Replace house fuses or correct house wiring.</li> <li>4. Correct house plumbing.</li> </ol> B. Repairs when dryer is used in other than normal home use. C. Damage resulting from accident, alteration, misuse, abuse, improper installation or installation not in accordance with local electrical or plumbing codes. D. Any labor costs during the limited warranties. E. Replacement parts or repair labor costs for units operated outside the United States. F. Pick up and delivery. This product is designed to be repaired in the home.
<b>FIVE YEAR LIMITED WARRANTY ONE YEAR FULL PLUS SECOND THROUGH FIFTH YEAR LIMITED FROM DATE OF PURCHASE.</b>	Replacement parts for any electric element on electric models or any burner on gas models. Rust-through protection on cabinet assembly.	
<b>TEN YEAR LIMITED WARRANTY ONE YEAR FULL PLUS SECOND THROUGH TENTH YEAR LIMITED FROM DATE OF PURCHASE.</b>	Replacement of the dryer drum if it rusts through due to defective materials or workmanship.	

**KITCHENAID, INC. DOES NOT ASSUME ANY RESPONSIBILITY FOR INCIDENTAL OR CONSEQUENTIAL DAMAGES.** Some states do not allow the exclusion or limitation of incidental or consequential damages, so this exclusion or limitation may not apply to you.

This warranty gives you specific legal rights and you may also have other rights which vary from state to state.

**KitchenAid, Inc.**  
St. Joseph, Michigan, USA 49085



## Free Manuals Download Website

<http://myh66.com>

<http://usermanuals.us>

<http://www.somanuals.com>

<http://www.4manuals.cc>

<http://www.manual-lib.com>

<http://www.404manual.com>

<http://www.luxmanual.com>

<http://aubethermostatmanual.com>

Golf course search by state

<http://golfingnear.com>

Email search by domain

<http://emailbydomain.com>

Auto manuals search

<http://auto.somanuals.com>

TV manuals search

<http://tv.somanuals.com>