

KitchenAid

FOR THE WAY IT'S MADE.



KitchenAid Built-In Thermal and Thermal-Convection™ Ovens

MODELS KEBN107Y KEBN100Y

A Note To You	2
Important Safety Instructions	3
Parts And Features	5
About Convection Ovens	6
Using Your Oven	7
Using The Self-Cleaning Cycle	25
Caring For Your Oven	29
If You Need Assistance Or Service	33
KitchenAid Warranty	36

Call Us With Questions
Or Comments:
1-800-422-1230

Use and Care Guide

A Note To You

Thank you for buying a KitchenAid home appliance.

You have purchased a quality, *world-class* home appliance. Years of engineering experience have gone into its manufacturing. To ensure that you will enjoy many years of trouble-free operation, we have developed this Use and Care Guide. It is full of valuable information on how to operate and maintain your home appliance properly and safely. Please read it carefully. Also, please complete and mail the Ownership Registration Card provided with your home appliance.

Your safety is important to us.

This guide contains safety symbols and statements. Please pay special attention to these symbols and follow any instructions given. Here is a brief explanation of the use of each symbol.

⚠ WARNING

This symbol will help alert you to such dangers as personal injury, burns, fire and electrical shock.

⚠ CAUTION

This symbol will help you avoid actions which could cause product damage (scratches, dents, etc.) and damage to your personal property.

Our Consumer Assistance Center telephone number, 1-800-422-1230, is toll-free, 24 hours a day.

If you ever have a question concerning your home appliance's operation, or if you need service, feel free to call our toll-free Consumer Assistance Center telephone number for help. When calling, you will need to know your appliance's complete model number and serial number. You can find this information on the model and serial number plate (see diagram on page 5). For your convenience, we have included a handy place below for you to record these numbers. Also, please record the date the product was purchased/installed and the Builder's or Dealer's name, address and phone number. You will need this information if you ever require service. Keep this book and the sales slip together in a safe place for future reference.

IMPORTANT: You must provide proof of purchase or installation date for in-warranty service.

Model Number _____

Builder/Dealer Name _____

Serial Number _____

Address _____

Date Purchased _____

Phone _____

Date Installed _____

Don't forget, KitchenAid offers a full line of quality home appliances.

Built-in Refrigerators

Trash Compactors

Ranges & Cooktops

Freestanding Refrigerators

Hot Water Dispensers

Microwave Ovens

50-Pound Ice Makers

Food Waste Disposers

Washers & Dryers

Dishwashers

Built-in Ovens

Mixers

For more information on these appliances, or the one you have purchased, call our toll-free Consumer Assistance Center telephone number, **1-800-422-1230**.

Important Safety Instructions

⚠ WARNING

To reduce the risk of fire, electrical shock, injury to persons, or damage when using the oven, follow basic precautions, including the following:

General

- Read all instructions before using the oven.
- Install or locate the oven only in accordance with the provided Installation Instructions. The oven must be installed by a qualified installer. The oven must be properly connected to electrical supply and grounded.
- **CAUTION:** Do not store things children might want above the oven. Children could be burned or injured while climbing on it.
- Do not leave children alone or unattended in area where the oven is in use. They should never be allowed to sit or stand on any part of the oven. They could be burned or injured.
- Do not operate the oven if it is damaged or not working properly.
- Do not use the oven for warming or heating the room. Persons could be burned or injured, or a fire could start.
- Use the oven only for its intended use as described in this manual.
- **DO NOT TOUCH HEATING ELEMENTS OR INTERIOR SURFACES OF OVEN.** Heating elements may be hot even though they are dark in color. Interior surfaces of an oven become hot enough to cause burns. During and after use, do not touch, or let clothing or other flammable materials contact heating elements or interior surfaces of oven until they have had sufficient time to cool. Other surfaces of the oven may become hot enough to cause burns; such as, the oven vent opening, the surface near the vent opening, the oven door and window.
- Do not wear loose or hanging garments when using the oven. They could ignite if they touch a hot heating element and you could be burned.
- Use only dry potholders. Moist or damp potholders on hot surfaces may result in burns from steam. Do not let potholder touch hot heating elements. Do not use a towel or bulky cloth for a potholder. It could catch on fire.
- Keep oven vents unobstructed.

continued on next page

- Do not heat unopened containers. They could explode. The hot contents could cause burns and container particles could cause injury.
- Do not store flammable materials on or near the oven. The fumes can create an explosion and/or fire hazard.

When using the oven

- Always position oven rack(s) in desired location while oven is cool. If a rack must be removed while oven is hot, do not let potholder contact hot heating element in oven.
- Use care when opening oven door. Let hot air or steam escape before removing or replacing food.

Grease

- Grease is flammable and should be handled carefully. Let fat cool before attempting to handle it.
- Do not use water on grease fires. Never pick up a flaming pan. Smother flaming pan by covering with a well-fitted lid, cookie sheet or flat tray. Flaming grease outside of pan can be extinguished with baking soda or, if available, a multipurpose dry chemical or foam-type extinguisher.

Care and cleaning

- Small amounts of formaldehyde and carbon monoxide are given off in the

Self-Cleaning cycle from fiberglass insulation and food decomposition. Significant exposure to these substances can cause cancer or reproductive harm. Exposure can be minimized by venting with a hood or open window and wiping out excess food spills prior to self-cleaning.



- Do not use oven cleaners. No commercial oven cleaner or oven liner protective coating of any kind should be used in or around any part of the oven.
- Before self-cleaning the oven, remove broiler pan, broiler grid, oven racks and other utensils. Do not use your oven to clean miscellaneous parts unless you are instructed to do so in this Use and Care Guide.
- Do not clean door gasket. It is essential for a good seal. Care should be taken not to rub, damage or move the gasket. Clean only parts recommended in this Use and Care Guide.
- Do not repair or replace any part of the oven unless specifically recommended in this manual. All other servicing should be referred to a qualified technician.
- Disconnect the electrical supply before servicing the oven.

- SAVE THESE INSTRUCTIONS -

Parts And Features

This section contains captioned illustrations of your oven. Use them to become familiar with the location and appearance of all parts and features.

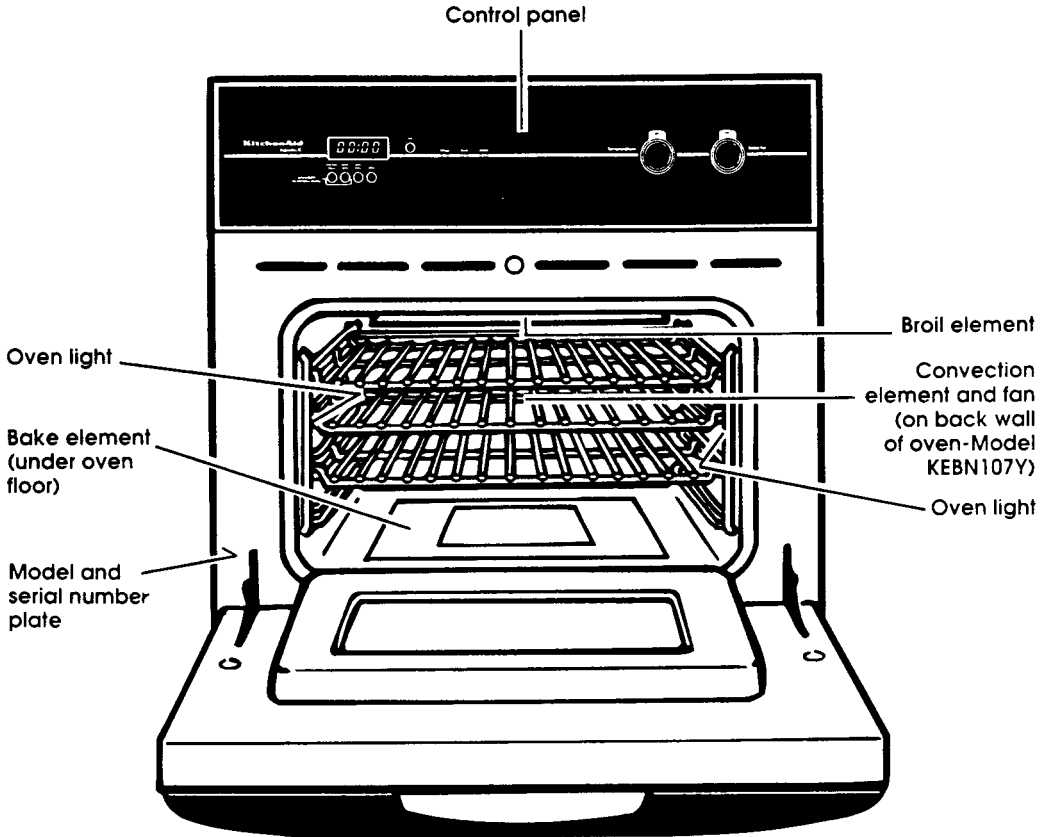

IMPORTANT: There is a cooling fan that runs when the Oven Selector is in any position except "OFF". The fan will remain on after cooking/cleaning functions, until the oven has cooled sufficiently.

Utensil and Setting Use Chart

Use either the broiler pan grid or the convection roasting rack with the broiler pan. See pages 18 and 20 for additional information.

UTENSIL	SETTING
Broiler pan grid/ convection roasting rack	BROIL CONVECTION BROIL CONVECTION ROAST
Broiler pan	BROIL CONVECTION BROIL CONVECTION ROAST

About Convection Ovens

(Model KEBN107Y)

The word "convection" means "the act of conveying." A convection oven is like a hair dryer—there is a heating element and a fan. The fan conveys the heat from the heating element around the oven cavity by moving the air. A standard oven is like a heat lamp—the heat radiates from the heating element to the food, but the air does not move. The moving air in a convection oven offers better baking results when cooking with multiple oven racks because the air can get to all sides of the food. It also tends to heat foods faster.

Because of faster heating, many types of foods can be cooked at lower temperatures than those suggested for standard ovens.

For example, you can roast a large cut of meat in a convection oven at 300°F (usually for a shorter period of time) compared to 325°F in a standard oven. Fruit and nut breads bake best at 300°F in a convection oven—about 50°F lower than the temperature recommended for a standard oven.

Convection ovens also tend to maintain a constant temperature (because of the hot swirling air) which leads to more even cooking. Egg and cheese dishes bake higher and lighter in a convection oven. A constant, even temperature also results in lofty soufflés and puffy, crisp-crustéd quiche.

Using Your Oven

In This Section		Page	Page	
The oven control panel		7	Control settings	14
The electronic clock/oven control	8	Baking/roasting and convection		
Setting the electronic clock	9	baking/roasting	15	
Using the electronic Kitchen Timer	10	Broiling and convection broiling	19	
Using the oven controls	11	Using the electronic clock/oven control	21	
Oven racks	13	Other operating hints	24	

To obtain the best cooking results possible, you must operate your oven properly. This section gives you important information for efficient and safe use of your oven.

The oven control panel

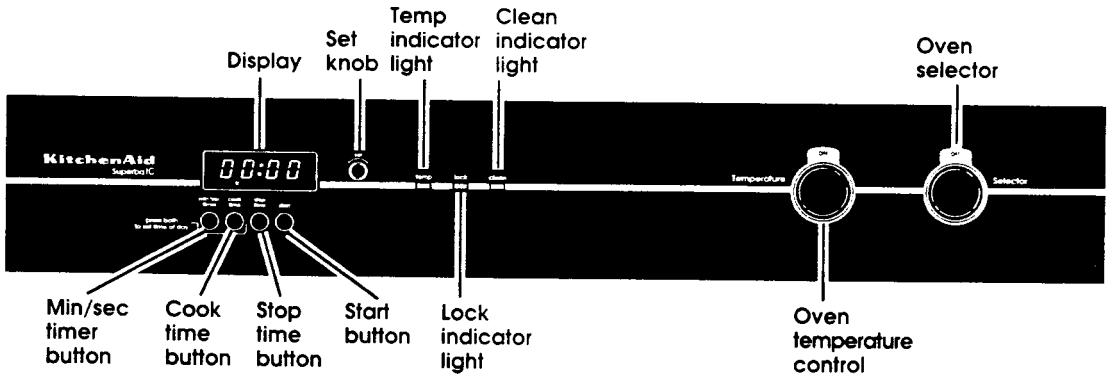

The electronic clock/oven control

The electronic clock/oven control handles many different types of functions. The following operating hints may be helpful when using the clock:

- The numbers on the display change rapidly when turning the Set Knob.
- When setting the Time-of-Day clock, the display shows hours and minutes.



Twenty-five minutes past six o'clock.



Forty-five minutes past twelve o'clock.



- When using the Kitchen Timer, the display shows minutes and seconds in the sequence shown.

– For settings from 1-59 seconds, each second will show in the display.

– For settings from 1-10 minutes, the display will increase in 10-second increments.



– For settings from 10-99 minutes, the display will increase in 1-minute increments.



- When using the Cook Time and/or Stop Time, the display shows hours and minutes.

Other operating hints may be found on page 24.



Two hours and fifteen minutes.



Eleven hours and fifty-nine minutes.

Setting the electronic clock

When you first plug in the oven or if your electricity goes off for a while, each light in the display will flash in sequence.

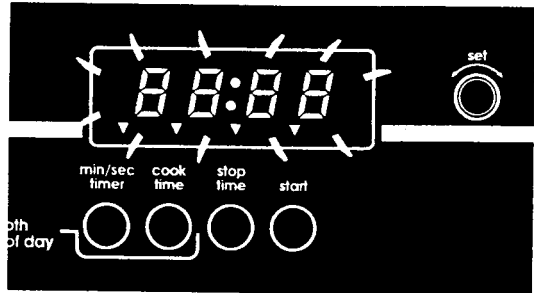

Then, 4 eights and the MIN/SEC TIMER and COOK TIME Indicator Lights will flash. The flashing means that the clock is ready to be set.

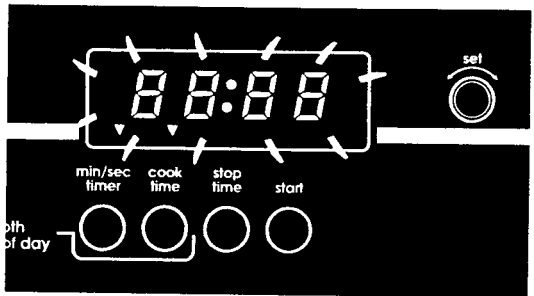

1. Push in both the Min/Sec Timer button and the Cook Time button. "0:00" will show in the display and the Indicator Lights will go off.

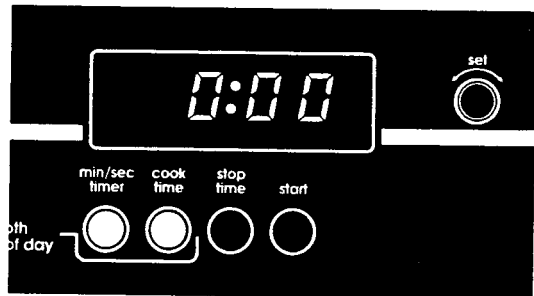

2. Turn the Set Knob to set the correct time of day. Turning the knob clockwise increases the numbers, while turning the knob counterclockwise decreases the numbers. The display will show the time you set in hours and minutes.

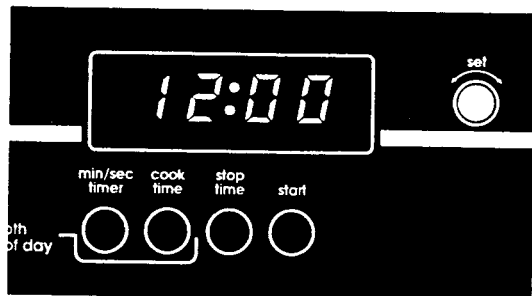

Using the electronic Kitchen Timer

The Kitchen Timer does not start or stop the oven. It works like a kitchen timer. It can be set in minutes and seconds up to 99 minutes. You will hear beeps when the set time is up.

1. Push in the Min/Sec Timer button. The Indicator Light will come on and the display will show "00:00".

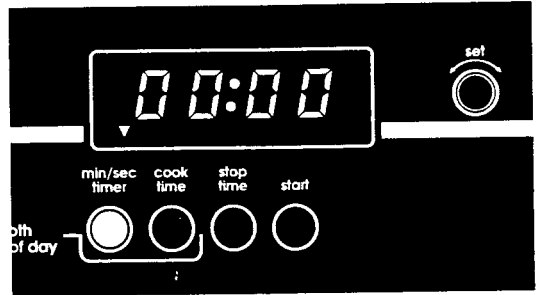

2. Turn the Set Knob until the desired time shows in the display. Turning the knob clockwise increases the numbers, while turning the knob counterclockwise decreases the numbers.

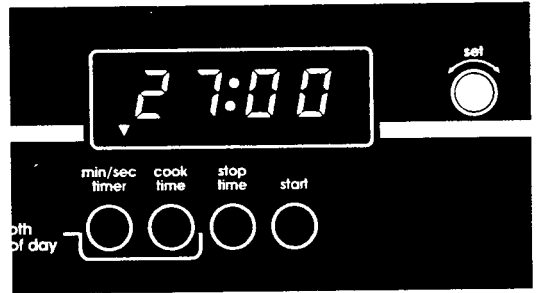

3. After setting the time you want, the Indicator Light will stay on and the display will start counting down in seconds.

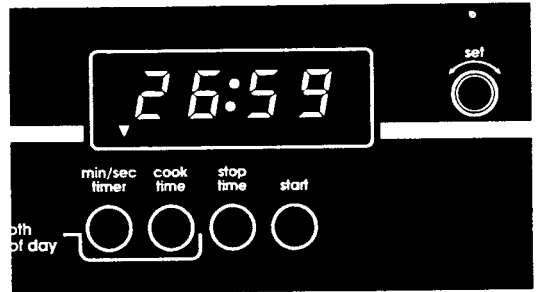

4. When the time is up, you will hear a beeping sound. Push the Min/Sec Timer button to stop the beeping. The beeping will automatically stop after 1-2 minutes.



Using the oven controls

Thermal-convection model (Model KEBN107Y):

The thermal-convection oven can be used for baking, roasting and broiling, as well as convection baking, roasting and broiling. The oven has two control knobs—a Selector and a Temperature Control. Both must be set for the oven to work. To use the control knobs, which are flush with the control panel, first push them in and release. The knobs will pop out, making them easy to turn. If you wish to again make the knobs flush with the control panel after turning them off, push knobs in and release. Knobs will stay flush until you push them again.

The selector has nine settings:

CONV BROIL—Use this setting for Convection Broiling.

MAXI BROIL—Use this setting for broiling a full rack of food with both broil elements.

ECONO BROIL—Use this setting for broiling a partial rack of food with the inner broil element.

CONV BAKE—Use this setting for Convection Baking.

CLEAN—Use this setting for Self-Cleaning only.

BAKE—Use this setting for baking, roasting and heating casseroles.

CONV ROAST—Use this setting for Convection Roasting.

LIGHT—Use this setting to turn on the oven light.

OFF—Use this setting to turn off the oven.

Temperature control:

The Temperature Control can be set at any temperature from 100°F (warm) to 500°F (broil), or to CLEAN. Settings 100°F to 250°F are suggested for warming and holding food. Be sure the Temperature Control is turned to OFF when the oven is not in use.

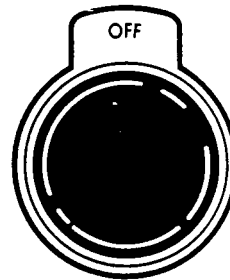

Selector

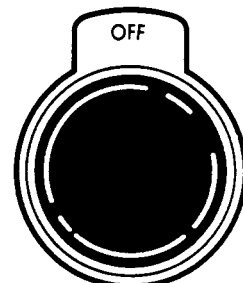

Temperature

Non-thermal-convection model (Model KEBN100Y):

The non-thermal-convection oven can be used for baking, roasting and broiling. The oven has two control knobs—a Selector and a Temperature Control. Both must be set for the oven to work. To use the control knobs, which are flush with the control panel, first push them in and release. The knobs will pop out, making them easy to turn. If you wish to again make the knobs flush with the control panel after turning them off, push knobs in and release. Knobs will stay flush until you push them again.

The selector has six settings:

MAXI BROIL—Use this setting for broiling a full rack of food with both broil elements.

ECONO BROIL—Use this setting for broiling a partial rack of food with the inner broil element.

CLEAN—Use this setting for Self-Cleaning only.

BAKE—Use this setting for baking, roasting and heating casseroles.

LIGHT—Use this setting to turn on the oven light.

OFF—Use this setting to turn off the oven.

Temperature control:

The Temperature Control can be set at any temperature from 100°F (warm) to 500°F (broil), or to CLEAN. Settings 100°F to 250°F are suggested for warming and holding food. Be sure the Temperature Control is turned to OFF when the oven is not in use.

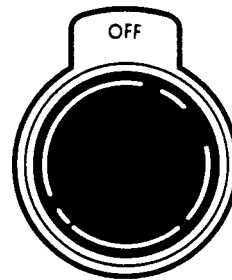

Selector

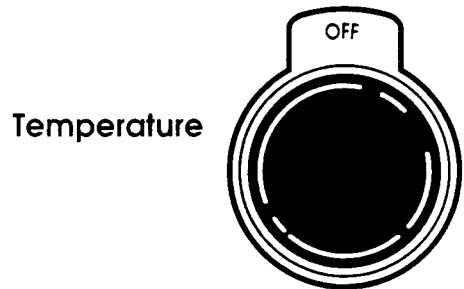

Temperature

Oven racks

Rack positions

Your oven has four rack positions. Rack position 4 is the highest position, or farthest from the bottom of the oven. Rack position 1 is the lowest position, or closest to the bottom of the oven.

There are three racks for the oven. Be sure to arrange the oven rack(s) before putting food into the oven or turning the oven on.

⚠ WARNING

Personal Injury Hazard

- Always position oven rack(s) in desired location before turning oven on. Be sure the rack(s) is level.
- If rack(s) must be moved while oven is hot, use potholders or oven mitts to protect hands.

Failure to follow the above precautions may result in personal injury.

To remove oven racks:

Lift rack at front and pull out.

To replace oven racks:

1. Place rear of rack on rack guides.
2. While lifting front of rack, push in all the way. Lower front.

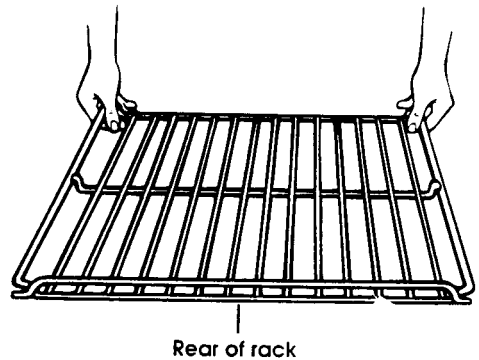
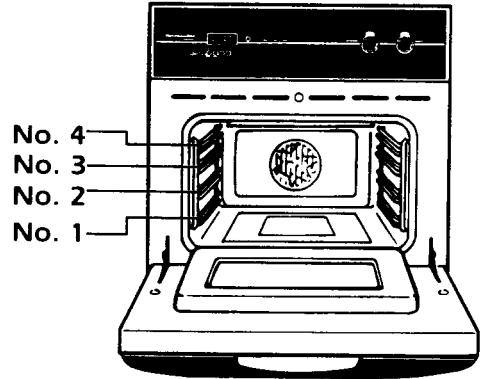

Control settings

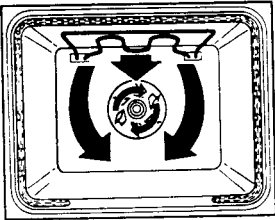
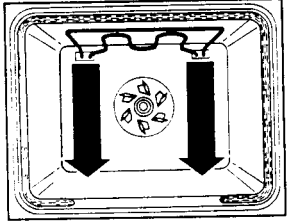
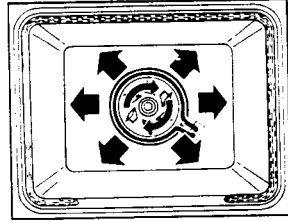
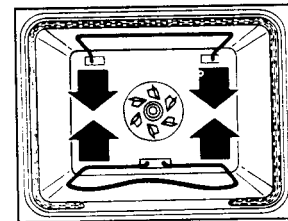
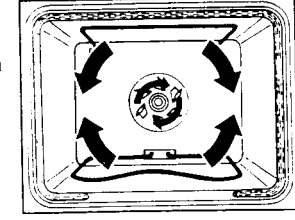
SETTING	DIAGRAM	SETTING INFORMATION
<p>CONV BROIL (thermal-convection oven, closed door)</p>		<p>During Convection Broiling, the top element(s) operates at full power whenever heating. Air in the oven cavity is circulated by the fan for even heating. Use this setting for broiling thick cuts of meat.</p>
<p>MAXI/ECONO BROIL (opened or closed door)</p>		<p>During Broiling, the top element(s) operates at full power whenever heating. Use this setting for broiling.</p>
<p>CONV BAKE (thermal-convection oven)</p>		<p>The rear element operates at full power whenever heating. Air in the oven cavity is circulated by the fan for even heating. Use this setting for foods which require gentle heating, and for baking breads and cakes. This setting is also recommended when baking large quantities of food on more than one oven rack.</p>
<p>BAKE (ROAST)</p>		<p>The bottom element and outer top element operate at full power and glow red whenever heating. Use this setting for baking, roasting, and heating casseroles.</p>
<p>CONV ROAST (thermal-convection oven)</p>		<p>The bottom element and outer top element operate at full power and glow red whenever heating. Air in the oven cavity is circulated by the fan for even heating and faster cooking. Use this setting for roasting.</p>
<p>CLEAN</p>		<p>Use this setting for self-cleaning only.</p>

Baking/roasting and convection baking/roasting

1. Position the rack(s) properly **before** turning on the oven. **To change rack position**, lift rack at front and pull out.
2. **Thermal-convection model:** Set the Oven Selector to BAKE, CONV BAKE or CONV ROAST.
Non-thermal-convection model: Set the Oven Selector to BAKE.



Selector

3. Set the Oven Temperature Control to the temperature you want.

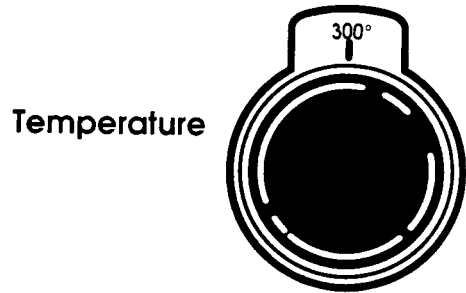

Temperature

4. Push in the Start button. The TEMP Indicator Light will come on. The oven is preheated when the TEMP Indicator Light first goes off.

IMPORTANT: The oven is automatically set to bake/roast for 3 hours. You can increase this cooking time to 4 hours or reduce it to 1 minute by turning the Set Knob. (This range is sufficient for most baking/roasting.) If you want to bake/roast longer than 4 hours, follow Steps 1-3, then push in the Cook Time button and turn the Set Knob until the desired cooking time is displayed.

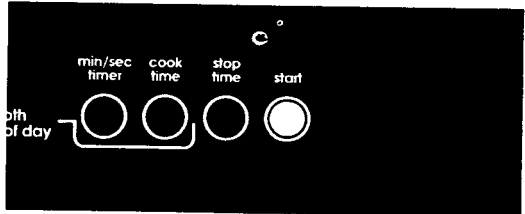

5. Put food in the oven.

During baking or roasting, the elements will turn on and off to keep the oven temperature at the setting. The TEMP Indicator Light will turn on and off with the elements.

IMPORTANT: The top element helps heat during baking/roasting.

6. When baking/roasting is done, push in the Start button to return to the time of day. Turn **both** the Oven Selector and the Oven Temperature Control to OFF. The TEMP Indicator Light will go out.

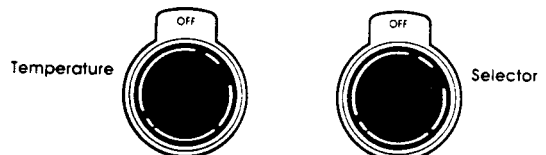

Temperature

Selector

Baking/convection baking tips

The hot air must circulate around the pans in the oven for even heat to reach all parts of the oven.

For best air circulation:

- Place the pans so that one is not directly over the other.
- Allow 1½ to 2 inches of space around each pan and between pans and oven walls.
- When baking with one pan, place pan in the center of the oven rack.
- When baking with two pans, place pans in opposite corners of the oven rack.

IMPORTANT: "Oven peeking" may cause heat loss, longer cooking times and unsatisfactory baking or roasting results. Rely on your timer. Do not allow pans to touch the heat sensor on the left wall near the back. Poor baking may result.

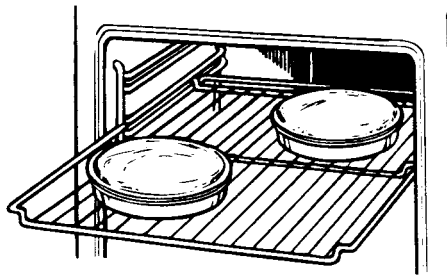

Thermal baking (Bake setting) tips:

Rack and pan placement

When using one rack, the rack should be placed so the top of the food will be centered in the oven.

For proper cooking, follow these guidelines for specific foods:

- Angel and bundt cakes, yeast breads, frozen pies, large roasts and turkeys—place rack on lowest level.
- Casseroles, muffins, most quick breads and meats—place rack on second level from bottom.
- Cookies, biscuits, cakes and non-frozen pies—place rack on second or third level from bottom.
- Use only one cookie sheet in the oven at one time.

When baking on two racks, arrange one rack on rack position 3 and the other rack on the top rack position (see page 13).

When baking on three racks, arrange racks on positions 2, 3 and 4 (see page 13).

Using aluminum foil in the oven (for thermal baking)

⚠ WARNING

Electrical Shock and Fire Hazard

Do not allow foil to touch the heating elements because it will damage them and could result in electrical shock or fire hazard.

Use aluminum foil to catch spillovers from pies or casseroles.

- Place the foil on the oven rack below the rack with the food. The foil should have the edges turned up and be about 1 inch (3 cm) larger all around than the dish holding the food.
- Do not cover the entire rack with aluminum foil. It will reduce air circulation and cause poor cooking results.
- Do not line oven bottom or entire oven rack with foil or other liners. Poor baking will result.

Convection baking (Convection Bake setting) tips:

- Do not use aluminum foil when convection baking. Aluminum foil may block airflow.
- Reduce recommended recipe oven temperature by approximately 25°F. See recipe adaption chart in the Convection Oven Cookbook for recommended temperatures.
- For most recipes, convection baking time can be reduced compared to standard baking times. See recipe adaption chart or convection baking chart in the Convection Oven Cookbook for recommended baking times.

IMPORTANT: Cooking time will be longer when you use more than one rack. This will prevent shortening of recipe cooking times.

- When baking with 2 or 3 racks, use the Convection Bake setting for more even results.
- To use three racks during convection baking, place racks on positions 2, 3, and 4 (see page 13). This allows all three racks to be an equal distance apart for better baking.
- Stagger cake pans or other utensils in opposite directions on each rack when three racks are used.

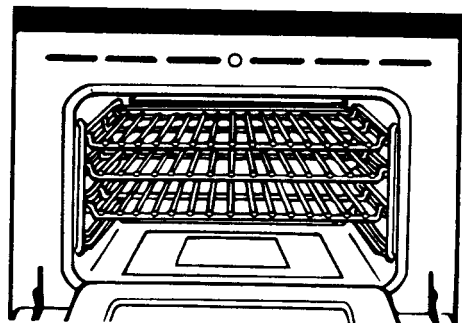
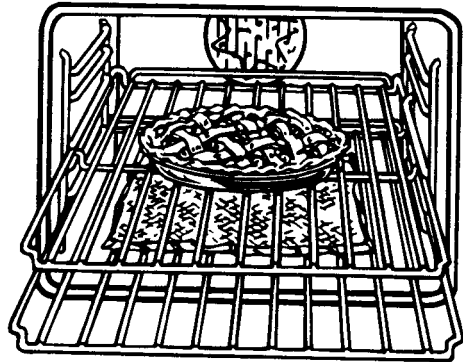

Roasting tips:

- Roast meats fat side up in a shallow pan using the roasting rack provided.
- Use a roasting pan that fits the size of the food to be roasted. Meat juices may overflow the sides of a pan that is too small. Too large of a pan will result in increased oven spatter.
- Spatter can be reduced by lining the bottom of the roasting pan with lightly crushed aluminum foil. **A foil tent is not recommended for convection roasting.**
- A foil tent will slow down surface browning for long-term roasting, as when roasting a turkey. Place tent-shaped foil loosely over meat to allow for air circulation. Do not seal foil or meat will be steamed. A foil tent is not recommended for convection roasting.
- Use an accurate meat thermometer to determine when meat has reached desired degree of doneness. Insert the thermometer into the center of the thickest portion of meat or inner thigh or breast of poultry. For an accurate reading, the tip of the thermometer should not touch fat, bone or gristle.
- After reading the thermometer once, push it further into the meat $\frac{1}{2}$ inch or more and read again. If the temperature drops, return the meat to the oven for more cooking.
- Check poultry with a thermometer in 2-3 places to ensure adequate doneness.
- Remove roasted meats from the oven when the thermometer registers 5°F to 10°F lower than the desired temperature. The meat will continue to cook after removal from the oven.
- Poultry and roasts will be easier to carve if loosely covered with foil and allowed to stand 10-15 minutes after removal from the oven.

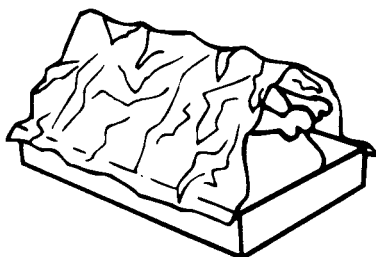

Convection roasting tips:

- For most recipes, convection roasting times and temperatures can be reduced. See recipe adaption chart or convection roasting chart in the Convection Oven Cookbook for recommended roasting times and temperatures.
- For convection roasting, do not use a roasting pan with high sides, as it cuts down the free flow of air circulating around the food. Use the convection roasting rack on the broiler pan as shown on page 6. (The convection roasting rack rests on the broiler pan, not inside it.) The long side of the rack should be parallel to the oven door for best heat distribution and airflow.

Broiling and convection broiling

IMPORTANT: Preheating is not necessary when broiling.

1. Position the rack properly **before** turning on the oven. See a reliable cookbook for recommended rack positions.
2. Place food on grid on broiler pan and place in center of the oven rack. Turn the pan so that the long side is parallel to the oven door for the best heat distribution and airflow.
3. Close the door to the Broil Stop position (open about 6 inches (15.2 cm)). The door will stay open by itself. Door can remain closed during broiling, however results may differ.

IMPORTANT: Door should remain closed for convection broiling.

4. **Thermal-convection model:** Set the Oven Selector to MAXI BROIL, ECONO BROIL or CONV BROIL.

Non-thermal-convection model: Set the Oven Selector to MAXI BROIL or ECONO BROIL.

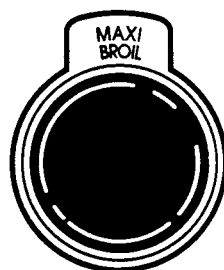

Selector

5. Set the Oven Temperature Control to 500°F or to the broiling temperature you want.

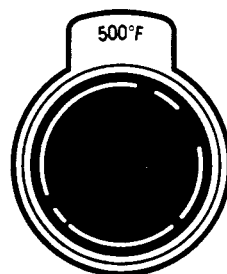

Temperature

6. Push in the Start button. The TEMP Indicator Light will come on and three hours of cooking time will show in the display. This is enough time for any broiling task. You do not have to adjust the cooking time.

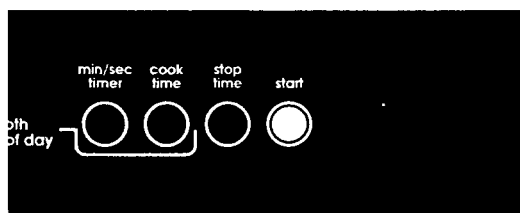

7. When broiling is done, push in the Start button to return to the time of day. Turn both the Oven Selector and the Oven Temperature Control to OFF. The TEMP Indicator Light will go out.

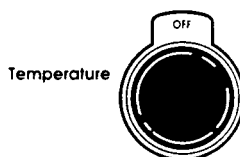

Temperature



Selector

Variable temperature broiling

- If food is cooking too fast, turn the Oven Temperature Control **counterclockwise** until the TEMP Indicator Light goes out.
- If you want food to broil slower from the start, set the Oven Temperature Control between 170°F and 325°F (77°C and 163°C). These temperature settings allow the broil heating element to cycle and to slow cooking. The lower the temperature, the slower the cooking.
- Fish and chicken are some foods that may cook better if you use lower broiling temperatures.

IMPORTANT: The door must be partly open whenever the oven is set to broil. Leaving the door open allows the oven to maintain proper temperatures. The door should remain closed for convection broiling.

Broiling tips:

- Always start broiling with a cold broiler pan for even results.
- To retain more natural juice, do not pierce meat with a fork.
- Trim the outer layer of fat from steaks and chops.
- Slit fatty edges to prevent meat from curling during broiling.
- Brush food with butter, sauce or seasoning, if desired, several times during broiling.
- Use a nonstick cooking spray or vegetable oil on the broiler pan and grid when broiling fish to prevent sticking.

⚠ WARNING

Fire Hazard

- Place meat the correct distance from the element. Meat placed too close to the element may spatter, smoke, burn or catch fire during broiling.
- To ensure adequate grease drainage, do not use cookie sheets or similar pans for broiling. Also, covering the broiler grid with foil is not recommended. Poor drainage of grease may result in fire. If foil is used, cut slits in foil to correspond with all openings in broiler grid. Grease can then drain away and cool in pan.

Using the electronic clock/oven control

The electronic clock/oven control is designed to turn the oven on and off at times you set, even when you are not around.

Automatic baking/roasting is ideal for foods which do not require a preheated oven, such as meats and casseroles. Do not use the automatic cycle for cakes, cookies, etc. ... undercooking will result.

To start baking/roasting now and stop automatically:

1. Position the oven rack(s) properly and place the food in the oven.
2. **Make sure the clock is set to the correct time of day.** (See "Setting the electronic clock" on page 9.)
3. Set the Oven Selector to BAKE, CONV BAKE or CONV ROAST.

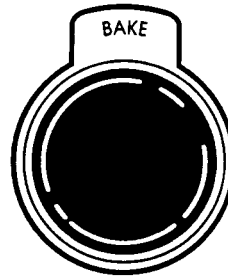

Selector

4. Set the Oven Temperature Control to the baking/roasting temperature you want.

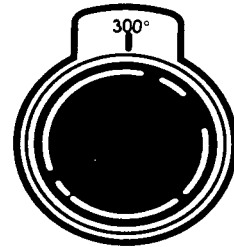

Temperature

5. **Set the clock for the length of baking/roasting time you want.** Push in the Cook Time button. Turn the Set Knob until the length of baking/roasting time you want shows in the display. This example shows 2 hours, 15 minutes. Cook Time can be set for up to 11 hours, 59 minutes. The oven will start immediately.

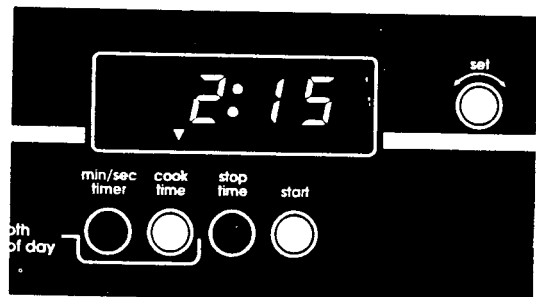

6. The COOK TIME Indicator Light will stay on and the STOP TIME Indicator Light will flash. The Auto Oven Symbol (in upper left corner of display) and TEMP Indicator Light will come on. **The display will count down in minutes. If you want to see Stop Time, push the Stop Time button.** Push the Cook Time button to see baking/roasting time again.

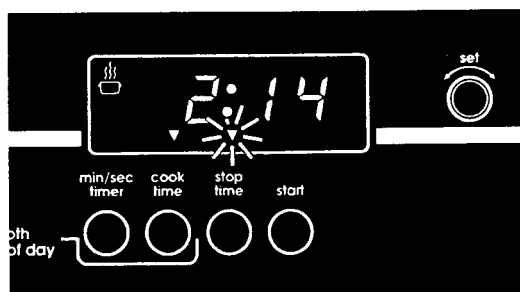

7. **When baking/roasting time is complete,** the oven will beep for 1-2 minutes. The oven will shut off automatically. Push the Cook Time button to stop the beeping. Turn the Oven Selector and Oven Temperature Control to OFF.

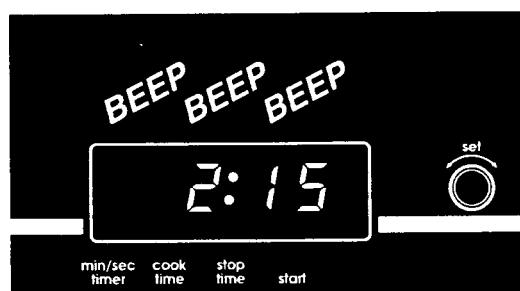

8. **To stop the timer before the programmed time,** push in the Cook Time button and turn the Set Knob counterclockwise until the display shows "0:00". The display will return to the time of day. Turn the Oven Selector and Oven Temperature Control to OFF.

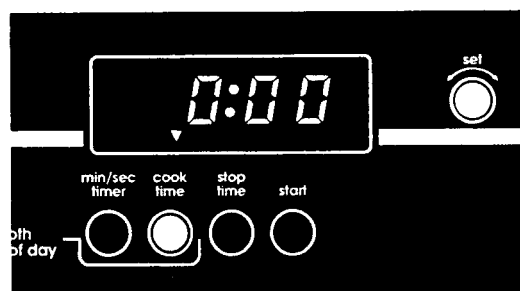

To delay start and stop automatically:

1. Position the oven rack(s) properly and place food in the oven.
2. **Make sure the clock is set to the correct time of day.** (See "Setting the electronic clock" on page 9.)
3. Set the Oven Selector to BAKE, CONV BAKE or CONV ROAST.
4. Set the Oven Temperature Control to the baking/roasting temperature you want.
5. **Set the clock for the time of day you want the food to be done (Stop Time):** Push in the Stop Time button, then turn the Set Knob until the time of day you want the food to be done shows on the display. This example shows 6 o'clock.

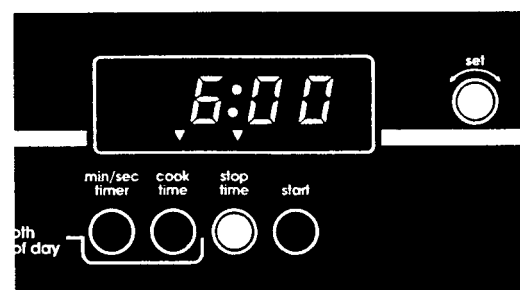

6. The display will show the time you want set. The STOP TIME Indicator Light will stay on. The COOK TIME Indicator Light will flash.

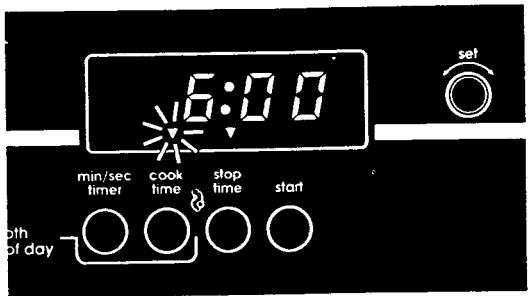

7. Set the clock for the length of baking/roasting time you want: Push in the Cook Time button, then turn the Set Knob until the length of baking/roasting time you want shows in the display. This example shows 2 hours, 15 minutes. Cook Time can be set for up to 11 hours, 59 minutes.

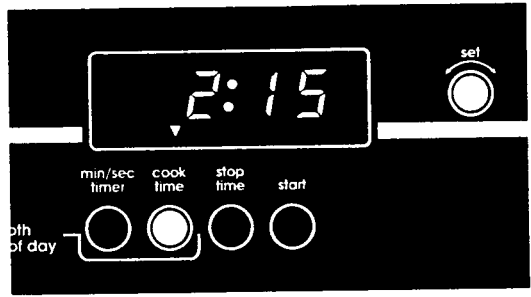

8. The COOK TIME Indicator Light will stay on and the STOP TIME Indicator Light will flash. If you want to see the Stop Time, push the Stop Time button. Push the Cook Time button to see baking/roasting time again.

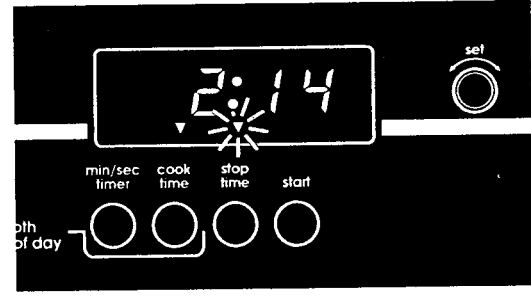

9. The clock automatically calculates the time to turn the oven on. At that time, the Auto Oven Symbol (in upper left corner of display) and the TEMP Indicator Light will come on and the oven will heat. This example shows the oven on at 45 minutes past 3 o'clock.

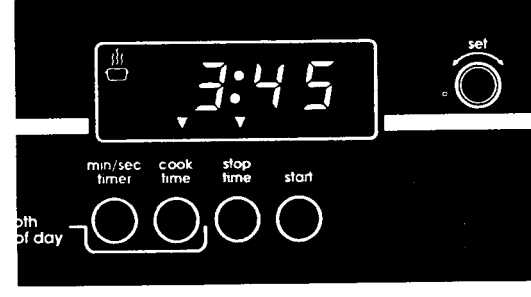

10. When baking/roasting is complete, the oven will shut off and beep for 1-2 minutes. To stop the beeping, push the Cook Time button. Turn the Oven Selector and Oven Temperature Control to OFF.

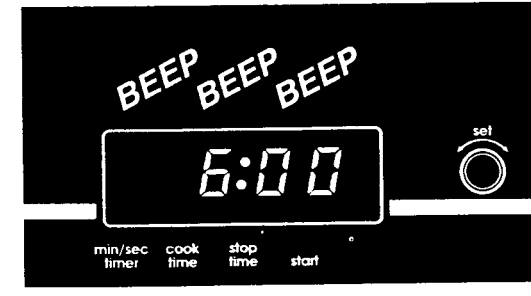

11. **To stop the oven before the preset time:**
 Push in the Cook Time button and turn the Set Knob counterclockwise until the display shows "0:00". Turn the Oven Selector and Oven Temperature Control to OFF.

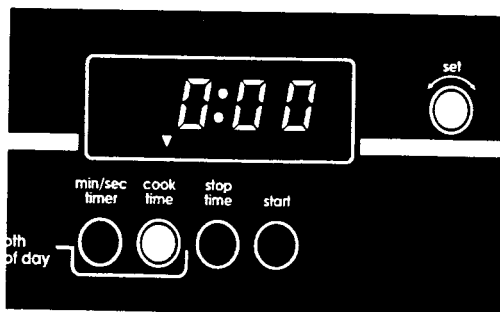

⚠ WARNING

To avoid sickness and food waste when automatic baking/roasting:

- Do not let most UNFROZEN food stand for more than two hours before cooking starts.
- Do not allow food to remain in oven for more than two hours after the end of cooking cycle.

IMPORTANT: Do not use foods that will spoil while waiting for cooking to start. Such foods are: dishes with milk or eggs, cream soups and cooked meats or fish. Also, foods containing baking powder or yeast will not rise properly when cooked using delay start.

Other operating hints

- If you want to check what you have programmed, press the button for the function you want to check. The display will show what you have programmed for that function.
- If you want to check the time of day, press the Min/Sec Timer and Cook Time buttons. The display will show the time of day.
- A rapidly flashing Indicator Light indicates an error in programming. Cancel any entries and begin again.

Using The Self-Cleaning Cycle

In This Section

	Page		Page
How the cycle works	25	Setting the controls	26
Before you start	25	Special tips	28

The Self-Cleaning cycle saves you from the toil and mess that often come with hand-cleaning the oven interior. Like the other functions of your oven, the Self-Cleaning cycle is operated with the easy-to-use controls. Please review the instructions in this section to keep your oven spotless.

How the cycle works

The Self-Cleaning cycle uses very high heat to burn away soil and grease. During the cycle, the oven gets much hotter than it does for normal baking or broiling—approximately 875°F (468°C). This high heat breaks up the soil or grease and burns it away.

Your oven is preset for a 3-hour Self-Cleaning cycle. However, the cycle time can be adjusted to the amount of soil in your oven. The cycle can be set anywhere between 2 and 4 hours. (See “Setting the controls” on page 26.)

The graph at the right is representative of a normal, 3-hour Self-Cleaning cycle. Note that the heating stops when the 3-hour setting is up, but it takes longer for the oven to cool enough to unlock.

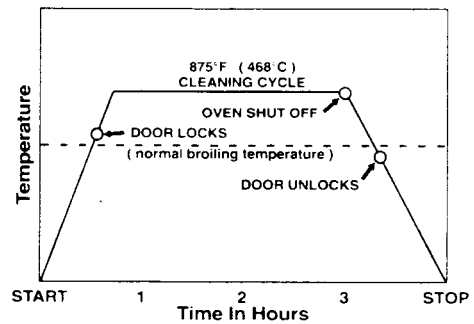

Before you start

Before you start the Self-Cleaning cycle, make sure you:

1. Hand-clean the indicated areas. They do not get hot enough during the cleaning cycle for soil to burn away. Use hot water and detergent or a soapy, steel-wool pad for cleaning.
IMPORTANT: DO NOT clean, move or bend the gasket. Poor cleaning, baking and roasting may result.
2. Remove the racks, broiler pan grid and any pots and pans being stored in the oven.

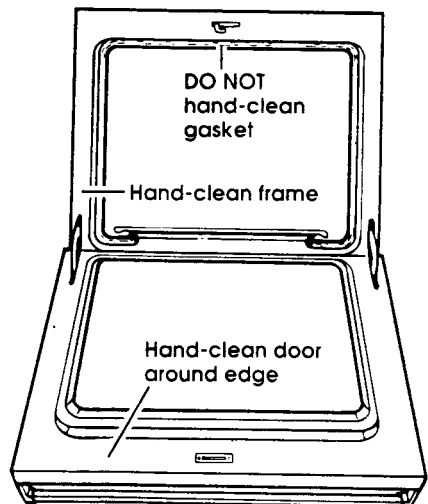

- Wipe out any loose soil or grease. This will help reduce smoke during the cleaning cycle.
- Remove the oven racks from the oven if you want them to remain shiny. If the oven racks are cleaned in the Self-Cleaning cycle, place them on the 2nd and 4th rack guides. (Guides are counted from bottom to top.)

IMPORTANT: If oven racks are cleaned in the Self-Cleaning cycle, they will discolor and become harder to slide.

Heat and odors are normal during the Self-Cleaning cycle. If needed, remove them by opening a window or by turning on a vent hood or other kitchen vent during the cycle.

IMPORTANT: Do not block the vent during the Self-Cleaning cycle. Air must move freely for best results.

⚠ WARNING

Personal Injury and Product Damage Hazard

- Do not touch the oven during the Self-Cleaning cycle. It could burn you.
- Do not use commercial oven cleaners in your oven. Cleaners may produce hazardous fumes or damage the porcelain finish.
- Do not leave foil in oven during the Self-Cleaning cycle. Foil can burn or melt and damage the oven surface.

Setting the controls

- Make sure the clock is set to the correct time of day.** (See "Setting the electronic clock" on page 9.)
- Set the Oven Selector and Oven Temperature Control to CLEAN.

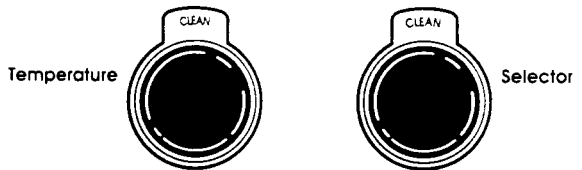

- Push in and release the Start button. A 3-hour Self-Cleaning cycle will be set automatically. The display will count down the time in minutes. The TEMP Indicator Light will come on. The Auto Oven Symbol (in upper left corner of display) and the CLEAN Indicator Light on the display will also come on. The display will count down in minutes.

If a Self-Cleaning cycle other than 3 hours is desired, push in the Start button and turn the Set Knob to the new time up to 4 hours.

- Use 2 hours for light soil.
- Use 3 hours for moderate soil.
- Use 3-4 hours for heavy soil.

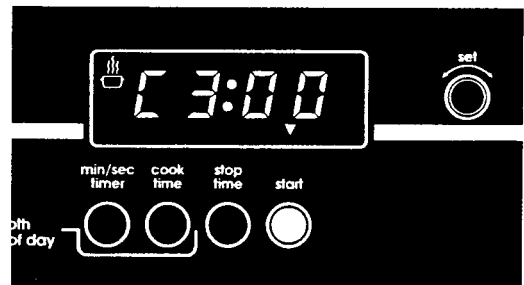

IMPORTANT: The STOP TIME Indicator Light will flash during the entire Self-Cleaning cycle.

- The LOCK Indicator Light will come on when the oven temperature exceeds normal baking/roasting temperatures. The door cannot be opened when the light is on. If you want to see the Stop Time of the Self-Cleaning cycle, push the Stop Time button. Push the Start button to see cleaning time again.

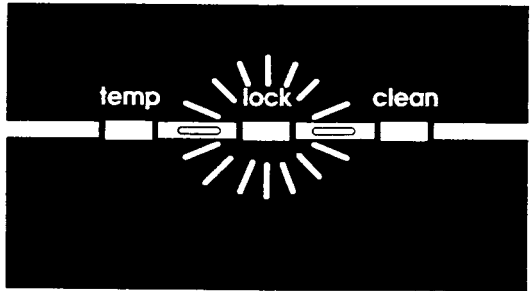

- After the Self-Cleaning cycle is completed, the TEMP Indicator Light will go off. The Auto Oven Symbol and CLEAN Indicator Light on the display will also go out. The display will show the time of day. When the oven reaches normal baking/roasting temperatures, the LOCK Indicator Light goes out and you can open the door.

- Turn **both** the Oven Selector and the Oven Temperature Control to OFF. The TEMP Indicator Light will go out.

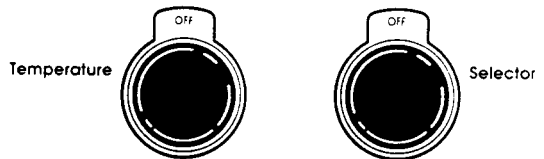

To stop the Self-Cleaning cycle at any time:

- Push in and release the Start button to return to the time of day.

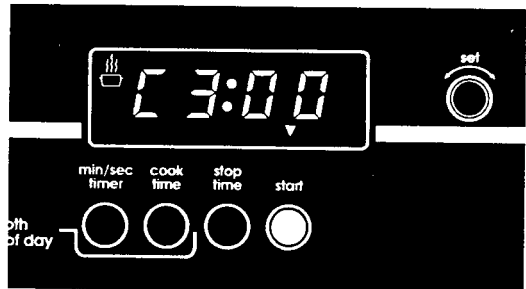

- Turn the Oven Selector and Oven Temperature Control to OFF. When the LOCK Indicator Light goes off, you can open the door.

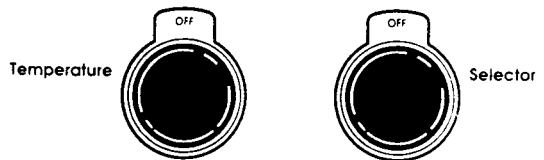

Special tips

- Keep the kitchen well ventilated during the Self-Cleaning cycle to help get rid of heat, odors and smoke.
- After the oven is cool, wipe up any residue or ash with a damp cloth.
- Clean the oven before it gets heavily soiled. Cleaning a very soiled oven takes longer and results in more smoke than usual.
- If the Self-Cleaning cycle does not get the oven as clean as you expected, the cycle may not have been set long enough or you may not have prepared the oven properly. Set the Self-Cleaning cycle longer the next time and hand-clean areas noted on page 25.

Caring For Your Oven

In This Section		Page	Page
Cleaning chart		29	Removing and replacing the rack guides...31
The oven lights		30	Removing and replacing the oven door32

Your oven is designed for ease of care. Most cleaning can be done with items found around your home. Cleaning your oven whenever spills or soiling occurs will help to keep it looking and operating like new.

⚠ WARNING

Burn and Electrical Shock Hazard

Make sure all controls are OFF and the oven is cool before cleaning. Failure to do so can result in burns or electrical shock.

Cleaning chart

Use the following table to help you clean all parts of your oven.

PART	WHAT TO USE	HOW TO CLEAN
Control panel	Sponge and warm, soapy water OR Paper towel and spray glass cleaner	<ul style="list-style-type: none"> Wash, rinse and dry thoroughly. DO NOT USE steel wool or abrasive cleaners. They may damage the finish.
Exterior surfaces (other than control panel)	Sponge and warm, soapy water	<ul style="list-style-type: none"> Wash, rinse and dry thoroughly. USE nonabrasive, plastic scrubbing pad on heavily soiled areas. Do not use abrasive or harsh cleansers.
Broiler pan and grid (clean after each use)	Steel-wool pad and warm, soapy water	<ul style="list-style-type: none"> Wash, rinse and dry thoroughly. DO NOT CLEAN grid in Self-Cleaning cycle.
Oven racks and rack guides	Steel-wool pad and warm, soapy water OR The Self-Cleaning cycle	<ul style="list-style-type: none"> Wash, rinse and dry thoroughly. OR Leave in oven during Self-Cleaning cycle. IMPORTANT: Racks will permanently discolor and become harder to slide if left in oven during Self-Cleaning cycle. Apply a small amount of vegetable oil to the side rungs to aid sliding.
Oven door glass	Paper towel and spray glass cleaner OR Warm, soapy water and a nonabrasive, plastic scrubbing pad	<ul style="list-style-type: none"> Make sure oven is cool. Follow directions provided with the cleaner. Wash, rinse and dry thoroughly.
Oven cavity	Self-Cleaning cycle	<ul style="list-style-type: none"> See "Using The Self-Cleaning Cycle" on pages 25-28.

The oven lights

If the oven is off, the oven lights come on when the oven door is opened. To turn on lights when door is closed, turn the Oven Selector to LIGHT and push in the Start button. The lights and fan will come on. The lights are also on during all cooking functions, but not during the Self-Cleaning cycle. During delay functions, the lights will come on when the oven turns on. Turn the Oven Selector to OFF to turn off the lights.

⚠ WARNING

Electrical Shock and Personal Injury Hazard

- Make sure oven and light bulb(s) are cool and power to the oven has been turned off before replacing the light bulb(s). Failure to do so could result in electrical shock or burns.
- The light cover(s) must be in place when using the oven. The cover(s) protects the bulb(s) from breaking, and from high oven temperatures. Because light cover(s) is made of glass, be careful not to drop it. Broken glass could cause injury.

To replace an oven light:

1. Turn off power at the main power supply.
2. Remove the glass frame by unscrewing the two screws.
3. Remove the glass light cover.
4. Remove the light bulb from its socket. Replace the bulb with a new appliance bulb taking care to screw it completely.
5. Replace the light cover glass by snapping it in place; fix the glass frame by the two screws. Turn power back on at the main power supply and set the electronic clock.

Note: It may happen that the light remains off due to an imperfect contact caused by the high temperature dilatation occurring during self-cleaning cycles. In such case it is necessary only to screw completely the bulb.

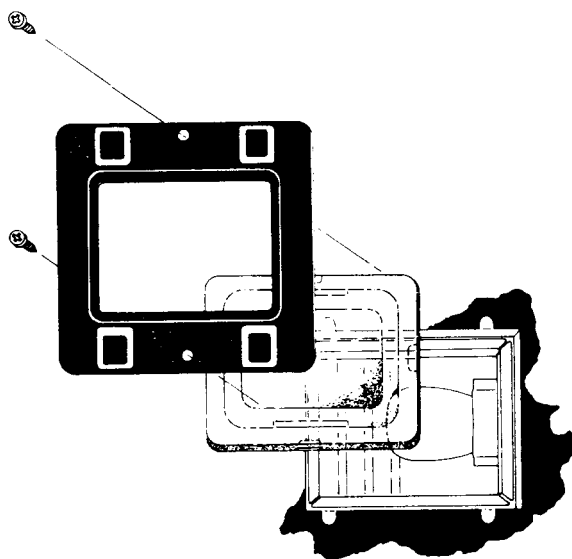

Removing and replacing the rack guides

The rack guides can be cleaned in the Self-Cleaning cycle. However, if you wish to clean them by hand, you can remove the rack guides.

To remove:

1. Grasp both sides of rack guide unit and pull up.
2. Pull rack guides away from oven wall.

To replace:

1. The top and bottom rack guides stick out and curve down on each side. Insert the curved parts down into the four holes in the oven wall.
2. Push rack guide unit down so it fits securely in holes.

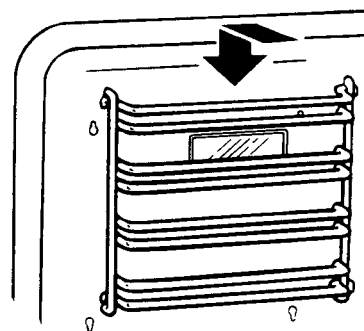
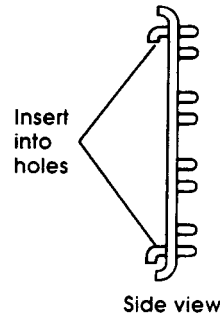
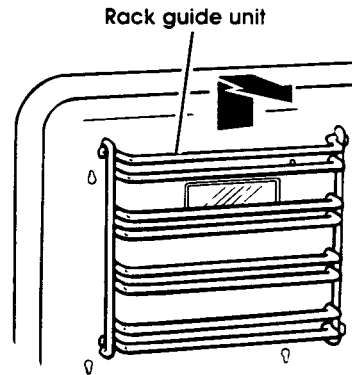

Removing and replacing the oven door

The oven door can be removed for hand-cleaning, if needed. **Only remove the door when the Self-Cleaning cycle is not operating.**

⚠ WARNING

Personal Injury Hazard

- Oven door is heavy. Use both hands to remove the oven door.
- Grasp only the sides of the oven door. Do not use any portion of the front frame or trim for lifting.

Failure to grasp the oven door properly could result in personal injury or product damage.

To remove:

1. Open the door completely.
2. Push up both hinge brackets.
3. Hold the door firmly on both sides. Pull the door straight out of the hinge slots to remove. Move door to a convenient location for cleaning.

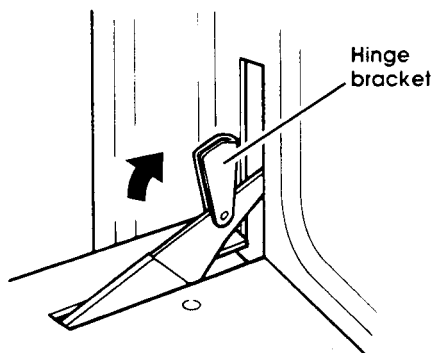

To replace:

1. Grasp door firmly on both sides. Slide the hinge slot in the bottom of the door over the hinges. Push the door into place.
2. Push both hinge brackets down to secure door to hinges.
3. Close and open the door slowly to make sure it is replaced properly.

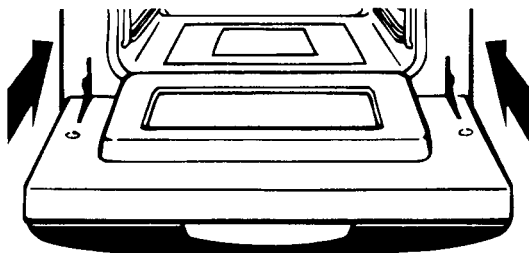

If You Need Assistance Or Service

If you ever have questions or comments about your appliance, you can call our toll-free Consumer Assistance Center telephone number, 1-800-422-1230, 24 hours a day.

This section is designed to help you save the cost of a service call. Part 1 of this section outlines possible problems, their causes, and actions you can take to solve each problem. Parts 2 and 3 tell you what to do if you still need assistance or service. When calling our Consumer Assistance Center for help or calling for service, please provide a detailed description of the problem, your appliance's complete model and serial numbers and the purchase or installation date. (See page 2.) This information will help us respond properly to your request.

1. Before calling for service ...

If your appliance should fail to operate, review the following list before calling your dealer. You could save the cost of a service call.

PROBLEM	CHECK IF	WHAT TO DO
Nothing will operate	The unit is not wired into a live circuit with proper voltage.	Wire the unit into a live circuit with proper voltage. (See Installation Instructions.)
	A household fuse has blown or a circuit breaker has tripped.	Replace household fuse or reset circuit breaker.
The oven will not operate	The Oven Selector is not turned to a cook setting.	Turn the Oven Selector to the desired setting.
	The Oven Temperature Control is not turned to a temperature setting.	Turn the Oven Temperature Control to the desired setting.
	The Start button is not pushed.	Push the Start button.
	The electronic clock/oven control is not set correctly.	Set the clock/oven control correctly. (See "Using the electronic clock/oven control" on page 21.)
The Self-Cleaning cycle will not operate	A delayed start time has been programmed.	Wait for the start time to be reached.
	The oven clock does not show the correct time of day.	Reset clock to show the correct time of day. (See page 9.)
	The Oven Selector and Temperature Control are not set to CLEAN.	Set the Oven Selector and Temperature Control to CLEAN.
	The Start button is not pushed.	Push the Start button.
	A delayed start time has been programmed.	Wait for the start time to be reached.
Fan is not running. If fan is running, you can hear it.	Call a KitchenAid service technician for repair.	

PROBLEM	CHECK IF	WHAT TO DO
Cooking results are not what you expected	The oven is not level.	Level oven. (See Installation Instructions.)
	The oven temperature seems too low or too high.	Your old oven may have shifted gradually while your new oven may be more exact. Adjust oven temperature settings as needed. Preheat oven when called for in recipe.
	The oven was not preheated before baking.	
	The recipe has never been tested or is not from a reliable source.	Use only tested recipes from a reliable source.
	The pan is not the correct type or size.	Refer to a reliable cookbook or recipe for recommended pan type and size.
	There is not proper air circulation around pan when baking.	Allow 1½ to 2 inches (4-5 cm) of air space on all sides of pan.

2. If the problem is not due to one of the items listed in Step 1:

- Call KitchenAid Consumer Assistance Center, toll-free:
1-800-422-1230
and talk with one of our trained consultants. The consultant can instruct you in how to obtain satisfactory operation from your appliance or, if service is necessary, recommend a qualified service company in your area.
- If you prefer, write to:
Consumer Assistance Center
KitchenAid
P.O. Box 558
St. Joseph, MI 49085-0558
Please include a daytime phone number in your correspondence.

3. If you need service:

- Call your dealer or the repair service he recommends.
- All service should be handled locally by the dealer from whom you purchased the unit or an authorized KitchenAid servicer.
- If you are unable to obtain the name of a local authorized KitchenAid servicer, call our Consumer Assistance Center telephone number (see Step 2).

4. If you are not satisfied with the action taken:

- Contact the Major Appliance Consumer Action Panel (MACAP). MACAP is a group of independent consumer experts that voices consumer views at the highest levels of the major appliance industry.
- Contact MACAP only when the dealer, authorized servicer and KitchenAid have failed to resolve your problem.
Major Appliance Consumer Action Panel
20 North Wacker Drive
Chicago, IL 60606
- MACAP will in turn inform us of your action.

KitchenAid

Electric Built-In Oven Warranty

LENGTH OF WARRANTY:	KITCHENAID WILL PAY FOR:	KITCHENAID WILL NOT PAY FOR:
ONE YEAR FULL WARRANTY FROM DATE OF INSTALLATION.	Replacement parts and repair labor costs to correct defects in materials or workmanship. Service must be provided by an authorized KitchenAid servicing outlet.	A. Service calls to: <ol style="list-style-type: none"> 1. Correct the installation of the oven. 2. Instruct you how to use the oven. 3. Replace house fuses or correct house wiring. B. Repairs when oven is used in other than normal home use.
SECOND THROUGH FIFTH YEAR LIMITED WARRANTY FROM DATE OF INSTALLATION.	Replacement parts for any electric element to correct defects in materials or workmanship.	C. Damage resulting from accident, alteration, misuse, abuse, improper installation or installation not in accordance with local electrical codes.
SECOND THROUGH TENTH YEAR LIMITED WARRANTY FROM DATE OF INSTALLATION.	Replacement parts for the porcelain oven cavity/inner door if the part rusts through due to defects in materials or workmanship.	D. Any labor costs during the limited warranties. E. Replace parts or repair labor costs for units operated outside the United States. F. Pickup and delivery. This product is designed to be repaired in the home. G. Repairs to parts or systems caused by unauthorized modifications made to the appliance.

KITCHENAID DOES NOT ASSUME ANY RESPONSIBILITY FOR INCIDENTAL OR CONSEQUENTIAL DAMAGES. Some states do not allow the exclusion or limitation of incidental or consequential damages, so this exclusion may not apply to you.

This warranty gives you specific legal rights and you may also have other rights which may vary from state to state.

If you need service, first see the "Assistance or Service" section of this book. After checking "Assistance or Service," additional help can be found by calling our Consumer Assistance Center telephone number, **1-800-422-1230**, from anywhere in the U.S.

KitchenAid
St. Joseph, Michigan, U.S.A. 49085

Free Manuals Download Website

<http://myh66.com>

<http://usermanuals.us>

<http://www.somanuals.com>

<http://www.4manuals.cc>

<http://www.manual-lib.com>

<http://www.404manual.com>

<http://www.luxmanual.com>

<http://aubethermostatmanual.com>

Golf course search by state

<http://golfingnear.com>

Email search by domain

<http://emailbydomain.com>

Auto manuals search

<http://auto.somanuals.com>

TV manuals search

<http://tv.somanuals.com>