

KitchenAid®

SUPERBA® BUILT-IN ELECTRIC CONVECTION SINGLE AND DOUBLE OVENS

Use & Care Guide

For questions about features, operation/performance, parts, accessories or service, call: **1-800-422-1230**
or visit our website at **www.kitchenaid.com**

In Canada, call for assistance, installation and service, call: **1-800-807-6777**
or visit our website at **www.KitchenAid.ca**

FOURS ÉLECTRIQUES À CONVECTION SIMPLES ET DOUBLES, ENCASTRÉS SUPERBA®

Guide d'utilisation et d'entretien

Au Canada, pour assistance, installation ou service composez le **1-800-807-6777** ou visitez notre site web à...
www.KitchenAid.ca

Table of Contents/Table des matières..... 2



Models/Modèles KEBS107 KEBS177 KEBS207 KEBS277 KEBS208 KEBS278

W10162180A

TABLE OF CONTENTS

OVEN SAFETY	3
PARTS AND FEATURES	4
ELECTRONIC OVEN CONTROL	5
Display	6
Start	6
Lower Oven Off, Upper Oven Off and Off	6
Clock	6
Tones	6
Fahrenheit and Celsius	6
Options	6
Timer	7
Control Lock	7
Oven Temperature Control	7
Sabbath Mode	7
OVEN USE	8
Aluminum Foil	8
Positioning Racks and Bakeware	8
Roll-Out Rack	9
Bakeware	10
Meat Thermometer	10
Oven Vent(s)	10
Baking and Roasting	10
Full and Center Broiling	11
Convection Cooking	12
Convection Bake	12
Convection Roast	12
Convection Broil	14
EasyConvect™ Conversion	14
Proofing Bread	15
Temperature Probe	15
Timed Cooking	16
Dehydrating	16
OVEN CARE	17
Self-Cleaning Cycle	17
General Cleaning	18
Oven Lights	19
Oven Door	19
TROUBLESHOOTING	20
ASSISTANCE OR SERVICE	21
In the U.S.A.	21
Accessories	21
In Canada	21
WARRANTY	21

TABLE DES MATIÈRES

SÉCURITÉ DU FOUR	23
PIÈCES ET CARACTÉRISTIQUES	24
COMMANDE ÉLECTRONIQUE DU FOUR	25
Afficheur	25
Mise en marche	26
Arrêt du four inférieur, arrêt du four supérieur et arrêt	26
Horloge	26
Signaux sonores	26
Fahrenheit et Celsius	26
Options	26
Minuterie	27
Verrouillage des commandes	27
Commande de la température du four	27
Mode Sabbath	27
UTILISATION DU FOUR	29
Papier d'aluminium	29
Positionnement des grilles et des ustensiles de cuisson	29
Grille coulissante	30
Ustensiles de cuisson	31
Thermomètre à viande	31
Évent(s) du four	31
Cuisson au four et rôtissage	32
Cuisson au gril complet et central	32
Cuisson par convection	33
Cuisson au four par convection	34
Rôtissage par convection	34
Cuisson au gril par convection	35
Conversion de la température de convection EasyConvect™	36
Levée du pain	36
Sonde thermométrique (four simple et supérieur et, sur certains modèles, four inférieur)	37
Cuisson minutée	37
Déshydratation	38
ENTRETIEN DU FOUR	39
Programme d'autonettoyage	39
Nettoyage général	40
Lampes du four	41
Porte du four	41
DÉPANNAGE	42
ASSISTANCE OU SERVICE	43
GARANTIE	43

OVEN SAFETY

Your safety and the safety of others are very important.

We have provided many important safety messages in this manual and on your appliance. Always read and obey all safety messages.



This is the safety alert symbol.

This symbol alerts you to potential hazards that can kill or hurt you and others.

All safety messages will follow the safety alert symbol and either the word "DANGER" or "WARNING." These words mean:

⚠ DANGER

You can be killed or seriously injured if you don't immediately follow instructions.

⚠ WARNING

You can be killed or seriously injured if you don't follow instructions.

All safety messages will tell you what the potential hazard is, tell you how to reduce the chance of injury, and tell you what can happen if the instructions are not followed.

IMPORTANT SAFETY INSTRUCTIONS

WARNING: To reduce the risk of fire, electrical shock, injury to persons, or damage when using the oven, follow basic precautions, including the following:

- Proper Installation – Be sure the oven is properly installed and grounded by a qualified technician.
- Never Use the Oven for Warming or Heating the Room.
- Do Not Leave Children Alone – Children should not be left alone or unattended in area where oven is in use. They should never be allowed to sit or stand on any part of the oven.
- Wear Proper Apparel – Loose-fitting or hanging garments should never be worn while using the oven.
- User Servicing – Do not repair or replace any part of the oven unless specifically recommended in the manual. All other servicing should be referred to a qualified technician.
- Storage in Oven – Flammable materials should not be stored in an oven.
- Do Not Use Water on Grease Fires – Smother fire or flame or use dry chemical or foam-type extinguisher.
- Use Only Dry Potholders – Moist or damp potholders on hot surfaces may result in burns from steam. Do not let potholder touch hot heating elements. Do not use a towel or other bulky cloth.
- Use Care When Opening Door – Let hot air or steam escape before removing or replacing food.
- Do Not Heat Unopened Food Containers – Build-up of pressure may cause container to burst and result in injury.

- Keep Oven Vent Ducts Unobstructed.
- Placement of Oven Racks – Always place oven racks in desired location while oven is cool. If rack must be moved while oven is hot, do not let potholder contact hot heating element in oven.
- DO NOT TOUCH HEATING ELEMENTS OR INTERIOR SURFACES OF OVEN – Heating elements may be hot even though they are dark in color. Interior surfaces of an oven become hot enough to cause burns. During and after use, do not touch, or let clothing or other flammable materials contact heating elements or interior surfaces of oven until they have had sufficient time to cool. Other surfaces of the oven may become hot enough to cause burns – among these surfaces are oven vent openings and surfaces near these openings, oven doors, and windows of oven doors.

For self-cleaning ovens:

- Do Not Clean Door Gasket – The door gasket is essential for a good seal. Care should be taken not to rub, damage, or move the gasket.
- Do Not Use Oven Cleaners – No commercial oven cleaner or oven liner protective coating of any kind should be used in or around any part of the oven.
- Clean Only Parts Listed in Manual.
- Before Self-Cleaning the Oven – Remove broiler pan and other utensils.

SAVE THESE INSTRUCTIONS

The California Safe Drinking Water and Toxic Enforcement Act requires the Governor of California to publish a list of substances known to the State of California to cause cancer, birth defects, or other reproductive harm, and requires businesses to warn of potential exposure to such substances.

WARNING: This product contains a chemical known to the State of California to cause cancer, birth defects, or other reproductive harm.

This appliance can cause low-level exposure to some of the substances listed, including benzene, formaldehyde, carbon monoxide, and toluene.

PARTS AND FEATURES

This manual covers different models. The oven you have purchased may have some or all of the items listed. The locations and appearances of the features shown here may not match those of your model.

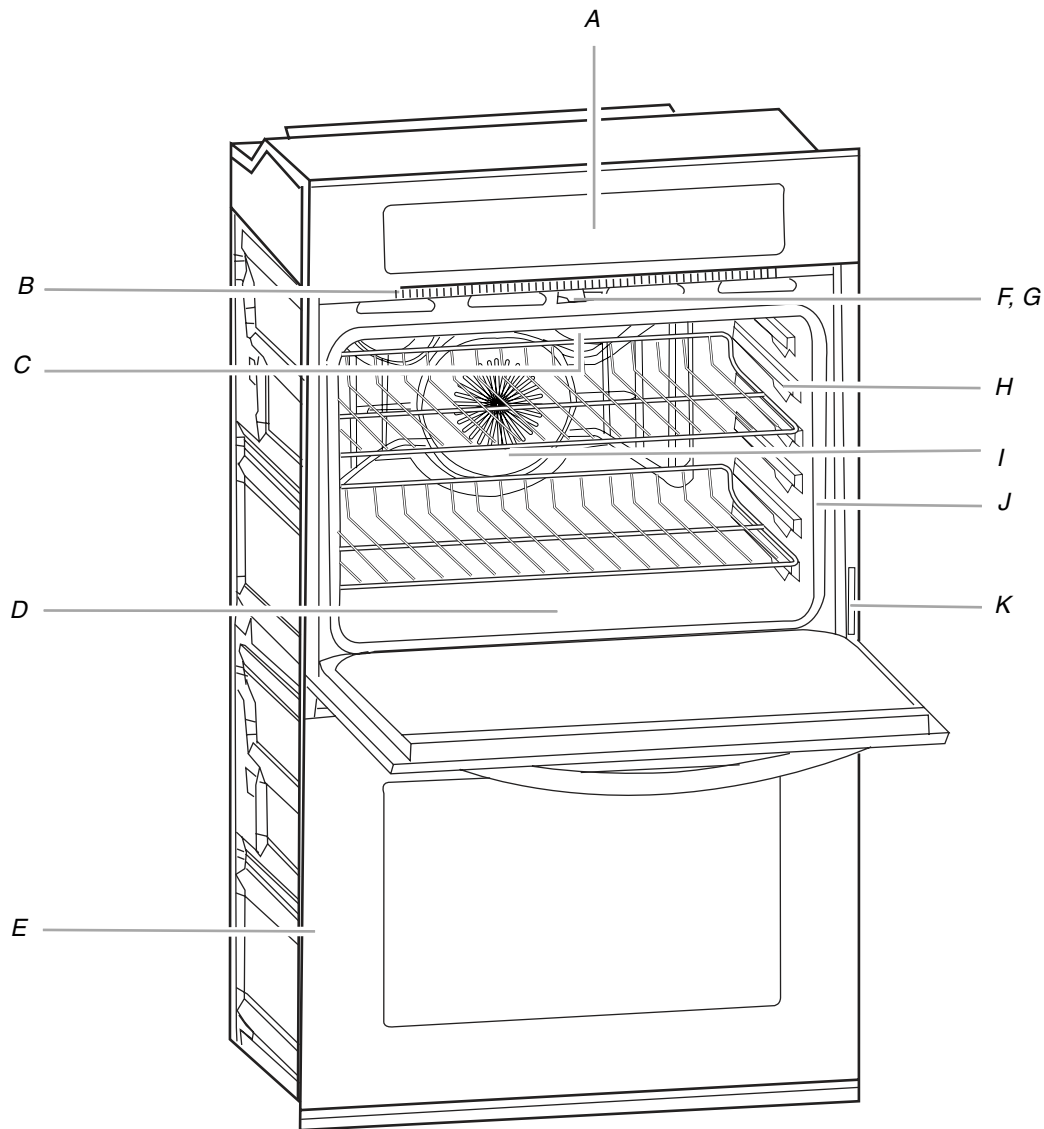

- A. Electronic oven control
- B. Oven vent
- C. Broil elements (not shown)
- D. CleanBake™ bake element (hidden beneath floor panel)
- E. Lower oven (on double oven models)
- F. Automatic oven light switch

- G. Oven door lock latch
- H. Temperature probe jack (cavity with convection element and fan only)
- I. T.H.E.™ (Third Hidden Element) convection element and fan (in back panel)
- J. Gasket
- K. Model and serial number plate (on right mounting rail)

Parts and Features not shown

- Oven lights
- Third oven rack (roll out rack)
- Roasting rack
- Temperature probe

ELECTRONIC OVEN CONTROL

This manual covers different models. The oven you have purchased may have some or all of the items listed. The locations and appearances of the items shown here may not match those of your model.

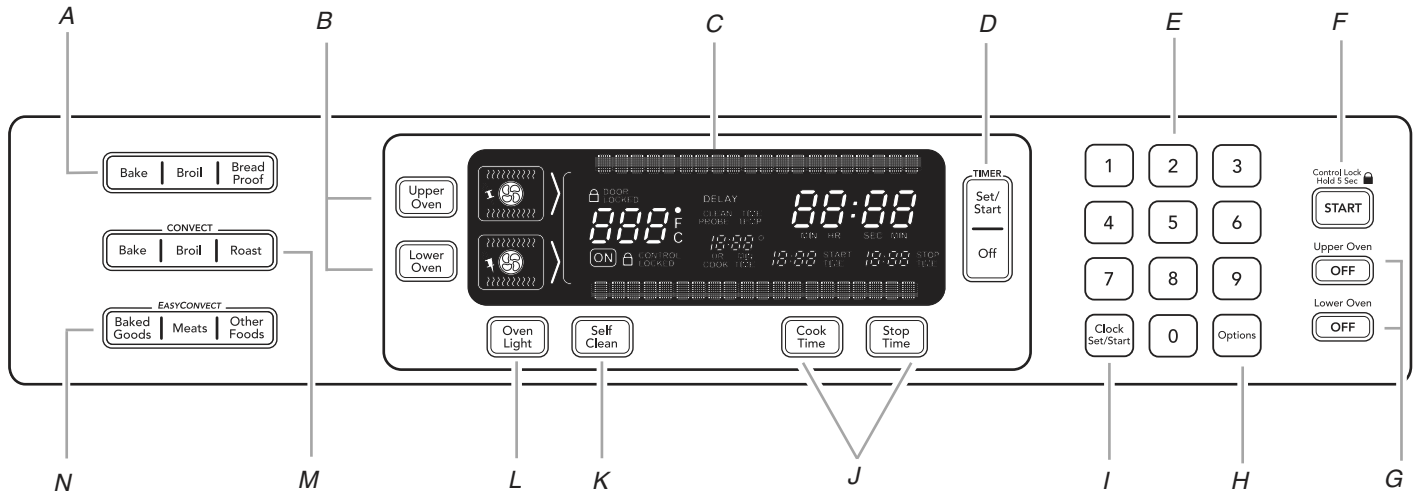

A. Oven settings

B. Upper or lower oven selectors (double oven models only)

C. Oven display

D. Timer

E. Number keys

F. Start/control lock

G. Upper and lower oven Off (double oven models)
Off (single oven models)

H. Options

I. Clock set/start

J. Timed cooking

K. Self-clean

L. Oven light

M. Convection cooking settings

N. EasyConvect™ conversion

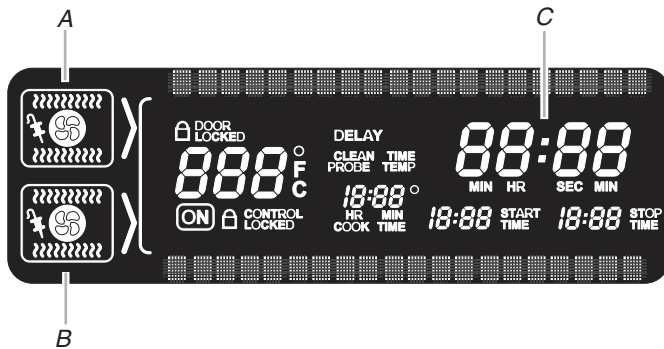

Double Oven Display

A. Upper oven cavity symbol

B. Lower oven cavity symbol

C. Time of day, timer display

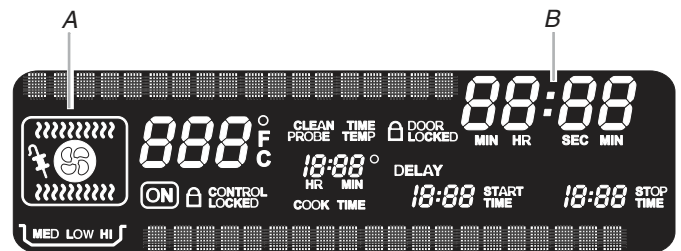

Single Oven Display

A. Oven cavity symbol

B. Time of day, timer display

Display

When power is first supplied to the oven, the clock will be flashing the message "clock-enter time." Time can be entered by touching either CLOCK SET/START or START to allow operation. To allow operation without setting a time, touch CLOCK SET/START, START or OFF.

Oven Display

When the oven(s) are in use, this display shows the oven temperature, heat source(s) and start time. On double oven models, this display will also show which oven is being set. The upper cavity symbol represents the upper oven; the lower cavity symbol represents the lower oven.

In addition, during Timed Cooking, this display shows a time countdown and the stop time (if entered).

If "Err" appears on the oven display, an error condition has occurred. Call for service, see the "Assistance or Service" section.

Time of Day, Timer Display

When the oven(s) are not in use this display shows the time of day or Timer countdown.

Start

The START key begins all oven functions except Sabbath Mode. If the Start key is not touched within 5 seconds after touching another key, "START?" will appear on the oven display as a reminder. If the Start key is not touched within 5 minutes after touching another key, the oven display will return to inactive mode and the programmed function will be canceled.

Lower Oven Off, Upper Oven Off and Off

The LOWER OVEN OFF, UPPER OVEN OFF and OFF keys stop their respective oven functions except for the Clock, Timer, and Control Lock. The oven cooling fan may continue to operate even after an oven function has been canceled or completed, depending on the oven temperature.

Clock

This is a 12-hour clock. Before setting, make sure the oven(s), Timer and Timed Cooking are off.

To Set:

1. Touch CLOCK SET/START.
 2. Touch the number keys to set the time of day.
 3. Touch CLOCK SET/START again.
-

Tones

Tones are audible signals, indicating the following:

One beep

- Valid key touch
- Oven is preheated
- Function has been entered

One chime

- Preheat cycle has been completed

Three beeps

- Invalid key touch
- End of a cooking cycle

Three chimes

- When timer reaches zero
Includes using the Timer for functions other than cooking.
-

Tone Volume

The volume is preset at high, but can be changed to low.

To Change: Touch OPTIONS and then "3" to toggle volume between high and low settings.

All Tones

All tones are preset on, but can be turned off.

To Turn Off/On: Touch OPTIONS and then "2" to toggle tones between on/off settings.

End-of-Cycle and Reminder Tones

The Timed Cooking end-of-cycle and reminder tones are preset on, but can be turned off. If all tones have been turned off, the end-of-cycle and reminder tones cannot be independently turned on.

To Turn Tones Off/On: Touch OPTIONS and then "4" to turn On. Touch OPTIONS and then "4" to turn Off.

Fahrenheit and Celsius

The temperature is preset in Fahrenheit, however it can be changed to Celsius.

To Change: Touch OPTIONS and then "1" to toggle temperature between Fahrenheit and Celsius settings.

When in Fahrenheit, "°F" follows the oven temperature.

When in Celsius, "°C" follows the oven temperature.

Options

The OPTIONS selection key allows you access to 7 hidden functions within the Electronic Oven Control. These hidden functions allow you to change the oven temperature between Fahrenheit and Celsius, turn the audible signals and prompts on and off and adjust the oven calibration. The Sabbath Mode is also set using the OPTIONS selection key.

To Use: Touch OPTIONS. The oven display will scroll through the various options, starting at 1 and ending automatically at 7. You can also touch the Options key repeatedly to manually scroll through the list of options.

OPTIONS	HIDDEN FUNCTION
1	Fahrenheit and Celsius conversion
2	Sound On/Off
3	Sound High/Low
4	End beep On/Off
5*	Dehydrate
6	Oven temperature calibration
7**	Sabbath Mode

*On convection models

**Sabbath Mode must be enabled

Timer

The Timer can be set in minutes and seconds or hours and minutes and counts down the set time.

NOTE: The Timer does not start or stop the oven.

To Set:

1. Touch **TIMER SET/START**.
Touch again to switch between MIN/SEC and HR/MIN.
If no action is taken, the control will continue to wait for a length of time to be entered.
2. Touch the number keys to set the length of time.
3. Touch **TIMER SET/START**.
If the key is not touched, the control will continue to wait for Timer Set/Start to be touched.
When the set time ends, if enabled, end-of-cycle tones will continuously repeat until the "Timer Off" key is touched.
4. Touch **TIMER OFF** anytime to cancel the Timer or stop the reminder tones.
If **UPPER OVEN OFF** or **LOWER OVEN OFF** key is touched, the respective oven will turn off; however, the timer can be turned off only by using the "Timer Off" key.

Control Lock

The Control Lock shuts down the control panel keys to avoid unintended use of the oven(s). The Control Lock will remain set after a power failure, if set before the power failure occurs.

When the control is locked, only the **TIMER SET/START**, **TIMER OFF** and **OVEN LIGHT** keys will function.

The Control Lock is preset unlocked, but can be locked.

To Lock Control: Touch and hold **START** for approximately 5 seconds, until "control locked" appears on the lower text line and a lock icon appears in the display.

To Unlock Control: Repeat to unlock and remove "control locked" and lock icon from the display.

Oven Temperature Control

IMPORTANT: Do not use a thermometer to measure oven temperature because opening the oven door during cycling may give incorrect readings.

The oven provides accurate temperatures; however, it may cook faster or slower than your previous oven, so the temperature calibration can be adjusted. It can be changed in Fahrenheit or Celsius.

A minus sign means the oven will be cooler by the displayed amount. The absence of a minus sign means the oven will be warmer by the displayed amount. Use the following chart as a guide.

ADJUSTMENT °F (AUTOMATIC °C CHANGE)	COOKS FOOD
10°F (5°C)	...a little more
20°F (10°C)	...moderately more
30°F (15°C)	...much more
0°F (0°C)	default setting
-10°F (-5°C)	...a little less
-20°F (-10°C)	...moderately less
-30°F (-15°C)	...much less

To Adjust Oven Temperature Calibration:

1. Touch **OPTIONS** and then "6" to set the calibration.
2. On double ovens only, touch **UPPER OVEN** or **LOWER OVEN** to select oven.
Each oven calibration can be independently set.
3. Touch "3" to increase and "6" to decrease the temperature.
4. Touch **START** to end calibration.

Sabbath Mode

The Sabbath Mode sets the oven(s) to remain on in a bake setting until turned off. A timed Sabbath Mode can also be set to keep the oven on for only part of the Sabbath.

When the Sabbath Mode is set, only the number and start keys will function, no tones will sound, and the displays will not show messages or temperature changes. The heat sources icons will appear lit on the oven display throughout the Sabbath Mode.

When the oven door is opened or closed, the oven light will not turn on or off and the heating elements will not turn on or off immediately.

If a power failure occurs when the Sabbath Mode is set, the oven(s) will remain in Sabbath Mode but will no longer be actively cooking. The "ON" indicator will no longer be lit. Touch **OFF** to return to normal operating mode (non-Sabbath Mode, not cooking).

To Activate:

Before the Sabbath Mode can be regularly set, the oven(s) must first be enabled with a one time only setup. On double oven models, the following steps will enable both ovens.

1. On double ovens, open the upper or lower oven door.
On single ovens, open the oven door.
2. On double ovens, touch **UPPER OVEN OFF** or **LOWER OVEN OFF**.
On single ovens, touch **OFF**.
3. Touch the number keys 7, 8, 9, 6, in this order.
4. Touch **START** to activate.
"SABBATH ENABLED" will appear on the display and remain for approximately 5 seconds. You may also touch **OFF**, **UPPER OVEN OFF** or **LOWER OVEN OFF** to clear the display.
5. Close oven door.

To Deactivate:

The oven(s) can be disabled of the ability to set the Sabbath Mode by repeating the previous steps. See the "To Activate" section. When disabled "SABBATH DISABLED" will appear on the display and remain on for approximately 5 seconds.

The Sabbath Mode cannot be regularly set until re-enabled.

On double oven models these steps will disable both ovens.

To Regularly Set, Untimed:

Sabbath Mode must be enabled before starting the Bake cycle. See the "To Activate" section.

1. On double ovens only, touch **UPPER OVEN** or **LOWER OVEN**.
Each oven can be independently set.
2. Touch **BAKE**.
Touch the number keys to enter a temperature other than 350°F (177°C). The bake range can be set between 170°F and 500°F (77°C and 260°C).
3. Touch **START**.
4. Touch **OPTIONS** and then number key "7." "SABBATH MODE" will appear on the oven display.

To Regularly Set, Timed:

! WARNING

Food Poisoning Hazard

Do not let food sit in oven more than one hour before or after cooking.

Doing so can result in food poisoning or sickness.

Sabbath Mode must be enabled before starting the Bake cycle. See the "To Activate" section.

1. On double ovens only, touch UPPER OVEN or LOWER OVEN. Each oven can be independently set.
2. Touch BAKE.
Touch the number keys to enter a temperature other than 350°F (177°C). The bake range can be set between 170°F and 500°F (77°C and 260°C).
3. Touch COOK TIME.
4. Touch the number keys to enter the length of Sabbath Mode time, up to 11 hours 59 minutes.
5. Touch START. The oven will begin a timed bake cycle. The start time and stop time will appear on the display.
6. Touch OPTIONS and then touch number key "7." "SABBATH MODE" will appear on the oven display.
7. When the stop time is reached, the oven will automatically turn off. The oven control will remain in Sabbath Mode until the Off button is touched.

Temperature Change

The oven temperature can be changed when the oven(s) are in the Sabbath Mode. No tones will sound, and the display will not change. The heating elements will not turn on or off for a random time, anywhere from 16 to 24 seconds. It may take up to one-half hour for the oven to change temperature.

Number keys 1 through 0 represent temperatures. Use the following chart as a guide.

NUMBER KEY	OVEN TEMPERATURE
1	170°F (77°C)
2	200°F (95°C)
3	225°F (107°C)
4	250°F (120°C)
5	300°F (149°C)
6	325°F (163°C)
7	350°F (177°C)
8	375°F (191°C)
9	400°F (204°C)
0	450°F (232°C)

To Change Temperature:

Initially on double ovens, the cavities can be set for independent temperatures. However, once Sabbath Mode is running, if the temperature is changed both cavities will use the new temperature.

1. Touch the number key from the chart.
2. Touch START.

OVEN USE

Odors and smoke are normal when the oven is used the first few times, or when it is heavily soiled.

During oven use, the heating elements will not remain on, but will cycle on and off throughout oven operation.

IMPORTANT: The health of some birds is extremely sensitive to the fumes given off. Exposure to the fumes may result in death to certain birds. Always move birds to another closed and well-ventilated room.

Aluminum Foil

IMPORTANT: To avoid permanent damage to the oven bottom finish, do not line the oven bottom with any type of foil, liners or cookware.

- For best cooking results, do not cover entire rack with foil because air must be able to move freely for best cooking results.
- To catch spills, place foil on rack below dish. Make sure foil is at least ½" (1.3 cm) larger than the dish and that it is turned up at the edges.

Positioning Racks and Bakeware

IMPORTANT: To avoid permanent damage to the porcelain finish, do not place food or bakeware directly on the oven door or bottom.

RACKS

- Position racks before turning on the oven.
- Do not position racks with bakeware on them.
- Make sure racks are level.

To move a rack, pull it out to the stop position, raise the front edge, then lift out. Use the following illustration and charts as a guide.

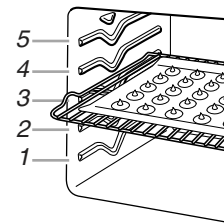

Traditional Cooking

FOOD	RACK POSITION*
Large roasts, turkeys, angel food, bundt cakes, quick breads, pies	1 or 2
Yeast breads, casseroles, meat and poultry	2
Cookies, biscuits, muffins, cakes	2 or 3

*On models with the CleanBake™ feature, foods may be placed on a lower rack position.

Convection Cooking

OVEN SETTING	NUMBER OF RACKS USED	RACK POSITION(S)
Convection Bake	1	1, 2 or 3
Convection Bake	2	1 or 2 and 4
Convection Bake	3	1, 3 and 5
Convection Roast	1	1, 2 or 3
Convection Broil	1	3 or 4

BAKEWARE

To cook food evenly, hot air must be able to circulate. For traditional cooking, allow 2" (5 cm) of space around bakeware and oven walls. For convection cooking, allow 1" (2.5 cm) of space around bakeware and oven walls. Use the following chart as a guide.

NUMBER OF PAN(S)	POSITION ON RACK
1	Center of rack.
2	Side by side or slightly staggered.
3 or 4	Placement that gives best result. Make sure that no bakeware piece is directly over another.

Roll-Out Rack

The roll-out rack allows easy access to position and remove food in the oven. It can be used in rack positions 1 through 4. Do not put the roll-out rack in position 5 because it will not fit.

Open Position

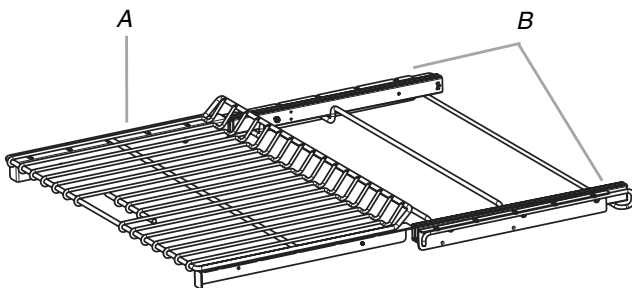

A. Roll-out rack
B. Sliding shelf

Closed and Engaged Position

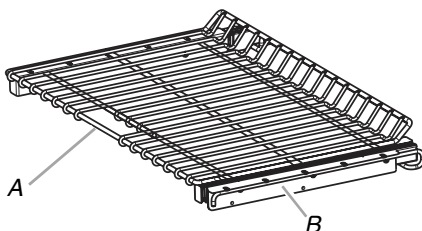

A. Roll-out rack
B. Sliding shelf

To Remove Roll-Out Rack:

1. Slide the rack in completely so that it is closed and engaged with the sliding shelf.
2. Using 2 hands, lift up on the front edge of the rack and the sliding shelf together. Slowly push both to the back wall of the oven so the front edge of the sliding shelf sits on the rack guide located on the sides of the oven.

The front edge of the rack and the sliding shelf should be higher than the back edge.

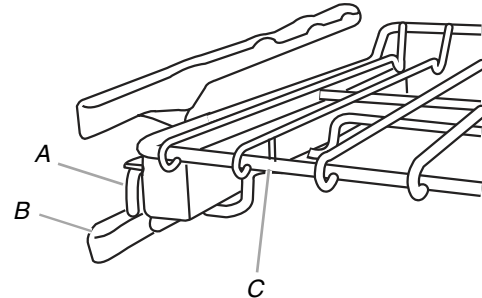

A. Sliding shelf
B. Rack guide
C. Roll-out rack

3. Using 2 hands, lift up the back of the rack and the sliding shelf so that the back and front are level on the rack guide.

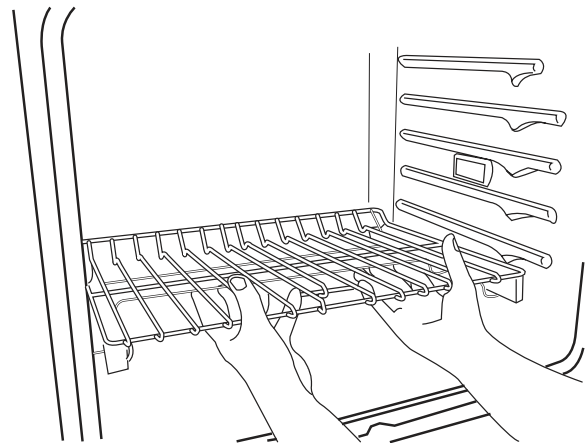

4. Pull the rack and the sliding shelf out.

To Replace Roll-out Rack

1. Using 2 hands, grasp the front of the closed rack and the sliding shelf. Place the closed rack and the sliding shelf on the rack guide.
2. Slowly push the rack and the sliding shelf to the back of the oven until the back edge of the sliding shelf drops.
3. Pull the rack and the sliding shelf slightly forward until the front edge drops and the sliding shelf is on the rack guide.

To avoid damage to the sliding shelves, do not place more than 25 lbs (11.4 kg) on the rack.

Do not clean the roll-out rack in a dishwasher. It may remove the rack's lubricant and affect its ability to slide.

See the "General Cleaning" section for more information.

Bakeware

The bakeware material affects cooking results. Follow manufacturer's recommendations and use the bakeware size recommended in the recipe. Use the following chart as a guide.

BAKEWARE/ RESULTS	RECOMMENDATIONS
Light colored aluminum <ul style="list-style-type: none"> ■ Light golden crusts ■ Even browning 	<ul style="list-style-type: none"> ■ Use temperature and time recommended in recipe.
Dark aluminum and other bakeware with dark, dull and/or nonstick finish <ul style="list-style-type: none"> ■ Brown, crisp crusts 	<ul style="list-style-type: none"> ■ May need to reduce baking temperatures slightly. ■ Use suggested baking time. ■ For pies, breads and casseroles, use temperature recommended in recipe. ■ Place rack in center of oven.
Insulated cookie sheets or baking pans <ul style="list-style-type: none"> ■ Little or no bottom browning 	<ul style="list-style-type: none"> ■ Place in the bottom third of oven. ■ May need to increase baking time.
Stainless steel <ul style="list-style-type: none"> ■ Light, golden crusts ■ Uneven browning 	<ul style="list-style-type: none"> ■ May need to increase baking time.
Stoneware/Baking stone <ul style="list-style-type: none"> ■ Crisp crusts 	<ul style="list-style-type: none"> ■ Follow manufacturer's instructions.
Ovenproof glassware, ceramic glass or ceramic <ul style="list-style-type: none"> ■ Brown, crisp crusts 	<ul style="list-style-type: none"> ■ May need to reduce baking temperatures slightly.

Meat Thermometer

On models without a temperature probe, use a meat thermometer to determine whether meat, poultry and fish, are cooked to the desired degree of doneness. The internal temperature, not appearance, should be used to determine doneness. A meat thermometer is not supplied with this appliance.

- Insert the thermometer into the center of the thickest portion of the meat or inner thigh and breast of poultry. The tip of the thermometer should not touch fat, bone or gristle.
- After reading the thermometer once, push it into the meat ½" (1.3 cm) more and read again. If the temperature drops, cook the meat or poultry longer.
- Check all meat, poultry and fish in 2 or 3 different places.

Oven Vent(s)

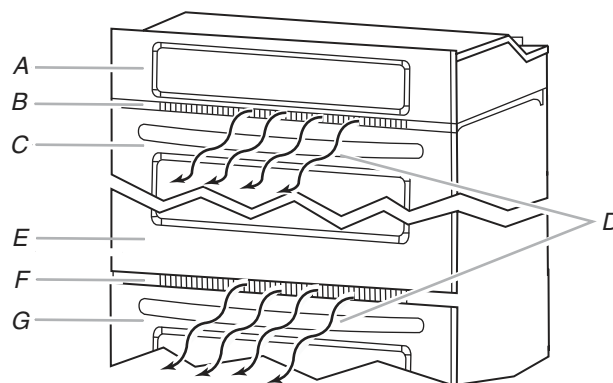

Single and Double Oven

- A. Control panel
- B. Oven vent
- C. Single oven or upper double oven
- D. Warm air

Double Oven

- D. Warm air
- E. Upper oven
- F. Oven vent
- G. Lower oven

The oven vent(s) should not be blocked or covered since they allow the release of hot air and moisture from the oven. Blocking or covering vents will cause poor air circulation, affecting cooking and cleaning results.

Baking and Roasting

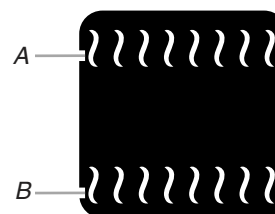

- A. Broil elements
- B. Bake element

During baking or roasting, the bake and broil elements will cycle on and off in intervals to maintain the oven temperature.

If the oven door is opened during baking or roasting, the heating elements (bake and both broils) will turn off approximately 30 seconds after the door is opened. They will turn on again approximately 30 seconds after the door is closed.

To Bake or Roast:

Before baking or roasting, position racks according to the "Positioning Racks and Bakeware" section. When roasting, it is not necessary to wait for the oven to preheat before putting food in, unless recommended in the recipe.

1. On double ovens only, touch UPPER OVEN or LOWER OVEN. The cavity symbol will indicate which oven was chosen.
2. Touch BAKE.

Touch the number keys to enter a temperature other than 350°F (177°C). The bake range can be set between 170°F and 500°F (77°C and 260°C).

3. Touch START.
"Lo" will appear on the oven display if the actual oven temperature is under 170°F (77°C).
When the actual oven temperature reaches 170°F (77°C), the oven display will begin displaying the temperature as it increases.
When the set temperature is reached, if on, one tone will sound.
4. Touch OFF, UPPER OVEN OFF or LOWER OVEN OFF when finished cooking.

Full and Center Broiling

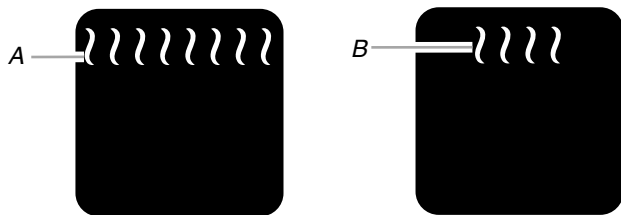

A. Full broil
B. Center broil

Broiling uses direct radiant heat to cook food.

During full broiling, both the inner and outer broil elements heat. During center broiling, only the inner broil element heats. The element(s) cycle on and off in intervals to maintain the oven temperature.

If the oven door is opened during broiling, the broil element(s) will turn off in approximately 30 seconds. When the oven door is closed, the elements will come back on approximately 30 seconds later.

- For best results, use a broiler pan and grid. It is designed to drain juices and help avoid spatter and smoke.
If you would like to purchase a Broiler Pan Kit, it may be ordered. See "Assistance or Service" section to order. Ask for Part Number W10123240.
- For proper draining, do not cover the grid with foil. The bottom of the broiler pan may be lined with aluminum foil for easier cleaning.
- Trim excess fat to reduce spattering. Slit the remaining fat on the edges to avoid curling.
- Pull out oven rack to stop position before turning or removing food. Use tongs to turn food to avoid the loss of juices. Very thin cuts of fish, poultry or meat may not need to be turned.
- After broiling, remove the pan from the oven when removing the food. Drippings will bake on the pan if left in the heated oven, making cleaning more difficult.

To Broil:

Before broiling, position rack according to the Broiling Chart.

When broiling, changing the temperature allows more precise control. The lower the temperature, the slower the cooking. Thicker cuts and unevenly shaped pieces of meat, fish and poultry may cook better at lower broiling temperatures.

Position food on the grid on the broiler pan, then place it in the center of the oven rack with the longest side parallel to the door. It is not necessary to wait for the oven to preheat before putting food in, unless recommended in the recipe.

Close the door.

1. On double ovens only, touch UPPER OVEN or LOWER OVEN. The cavity symbol will indicate which oven was chosen.
2. Touch BROIL once for Full broiling, twice for Center broiling. Touch the number keys to enter a temperature other than 500°F (260°C). The broil range can be set between 170°F and 500°F (77°C and 260°C).
3. Touch START.
The set oven temperature will appear on the oven display until the oven is turned off.
4. Touch OFF, UPPER OVEN OFF or LOWER OVEN OFF when finished cooking.

BROILING CHART

For best results, place food 3" (7 cm) or more from the broil elements, rack position 4 is recommended. For diagram, see the "Positioning Racks and Bakeware" section.

A temperature setting of 500°F (260°C) is recommended.

Times are guidelines only and may need to be adjusted for individual foods and tastes.

FOOD	COOK TIME (in minutes)
Beef	
Steak 1" to 1¼" (2.5 cm to 3 cm) thick	15-17
medium-rare	17-19
medium	20-24
well-done	
Pork	
Pork chops 1" (2.5 cm) thick	16-18
medium	
Lamb	
Lamb chops 1" (2.5 cm) thick	10-12
medium-rare	11-13
medium	
Ground Meats	
Ground beef, pork or lamb patties* ¾" (2 cm) thick	16-18
well-done	
Chicken	
Chicken bone-in pieces (2" to 2½" [5 cm to 6.3 cm])	20-30
boneless pieces (4 oz. [113 g])	12-15
Fish	
Fish ½" to ¾" (1.25 to 2 cm) thick	6-9

*Place up to 12 patties, equally spaced, on broiler grid.

Convection Cooking

(single, upper and, on some models, lower oven)

In a convection oven, the fan-circulated hot air continually distributes heat more evenly than the natural movement of air in a standard thermal oven. This movement of hot air helps maintain a consistent temperature throughout the oven, cooking foods more evenly, crisping surfaces while sealing in moisture and yielding crustier breads.

Most foods can be cooked by lowering cooking temperatures 25°F to 50°F (14°C to 28°C), and cooking time can be shortened by as much as 30 percent, especially for large turkeys and roasts.

- It is important not to cover foods with lids or aluminum foil so that surface areas remain exposed to the circulating air, allowing browning and crisping.
- Keep heat loss to a minimum by opening the oven door only when necessary.
- Choose cookie sheets without sides and roasting pans with lower sides to allow air to move freely around the food.
- Test baked goods for doneness a few minutes before the minimum cooking time using a method such as a toothpick.

⚠ WARNING



Burn Hazard

- Use an oven mitt to remove temperature probe.**
- Do not touch broil element.**
- Failure to follow these instructions can result in burns.**

- Use a meat thermometer or the temperature probe to determine the doneness of meats and poultry. Check the temperature of pork and poultry in 2 or 3 places.

Convection Bake

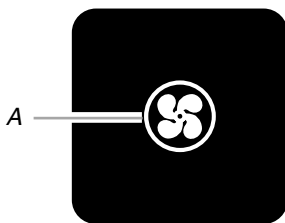

A. T.H.E.™ Convection element (hidden) and fan

The T.H.E.™ (Third Hidden Element) convection element is hidden in the rear panel of the oven cavity, and assisted by the convection fan, provides balanced, efficient heating.

Convection baking can be used for baking delicate cakes and pastries, as well as foods on multiple racks. It is helpful to stagger items on the racks to allow a more even flow of heat. If the oven is full, extra cooking time may be needed.

When cooking an oven meal with several different types of foods, be sure to select recipes that require similar temperatures. Cookware should sit in the oven with at least 1" (2.5 cm) of space between the cookware and the sides of the oven.

During convection baking preheat, the T.H.E.™ convection element and broil element and the CleanBake™ element all heat the oven cavity. After preheat, the T.H.E.™ convection element and the CleanBake™ element will cycle on and off in intervals to maintain oven temperature, while the fan constantly circulates the hot air.

If the oven door is opened during convection baking, the fan turns off immediately when the door is opened and turns on immediately when the door is closed. Convection, Bake and Broil (only during preheating) elements will turn off approximately 30 seconds after the door is opened. They will turn on again approximately 30 seconds after the door is closed.

- Reduce recipe temperature 25°F (14°C). The cook time may need to be reduced also.

To Convection Bake:

Before convection baking, position racks according to the "Positioning Racks and Bakeware" section. When using 2 racks, place on guides 2 and 4. When using 3 racks, place on guides 1, 3 and 5.

1. On double ovens only, touch UPPER OVEN or LOWER OVEN. The cavity symbol indicates which oven was chosen.
2. Touch CONVECTION BAKE.
Touch the number keys to enter a temperature other than 325°F (163°C). The convection bake range can be set between 170°F and 500°F (77°C and 260°C).
3. Touch START.
"Lo°" will appear on the oven display if the actual oven temperature is under 170°F (77°C).
When the actual oven temperature reaches 170°F (77°C), the oven display will show the oven temperature increasing.
When the set temperature is reached, if on, 1 tone will sound.
4. Touch OFF, UPPER OVEN OFF or, on some models, LOWER OVEN OFF when finished cooking.

Convection Roast

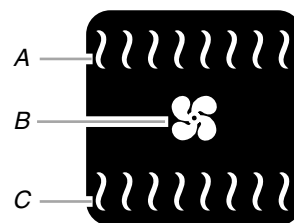

- A. Broil heat
- B. Convection fan
- C. Bake heat

Convection roasting can be used for roasting meats and poultry, or for baking yeast breads and loaf cakes using a single rack. During convection roasting, the broil, convection, and CleanBake™ elements will cycle on and off in intervals to maintain oven temperature, while the fan constantly circulates the hot air.

If the oven door is opened during convection roasting, the fan turns off immediately when the door is opened and turns on immediately when the door is closed. Bake, broil, and convection elements will turn off approximately 30 seconds after the door is opened. They will turn on again approximately 30 seconds after the door is closed.

- Reduce recipe temperature 25°F (14°C). The cook time may need to be reduced also.

To Convection Roast:

Before convection roasting, position racks according to the "Positioning Racks and Bakeware" section. It is not necessary to wait for the oven to preheat before putting food in, unless recommended in the recipe.

Use the roasting rack on top of the broiler pan and grid. This holds the food above the grid and allows air to circulate completely around all surfaces.

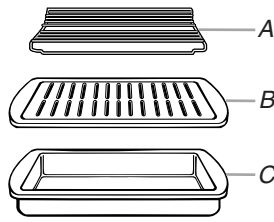

A. Roasting rack
B. Broiler grid
C. Broil pan

1. On double ovens only, touch UPPER OVEN or, on some models, LOWER OVEN.

The cavity symbol indicates which oven was chosen.

2. Touch CONVECTION ROAST.

Touch the number keys to enter a temperature other than 325°F (163°C). The convection roast range can be set between 170°F and 500°F (77°C and 260°C).

3. Touch START.

"Lo°" will appear on the oven display if the actual oven temperature is under 170°F (77°C).

When the actual oven temperature reaches 170°F (77°C), the oven display will show the oven temperature increasing.

When the set temperature is reached, if on, one tone will sound.

4. Touch OFF when finished cooking.

CONVECTION ROASTING CHART

FOOD/RACK POSITION	COOK TIME (min. per 1 lb [454 g])	OVEN TEMP.	INTERNAL FOOD TEMP.
Beef, Rack Position 2			
Rib Roast			
rare	20-25	300°F (149°C)	140°F (60°C)
medium	25-30		160°F (71°C)
well-done	30-35		170°F (77°C)
Rib Roast (boneless)			
rare	22-25	300°F (149°C)	140°F (60°C)
medium	27-30		160°F (71°C)
well-done	32-35		170°F (77°C)
Rump, Sirloin Tip Roast			
rare	20-25	300°F (149°C)	140°F (60°C)
medium	25-30		160°F (71°C)
well-done	30-35		170°F (77°C)
Meat Loaf	20-25	325°F (163°C)	165°F (74°C)

FOOD/RACK POSITION	COOK TIME (min. per 1 lb [454 g])	OVEN TEMP.	INTERNAL FOOD TEMP.
Veal, Rack Position 2			
Loin, Rib, Rump Roast			
medium	25-35	325°F (163°C)	160°F (71°C)
well-done	30-40		170°F (77°C)
Pork, Rack Position 2			
Loin Roast (boneless)	30-40	325°F (163°C)	160°F-170°F (71°C-77°C)
Shoulder Roast	35-40	325°F (163°C)	160°F-170°F (71°C-77°C)
Ham, Rack Position 2			
Fresh (uncooked)	25-35	300°F (149°C)	160°F (71°C)
Fully Cooked	15-20	300°F (149°C)	160°F (71°C)
Lamb, Rack Position 2			
Leg, Shoulder Roast			
medium	25-30	300°F (149°C)	160°F (71°C)
well-done	30-35		170°F (77°C)
Chicken*, Rack Position 2			
Whole			
3-5 lbs (1.5-2.2 kg)	20-25	325°F (163°C)	180°F (82°C)
5-7 lbs (2.2-3.1 kg)	15-20	325°F (163°C)	180°F (82°C)
Turkey*, Rack Positions 1 or 2			
13 lbs and under (5.85 kg)	10-15	300°F (149°C)	180°F (82°C)
Over 13 lbs (5.85 kg)	10-12	300°F (149°C)	180°F (82°C)
Cornish Game Hens*, Rack Position 2 or 3			
1-1.5 lbs (0.5-0.7 kg)	50-60	325°F (163°C)	180°F (82°C)

*Do not stuff poultry when convection roasting.

Convection Broil

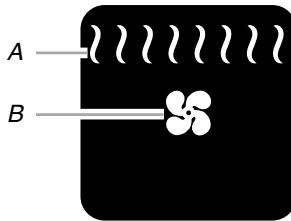

A. Broil heat
B. Convection fan

During convection broiling, the broil elements will cycle on and off in intervals to maintain oven temperature, while the fan constantly circulates the hot air.

The temperature is preset at 450°F (232°C), but can be changed to a different temperature. Cooking times will vary depending on the rack position and temperature and may need to be adjusted.

If the oven door is opened during convection broiling, fan turns off immediately when door is opened and turns on again immediately when door is closed. Broil elements will turn off approximately 30 seconds after the door is opened. They will turn on again approximately 30 seconds after the door is closed.

To Convection Broil:

Before convection broiling, see “Full and Center Broiling” section for general broiling guidelines. Position rack.

Allow the oven to preheat for 5 minutes. Position food on the unheated grid on the broiler pan, then place it in the center of the oven rack with the longest side parallel to the door.

Close the door.

1. On double ovens only, touch UPPER OVEN or, on some models, LOWER OVEN.
The cavity symbol indicates which oven was chosen.
2. Touch CONVECTION BROIL.
Touch the number keys to enter a temperature other than 450°F (232°C). The convection broil range can be set between 170°F and 500°F (77°C and 260°C).
3. Touch START.
The set oven temperature will appear on the oven display until oven is turned off.
4. Touch OFF, UPPER OVEN OFF or, on some models, LOWER OVEN OFF when finished cooking.

EasyConvect™ Conversion

(single, upper and, on some models, lower oven)

Convection temperatures and times differ from those of standard cooking. The oven can automatically reduce standard recipe temperatures and times for convection cooking.

The conversion may not be exact because foods are grouped in general categories. To ensure optimal cooking results, the oven will prompt a food check at the end of a non-delayed cook time. Use the following chart as a guide.

SETTING	FOODS
BAKED GOODS	Biscuits, Breads: quick and yeast, Cakes and Cookies Casseroles: including frozen entrées and soufflés Fish
MEATS	Baked potatoes Chicken: whole and pieces, Meat loaf, Roasts: pork, beef and ham Turkey and large poultry are not included because their cook times vary.
OTHER FOODS	Convenience foods: french fries, nuggets, fish sticks, pizza, Pies: fruit and custard

To Use:

Before using Convection Temperature Conversion for BAKED GOODS and OTHER FOODS, allow the oven to preheat before placing food in the oven.

1. On double ovens only, touch UPPER OVEN or, on some models, LOWER OVEN.
The cavity symbol indicates which oven was chosen.
2. Touch BAKED GOODS, MEATS or OTHER FOODS.
3. Touch number keys to enter standard cook temperature.
4. Touch number keys to enter standard cook time.
5. Touch START.
“CHECK FOOD AT” and the stop time will appear on the oven display after preheating is complete.
When the stop time is reached, end-of-cycle tones will sound if enabled. Open the door and check food.
6. Touch OFF, UPPER OVEN OFF or, on some models, LOWER OVEN OFF when finished cooking.

Proofing Bread

Proofing bread prepares dough for baking by activating the yeast. Proofing twice is recommended unless the recipe directs otherwise.

To Proof:

Before first proofing, place dough in a lightly greased bowl and cover loosely with wax paper coated with shortening. Place on rack guide 2, then place broiler pan on guide 1. See "Positioning Racks and Bakeware" for diagram. Close door.

1. On double ovens only, touch UPPER OVEN or LOWER OVEN. The cavity symbol will indicate which oven was chosen.
2. Touch BREAD PROOF. Display will show 100°F (38°C).
3. Touch START.
Let dough rise until nearly doubled in size, check at 20 to 25 minutes. Proofing time may vary depending on dough type and quantity.
4. Touch OFF, UPPER OVEN OFF or LOWER OVEN OFF when finished proofing.

Before second proofing, shape dough, place in baking pan(s) and cover loosely with plastic wrap coated with cooking spray. Follow same placement, and control steps above. Before baking, remove plastic wrap.

Temperature Probe

(single, upper and, on some models, lower oven)

! WARNING



Burn Hazard

Use an oven mitt to remove temperature probe.

Do not touch broil element.

Failure to follow these instructions can result in burns.

The temperature probe accurately measures the internal temperature of meat, poultry and casseroles with liquid and should be used in determining the doneness of meat and poultry. It should not be used during full and center broiling, convection broiling, dehydrating or proofing bread.

Always unplug and remove the temperature probe from the oven when removing food.

To Use:

Before using, insert the probe into the food item. (For meats, the probe tip should be located in the center of the thickest part of the meat and not into the fat or touching a bone). Place food in oven and connect the temperature probe to the jack. Keep probe as far away from heat source as possible. Close oven door.

1. On double ovens only, touch UPPER OVEN or LOWER OVEN.

This step is necessary only if a meat probe is plugged into the upper and lower cavity at the same time. If only 1 meat probe is used, cavity focus is automatically switched to the oven that the meat probe is plugged into.

2. Touch the number keys to enter a probe temperature, if other than 160°F (75°C). The probe temperature is the desired internal temperature of the food when it is done. The temperature can be set between 130°F and 190°F (55°C and 85°C).
3. Touch BAKE, CONVECT BAKE or CONVECT ROAST.
Touch number keys to enter a temperature other than the one displayed. The oven temperature is the temperature given in the recipe.
4. Touch START.

The set oven temperature will appear on the oven display throughout cooking.

"Lo°" will appear as the probe temperature until the internal temperature of the food reaches 130°F (54°C). Then the display will show the temperature increasing.

When the set probe temperature is reached, the oven will shut off automatically and "Cooking Complete" will appear on the oven display.

If enabled, end-of-cycle tones will sound, then reminder tones will sound every minute.

5. Touch OFF, UPPER OVEN OFF or, on some models, LOWER OVEN OFF, or open the oven door to clear the display and/or stop reminder tones.
6. Always unplug and remove the temperature probe from the oven when removing food. The probe symbol will remain lit in the display until the probe is unplugged.

To Change Probe Temperature, Oven Setting:

1. Unplug probe, plug back in, then close oven door.
2. Follow steps 1 through 6 in the "To Use" section.

Timed Cooking

⚠ WARNING

Food Poisoning Hazard

Do not let food sit in oven more than one hour before or after cooking.

Doing so can result in food poisoning or sickness.

Timed Cooking allows the oven(s) to be set to turn on at a certain time of day, cook for a set length of time, and/or shut off automatically. Delay start should not be used for food such as breads and cakes because they may not bake properly.

To Set a Cook Time:

1. On double ovens only, touch UPPER OVEN or LOWER OVEN. The cavity symbol will indicate which oven was chosen.

2. Touch BAKE, CONVECTION BAKE OR CONVECTION ROAST.

Touch the number keys to enter a temperature other than the one displayed. The range can be set between 170°F and 500°F (77°C and 260°C).

Timed Cooking may also be used with the Bread Proof function, but the temperature is not adjustable.

3. Touch COOK TIME.
4. Touch number keys to enter the length of time to cook.
5. Touch START.

The minute time countdown will appear on the oven display. The start time and stop time are not displayed until the oven is finished preheating.

On double oven models only, when both upper and lower ovens are being used at the same time, touch UPPER OVEN or LOWER OVEN to display respective cook time.

When the stop time is reached, the oven will shut off automatically and “cooking complete” will appear on the oven display.

If enabled, end-of-cycle tones will sound, then reminder tones will sound every minute.

6. Touch OFF, UPPER OVEN OFF or LOWER OVEN OFF, or open the oven door to clear the display and/or stop reminder tones.

To Set a Cook Time and Stop Time:

Before setting, make sure the clock is set to the correct time of day. See “Clock” section.

1. On double ovens only, touch UPPER OVEN or LOWER OVEN. The cavity symbol will indicate which oven was chosen.
2. Touch BAKE, CONVECTION BAKE OR CONVECTION ROAST.

Touch the number keys to enter a temperature other than the one displayed. The range can be set between 170°F and 500°F (77°C and 260°C).

Timed Cooking may also be used with the Bread Proof function, but the temperature is not adjustable.

3. Touch COOK TIME.
4. Touch number keys to enter the length of time to cook.
5. Touch STOP TIME.
6. Touch the number keys to enter time of day to stop.
7. Touch START.

The start time is automatically calculated and displayed.

“DELAY” and the stop time will also appear on the oven display.

When the start time is reached, the oven will automatically turn on. The minute time countdown will appear on the oven display.

When the stop time is reached, the oven will shut off automatically and “cooking complete” will appear on the oven display.

If enabled, end-of-cycle tones will sound, then reminder tones will sound every minute.

8. Touch OFF, UPPER OVEN OFF or LOWER OVEN OFF, or open the oven door to clear the display and/or stop reminder tones.

Dehydrating

(on convection models, closed door)

Dehydration is a method used to preserve food. Various factors, such as the quality of the fresh food, pretreatment techniques, the size and thickness of the food, and the climate may affect the finished product.

During dehydration, heat is used to force out moisture and air circulation is used to carry the moisture away.

Refer to a reliable book or source for complete information about dehydrating and preserving foods.

To Dehydrate:

Position the racks according to the following chart. See “Positioning Racks and Bakeware” section for diagram.

NUMBER OF RACKS	RACK POSITION(S)
1	3
2	2 and 4
3	1, 3 and 5

1. Close the oven door.
2. Touch OPTIONS then 5.
3. On double ovens only, touch UPPER OVEN or LOWER OVEN. The cavity symbol will indicate which oven was chosen.
4. Touch the number key to enter a temperature other than 140°F (60°C). The dehydrating range can be set between 100°F and 200°F (38°C and 93°C).
5. Touch START.
6. Touch OFF, UPPER OVEN OFF or, on some models, LOWER OVEN OFF when finished dehydrating.

NOTE: The oven will automatically turn off after 12 hours. However, some foods may take more than 12 hours to dehydrate. If this is the case, the oven will need to be restarted.

OVEN CARE

Self-Cleaning Cycle

! WARNING



Burn Hazard

Do not touch the oven during the Self-Cleaning cycle.

Keep children away from oven during Self-Cleaning cycle.

Failure to follow these instructions can result in burns.

IMPORTANT: The health of some birds is extremely sensitive to the fumes given off during the Self-Cleaning cycle. Exposure to the fumes may result in death to certain birds. Always move birds to another closed and well-ventilated room.

Self-clean the oven before it becomes heavily soiled. Heavy soil results in longer cleaning and more smoke.

Keep the kitchen well-ventilated during the Self-Cleaning cycle to help get rid of heat, odors, and smoke.

Do not block the oven vent(s) during the Self-Cleaning cycle. Air must be able to move freely. Depending on your model, see "Oven Vent" or "Oven Vents" section.

Do not clean, rub, damage or move the oven door gasket. The door gasket is essential for a good seal.

Prepare Oven:

- Remove the broiler pan, grid, cookware and bakeware and, on some models, the temperature probe from the oven.
Remove oven racks to keep them shiny and easy to slide. See "General Cleaning" section for more information.
- Remove any foil from the oven because it may burn or melt, damaging the oven.
- Hand clean inside door edge and the 1½" (3.8 cm) area around the inside oven cavity frame, being certain not to move or bend the gasket. This area does not get hot enough during self-cleaning to remove soil. Do not let water, cleaner, etc. enter slots on door frame. Use a damp cloth to clean this area.
- Wipe out any loose soil to reduce smoke and avoid damage. At high temperatures, foods react with porcelain. Staining, etching, pitting or faint white spots can result. This will not affect cooking performance.

How the Cycle Works

IMPORTANT: The heating and cooling of porcelain on steel in the oven may result in discoloring, loss of gloss, hairline cracks and popping sounds.

The Self-Cleaning cycle uses very high temperatures, burning soil to a powdery ash.

The oven is preset for a 3 hour 30 minute clean cycle, however the time can be changed. Suggested clean times are 2 hours 30 minutes for light soil and between 3 hours 30 minutes and 4 hours 30 minutes for average to heavy soil.

Use the following chart as a guide to determine the desired cleaning level.

CLEANING LEVEL	TOTAL CLEANING TIME (includes a 30 minute cool down time)
1 (Quick)	2 hours 30 minutes
2	3 hours
3 (Regular)	3 hours 30 minutes
4	4 hours
5 (Maxi)	4 hours 30 minutes

Once the oven has completely cooled, remove ash with a damp cloth. To avoid breaking the glass, do not apply a cool damp cloth to the inner door glass before it has completely cooled.

The oven lights will not work during the Self-Cleaning cycle.

On double oven models, only one oven can self-clean at a time. If one oven is self-cleaning, the other oven cannot be set or turned on.

NOTE: The oven has a 2 speed cooling fan motor. During self-clean the fan(s) will operate at its highest speed to increase airflow to better exhaust the hotter air through the oven vent(s). An increase in noise may be noticeable during and after the self-clean cycle until the oven cools.

To Self-Clean:

Before self-cleaning, make sure the door is closed completely or it will not lock and the cycle will not begin.

1. On double ovens only, touch UPPER OVEN or LOWER OVEN. The cavity symbol will indicate which oven was chosen.
2. Touch SELF CLEAN. Touch SELF CLEAN repeatedly to set a clean time other than 3 hours and 30 minutes. The clean time can be set between 2 hours and 30 minutes and 4 hours and 30 minutes.
Number keys cannot be used to set a clean time.
3. Touch START.
The oven door will automatically lock and "DOOR LOCKED," the start time and stop time will appear on the oven display. The door will not unlock until the oven cools.
When the cycle is complete and the oven is cool, "self clean complete" will appear on the oven display and "DOOR LOCKED" will disappear.
If enabled, end-of-cycle tones will sound, then reminder tones will sound every minute.
4. Touch OFF, UPPER OVEN OFF or LOWER OVEN OFF or open the oven door to clear the oven display and/or stop reminder tones.

To Delay the Start of Self-Cleaning:

Before delaying the starting of Self-Clean, make sure the clock is set to the correct time of day. See "Clock" section. Also, make sure the door is closed completely or it will not lock and the cycle will not begin.

1. On double ovens only, touch UPPER OVEN or LOWER OVEN. The cavity symbol will indicate which oven was chosen.
2. Touch SELF CLEAN. Touch SELF CLEAN repeatedly to set a clean time other than 3 hours and 30 minutes. The clean time can be set between 2 hours and 30 minutes and 4 hours and 30 minutes.
3. Touch STOP TIME.
4. Touch the number keys to enter the time of day to stop.
5. Touch START.

Number keys cannot be used to set clean time.

The start time is automatically calculated and displayed.

The door will automatically lock and "DOOR LOCKED," "DELAY," and the stop time will also appear on the display. The door will not unlock until the oven cools.

When the start time is reached, the oven will automatically turn on.

When the cycle is complete and the oven cools, "self clean complete" will appear on the oven display and "DOOR LOCKED" will disappear.

If enabled, end-of-cycle tones will sound, then reminder tones will sound every minute.

6. Touch OFF, UPPER OVEN OFF or LOWER OVEN OFF or open the oven door to clear the oven display.

To Stop Self-Clean anytime:

Touch OFF, UPPER OVEN OFF or LOWER OVEN OFF. If the oven temperature is too high, the door will remain locked. It will not unlock until the oven cools.

General Cleaning

IMPORTANT: Before cleaning, make sure all controls are off and the oven is cool. Always follow label instructions on cleaning products.

Soap, water and a soft cloth or sponge are suggested first unless otherwise noted.

STAINLESS STEEL (on some models)

Cleaning Method:

Rub in direction of grain to avoid damaging.

- KitchenAid® Stainless Steel Cleaner and Polish Part Number 4396920 (not included) or KitchenAid® Stainless Steel Wipes Part Number 8212510 (not included):

See "Assistance or Service" section to order.

- Liquid detergent or all-purpose cleaner:

Rinse with clean water and dry with soft, lint-free cloth.

- Vinegar for hard water spots

To avoid damage to stainless steel surfaces, do not use soap-filled scouring pads, abrasive cleaners, Cooktop Polishing Creme, steel-wool pads, gritty washcloths or some paper towels.

OVEN DOOR EXTERIOR

Cleaning Method:

- Glass cleaner and a soft cloth or sponge:
Apply glass cleaner to soft cloth or sponge, not directly on panel.
- All-Purpose Appliance Cleaner Part Number 31682 (not included):
See "Assistance or Service" section to order.

OVEN DOOR INTERIOR

Cleaning Method:

- Self-Cleaning cycle:
For optimal door cleaning result, wipe away any deposits with a damp sponge before running cycle.

CONTROL PANEL

Cleaning Method:

- Glass cleaner and soft cloth or sponge:
Apply glass cleaner to soft cloth or sponge, not directly on panel.
- All-Purpose Appliance Cleaner Part Number 31682 (not included):
See "Assistance or Service" section to order.

To avoid damage to the control panel, do not use abrasive cleaners, steel-wool pads, gritty washcloths or some paper towels.

OVEN CAVITY

Do not use oven cleaners.

Food spills should be cleaned when oven cools. At high temperatures, foods react with porcelain and staining, etching, pitting or faint white spots can result.

Cleaning Method:

- Self-Cleaning cycle: See "Self-Cleaning Cycle" first.

OVEN RACKS AND ROASTING RACKS

Cleaning Method:

- Self-Cleaning cycle:
See "Self-Cleaning Cycle" first. Remove racks or they will discolor and become harder to slide. If this happens, a light coating of vegetable oil applied to the rack guides will help them slide.
- Steel-wool pad

BROILER PAN AND GRID (on some models)

Do not clean in the Self-Cleaning cycle.

Cleaning Method:

- Mildly abrasive cleanser:
Scrub with wet scouring pad.
- Solution of ½ cup (125 mL) ammonia to 1 gal. (3.75 L) water:
Soak for 20 minutes, then scrub with scouring or steel-wool pad.

Porcelain enamel only, not chrome

- Dishwasher
-

Oven Lights

The oven lights are 12-volt, 5-watt maximum halogen bulbs. They will come on when the oven door is opened. On double oven models, both upper and lower lights will come on when either door is opened. The oven lights will not work during the Self-Cleaning cycle. When the oven door is closed, touch OVEN LIGHT to turn light on or off.

To Replace:

Before replacing the bulb, make sure the oven is off and cool.

1. Disconnect power.
2. Remove glass light cover by grasping the front edge and pulling away from oven.

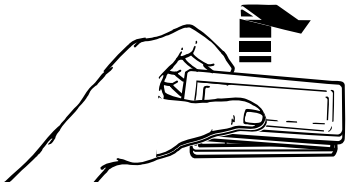

3. Remove bulb from socket.
4. Replace bulb, using tissue or wearing cotton gloves to handle bulb. Do not touch bulb with bare fingers.
5. Replace bulb cover by snapping back into wall.
6. Reconnect power.

Oven Door

IMPORTANT:

To avoid oven door glass breakage:

- Do not close the oven door if the racks are not fully inserted into the oven cavity or when bakeware extends past the front edge of an oven rack.
- Do not set objects on the glass surface of the oven door.
- Do not hit glass surfaces with bakeware or other objects.
- Do not wipe down glass surfaces until the oven has completely cooled.

For normal oven use, it is not suggested to remove the oven door. However, if removal is necessary, make sure the oven is off and cool. Then, follow these instructions. The oven door is heavy.

To Remove:

1. Open oven door all the way.
2. Flip up the hinge latch on each side.

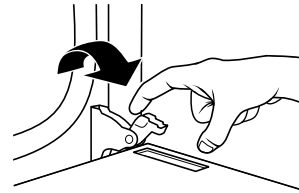

3. Close the oven door as far as it will shut.
4. Lift the oven door while holding both sides.

Continue to push the oven door closed and pull it away from the oven door frame.

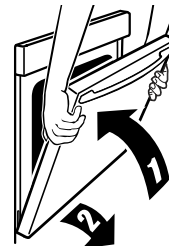

To Replace:

1. Insert both hanger arms into the door.



2. Open the oven door.
You should hear a “click” as the door is set into place.
3. Move the hinge levers back to the locked position. Check that the door is free to open and close. If it is not, repeat the removal and installation procedures.

TROUBLESHOOTING

Try the solutions suggested here first in order to avoid the cost of an unnecessary service call.

Nothing will operate

- **Has a household fuse blown, or has a circuit breaker tripped?**
Replace the fuse or reset the circuit breaker. If the problem continues, call an electrician.
 - **Is the appliance wired properly?**
See Installation Instructions.
-

Oven will not operate

- **Is the electronic oven control set correctly?**
See "Electronic Oven Control" section.
 - **Has a delay start been set?**
See "Timed Cooking" section.
 - **Is the Control Lock set?**
See "Control Lock" section.
 - **Is the Sabbath Mode set?**
See "Sabbath Mode" section.
 - **On double oven models, is one oven self-cleaning?**
When one oven is self-cleaning the other oven cannot be set or turned on.
 - **On double oven models, has the correct oven been selected?**
Choose UPPER OVEN or LOWER OVEN first.
-

Oven temperature too high or too low

- **Does the oven temperature calibration need adjustment?**
See "Oven Temperature Control" section.
-

Warm air coming from oven vent

- Warm air coming from the oven vent is normal. During a self-clean cycle the air stream is increased.
-

Display shows messages

- **Is the display showing a letter followed by a number?**
Clear the display. See "Display(s)" section. If a letter followed by a number reappears, call for service. See "Assistance or Service" section.
-

Self-Cleaning cycle will not operate

- **Is the oven door open?**
Close the oven door all the way.
 - **Has the function been entered?**
See "Self-Cleaning Cycle" section.
 - **On some models, has a delay start Self-Clean cycle been set?**
See "Self-Cleaning Cycle" section.
 - **Has a delay start been set?**
See "Timed Cooking" section.
 - **On double oven models, is one oven self-cleaning?**
When one oven is self-cleaning, the other oven cannot be set to self-clean.
-

Oven cooking results not what expected

- **Is the proper temperature set?**
Double-check the recipe in a reliable cookbook.
- **Is the proper oven temperature calibration set?**
See "Oven Temperature Control" section.
- **Was the oven preheated?**
See "Baking and Roasting" section.
- **Is the proper bakeware being used?**
See "Bakeware" section.
- **Are the racks positioned properly?**
See "Positioning Racks and Bakeware" section.
- **Is there proper air circulation around bakeware?**
See "Positioning Racks and Bakeware" section.
- **Is the batter evenly distributed in the pan?**
Check that batter is level in the pan.
- **Is the proper length of time being used?**
Adjust cooking time.
- **Has the oven door been opened while cooking?**
Oven peeking releases oven heat and can result in longer cooking times.
- **Are baked items too brown on the bottom?**
Move rack to higher position in the oven.
- **Are pie crust edges browning early?**

Use aluminum foil to cover the edge of the crust and/or reduce baking temperature.

ASSISTANCE OR SERVICE

Before calling for assistance or service, please check "Troubleshooting." It may save you the cost of a service call. If you still need help, follow the instructions below.

When calling, please know the purchase date and the complete model and serial number of your appliance. This information will help us to better respond to your request.

If you need replacement parts

If you need to order replacement parts, we recommend that you use only factory specified parts. These factory specified parts will fit right and work right because they are made with the same precision used to build every new KITCHENAID® appliance.

To locate factory specified parts in your area, call us or your nearest KitchenAid designated service center.

In the U.S.A.

Call the KitchenAid Customer eXperience Center toll free: **1-800-422-1230**.

Our consultants provide assistance with:

- Features and specifications on our full line of appliances.
- Installation information.
- Use and maintenance procedures.
- Accessory and repair parts sales.
- Specialized customer assistance (Spanish speaking, hearing impaired, limited vision, etc.).
- Referrals to local dealers, repair parts distributors and service companies. KitchenAid designated service technicians are trained to fulfill the product warranty and provide after-warranty service, anywhere in the United States.

To locate the KitchenAid designated service company in your area, you can also look in your telephone directory Yellow Pages.

For further assistance

If you need further assistance, you can write to KitchenAid with any questions or concerns at:

KitchenAid Brand Home Appliances
Customer eXperience Center
553 Benson Road
Benton Harbor, MI 49022-2692

Please include a daytime phone number in your correspondence.

Accessories

Accessories U.S.A.

To order accessories, call the KitchenAid Customer eXperience Center toll free at **1-800-442-9991** and follow the menu prompts. Or visit our website at www.kitchenaid.com and click on "Shopping Options." Go to "Replacement Parts & Accessories" and click on "applianceaccessories.com." Portable appliances, bakeware, cookware, gadgets and textiles are also available.

KitchenAid® Stainless Steel Cleaner and Polish

(stainless steel models)

Order Part Number 4396920

KitchenAid® Stainless Steel Wipes

(stainless steel models)

Order Part Number 8212510

All-Purpose Appliance Cleaner

Order Part Number 31682

In Canada

Call the KitchenAid Canada Customer Interaction Centre toll free: **1-800-807-6777**.

Our consultants provide assistance with:

- Features and specifications on our full line of appliances.
- Use and maintenance procedures.
- Accessory and repair parts sales.
- Referrals to local dealers, repair parts distributors and service companies. KitchenAid Canada designated service technicians are trained to fulfill the product warranty and provide after-warranty service, anywhere in Canada.

For further assistance

If you need further assistance, you can write to KitchenAid Canada with any questions or concerns at:

Customer Interaction Centre
KitchenAid Canada
1901 Minnesota Court
Mississauga, Ontario L5N 3A7

Please include a daytime phone number in your correspondence.

KITCHENAID® BUILT-IN OVEN & MICROWAVE WARRANTY

LIMITED WARRANTY

For one year from the date of purchase, when this major appliance is operated and maintained according to instructions attached to or furnished with the product, KitchenAid brand of Whirlpool Corporation or Whirlpool Canada LP (hereafter "KitchenAid") will pay for Factory Specified Parts and repair labor to correct defects in materials or workmanship. Service must be provided by a KitchenAid designated service company. This limited warranty is valid only in the United States or Canada and applies only when the major appliance is used in the country in which it was purchased. Outside the 50 United States and Canada, this limited warranty does not apply. Proof of original purchase date is required to obtain service under this limited warranty.

SECOND THROUGH FIFTH YEAR LIMITED WARRANTY ON CERTAIN COMPONENT PARTS

In the second through fifth years from the date of purchase, when this appliance is operated and maintained according to instructions attached to or furnished with the product, KitchenAid will pay for Factory Specified Parts for the following components if defective in materials or workmanship:

- Electric element
- Solid state touch control system parts

SECOND THROUGH TENTH YEAR LIMITED WARRANTY

On microwave ovens only, in the second through tenth years from date of purchase, when this major appliance is operated and maintained according to instructions attached to or furnished with the product, KitchenAid will pay for Factory Specified Parts for the stainless steel oven cavity/inner door if the part rusts through due to defects in materials or workmanship.

ITEMS EXCLUDED FROM WARRANTY

This limited warranty does not cover:

1. Service calls to correct the installation of your major appliance, to instruct you on how to use your major appliance, to replace or repair house fuses, or to correct house wiring or plumbing.
2. Service calls to repair or replace appliance light bulbs, air filters or water filters. Consumable parts are excluded from warranty coverage.
3. Repairs when your major appliance is used for other than normal, single-family household use or when it is used in a manner that is contrary to published user or operator instructions and/or installation instructions.
4. Damage resulting from accident, alteration, misuse, abuse, fire, flood, acts of God, improper installation, installation not in accordance with electrical or plumbing codes, or use of consumables or cleaning products not approved by KitchenAid.
5. Cosmetic damage, including scratches, dents, chips or other damage to the finish of your major appliance, unless such damage results from defects in materials or workmanship and is reported to KitchenAid within 30 days from the date of purchase.
6. Costs associated with the removal from your home of your major appliance for repairs. This major appliance is designed to be repaired in the home and only in-home service is covered by this warranty.
7. Repairs to parts or systems resulting from unauthorized modifications made to the appliance.
8. Expenses for travel and transportation for product service if your major appliance is located in a remote area where service by an authorized KitchenAid servicer is not available.
9. The removal and reinstallation of your major appliance if it is installed in an inaccessible location or is not installed in accordance with published installation instructions.
10. Major appliances with original model/serial numbers that have been removed, altered or cannot be easily determined. This warranty is void if the factory applied serial number has been altered or removed from your major appliance.

The cost of repair or replacement under these excluded circumstances shall be borne by the customer.

DISCLAIMER OF IMPLIED WARRANTIES; LIMITATION OF REMEDIES

CUSTOMER'S SOLE AND EXCLUSIVE REMEDY UNDER THIS LIMITED WARRANTY SHALL BE PRODUCT REPAIR AS PROVIDED HEREIN. IMPLIED WARRANTIES, INCLUDING WARRANTIES OF MERCHANTABILITY OR FITNESS FOR A PARTICULAR PURPOSE, ARE LIMITED TO ONE YEAR OR THE SHORTEST PERIOD ALLOWED BY LAW. KITCHENAID SHALL NOT BE LIABLE FOR INCIDENTAL OR CONSEQUENTIAL DAMAGES. SOME STATES AND PROVINCES DO NOT ALLOW THE EXCLUSION OR LIMITATION OF INCIDENTAL OR CONSEQUENTIAL DAMAGES, OR LIMITATIONS ON THE DURATION OF IMPLIED WARRANTIES OF MERCHANTABILITY OR FITNESS, SO THESE EXCLUSIONS OR LIMITATIONS MAY NOT APPLY TO YOU. THIS WARRANTY GIVES YOU SPECIFIC LEGAL RIGHTS, AND YOU MAY ALSO HAVE OTHER RIGHTS WHICH VARY FROM STATE TO STATE OR PROVINCE TO PROVINCE.

If outside the 50 United States and Canada, contact your authorized KitchenAid dealer to determine if another warranty applies.

If you need service, first see the "Troubleshooting" section of the Use & Care Guide. After checking "Troubleshooting," you may find additional help by checking the "Assistance or Service" section or by calling KitchenAid. In the U.S.A., call **1-800-422-1230**. In Canada, call **1-800-807-6777**.

9/07

Keep this book and your sales slip together for future reference. You must provide proof of purchase or installation date for in-warranty service.

Write down the following information about your major appliance to better help you obtain assistance or service if you ever need it. You will need to know your complete model number and serial number. You can find this information on the model and serial number label located on the product.

Dealer name _____
Address _____
Phone number _____
Model number _____
Serial number _____
Purchase date _____

Free Manuals Download Website

<http://myh66.com>

<http://usermanuals.us>

<http://www.somanuals.com>

<http://www.4manuals.cc>

<http://www.manual-lib.com>

<http://www.404manual.com>

<http://www.luxmanual.com>

<http://aubethermostatmanual.com>

Golf course search by state

<http://golfingnear.com>

Email search by domain

<http://emailbydomain.com>

Auto manuals search

<http://auto.somanuals.com>

TV manuals search

<http://tv.somanuals.com>