

# **KDIX 8810**

## **Instructions for use**



**FOR THE WAY IT'S MADE.®**



<b>Dishwasher safety</b>	<b>4</b>
<b>Before using your dishwasher</b>	<b>5</b>
<b>Precautions and general recommendations</b>	<b>6</b>
<b>Parts and features</b>	<b>7</b>
<b>How to run the scale removal cycle</b>	<b>8</b>
<b>How to test ground fault circuit interrupter (GFCI)</b>	<b>8</b>
<b>Start-up guide</b>	<b>9</b>
<b>Dishwasher loading</b>	<b>10</b>
<b>Washing special items</b>	<b>13</b>
<b>Rinse aid dispenser</b>	<b>14</b>
<b>Detergent use</b>	<b>15</b>
<b>Cycle selection charts</b>	<b>16</b>
<b>Dishwasher care</b>	<b>17</b>
<b>Troubleshooting</b>	<b>19</b>
<b>Assistance or service</b>	<b>21</b>

# Dishwasher safety

## Your safety and the safety of others are very important.

We have provided many important safety messages in this manual and on your appliance. Always read and obey all safety messages.



This is the safety alert symbol.

This symbol alerts you to potential hazards that can kill or hurt you and others.

All safety messages will follow the safety alert symbol and either the word “DANGER” or “WARNING.” These words mean:



**DANGER**

**You can be killed or seriously injured if you don't immediately follow these instructions.**



**WARNING**

**You can be killed or seriously injured if you don't follow these instructions.**

All safety messages will tell you what the potential hazard is, tell you how to reduce the chance of injury, and tell you what can happen if these instructions are not followed.

## IMPORTANT SAFETY INSTRUCTIONS

**WARNING:** When using the dishwasher, follow basic precautions, including the following.

- Read all instructions before using the dishwasher.
- Use the dishwasher only for its intended function.
- Use only detergents or rinse agents recommended for use in a dishwasher, and keep them out of the reach of children.
- When loading items to be washed:
  1. Locate sharp items so that they are not likely to damage the door seal; and
  2. Load sharp knives with the handles up to reduce the risk of cut-type injuries.
- Do not wash plastic items unless they are marked “dishwasher safe” or the equivalent. For plastic items not so marked, check the manufacturer’s recommendations.
- Do not operate the dishwasher unless all enclosure panels are properly in place.
- Do not tamper with controls.
- Do not abuse, sit on, or stand on the door, lid, or dish rack of the dishwasher.
- To reduce the risk of injury, do not allow children to play in or on the dishwasher.
- Under certain conditions, hydrogen gas may be produced in a hot water system that has not been used for two weeks or more. **HYDROGEN GAS IS EXPLOSIVE.** If the hot water system has not been used for such a period, before using the dishwasher turn on all hot water faucets and let the water flow from each for several minutes. This will release any accumulated hydrogen gas. As the gas is flammable, do not smoke or use an open flame during this time.
- Remove the door or lid to the washing compartment when removing an old dishwasher from service or discarding it.

## SAVE THESE INSTRUCTIONS

# Before using your dishwasher

## 1. Removing the packaging and controls:

- After unpacking, make sure that the dishwasher is undamaged and that the door closes correctly. If in doubt, contact a qualified technician or your local retailer.
- Keep the packaging materials (plastic bags, polystyrene parts, etc.) out of reach of children, as they are potentially dangerous.
- This dishwasher has been factory tested to ensure it functions correctly. Such testing may leave slight water marks that will disappear with the first wash.

## 2. Water and electrical connections:

All water and electrical connections must be carried out by a qualified technician in compliance with the manufacturer's instructions (refer to the enclosed installation booklet) and current local safety regulations. This appliance must only be used in the household for the prescribed uses.

Do not use this dishwasher if it has been damaged in transit. Consult your local retailer or our Customer Care Centre.

(Refer to the separate installation instructions booklet)

## 3. Water inlet and drain:

- Observe any special regulations issued by your local Water Board.  
Water supply pressure: 0,3 - 1,0 MPa.
- Make sure the inlet and drain hoses are kink-free and are not crushed.
- If the hose length is not sufficient, please contact your local dealer or our Customer Care Centre.
- The inlet hose must be securely clamped to the water tap to prevent leaks.
- The inlet water temperature varies according to the model installed. Inlet hose marked "25°C

Max": maximum temperature 25°C.

All other models: maximum temperature 60°C.

- When installing the appliance, make sure the drain water discharges correctly (if necessary, remove drain filter).
- After installation check leak tightness all water connections. Leaky connection can damage your home caused by flooding.

## 4. Electrical connection:

- Closely adhere to local Electricity Board regulations.
- Voltage information is shown on the rating plate mounted inside the door on the right hand side.
- The appliance must be grounded as prescribed by law.
- Do not use extension leads or multiple adapters.
- Before carrying out maintenance, disconnect the mains plug.
- If necessary, the power cable may be replaced with one the same obtained from our After-Sales Service via our Customer Care Centre. The power cable must only be replaced by a qualified technician.

## EC Declaration of conformity

This appliance has been designed, constructed and distributed in compliance with the safety requirements of these EC Directives:

- the safety objectives of Low Voltage Directive 2006/95/EC (replacing 73/23/EEC and subsequent amendments);
- 89/336/EEC
- 93/68/EEC



## Load capacity:

5 place settings according EN 50242.

# Precautions and general recommendations



## 1. Packing:

- The packing box may be fully recycled as confirmed by the recycling symbol .

## 2. Energy and water saving tips:

- Do not rinse crockery under running water.
- Always fully load the dishwasher before switching on.
- If ecological energy sources are available such as solar panel heating, heat pumps or centralised heating systems, the appliance may be connected to the hot water mains up to a maximum temperature of 60°C. Ensure the water inlet hose is of the correct type. Refer to the “Connections” chapter in these user instructions.

## 3. Disposal:

This appliance is built from reusable materials. If you decide to scrap the dishwasher, it must be disposed of in compliance with local waste disposal laws. Before scrapping, cut off the power cable so that the appliance cannot be connected to the mains.

- To prevent situations of potential danger to children (e.g. danger of suffocation), break the lock of the door so that it can no longer be closed.

## 4. Child safety:

- Children must not be allowed to play with this dishwasher.
- Store all detergents and rinse aid in a dry place out of the reach of children.

## 5. Safety warnings:

- Do not use solvents inside the dishwasher: **risk of explosion!**
- Sharp knives and forks must be placed in the cutlery basket. Long-handled utensils must be arranged horizontally, with the sharp end facing away from the front of the appliance.
- Before cleaning or carrying out maintenance, switch off the appliance, disconnect the mains plug and turn off the water tap.
- If a fault occurs, switch off the appliance and turn off the water tap.

- On completion of the programme switch off the dishwasher and turn off the water tap.
- Repairs and technical modifications must be carried out exclusively by a qualified technician.
- The water in the dishwasher is not drinkable.
- Do not store inflammable liquids near the dishwasher.
- Do not operate the appliance in the open air.
- Attention: Danger be careful of hot steam escaping when the door is opened.

## 6. Resistance to frost

- If this appliance is placed in surroundings exposed to the risk of frost, it must be drained completely. Turn off the water tap, remove the flexible inlet hoses, outlet pipes and drain filter, and allow all the water run out.

## 7. This appliance must be used at temperatures between 5°C and 45°C.

This appliance is marked according to the European directive 2002/96/EC on Waste Electrical and Electronic Equipment (WEEE). By ensuring this product is disposed of correctly, you will help prevent potential negative consequences for the environment and human health, which could otherwise be caused by inappropriate waste handling of this product.



The symbol  on the product, or on the documents accompanying the product, indicates that this appliance may not be treated as household waste. Instead it should be handed over to the applicable collection point for the recycling of electrical and electronic equipment. Disposal must be carried out in accordance with local environmental regulations for waste disposal.

For more detailed information about treatment, recovery and recycling of this product, please contact your Local Authority, or the shop where you purchased the product.

## Parts and features

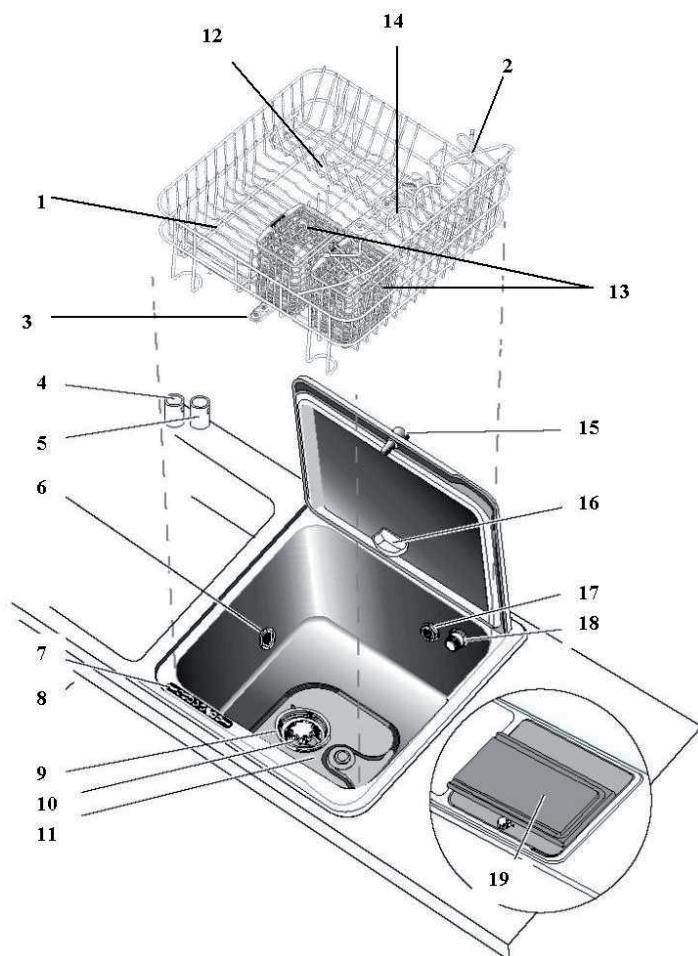

- |                        |                                  |                         |
|------------------------|----------------------------------|-------------------------|
| 1. Large rack insert   | 7. Control panel                 | 14. Small rack insert   |
| 2. Fold-down cup shelf | 8. Model and serial number label | 15. Lid knob latch      |
| 3. Spray arm           | 9. Drain screen basket           | 16. Detergent cup       |
| 4. Drain air gap       | 10. Drain stopper                | 17. Rinse aid dispenser |
| 5. Fill air gap        | 11. Drain fine screen            | 18. Rinse aid fill      |
| 6. Water inlet opening | 12. Medium rack insert           | 19. Wood cutting board  |
|                        | 13. Cutlery basket               |                         |

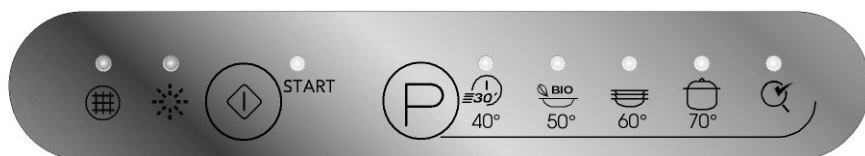

### Control Panel

# How to run the scale removal cycle

## Starting scale removal cycle

It is important to run the scale removal cycle where the appliance is used in areas of hard or very hard water. An LED (shown below) will light up to remind you to run the scale removal cycle every 30 cycles. There is variety of products which could be used to remove scale, dirt and grease (f.e. Calgonit). Please follow the detergent manufacturer's instructions.



## How to turn off the LED

To turn off the LED press the start button for 3 seconds whilst in programme selection mode. We recommend that switching off this LED just before starting the Scale removal cycle.

# How to test ground fault circuit interrupter (GFCI)

This product is provided with a Ground Fault Circuit Interrupter (GFCI) located on the front base of the dishwasher inside the cabinet. A GFCI is designed to protect you against the dangers of line to ground electrical faults. If the appliance develops a fault of this type, the GFCI is designed to disconnect the power to the appliance. This is a built-in safety feature. The GFCI should be tested once a month.

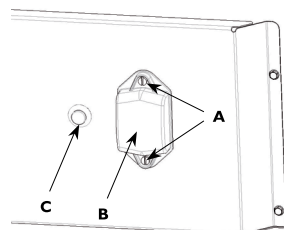

## GFCI test procedure: this MUST be done once a month.

1. Unscrew two bolts (A) and remove GFCI cover (B) located on the front base of the dishwasher inside the cabinet.
2. Make sure that indicator (D) is in "I" position.
3. Turn on dishwasher if it is off – press main switch (C) to "on" position (LED's are lighting).
4. Press TEST button (E). Indicator should switch into "0" position.
5. Switch back indicator into "I" position.
6. Replace the GFCI cover and screw down two bolts.

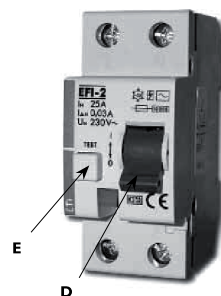

**NOTE:** If the GFCI fails this test, do not use this dishwasher. Please call the Customer Care Centre immediately.

## GROUNDING INSTRUCTIONS

- For a grounded, cord-connected dishwasher:  
The dishwasher must be grounded. In the event of a malfunction or breakdown, grounding will reduce the risk of electric shock by providing a path of least resistance for electric current. The dishwasher is equipped with a cord having an equipment-grounding conductor and a grounding plug. The plug must be plugged into an appropriate outlet that is installed and grounded in accordance with all local codes and ordinances.  
**WARNING:** Improper connection of the equipment-grounding conductor can result in a risk of electric shock. Check with a qualified

- electrician or service representative if you are in doubt whether the dishwasher is properly grounded. Do not modify the plug provided with the dishwasher; if it will not fit the outlet, have a proper outlet installed by a qualified electrician.
- For a permanently connected dishwasher:  
The dishwasher must be connected to a grounded metal, permanent wiring system, or an equipment-grounding conductor must be run with the circuit conductors and connected to the equipment-grounding terminal or lead on the dishwasher.

**SAVE THESE INSTRUCTIONS**



## Start-up guide

Before using your dishwasher, remove all packaging materials. Read this entire Use and Care Guide. You will find important safety information and useful operating tips.

### Using Dishwasher

1. Rinse aid is essential for good drying. Be sure to fill the dispenser before you use your new dishwasher. Each filling will last about 1 to 3 months depending on your usage. (See "Rinse Aid Dispenser.")



2. Scrape large food soil and hard items (toothpicks or bones) from dishes.
3. Check and clean drain assembly screens. (See "Cleaning.")



4. Insert the drain stopper and turn clockwise one-quarter turn to close.



5. Load the dishwasher. (See "Dishwasher Loading." for hints and tips) Load dishes with space in between them so that water can reach the soiled surfaces. Ensure nothing prevents the spray arm(s) from spinning freely.

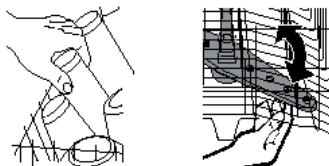

6. Add detergent and check the rinse aid dispenser. Add rinse aid if needed. (See "Detergent Use.")



7. Press the desired cycle and option selections on the top of the dishwasher opening.

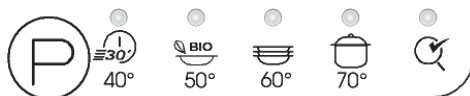

8. Press the Start pad on the top of the dishwasher opening. The LEDs on the control panel will illuminate.



9. Push lid firmly closed. Turn lid knob to lock shut.

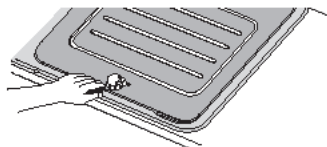

If the lid is opened during the cycle, the cycle will stop. Close the lid firmly and the cycle will continue.

10. The lid opens automatically at the end of the cycle.

**NOTE:** Do not place anything on the dishwasher lid whilst running a cycle.

### Using Dishwasher As a Sink

When you need more sink area, remove the rack and spray arm completely

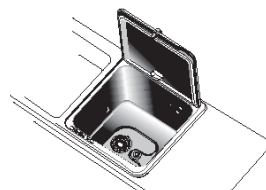

#### To open drain

Turn the drain stopper one-quarter turn counter clockwise and lift to allow water to drain.

#### To close drain

- Insert drain stopper so it aligns and drops down to seal against the drain.
- Turn clockwise one-quarter turn to lock it into place.

**NOTE:** Do not completely fill the dishwasher when using it as a sink. Make sure the sink is completely drained before using it again as a dishwasher.

# Dishwasher loading

## LOADING SUGGESTIONS

- Remove leftover foods, bones, toothpicks and other hard items from the dishes. To conserve water, energy and save time it is not necessary to rinse dishes before putting them into the dishwasher.
- It is important for the water spray to reach all soiled surfaces.
- Load dishes so they are not stacked or overlapping if possible. For best drying results, water must be able to drain from all surfaces.
- Load heavy pots and pans carefully. Heavy items can dent the stainless steel interior if they are dropped!
- Ensure pot lids and handles, etc., do not interfere with the spray arm rotation.
- Conserve water, energy and save time over hand rinsing by running a rinse cycle to keep dishes moist if you do not plan to wash them straight away. Foods like eggs, rice, pasta, spinach, and cooked cereals may be hard to remove if they are left to dry over a period of time.

## Quiet operating tips

To avoid thumping/clattering noises during operation:

- Ensure lightweight items are held securely in the rack.
- Ensure pot lids and handles, etc., do not touch interior walls or interfere with the rotation of the spray arm.
- Load dishes so they do not touch one another.

## LOADING RACK

This rack is designed for cups, glasses, plates, pans, casseroles and utensils. Many items, up to 28 cm (11 in), will fit in the rack.

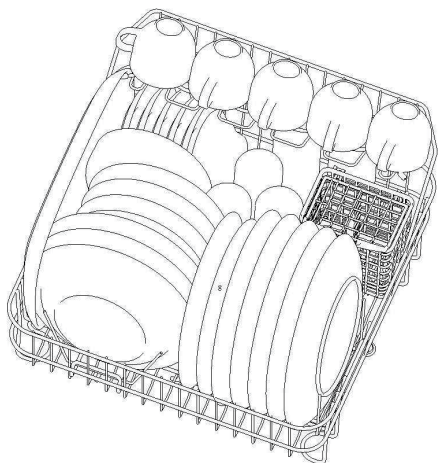

- Place items upper surfaces down for cleaning and draining.
- China, crystal and other delicate items must not touch each other during dishwasher operation, or damage may occur.
- Load small items in the rack securely.
- Load plastic items so the force of the spray arm does not move them during the cycle. Only wash plastic items marked "Dishwasher safe".
- To avoid chipping, do not let stemware touch other items.
- Small bowls, pans and other utensils can be placed in the rack. Load bowls in the centre section for stability.
- Load plates, soup bowls, etc., between tines.
- Overlap the edges of plates for large loads.
- Load soup, cereal and serving bowls in the rack in a variety of ways depending upon their size and shape. Load bowls securely between the rows of tines. Do not 'nest' bowls together as the spray will not reach all surfaces.
- Load cake tins and other large items at the side and front only as loading such items at the back can keep the water spray from reaching the Rinse Aid Dispenser.
- Place heavily soiled cookware face down in the rack.
- Ensure pot handles and other items do not stop rotation of the spray arm. The spray arm must rotate freely.
- Do not load items between the rack and the left side of the dishwasher tub as they might block the water inlet opening.

## Fold-Down Cup Shelf

Fold down the cup shelf on the rack front to hold additional cups, stemware or long items such as utensils and spatulas. Fold up when you need room for larger items in the main rack.

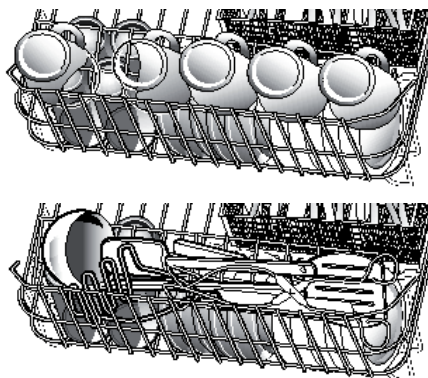

# Dishwasher loading

## Removable Rack Inserts

The large, medium and small removable rack inserts (see "Parts and Features" section) allows you to adjust the rack depending on the type of load you are washing. You can remove, or move the inserts to customize the rack for a particular load. This is useful when washing a variety of dishes, pots and pans or roasting tins.

### To remove insert

Lift up on insert handle and lift insert out of rack.

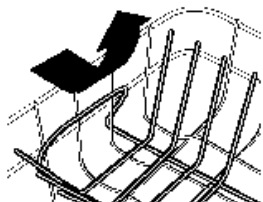

### To install insert

Place the insert end legs under the rack cross wire.

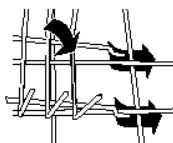

Push down until handle fits against outer rack edge.

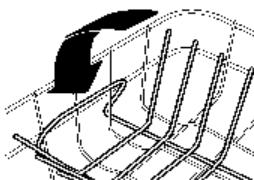

## Extra-large wood cutting board

The movable cutting board allows you to decide the best location for food preparation. Use the cutting board on the dishwasher closed lid or any other location you choose.

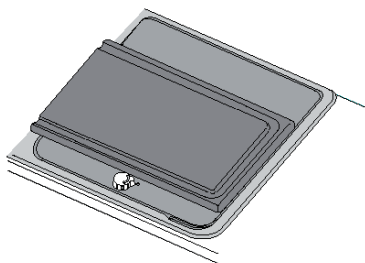

## NOTE:

Remove the cutting board before running a cycle. Leaving the cutting board on the lid can keep the lid from opening at the end of the cycle, reducing drying performance. See "Cleaning" for care instructions.

## LOADING CUTLERY BASKET

Load the cutlery basket while it is in the rack or take the basket out for loading on a counter or table.

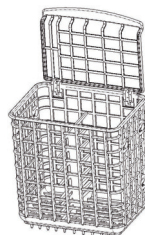

Place the cutlery in each section of the basket with some pointing up and some pointing down to avoid 'nesting'. Spray cannot reach 'nested' items.

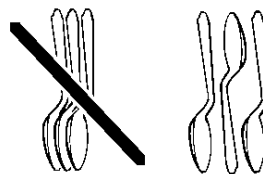

## IMPORTANT:

Always load sharp items (knives, skewers, etc.) pointing down.

## NOTES:

- Do not load silver or silver-plated silverware with stainless steel. These metals can be damaged by contact with each other during washing cycle.
- Some foods (such as salt, vinegar, milk products, fruit juices, etc.) can pit or corrode silverware. Run a rinse cycle if you do not have a full load to wash immediately.

## IN-SINK DISHWASHER WASH SYSTEM

The three-level wash system provides excellent cleaning results. Three levels of filtration filter the wash water and prevent food particles from being re-deposited back onto the dishes.

- A coarse strainer as part of the drain stopper assembly, prevents bones and other large objects from entering the pump system.

## Dishwasher loading

- Items small enough to pass through the coarse strainer are caught in the drain screen basket.
- The wash water continuously flows through the drain fine screen filter, trapping food particles.

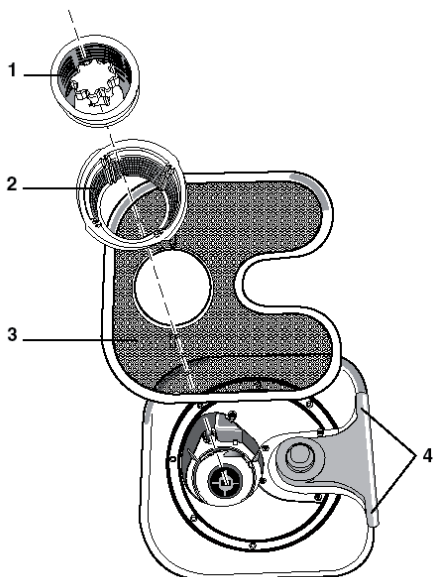

1. Drain stopper assembly with coarse strainer
2. Drain screen basket
3. Fine filter screen
4. Fine screen filter holder

- Two water jets, located under the spray arm, remove the food particles from the Drain fine screen filter.

### NOTE:

Before each wash load, check the coarse strainer, the drain screen basket and the fine screen filter removing any objects and soil particles. Also check the spray arm, it should rotate easily.

### DRYING SYSTEM

The In-sink dishwasher wash system features FLASHDRY instant drying. At the end of the cycle, the lid automatically pops open and vapour escapes. This results in fast, efficient drying of your dishes.

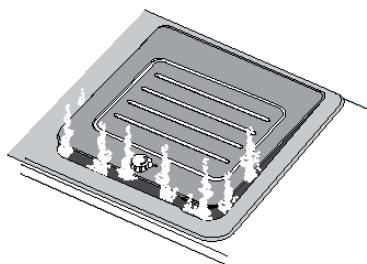

### IMPORTANT:

The vapour is hot. Do not touch the lid opening during drying. Do not place anything on top of the lid when running a cycle.

# Washing special items

If you have doubts about washing a particular item, check with the manufacturer to see if it is dishwasher safe.

Material	Dishwasher safe?/Comments
Aluminium	<b>Yes</b> High water temperature and detergents can affect finish of anodized aluminium.
Disposable Aluminium	<b>No</b> Do not wash throwaway aluminium pans in the dishwasher. These might shift during washing and transfer black marks to dishes and other items.
Bottles and Cans	<b>No</b> Wash bottles and cans by hand. Labels attached with glue can loosen and clog the spray arm or pump and reduce washing performance.
Cast Iron	<b>No</b> 'Seasoning' will be removed and the iron will rust.
China/Stoneware	<b>Yes</b> Always check manufacturer's recommendations before washing. Antique, hand-painted or over-the-glaze patterns may fade. Gold leaf can discolour or fade.
Crystal	<b>Yes</b> Check manufacturer's recommendations before washing. Some types of lead crystal can etch with repeated
Gold	<b>No</b> Gold-coloured flatware will discolour.
Glass	<b>Yes</b> Milk glass yellows with repeated dishwasher washing.

Material	Dishwasher safe?/Comments
Hollow-Handle Knives	<b>No</b> Handles of some knives are attached to the blade with adhesives which can loosen if washed in the dishwasher.
Pewter, Brass, Bronze	<b>No</b> High water temperatures and detergent can discolour or pit the finish.
Disposable Plastics	<b>No</b> Cannot withstand high water temperatures and detergents.
Plastics	<b>Yes</b> Always check manufacturer's recommendations before washing. Plastics vary in their capacity to withstand high temperatures and detergents. Load plastics in top rack only.
Stainless Steel	<b>Yes</b> Run a rinse cycle if not washing immediately. Prolonged contact with food containing salt, vinegar, milk products or fruit juice can damage finish.
Sterling Silver or Silver Plate	<b>Yes</b> Run a rinse cycle if not washing immediately. Prolonged contact with food containing salt, acid or sulfide (eggs, mayonnaise and seafood) can damage finish.
Tin	<b>No</b> Can rust
Wooden Ware	<b>No</b> Wash by hand. Always check. Untreated wood can warp, crack or lose its finish

## Rinse aid dispenser

Rinse aids prevent water from forming small droplets that can dry as spots or streaks. They also improve drying by allowing water to drain off of the dishes during the final rinse by releasing a small amount of the rinse aid into the rinse water. Your dishwasher is designed to use a liquid rinse aid. Do not use a solid or bar-type. If you use "4 in 1" tablets (with rinse aid) do not fill rinse aid dispenser.

### Filling the dispenser

The rinse aid dispenser holds 100 ml of rinse aid. Under normal conditions, this will last for about 3 months. You do not have to wait until the dispenser is empty to refill it. Try to keep it full, but be careful not to overfill it.

1. Make sure the dishwasher lid is fully open.  
Locate the rinse aid fill on the right-hand side of the dishwasher back wall.



Rinse aid dispenser



Rinse aid fill

2. Open the rinse aid fill by unscrewing the cap.



3. Add rinse aid until container is full.



4. Clean up any spilled rinse aid with a damp cloth.
5. Replace the cap and tighten.



### Rinse Aid Empty indicator

When the Rinse Aid Empty indicator is lit on the control panel, you need to refill the rinse aid. If you are using 4in1 tablets do not fill rinse aid dispenser. Tablets contain enough rinse aid.



## Detergent use

The detergent cup, located on the inside of the dishwasher lid, empties detergent into the dishwasher when you close the lid.

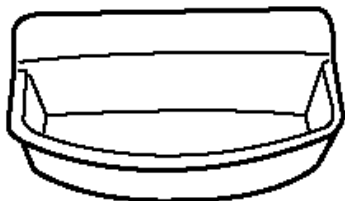

- Use dishwashing detergent only. Other detergents can produce excessive suds and foaming that overflow out of the dishwasher, reducing washing performance.
- Add detergent just before starting a cycle.
- Store detergent in a tightly closed container in a cool, dry place. Using fresh, automatic dishwasher detergent results in better cleaning.
- The use of tablets is approved for this dishwasher. We recommended the use of “3 in 1” or “4 in 1” tablets. For “4 in 1” tablets see “Rinse Aid Dispenser” section.

### How much detergent to use

- The amount of detergent to use depends on the hardness of your water and the type of detergent. If you use too little, dishes won't be clean. If you use too much in soft water, glassware will etch.
- Water hardness can change over a period of time. Find out your water's hardness by asking your local water department, water softener company, or county extension agent.
- Different brands of dishwasher detergent have different amounts of phosphorus for softening water. If you have hard water and use a detergent with a phosphorous content of less than 8.7%, you might need to use more detergent, or use a detergent with a phosphorous content higher than 8.7%.

### Water Hardness

#### Soft to Medium Hard Water

0 to 6 grains per gallon  
(0 to 5,75° n)

### Amount of Detergent

#### For normally-soiled loads



- Add 2 tsp or 10g

#### For heavily-soiled loads

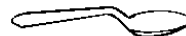

- Add 1 Tbsp or 15g

#### Medium to Hard Water

(5,75 to 11,5° n)

#### For normally and heavily-soiled loads

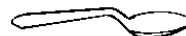

- Add 1 Tbsp or 15g

#### Very Hard Water

(11,6° n and above)  
For normally and heavily-soiled loads

#### For normally and heavily-soiled loads

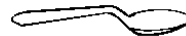

- Add 1 Tbsp or 15g

**NOTE:** Fill amounts shown are for standard powdered detergent. Amounts may vary if you use liquid or concentrated powdered detergent. Follow instructions on the package when using liquid dishwasher detergent or concentrated powdered detergent.

For best cleaning and drying results we recommend using 3in1 or 4in1 tablets.

## Cycle selection charts

Select the wash cycle and option desired or press Start pad to repeat the same cycle and option as the previous cycle.

**NOTE:**

If the last cycle you completed was a rinse cycle, the dishwasher will run the last full wash cycle and option that you selected when you press the Start pad.

A “•” shows what steps are in each cycle.

Temperatures indicate where extra heat is added.

Water usage is shown in litres.

Cycle time includes drying time. An asterisk (\*) by the cycle time indicates the cycle time will be longer depending on the temperature of water entering the dishwasher. The cooler the water, the longer the cycle time.



Main Wash	Rinse	Final Heated Rinse	Energy Consumption (kWh)	Time (min)	Water Usage (L)
•	•	•	0,96	129	11,2



Main Wash	Rinse	Final Heated Rinse	Energy Consumption (kWh)	Time (min)	Water Usage (L)
•	•	•	0,44	30	11,2



Main Wash	Rinse	Final Heated Rinse	Energy Consumption (kWh)	Time (min)	Water Usage (L)
•	•	•	1,08	137	14,7



Main Wash	Rinse	Final Heated Rinse	Energy Consumption (kWh)	Time (min)	Water Usage (L)
•	•	•	0,74	165	10,2



Main Wash	Rinse	Final Heated Rinse	Energy Consumption (kWh)	Time (min)	Water Usage (L)
•	•	•	1,04	115	11,2



## Dishwasher care

### CLEANING

Before cleaning or carrying out maintenance, switch off the appliance, disconnecting the mains plug and turn off the water tap.

#### Cleaning the drain screen assembly

Before each wash load, check the coarse strainer, the drain screen basket and the drain fine screen filter and remove any objects and soil particles.

#### To remove the drain screen assembly for cleaning

1. Turn the handle one-quarter turn to the left to release and lift up. Clean basket.
2. Turn the drain screen basket to the left until you feel release and lift up. Clean the screen.
3. Lift the fine filter screen up and slide right edges out of the holder. Clean screen.

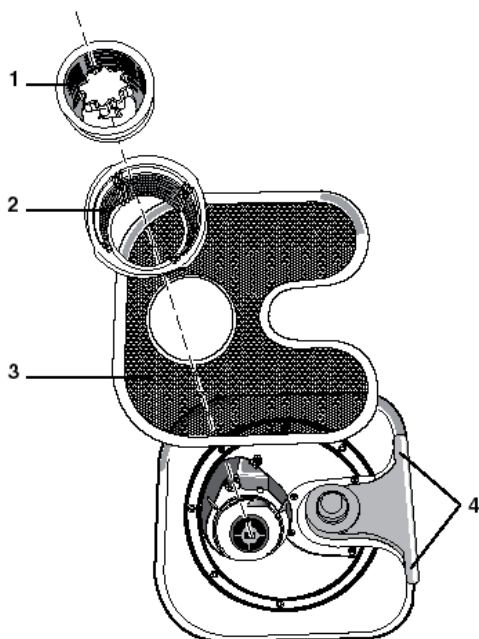

1. Drain stopper assembly with coarse strainer
2. Drain screen basket
3. Fine filter screen
4. Fine screen filter holder

#### To install the drain screen assembly after cleaning

1. Slide the right edge of the fine filter screen under the holders in the floor of the dishwasher and move into position.

2. Insert the drain screen basket into the opening and turn to the right slightly until it locks into position.
3. Install the drain stopper assembly until it drops into position and turn one-quarter turn clockwise to lock into place.

#### Cleaning the exterior

In most cases, regular use of a soft, damp cloth or sponge and a mild detergent is all that is necessary to keep the outside of your dishwasher looking nice and clean.



#### To clean the wooden cutting board

Wash in warm, soapy water and dry completely. Oil frequently with a mineral or a linseed oil, following the instructions on the container.

#### NOTES:

- Never put wood in the dishwasher or microwave.
- Never soak.
- Avoid extremes in temperatures--do not plunge into very hot water or store in the refrigerator.

#### Cleaning the interior

Hard water minerals can cause a chalky white film to build up on the inside surfaces, especially just beneath the lid area.

Do not clean the dishwasher interior until it has cooled down. Wear rubber gloves. Do not use any type of cleanser other than dishwasher detergent as it may cause excess suds or foaming.

## Dishwasher care

### To clean the interior

Make a paste with powdered dishwasher detergent on a damp sponge and clean.

### OR

Use liquid automatic dishwasher detergent and clean with a damp sponge.

### OR

See the vinegar rinse procedure in “Spotting and filming on dishes” in “Troubleshooting.”

**NOTE:** Run a Normal cycle with detergent after cleaning the interior.

### DRAIN AIR GAP

Check the drain air gap any time the dishwasher isn't draining well.

If a drain is clogged, the drain air gap protects your dishwasher from water backing up into it. If there is leakage from air gap check connection of dishwasher to water-pipe network (See Installation Instructions).

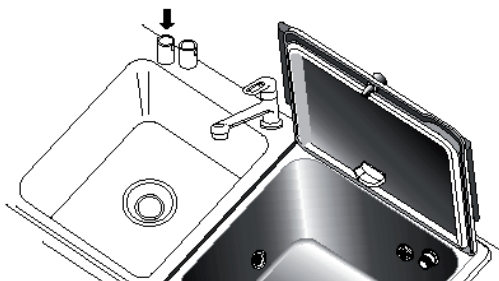

### To clean the drain air gap

Clean the drain air gap periodically to ensure proper drainage of your dishwasher. Lift off the outer cover. Unscrew the plastic cap. Then check for any soil build-up. Clean if necessary.

**NOTE:** The fill air gap is located to the right of the drain air gap and does not require maintenance.

### STORING

#### Storing for the summer

Protect your dishwasher during the summer months by turning off the water supply and power supply to the dishwasher.

#### 'Winterising' your dishwasher

Protect your dishwasher and home against water damage due to freezing water lines. If your dishwasher is left in a seasonal dwelling, or could be exposed to near freezing temperatures, have your dishwasher winterised by contacting our Customer care Centre.

# Troubleshooting

First try the solutions suggested here and possibly avoid the cost of a service call...

## DISHWASHER IS NOT OPERATING PROPERLY

### Dishwasher does not run or stops during a cycle

- Is the lid closed tightly and latched?
- Is the right cycle selected? Refer to the “Cycle Selection Charts”.
- Is there power to the dishwasher? Has a household fuse blown or circuit breaker tripped?
- Has the Ground Fault Circuit Interrupter (GFCI) tripped? Indicator should be in “I” position (See “How to test Ground Fault Circuit Interrupter (GFCI)” section).
- Has the motor stopped due to an overload? The motor automatically resets itself within a few minutes. If it does not restart, call for service.
- Is the Drain stopper closed? If it is not closed properly, water indicator indicates there is no water in dishwasher. Failure mode is activated (See Service Instruction”). Reset program, install Drain stopper properly and restart program.

### Dishwasher will not fill

- Is the water shut-off valve (if installed) turned on?

### Dishwasher seems to run too long

- Is the water supplied to the dishwasher hot enough? The dishwasher runs longer while heating water
- A delay automatically occurs in some wash and rinse cycles until the water reaches the proper temperature.

### Water remains in the dishwasher

- Is the cycle complete

### Odour in the dishwasher

- Are dishes washed only every 2 or 3 days? Run a rinse cycle once or twice a day until you have a full load.

## DISHES ARE NOT COMPLETELY CLEAN

### Food soil left on the dishes

- Is the dishwasher loaded correctly? Refer to the “Dishwasher Loading” section.
- Is the water temperature too low? For best dishwashing results, water should be 49°C (120°F) as it enters the dishwasher.
- Did you use the correct amount of fresh detergent? Use recommended dishwasher detergents only. For best results use “3 in 1” or “4 in 1” tablets. Refer to the “Detergent Use” section.
- Is the pump or spray arm clogged by labels from bottles and cans? If you wash bottles and cans in your dishwasher, check for labels clogging the pump or spray arm.
- Are high suds slowing the wash arm? Never use soap or laundry detergents. Use recommended dishwasher detergents only.

## SPOTS AND STAINS ON DISHES

### Spotting and filming on dishes

- Is your water hard or is there a high mineral content in your water? Conditioning the final rinse water with a liquid rinse aid helps eliminate spotting and filming. Keep the rinse aid dispenser filled or use “4 in 1” tablets (try to avoid using “4 in 1” tablets and filled rinse aid dispenser).
- Is the water temperature too low? For best dishwashing results, water should be 49°C (120°F) as it enters the dishwasher.

### NOTE:

To remove spots and film from dishes, try a white vinegar rinse. The procedure is intended for occasional use only. Vinegar is an acid and using it too often could damage your dishwasher.

1. Wash and rinse dishes. Remove all silverware or metal items.
2. Put 1 cup (250 ml) white vinegar in a glass or dishwasher-safe measuring cup on the rack.
3. Run the dishwasher through a complete washing cycle. Do not use detergent. Vinegar will mix with the wash water.

# Troubleshooting

## **Silica film or etching (silica film is a milky, rainbow-coloured deposit; etching is a cloudy film)**

Sometimes there is a water/chemical reaction with certain types of glassware. This is usually caused by some combination of soft or softened water, alkaline washing solutions, insufficient rinsing, overloading the dishwasher and the heat of drying. It might not be possible to prevent the problem, except by hand washing.

To slow this process use a minimum amount of detergent but not less than 1 tsp (5g) per load. Use a liquid rinse aid and under load the dishwasher to allow thorough rinsing. Silica film and etching are permanent and cannot be removed.

## **White spots on cookware with non-stick finish**

Has the dishwasher detergent removed cookware seasoning? Re-season cookware after washing in the dishwasher.

## **Brown stains on dishes and dishwasher interior**

Does your water have high iron content? Rewash dishes using 1-3tsp (5-15g) of citric acid crystals added to the covered section of the detergent dispenser. Do not use detergent. Follow with a Eco wash cycle with detergent. If treatment is needed more often than every other month, the installation of an iron removal unit is recommended.

## **Black or grey marks on dishes**

Are aluminium items rubbing dishes during washing? Disposable aluminium items can break down in the dishwasher and cause marking. Handwash these items. Remove aluminium markings by using a mild abrasive cleaner.

## **Orange stains on plastic dishes or dishwasher interior**

Are large amounts of tomato-based foods on dishes placed in the dishwasher? Stains gradually fade over time. Stains will not affect dishwasher performance. Regular use of a rinse cycle will reduce the likelihood of staining.

## **DISHES DO NOT DRY COMPLETELY**

### **Dishes are not dry**

- Did you load your dishwasher to allow proper water drainage? Do not overload. Refer to the "Dishwasher Loading" section. Use a liquid rinse aid to speed drying.
- Are the plastics wet? Plastics often need towel drying.
- Is the rinse aid dispenser empty? Refer to the "Rinse Aid Dispenser" section.

## **DISHES ARE DAMAGED DURING A CYCLE**

### **Chipping of dishes**

Did you load the dishwasher properly? Load the dishes and glasses so they are stable and do not strike together from washing action.

### **NOTE:**

Antiques, feather-edged crystal and similar types of china and glassware might be too delicate for automatic dishwashing. Wash by hand.

## **SCRATCHES**

### **Minor scratches on the surface of the sink or dishwasher**

Scouring with a mild abrasive kitchen cleaner in the direction of the grain lines will blend scratches into the finish of the sink.

## Assistance or service

Before calling for assistance or service, please check “Troubleshooting”. It may save you the cost of a service call. If you still need help, follow the instruction below.

When calling, please know the purchase date and the complete model and serial number of your appliance. This information will help us to better respond to your request.

### If you need replacement parts

If you need to order replacement parts, we recommended that you only use factory specified parts. These parts will fit right and work right, because they are made with the same precision used to build every new KITCHENAID® appliance. To locate factory specified replacement parts in your area, contact the Customer Care Centre.

### Our consultants provide assistance with:

- Features and specifications on our full line of appliances.
- Installation information.
- Use and maintenance procedures.
- Accessory and repair parts sales.
- Specialised customer assistance.
- Referrals to local dealers, repair parts distributors and service companies. KitchenAid designated service technicians are trained to fulfil the product warranty and provide after-warranty service.

**SERVICE** 0000 000 00000







Printed in Italy

 07/07

**5019 709 02004**



Download from [Www.Somanuals.com](http://www.Somanuals.com). All Manuals Search And Download.



## Free Manuals Download Website

<http://myh66.com>

<http://usermanuals.us>

<http://www.somanuals.com>

<http://www.4manuals.cc>

<http://www.manual-lib.com>

<http://www.404manual.com>

<http://www.luxmanual.com>

<http://aubethermostatmanual.com>

Golf course search by state

<http://golfingnear.com>

Email search by domain

<http://emailbydomain.com>

Auto manuals search

<http://auto.somanuals.com>

TV manuals search

<http://tv.somanuals.com>