

KitchenAid®

FOR THE WAY IT'S MADE.

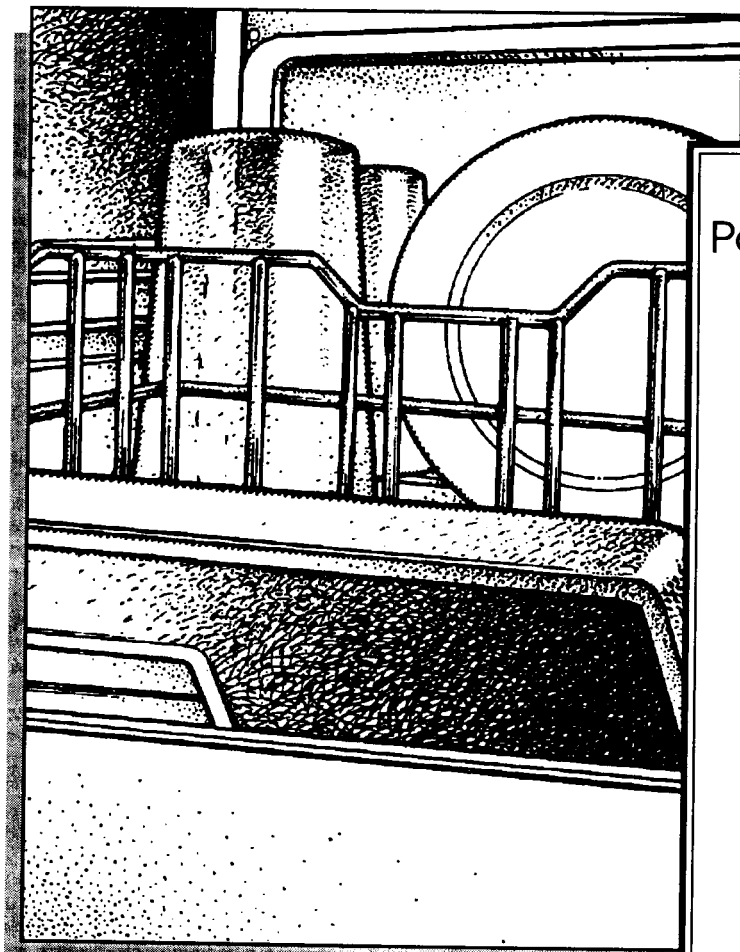

KitchenAid®

Portable/Undercounter Dishwashers

Models KPDJ630Y KUDJ230Y
KUDJ23HY

A Note To You 2

Important Safety
Instructions 3

Parts And Features 4

Connecting Portable
KPDJ630Y 5

Operating Your Dishwasher . 8

Caring For Your
Dishwasher 17

Changing Front Panels 19

Common Dishwashing
Problems 22

If You Need Assistance
Or Service 25

Warranty 28

Call Us With Questions
Or Comments:

1-800-422-1230

Use and Care Guide

A Note To You

Thank you for buying a KitchenAid home appliance.

You have purchased a quality, *world-class* home appliance. Years of engineering experience have gone into its manufacturing. To ensure that you will enjoy many years of trouble-free operation, we have developed this Use and Care Guide. It is full of valuable information on how to operate and maintain your home appliance properly and safely. Please read it carefully. Also, please complete and mail the Ownership Registration Card provided with your home appliance.

Your safety is important to us.

This guide contains safety symbols and statements. Please pay special attention to these symbols and follow any instructions given. Here is a brief explanation of the use of each symbol.

WARNING

This symbol will help alert you to such dangers as personal injury, burns, fire and electrical shock.

CAUTION

This symbol will help you avoid actions which could cause product damage (scratches, dents, etc.) and damage to your personal property.

Our Consumer Assistance Center telephone number, 1-800-422-1230, is toll-free, 24 hours a day.

If you ever have a question concerning your home appliance's operation, or if you need service, feel free to call our toll-free Consumer Assistance Center telephone number for help. When calling, you will need to know your appliance's complete model number and serial number. You can find this information on the model and serial number label (see diagram on page 4). For your convenience, we have included a handy place below for you to record these numbers, as well as purchase information. You will need this information if you ever require service. Keep this book and the sales slip together in a safe place for future reference.

IMPORTANT: You must provide proof of purchase or installation date for in-warranty service.

Model Number _____

Builder/Dealer Name _____

Serial Number _____

Address _____

Date Purchased _____

Phone _____

Date Installed _____

Don't forget, KitchenAid offers a full line of quality home appliances.

Built-In Refrigerators

Trash Compactors

Ranges & Cooktops

Freestanding Refrigerators

Hot Water Dispensers

Microwave Ovens

50-Pound Ice Makers

Food Waste Disposers

Washers & Dryers

Dishwashers

Built-in Ovens

Mixers

For more information on these appliances, or the one you have purchased, call our toll-free Consumer Assistance Center telephone number, 1-800-422-1230.

Important Safety Instructions

⚠ WARNING

To reduce the risk of fire, electrical shock, or injury when using your dishwasher, follow basic precautions including the following:

- Read all instructions before using the dishwasher.
- Use your dishwasher only for the uses described in this manual.
- **DISHWASHER MUST BE ELECTRICALLY GROUNDED.** Read the installation instructions for details.
- When discarding an old dishwasher, always remove the door to prevent accidental entrapment or suffocation.
- Use **ONLY** detergents and rinse agents recommended for use in a dishwasher.
- Store dishwasher detergent in a cool, dry place **WHERE CHILDREN CAN'T REACH IT.**
- When loading items to be washed:
 - Load sharp knives with the handles up to reduce risk of cut-type injuries.
 - Locate sharp items so that they are not likely to damage the door seal.
- **DO NOT** let children play in or on the dishwasher.
- **DO NOT** reach into the area below the bottom rack until the heating element has cooled for at least 20 minutes.
- **DO NOT** wash plastic items unless marked "Dishwasher Safe" or the equivalent. If not marked, check manufacturer's recommendations.
- **DO NOT** use your dishwasher unless all enclosure panels are properly in place.
- **DO NOT** sit on, stand on or abuse the dishwasher door or dish racks.
- **DO NOT** tamper with controls.
- If hot water has not been used recently (usually two weeks or longer), hydrogen gases may build up in the water heater and the hot water pipes. **HYDROGEN GAS IS EXPLOSIVE.** To prevent injury or damage, before using your dishwasher, turn on all hot water faucets and allow water to run for several minutes. This will allow gases to escape. Do not smoke or use any open flame near the faucet while it is open.
- Disconnect electrical power to the dishwasher before attempting to service.
- **DO NOT** store or use gasoline or other flammable vapors and liquids in the vicinity of this or any other appliance. The fumes can create a fire hazard or explosion.

– SAVE THESE INSTRUCTIONS –

Help us help you

Please:

- Have your dishwasher installed by a qualified installer.
- Install where dishwasher is protected from the elements. Protect against possible rupture of fill valve by freezing. Such ruptures are not covered by the warranty. See winter storage information on page 18.
- Install and level dishwasher on a floor that will hold the weight, and in an area suitable for its size and use.
- Properly connect dishwasher to electricity, water and drain.*
- Remove all shipping plugs from hoses and connectors (such as drain connector on a disposer) before installing.*
- Use heavy-duty door springs when installing heavy custom door panels. See page 21.*
- Remove all hang tags and temporary labels.
- Make sure dishwasher is not used by anyone unable to operate it properly.
- Properly maintain dishwasher. See page 17.

*See Installation Instructions for complete information.

Parts And Features

This section contains captioned illustrations of your appliance. Use them to become familiar with the location and appearance of all parts and features.

Your KitchenAid dishwasher is equipped with a unique sound reduction system. The Quiet Scrub™ System is designed to reduce many common sounds heard while a dishwasher is operating.

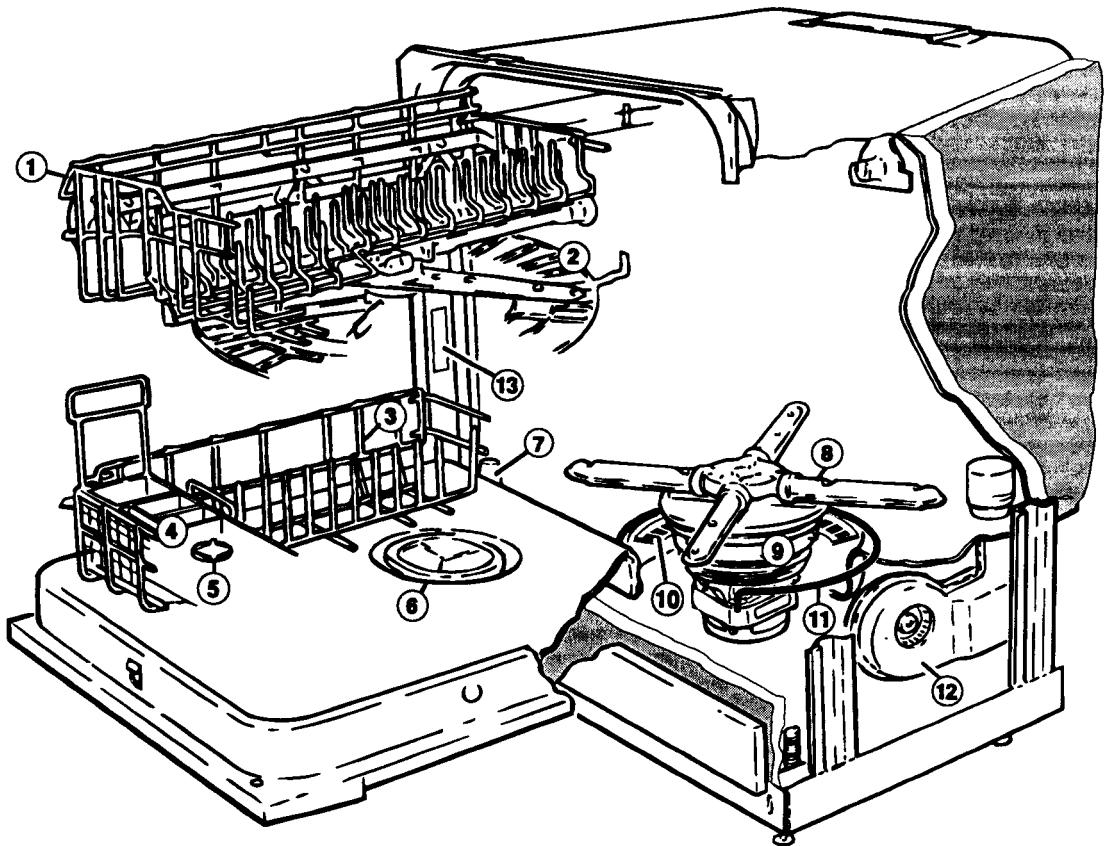

- | | |
|---|--|
| 1. 16-Position adjustable upper rack with Durakote™ nylon | 7. Overflow protection float |
| 2. Upper level power wash with ChinaGuard™ | 8. 4-Way hydro sweep wash |
| 3. Lower rack with Durakote™ nylon | 9. Self-Cleaning filter with jet spray |
| 4. Cutlery/silverware basket | 10. Coarse strainer |
| 5. Automatic rinse agent dispenser | 11. Water-heating element |
| 6. Detergent dispenser | 12. Flo-Thru™ drying fan |
| | 13. Model and serial number label |

Connecting Portable KPDJ630Y

In This Section

	Page	Page	
Installing faucet adapter kit	5	Electrical connection	7
Connecting your dishwasher	6	Care of dishwasher top	7
When cycle is finished	6	Converting to a built-in	7

Portable dishwashers must be connected to a sink faucet and an electrical outlet to operate. They are essentially built-in dishwashers with portable features.

Installing faucet adapter kit

A faucet adapter kit is supplied with your dishwasher. It has all parts necessary to connect the dishwasher coupler to most faucets with external or internal threads. If the adapter cannot be used on your faucet, other adapters may be purchased from your KitchenAid dealer, plumbing supply dealer or hardware store.

Before you begin

Sinks with a spray attachment may require a new hose for the attachment. Back pressure on an old hose may cause the hose to burst. Replace an old spray attachment hose with a new and stronger hose or disconnect the old hose, cap the hose connection and plug the hole in the sink.

CAUTION

Property Damage Hazard

A sink with a spray attachment should have a new spray attachment hose installed. An old hose may burst as a result of back pressure.

Failure to follow these instructions could cause property damage.

- Remove the faucet aerator.

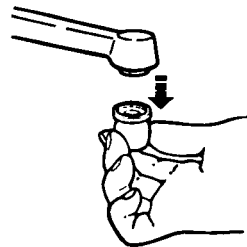

Faucets with external threads

- Screw adapter, furnished in kit, to faucet.

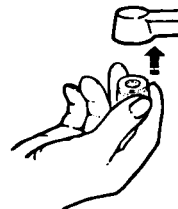

Faucets with internal threads

1. Screw faucet adapter (B) with washers (A & C) to adapter (D).
2. Screw adapter assembly to faucet.

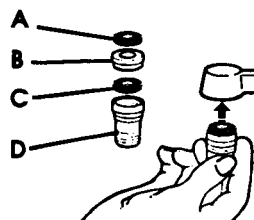

Connecting your dishwasher

When moving your dishwasher, make sure the door is latched. Hold the dishwasher at the top front corners.

1. Run water at faucet until water is hot. Turn off water.
2. Pull hoses out of their storage compartment in back of dishwasher.
3. Pull down on the coupler locking collar and slide the coupler onto the faucet adapter.
4. Release the locking collar when the coupler locks in place on the adapter.
5. Turn the hot water on slowly until it is completely on.
6. Pull power cord from storage compartment in back of dishwasher. Position cord between posts as shown.
7. Connect power cord to grounded outlet. (See "Electrical connection".)
8. See pages 8 and 9 to start the dishwasher.

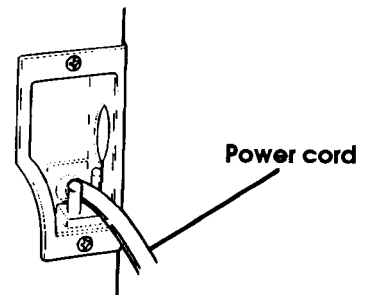
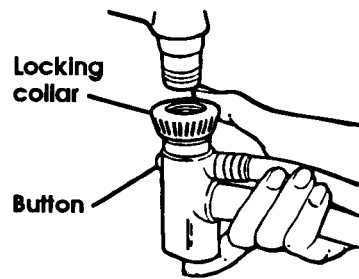

Using faucet

You can draw water from the faucet while the dishwasher is connected. **Do not** draw water while the dishwasher is filling or draining. (This prevents the dishwasher from underfilling and drain water from mixing with fresh water.)

1. Press the side button on coupler to draw water.
2. Adjust the faucet for the water temperature you want.
3. **Be sure to return faucet setting to hot water when you are finished.**

When cycle is finished

1. Turn hot water off. (This may be done after the final rinse.)
2. Unplug power supply cord and return to storage compartment.
3. Press the button on the side of the coupler to release the water pressure.
4. Lift slightly on the coupler while pulling down on the locking collar. Slide the coupler off the faucet adapter.
5. Empty any remaining water from the coupler.
6. Return hoses to storage compartment.

Electrical connection

A power supply of 120 volts, 60Hz AC or 120 volts, 50Hz, 15 or 20 amps is required. For your personal safety, this appliance must be grounded. This appliance is equipped with a power supply cord having a 3-prong grounding plug. To minimize possible shock hazard, the appliance must be connected to a mating 3-prong grounding type wall receptacle, grounded in accordance with the National Electrical Code (ANSI/NFPA 70, latest edition) and local codes and ordinances. If a mating wall receptacle is not available, it is the responsibility and obligation of the customer to have a properly grounded 3-prong wall receptacle installed by a qualified electrician.

IMPORTANT: Do not, under any circumstances, remove the power supply cord ground prong.

⚠ WARNING

Personal Injury Hazard

An extension cord should not be used with this appliance.

Such use may result in a fire, electrical shock or other personal injury.

3-prong
grounding
plug

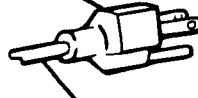

Power supply cord

3-prong
grounding type
wall receptacle

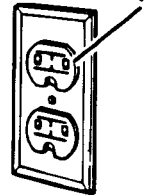

Care of dishwasher top

The wood top is prefinished with a protective lacquer seal.

For daily care

Wipe top with a damp cloth after using.

For stubborn stains

1. Leave dampened scouring powder on wood for three to five hours.
2. Wipe powder away with a damp cloth.

To recondition top

After an extended period of use it may be necessary to recondition the top.

1. Lightly sand off all remaining lacquer.
2. Wipe the top with a clean cloth saturated with mineral oil. Leave oil on overnight.
3. Repeat oil treatment the following day. Allow to stand four to six hours.
4. Remove excess oil with soft, dry cloth. The top is ready for use.
5. Repeat treatment every six to eight months as necessary.

Converting to a built-in

There are no additional parts needed to convert your portable to a built-in dishwasher. Instructions were packaged with your dishwasher. If you have misplaced these instructions, please call 1-800-422-1230 or write to:

Consumer Assistance Center
KitchenAid
P.O. Box 558
St. Joseph, MI 49085-0558

Operating Your Dishwasher

In This Section

	Page		Page
Before starting your dishwasher	8	Using the detergent dispenser	13
Starting your dishwasher	8	Using the rinse agent dispenser	14
Adding dishware during a cycle	8	Sure-Clean™ water heating	14
Changing a cycle setting	9	Flo-through drying	15
To cancel a cycle	9	Quiet operating tips	15
What happens in each cycle	9	Energy saving tips	15
What happens in each option	10	Special tips on dishwasher use	16
Loading your dishwasher	10		

Operating your dishwasher properly enables you to obtain the best possible results. This section explains proper dishwasher operation.

Before starting your dishwasher

1. Properly load the top and bottom racks, and the silverware basket. See pages 10-12.
2. Spin the upper and lower spray arms with lower rack in place to make sure nothing prevents arms from turning freely.
3. Add detergent. See page 13.
4. Check rinse agent dispenser. See page 14.
5. Firmly close door. Latch door by pushing the door handle down.
6. Run hot water at sink nearest dishwasher until water is hot. Turn off water.

Starting your dishwasher

The dishwasher will wash and dry dishware according to the selections you make on the control panel.

1. Turn Cycle Selection dial to the desired cycle. See pages 9-10 for cycle descriptions.
2. Select a drying option. See page 10 for description.
3. Push a Wash Selection button for the desired cycle. The dishwasher will start the cycle.

Adding dishware during a cycle

You can add a forgotten item to the dishwasher anytime before the Cycle Selection dial reaches LIGHT/CHINA. See page 9.

1. Unlatch the door to stop the cycle. Wait a moment for the spray action to stop before opening the door.
2. Open the door and add the dishware.
3. Close the door.
4. Push down on the door handle to latch door.
5. Push the Wash Selection button of the current cycle to restart dishwasher.

Changing a cycle setting

You can change a setting anytime during any cycle.

1. Unlatch the door. Wait for the spray arms to stop spinning.
2. Open the door.
3. Check the detergent dispenser to be sure it is properly filled for the new cycle.
4. Relatch the door.
5. Select the desired new cycle and dry option.
6. Push the Wash Selection button for the new cycle to start dishwasher.

To cancel a cycle

You can cancel a cycle anytime during the cycle.

1. Turn the Cycle Selection dial slowly to the drain portion of the wash or rinse.
You will hear water draining when you have advanced to the proper location.
2. Let the dishwasher drain completely.
3. Unlatch the door.
4. Advance the Cycle Selection dial to POTS/PANS.
The cycle is now canceled.

What happens in each cycle

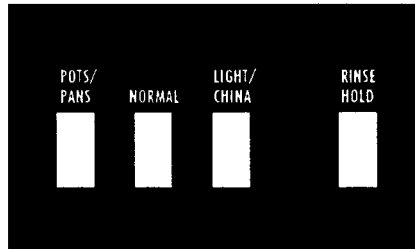
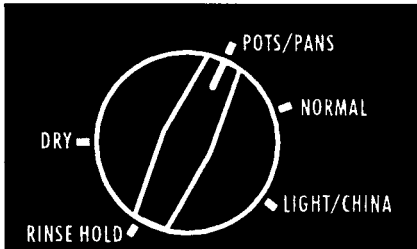

Pots/Pans cycle

This cycle is used to soak, wash, and dry hard-to-clean heavily soiled pots, pans and casseroles along with regular tableware.

The cycle starts with a pre-wash and rinse, followed by a wash, a purge to remove soiled water, and a rinse. Cycle time is about 81 minutes* if heated drying is selected. Water usage is 9¼ gallons.

Cycle sequence:

Pre-Wash → Rinse → Wash → Purge → Rinse → Dry → Off

Normal cycle

This cycle is used to wash and dry daily loads with moderate amounts of food soil.

There are two wash periods, a purge to remove soiled water, and a rinse. Cycle time is about 71 minutes* if heated drying is selected. Water usage is 7½ gallons.

Cycle sequence:

Wash → Wash → Purge → Rinse → Dry → Off

*Cycle time may be longer depending on incoming household water temperature.

Light/China cycle

This cycle is used to wash and dry daily loads with light amounts of food soil.

The cycle starts with a wash period, then a purge to remove soiled water, and a rinse. Cycle time is about 58 minutes* if heated drying is selected. Water usage is 5¼ gallons.

Cycle sequence:

Wash → Purge → Rinse → Dry → Off

IMPORTANT: Check manufacturers' recommendations before washing china and crystal. All cycles may be used to wash and dry dishwasher-safe china and crystal.

Rinse Hold cycle

This cycle is used to rinse partial loads of dishware until a full load is accumulated. Detergent is not used. Dishware is kept moist until a complete wash and dry cycle can be run.

The cycle provides one rinse period. Cycle time is about 8 minutes. Water usage is 2¼ gallons.

Cycle sequence:

Rinse → Off

IMPORTANT: The Energy Saver Dry option cannot be used with the Rinse Hold cycle.

*Cycle time may be longer depending on incoming household water temperature.

What happens in each option

Energy Saver Dry option

This option will eliminate the heat during the dry portion of a cycle. This option may be used with the Pots/Pans, Normal and Light/China cycles.

The fan of the drying system will continue to operate, helping the dishware to air dry naturally. Under certain conditions, you may find a few drops of water on the dishware and silverware. For best drying results, use a liquid rinse agent such as Jet-Dry®.

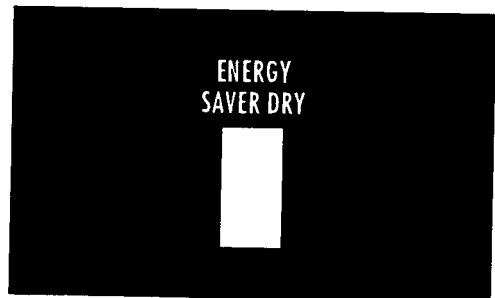

Loading your dishwasher

Preparation for loading

It is not necessary to rinse dishware before putting them into the dishwasher.

- Scrape leftover food, bones, toothpicks and other hard items from dishware.
- Foods like eggs, rice, pasta, and cooked cereals may be hard to remove if they are left to dry over a period of time.

Run a Rinse Hold cycle to keep dishware moist if you do not plan to wash them soon.

- Load dishware so that soiled surfaces face the rotating wash arm.
- Be careful to separate items. Spray must reach all surfaces for best washing. Water must drain off completely for best drying.

Durakote™ nylon upper and lower racks

Your KitchenAid dishwasher is equipped with Durakote™ Nylon upper and lower racks which provide extended life and better protection for your dishware. These racks have an extended five-year limited warranty. See your dishwasher warranty on the back cover for details.

Top rack loading

CAUTION

Dishware Damage Hazard

Unstable dishware items may be damaged.

Load carefully to prevent damage.

Glasses, stemware, bowls, pans, saucers and cups may be loaded together. Stability is important when loading such items. Tilt cups and mugs with concave bottom surfaces to aid drainage.

Lightweight plastics, or glassware and stemware should be locked into place. Additional glasses, and stemware, may also be loaded in the upper rack between and over pins in a stable manner.

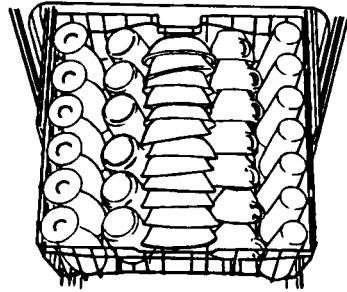
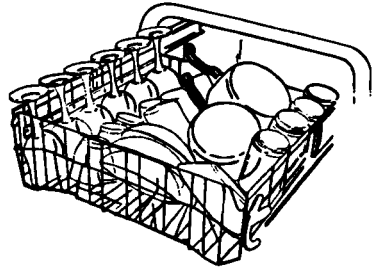

Adjustable upper rack

Your KitchenAid dishwasher features a 16-position upper rack which may be easily adjusted when either empty or full.

1. Pull the upper rack out so that the knobs on either side of the rack are easily reached.
2. Pull the knob on side of rack out from the retainer plate. Raise or lower the rack to desired level.
3. Place knob pin in one of the four retainer holes.

Raise the upper rack when loading platters, trays, large roasting pans and other baking utensils in the lower rack.

Lower the upper rack when loading pitchers, deep bowls, and tall stemware in the upper rack.

Either side of the rack may be raised or lowered independently of the other to accommodate extra large items in both racks.

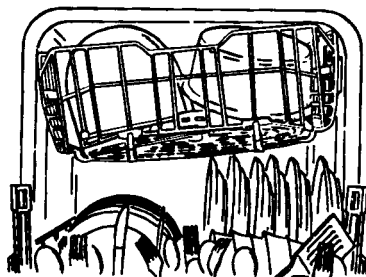
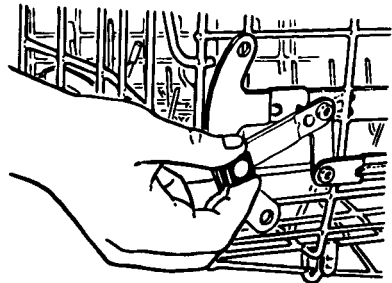

Bottom rack loading

For maximum capacity and stability of an all-plate load, overlap small plates on right side, as shown.

Cereal/soup bowls may be loaded in a variety of ways, depending upon the shape of the bowls.

Plates may be loaded front to back or side to side with pots, pans and large cookware.

Glasses may be loaded in the lower rack along with plates, bowls and saucepans.

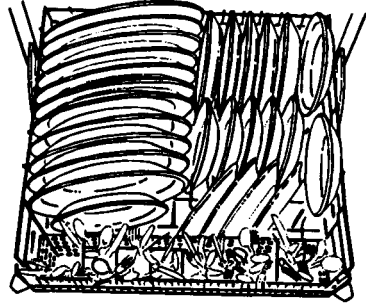

Silverware basket loading

⚠ WARNING

Personal Injury Hazard

Sharp utensils should be loaded with the point down.

Failure to do so could cause personal injury.

The silverware/cutlery basket may be removed for loading and unloading.

For best washing results:

Load slim handled silverware with handles up to prevent them from sticking through the basket, possibly causing damage to the silverware or dishwasher.

Load forks and spoons with handles up and down so they do not nest together. Nesting may result in reduced washing performance.

The cutlery section in the front of the basket is for long-handled utensils and long knives.

IMPORTANT: Silver and stainless-steel flatware may be damaged if washed when in contact with one another.

Silver and stainless-steel flatware may also be damaged if exposed to foods containing salt, vinegar, milk products or fruit juices for long periods of time. Use the Rinse Hold cycle if flatware is not washed immediately after use.

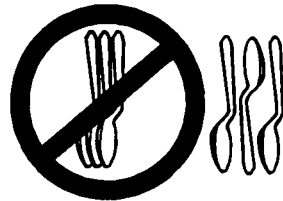
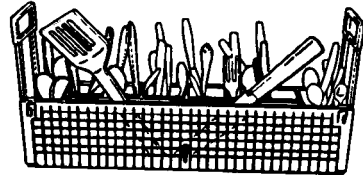

Using the detergent dispenser

IMPORTANT: Use automatic dishwasher detergent only.

Never use soap, hand dishwashing detergent, laundry detergent or laundry enzyme products. The products will produce excessive suds which could cause flooding. Use of these products will reduce washing performance.

Different brands of dishwasher detergent have different amounts of phosphorus for softening water. If water is hard and phosphorus content is low (6.0% or less), you may need to use more detergent or use a brand with a higher phosphorus content (8.7% or higher).

Add detergent to the dispenser immediately before starting a cycle. Detergent exposed to moisture over a period of time may become caked and ineffective. An open box of detergent should stay fresh for about one month. Keep detergent container tightly closed in a cool, dry place. Store detergent where children cannot reach the container.

- Excessive amounts of detergent combined with soft water may cause etching of glassware.
- Do not use more than one tablespoon of detergent if you have rinsed or pre-washed the dishware.

IMPORTANT: Contact your local water utility, area water softening company or state university extension agent to determine your water hardness.

Water Hardness	Amount of Detergent
Soft Water 0-4 grains per gallon	Fill each dispenser to the $\frac{1}{2}$ full line
Medium Hard Water 4-8 grains per gallon	Fill each dispenser to the $\frac{3}{4}$ full line
Hard Water 8-12 grains per gallon	Fill each dispenser completely full

How much detergent to use

There are ingredients in detergent to help protect your dishware. The amount of detergent needed depends on the amount of food soil on the dishware and the water hardness.

- ALWAYS use at least one tablespoon of automatic dishwashing detergent in Main Wash compartment.
- If you have hard water, you will have to use more detergent than if you have soft water.

The detergent dispenser

The detergent dispenser has one section with a cover and one section without a cover.

1. Fill the dispenser sections with the proper amount of detergent.
2. Close the section covers.

Single fill:

Single fill is used for the Light/China cycle when dishware is lightly soiled.

Double fill:

Double fill is used for the Pots/Pans and Normal cycles when dishware is heavily soiled.

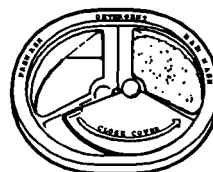
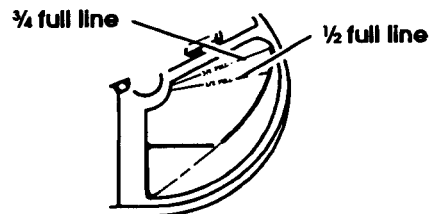

Single fill

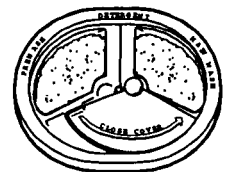

Double fill

Using the rinse agent dispenser

Keep the rinse agent dispenser filled with a liquid rinse agent such as Jet-Dry®. A small amount of rinse agent is automatically released into the rinse water during the final rinse of each cycle.

IMPORTANT: A rinse agent prevents water from forming droplets and drying as spots or streaks. A rinse agent improves drying by allowing water to drain off dishware during the final rinse.

To fill dispenser

1. Make sure the dishwasher door is fully open.
2. Do not fill past the smallest opening in the lower part of the dispenser.
If you overfill, excess rinse agent may overflow dispenser and cause over-sudsing.
3. Clean up any spilled rinse agent with a damp cloth.
4. Replace the fill cap and keep cap tightly closed.

IMPORTANT: Because your dishwasher is designed to use a liquid rinse agent, you do not need to use a solid or bar-type rinse agent.

® Registered Trademark of Benckiser Consumer Products, Inc.

Check the dispenser

For best drying results, check the dispenser periodically to see if refilling is needed. You do not have to wait until the dispenser is empty to refill it, but do not overfill it.

The rinse agent dispenser will hold 7 fluid ounces of rinse agent. Under normal conditions, this will last about 3 months.



Sure-Clean™ water heating

During the wash portion of the cycle selected (excluding Rinse Hold) the wash water is heated to approximately 140°F (60°C). This means that you may turn your home water heater down to provide a minimum of 120°F (49°C) incoming water to the dishwasher. Keeping your water heater at 120°F (49°C) rather than 140°F (60°C) will save you approximately 10% of your total household water heating energy.

Time needed to heat water

The lower the incoming water temperature, the longer the wash portion of the cycle will run. This is because the cycle will continue to wash while the water is being heated to 140°F (60°C). Higher incoming water temperatures will shorten the water heating time.

IMPORTANT: For best dishwashing results, water should be at least 120°F (49°C) as it enters the dishwasher.

To check water temperature

1. Test water at the faucet closest to your dishwasher.
2. Run water into a glass set in the sink for at least one minute, allowing water to overflow.
3. Place a candy or meat thermometer in the glass. Read the thermometer at the maximum setting.
4. If the water temperature is too low, raise the setting on your water heater, if possible.

Flo-through drying

A pause period of approximately four minutes at the start of the drying period allows water to drain from dishware. After this pause, a separate motor and fan circulate air throughout the wash chamber.

Occasionally, steam vapor may be noticed coming through the door-wide evaporation strip (A) at the bottom of the door. This is normal. The vapor is the result of moisture in the dishwasher being moved by the Flo-Thro Drying System (B). Vapor may be more noticeable in an air conditioned home. The vapor is not harmful and usually dissipates very quickly.

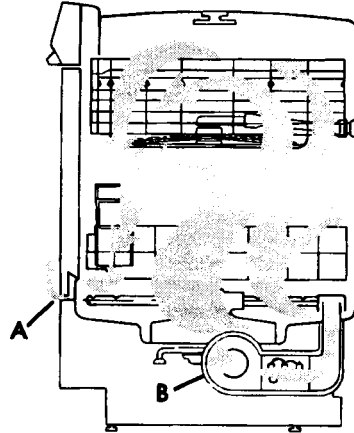

Quiet operating tips

To avoid thumping and clattering noises during operation:

- Make sure lightweight load items are secured in the rack.
- Make sure pot lids and handles, pizza pans, cookie sheets, etc. do not touch interior walls or interfere with the spray arm rotation.
- Load dishware so they **do not** touch one another.

IMPORTANT: Keep sink drain plugs inserted during dishwasher operation to prevent noise transfer through drains.

Normal sounds you may hear while dishwasher is running:

- The fill valve opening or closing and the sound of water entering the dishwasher.
- Water being pumped out during drain portion of a cycle.
- Detergent cup opening.
- Timer clicking as it advances.
- Pump motor starting.
- Items being ground up in the hard food disposer.

Energy saving tips

- Do not rinse dishware before loading.
- Use the Energy Saver Dry option whenever possible.
- Turn the temperature setting on your home water heater down to provide a minimum of 120°F (49°C) incoming water to the dishwasher.
- Run the dishwasher only with a full load.
- Use only the cycle and options that you need.
- Run the dishwasher at night during summer to avoid daytime heat load.

Special tips on dishwasher use

Most tableware, cookware and silverware can be safely washed in your KitchenAid dishwasher. If you have any doubts about a particular piece of dishware, check with the manufacturer to see if it is dishwasher safe.

REMEMBER: It is the user's responsibility to determine if dishware should be washed in a dishwasher.

Material	Dishwasher Safe?	Exceptions/Special Information	Material	Dishwasher Safe?	Exceptions/Special Information
Aluminum	Yes	High water temperature and detergents may affect finish of anodized aluminum.	Disposable Plastics	No	Cannot withstand high water temperatures and detergents.
Cast Iron	No	Seasoning will be removed, and iron will rust.	Plastics	Yes	Always check manufacturers' recommendations before washing. Plastics vary in their capacity to withstand high water temperatures and detergents.
China/ Stoneware	Yes	Always check manufacturers' recommendations before washing. Antique, hand-painted or over-the-glaze patterns may fade. Gold leaf may discolor.	Stainless Steel	Yes	Run a Rinse Hold cycle if not washing immediately. Prolonged contact with foods containing salt, vinegar, milk products or fruit juice could damage finish.
Crystal	Yes	Always check manufacturers' recommendations before washing. Some types of leaded crystal may etch with repeated washings.	Sterling Silver or Silverplate	Yes	Run a Rinse Hold cycle if not washing immediately. Prolonged contact with food containing salt, acid or sulfide (eggs, mayonnaise and seafood) could damage finish.
Gold	No	Gold-colored flatware will discolor.	Tin	No	May rust.
Glass	Yes	Milk glass will yellow with repeated dishwasher washing.	Wooden Ware	No	Always check manufacturers' recommendations before washing. Untreated wood may warp, crack or lose its finish.
Hollow-Handle Knives	No	Handles of some knives are attached to the blade with adhesives which may loosen if washed in the dishwasher.			
Pewter	No	High water temperatures and detergent may discolor or pit finish.			

Caring For Your Dishwasher

In This Section

	Page		Page
Sure-Scrub™ wash system	17	Seasonal storage	18
Overflow protection float	17	Drain air gap	18
General cleaning	17		

Your new dishwasher is designed to give you many years of dependable service. However, there are a few things you are expected to do in order to maintain your dishwasher properly. This section will tell you how to clean and care for your dishwasher.

Sure-Scrub™ wash system

The Sure-Scrub Wash System in your dishwasher provides excellent cleaning results. The wash water is continuously filtered by a triple filtration and soil collector system to prevent food particles from redepositing on clean dishware. The filter continuously filters the wash water and traps the food particles that have been removed from the dishware on the outside of the filter.

These trapped food particles are removed from the ultrafine filter by four water jets

underneath the 4-Way Hydro Sweep Wash Arm.

The coarse strainer prevents bones, pits and other large objects from entering the pump system. Occasionally check the strainer for such items that may have mistakenly entered the dishwasher.

IMPORTANT: A small amount of water always remains in the sump (under the ultrafine filter) to keep the seal moist.

Overflow protection float

The Overflow Protection Float in the front left corner of the dishwasher tank prevents the dishwasher from overflowing. The float must be in place for the dishwasher to operate.

Check under the float for object that may prevent the float from moving up or down.

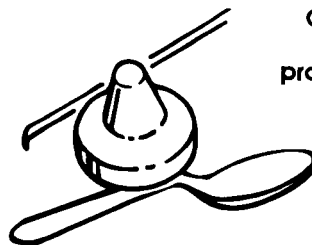

Check under overflow protection float

General cleaning

Interior

The porcelain enamel interior of your dishwasher will seldom need cleaning. However, if mineral deposits from hard water accumulate, clean the interior with a mild scouring powder or follow the suggestions indicated in the "Removing Spots and Film" section on page 24.

DO NOT use any type of cleanser which may cause foaming or sudsing.

IMPORTANT: Run the dishwasher through a normal cycle with detergent after cleaning the interior.

Exterior

The control panel may be cleaned with a damp cloth, then dried. NEVER use detergents or abrasive or powdered cleansers which may mar the finish.

The enamel or wood fronts and sides may be cleaned with a soft cloth and a mild, nonabrasive soap and water solution. NEVER use paper towels for cleaning. Paper towels are abrasive and may scratch your dishwasher's finish. Always dry with a soft cloth.

Seasonal storage

The winter season:

⚠ CAUTION

Property Damage Hazard

To protect against possible rupture of fill valve, be sure water lines leading to, as well as in, the dishwasher are well protected against freezing.

Failure to do so could result in property damage. Ruptures of this kind are not covered by the warranty.

To safeguard your KitchenAid dishwasher when it is exposed to freezing temperatures in a seasonal dwelling, refer to the Installation Instructions and have a qualified person do the following:

1. Close and latch the door.
2. Turn off electrical power supply to the dishwasher.

3. Shut off water supply. Place pan under fill valve, and disconnect fill valve at both inlet and outlet sides. Drain water into pan.

4. Place a pan under the drain valve outlet, and disconnect the flexible tubing at the drain valve. Drain machine water into pan. Leave fill and drain valve disconnected.

To restore service, reconnect the fill valve and the flexible tubing at the drain valve. Turn on the electrical power supply and the water supply. Close and latch the door. Select the Light/China cycle and let the machine complete the cycle. Check connections to make sure they are water tight and do not leak.

The summer season:

Two simple steps will safeguard your KitchenAid dishwasher during an idle summer:

1. Turn off the water supply.
2. Turn off electrical power supply to the dishwasher.

Drain air gap

Some state or local plumbing codes require the addition of a drain air gap between a built-in dishwasher and the home drain system. This device protects your dishwasher against water backing up into it when a drain clogs. The drain air gap is usually located on top of the sink or countertop near the dishwasher. To order drain air gap accessory part number 300096, contact your local KitchenAid dealer or call 1-800-422-1230.

IMPORTANT: This external plumbing device is not part of your KitchenAid dishwasher.

To clean the drain air gap

Clean the drain air gap periodically to ensure proper drainage of your dishwasher. Follow drain air gap cleaning instructions provided by the manufacturer. With most types, just lift off the chrome cover, unscrew the plastic cap, and then check for any buildup of soil. Clean, if necessary.

Check the air gap anytime your dishwasher isn't draining well

IMPORTANT: The warranty provided with your dishwasher does not cover service costs directly associated with the cleaning or repair of the external drain air gap.

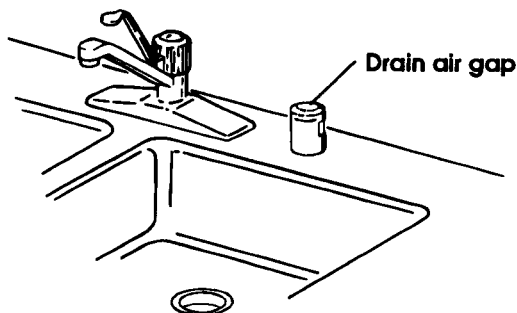

Changing Front Panels

In This Section

	Page	Page
Changing the front panels	19	Optional front panels21

Your new KitchenAid dishwasher comes with a stainless steel trim kit and a reversible front panel. You may choose from black or white (front and back of one panel) or build a custom panel. See "Optional front panels" on page 21 if you want to use custom front panels.

Changing the front panels

If you want to change the color of the panels, follow one of the options below:

OPTION A may be used if your dishwasher front protrudes several inches from the cabinets.

OPTION B may be used if your dishwasher front is flush with the cabinets.

OPTION A

Use these directions when the dishwasher front protrudes several inches from the cabinets.

Upper Panel:

1. Disconnect electrical power supply.
2. Pull door open and on either side of the dishwasher door, remove the three screws (A) from the trim (B). Remove the loosened piece of trim.
3. Slide the color panel out. Handle the panel carefully to avoid scratching or bending the panel. Turn the panel to the desired color. Place the color panel in position; then push the filler panel in behind the color panel.
4. Replace the trim (B) and the three screws (A).

Lower Panel:

1. Remove the two screws (C) on either side of the lower panel. Remove the loosened piece of trim (D).
2. Slide the color panel out. Handle the panel carefully to avoid scratching or bending the panel. Turn the panel to the desired color. Place the color panel in position; then push the filler panel in behind the color panel.
3. Replace the trim (D) and the two screws (C).
4. Reconnect electrical power supply.

⚠ WARNING

Electrical Shock Hazard

Disconnect electrical power supply to dishwasher before changing panels.

Failure to do so could result in electrical shock or personal injury.

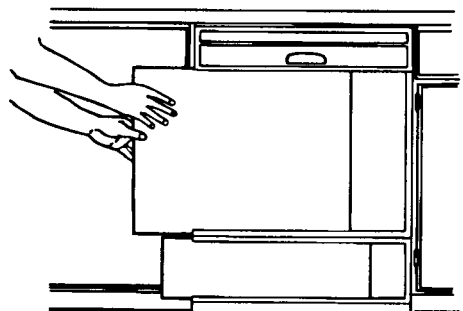
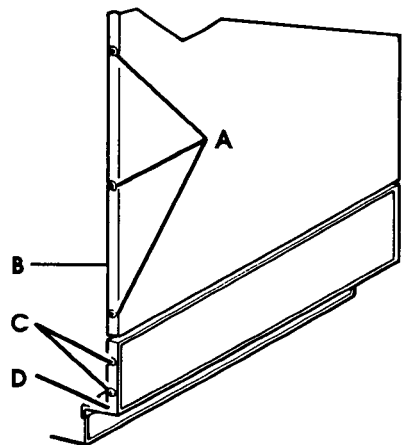

OPTION B

Use these directions when the dishwasher front is flush with the cabinets.

Upper Panel:

1. Disconnect electrical power supply.
2. Pull door open. Remove the two screws (E) on each side of the dishwasher door which secure the upper panel assembly.
3. Close door while holding upper panel assembly in place. Pull out lower edge of assembly until top edge drops down.
4. Place panel assembly on a smooth, flat surface. Remove three screws (A) from either side of panel to remove the trim strip (B).
5. Slide the color panel out. Handle the panel carefully to avoid scratching or bending the panel. Turn the panel to the desired color. Place the color panel in position; then push the filler panel in behind the color panel.
6. Replace the trim strip and the three screws.
7. With hands placed at sides of panel, slide the top edge of the panel up into position under the control panel (see illustration).
8. Hold the panel in place and open the door.
9. Hold panel assembly in position with one hand. Replace the two screws (E) on each side of the dishwasher door which secure the panel assembly.

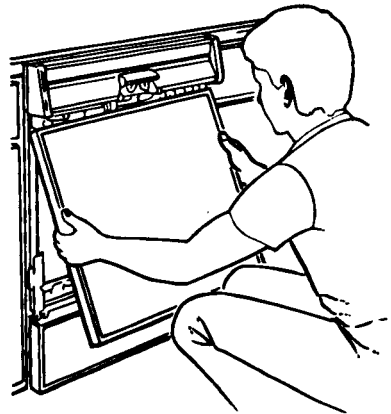
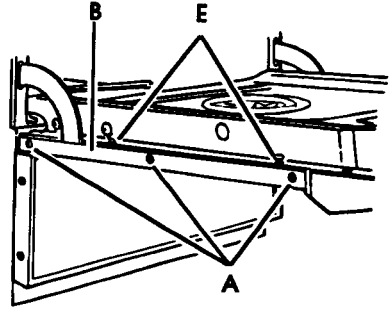

Lower Panel:

1. Remove two screws (F) located under panel assembly.
2. With hands placed under ends of panel assembly (H), turn out and lift assembly off of support bracket (G).
3. Place panel assembly on a smooth, flat surface and remove the two screws (C) from either side of the trim. Remove the loosened piece of trim.
4. Slide the color panel out. Handle the panel carefully to avoid scratching or bending the panel. Turn the panel to the desired color. Place the color panel in position; then push the filler panel in behind the color panel.
5. Replace the trim and screws (C).
6. Taking the assembled lower panel (H), insert the top of the assembly into the dishwasher until the seal is seated properly on top of the support bracket (G).
7. Replace the screws (F).
8. Check that upper and lower panels are secure.
9. Reconnect electrical power supply.

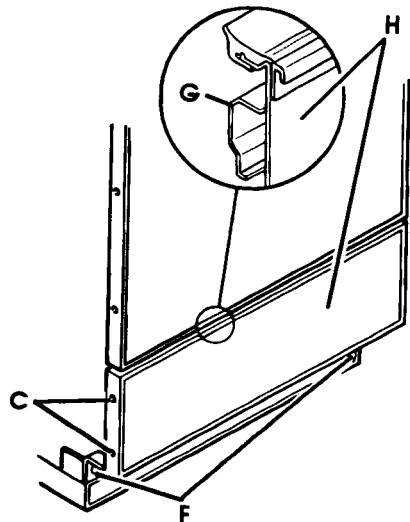

Optional front panels

1. Wood and decorative panels

The stainless-steel front trim will accommodate a custom wood front or a decorative panel insert, ¼ inch thick, weighing no more than 10 pounds. Any wood panel or decorative panel weighing over 4 pounds requires heavy-duty door springs.

To order heavy-duty springs, contact your local KitchenAid dealer or call 1-800-422-1230.

For more information on installing a custom wood front, refer to the Dishwasher Installation Instructions. If you have misplaced these instructions, please call 1-800-422-1230 or write to:

Consumer Assistance Center
KitchenAid
P.O. Box 558
St. Joseph, MI 49085-0558

2. Solid colors

If the two colors provided with your dishwasher do not match your kitchen decor, optional panels are available from your KitchenAid dealer in a variety of decorator colors.

⚠ CAUTION

Product Damage

- Heavy-duty door springs must be used with custom panels that weigh more than 4 pounds.
- Heavy duty door spring kit, part number 9741247, must be ordered from your dealer or authorized parts distributor.
- Maximum door panel weight is 10 pounds.

Failure to follow these instructions could cause product damage.

Common Dishwashing Problems

In This Section

	Page	Page
Solution chart	22	Removing spots and film24

Solution chart

A convenient checklist for handling minor performance problems. Go over this list before calling for service. If you are unable to solve your dishwasher's problem, turn to page 24 for service information.

Problem	Cause	Solution
Food Soil Left on Dishware	Slowdown of wash arm due to high suds	Never use soap or laundry detergents. Use recommended dishwasher detergents only.
	Improper loading	Follow loading instructions on pages 10-12.
	Low water pressure due to insufficient fill	Home water pressure should be 20 to 120 psi for proper dishwasher fill. A booster pump on the water supply may be necessary if pressure is too low.
	Use of incorrect, too little or ineffective detergent	Use recommended dishwasher detergents only. Follow recommendations on page 13 for amounts; never use less than one tablespoon per load. Detergent must be fresh to be effective. Always store detergent in a cool, dry area, preferably in an airtight container.
	Detergent cakes in dispenser	Use fresh detergent only. Do not allow detergent to sit for several hours in a wet dispenser. Check dispenser for caked detergent. Clean dispenser when caked detergent is present.
	Water temperature is too low	Turn home water heater up to ensure water entering dishwasher is 120°F (49°C) minimum. See recommended procedure "Sure-Clean Water Heating" page 14.
Spotting and Filming	Hard water or high mineral content in water	Conditioning the final rinse water with a liquid rinse agent helps eliminate spotting and filming. Keep the dispenser full with a rinse agent, such as Jet-Dry® at all times.
	Water temperature is too low	Turn home water heater up to ensure water entering dishwasher is 120°F (49°C) minimum. See recommended procedure "Sure-Clean Water Heating" page 14.
	Use of incorrect detergents	Use recommended dishwasher detergents only.
	Incorrect amount of detergent	Follow recommendations on page 13 for amount. Heavy soil and/or hard water generally require extra detergent.
	Use of ineffective detergents	Detergent should be fresh. Store in a cool, dry place, preferably in an airtight container. Discard lumpy detergent.
	Insufficient fill caused by low water pressure	Home water pressure should be 20 to 120 psi for proper dishwasher fill. A booster pump on the water supply may be necessary if pressure is too low.

Problem	Cause	Solution
Cycle Takes Extremely Long Time	Water temperature is too low	Turn home water heater up to ensure water entering dishwasher is 120°F (49°C) minimum. See recommended procedure "Sure-Clean Water Heating" page 14.
Dishware Does Not Dry Completely	Dishware does not drain properly Plastics	Dishware must have proper water drainage. Do not overload. Follow instructions for loading dishwasher on pages 10-12. Use a liquid rinse agent to speed draining. Some plastics, due to material, may need to be towel dried.
Silica Film or Etching (Silica Film is a White Iridescent Deposit; Etching is a Cloudy Film)	A water chemical reaction with certain types of glassware. Usually caused by some combination of soft or softened water, alkaline washing solutions, insufficient rinsing, overloading the dishwasher, and heat of drying.	It may not be possible to prevent problem, except by hand-washing. To retard this process, use a minimum amount of detergent but not less than one tablespoon per load. Use a liquid rinse agent and underload the dishwasher to allow thorough rinsing. Silica film and etching are permanent and can not be removed. Use the Energy Saver Dry option.
Black or Gray Marks on Dishware	Aluminum markings	Aluminum pieces should be loaded so that they will not rub against dishware during washing. Throw-away aluminum items should not be dishwasher washed because they may break down and cause marking. Aluminum markings can be removed by using a mild abrasive cleanser.
Brown Stains on Dishware and Dishwasher Interior	High iron content in water supply	Remove by washing dishware (after food soil has been removed) with 1 teaspoon to 1 tablespoon of citric acid crystals added to Main Wash compartment of detergent dispenser. Do not use detergent. Follow with a Light/China cycle with detergent. If treatment is needed more often than every other month, the installation of an iron removal unit is recommended.
White Spots on Cookware with Non-Stick Finish	Seasoning removed by dishwasher detergents	Re-season cookware after dishwasher washing.
Odor in the Dishwasher	Dishware only washed every two to three days	Run a Rinse Hold cycle at least once or twice a day until a full load is accumulated.
Chipping of Dishware	Improper loading	Load dishware and glasses so that they are stable and do not strike together from washing action. (Note: Some types of china and glassware are too delicate for automatic dishwashing and should be hand-washed; for example: antiques, feather-edged crystal and similar types.) Moving racks in and out smoothly will also minimize chipping.

Removing spots and film

Keep the rinse agent dispenser filled with a liquid rinse agent such as Jet-Dry®. A rinse agent prevents water from forming droplets and drying as spots or streaks.

To remove spots and film on dishware and glasses, or hard water film on the interior of the dishwasher, you may use white vinegar with the following procedure:

1. Load clean dishware and glasses in dishwasher in regular manner. Do not load silverware or other metals in the dishwasher.
2. Close and latch door.
3. Select the Light/China cycle. Do not use detergent.
4. Allow dishwasher to run through the first wash. When washer has filled for main wash portion of cycle, unlatch and open door.
5. Add 2 cups of household vinegar.
6. Close and latch door.
7. Re-select the Light/China cycle with an Energy Saver Dry option.

If You Need Assistance Or Service

If you ever have questions or comments about your appliance, you can call our toll-free Consumer Assistance Center telephone number, 1-800-422-1230, 24 hours a day, seven days a week.

This section is designed to help you save the cost of a service call. First we outline possible problems, their causes and their solutions. However, you may still need assistance or service. When calling our Consumer Assistance Center for help or when calling for service, you will need to provide a complete description of the problem, your appliance's complete model and serial numbers and the purchase or installation date. (See page 2.) This information is needed to respond to your request properly.

1. Before calling for service ...

If your appliance should fail to operate, review the following list before calling your dealer. You could save the cost of a service call.

PROBLEM	CHECK IF	WHAT TO DO
Dishwasher will not run, or stops during a cycle	The door is open or unlatched.	Close the door and securely latch it.
	A cycle is selected.	Select the correct cycle. See pages 9-10.
	Water supply is turned off.	Turn on water supply.
	A household fuse is blown or circuit breaker is tripped.	Change the fuse or reset the circuit breaker.
	Dishwasher is connected in a live circuit with the proper voltage.	Connect the dishwasher in a live circuit with the proper voltage.
	An electrical overload has stopped the motor.	If the motor has stopped because of an overload, it will automatically reset itself within a few minutes. If the motor does not start, call for service.
Dishwasher seems to run too long	Household water heater temperature is low.	The dishwasher will run longer while heating the water. This is normal for lower incoming water temperatures. See page 14.
Dishwasher won't fill	The overflow protector stuck in "up" position.	Check for and remove any object under overflow protector float. Float should move up and down freely. Press down on float to release. See page 17.
Dishware and glasses not clean		See "Food Soil Left on Dishware" section of "Solution Chart" on page 22.

PROBLEM	CHECK IF	WHAT TO DO
White film on dishware		See "Spotting and Filming" section of "Solution Chart" on page 22.
Steam from door vent	Dishwasher is in drying portion of cycle.	This is normal. See "Flo-through drying" on page 15.
Water remains in the dishwasher	The cycle has completed.	Wait for the cycle to finish draining. A small amount of remaining water is normal.
	The drain air gap is clogged.	Follow the manufacturer's cleaning instructions. See page 18.
Grinding, grating, crunching or buzzing sounds are heard	A hard food object has entered the pump.	The sound will stop when the object is ground up by the pump. If it does not stop after the next cycle, call for service.
Detergent remains in the covered detergent cup	Detergent is lumpy.	Use fresh detergent. See page 13.
	The cycle has completed.	Wait for the cycle to finish.
White residue appears on front of access panel	Too much detergent is used.	See page 13 for recommended amounts of detergent.
	Liquid detergent is used.	Some liquid detergents develop excess foam and build up on exterior of access panel. Try a different brand to reduce foaming and eliminate build-up.
Dishware is not as dry as you expected	The rinse agent dispenser is empty.	Fill the rinse agent dispenser. Using a rinse agent greatly improves drying. See page 14.
	Energy Saver Dry option is used.	Turn off Energy Saver Dry option.

2. If the problem is not due to one of the items in step 1:

- Call KitchenAid Consumer Assistance Center toll-free:

1-800-422-1230

and talk with one of our trained consultants. The consultant can instruct you how to obtain satisfactory operation from your appliance or, if service is necessary, recommend a qualified service company in your area.

- If you prefer, write to:
Consumer Assistance Center
KitchenAid
P.O. Box 558
St. Joseph, MI 49085-0558
Please include a daytime phone number in your correspondence.

3. If you need service:

- Call your dealer or the repair service he recommends.
- All service should be handled locally by the dealer from whom you purchased the unit or an authorized KitchenAid servicer.
- If you are unable to obtain the name of a local authorized KitchenAid servicer, call our Consumer Assistance Center telephone number (see Step 2).

4. If you are not satisfied with the action taken:

- Contact the Major Appliance Consumer Action Panel (MACAP). MACAP is a group of consumer experts which voices consumer views at the highest levels of the major appliance industry.
Contact MACAP only when the dealer, authorized servicer, and KitchenAid have failed to resolve your problem.
Major Appliance Consumer Action Panel
20 North Wacker Drive
Chicago, IL 60606
- MACAP will in turn inform us of your action.

KitchenAid®

Dishwasher Warranty

LENGTH OF WARRANTY:	KITCHENAID WILL PAY FOR:	KITCHENAID WILL NOT PAY FOR:
ONE YEAR FULL WARRANTY FROM DATE OF INSTALLATION.	Replacement parts and repair labor to correct defects in materials or workmanship. Service must be provided by an authorized KitchenAid servicing outlet.	A. Service calls to: <ol style="list-style-type: none"> 1. Correct the installation of the dishwasher. 2. Instruct you how to use the dishwasher. 3. Replace house fuses or correct house wiring. 4. Correct house plumbing. B. Repairs when dishwasher is used in other than normal home use. C. Damage resulting from accident, alteration, misuse, abuse, improper installation or installation not in accordance with local electrical and plumbing codes. D. Any labor costs during the limited warranty. E. Replacement parts or repair labor costs for units operated outside the United States. F. Pickup and delivery. This product is designed to be repaired in the home. G. Repairs to parts or systems caused by unauthorized modifications made to the appliance.
FIVE YEAR LIMITED WARRANTY ONE YEAR FULL PLUS SECOND THROUGH FIFTH YEAR LIMITED FROM DATE OF INSTALLATION.	Replacement parts for the upper or lower dishware rack if they rust due to defective materials or workmanship.	
FIVE YEAR LIMITED WARRANTY ONE YEAR FULL PLUS SECOND THROUGH FIFTH YEAR LIMITED FROM DATE OF INSTALLATION.	Replacement parts for the one-half horsepower motor if defective in materials or workmanship.	
TWENTY-FIVE YEAR FULL WARRANTY FROM DATE OF INSTALLATION.	Replacement parts and repair labor for the TriDura™ Porcelain-on-steel tank or inner door if the tank or inner door develops water leak caused by rust through as a result of defective materials or workmanship.	

KITCHENAID DOES NOT ASSUME ANY RESPONSIBILITY FOR INCIDENTAL OR CONSEQUENTIAL DAMAGES. Some states do not allow the exclusion or limitation of incidental or consequential damages, so this exclusion may not apply to you.

This warranty gives you specific legal rights and you may also have other rights which may vary from state to state.

If you need service, first see the "Assistance or Service" section of this book. After checking "Assistance or Service," additional help can be found by calling our Consumer Assistance Center telephone number, **1-800-422-1230**, from anywhere in the U.S.

KitchenAid
St. Joseph, Michigan, U.S.A. 49085



Printed on recycled paper

Part No. 9741254 Rev. C

© 1992 KitchenAid

® Registered Trademark / TM Trademark of KitchenAid

Printed in U.S.A.

Free Manuals Download Website

<http://myh66.com>

<http://usermanuals.us>

<http://www.somanuals.com>

<http://www.4manuals.cc>

<http://www.manual-lib.com>

<http://www.404manual.com>

<http://www.luxmanual.com>

<http://aubethermostatmanual.com>

Golf course search by state

<http://golfingnear.com>

Email search by domain

<http://emailbydomain.com>

Auto manuals search

<http://auto.somanuals.com>

TV manuals search

<http://tv.somanuals.com>