



KFP1333 • KFP1344
Food Processor

INSTRUCTIONS

Robot culinaire

INSTRUCTIONS

Procesador de alimentos

INSTRUCCIONES



FOR THE WAY IT'S MADE.®

Welcome to the world of KitchenAid®

We're committed to helping you create a lifetime of delicious meals for family and friends. To help ensure the longevity and performance of your appliance, keep this guide handy. It will empower you with the best way to use and care for your product. Your satisfaction is our #1 goal. Remember to register your product online at www.kitchenaid.com, or by mail using the attached Product Registration Card.



USA: 1.800.541.6390
Canada: 1.800.807.6777
KitchenAid.com
KitchenAid.ca

Table of Contents

FOOD PROCESSOR SAFETY	
Important Safeguards.....	4
Electrical Requirements.....	5
PARTS AND FEATURES.....	6
ACCESSORIES	
Included Accessories	7
Available Accessories (not included)	8
Disc Assembly Overview.....	8
Accessories Selection Guide.....	9
PREPARING THE FOOD PROCESSOR FOR FIRST USE	
Before First Use	10
Removing the Work Bowl and Work Bowl Cover	10
Storing Parts	10
SETTING UP YOUR FOOD PROCESSOR	
Attaching the Work Bowl.....	11
Attaching the Work Bowl Cover	11
Installing the Adjustable Slicing Disc	12
Adjusting the Slicing Thickness	12
Installing Other Slicing or Shredding Discs	13
Installing the Multipurpose Blade or Dough Blades.....	14
Installing the Mini-Bowl and Mini-Blade	14
Installing the Optional Chef's Bowl	15
Using the 3-in-1 Feed Tube	15
USING YOUR FOOD PROCESSOR	
Before Use	16
Maximum Liquid Level	16
Using the Low/High Speed Control	16
Using the Pulse Control	16
Removing Processed Foods.....	17
CARE AND CLEANING	18
TIPS FOR GREAT RESULTS	
Food Processing Tips.....	19
Helpful Hints.....	21
PART NUMBERS FOR ACCESSORIES	22
TROUBLESHOOTING	23
WARRANTY	24

Find recipes and more at
www.kitchenaid.com

Your safety and the safety of others are very important.

We have provided many important safety messages in this manual and on your appliance. Always read and obey all safety messages.



This is the safety alert symbol.

This symbol alerts you to potential hazards that can kill or hurt you and others.

All safety messages will follow the safety alert symbol and either the word "DANGER" or "WARNING." These words mean:

 **DANGER**

You can be killed or seriously injured if you don't immediately follow instructions.

 **WARNING**

You can be killed or seriously injured if you don't follow instructions.

All safety messages will tell you what the potential hazard is, tell you how to reduce the chance of injury, and tell you what can happen if the instructions are not followed.

IMPORTANT SAFEGUARDS

When using electrical appliances, basic safety precautions should always be followed, including the following:

1. Read all instructions.
2. To protect against risk of electrical shock, do not put Food Processor in water or other liquid.
3. Close supervision is necessary when any appliance is used by or near children.
4. Unplug from the outlet when not in use, before putting on or taking off parts, and before cleaning.
5. Avoid contacting moving parts.
6. Do not operate any appliance with a damaged cord or plug, or after the appliance malfunctions, or is dropped or damaged in any manner. Return appliance to the nearest Authorized Service Facility for examination, repair, or electrical or mechanical adjustment.
7. The use of attachments not recommended or sold by KitchenAid may cause fire, electric shock, or injury.
8. Do not use outdoors.
9. Do not let cord hang over edge of table or counter.
10. Keep hands and utensils away from moving blades or discs while processing food to reduce the risk of severe injury to persons or damage to the Food Processor. A scraper may be used but must be used only when the Food Processor is not running.
11. Blades are sharp. Handle carefully.
12. To reduce the risk of injury, never place cutting blade or discs on base without first putting bowl properly in place.
13. Be certain cover is securely locked in place before operating appliance.
14. Never feed food by hand. Always use the food pusher.
15. Do not attempt to defeat the cover interlock mechanism.
16. This product is designed for household use only.

SAVE THESE INSTRUCTIONS

Electrical Requirements

⚠ WARNING



Fire Hazard

Do not use an extension cord.

Doing so can result in death or fire.

Volts: 120 V.A.C.

Hertz: 60 Hz

NOTE: This Food Processor is equipped with a polarized plug (one blade is wider than the other). To reduce the risk of electrical shock, this plug will fit in a polarized outlet only one way. If the plug does not fit fully in the outlet, reverse the plug. If it still does not fit, contact a qualified electrician. Do not modify the plug in any way.

Do not use an extension cord. If the power supply cord is too short, have a qualified electrician or serviceman install an outlet near the appliance.

Proof of Purchase & Product Registration

Always keep a copy of the itemized sales receipt showing the date of purchase of your Food Processor. Proof of purchase will assure you of in-warranty service. Before you use your Food Processor, please fill out and mail your product registration card packed with the unit. This card will enable us to contact you in the unlikely event of a product safety notification and assist us in complying with the provisions of the Consumer Product Safety Act. This card does not verify your warranty. Please complete the following for your personal records:

Model Number _____

Serial Number _____

Date Purchased _____

Store Name _____

Parts and Features

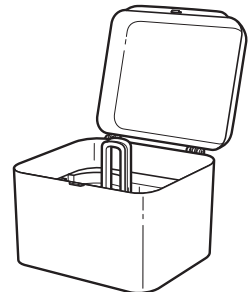
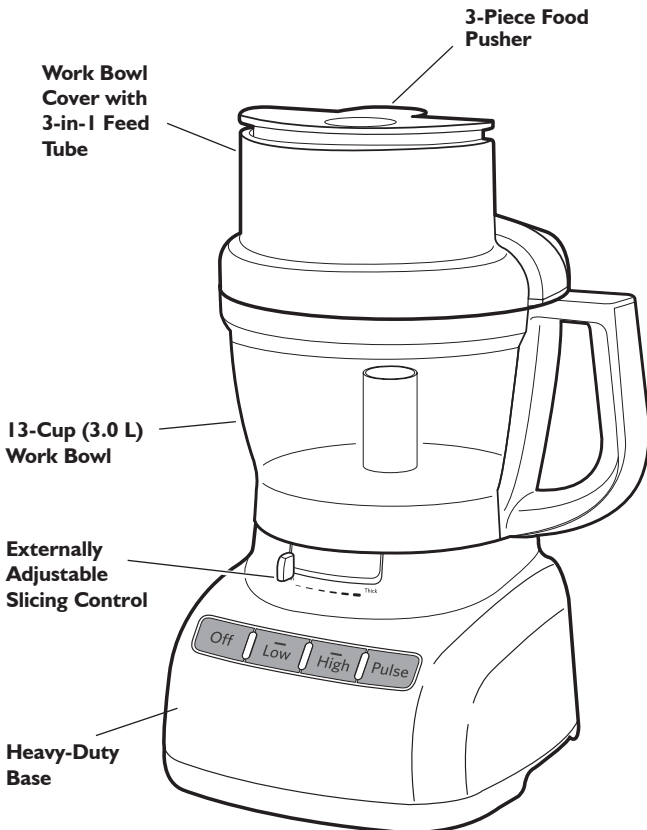
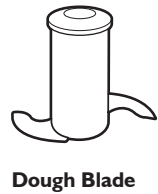
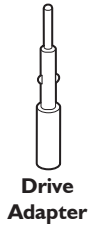
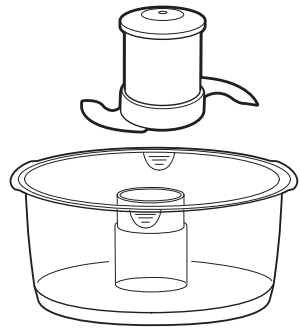
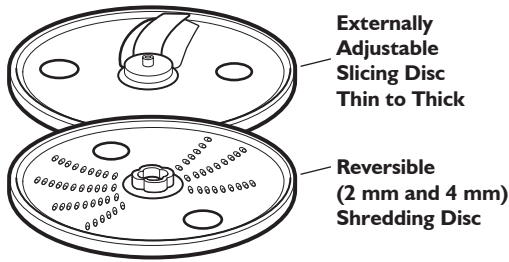

Important parts and accessories included with your new Food Processor are highlighted below. Refer to the following pages for additional details on included accessories included with your Food Processor as well as optional accessories you can order.

Externally Adjustable Slicing Control

KitchenAid's® exclusive on-the-fly externally adjustable slicing disc allows you to adjust slicing thickness from thin to thick, without having to remove the blade assembly. With the slicing disc installed, simply slide the Slicing Thickness Control to the desired setting - no need to remove the cover or even turn off the Food Processor!

High/Low/Pulse/Control

Two speeds and Pulse provide precise control to give great results with most any food.

Work Bowl Cover with 3-in-1 Feed Tube

One of the industry's largest, the 3-in-1 feed tube accommodates large items – like tomatoes, cucumbers, and potatoes – with a minimum of sectioning or slicing.

3-Piece Food Pusher

Three pushers are nested inside of each other. Remove the medium pusher from the large pusher to reveal a medium-size feed tube for continuous processing.

For continuous processing of smaller items (like herbs, nuts, single carrots, and celery), remove the narrow pusher and use the narrow feed tube.

A small hole in the bottom of the narrow pusher makes it easy to drizzle oil into ingredients – just fill with the desired amount of oil or other liquid ingredient.

Heavy-Duty Base

The heavy, slip-resistant base helps provide improved stability and reduced vibration during tough food processing jobs.

Accessories

Included Accessories

4-cup (945 ml) Mini-Bowl and Mini-Blade

Mini-bowl and stainless steel mini-blade are perfect for small chopping and mixing jobs.

13-Cup (3.0 L) Work Bowl

The durable, large work bowl provides capacity for large jobs.

Externally Adjustable Slicing Disc

Disc is adjustable from approximately $\frac{1}{16}$ inch (1 mm) to $\frac{1}{4}$ inch (6 mm) for slicing most foods.

Reversible Shredding Disc

Shredding disc is reversible to allow coarse or finely shredded cheese or vegetables.

Drive Adapter

The drive adapter is used with the appropriate adapter to connect the slicing/shredding discs and mini-blade to the power shaft on the base.

Disc Adapter

Adapter fits over the drive adapter and into the bottom of the adjustable slicing disc.

Slicing Adapter

Adapter fits over the drive adapter and into the bottom of the shredding or Julienne disc.

Stainless Steel Multipurpose Blade

Versatile blade chops, minces, blends, mixes, and emulsifies in a matter of seconds.

Dough Blade

The dough blade is specially designed for mixing and kneading yeast dough.

Chef's Accessory Case

Stylish and durable case organizes and protects blades, discs, and accessories.

Spatula/Cleaning Tool (not shown)

Special shape facilitates food removal from bowls, discs, and blades.

Available Accessories (sold separately)

The following accessories are available separately. For ordering information, see page 25.

Julienne Disc

Julienne disc is great for making shoestring potatoes or vegetables.

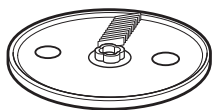

Egg Whip

The egg whip will quickly whip cream and egg whites for meringues, mousses, soufflés, and desserts.

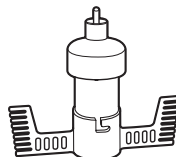

Grate/Shave Disc

Grate hard cheeses such as parmesan, or shave ice for creating refreshing beverages and frozen desserts.

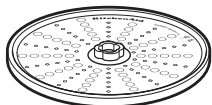

10-cup (2.4 L) Chef's Bowl

Place the chef's bowl inside the work bowl, and slice or shred a food item while keeping the work bowl clean for another ingredient.

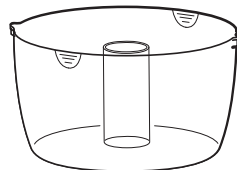

Disc Assembly Overview

There are two different disc adapters included with the food processor. One is used exclusively with the adjustable slicing disc. The other is used with all other discs.

Adjustable Slicing Disc

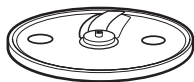

Slicing Adapter



Drive Adapter

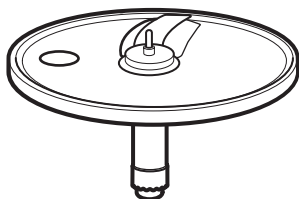

Reversible Shredding Disc

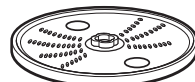

Disc Adapter

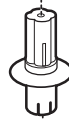



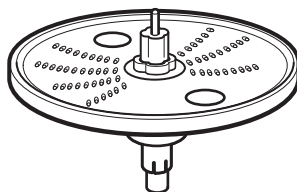



















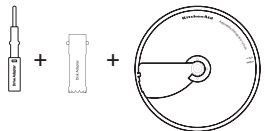



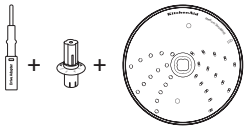

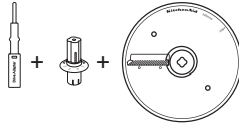

Drive Adapter

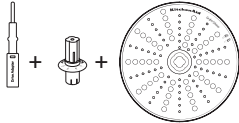

Properly assembled

Accessories Selection Guide

Not all accessories shown are included with all models.

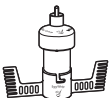
Action	Food	Setting	Accessory
 Chop  Mince  Puree	Cheese Chocolate Fruit Fresh herbs Nuts Tofu Vegetables		Multipurpose Stainless Steel Blade  OR Mini-bowl and Mini Multipurpose Stainless Steel Blade 
 Mix	Pasta Sauce Pesto Salsa Sauces		
 Slice Thin  Slice Thick	Fruit (soft) Potatoes Tomatoes Vegetables (soft)		Adjustable Slicing Disc 
	Cheese Chocolate Fruit (hard) Vegetables (hard)		
 Shred Medium  Shred Fine	Potatoes Vegetables (soft)		Reversible Shredding Disc 
	Cabbage Cheese Chocolate Fruit (hard) Vegetables (hard)		
 Julienne Cut	Potatoes Vegetables (soft)		Julienne Disc 
	Vegetables (hard)		
 Grate  Shave	Cheese (Grate) Ice (Shave)		Grate/Shave Disc 
 Knead	Batter Sweet dough Yeast dough		Plastic Dough Blade 
 Whip	Eggs		Egg Whip 

Preparing the Food Processor for First Use

⚠ WARNING

Cut Hazard
Handle blades carefully.
Failure to do so can result in cuts.

Before First Use

Before using your Food Processor for the first time, wash the work bowl, work bowl cover, mini-bowl, feed tube pushers, discs, and blades (either by hand or in the dishwasher (see "Cleaning the Food Processor" on page 16).

Removing the Work Bowl Cover from the Work Bowl

Your Food Processor is shipped with the work bowl cover installed on the work bowl, with the mini-bowl inside the work bowl.

To remove the work bowl cover from the work bowl for initial cleaning:

1. Grasp the feed tube on the work bowl cover and turn it clockwise to remove it from the work bowl.



2. Lift out the mini-bowl.

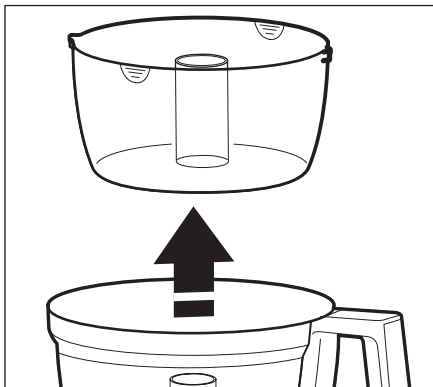

Storing Parts

Once washed, disassembled discs, shafts, and blades should be stored in the provided storage case, in a location out of the reach of children.

The mini-bowl and optional chef's bowl can nest inside the work bowl for convenient storage.

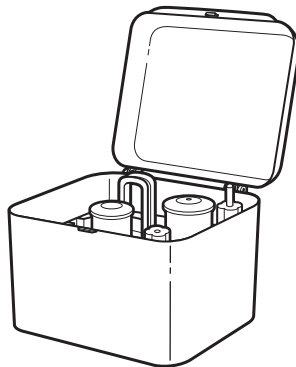

Setting Up Your Food Processor

Attaching the Work Bowl

1. Place the Food Processor on a dry, level countertop with the controls facing forward. Do not plug in the Food Processor until it is completely assembled.
2. Place the work bowl on the base, aligning the raised portion with the indentation on the base. The center hole should fit over the power shaft.

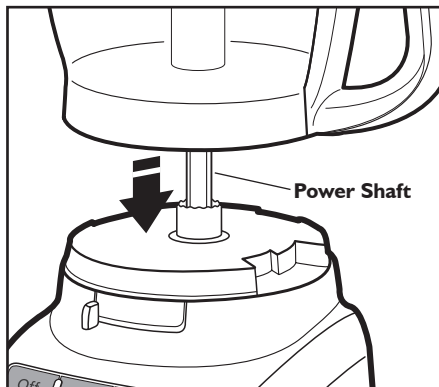

3. Grasp the work bowl handle and turn the bowl counterclockwise to lock it on the base.

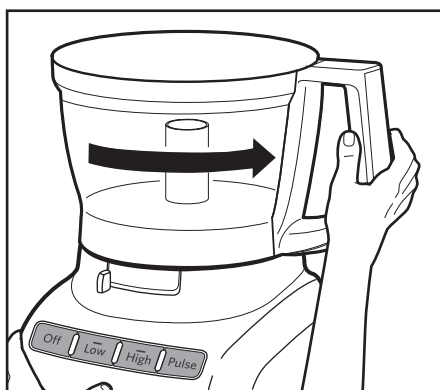

Select the accessory you would like to use and install it according to the instructions on the following pages.

Attaching the Work Bowl Cover

NOTE: Be sure to install the desired accessory before attaching the work bowl cover.

1. Place the work bowl cover on the work bowl with the feed tube just to the left of the work bowl handle. Grasp the feed tube and turn the cover to the right until it locks into place.

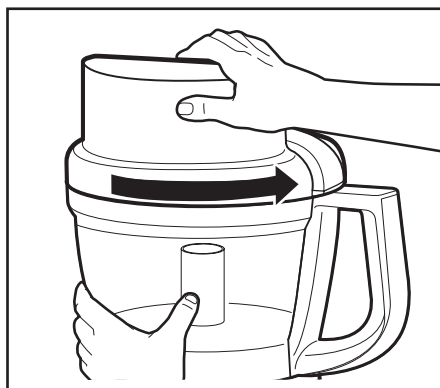

2. Fit the food pusher into the 3-in-1 feed tube. See "Using the 3-in-1 Feed Tube" for details on working with different sized foods.

NOTE: Your Food Processor will not operate unless the work bowl and work bowl cover are properly locked on the base, and the large pusher is inserted to the maximum fill line on the feed tube (approximately halfway down).

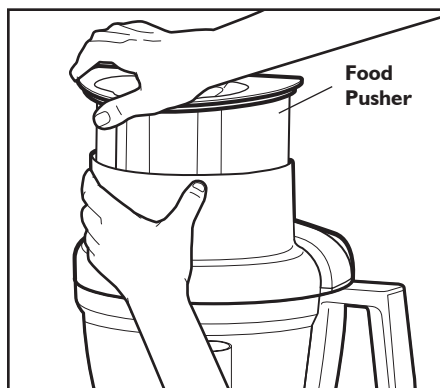

Setting Up Your Food Processor

Installing the Adjustable Slicing Disc

IMPORTANT: The adjustable slicing disc can only be installed in one direction.

1. With the work bowl installed, place the drive adapter on the power shaft of the base.

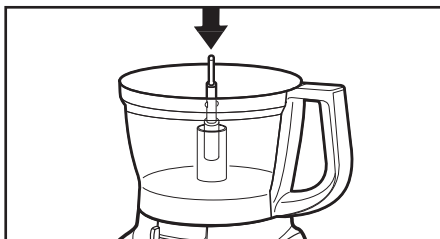

2. Holding the adjustable slicing disc by the 2 finger grips, align the pins onto the adjustable slicing disc adapter into the L-slots on the disc. Slide the disc down onto the adapter and turn to engage the pins in the L-slot.

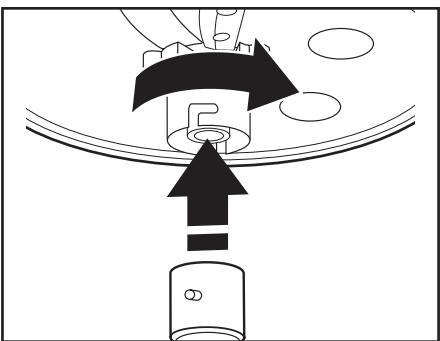

3. Lower the slicing blade and slicing adapter onto the drive adapter.

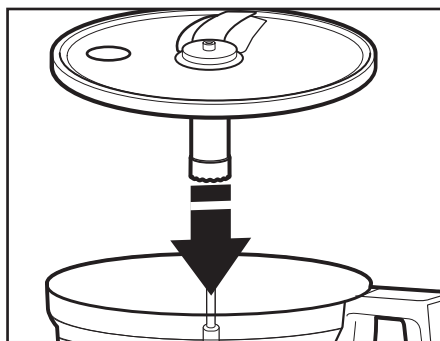

TIP: You may need to turn the disc/drive adapter until it drops down into place.

4. Install the work bowl cover, being sure it locks into place.



Adjusting the Slicing Thickness

Set the desired slicing thickness by moving the lever to the left for thinner slices or to the right for thicker slices.

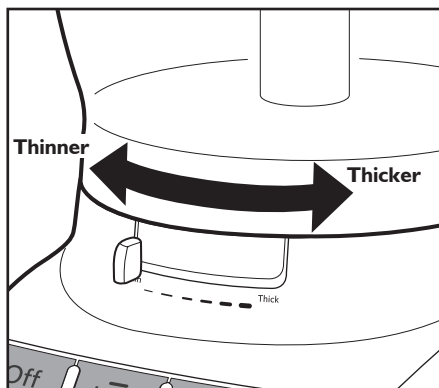

NOTE: The lever only works with the adjustable slicing disc. Changing thickness settings with other discs or blades installed will have no effect on operation.

Setting Up Your Food Processor

Installing Other Slicing or Shredding Discs

IMPORTANT: The optional julienne and plane/shave discs can only be installed in one direction. When using the reversible shredding disc, have the desired side (medium/fine) facing UP.

1. Holding the desired disc by the 2 finger grips, insert the slicing/shredding adapter into the hole in the bottom of the disc.

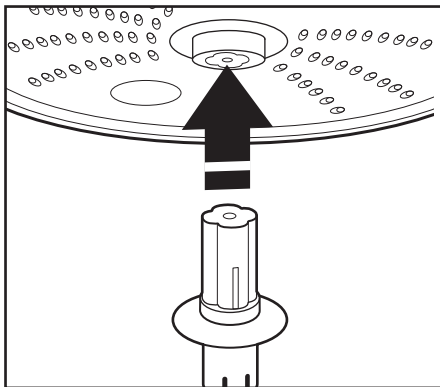

2. Slide the drive adapter into the slicing adapter as far as it will go, until it clicks into place.

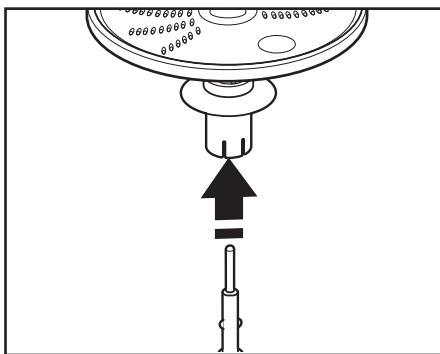

3. With the work bowl installed, slide the drive adapter onto the power shaft.

TIP: You may need to turn the disc/drive adapter until it drops down into place.

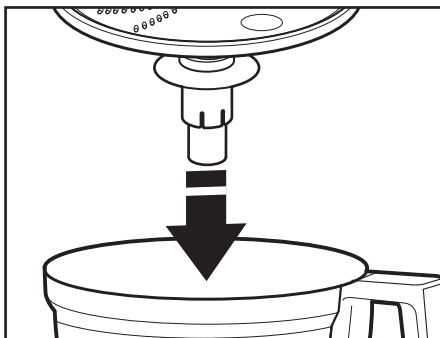

4. Install the work bowl cover, being sure it locks into place.



Setting Up Your Food Processor

Installing the Multipurpose Blade or Dough Blade

IMPORTANT: The multipurpose blade and dough blade can only be used with the work bowl.

1. Place the blade on the power shaft.
2. Rotate the blade so it falls into place on the power shaft.

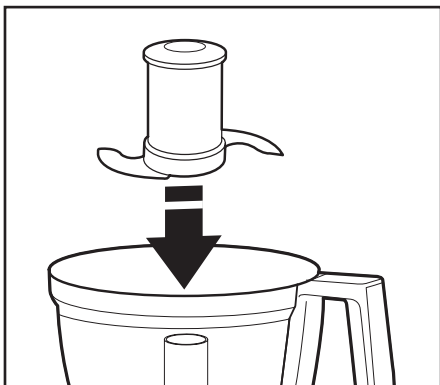

3. Push to lock: Press down firmly on the multipurpose blade until it is down as far as it will go. The multipurpose blade features an internal seal that fits tightly over the center of the work bowl.

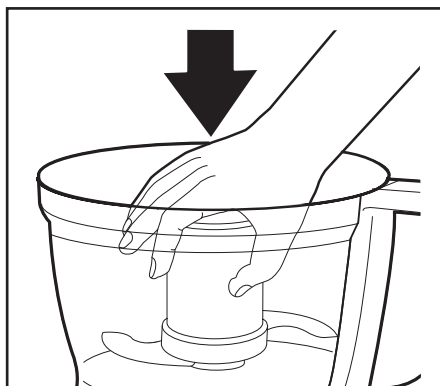

4. Install the work bowl cover, being sure it locks into place.

Installing the Mini-Bowl and Mini-Blade

1. Place the mini-bowl inside the work bowl over the power shaft. Rotate the mini-bowl until the tabs on the top edge of the bowl drop into the indents on the top of the work bowl.

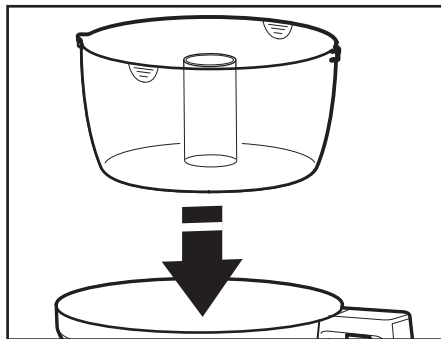

2. Insert the drive adapter into the mini-blade, and place on the power shaft. It may be necessary to rotate the blade until it falls into place. Press down firmly to lock it into place.

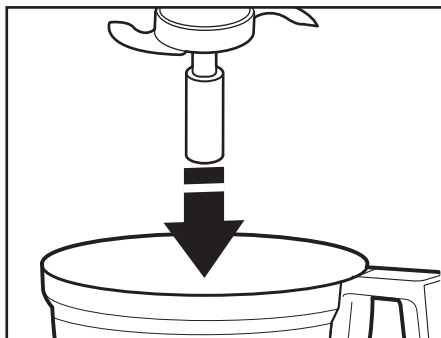

3. Install the work bowl cover, being sure it locks into place.
4. To remove the mini-bowl after processing, remove the mini-blade by pulling straight up on the cap. Then lift the bowl straight up and out, using the two finger grips located along the top edge of the bowl.

Setting Up Your Food Processor

Installing the Optional Chef's Bowl (not included)

The optional Chef's Bowl can only be used with the slicing or shredding discs. It cannot be used with the multipurpose blade.

1. Place the Chef's Bowl inside the work bowl, sliding it down over the power shaft. Rotate the Chef's Bowl until it drops into place. Once in place, it cannot be rotated.

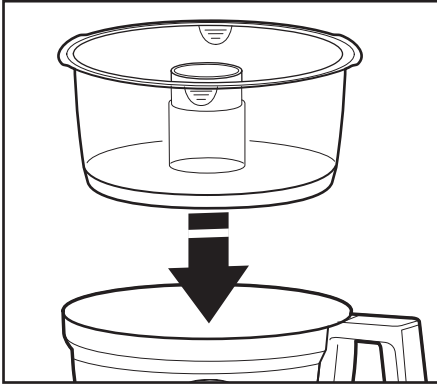

2. Install the desired slicing or shredding disc.
3. Install the work bowl cover, being sure it locks into place.

To remove the Chef's Bowl after processing, grasp by the finger grips along the top edge of the bowl and lift straight up and out.

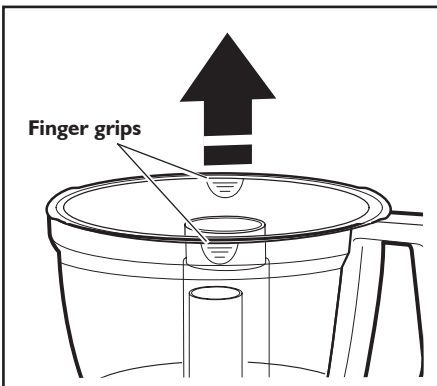

Using the 3-in-1 Feed Tube

The 3-in-1 feed tube features a 3-piece food pusher. Use the entire food pusher to process large items, or use the inner portions to create medium-sized or small feed tubes to process smaller items.

To slice or shred small items, insert the 3-piece food pusher into the feed tube, then lift out the small pusher to remove. Use the small feed tube and pusher to process small or slender items, like single carrots or celery stalks. When not using the small feed tube, be sure to lock the small pusher into place.

To slowly drizzle oil or other liquid ingredients into the work bowl, just fill the small pusher with the desired amount of liquid. A small hole in the bottom of the pusher will drizzle the liquid ingredient at a constant rate.

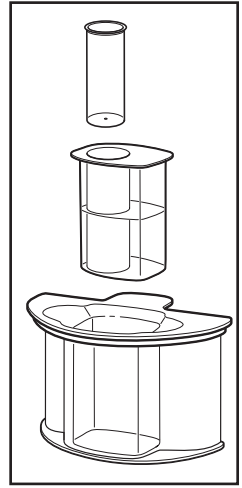

WARNING



Rotating Blade Hazard

Always use food pusher.

Keep fingers out of openings.

Keep away from children.

Failure to do so can result in amputation or cuts.

Before Use

Before operating the Food Processor, be sure the work bowl, blades, and work bowl cover are properly assembled on the Food Processor base (see “Setting Up Your Food Processor” starting on page 10).

Maximum Liquid Level

This line on the work bowl indicates the maximum level of liquid that can be processed by the Food Processor.

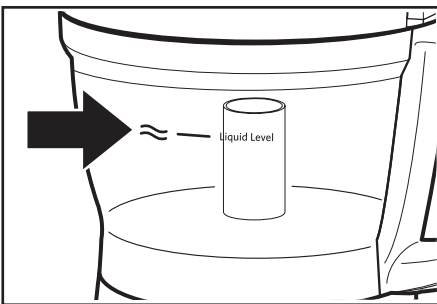

Using the Low/High Speed Control

1. To turn on the Food Processor, press the Low or High button. The Food Processor will run continuously and the indicator light will glow.
2. To stop the Food Processor, press the OFF button. The indicator light will go out and the blade or disc will stop within a few seconds.
3. Wait until the blade or disc comes to a complete stop before removing the work bowl cover. Be sure to turn off the Food Processor before removing the work bowl cover, or before unplugging the Food Processor.

NOTE: If the Food Processor fails to operate, make sure the work bowl and cover are properly locked on the base (see “Setting Up Your Food Processor”).

Using the Pulse Control

The pulse control allows precise control of the duration and frequency of processing. It's great for jobs which require a light touch. Just press and hold the PULSE Button to start processing at high speed, and release it to stop.

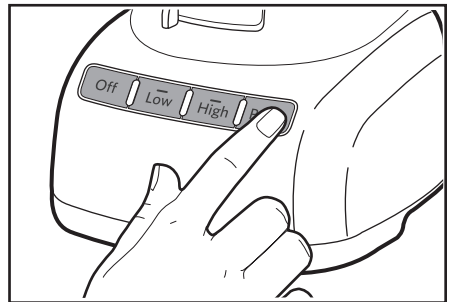

⚠ WARNING

Cut Hazard

Handle blades carefully.

Failure to do so can result in cuts.

Removing Processed Foods

1. Press the OFF Button.
2. Unplug the Food Processor before disassembling.
3. Turn the work bowl cover to the left and remove.

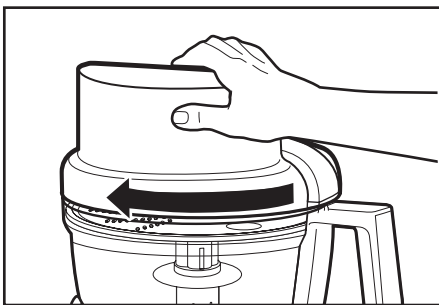
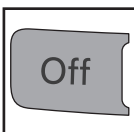

4. If using a disc, remove it before removing the bowl. Holding the disc by the 2 finger grips, lift it straight up. Remove the adapter.

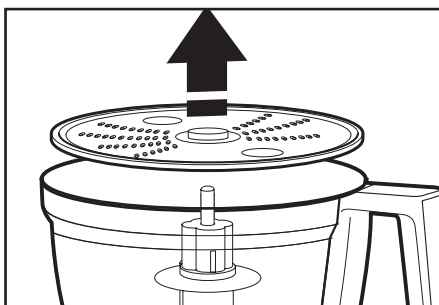

5. If using the mini-bowl, grasp and remove the bowl using the finger grips located along the top edge of the bowl.

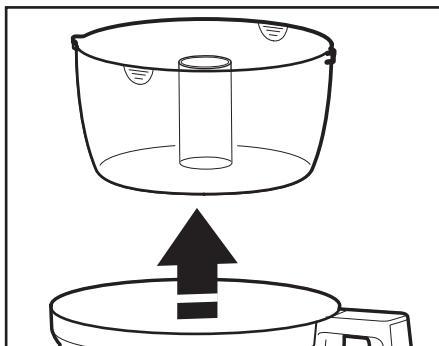

6. Turn the work bowl to the left to unlock it from the base. Lift to remove.

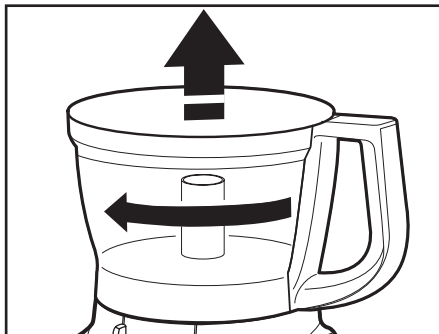

7. The multipurpose blade can be removed from the work bowl before the contents are emptied. You may also leave the blade locked in place. Then remove food from the bowl and blade with a spatula.

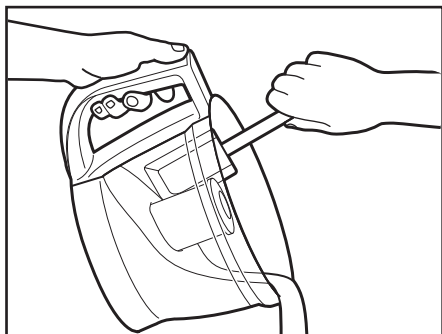

Cleaning the Food Processor

⚠️ WARNING

Cut Hazard

Handle blades carefully.

Failure to do so can result in cuts.

1. Press the OFF Button.
2. Unplug the Food Processor before Cleaning.
3. Wipe the base and cord with a warm, sudsy cloth, and wipe clean with a damp cloth. Dry with a soft cloth. Do not use abrasive cleansers or scouring pads.
4. All the other parts of the Food Processor are dishwasher safe. When washing parts in a dishwasher, follow the following tips:
 - Load parts away from exposed heating elements in the dishwasher.
 - Bowls should be loaded upside down, not on their sides.
 - Avoid using high temperature settings such as sani-rinse or steam settings.
5. If washing the Food Processor parts by hand, avoid the use of abrasive cleansers or scouring pads. They may scratch or cloud the work bowl and cover. Thoroughly dry all parts after washing.

6. To prevent damage to the locking system, always store the work bowl and work bowl cover in the unlocked position when not in use.



7. Wrap the power cord around the work bowl. Secure the plug by clipping it to the cord.
8. Disassembled discs, shafts, and blades should be stored in the provided storage case, and in a location out of the reach of children.

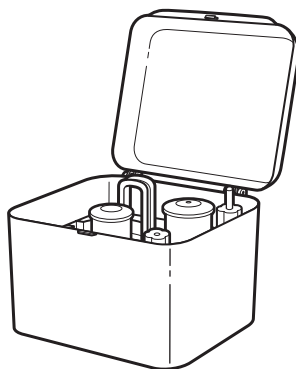

Food Processing Tips

!WARNING

Cut Hazard

Handle blades carefully.

Failure to do so can result in cuts.

Using the Multipurpose Blade

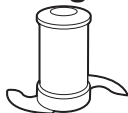

To chop fresh fruits or vegetables:

Peel, core, and/or remove seeds. Cut food in 1 to 1½-inch (2.5-3.75 cm) pieces. Process food to desired size, using short pulses, 1 to 2 seconds each time. Scrape sides of bowl, if necessary.

To puree cooked fruits and vegetables (except potatoes):

Add 1/4 cup (60 ml) liquid from recipe per cup (235 ml) of food. Process food, using short pulses, until finely chopped. Then process continuously until reaching desired texture. Scrape sides of bowl, if necessary.

To prepare mashed potatoes:

Shred hot cooked potatoes using the shredding disc. Exchange shredding disc for multipurpose blade. Add softened butter, milk, and seasonings. Pulse 3 to 4 times, 2 to 3 seconds each time, until smooth and milk is absorbed. Do not over process.

To chop dried (or sticky) fruits:

The food should be cold. Add 1/4 cup (60 ml) flour from recipe per 1/2 cup (120 ml) dried fruit. Process fruit, using short pulses, until reaching desired texture.

To finely chop citrus peel:

With sharp knife, peel colored portion (without white membrane) from citrus. Cut peel in small strips. Process until finely chopped.

To mince garlic or to chop fresh herbs or small quantities of vegetables:

With processor running, add food through the feed tube. Process until chopped. For best results, make sure work bowl and herbs are very dry before chopping.

To chop nuts or make nut butters:

Process up to 3 cups (710 ml) of nuts to desired texture, using short pulses, 1 to 2 seconds each time. For a coarser texture, process smaller batches, pulsing 1 or 2 times, 1 to 2 seconds each time. Pulse more often for finer texture. For nut butters, process continuously until smooth. Store in refrigerator.

NOTE: Processing nuts and other hard foods may scratch the surface finish on the inside of the bowl.

To chop cooked or raw meat, poultry or seafood:

The food should be very cold. Cut in 1-inch (2.5 cm) pieces. Process up to 1 pound (455 g) at a time to desired size, using short pulses, 1 to 2 seconds each time. Scrape sides of bowl, if necessary.

To make bread, cookie, or cracker crumbs:

Break food into 1½ to 2-inch (3.75-5 cm) pieces. Process until fine. For larger pieces, pulse 2 to 3 times, 1 to 2 seconds each time. Then process until fine.

To melt chocolate in a recipe:

Combine chocolate and sugar from recipe in work bowl. Process until finely chopped. Heat liquid from recipe. With processor running, pour hot liquid through the feed tube. Process until smooth.

To grate hard cheeses, such as Parmesan and Romano:

Never attempt to process cheese that cannot be pierced with the tip of a sharp knife. You can use the multi-purpose blade to grate hard cheeses. Cut cheese in 1-inch (2.5 cm) pieces. Place in work bowl. Process, using short pulses, until coarsely chopped. Process continuously until finely grated. Pieces of cheese can also be added through the feed tube while the processor is running.

Using a Slicing or Shredding Disc



To slice or shred fruits or vegetables that are long and relatively small in diameter, such as celery, carrots, and bananas:

Cut food to fit feed tube vertically or horizontally, and pack feed tube securely to keep food positioned properly. Process using even pressure.

Or use the small feed tube in the two-piece food pusher. Position food vertically in the tube and use the small food pusher to process food.



To slice or shred fruits and vegetables that are round, such as onions, apples, and green peppers:

Peel, core, and remove seeds. Cut in halves or quarters to fit feed tube. Position in feed tube. Process using even pressure.

To slice or shred fruits and vegetables that are small, such as strawberries, mushrooms, and radishes:

Position food vertically or horizontally in layers within the feed tube. Fill feed tube in order to keep food positioned properly. Process, using even pressure. Or use the small feed tube in the two-piece food pusher. Position food vertically in the tube and use the small food pusher to process food.

To slice uncooked meat or poultry, such as stir-fry meats:

Cut or roll food to fit feed tube. Wrap and freeze food until hard to the touch, 30 minutes to 2 hours, depending on thickness of food. Check to be sure you can still pierce food with the tip of a sharp knife. If not, allow to thaw slightly. Process, using even pressure.

To slice cooked meat or poultry, including salami, pepperoni, etc.:

Food should be very cold. Cut in pieces to fit feed tube. Process food using firm, even pressure.

To shred spinach and other leaves:
Stack leaves. Roll up and stand up in feed tube. Process using even pressure.

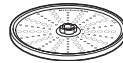

To shred firm and soft cheeses:

Firm cheese should be very cold. For best results with soft cheeses, such as mozzarella, freeze 10 to 15 minutes before processing. Cut to fit feed tube. Process using even pressure.

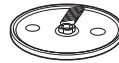

To cut julienne, or match stick, strips of vegetables and fruits using the optional julienne disc (not included):

Cut food to fit feed tube horizontally. Position food horizontally in feed tube. Process, using even pressure to make plank-like slices. Re-stack slices and position vertically or horizontally in feed tube. Process using even pressure.



Using the Dough Blade

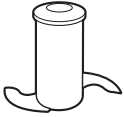

The dough blade is specially designed for mixing and kneading yeast dough quickly and thoroughly. For the best results, do not knead recipes which use more than 2-3 cups (475 - 710 ml) of flour.

Helpful Hints

- To avoid damage to the blade or motor, do not process food that is so hard or firmly frozen that it cannot be pierced with the tip of a sharp knife. If a piece of hard food, such as a carrot, becomes wedged or stuck on the blade, stop the processor and remove the blade. Gently remove food from the blade.
- Do not overfill work bowl or mini-bowl. For thin mixtures, fill work bowl up to 1/2 to 2/3 full. For thicker mixtures, fill work bowl up to 3/4 full. For liquids, fill up to the maximum level as described on page 17. When chopping, the work bowl should be no more than 1/3 to 1/2 full. Use the mini-bowl for up to 1 cup (235 ml) of liquid or 1/2 cup (155 g) solids.
- Position slicing discs so the cutting surface is just to the right of the feed tube. This allows the blade a full rotation before contacting the food.
- To capitalize on the speed of the processor, drop ingredients to be chopped through the feed tube while the processor is running.
- Different foods require varying degrees of pressure for best shredding and slicing results. In general, use light pressure for soft, delicate foods (strawberries, tomatoes, etc.), moderate pressure for medium foods (zucchini, potatoes, etc.), and firmer pressure for harder foods (carrots, apples, hard cheeses, partially frozen meats, etc.).
- Soft and medium-hard cheese may spread out or roll up on the shredding disc. To avoid this, shred only well-chilled cheese.

- Sometimes slender foods, such as carrots or celery, fall over in the feed tube, resulting in an uneven slice. To minimize this, cut food in several pieces and pack the feed tube with the food. For processing small or slender items, the small feed tube in the two piece food pusher will prove especially convenient.



- When preparing a cake or cookie batter or quick bread, use the multipurpose blade to cream fat and sugar first. Add dry ingredients last. Place nuts and fruit on top of flour mixture to prevent overchopping. Process nuts and fruits, using short pulses, until blended with other ingredients. Do not overprocess.
- When shredded or sliced food piles up on one side of the bowl, stop the processor and redistribute the food using a spatula.
- When food quantity reaches the bottom of a slicing or shredding disc, remove the food.
- A few larger pieces of food may remain on top of the disc after slicing or shredding. If desired, cut these by hand and add to mixture.
- Organize processing tasks to minimize bowl cleanup. Process dry or firm ingredients before liquid ingredients.
- To clean ingredients from the multipurpose blade easily, just empty the work bowl, replace the lid, and pulse 1 to 2 seconds to spin the blade clean.
- After removing the work bowl cover, place it upside down on the counter. This will help keep the counter clean.

Tips and Tricks for Great Results

- Use the spatula to remove ingredients from the work bowl.



- Your Food Processor is not designed to perform the following functions:
 - Grind coffee beans, grains, or hard spices
 - Grind bones or other inedible parts of food
 - Liquefy raw fruits or vegetables
 - Slice hard-cooked eggs or unchilled meats.
- If any plastic parts should discolor due to the types of food processed, clean them with lemon juice

Part Numbers for Accessories

The following accessories are available for separate purchase for your Food Processor. See page 25 for information on where to order.

Included Accessories:

Description

Part Number

Blades:

Multipurpose Blade

KFP13BL

Dough Blade

KFP13DB

Mini-Multipurpose Blade

KFP13BM

Discs:

Adjustable Slicing Disc

KFP13ESL

Reversible Shredding Disc

KFP13RD

Bowls and Cover:

Work Bowl

KFP13WBOB

Work Bowl Lid

KFPL31FT

3-in-1 Food Pusher

KFP31FTP

Mini-Bowl

KFP13MB4

Other Accessories:

Storage Case

KFP13SC

Slicing Adapter

Disc Adapter

Drive Adapter

Available Accessories (not included):

Description

Part Number

Julienne Disc

KFP13JD

Grate/Shave Disc

Call

Egg Whip

KFP13EW

Chef's Bowl

Call

If your Food Processor should malfunction or fail to operate, check the following:

Food Processor doesn't run:

- Make sure that the bowl and lid are properly aligned and locked in place and the large food pusher is inserted in the feed tube.
- When using the large feed tube opening, make sure that food is not above the Max. Fill line on the feed tube.

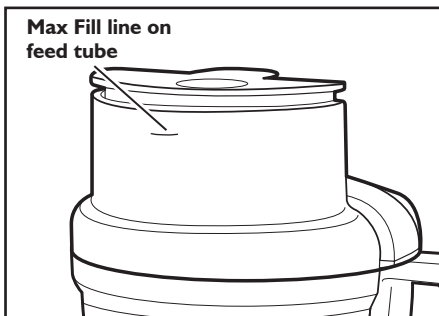

- Press only one button at a time. The Food Processor will not operate if more than one button is pressed at the same time.
- Is the Food Processor plugged in?
- Is the fuse in the circuit to the Food Processor in working order? If you have a circuit breaker box, be sure the circuit is closed.
- Unplug the Food Processor, then plug it back into the outlet.
- If the Food Processor is not at room temperature, wait until it reaches room temperature and retry.

Food Processor not shredding or slicing properly:

- Make sure the raised-blade side of the disc is positioned face up on the common adapter.
- If using the adjustable slicing blade, make sure it is set to the correct thickness.
- Make sure ingredients are suitable for slicing or shredding. See "Tips and Tricks for Great Results."

If the work bowl cover won't close when using the disc:

- Make sure the disc is installed correctly, with the raised nub on top, and is positioned properly on the drive adapter.

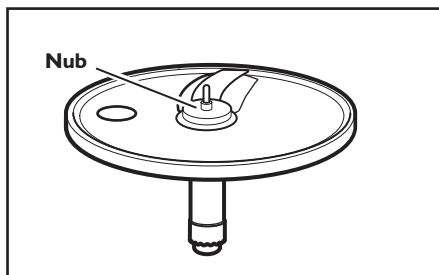

If the problem is not due to one of the above items, see "Warranty".

Do not return the Food Processor to the retailer. Retailers do not provide service.

KitchenAid® Food Processor Warranty for the 50 United States, Puerto Rico, and Canada

This warranty extends to the purchaser and any succeeding owner for Food Processors operated in the 50 United States, the District of Columbia, Puerto Rico, and Canada.

Length of Warranty:	One Year Full Warranty from date of purchase.
KitchenAid Will Pay for Your Choice of:	Hassle-Free Replacement of your Food Processor. See the next page for details on how to arrange for service, or call the Customer Satisfaction Center toll-free at 1-800-541-6390 . OR The replacement parts and repair labor costs to correct defects in materials and workmanship. Service must be provided by an Authorized KitchenAid Service Center.
KitchenAid Will Not Pay for:	<ul style="list-style-type: none">A. Repairs when Food Processor is used in other than normal single family home use.B. Damage resulting from accident, alteration, misuse or abuse.C. Any shipping or handling costs to deliver your Food Processor to an Authorized Service Center.D. Replacement parts or repair labor costs for Food Processors operated outside the 50 United States, District of Columbia, Puerto Rico, and Canada.
DISCLAIMER OF IMPLIED WARRANTIES; LIMITATION OF REMEDIES IMPLIED WARRANTIES, INCLUDING TO THE EXTENT APPLICABLE WARRANTIES OF MERCHANTABILITY OR FITNESS FOR A PARTICULAR PURPOSE, ARE EXCLUDED TO THE EXTENT LEGALLY PERMISSIBLE. ANY IMPLIED WARRANTIES THAT MAY BE IMPOSED BY LAW ARE LIMITED TO ONE YEAR, OR THE SHORTEST PERIOD ALLOWED BY LAW. SOME STATES AND PROVINCES DO NOT ALLOW LIMITATIONS OR EXCLUSIONS ON HOW LONG AN IMPLIED WARRANTY OF MERCHANTABILITY OR FITNESS LASTS, SO THE ABOVE LIMITATIONS OR EXCLUSIONS MAY NOT APPLY TO YOU. IF THIS PRODUCT FAILS TO WORK AS WARRANTED, CUSTOMER'S SOLE AND EXCLUSIVE REMEDY SHALL BE REPAIR OR REPLACEMENT ACCORDING TO THE TERMS OF THIS LIMITED WARRANTY. KITCHENAID AND KITCHENAID CANADA DO NOT ASSUME ANY RESPONSIBILITY FOR INCIDENTAL OR CONSEQUENTIAL DAMAGES. This warranty gives you specific legal rights and you may also have other rights which vary from state to state or province to province.	



Hassle-Free Replacement Warranty – 50 United States and Puerto Rico

We're so confident the quality of our products meets the exacting standards of KitchenAid that, if your Food Processor should fail within the first year of ownership, KitchenAid will arrange to deliver an identical or comparable replacement to your door free of charge and arrange to have your original Food Processor returned to us. Your replacement unit will also be covered by our one year limited warranty. Please follow these instructions to receive this quality service.

If your Food Processor should fail within the first year of ownership, simply call our toll-

free Customer Satisfaction Center at **1-800-541-6390** Monday through Saturday. Please have your original sales receipt available when you call. Proof of purchase will be required to initiate the claim. Give the consultant your complete shipping address. (No P.O. Box numbers, please.)

When you receive your replacement Food Processor, use the carton and packing materials to pack up your original Food Processor. In the carton, include your name and address on a sheet of paper along with a copy of the proof of purchase (register receipt, credit card slip, etc.).

Hassle-Free Replacement Warranty – Canada

We're so confident the quality of our products meets the exacting standards of the KitchenAid® brand that, if your Food Processor should fail within the first year of ownership, KitchenAid Canada will replace your Food Processor with an identical or comparable replacement. Your replacement unit will also be covered by our one year limited warranty. Please follow these instructions to receive this quality service.

If your Food Processor should fail within the first year of ownership, take the Food Processor or ship collect to an Authorized KitchenAid Service Centre. In the carton

include your name and complete shipping address along with a copy of the proof of purchase (register receipt, credit card slip, etc.). Your replacement Food Processor will be returned prepaid and insured. If you are unable to obtain satisfactory service in this manner call our toll-free Customer Interaction Centre at **1-800-807-6777**.

Or write to us at:
Customer eXperience Centre
KitchenAid Canada
200 - 6750 Century Ave.
Mississauga, ON L5N 0B7

Arranging for Service after the Warranty Expires, or Ordering Accessories and Replacement Parts

In the United States and Puerto Rico:

For service information, , or to order accessories or replacement parts, call toll-free at **1-800-541-6390** or write to: Customer Satisfaction Center, KitchenAid Portable Appliances, P.O. Box 218, St. Joseph, MI 49085-0218

Outside the United States and Puerto Rico:

Consult your local KitchenAid dealer or the store where you purchased the Food Processor for information on how to obtain service.

For service information in Canada:

Call toll-free **1-800-807-6777**.

Or write to:
Customer eXperience Centre
KitchenAid Canada
200 - 6750 Century Ave.
Mississauga, ON L5N 0B7



FOR THE WAY IT'S MADE.[®]

- ® Registered trademark/[™] Trademark/The shape of the mixer is a registered trademark of KitchenAid, U.S.A.
- ® Marque déposée/[™] Marque déposée/La forme du batteur est une marque déposée de KitchenAid, Etats-Unis
- ® Marca registrada/[™] Marca de comercio/La forma de la batidora es una marca de comercio de KitchenAid, U.S.A.

W10407578A

© 2011

All rights reserved.

Tous droits réservés.

Todos los derechos reservados.

07/11

Free Manuals Download Website

<http://myh66.com>

<http://usermanuals.us>

<http://www.somanuals.com>

<http://www.4manuals.cc>

<http://www.manual-lib.com>

<http://www.404manual.com>

<http://www.luxmanual.com>

<http://aubethermostatmanual.com>

Golf course search by state

<http://golfingnear.com>

Email search by domain

<http://emailbydomain.com>

Auto manuals search

<http://auto.somanuals.com>

TV manuals search

<http://tv.somanuals.com>