

# **KitchenAid®**

---

## **ELECTRIC RANGE ARCHITECT® SERIES II**

### **Use & Care Guide**

For questions about features, operation/performance, parts accessories or service, call: **1-800-422-1230**  
or visit our website at **www.kitchenaid.com**

In Canada, call for assistance, installation and service, call: **1-800-807-6777**  
or visit our website at **www.KitchenAid.ca**

---

Table of Contents ..... 2



**Models KESK901 KESS907 KERS807 KESS908 YKESS907 YKERS807 YKESS908**

**W10109440**

# TABLE OF CONTENTS

<b>RANGE SAFETY</b> .....	<b>3</b>	<b>OVEN USE</b> .....	<b>19</b>
The Anti-Tip Bracket .....	3	Aluminum Foil .....	19
<b>PARTS AND FEATURES</b> .....	<b>5</b>	Bakeware.....	19
<b>COOKTOP USE</b> .....	<b>9</b>	Meat Thermometer.....	19
Ceramic Glass .....	9	Temperature Probe (on convection models) .....	19
Cookware .....	9	Oven Vent.....	20
Home Canning .....	10	Positioning Racks and Bakeware .....	20
Cooktop Controls - Touch-Activated		Bake.....	21
Custom Control Temperature Management System .....	10	Broil.....	21
Cooktop Controls - Custom Knobs		Convection Cooking (on some models).....	22
Custom Control Temperature Management System .....	12	EasyConvect Conversion (on some models).....	22
Cooktop Controls - Standard Knobs.....	13	Convection Bake (on some models) .....	22
<b>GLASS TOUCH-ACTIVATED</b>		Convection Roast (on some models).....	23
<b>ELECTRONIC OVEN CONTROL</b> .....	<b>15</b>	Convection Broil (on some models) .....	24
Electronic Control Pads .....	16	Proofing Bread (on some models) .....	24
Oven Displays .....	16	Timed Cooking .....	24
Start .....	16	Warming Drawer (on some models).....	25
Control Lock.....	16	<b>RANGE CARE</b> .....	<b>26</b>
Off.....	16	Self-Cleaning Cycle (on some models).....	26
Clock/Timer Display .....	16	General Cleaning .....	27
Timer.....	16	Oven Light(s).....	28
<b>OPTIONS</b> .....	<b>16</b>	Oven Door .....	29
Options Selection Pad .....	16	Storage Drawer .....	29
Fahrenheit and Celsius - Option 1 .....	16	Warming Drawer (on some models).....	29
Tones - Options 2 , 3, 4 .....	17	<b>TROUBLESHOOTING</b> .....	<b>30</b>
Dehydrate - Option 5		<b>ASSISTANCE OR SERVICE</b> .....	<b>31</b>
(on convection models, closed door) .....	17	In the U.S.A. ....	31
Oven Temperature Calibration - Option 6 .....	17	In Canada .....	31
Sabbath Mode - Option 7 .....	18	<b>WARRANTY</b> .....	<b>32</b>

# RANGE SAFETY

## Your safety and the safety of others are very important.

We have provided many important safety messages in this manual and on your appliance. Always read and obey all safety messages.



This is the safety alert symbol.

This symbol alerts you to potential hazards that can kill or hurt you and others.

All safety messages will follow the safety alert symbol and either the word "DANGER" or "WARNING."

These words mean:

**⚠ DANGER**

**You can be killed or seriously injured if you don't immediately follow instructions.**

**⚠ WARNING**

**You can be killed or seriously injured if you don't follow instructions.**

All safety messages will tell you what the potential hazard is, tell you how to reduce the chance of injury, and tell you what can happen if the instructions are not followed.

## The Anti-Tip Bracket

The range will not tip during normal use. However, the range can tip if you apply too much force or weight to the open door without the anti-tip bracket fastened down properly.

**⚠ WARNING**

### Tip Over Hazard

**A child or adult can tip the range and be killed.**

**Connect anti-tip bracket to rear range foot.**

**Reconnect the anti-tip bracket, if the range is moved.**

**See the installation instructions for details.**

**Failure to follow these instructions can result in death or serious burns to children and adults.**



### Anti-Tip Bracket

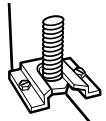

Range Foot

**Making sure the anti-tip bracket is installed:**

- Slide range forward.
- Look for the anti-tip bracket securely attached to floor.
- Slide range back so rear range foot is under anti-tip bracket.

The California Safe Drinking Water and Toxic Enforcement Act requires the Governor of California to publish a list of substances known to the State of California to cause cancer, birth defects, or other reproductive harm, and requires businesses to warn of potential exposure to such substances.

**WARNING:** This product contains a chemical known to the State of California to cause cancer, birth defects, or other reproductive harm.

This appliance can cause low-level exposure to some of the substances listed, including benzene, formaldehyde, carbon monoxide, and toluene.

# IMPORTANT SAFETY INSTRUCTIONS

**WARNING:** To reduce the risk of fire, electrical shock, injury to persons, or damage when using the range, follow basic precautions, including the following:

- **WARNING:** TO REDUCE THE RISK OF TIPPING OF THE RANGE, THE RANGE MUST BE SECURED BY PROPERLY INSTALLED ANTI-TIP DEVICES. TO CHECK IF THE DEVICES ARE INSTALLED PROPERLY, SLIDE RANGE FORWARD, LOOK FOR ANTI-TIP BRACKET SECURELY ATTACHED TO FLOOR, AND SLIDE RANGE BACK SO REAR RANGE FOOT IS UNDER ANTI-TIP BRACKET.
  - **CAUTION:** Do not store items of interest to children in cabinets above a range or on the backguard of a range – children climbing on the range to reach items could be seriously injured.
  - Proper Installation – Be sure the range is properly installed and grounded by a qualified technician.
  - Never Use the Range for Warming or Heating the Room.
  - Do Not Leave Children Alone – Children should not be left alone or unattended in area where the range is in use. They should never be allowed to sit or stand on any part of the range.
  - Wear Proper Apparel – Loose-fitting or hanging garments should never be worn while using the range.
  - User Servicing – Do not repair or replace any part of the range unless specifically recommended in the manual. All other servicing should be referred to a qualified technician.
  - Storage in or on the Range – Flammable materials should not be stored in an oven or near surface units.
  - Do Not Use Water on Grease Fires – Smother fire or flame or use dry chemical or foam-type extinguisher.
  - Use Only Dry Potholders – Moist or damp potholders on hot surfaces may result in burns from steam. Do not let potholder touch hot heating elements. Do not use a towel or other bulky cloth.
  - DO NOT TOUCH SURFACE UNITS OR AREAS NEAR UNITS – Surface units may be hot even though they are dark in color. Areas near surface units may become hot enough to cause burns. During and after use, do not touch, or let clothing or other flammable materials contact surface units or areas near units until they have had sufficient time to cool. Among those areas are the cooktop and surfaces facing the cooktop.
  - Use Proper Pan Size – The range is equipped with one or more surface units of different size. Select utensils having flat bottoms large enough to cover the surface unit heating element. The use of undersized utensils will expose a portion of the heating element to direct contact and may result in ignition of clothing. Proper relationship of utensil to burner will also improve efficiency.
  - Never Leave Surface Units Unattended at High Heat Settings – Boilover causes smoking and greasy spillovers that may ignite.
  - Make Sure Reflector Pans or Drip Bowls Are in Place – Absence of these pans or bowls during cooking may subject wiring or components underneath to damage.
  - Protective Liners – Do not use aluminum foil to line surface unit drip bowls or oven bottoms, except as suggested in the manual. Improper installation of these liners may result in a risk of electric shock, or fire.
  - Glazed Cooking Utensils – Only certain types of glass, glass/ceramic, ceramic, earthenware, or other glazed utensils are suitable for range-top service without breaking due to the sudden change in temperature.
  - Utensil Handles Should Be Turned Inward and Not Extend Over Adjacent Surface Units – To reduce the risk of burns, ignition of flammable materials, and spillage due to unintentional contact with the utensil, the handle of a utensil should be positioned so that it is turned inward, and does not extend over adjacent surface units.
  - Do Not Soak Removable Heating Elements – Heating elements should never be immersed in water.
  - Do Not Cook on Broken Cooktop – If cooktop should break, cleaning solutions and spillovers may penetrate the broken cooktop and create a risk of electric shock. Contact a qualified technician immediately.
  - Clean Cooktop With Caution – If a wet sponge or cloth is used to wipe spills on a hot cooking area, be careful to avoid steam burn. Some cleaners can produce noxious fumes if applied to a hot surface.
  - Use Care When Opening Door – Let hot air or steam escape before removing or replacing food.
  - Do Not Heat Unopened Food Containers – Build-up of pressure may cause container to burst and result in injury.
  - Keep Oven Vent Ducts Unobstructed.
  - Placement of Oven Racks – Always place oven racks in desired location while oven is cool. If rack must be moved while oven is hot, do not let potholder contact hot heating element in oven.
  - DO NOT TOUCH HEATING ELEMENTS OR INTERIOR SURFACES OF OVEN – Heating elements may be hot even though they are dark in color. Interior surfaces of an oven become hot enough to cause burns. During and after use, do not touch, or let clothing or other flammable materials contact heating elements or interior surfaces of oven until they have had sufficient time to cool. Other surfaces of the appliance may become hot enough to cause burns – among these surfaces are oven vent openings and surfaces near these openings, oven doors, and windows of oven doors.
- For self-cleaning ranges –**
- Do Not Clean Door Gasket – The door gasket is essential for a good seal. Care should be taken not to rub, damage, or move the gasket.
  - Do Not Use Oven Cleaners – No commercial oven cleaner or oven liner protective coating of any kind should be used in or around any part of the oven.
  - Clean Only Parts Listed in Manual.
  - Before Self-Cleaning the Oven – Remove broiler pan and other utensils.
- For units with ventilating hood –**
- Clean Ventilating Hoods Frequently – Grease should not be allowed to accumulate on hood or filter.
  - When flambeing foods under the hood, turn the fan on.

## SAVE THESE INSTRUCTIONS

# PARTS AND FEATURES

This manual covers several different models. The range you have purchased may have some or all of the items listed. The locations and appearances of the features shown here may not match those of your model.

## Glass Touch-Activated Electronic Oven Control Panel (Models KESS908 and YKESS908)

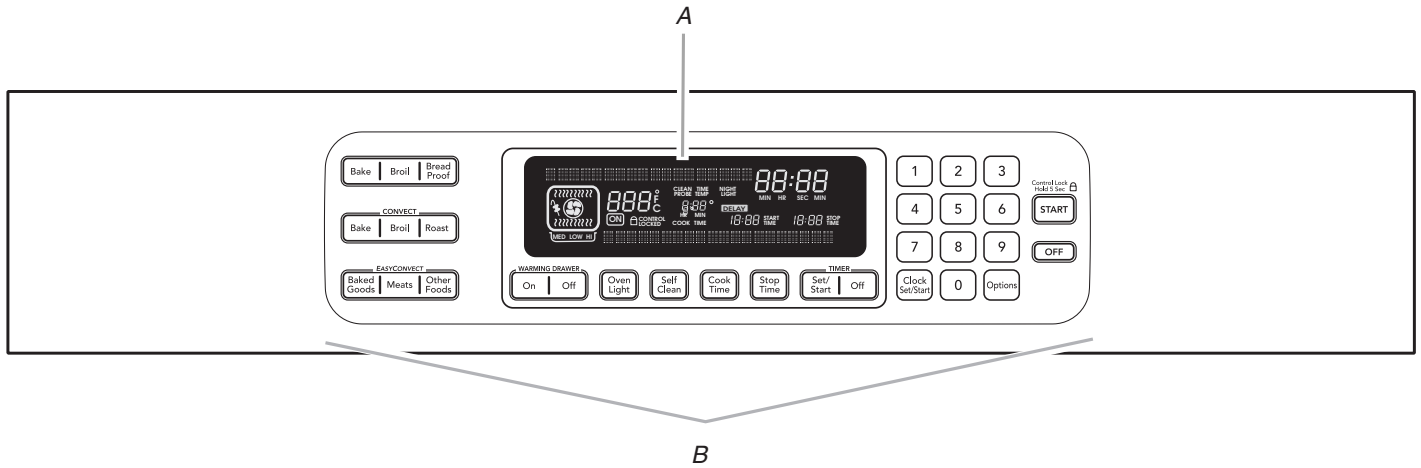

A. Oven display  
B. Oven control panel

## Glass Touch-Activated Electronic Custom Control Cooktop Control

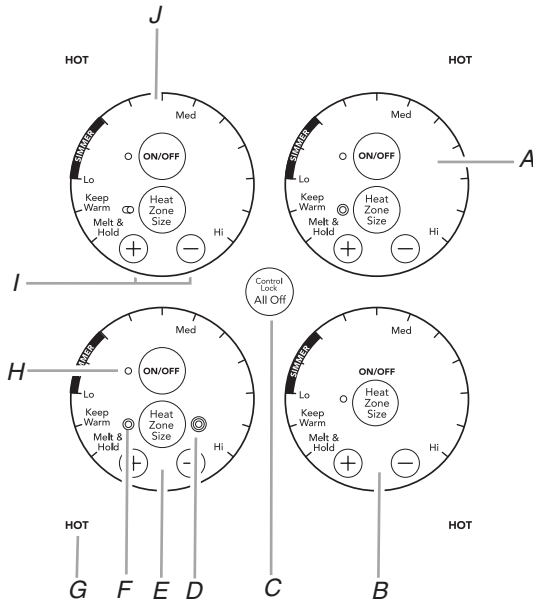

- A. Right rear touch control (dual-size element)
- B. Right front touch control (single element)
- C. Control Lock/All Off
- D. Zone diameter indicator (triple)
- E. Left front touch control (triple-size element)
- F. Zone diameter indicator (dual)
- G. Hot surface indicator lights
- H. Zone diameter indicator (single)
- I. Increase/Decrease temperature touch control
- J. Left rear touch control (dual-size element)

## Range

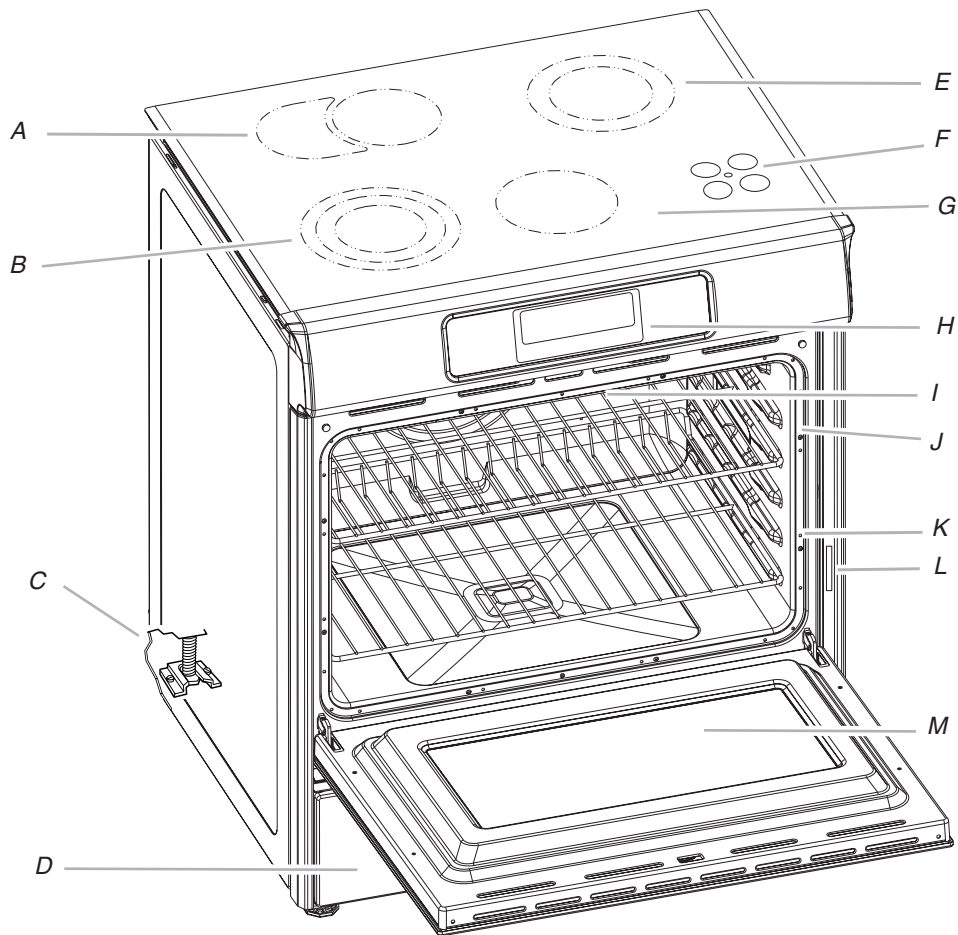

A. Dual-size oval element  
 B. Triple-size element  
 C. Anti-tip bracket  
 D. Warming drawer

E. Dual-size element  
 F. Electronic cooktop touch controls  
 G. Ceramic surface cooking area  
 H. Oven control panel  
 I. Automatic oven light switch/  
 self-clean latch

J. Temperature probe jack  
 (not shown)  
 K. Door gasket  
 L. Model and serial number  
 M. Oven door window

**Parts and Features not shown**  
 (on some models)  
 Broiler pan and grid  
 Roasting rack  
 Temperature probe

## Oven Interior

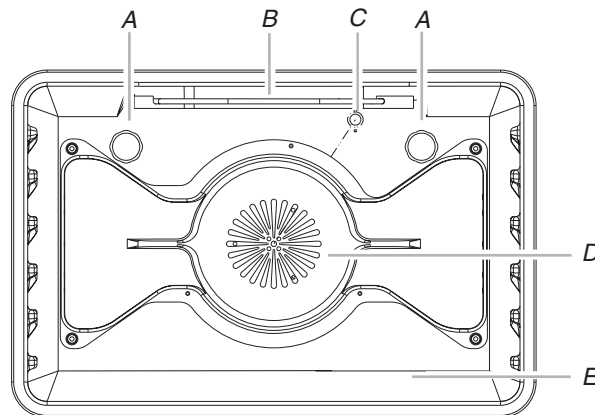

A. Oven lights  
 B. Full and center broil elements  
 C. Oven cavity sensor

D. T.H.E.™ convection fan and element (not visible)  
 E. CleanBake™ element (not visible)

## Glass Touch-Activated Electronic Oven Control/Cooktop Knob Control Models

### Electronic Custom Control Knob (Models KERS807, YKERS807, KESS907 and YKESS907)

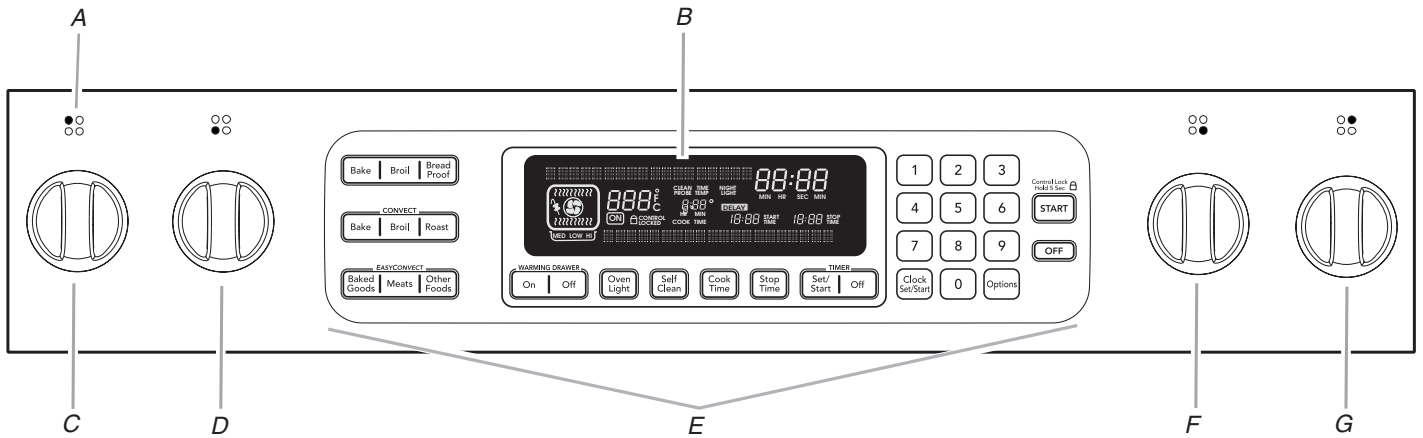

A. Surface locator and indicator light  
 B. Oven display  
 C. Left rear cooktop element control  
 (dual-size element)

D. Left front cooktop element control  
 (dual-size element)  
 E. Oven control panel

F. Right front cooktop element control  
 (single element)  
 G. Right rear cooktop element control  
 (dual-size element)

### Standard Control Knob (Model KESK901)

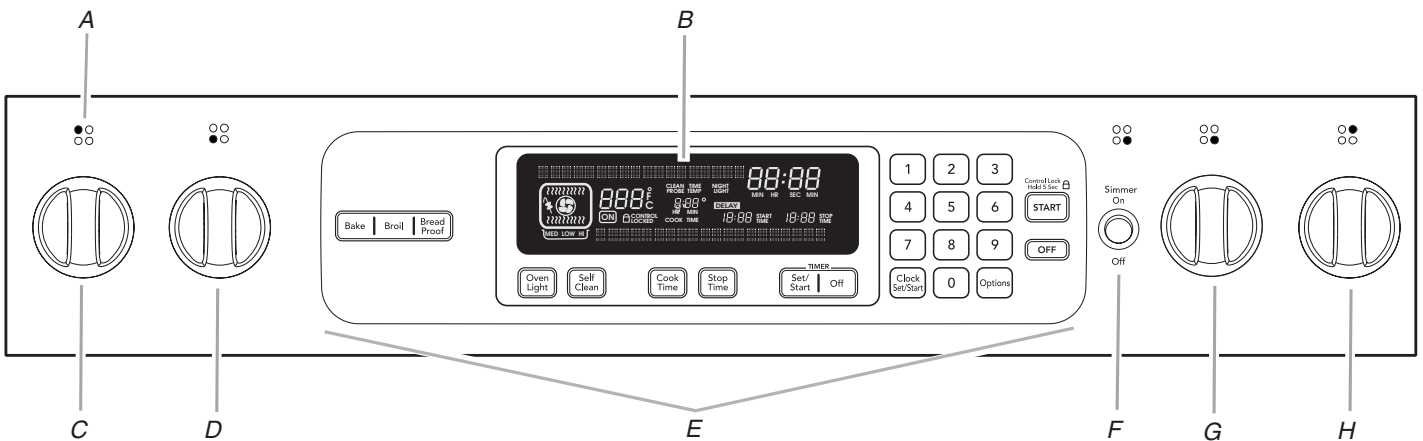

A. Surface locator and indicator light  
 B. Oven display  
 C. Left rear cooktop element control  
 (single element)

D. Left front cooktop element control  
 (dual-size element)  
 E. Oven control panel  
 F. Simmer switch

G. Right front cooktop element control  
 (single element)  
 H. Right rear cooktop element control  
 (single element)

## Range

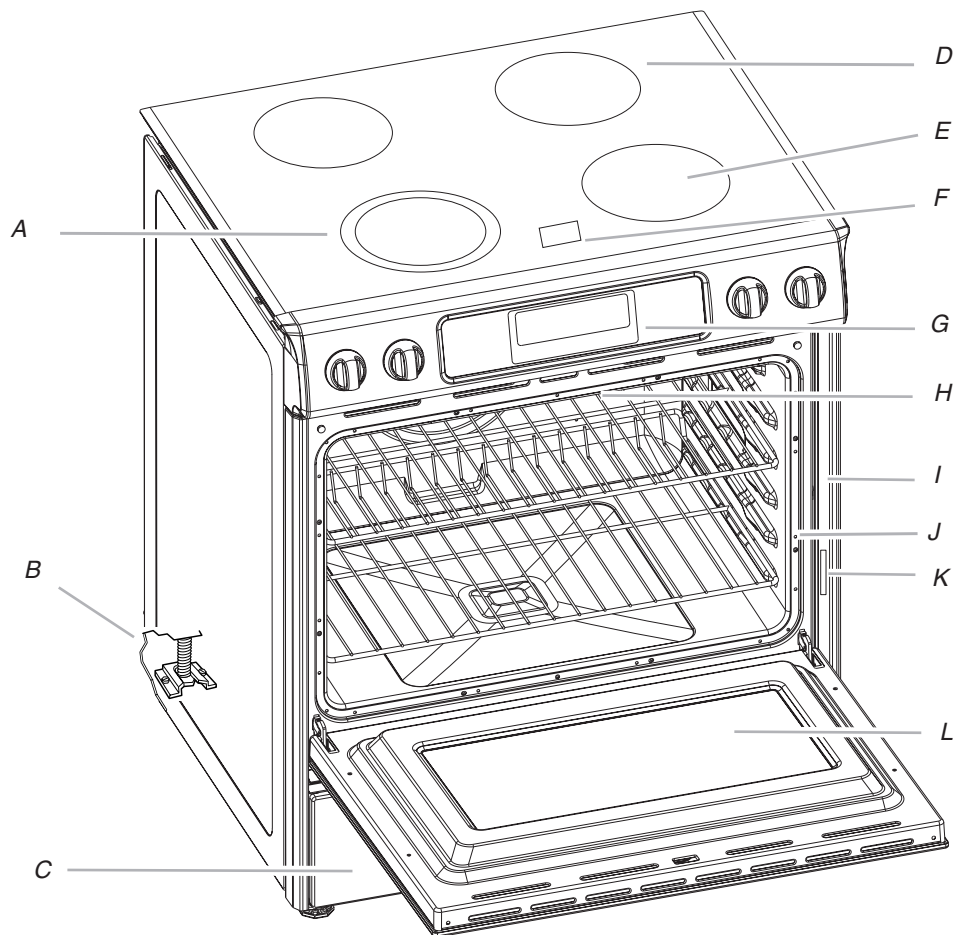

A. Dual-size element  
(rear element also dual on  
electronic control models)  
B. Anti-tip bracket  
C. Warming drawer  
(storage drawer on standard  
control models)

D. Ceramic surface cooking area  
E. Selectable simmer feature  
(available on standard control  
models)  
F. Hot surfaces indicator lights  
G. Control panel  
H. Automatic oven light switch/  
self-clean latch

I. Temperature probe jack  
(not shown)  
(electronic knob control only)  
J. Door gasket  
K. Model and serial number  
L. Oven door window

**Parts and Features not shown**  
(on some models)  
Broiler pan and grid  
Roasting rack  
Temperature probe  
Simmer feature switch

## Oven Interior

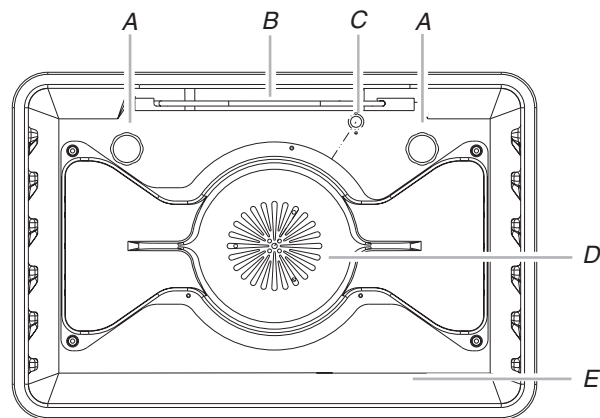

A. Oven lights  
B. Full and center broil elements  
C. Oven cavity sensor

D. T.H.E.™ convection fan and element (on 807 and 907 models)  
E. CleanBake™ element (not visible)



# COOKTOP USE

## Ceramic Glass

The surface cooking area will glow red when an element is on. It may cycle on and off to maintain the selected heat level.

It is normal for the surface of white or biscuit ceramic glass to appear to change color when surface cooking areas are hot. As the glass cools, it will return to its original color.

Cleaning off the cooktop before and after each use will help keep it free from stains and provide the most even heating. On cooktops with white or biscuit ceramic glass, soils and stains may be more visible, and may require more cleaning and care. Cooktop cleaner and a cooktop scraper are recommended. For more information, see "General Cleaning" section.

- Do not store jars or cans above the cooktop. Dropping a heavy or hard object onto the cooktop could crack the cooktop.
- Do not leave a hot lid on the cooktop. As the cooktop cools, air can become trapped between the lid and the cooktop, and the ceramic glass could break when the lid is removed.
- For foods containing sugar in any form, clean up all spills and soils as soon as possible. Allow the cooktop to cool down slightly. Then, while wearing oven mitts, remove the spills while the surface is still warm. If sugary spills are allowed to cool down, they can adhere to the cooktop and can cause pitting and permanent marks.
- Do not slide cookware or bakeware across the cooktop. Aluminum or copper bottoms and rough finishes on cookware or bakeware could leave scratches or marks on the cooktop.
- Do not cook popcorn in prepackaged aluminum containers on the cooktop. They could leave aluminum marks that cannot be removed completely.
- Do not allow objects that could melt, such as plastic or aluminum foil, to touch any part of the entire cooktop.
- Do not use the cooktop as a cutting board.
- Use cookware about the same size as the surface cooking area. Cookware should not extend more than ½" (1.3 cm) outside the area.

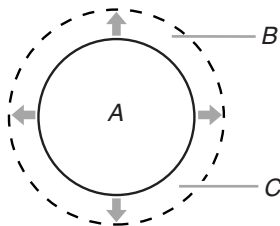

A. Surface cooking area  
B. Cookware/canner  
C. ½" (1.3 cm) Maximum overhang

- Use flat-bottomed cookware for best heat conduction and energy efficiency. Cookware with rounded, warped, ribbed or dented bottoms could cause uneven heating and poor cooking results.
- Determine flatness by placing the straight edge of a ruler across the bottom of the cookware. While you rotate the ruler, no space or light should be visible between it and the cookware.

- Cookware designed with slightly indented bottoms or small expansion channels can be used.
- Make sure the bottoms of pots and pans are clean and dry before using them. Residue and water can leave deposits when heated.
- Do not cook foods directly on the cooktop.

## Cookware

**IMPORTANT:** Do not leave empty cookware on a hot surface cooking area, element or surface burner.

Ideal cookware should have a flat bottom, straight sides, and a well-fitting lid and the material should be of medium-to-heavy thickness.

Rough finishes may scratch the cooktop. Aluminum and copper may be used as a core or base in cookware. However, when used as a base they can leave permanent marks on the cooktop or grates.

Cookware material is a factor in how quickly and evenly heat is transferred, which affects cooking results. A nonstick finish has the same characteristics as its base material. For example, aluminum cookware with a nonstick finish will take on the properties of aluminum.

Use the following chart as a guide for cookware material characteristics.

COOKWARE	CHARACTERISTICS
<b>Aluminum</b>	<ul style="list-style-type: none"> <li>■ Heats quickly and evenly.</li> <li>■ Suitable for all types of cooking.</li> <li>■ Medium or heavy thickness is best for most cooking tasks.</li> </ul>
<b>Cast iron</b>	<ul style="list-style-type: none"> <li>■ Heats slowly and evenly.</li> <li>■ Good for browning and frying.</li> <li>■ Maintains heat for slow cooking.</li> </ul>
<b>Ceramic or Ceramic glass</b>	<ul style="list-style-type: none"> <li>■ Follow manufacturer's instructions.</li> <li>■ Heats slowly, but unevenly.</li> <li>■ Ideal results on low to medium heat settings.</li> </ul>
<b>Copper</b>	<ul style="list-style-type: none"> <li>■ Heats very quickly and evenly.</li> </ul>
<b>Earthenware</b>	<ul style="list-style-type: none"> <li>■ Follow manufacturer's instructions.</li> <li>■ Use on low heat settings.</li> </ul>
<b>Porcelain enamel-on-steel or cast iron</b>	<ul style="list-style-type: none"> <li>■ See stainless steel or cast iron.</li> </ul>
<b>Stainless steel</b>	<ul style="list-style-type: none"> <li>■ Heats quickly, but unevenly.</li> <li>■ A core or base of aluminum or copper on stainless steel provides even heating.</li> </ul>

## Home Canning

When canning for long periods, alternate the use of surface cooking areas, elements or surface burners between batches. This allows time for the most recently used areas to cool.

- Center the canner on the grate or largest surface cooking area or element. On electric cooktops, canners should not extend more than ½" (1.3 cm) beyond the surface cooking area or element.
- Do not place canner on 2 surface cooking areas, elements or surface burners at the same time.
- On ceramic glass models, use only flat-bottomed canners.
- For more information, contact your local agricultural department. Companies that manufacture home canning products can also offer assistance.

## Cooktop Controls - Touch-Activated Custom Control Temperature Management System

### **! WARNING**



#### Fire Hazard

**Turn off all controls when done cooking.  
Failure to do so can result in death or fire.**

The electronic touch controls offer a variety of heat settings for optimal cooking results. When melting foods such as chocolate or butter, or when proofing bread, the surface cooking area can be set to MELT & HOLD for very low temperature operation.

To keep cooked foods warm or to heat serving dishes, the surface cooking area can be set to KEEP WARM.

For maximum element operation, all cooktop touch-activated controls can be set to HI when bringing liquids to a fast and rapid boil. Touch the “-” pad to immediately reach the HI setting.

**NOTE:** This cooktop automatically adjusts for 208V operation without affecting cooking performance.

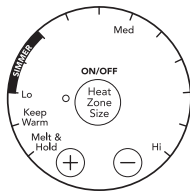

#### To Use:

1. Touch ON/OFF.
2. Touch the “+” or “-” pads to increase or decrease power.
3. To choose a power level between HI and MELT & HOLD, touch and hold either pad until the desired level has been reached.
4. When finished cooking, touch ON/OFF to turn surface cooking area(s) off individually, or touch Control Lock/All Off to turn all elements off at the same time.

Use the following chart as a guide when setting heat levels.

SETTING	RECOMMENDED USE
<b>DUAL and TRIPLE-SIZE ELEMENTS</b>	<ul style="list-style-type: none"> <li>■ Large diameter cookware.</li> <li>■ Large quantities of food.</li> <li>■ Home canning.</li> </ul>
<b>HI</b>	<ul style="list-style-type: none"> <li>■ Bring liquid to a boil.</li> </ul>
<b>MED- HI [8-10]</b>	<ul style="list-style-type: none"> <li>■ Hold a rapid boil.</li> <li>■ Quickly brown or sear food.</li> </ul>
<b>MED [6-7]</b>	<ul style="list-style-type: none"> <li>■ Maintain a slow boil.</li> <li>■ Fry or sauté foods.</li> <li>■ Cook soups, sauces and gravies.</li> </ul>
<b>MED-LO [4-5]</b>	<ul style="list-style-type: none"> <li>■ Stew or steam food.</li> </ul>
<b>LO-3 [SIMMER]</b>	<ul style="list-style-type: none"> <li>■ Simmer (range of simmer temperatures)</li> </ul>
<b>KEEP WARM</b>	<ul style="list-style-type: none"> <li>■ Keep cooked foods warm.</li> </ul>
<b>MELT &amp; HOLD</b>	<ul style="list-style-type: none"> <li>■ Melt chocolate or butter.</li> </ul>

**REMEMBER:** When range is in use or (on some models) during the Self-Cleaning cycle, the entire cooktop area may become hot.

## Single, Dual and Triple-Size Elements



A. Single size

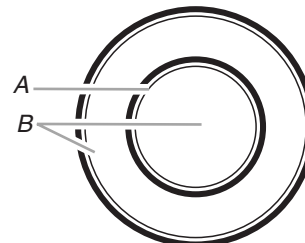

A. Single size  
B. Dual size



A. Single size  
B. Dual size

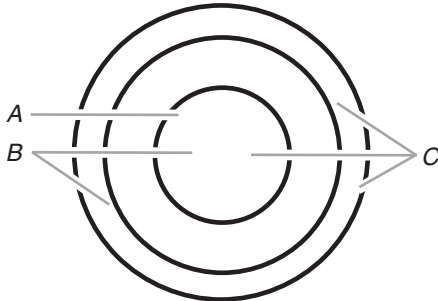

A. Single size  
B. Dual size  
C. Triple size

#### To Use:

1. Touch ON/OFF.
2. Touch heat zone size to desired zone diameter (single, dual or triple). The corresponding zone diameter indicator light will glow to show which setting is activated.
3. To choose a power level between HI and MELT & HOLD, touch and hold either the “+” or “-” pads until the desired level has been reached.

When finished cooking, touch ON/OFF to turn surface cooking area(s) off individually, or touch Control Lock/All Off to turn all elements off at the same time.

#### Melt & Hold

The Melt & Hold function is available on all the surface cooking elements, and is ideal for melting and holding chocolate or butter without scorching.

#### To Use:

1. Touch ON/OFF.
2. Touch the “+” pad once for MELT & HOLD.

When finished cooking, touch ON/OFF to turn surface cooking area off.

#### Keep Warm

## ⚠ WARNING

### Food Poisoning Hazard

**Do not let food sit for more than one hour before or after cooking.**

**Doing so can result in food poisoning or sickness.**

The Keep Warm function is available on all the surface cooking elements, and is ideal for keeping cooked foods warm. Do not use it to heat cold foods. One hour is the recommended maximum time to maintain food quality.

- Use only cookware and dishes recommended for oven and cooktop use.
- Cover all foods with a lid or aluminum foil. When warming baked goods, allow a small opening in the cover for moisture to escape.
- Do not use plastic wrap to cover food. Plastic wrap may melt.
- Use pot holders or oven mitts to remove food.

#### To Use:

1. Touch ON/OFF.
2. Touch the “+” pad twice for KEEP WARM.

When finished cooking, touch ON/OFF to turn surface cooking area off.

#### Simmer

The Simmer function is available on all the surface cooking elements. It has an adjustable heat setting for more precise simmer control.

Three levels of simmer are available. The recommended setting will vary depending on the quantity and density of the food being cooked as well as the size and shape of the cookware being used.

#### To Use:

1. Touch ON/OFF.
2. Touch the “+” pad to select the desired simmer setting.

When finished cooking, touch ON/OFF to turn surface cooking area off.

Use the following chart as a guide when setting heat levels.

SETTING	RECOMMENDED USE
LO	<ul style="list-style-type: none"> <li>■ Water-based foods such as chicken noodle soup.</li> <li>■ Bringing water to boil.</li> <li>■ Cooking with a lid.</li> <li>■ Cooking with smaller cookware.</li> </ul>
2	<ul style="list-style-type: none"> <li>■ Medium-density foods such as cream soups, sauces and gravy.</li> </ul>
3	<ul style="list-style-type: none"> <li>■ Thicker foods such as tomato sauce, chili.</li> <li>■ Cooking without a lid.</li> <li>■ Cooking with larger cookware.</li> </ul>

#### Control Lock/All Off

The All Off cooktop touch controls turn off all surface cooking areas that are in use at the same time.

The Control Lock cooktop touch control helps avoid unintended use of the surface cooking areas. When the cooktop is locked out, the surface cooking areas cannot be turned on by the cooktop touch controls.

**To Lock Cooktop:** Press and hold the Control Lock/All Off keypad for 5 seconds. After 5 seconds, CONTROL LOCK will glow red, indicating that the cooktop touch controls are in the lockout position.

**To Unlock Cooktop:** Press and hold the Control Lock/All Off keypad for 5 seconds.

## Hot Surface Indicator Lights

The Hot Surface Indicator Lights are located next to each of the cooktop touch controls. The Hot Surface Indicator Lights will glow as long as any surface cooking area is too hot to touch, even after the surface cooking area(s) is turned off.

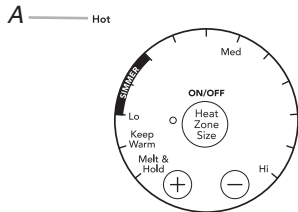

A. Hot surface indicator light

## Cooktop Controls - Custom Knobs Custom Control Temperature Management System

### WARNING



#### Fire Hazard

**Turn off all controls when done cooking.**  
**Failure to do so can result in death or fire.**

The knob-activated electronic system controls offer a variety of heat settings for optimal cooking results. When melting foods such as chocolate or butter, the surface cooking area can be set to MELT for minimal element operation.

To keep cooked foods warm or to heat serving dishes, the surface cooking area can be set to WARM.

For maximum element operation, all knob-activated electronic system controls can be set to HI when bringing liquids to a fast and rapid boil.

**NOTE:** This cooktop automatically adjusts for 208V operation without affecting cooking performance.

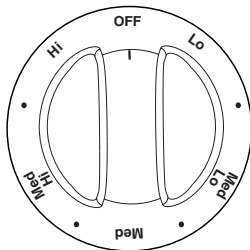

#### To Use:

1. The cooktop control can be set to anywhere between HI and MELT.
2. Push in and turn to desired setting.

Use the following chart as a guide when setting heat levels.

SETTING	RECOMMENDED USE
<b>DUAL-SIZE ELEMENT</b>	<ul style="list-style-type: none"> <li>Large diameter cookware.</li> <li>Large quantities of food.</li> <li>Home canning.</li> </ul>
<b>HI</b>	<ul style="list-style-type: none"> <li>Bring liquid to a boil.</li> </ul>
<b>MED- HI</b>	<ul style="list-style-type: none"> <li>Hold a rapid boil.</li> <li>Quickly brown or sear food.</li> </ul>
<b>MED</b>	<ul style="list-style-type: none"> <li>Maintain a slow boil.</li> <li>Fry or sauté foods.</li> <li>Cook soups, sauces and gravies.</li> </ul>
<b>MED-LO</b>	<ul style="list-style-type: none"> <li>Stew or steam food.</li> </ul>
<b>LO [SIMMER]</b>	<ul style="list-style-type: none"> <li>Simmer (range of simmer temperatures).</li> </ul>
<b>WARM</b>	<ul style="list-style-type: none"> <li>Keep cooked foods warm.</li> </ul>
<b>MELT</b>	<ul style="list-style-type: none"> <li>Melt chocolate or butter.</li> </ul>

**REMEMBER:** When range is in use or (on some models) during the Self-Cleaning cycle, the entire cooktop area may become hot.

## Single and Dual-Size Elements



A. Single size

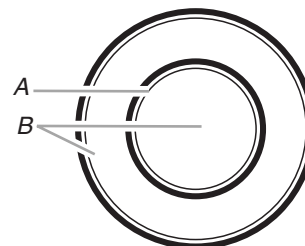

A. Single size  
B. Dual size



A. Single size  
B. Dual size

The Dual-Size Elements offer flexibility depending on the size of the cookware. Single size can be used in the same way as a regular element. The dual size combines both the single and outer element and is recommended for larger size cookware.

### To Use SINGLE:

1. Push in and turn knob counterclockwise from the OFF position to the SINGLE zone anywhere between LO and HI.
2. Turn knob to OFF when finished.

### To Use DUAL:

1. Push in and turn knob clockwise from the OFF position to the DUAL zone anywhere between LO and HI.
2. Turn knob to OFF when finished.

---

### Melt

---

The Melt function is available on all the surface cooking elements, and is ideal for melting chocolate or butter.

### To Use:

1. Push in and turn knob to MELT setting.
2. Turn knob to OFF when finished.

---

### Warm

---

The Warm function is available on all the surface cooking elements, and is ideal for keeping cooked foods warm. Do not use it to heat cold foods. One hour is the recommended maximum time to maintain food quality.

- Use only cookware and dishes recommended for oven and cooktop use.
- Cover all foods with a lid or aluminum foil. When warming baked goods, allow a small opening in the cover for moisture to escape.
- Do not use plastic wrap to cover food. Plastic wrap may melt.
- Use pot holders or oven mitts to remove food.

### To Use:

1. Push in and turn knob to WARM setting.
2. Turn knob to OFF when finished.

---

### Simmer

---

The Simmer function is available on all cooking elements. It has an adjustable heat setting for more precise simmer control. Three levels of simmer are available. The recommended setting will vary depending on the quantity and density of the food being cooked as well as the size and shape of the cookware used.

### To Use:

1. Push in and turn knob to the desired SIMMER setting.
2. Turn knob to OFF when finished.

Use the following chart as a guide when setting heat levels.

SETTING	RECOMMENDED USE
LO	<ul style="list-style-type: none"><li>■ Water-based foods such as chicken noodle soup.</li><li>■ Bringing water to boil.</li><li>■ Cooking with a lid.</li><li>■ Cooking with smaller cookware.</li></ul>
2	<ul style="list-style-type: none"><li>■ Medium-density foods such as cream soups, sauces and gravy.</li></ul>
3	<ul style="list-style-type: none"><li>■ Thicker foods such as tomato sauce, chili.</li><li>■ Cooking without a lid.</li><li>■ Cooking with larger cookware.</li></ul>

---

### POWER ON Lights

---

Each control knob has a POWER ON light. The light will glow when its control knob is on.

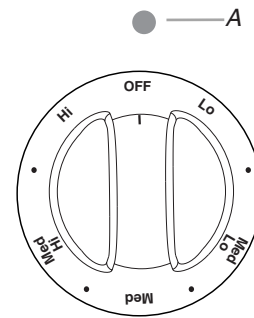

A. Power on indicator light

---

### Hot Surface Indicator Light

---

The hot surface indicator light will glow as long as any surface cooking area is too hot to touch, even after the surface cooking area(s) is turned off.

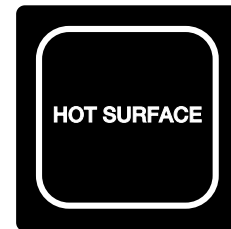

---

### Cooktop Controls - Standard Knobs

## ⚠ WARNING



### Fire Hazard

**Turn off all controls when done cooking.**  
**Failure to do so can result in death or fire.**

The cooktop controls can be set to anywhere between HI and LO.

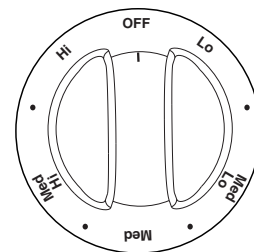

Push in and turn to the desired heat setting. Use the following chart as a guide when setting heat levels.

SETTING	RECOMMENDED USE
HI	<ul style="list-style-type: none"> <li>Bring liquid to a boil.</li> </ul>
MED- HI	<ul style="list-style-type: none"> <li>Hold a rapid boil.</li> <li>Quickly brown or sear food.</li> </ul>
MED	<ul style="list-style-type: none"> <li>Maintain a slow boil.</li> <li>Fry poultry or meat.</li> <li>Cook pudding, sauce, icing or gravy.</li> </ul>
MED- LO	<ul style="list-style-type: none"> <li>Stew or steam food.</li> <li>Simmer.</li> </ul>
LO	<ul style="list-style-type: none"> <li>Keep food warm.</li> <li>Melt chocolate or butter.</li> </ul>
<b>SIMMER Switch</b> (on some models)	<ul style="list-style-type: none"> <li>Precise simmer control.</li> </ul>

**REMEMBER:** When range is in use or (on some models) during the Self-Cleaning cycle, the entire cooktop area may become hot.

### Single and Dual-Size Elements



A. Single size

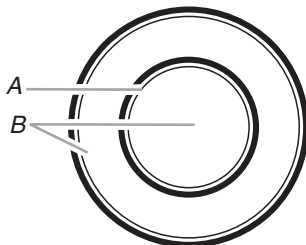

A. Single size  
B. Dual size

The Dual-Size Elements offer flexibility depending on the size of the cookware. Single size can be used in the same way as a regular element. The dual size combines both the single and outer element and is recommended for larger size cookware, large quantities of food and home canning.

### To Use SINGLE:

1. Push in and turn knob counterclockwise from the OFF position to the SINGLE zone anywhere between LO and HI.
2. Turn knob to OFF when finished.

### To Use DUAL:

1. Push in and turn knob clockwise from the OFF position to the DUAL zone anywhere between LO and HI.
2. Turn knob to OFF when finished.

### Simmer

The Simmer feature is an adjustable heat setting for more precise simmering. It is the right front surface cooking areas or elements. When the Simmer feature is not on, the right front surface cooking areas or elements will function as usual.

When this feature is on, the wattage to the burner is significantly reduced. It provides a wide range of temperatures for simmering. Choose from the higher levels for stocks and water-based foods or the lower levels for sauces, puddings and gravies.

### To Use:

1. Set SIMMER switch to ON (press up).
2. Select desired temperate setting from LO to HI.
3. Set SIMMER switch to OFF (press down) when finished.



### POWER ON Lights

Each control knob has a POWER ON light. The light will glow when its control knob is on.

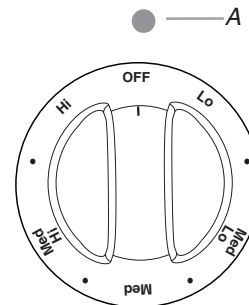

A. Power on indicator light

### Hot Surface Indicator Light

The hot surface indicator light will glow as long as any surface cooking area is too hot to touch, even after the surface cooking area(s) is turned off.

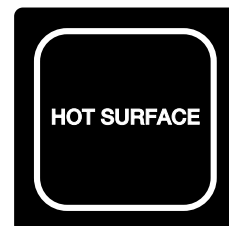

# GLASS TOUCH-ACTIVATED ELECTRONIC OVEN CONTROL

## Style 1 (Electronic Touch Activated and Electronic Knob Control Systems)

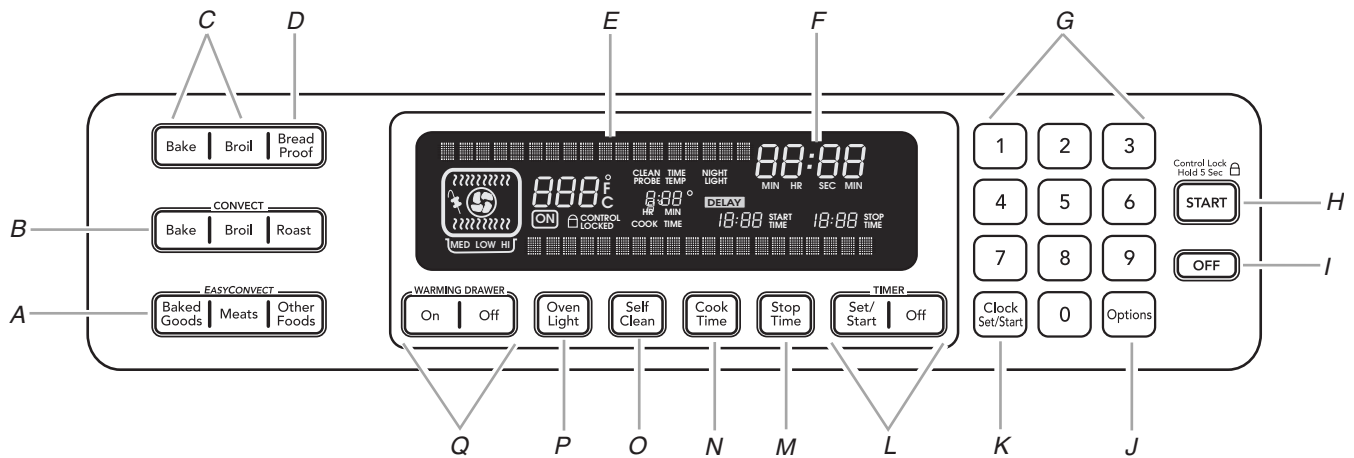

- A. EasyConvect conversion
- B. Convection oven settings
- C. Oven settings
- D. Proof bread setting
- E. Oven display
- F. Clock/Time of day display

- G. Number pads
- H. Start (control lock)
- I. Off
- J. Options selection pad
- K. Clock set/start
- L. Timer

- M. Stop time
- N. Cook time (length of cooking time)
- O. Self-clean
- P. Oven light
- Q. Warming drawer

## Style 2 (Standard Knob Controls System)

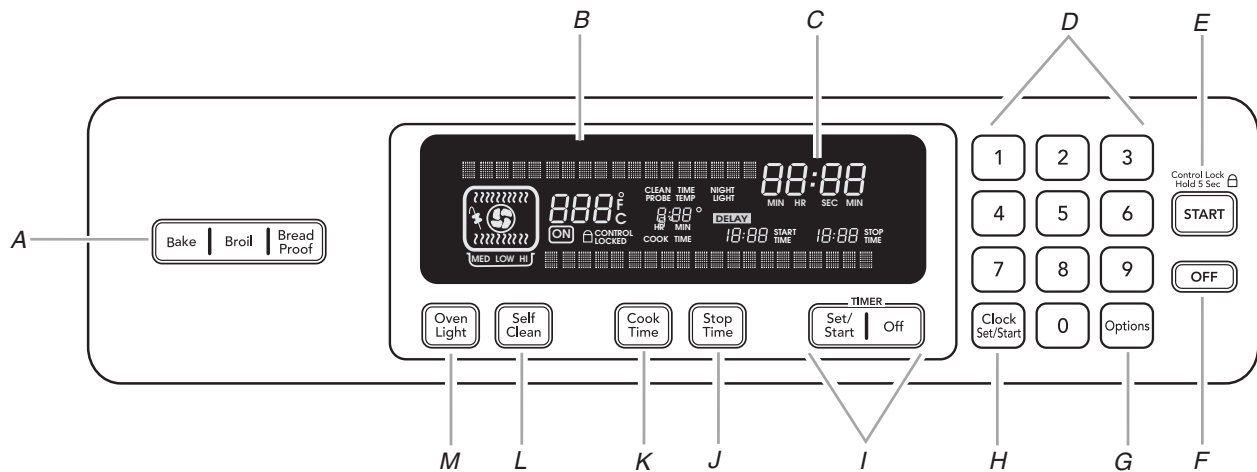

- A. Oven settings
- B. Oven display
- C. Clock/Time of day display
- D. Number pads

- E. Start (control lock)
- F. Off
- G. Options selection pad
- H. Clock set/start
- I. Timer

- J. Stop time
- K. Cook time (length of cooking time)
- L. Self-clean
- M. Oven light

---

## Electronic Control Pads

When pressing any control pad function on the Electronic Oven Control, use the pad of your finger to press the desired function. Hold down the pad a few seconds, or until the desired function appears in the display.

When entering multiple functions within one setting, pause briefly between each control pad command. If a command pad is pressed several times repeatedly, the pad may briefly stop working. Wait a few seconds, and the pad should function again as normal.

---

## Oven Displays

When the oven is in use, this display shows the oven temperature, heat source(s) and start time. During Timed Cooking, this display also shows a timed countdown and the stop time (if entered).

If "Err" appears on the display, an invalid pad was pressed. Press OFF and retry your entry. When the oven is not in use, this display is blank.

---

## Start

The START pad begins any oven function except the Timer, Control Lock and Sabbath Mode. If not pressed within 5 seconds after pressing a pad, "START?" will appear on the oven display as a reminder. If not pressed within 5 minutes after pressing a pad, the oven display will return to inactive mode (blank) and the programmed function will be canceled.

If a function has been started and a different function is selected, "START?" will appear in the display after 5 seconds. If the START pad is not pressed within 5 seconds, the oven display will return to the active/already started function.

---

## Control Lock

The Control Lock feature shuts down the control panel pads to avoid unintended use of the oven.

The Control Lock feature may be used either when the range is in use or turned off (for example, during cleaning).

The Control Lock is preset unlocked, but can be locked.

When the control is locked, only the TIMER SET/START, TIMER OFF and OVEN LIGHT pads will function.

**To Lock/Unlock Control:** Before locking, make sure the oven, the Timer and Timed Cooking are off. Press and hold the START pad for 5 seconds until "CONTROL LOCK" appears on the display. Repeat to unlock and remove "CONTROL LOCK" from the display.

---

## Off

The OFF pad stops any oven function except for the Warming Drawer, Clock, Timer and Control Lock.

---

## Clock/Timer Display

This is a 12-hour clock.

1. Press CLOCK SET/START.
2. Press number pads to set time of day.
3. Press CLOCK SET/START

---

## Timer

The Timer can be set in minutes and seconds or hours and minutes and counts down the set time.

**NOTE:** The Timer does not start or stop the oven.

1. Press TIMER SET/START.  
Press again to switch from MIN/SEC and HR/MIN.
2. Press the number pads to set length of time.
3. Press TIMER SET/START to start the timer.  
When the set time ends, timer completion tones will sound, then reminder tones will sound approximately every 10 seconds.
4. Press TIMER OFF anytime to cancel the Timer and/or stop reminder tones.  
If OFF is pressed, the oven will turn off.

The time can be reset during the countdown by repeating the above steps.

---

# OPTIONS

---

## Options Selection Pad

The OPTIONS selection pad allows you to access special functions within the Electronic Oven Control that allow you to customize the product to your needs. These special functions allow you to change the oven temperature between Fahrenheit and Celsius, turn the audible signals and prompts on and off, and adjust the oven calibration. The Dehydrate and Sabbath Mode are also set using the OPTIONS selection pad.

### To Use:

Press OPTIONS. The oven display will scroll through the various options, starting at 1 and ending in 7. You can also press the OPTIONS selection pad and number pad to quickly enter the desired hidden function.

OPTIONS	SPECIAL FUNCTION
1	Fahrenheit and Celsius conversion
2	Tones On/Off
3	Tones High/Low
4	Cooking Time Completion Tones On/Off
5*	Dehydrate
6	Oven temperature calibration
7	Sabbath Mode

---

\*Available only on convection models.

---

## Fahrenheit and Celsius - Option 1

Fahrenheit is the default setting, but setting may be changed to Celsius.

**To Change:** Press OPTIONS, then 1 on the keypad for Celsius. To convert back to Fahrenheit, press OPTIONS, then 1 again on the keypad.



---

## Tones - Options 2, 3, 4

Tones are audible signals, indicating the following:

### One beep

- Function has been entered

### Three beeps

- Invalid pad press

### Preheat Completion Tone

One chime indicates a preheat cycle has been completed.

### Timer Completion Tones

Three chimes sound when the timer reaches zero. This can occur when using the timer for functions other than cooking.

### Cooking Time Completion Tones

Three beeps indicate the end of a cooking cycle.

### All Tones ON/OFF

All tones are preset to ON, but can be turned OFF.

**To change:** Press OPTIONS, then 2 to turn tones OFF. To turn tones ON, press OPTIONS again, and then 2.

### Tone Volume High/Low

The volume is preset to HIGH, but can be changed to LOW.

**To change:** Press OPTIONS, then 3 for LOW. Press OPTIONS, then 3 again for HIGH.

### Cooking Time Completion Tones ON/OFF

All tones are preset to ON, but can be turned OFF.

**To change:** Press OPTIONS, then 4 to turn tones OFF. To turn tones ON, press OPTIONS again, and then 4.

---

## Dehydrate - Option 5

(on convection models, closed door)

Dehydration is a method used to preserve food. Various factors, such as the quality of the fresh food, pretreatment techniques, the size and thickness of the food, and the climate may affect the finished product.

During dehydration, heat is used to force out moisture and air circulation is used to carry the moisture away.

Refer to a reliable book or source for complete information about dehydrating and preserving foods.

### To Dehydrate:

Position the racks according to the following chart. See "Positioning Racks and Bakeware" section for diagram.

NUMBER OF RACKS	RACK POSITION(S)
1	3
2	2 and 4
3	1, 3 and 5

1. Close the oven door.

2. Press OPTIONS then 5.

Press the number pads to enter a temperature other than 140°F (60°C). The dehydrating range can be set between 100°F and 200°F (38°C and 93°C).

3. Press START.

4. Press OFF when finished dehydrating.

**NOTE:** The oven will automatically turn off after 12 hours. However, some foods may take more than 12 hours to dehydrate. If this is the case, the oven will need to be restarted.

---

## Oven Temperature Calibration - Option 6

**IMPORTANT:** Do not use a thermometer to measure oven temperature because opening the oven door during cycling may give incorrect readings.

The oven provides accurate temperatures; however, it may cook faster or slower than your previous oven, so the temperature calibration can be adjusted. It can be changed in Fahrenheit or Celsius.

A minus sign means the oven will be cooler by the displayed amount. The absence of a minus sign means the oven will be warmer by the displayed amount. Use the following chart as a guide.

ADJUSTMENT °F (AUTOMATIC °C CHANGE)	COOKS FOOD
10°F (5°C)	...a little more
20°F (10°C)	...moderately more
30°F (15°C)	...much more
-10°F (-5°C)	...a little less
-20°F (-10°C)	...moderately less
-30°F (-15°C)	...much less

### To Adjust Oven Temperature Calibration:

1. Press OPTIONS, and then 6 to set the calibration.

2. Press 3 to increase the temperature, or press 6 to decrease the temperature.

3. Press START to end calibration.

## Sabbath Mode - Option 7

The Sabbath Mode sets the oven to remain on in a bake setting until turned off. A timed Sabbath Mode can also be set to keep the oven on for only part of the Sabbath.

When the Sabbath Mode is set, only the number and start pads will function, no tones will sound, and the displays will not show messages or temperature changes. The heat sources icons will appear lit on the oven display throughout the Sabbath Mode.

When the oven door is opened or closed, the oven light will not turn on or off and the heating elements will not turn on or off immediately.

If a power failure occurs when the Sabbath Mode is set, the oven will remain Sabbath Mode compliant but will no longer be actively cooking. The "ON" indicator will no longer be illuminated. Press OFF to return to normal operating mode (non-Sabbath Mode compliant, not cooking).

### To Activate:

**IMPORTANT:** Before the Sabbath Mode can be regularly set, the oven must first be enabled with a one time only setup.

1. Open the oven door.
2. Press OFF.
3. Press the number pads 7, 8, 9, 6, in this order.
4. Press START to activate.  
"SABBATH ENABLED" will appear on the display.
5. Press OFF pad to clear the display.

### To Deactivate:

The oven can be disabled of the ability to set the Sabbath Mode by repeating the previous steps. See "To Activate" section. When disabled the Sabbath Mode cannot be regularly set until re-enabled.

### To Regularly Set, Untimed:

1. Press BAKE.  
Press the number pads to enter a temperature other than 325°F (163°C). The bake range can be set between 170°F and 500°F (77°C and 260°C).
2. Press START. The oven will begin a bake cycle.
3. Press OPTIONS, and then press number pad 7.
4. "SABBATH MODE" will appear on the oven display.

### To Regularly Set, Timed:

## WARNING

### Food Poisoning Hazard

**Do not let food sit in oven more than one hour before or after cooking.**

**Doing so can result in food poisoning or sickness.**

1. Press BAKE.  
Press the number pads to enter a temperature other than 325°F (163°C). The bake range can be set between 170°F and 500°F (77°C and 260°C).
2. Press COOK TIME.

3. Press the number pads to enter the length of Sabbath Mode time, up to 11 hours 59 minutes.
4. Press START. The oven will begin a timed bake cycle.  
The start time and stop time will appear on the display.
5. Press OPTIONS, and then press number pad 7. "SABBATH MODE" will appear on the display.
6. When the stop time is reached, the oven will automatically turn off. The oven control will remain Sabbath Mode compliant until the OFF button is pressed.

### Temperature Change

The oven temperature can be changed when the oven(s) are in the Sabbath Mode. No tones will sound, and the display will not change. The heating elements will not turn on or off for a random time, anywhere from 16 to 24 seconds. It may take up to ½ hour for the oven to change temperature.

Number pads 1 through 0 represent temperatures. Use the following chart as a guide.

NUMBER PAD	OVEN TEMPERATURE
1	170°F (77°C)
2	200°F (95°C)
3	225°F (107°C)
4	250°F (120°C)
5	300°F (149°C)
6	325°F (163°C)
7	350°F (177°C)
8	375°F (191°C)
9	400°F (204°C)
0	450°F (232°C)

### To Change Temperature:

1. Press the number pad from the chart.
2. Press START.

### Warming Drawer Operation During Sabbath Mode

The warming drawer may be set for use during Sabbath Mode. This is accomplished by pressing the WARMING DRAWER ON key (continue pressing until desired temperature level is displayed) before the oven is placed into its Sabbath Mode compliant state. See "To Regularly Set, Untimed" section for instructions on placing the oven into its Sabbath Mode compliant state. Once the oven is in its Sabbath Mode compliant state, the warming drawer cannot be turned on or off and its temperature cannot be changed until the oven is returned to its normal operating state (non-Sabbath Mode compliant state, not cooking) by pressing the OFF key.

# OVEN USE

Odors and smoke are normal when the oven is used the first few times, or when it is heavily soiled.

**IMPORTANT:** The health of some birds is extremely sensitive to the fumes given off. Exposure to the fumes may result in death to certain birds. Always move birds to another closed and well-ventilated room.

**NOTE:** This oven automatically adjusts for 208V operation without affecting cooking performance. Preheat times may be longer.

## Aluminum Foil

**IMPORTANT:** Do not line the oven bottom with any type of foil, liners or cookware because permanent damage will occur to the oven bottom finish.

- Do not cover entire rack with foil because air must be able to move freely for best cooking results.
- To catch spills, place foil on rack below dish. Make sure foil is at least ½" (1.3 cm) larger than the dish and that it is turned up at the edges.

## Bakeware

The bakeware material affects cooking results. Follow manufacturer's recommendations and use the bakeware size recommended in the recipe. Use the following chart as a guide.

BAKEWARE/ RESULTS	RECOMMENDATIONS
<b>Light colored aluminum</b> <ul style="list-style-type: none"> <li>■ Light golden crusts</li> <li>■ Even browning</li> </ul>	<ul style="list-style-type: none"> <li>■ Use temperature and time recommended in recipe.</li> </ul>
<b>Dark aluminum and other bakeware with dark, dull and/or nonstick finish</b> <ul style="list-style-type: none"> <li>■ Brown, crisp crusts</li> </ul>	<ul style="list-style-type: none"> <li>■ May need to reduce baking temperatures 25°F (15°C).</li> <li>■ Use suggested baking time.</li> <li>■ For pies, breads and casseroles, use temperature recommended in recipe.</li> <li>■ Place rack in center of oven.</li> </ul>
<b>Insulated cookie sheets or baking pans</b> <ul style="list-style-type: none"> <li>■ Little or no bottom browning</li> </ul>	<ul style="list-style-type: none"> <li>■ Place in the bottom third of oven.</li> <li>■ May need to increase baking time.</li> </ul>
<b>Stainless steel</b> <ul style="list-style-type: none"> <li>■ Light, golden crusts</li> <li>■ Uneven browning</li> </ul>	<ul style="list-style-type: none"> <li>■ May need to increase baking time.</li> </ul>
<b>Stoneware/Baking stone</b> <ul style="list-style-type: none"> <li>■ Crisp crusts</li> </ul>	<ul style="list-style-type: none"> <li>■ Follow manufacturer's instructions.</li> </ul>
<b>Ovenproof glassware, ceramic glass or ceramic</b> <ul style="list-style-type: none"> <li>■ Brown, crisp crusts</li> </ul>	<ul style="list-style-type: none"> <li>■ May need to reduce baking temperatures 25°F (15°C).</li> </ul>

## Meat Thermometer

On models without a temperature probe, use a meat thermometer to determine doneness of meat, poultry and fish. The internal temperature, not appearance, should be used to determine doneness. A meat thermometer is not supplied with this appliance.

- Insert the thermometer into the center of the thickest portion of the meat or inner thigh or breast of poultry. The tip of the thermometer should not touch fat, bone or gristle.
- After reading the thermometer once, push it into the meat ½" (1.3 cm) more and read again. If the temperature drops, cook the meat or poultry longer.
- Check all meat, poultry and fish in 2 or 3 different places.

## Temperature Probe (on convection models)

### ⚠ WARNING



#### Burn Hazard

**Use an oven mitt to remove temperature probe.**

**Do not touch broil element.**

**Failure to follow these instructions can result in burns.**

The temperature probe accurately measures the internal temperature of meat, poultry and casseroles with liquid and should be used in determining the doneness of meat and poultry. It should not be used during full and center broiling, convection broiling, dehydrating or proofing bread.

Always unplug and remove the temperature probe from the oven when removing food.

#### To Use:

Before using, insert the probe into the center of the thickest portion of meat or into the inner thigh or breast of poultry, away from fat or bone at an angle as shown in following diagram. Place food in oven and connect the temperature probe to the jack. Keep probe as far away from heat source as possible. Close oven door.

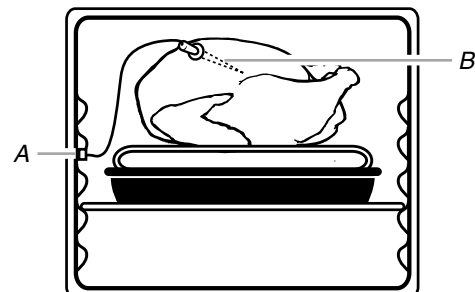

A. Temperature probe jack  
B. Temperature probe

1. Press the number pads to enter a probe temperature. The probe temperature can be set between 130°F and 190°F (54°C and 88°C).
2. Press BAKE, CONVECT BAKE or CONVECT ROAST.  
Press number pads to enter a temperature other than the one displayed.
3. Press START.

The set oven temperature will appear on the oven display throughout cooking.

“Lo” will appear as the probe temperature until the internal temperature of the food reaches 130°F (54°C). Then the display will show the temperature increasing in 1°F increments.

When the set probe temperature is reached, the oven will shut off automatically and “End” will appear on the oven display.

If enabled, end-of-cycle tones will sound.

4. Press OFF or open the oven door to clear the display.

### To Change Probe Temperature, Oven Setting:

Press OFF, then repeat previous steps.

After cooking, unplug the probe and remove food from oven. The probe symbol will remain lit until the probe is unplugged from the probe jack.

See “General Cleaning” section to clean probe.

## Positioning Racks and Bakeware

**IMPORTANT:** To avoid permanent damage to the porcelain finish, do not place food or bakeware directly on the oven door or bottom.

### RACKS

#### NOTES:

- Position racks before turning on the oven.
- Do not position racks with bakeware on them.
- Make sure racks are level.

To move a rack, pull it out to the stop position, raise the front edge, and then lift out. Use the following illustration and charts as a guide.

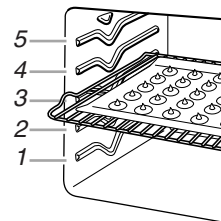

### Traditional Cooking

FOOD	RACK POSITION
Large roasts, turkeys, angel food, bundt and tube cakes, quick breads, pies	1 or 2
Yeast breads, casseroles, meat and poultry	2
Cookies, biscuits, muffins, cakes	2 or 3

### Convection Cooking

FUNCTION	NUMBER OF RACKS USED	RACK POSITION(S)
Convection baking or roasting	1	1, 2 or 3
Convection baking	2	2 and 4
Convection baking	3	1, 3 and 5

### BAKEWARE

To cook food evenly, hot air must be able to circulate. Allow 2" (5 cm) of space around bakeware and oven walls. Use the following chart as a guide.

NUMBER OF PAN(S)	POSITION ON RACK
1	Center of rack.
2	Side by side or slightly staggered.
3 or 4	Opposite corners on each rack. Make sure that no bakeware piece is directly over another.

## Oven Vent

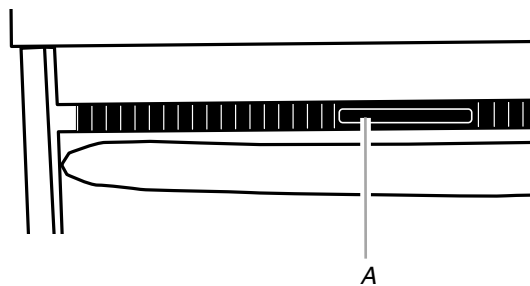

A. Oven vent

The oven vent should not be blocked or covered since it allows the release of hot air and moisture from the oven. Blocking or covering the vent will cause poor air circulation, affecting cooking and cleaning results. Do not set plastics, paper or other items that could melt or burn near the oven vent.

---

## Bake

The BAKE function is ideal for baking, roasting or heating foods. During baking or roasting, the bake and broil elements will cycle on and off in intervals to maintain oven temperature.

If the oven door is opened during baking or roasting, the broil element will turn off immediately and the bake element will turn off in 30 seconds to 2 minutes. They will come back on once the door is closed.

### To Bake or Roast:

Before baking and roasting, position racks according to the "Positioning Racks and Bakeware" section.

For baking, allow the range to preheat before placing food in the oven. When roasting, it is not necessary to wait for the oven to preheat before putting food in, unless recommended in the recipe.

1. Press BAKE once for 350°F (177°C), or press the number pads to enter the desired temperature.
2. Press START.  
"Preheating" will show in the display until the set temperature is reached.  
"Lo°" will also appear in the display if the actual oven temperature is under 170°F (77°C).  
When the actual oven temperature reaches 170°F (77°C), the oven display will show the oven temperature increasing in 1-degree increments.  
When the set temperature is reached, if on, 1 tone will sound.
3. Press OFF when finished cooking.

---

## Broil

Broiling uses direct radiant heat to cook food. There are 2 broiling choices, Full Broil and Center Broil. Full Broil uses both top elements for maximum browning coverage of foods. Center Broil uses the inner element for browning coverage of a smaller area.

- Use only the broiler pan and grid provided with the range. It is designed to drain juices and help avoid spatter and smoke.
- For proper draining, do not cover the grid with foil. The bottom of the pan may be lined with aluminum foil for easier cleaning.
- Trim excess fat to reduce spattering. Slit the remaining fat on the edges to avoid curling.
- Pull out oven rack to stop position before turning or removing food. Use tongs to turn food to avoid the loss of juices. Very thin cuts of fish, poultry or meat may not need to be turned.
- After broiling, remove the pan from the oven when removing the food. Drippings will bake on the pan if left in the heated oven, making cleaning more difficult.
- If the oven door is opened during broiling, the broil element will turn off immediately and come back on once the door is closed.

Before broiling, position rack according to the Broiling Chart. It is not necessary to preheat the oven before putting food in unless recommended in the recipe. Position food on grid in the broiler pan, then place it in the center of the oven rack.

Close the door to ensure proper broiling operation.

### To Broil:

1. Press BROIL once for FULL BROIL or twice for CENTER BROIL.  
Choose Full Broil when broiling larger amounts of food with both broil elements. Choose Center Broil when broiling smaller amounts of food with only the inner broil element.
2. Press START.
3. Press OFF when finished.

### Variable Temperature Broiling

Changing the temperature when Variable Temperature Broiling allows more precise control when cooking. The lower the temperature, the slower the cooking. Thicker cuts and unevenly shaped pieces of meat, fish and poultry may cook better at lower broiling temperatures.

### To Use:

1. Close oven door.
2. Press BROIL once for FULL BROIL or twice for CENTER BROIL.
3. Press the number pads to set a temperature between 300°F and 500°F (149°C to 260°C).
4. Press START.  
The temperature can be changed after this step. Start does not need to be pressed again.
5. Press OFF when finished.

## BROILING CHART

For best results, place food 3" (7 cm) or more from the broil element. Times are guidelines only and may need to be adjusted for individual tastes. Recommended rack positions are numbered from the bottom (1) to the top (5). For diagram, see the "Positioning Racks and Bakeware" section.

FOOD	RACK POSITION	TEMP.	TOTAL TIME MIN.
<b>Steak</b> 1" (2.5 cm) thick			
medium rare	4	500°F (260°C)	14
medium	4		16
well-done	4		18
<b>Steak</b> 1½" (3.8 cm) thick			
rare	4	500°F (260°C)	23
medium	4		28
<b>Ground meat patties*</b> 1" (2.5 cm) thick			
well-done	4	500°F (260°C)	16-18

FOOD	RACK POSITION	TEMP.	TOTAL TIME MIN.
<b>Pork chops</b> 1" (2.5 cm) thick	4	450°F (232°C)	25-28
<b>Ham slice</b> [precooked] ½" (1.25 cm) thick	4	500°F (260°C)	10-12
1" (2.5 cm) thick	4		20-22
<b>Frankfurters</b>	4	500°F (260°C)	8
<b>Lamb chops</b> 1" (2.5 cm) thick	4	400°F (204°C)	18-20
<b>Chicken</b> bone-in pieces	3	500°F (260°C)	32
<b>Fish</b> ½" (1.25 cm) thick	3	350°F	20
1" (2.5 cm) thick	3	(177°C)	20-22

\*Place up to 12 patties, equally spaced, on broiler grid.

## Convection Cooking (on some models)

In a convection oven, the fan-circulated hot air continually distributes heat more evenly than the natural movement of air in a standard thermal oven. This movement of hot air helps maintain a consistent temperature throughout the oven, cooking foods more evenly, crisping surfaces while sealing in moisture and yielding crustier breads.

Most foods can be cooked by lowering cooking temperatures 25°F to 50°F (14°C to 28°C), and cooking time can be shortened by as much as 30 percent, especially for large turkeys and roasts.

- It is important not to cover foods with lids or aluminum foil so that surface areas remain exposed to the circulating air, allowing browning and crisping.
- Keep heat loss to a minimum by opening the oven door only when necessary.
- Choose cookie sheets without sides and roasting pans with lower sides to allow air to move freely around the food.
- Test baked goods for doneness a few minutes before the minimum cooking time with an alternative method such as using a toothpick.
- Use a meat thermometer or the temperature probe to determine the doneness of meats and poultry. Check the temperature of pork and poultry in 2 or 3 places.

## EasyConvect Conversion (on some models)

Convection cooking temperatures and times differ from those of standard cooking. Depending upon the selected category, EasyConvect conversion automatically may reduce the standard recipe temperature and/or time you input for convection cooking.

Foods are grouped into 3 general categories. Choose the category most appropriate for the food to be cooked. To ensure optimal cooking results, the oven will prompt a food check at the end of a non-delayed cook time. Use the following chart as a guide.

SETTING	FOODS
<b>MEATS</b>	<b>Baked potatoes, Chicken:</b> whole and pieces <b>Meat loaf, Roasts:</b> pork, beef and ham (Turkey and large poultry are not included because their cook time varies.)
<b>BAKED GOODS</b>	<b>Biscuits, Breads:</b> quick and yeast <b>Cakes and Cookies</b> <b>Casseroles:</b> including frozen entrées and soufflés <b>Fish</b>
<b>OTHER FOODS</b>	<b>Convenience foods:</b> french fries, nuggets, fish sticks, pizza <b>Pies:</b> fruit and custard

### To Use:

When using convection temperature conversion for BAKED GOODS and OTHER FOODS, allow the oven to preheat before placing food in the oven.

1. Press MEATS, BAKED GOODS or OTHER FOODS.
2. Press number pads to enter standard cook temperature.
3. Press number pads to enter standard cook time.
4. Press START.

"CHECK FOOD AT" and the stop time will appear on the oven display, after preheating is complete.

When the stop time is reached, end-of-cycle tones will sound if enabled. Open the door and check food.

## Convection Bake (on some models)

Convection Bake can be used to bake and cook foods on single or multiple racks. It is helpful to stagger items on the racks to allow a more even flow of heat. If the oven is full, extra cooking time may be needed.

When cooking an oven meal with several different types of foods, be sure to select recipes that require similar temperatures. Cookware should sit in the oven with at least 1" (2.5 cm) of space between the cookware and the sides of the oven.

Allow the range to preheat before placing food in the oven.

During convection baking preheat, the broil elements and the bake element all heat the oven cavity. After preheat, the convection element will cycle on and off in intervals to maintain oven temperature, while the fan constantly circulates the hot air.

If the oven door is opened during convection baking or preheating, the convection element and fan will turn off immediately. They will come back on once the door is closed.

- Reduce recipe temperature 25°F (14°C). The cook time may need to be reduced also.

## To Convection Bake:

Before convection baking, position racks according to the "Positioning Racks and Bakeware" section.

### 1. Press CONVECT BAKE.

Press the number pads to enter a temperature other than 325°F (163°C). The convection bake range can be set between 170°F and 500°F (77°C and 260°C).

### 2. Press START.

"Preheating" will show in the display until the set temperature is reached.

"Lo°" will also appear in the display if the actual oven temperature is under 170°F (77°C).

When the actual oven temperature reaches 170°F (77°C), the oven display will show the oven temperature increasing in 1-degree increments.

When the set temperature is reached, if on, 1 tone will sound.

### 3. Press OFF when finished cooking.

## Convection Roast (on some models)

Convection Roast can be used to roast meat and poultry, and bake foods, such as yeast breads, pies, loaf, bundt and tube cakes on a single rack. During convection roasting, the bake and broil elements will cycle on and off in intervals to maintain oven temperature, while the fan constantly circulates the hot air.

If the oven door is opened during convection roasting, the broil element and convection fan will turn off immediately and the bake element will turn off within 2 minutes. They will come back on once the door is closed.

- Reduce recipe temperature 25°F (14°C). The cook time may need to be reduced also.

## To Convection Roast:

Before convection roasting, position racks according to the "Positioning Racks and Bakeware" section. It is not necessary to wait for the oven to preheat before putting food in, unless recommended in the recipe.

Use the roasting rack on top of the broiler pan and grid. This holds the food above the grid and allows air to circulate completely around all surfaces.

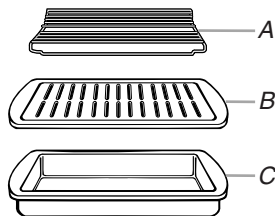

A. Roasting rack  
B. Broiler grid  
C. Broil pan

### 1. Press CONVECT ROAST.

Press the number pads to enter a temperature other than 325°F (162°C). The convection roast range can be set between 170°F and 500°F (77°C and 260°C).

### 2. Press START.

"Preheating" will show in the display until the set temperature is reached.

"Lo°" will also appear in the display if the actual oven temperature is under 170°F (77°C).

When the actual oven temperature reaches 170°F (77°C), the oven display will show the oven temperature increasing in 1-degree increments.

When the set temperature is reached, if on, 1 tone will sound.

### 3. Press OFF when finished cooking.

## CONVECTION ROASTING CHART

FOOD/RACK POSITION	COOK TIME (min. per 1 lb [454 g])	OVEN TEMP.	INTERNAL FOOD TEMP.
<b>Beef, Rack Position 2</b>			
<b>Rib Roast</b>			
rare	20-25	300°F (149°C)	140°F (60°C)
medium	25-30		160°F (71°C)
well-done	30-35		170°F (77°C)
<b>Rib Roast (boneless)</b>			
rare	22-25	300°F (149°C)	140°F (60°C)
medium	27-30		160°F (71°C)
well-done	32-35		170°F (77°C)
<b>Rump, Sirloin Tip Roast</b>			
rare	20-25	300°F (149°C)	140°F (60°C)
medium	25-30		160°F (71°C)
well-done	30-35		170°F (77°C)
<b>Meat Loaf</b>	20-25	325°F (163°C)	165°F (74°C)
<b>Veal, Rack Position 2</b>			
<b>Loin, Rib, Rump Roast</b>			
medium	25-35	325°F (163°C)	160°F (71°C)
well-done	30-40		170°F (77°C)
<b>Pork, Rack Position 2</b>			
<b>Loin Roast (boneless)</b>	30-40	325°F (163°C)	160°F-170°F (71°C-77°C)
<b>Shoulder Roast</b>	35-40		160°F-170°F (71°C-77°C)
<b>Ham, Rack Position 2</b>			
<b>Fresh (uncooked)</b>	25-35	300°F (149°C)	160°F (71°C)
<b>Fully Cooked</b>	15-20	300°F (149°C)	160°F (71°C)
<b>Lamb, Rack Position 2</b>			
<b>Leg, Shoulder Roast</b>			
medium	25-30	300°F (149°C)	160°F (71°C)
well-done	30-35		170°F (77°C)

FOOD/RACK POSITION	COOK TIME (min. per 1 lb [454 g])	OVEN TEMP.	INTERNAL FOOD TEMP.
<b>Chicken*, Rack Position 2</b>			
<b>Whole</b>			
3-5 lbs (1.5-2.2 kg)	20-25	325°F (163°C)	180°F (82°C)
5-7 lbs (2.2-3.1 kg)	15-20	325°F (163°C)	180°F (82°C)
<b>Turkey*, Rack Positions 1 or 2</b>			
13 lbs and under (5.85 kg)	10-15	300°F (149°C)	180°F (82°C)
Over 13 lbs (5.85 kg)	10-12	300°F (149°C)	180°F (82°C)
<b>Cornish Game Hens*, Rack Position 2 or 3</b>			
1-1.5 lbs (0.5-0.7 kg)	50-60	325°F (163°C)	180°F (82°C)

\*Do not stuff poultry when convection roasting.

## Convection Broil (on some models)

Convection Broil is ideal for cooking foods such as thinner cuts of meat; filets of fish; boneless, skinless chicken; vegetables and garlic bread.

During convection broiling, the broil elements will cycle on and off in intervals to maintain oven temperature, while the fan constantly circulates the hot air. The circulating air creates a seal on all sides of the food so that turning of foods is often not necessary.

The temperature is preset at 450°F (232°C), but can be changed to a different temperature. Cooking times will vary depending on the rack position and temperature and may need to be adjusted.

If the oven door is opened during convection broiling, the broil elements and fan will turn off after 30 seconds. They will come back on once the door is closed.

### To Convection Broil:

Before convection broiling, see “Broil” section for general broiling guidelines. Position rack.

Allow the oven to preheat for 5 minutes. Position food on the unheated grid on the broiler pan, then place it in the center of the oven rack with the longest side parallel to the door.

Close the door.

1. Press CONVECT BROIL.

Press the number pads to enter a temperature other than 500°F (260°C). The convection broil range can be set between 300°F and 500°F (149°C and 260°C).

2. Press START.

The set oven temperature will appear on the oven display until oven is turned off.

3. Press OFF when finished cooking.

## Proofing Bread (on some models)

Proofing bread prepares the dough for baking by activating the yeast. Follow the recipe directions as a guide.

### To Proof:

Before first proofing, place the dough in a lightly greased bowl and cover loosely with wax paper, coated with shortening. Place on rack guide 2, then place broiler pan on guide 1. See “Positioning Racks and Bakeware” for diagram. Put 2 cups (500 mL) of boiling water in the broiler pan. Close the door.

1. Press BREAD PROOF.

**Style 1:** The display will show 100°F (38°C).

**Style 2:** The display will show “brd.”

2. Press START.

Let the dough rise until nearly doubled in size, checking after 20-25 minutes. Proofing time may vary depending on dough type and quantity.

3. Press OFF when finished proofing.

Before second proofing, shape the dough, place it in baking pan(s) and cover loosely with plastic wrap, coated with cooking spray. Follow the same placement, broiler pan and water and control steps above. Before baking, remove the plastic wrap.

## Timed Cooking

### WARNING

#### Food Poisoning Hazard

**Do not let food sit in oven more than one hour before or after cooking.**

**Doing so can result in food poisoning or sickness.**

Timed Cooking allows the oven to be set to turn on at a certain time of day, cook for a set length of time, and/or shut off automatically. Delay start should not be used for food such as breads and cakes because they may not bake properly.

### To Set a Cook Time:

1. Press BAKE, CONVECT BAKE, CONVECT ROAST, BROIL, CONVECT BROIL, or BREAD PROOF.

Press the number pads to enter a temperature other than the one displayed.

2. Press COOK TIME.

3. Press number pads to enter the length of time to cook.

4. Press START.

On some models, the start time, stop time and cook time countdown will appear on the oven display.

When the stop time is reached, the oven will shut off automatically, and end-of-cycle tones will sound.

### To Set a Cook Time and Stop Time (Delay Start):

Before setting, make sure the clock is set to the correct time of day. See “Clock/Timer Display” section.

1. Press BAKE, CONVECT BAKE or CONVECT ROAST.

Press the number pads to enter a temperature other than the one displayed.

2. Press COOK TIME.



3. Press number pads to enter the length of time to cook.
4. Press STOP TIME.
5. Press the number pads to enter time of day to stop.
6. Press START.

The start time is automatically calculated and displayed.

“DELAY” and the stop time will also appear on the oven display.

When the start time is reached, the oven will automatically turn on. The cook time countdown will appear on the oven display.

On some models, the set temperature and minute time countdown will appear on the oven display.

When the stop time is reached, the oven will shut off automatically, and end-of-cycle tones will sound.

## Warming Drawer (on some models)

### ! **WARNING**

#### Food Poisoning Hazard

**Do not let food sit for more than one hour before or after cooking.**

**Doing so can result in food poisoning or sickness.**

The Warming Drawer is ideal for keeping hot cooked foods at serving temperature. It may also be used for warming breads and pastries.

Different types of food may be placed in the warming drawer at the same time. For smaller quantities of foods, or food containing eggs, do not hold longer than 30 minutes.

Food must be at serving temperature before being placed in the warming drawer. Breads, pastries, and fruit pies may be heated from room temperature on the HI setting.

Remove food from plastic bags and place in oven-safe container. Cover foods with a lid or aluminum foil.

Do not cover with plastic wrap.

Empty serving dishes and ovenproof dishes can be heated while the warming drawer is preheating.

Do not place food to be warmed directly on warming drawer surface.

#### To Use:

1. Place cooked food(s) in warming drawer.
2. Press WARMING DRAWER ON button.  
“WARM-LOW” will appear on the display.

To change the temperature setting, press WARMING DRAWER ON again. Each press of the WARMING DRAWER ON button will increase the temperature setting. Setting may be changed at any time.

“WARM DRAWER ON” will appear on the display after 5 seconds.

3. Press WARM DRAWER OFF when finished.

### Warming Drawer Settings:

The warming drawer is preset for a “low” temperature, but can be changed by pressing WARMING DRAWER ON additional times. Use the following chart as a guide when selecting a different temperature other than “Low.”

SETTINGS	TEMPERATURES
LOW	100°F (38°C)
MED LOW (Medium Low)	140°F (60°C)
MED (Medium)	160°F (71°C)
MED HI (Medium High)	180°F (88°C)
HI (High)	195°F (91°C)

### Warming Drawer Temperature Chart

Different foods require different settings in order to maintain the ideal serving temperature. Use the following chart as a guide.

FOOD	SETTING
<b>Appetizers</b>	HI
<b>Biscuits</b>	LOW
<b>Chicken</b>	
Boneless, Breaded Nuggets	HI HI
<b>Coffee Cake</b>	LOW
<b>Dinner Plate (1)</b>	
Salisbury Steak, Mashed Potatoes, Corn	HI
<b>Fish Pieces</b>	
Breaded Battered	HI HI
<b>French Fries</b>	HI
<b>Gravy</b>	MED HI
<b>Ham, Boneless</b>	MED
<b>Hard Rolls</b>	LOW
<b>Lasagna</b>	MED HI
<b>Pastries</b>	
Prepackaged, baked Prepackaged, frozen	MED HI LOW
<b>Pie</b>	
Single Crust Double Crust	LOW LOW
<b>Pizza</b>	MED HI
<b>Potatoes, Baked</b>	MED HI
<b>Quiche</b>	MED
<b>Roast, Boneless</b>	MED HI
<b>Roasted Chicken</b>	MED HI
<b>Soft Rolls</b>	LOW

# RANGE CARE

## Self-Cleaning Cycle (on some models)

### **⚠ WARNING**



#### **Burn Hazard**

**Do not touch the oven during the Self-Cleaning cycle.**

**Keep children away from oven during Self-Cleaning cycle.**

**Failure to follow these instructions can result in burns.**

**IMPORTANT:** The health of some birds is extremely sensitive to the fumes given off during the Self-Cleaning cycle. Exposure to the fumes may result in death to certain birds. Always move birds to another closed and well ventilated room.

Self-clean the oven before it becomes heavily soiled. Heavy soil results in longer cleaning and more smoke.

Keep the kitchen well-ventilated during the Self-Cleaning cycle to help get rid of heat, odors, and smoke.

Do not block the oven vent(s) during the Self-Cleaning cycle. Air must be able to move freely. Depending on your model, see "Oven Vent" or "Oven Vents" section.

Do not clean, rub, damage or move the oven door gasket. The door gasket is essential for a good seal.

#### **Prepare Oven:**

- Remove the broiler pan, grid, cookware and bakeware from the oven.
- Remove any foil from the oven because it may burn or melt, damaging the oven.
- Remove oven racks to keep them shiny and easy to slide. See "General Cleaning" section for more information.
- Hand clean inside door edge and the 1½" (3.8 cm) area around the inside oven cavity frame, being certain not to move or bend the gasket. This area does not get hot enough during self-cleaning to remove soil. Do not let water, cleaner, etc. enter slots on door frame. Use a damp cloth to clean this area.
- Wipe out any loose soil to reduce smoke and avoid damage. At high temperatures, foods react with porcelain. Staining, etching, pitting or faint white spots can result. This will not affect cooking performance.

#### **Prepare Cooktop and Storage Drawer:**

- Remove plastic items from the cooktop because they may melt.
- Remove all items from the storage drawer.

#### **How the Cycle Works**

**IMPORTANT:** The heating and cooling of porcelain on steel in the oven may result in discoloring, loss of gloss, hairline cracks and popping sounds.

The Self-Cleaning cycle uses very high temperatures, burning soil to a powdery ash.

The oven is preset for a 2 hour 30 minute clean cycle, however the time can be changed. There are 5 levels of clean. Suggested clean times are 2 hours 30 minutes for light soil and between 3 hours 30 minutes and 4 hours 30 minutes for average to heavy soil. Use the following chart as a guide to determine the desired cleaning level.

<b>CLEANING LEVEL</b>	<b>TOTAL CLEANING TIME (includes a 30 minute cool down time)</b>
1 (Quick)	2 hours 30 minutes
2	3 hours
3 (Regular)	3 hours 30 minutes
4	4 hours
5 (Maxi)	4 hours 30 minutes

Once the oven has completely cooled, remove ash with a damp cloth. Do not wipe down any of the inside surfaces until the oven has completely cooled down. Applying a cool damp cloth to the inner door glass before it has cooled completely could result in the glass breaking.

The oven light will not work during the Self-Cleaning cycle.

On some Canadian models, the surface elements will not work during the Self-Cleaning cycle.

#### **To Self-Clean:**

Before self-cleaning, make sure the door is closed completely or it will not lock and the cycle will not begin.

1. Press SELF CLEAN. To set a clean time other than 3 hours 30 minutes, press SELF CLEAN until the desired time is reached. The clean time can be set between 2 hours 30 minutes and 4 hours 30 minutes.
2. Press START.  
"LOCKING DOOR" will appear on the display as will the clean time, start time and stop time. When the door locks, self-clean will start and "OVEN IS CLEANING" then, "DOOR LOCKED" will appear in the display.

The door will not unlock until the oven cools.

When the cycle is complete and the oven cools, "SELF CLEAN COMPLETE" will appear in the oven display.

3. Press any pad or open the oven door to clear the oven display.

### To Delay Start Self-Clean:

Before delay starting Self-Clean, make sure the clock is set to the correct time of day. See "Clock/Timer Display" section. Also, make sure the door is closed completely or it will not lock and the cycle will not begin.

1. Press SELF CLEAN. To set a clean time other than 3 hours 30 minutes, press SELF CLEAN until the desired time is reached. The clean time can be set between 2 hours 30 minutes and 4 hours 30 minutes.
2. Press STOP TIME.
3. Press the number pads to enter the time of day to stop.
4. Press START.

The start time is automatically calculated and displayed along with the clean time and stop time. "DELAY" will also appear on the display.

When the start time is reached, "LOCKING DOOR" will appear in the display. When the door locks, self-clean will start and "OVEN IS CLEANING" then, "DOOR LOCKED" will appear in the display.

The door will not unlock until the oven cools.

When the cycle is complete and the oven cools, "SELF CLEAN COMPLETE" will appear on the oven display.

5. Press OFF to clear the oven display.

---

## General Cleaning

**IMPORTANT:** Before cleaning, make sure all controls are off and the oven and cooktop are cool. Always follow label instructions on cleaning products.

Soap, water and a soft cloth or sponge are suggested first unless otherwise noted.

---

### EXTERIOR PORCELAIN ENAMEL SURFACES (on some models)

Food spills containing acids, such as vinegar and tomato, should be cleaned as soon as the entire appliance is cool. These spills may affect the finish.

#### Cleaning Method:

- Glass cleaner, mild liquid cleaner or nonabrasive scrubbing pad:  
Gently clean around the model and serial number plate because scrubbing may remove numbers.

---

### STAINLESS STEEL (on some models)

To avoid damage to stainless steel, do not use soap-filled scouring pads, abrasive cleaners, Cooktop Polishing Creme, steel-wool pads, gritty washcloths or some paper towels.

Rub in direction of grain to avoid damaging.

#### Cleaning Method:

- KitchenAid® Stainless Steel Cleaner & Polish (sample included):  
See "Assistance or Service" section to order.
- Liquid detergent or all-purpose cleaner:  
Rinse with clean water and dry with soft, lint-free cloth.
- Vinegar for hard water spots.

---

## CERAMIC GLASS

---

To avoid damage to ceramic glass, do not use steel wool, abrasive powder cleansers, chlorine bleach, rust remover or ammonia.

Always wipe with a clean, wet cloth or sponge and dry thoroughly to avoid streaking and staining.

Cooktop Cleaner is recommended regularly to help avoid scratches, pitting and abrasions and to condition the cooktop, and can be ordered as an accessory. See "Assistance or Service" to order.

A Cooktop Scraper is also recommended for stubborn soils, and can be ordered as an accessory. See "Assistance or Service" to order. The Cooktop Scraper uses razor blades. **Store razor blades out of the reach of children.**

#### Cleaning Method:

##### Light to moderate soil

- Paper towels or clean damp sponge:

Clean while the cooktop is still warm. You may want to wear oven mitts while doing so.

##### Sugary spills (jellies, candy, syrup)

- Cooktop Scraper:

Clean while the cooktop is still warm. You may want to wear oven mitts while doing so.

- Cooktop Polishing Creme and clean damp paper towel:

Clean as soon as cooktop has cooled down. Rub creme into surface with a damp paper towel or soft cloth. Continue rubbing until white film disappears.

##### Heavy soil, dark streaks, specks and discoloration

- Cooktop Polishing Creme or nonabrasive cleanser:

Rub product into soil with a damp paper towel or soft cloth. Continue rubbing until white film disappears.

##### Burned-on soil

- Cooktop Polishing Creme and Cooktop Scraper:

Rub creme into soil with damp paper towel. Hold scraper as flat as possible on surface and scrape. Repeat for stubborn spots. Polish entire cooktop with creme and paper towel.

##### Metal marks from aluminum and copper

- Cooktop Polishing Creme:

Clean as soon as cooktop has cooled down. Rub creme into surface with a damp paper towel or soft cloth. Continue rubbing until white film disappears. The marks will not totally disappear but after many cleanings become less noticeable.

##### Tiny scratches and abrasions

- Cooktop Polishing Creme:

Rub creme into surface with a damp paper towel or soft cloth. Continue rubbing until white film disappears. Scratches and abrasions do not affect cooking performance and after many cleanings become less noticeable.

---

## COOKTOP CONTROLS

---

Do not use steel wool, abrasive cleansers or oven cleaner.

Do not soak knobs.

When replacing knobs, make sure knobs are in the Off position.

On some models, do not remove seals under knobs.

### Cleaning Method:

- Soap and water or dishwasher:  
Pull knobs straight away from control panel to remove.

---

## CONTROL PANEL

---

Do not use abrasive cleaners, steel-wool pads, gritty washcloths or some paper towels. Damage may occur.

### Cleaning Method:

- Glass cleaner and soft cloth or sponge:  
Apply glass cleaner to soft cloth or sponge, not directly on panel.

---

## OVEN DOOR EXTERIOR

---

### Cleaning Method:

- Glass cleaner and a soft cloth or sponge:  
Apply glass cleaner to soft cloth or sponge, not directly on panel.

---

## OVEN CAVITY

---

Do not use oven cleaners.

Food spills should be cleaned when oven cools. At high temperatures, foods react with porcelain and staining, etching, pitting or faint white spots can result.

### Cleaning Method:

- Self-Cleaning cycle:  
See "Self-Cleaning Cycle" first.

---

## OVEN AND ROASTING RACKS

---

### Cleaning Method:

- Self-Cleaning cycle:  
See "Self-Cleaning Cycle" first. Remove racks or they will discolor and become harder to slide. If this happens, a light coating of vegetable oil applied to the rack guides will help them slide.
- Steel-wool pad

---

## BROILER PAN AND GRID

---

Do not clean in the Self-Cleaning cycle.

### Cleaning Method:

- Mildly abrasive cleanser:  
Scrub with wet scouring pad.
- Solution of ½ cup (125 mL) ammonia to 1 gal. (3.75 L) water:  
Soak for 20 minutes, then scrub with scouring or steel-wool pad.
- Oven cleaner:  
Follow product label instructions.

### Porcelain enamel only, not chrome

- Dishwasher

---

## STORAGE DRAWER (on some models)

---

Make sure drawer is cool and empty before cleaning.

For more information, see "Storage Drawer" section.

### Cleaning Method:

- Mild detergent

---

## WARMING DRAWER (on some models)

---

Make sure drawer is cool.

### Cleaning Method:

- KitchenAid® Stainless Steel Cleaner & Polish (sample included):  
See "Assistance or Service" section to order.
- All-Purpose Appliance Cleaner (not included):  
See "Assistance or Service" section to order.
- Mild detergent

---

## Oven Light(s)

The oven light is a standard 15-watt appliance bulb. It will come on when the oven door is opened. The light will not work during the Self-Cleaning cycle (on some models). On some models, when the oven door is closed, press OVEN LIGHT to turn the light on or off.

### To Replace:

Before replacing, make sure the oven and cooktop are cool and the control knobs are off.

1. Unplug range or disconnect power.
2. Turn the glass bulb cover in the back of the oven counterclockwise to remove.

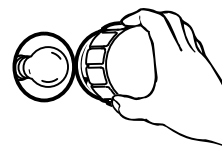

3. Turn bulb counterclockwise to remove from socket.
4. Replace bulb and bulb cover by turning clockwise.
5. Plug in range or reconnect power.

---

## Oven Door

For normal range use, it is not suggested to remove the oven door. However, if removal is necessary, make sure the oven is off and cool. Then, follow these instructions. The oven door is heavy.

### To Remove:

1. Open oven door all the way.
2. Flip up the hinge latch on each side.

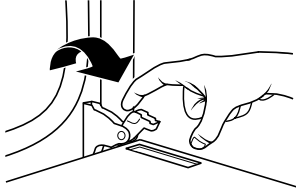

3. Close the oven door as far as it will shut.
4. Lift the oven door while holding both sides.  
Continue to push the oven door closed and pull it away from the oven door frame.

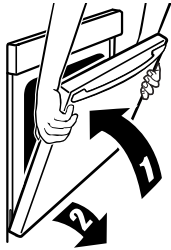

### To Replace:

1. Insert both hanger arms into the door.



2. Open the oven door.  
You should hear a "click" as the door is set into place.
3. Move the hinge levers back to the locked position. Check that the door is free to open and close. If it is not, repeat the removal and installation procedures.

---

## Storage Drawer

The storage drawer can be removed. Before removing, make sure drawer is cool and empty.

### To Remove:

1. Pull drawer straight out to the first stop.
2. Lift up the back of the drawer and pull out.

### To Replace:

1. Fit the ends of the drawer rails into the guides in the cavity.
2. Slide the drawer closed.

---

## Warming Drawer (on some models)

Remove all items from inside the warming drawer, and allow the warming drawer to cool completely before attempting to remove the drawer.

### To Remove:

1. Open drawer to its full open position.
2. Locate the black loops on both sides of the drawer.

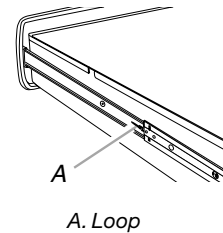

3. Pull both loops forward at the same time, then pull drawer out another inch.

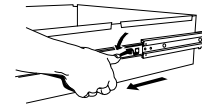

4. Holding the drawer by its sides, not its front, gently pull it all the way out.

### To Replace:

1. Align the drawer glides with the receiving guides.

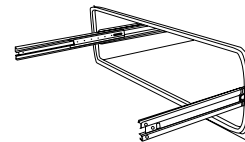

2. Push drawer in all the way.
3. Gently open and close the drawer to ensure it is seated properly on the slides.

---

# TROUBLESHOOTING

Try the solutions suggested here first in order to avoid the cost of an unnecessary service call.

---

## Nothing will operate

---

- **Is the power supply cord unplugged?** Plug into a grounded outlet.
  - **Has a household fuse blown, or has a circuit breaker tripped?** Replace the fuse or reset the circuit breaker. If the problem continues, call an electrician.
- 

## Cooktop will not operate

---

- **Is the control knob set correctly?** Push in knob before turning to a setting.
  - **On some ceramic glass models, is the Cooktop Control Lock set?** See "Control Lock/All Off" in "Cooktop Controls - Touch Activated Custom Control Temperature Management System" section.
- 

## Excessive heat around cookware on cooktop

---

- **Is the cookware the proper size?** Use cookware about the same size as the surface cooking area, element or surface burner. Cookware should not extend more than ½" (1.3 cm) outside the cooking area.
- 

## Hot surface indicator light stays on

---

- **Does the hot surface indicator light stay on after controls have been turned off?** See "Hot Surface Indicator Lights" in "Cooktop Controls - Touch-Activated Custom Control Temperature Management System," "Cooktop Controls - Custom Knobs Custom Control Temperature Management System" or "Cooktop Controls - Standard Knobs" section, depending on your model.
- 

## Cooktop cooking results not what expected

---

- **Is the proper cookware being used?** See "Cookware" section.
  - **Is the control knob or element controls set to the proper heat level?** See "Cooktop Controls - Touch-Activated Custom Control Temperature Management System," "Cooktop Controls - Custom Knobs Custom Control Temperature Management System" or "Cooktop Controls - Standard Knobs" section, depending on your model.
  - **Is the appliance level?** Level the appliance. See the Installation Instructions.
- 

## Oven will not operate

---

- **Is the electronic oven control set correctly?** See "Electronic Oven Control" section.
  - **Has a delay start been set?** See "Timed Cooking" section.
  - **On some models, is the Control Lock set?** See "Control Lock" section.
  - **On some models, is the Sabbath Mode set?** See "Sabbath Mode - Option 7" section.
- 

## Oven temperature too high or too low

---

- **Does the oven temperature calibration need adjustment?** See "Oven Temperature Calibration - Option 6" section.
  - **On some models, does the cooling fan run during BAKE, BROIL or CLEAN?** It is normal for the fan to automatically run when the oven is in use. This helps cool the electronic control.
- 

## Display shows messages

---

- **Is the display showing "SET CLOCK"?** There has been a power failure. Clear the display. See "Oven Displays" section. On some models, reset the clock, if needed. See "Clock/Timer Display" section.
  - **Is the display showing a letter followed by a number?** Press OFF to clear the display. See "Oven Displays" section. If it reappears, call for service. See "Assistance or Service" section.
- 

## Self-Cleaning cycle will not operate

---

- **Is the oven door open?** Close the oven door all the way.
  - **Has the function been entered?** See "Self-Cleaning Cycle" section.
  - **On some models, has a delay start Self-Clean cycle been set?** See "Self-Cleaning Cycle" section.
  - **Has a delay start been set?** See "Timed Cooking" section.
- 

## Oven cooking results not what expected

---

- **Is the appliance level?** Level the appliance. See the Installation Instructions.
  - **Is the proper temperature set?** Double-check the recipe in a reliable cookbook.
  - **Is the proper oven temperature calibration set?** See "Oven Temperature Calibration - Option 6" section.
-

- **Was the oven preheated?** See “Bake,” “Broil,” “Easy Convection Conversion,” “Convection Bake,” “Convection Roast” or “Convection Broil” section.
- **Is the proper bakeware being used?** See “Bakeware” section.
- **Are the racks positioned properly?** See “Positioning Racks and Bakeware” section.
- **Is there proper air circulation around bakeware?** See “Positioning Racks and Bakeware” section.
- **Is the batter evenly distributed in the pan?** Check that batter is level in the pan.
- **Is the proper length of time being used?** Adjust cooking time.
- **Has the oven door been opened while cooking?** Oven peeking releases oven heat and can result in longer cooking times.
- **Are baked items too brown on the bottom?** Move rack to higher position in the oven.
- **Are pie crust edges browning early?** Use aluminum foil to cover the edge of the crust and/or reduce baking temperature.

## ASSISTANCE OR SERVICE

Before calling for assistance or service, please check “Troubleshooting.” It may save you the cost of a service call. If you still need help, follow the instructions below.

When calling, please know the purchase date and the complete model and serial number of your appliance. This information will help us to better respond to your request.

### If you need replacement parts

If you need to order replacement parts, we recommend that you use only factory specified parts. These factory specified parts will fit right and work right because they are made with the same precision used to build every new KITCHENAID® appliance.

To locate factory specified parts in your area, call us or your nearest KitchenAid designated service center.

### In the U.S.A.

Call the KitchenAid Customer eXperience Center toll free: **1-800-422-1230**.

#### Our consultants provide assistance with:

- Features and specifications on our full line of appliances.
- Installation information.
- Use and maintenance procedures.
- Accessory and repair parts sales.
- Specialized customer assistance (Spanish speaking, hearing impaired, limited vision, etc.).
- Referrals to local dealers, repair parts distributors and service companies. KitchenAid designated service technicians are trained to fulfill the product warranty and provide after-warranty service, anywhere in the United States.

To locate the KitchenAid designated service company in your area, you can also look in your telephone directory Yellow Pages.

#### For further assistance

If you need further assistance, you can write to KitchenAid with any questions or concerns at:

KitchenAid Brand Home Appliances  
Customer eXperience Center  
553 Benson Road  
Benton Harbor, MI 49022-2692

Please include a daytime phone number in your correspondence.

#### Accessories U.S.A.

To order accessories, call the KitchenAid Customer eXperience Center toll free at **1-800-442-9991** and follow the menu prompts. Or visit our website at **www.kitchenaid.com** and click on “Shopping Options,” then “Replacement Parts and Accessories.” Portable appliances, bakeware, cookware, gadgets and textiles are also available.

#### KitchenAid® Stainless Steel Cleaner & Polish

(stainless steel models)

Order Part Number 4396920

#### KitchenAid® Stainless Steel Wipes

(stainless steel models)

Order Part Number 8212510

#### Cooktop Cleaner

(porcelain or glass cooktop surfaces)

Order Part Number 31464

#### Cooktop Protectant

(porcelain or glass cooktop surfaces)

Order Part Number 31463

#### Cooktop Scraper

(ceramic glass models)

Order Part Number WA906B

#### Brick Pizza Stone

Order Part Number 4378577

### In Canada

Call the KitchenAid Canada Customer Interaction Centre toll free: **1-800-807-6777**.

#### Our consultants provide assistance with:

- Features and specifications on our full line of appliances.
- Use and maintenance procedures.
- Accessory and repair parts sales.
- Referrals to local dealers, repair parts distributors and service companies. KitchenAid Canada designated service technicians are trained to fulfill the product warranty and provide after-warranty service, anywhere in Canada.

#### For further assistance

If you need further assistance, you can write to KitchenAid Canada with any questions or concerns at:

Customer Interaction Centre  
KitchenAid Canada  
1901 Minnesota Court  
Mississauga, Ontario L5N 3A7

Please include a daytime phone number in your correspondence.

---

# KITCHENAID® ELECTRIC RANGE WARRANTY

---

## ONE YEAR LIMITED WARRANTY

For one year from the date of purchase, when this major appliance is operated and maintained according to instructions attached to or furnished with the product, KitchenAid or KitchenAid Canada (hereafter "KitchenAid") will pay for factory specified parts and repair labor to correct defects in materials or workmanship. Service must be provided by a KitchenAid designated service company.

---

## SECOND THROUGH FIFTH YEAR LIMITED WARRANTY ON CERTAIN COMPONENT PARTS

In the second through fifth years from the date of purchase, when this appliance is operated and maintained according to instructions attached to or furnished with the product, KitchenAid or KitchenAid Canada will pay for factory specified parts for the following components if defective in materials or workmanship:

- Electric elements
  - Solid state touch control system parts
  - Any cracking of the rubber seal between the ceramic glass cooktop and porcelain edge
  - Any cracking due to thermal shock of the ceramic glass cooktop
  - Surface unit elements
- 

## ITEMS KITCHENAID WILL NOT PAY FOR

1. Service calls to correct the installation of your major appliance, to instruct you how to use your major appliance, to replace or repair house fuses or to correct house wiring or plumbing.
  2. Service calls to repair or replace appliance light bulbs, air filters or water filters. Those consumable parts are excluded from warranty coverage.
  3. Repairs when your major appliance is used for other than normal, single-family household use.
  4. Damage resulting from accident, alteration, misuse, abuse, fire, flood, acts of God, improper installation, installation not in accordance with electrical or plumbing codes, or use of products not approved by KitchenAid.
  5. Replacement parts or repair labor costs for units operated outside the United States or Canada.
  6. Pickup and delivery. This major appliance is designed to be repaired in the home.
  7. Repairs to parts or systems resulting from unauthorized modifications made to the appliance.
  8. Expenses for travel and transportation for product service in remote locations.
  9. The removal and reinstallation of your appliance if it is installed in an inaccessible location or is not installed in accordance with published installation instructions.
- 

## DISCLAIMER OF IMPLIED WARRANTIES; LIMITATION OF REMEDIES

CUSTOMER'S SOLE AND EXCLUSIVE REMEDY UNDER THIS LIMITED WARRANTY SHALL BE PRODUCT REPAIR AS PROVIDED HEREIN. IMPLIED WARRANTIES, INCLUDING WARRANTIES OF MERCHANTABILITY OR FITNESS FOR A PARTICULAR PURPOSE, ARE LIMITED TO ONE YEAR OR THE SHORTEST PERIOD ALLOWED BY LAW. KITCHENAID SHALL NOT BE LIABLE FOR INCIDENTAL OR CONSEQUENTIAL DAMAGES. SOME STATES AND PROVINCES DO NOT ALLOW THE EXCLUSION OR LIMITATION OF INCIDENTAL OR CONSEQUENTIAL DAMAGES, OR LIMITATIONS ON THE DURATION OF IMPLIED WARRANTIES OF MERCHANTABILITY OR FITNESS, SO THESE EXCLUSIONS OR LIMITATIONS MAY NOT APPLY TO YOU. THIS WARRANTY GIVES YOU SPECIFIC LEGAL RIGHTS AND YOU MAY ALSO HAVE OTHER RIGHTS, WHICH VARY FROM STATE TO STATE OR PROVINCE TO PROVINCE.

Outside the 50 United States and Canada, this warranty does not apply. Contact your authorized KitchenAid dealer to determine if another warranty applies.

If you need service, first see the "Troubleshooting" section of the Use & Care Guide. After checking "Troubleshooting," additional help can be found by checking the "Assistance or Service" section or by calling KitchenAid. In the U.S.A., call **1-800-422-1230**. In Canada, call **1-800-807-6777**.

9/05

---

**Keep this book and your sales slip together for future reference. You must provide proof of purchase or installation date for in-warranty service.**

Write down the following information about your major appliance to better help you obtain assistance or service if you ever need it. You will need to know your complete model number and serial number. You can find this information on the model and serial number label located on the product.

Dealer name \_\_\_\_\_

Address \_\_\_\_\_

Phone number \_\_\_\_\_

Model number \_\_\_\_\_

Serial number \_\_\_\_\_

Purchase date \_\_\_\_\_



## Free Manuals Download Website

<http://myh66.com>

<http://usermanuals.us>

<http://www.somanuals.com>

<http://www.4manuals.cc>

<http://www.manual-lib.com>

<http://www.404manual.com>

<http://www.luxmanual.com>

<http://aubethermostatmanual.com>

Golf course search by state

<http://golfingnear.com>

Email search by domain

<http://emailbydomain.com>

Auto manuals search

<http://auto.somanuals.com>

TV manuals search

<http://tv.somanuals.com>