

A Guide to the TracPhone F33 user's guide



KVH TracPhone® F33

Congratulations!

You have selected one of the most advanced and convenient marine communications systems available today. The KVH® Industries' TracPhone® F33/F55/F77 system, manufactured by Thrane & Thrane, is designed to provide high-quality voice, fax, data, and high-speed Internet access.

Technical Support

Please direct any technical questions to:

North America

KVH Industries, Inc.
50 Enterprise Center
Middletown, RI 02842 USA
Tel: +1 401 847-3327
Fax: +1 401 849-0045
E-mail: techs@kvh.com
Internet: www.kvh.com

Europe/Middle East/Africa

KVH Europe A/S
Kokkedal Industripark 2B
2980 Kokkedal, Denmark
Tel: +45 45 160 180
Fax: +45 45 160 181
E-mail: customersupport@kvh.dk
Internet: www.kvh.com

Product Registration

Don't forget to register your TracPhone system for KVH's **free** customer support subscription service. When you register, you will receive technical and service updates specific to your system along with customer support and product news. In addition, with your information on file, KVH will be able to offer you even faster, more convenient product, customer, and warranty support. *KVH will NOT sell or share your data with other companies or organizations.*

To register your system, simply fill out the enclosed Product Registration Form or visit www.kvh.com/register.



Product Information

Before installing the TracPhone, be sure to write down the following information:

ISN: _____

Above Decks Unit (ADU)

S/N: _____

Below Decks Unit (BDU)

S/N: _____

BDU Build Date: ____ / ____ / ____
 YY MM DD

This information will be required for all troubleshooting or service calls made regarding this product.



PLEASE READ!

Important Notice About Your Data Connection

To prevent inadvertent airtime usage, the user must disconnect the data connection when not in use. If the data connection is not properly disconnected, your computer may dial out on its own, which could result in an unintended airtime charge.

KVH accepts no responsibility if this occurs. It is the vessel owner's responsibility to ensure that the TracPhone is correctly interfaced with the vessel's computer.

If you have any questions about data connections, please contact KVH Technical Support.

Thrane & Thrane A/S

SAILOR Fleet33

TT-3088A

User Manual

Copyright© Thrane & Thrane A/S

ALL RIGHTS RESERVED

Information in this document is subject to change without notice and does not represent a commitment on the part of Thrane & Thrane A/S. It is recommended to download the latest version of the manual from the Thrane Extra net or request this from the distributor.

© 2005 Thrane & Thrane A/S. All rights reserved. Printed in Denmark.

Trademark Acknowledgements:

WinPoET is a trademark of iVasion, a RouterWare Company.

Document No: TT98—116874-F.

Release date: 26 May 2005.

Safety Summary

The following general safety precautions must be observed during all phases of operation, service and repair of this equipment. Failure to comply with these precautions or with specific warnings elsewhere in this manual violates safety standards of design, manufacture and intended use of the equipment. Thrane & Thrane A/S assumes no liability for the customer's failure to comply with these requirements.

Microwave Radiation Hazards

During transmission the antenna in this system radiates Microwave Power. This radiation may be hazardous if exposed directly to humans, close to the antenna. During transmission, make sure that nobody gets closer than the recommended minimum safety distance. The minimum safety distance to the antenna on the focal line is 1.3 m.

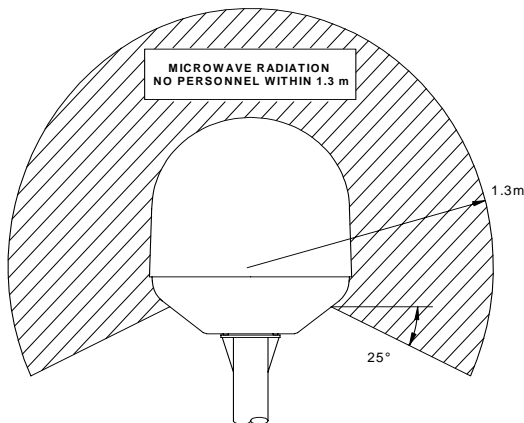

GROUND THE EQUIPMENT

To minimize shock hazard, the equipment chassis and cabinet must be connected to an electrical ground.

DO NOT OPERATE IN AN EXPLOSIVE ATMOSPHERE

Do not operate the equipment in the presence of flammable gases or fumes. Operation of any electrical equipment in such an environment constitutes a definite safety hazard.

KEEP AWAY FROM LIVE CIRCUITS

Operating personnel must not remove equipment covers. Component replacement and internal adjustment must be made by qualified maintenance personnel. Do not replace components with the power cable connected. Under certain conditions, dangerous voltages may exist even with the power cable removed. To avoid injuries, always disconnect power and discharge circuits before touching them.

DO NOT SERVICE OR ADJUST ALONE

Do not attempt internal service or adjustments unless another person, capable of rendering first aid resuscitation, is present.

Table of Contents

1	About the Manual	1
1.1	Abbreviations	1
2	Introduction	3
2.1	The Inmarsat Fleet Service	3
2.2	The SAILOR Fleet33 System.....	6
2.3	Hardware Interfaces.....	9
2.4	The Handset	11
2.4.1	LCD/LED.....	12
2.4.2	Function Buttons.....	16
2.4.3	Alpha-Numeric Section	18
3	Getting Started	23
3.1	Get Ready to Make a Call.....	23
3.1.1	How to Power-Up the System.	23
3.1.2	How to Shut Down the System.	25
3.2	Use of PIN Codes.....	26
3.3	Normal Calls	27
3.3.1	Calling From the TT-3088A.....	27
3.3.2	Calling To the TT-3088A.....	28
3.4	Data Calls.....	29
3.4.1	MPDS Connection.....	29
3.4.2	Call waiting.....	30
3.4.3	9600 Data Connection	31
4	Operation.....	33
4.1	Call Functions	33
4.1.1	Calls Using the Phone Book	33
4.1.2	Call From Handset Connected to RJ11	33
4.1.3	Fax Calls.....	34
4.1.4	Internal Calls.....	35
4.2	Using the Menu System.....	35
4.3	Menu System – All Users	36

Table of Contents

4.3.1	Phonebook.....	36
4.3.2	Area.....	38
4.3.3	LES.....	39
4.3.4	Mailbox	40
4.3.5	Help Desk	41
4.3.6	Alarm Log.....	42
4.3.7	Status	43
4.4	Menu System - Super User	46
4.4.1	Call Logs	46
4.4.2	Routing	47
4.4.3	Data Setup	49
4.4.4	Contrast	49
4.4.5	Ring Setup.....	50
4.4.6	Key Beep	50
4.4.7	Set UTC Time	51
4.4.8	Set UTC Date	51
4.4.9	Disclose Pos.	52
4.4.10	Allowed Dial	52
4.4.11	Ph.Book Dial	53
4.4.12	Auto Prefix.....	54
4.4.13	BarServiceIn	54
4.4.14	BarServiceOut	55
4.4.15	LED Dimm	55
4.4.16	Ant.Setup	56
4.4.17	Alarm log.....	57
4.4.18	Warning Log.....	58
4.4.19	Help Desk	58
4.4.20	PIN codes	59
4.4.21	Mail Box	59
4.4.22	RJ11 Setup	60
4.4.23	LES Config.....	61
4.4.24	Additional Features	62
4.4.25	Data Limits	63
4.4.26	Call Waiting Notification	64
5	PC Programs	67
5.1	System Set-up using FleetCP	67

5.1.1	The Map	68
5.1.2	Pin Codes	69
5.1.3	Phonebook	70
5.1.4	Satellite Setup	71
5.1.5	Routing	72
5.1.6	Setting up Time and Date.....	73
5.1.7	Barring Services	74
5.1.8	Settings.....	75
5.1.9	Antenna	76
5.2	Set-up Using RS-232.....	77
5.2.1	Set-up for MPDS	77
5.2.2	Set-up for 9600 Data.....	81
5.3	Set-up using Ethernet/PPPoE.....	84
5.3.1	Windows XP with Built-in PPPoE Client	84
5.3.2	Windows 2000 WinPoET PPPoE Client.....	85
6	Troubleshooting	89
6.1	List of Error messages	89
6.1.1	Satellite Network Messages	89
6.1.2	TT-3088A Messages	103
7	Index	107
	Appendix A - Menu Tree	109

Blank page

1 About the Manual

Congratulations on purchasing your TT-3088A SAILOR Fleet33 product. This system makes it possible for you to communicate from virtually any ocean region in the world using the Inmarsat Fleet service established by Inmarsat. The system supports inexpensive voice services as well as data and fax (Spot beam only). This manual has the following chapters:

Chapter **2 Introduction** - an overview of the Inmarsat Fleet system and its services. Also a brief description of the systems.

Chapter **3 Getting Started** - a description of how to make and receive calls and the use of PIN codes.

Chapter **4 Operation** - a detailed description of the menu system in the terminal.

Chapter **5 PC Programs** - a description on how to use the accompanying configuration PC software (FleetCP).

Chapter **6 Troubleshooting** – a description of the most common errors, how to deal with them and how to get further help if necessary.

Chapter **7 Index** - a subject index

Appendix A - Menu Tree

1.1 Abbreviations

ACU	Antenna Control Unit
ADU	Above Deck Unit
AORE	Atlantic Ocean Region East

AORW	Atlantic Ocean Region West
BDU	Below Deck Unit
FEU	Front End Unit
GPS	Global Positioning System
IMN	Inmarsat Mobile Number
ISDN	Integrated Services Digital Network
ISN	Inmarsat Serial Number
IOR	Indian Ocean Region
ISP	Inmarsat Service Provider
LCD	Liquid Crystal Display
LED	Light Emitting Diode
LES	Land Earth Stations
MES	Mobile Earth Station
MMI	Man Machine Interface
MPDS	Mobile Packet Data Service
MSN	Multiple Subscriber Number
NCS	Network Co-ordination Station
NSR	Network Status Record
PIN	Personal Identification Number
PUK	Personal Unblocking Key
POR	Pacific Ocean Region
PSTN	Public Services Telephone Network
RCC	Rescue Co-ordination Center
STE	Secure Telephone Equipment
T&T	Thrane & Thrane A/S
TNID	Terrestrial Network ID
UDI	Unrestricted Digital Information

2 Introduction

2.1 The Inmarsat Fleet Service

The Inmarsat Fleet service is based on 4 Geo-stationary 3rd generation satellites situated above the equator. Geo-stationary means that the satellites are always located in the same position, i.e. they rotate at the same speed as that of the earth. Each satellite covers a certain area (footprint) and supports a number of powerful spot-beams making the service available in virtually all ocean regions on the earth between approximately 76°N and 76°S.

The 4 Geo-Stationary Inmarsat Satellites

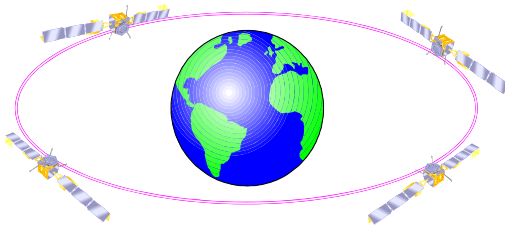

The satellites are your connection to the worldwide networks, and they are managed by the Network Co-ordination Stations (NCSs), run by Inmarsat. The primary functions of the NCSs are to constantly keep track of which terminals are logged on to the system, and assign a free channel whenever a call is made.

A Land Earth Station (LES) is a gateway between the public network and the satellites. Different operators around the world run the various LES's.

The Fleet services are prepared for operation with the next generation of Inmarsat satellites (Inm-IV) expected in 2005. The services, which allow for a wide range of applications, supported by the Inmarsat Fleet encompass:

- Circuit switched services:
 - Mini M voice call (Global)
 - 9.6 kbps data (Spot beam only)
 - 9.6 kbps fax (Spot beam only)
- Packet switched services
 - 64/28 kbps MPDS (Spot beam only)

(cf. Appendix B for a map on global and spot beam coverage).

Service explanation:

The **mini-M voice** service is only for voice transmission. The voice transmitted over the satellite is subject to a compression process down to 4.8 kbit/s, which reduces the bandwidth use and subsequently the cost.

The **9.6 kbps fax** service is a service that enables G3 fax machines employing one of the modem standards: V.27 or V.29.

The **9.6 kbps data** service allows you to establish a 9.6 kbps circuit switched data connection employing the modem standard: V.24.

The **MPDS service** is a packet data service where the tariff depends on the amount of data transmitted. This service is a more cost-effective solution for web browsing, and other applications where there is no need for constant transmission of data in both directions. It is also suitable for applications where a constant connection is required, because the user is no longer charged the "per minute rate". The channel is a shared channel i.e. the transmission

speed may be reduced when other users are using the same channel. The channel to be shared among the users has a capacity of 64 kbps in the direction to the terminal, and from the terminal the channel to be shared among the users has a capacity of 28 kbps.

Important notice: Before a terminal can be used on the network, it has to be commissioned by one of the Inmarsat Service Providers (ISP's). In order to use the different Inmarsat Fleet services it is necessary to have at least one Inmarsat Mobile Number (IMN) for each of the above mentioned services. In case all 3 circuit switched services are commissioned on your terminal, you will have 3 IMN numbers.

Calling an Inmarsat Fleet terminal is equal to making international calls. If the satellite region/area is not known for the terminal the "country" code for a terminal is 870. When you dial an Inmarsat Fleet terminal through the public network, you have to dial the IMN number in addition to the international access code for Inmarsat, e.g.:

+870 600 555 555

Making calls from an Inmarsat Fleet terminal is equal to making international calls, as the country code always has to be dialed.

2.2 The SAILOR Fleet33 System

The SAILOR Fleet33 System includes the following system components:

- TT-3008G SAILOR Fleet33 Antenna (ADU)
- TT-3038G SAILOR Fleet33 Transceiver Unit (BDU)
- TT-3622E SAILOR Fleet33 Handset Cradle
- TT-3620G SAILOR Fleet33 Control Handset (4 wire)
- Accessories (manual, software, etc.)



Instructions on how to assemble the system, wiring and specification, can be found in the Installation Manual.

TT-3008G SAILOR Fleet33 Antenna

The TT-3008G antenna or ADU (Above Deck Unit) is a stabilized high-gain antenna. The antenna has built-in all functions for satellite tracking including a GPS system.



TT-3038G SAILOR Fleet33 Transceiver Unit (BDU)

All the interface connectors are located on the rear of the Transceiver Unit or BDU (Below Deck Unit).



TT-3622E SAILOR Fleet33 Handset Cradle / TT-3620G SAILOR Fleet33 Control Handset (4 wire)

The Handset is used to configure the system and to make calls. See section 2.4 for a description of buttons, LED's and display of the handset.



2.3 Hardware Interfaces

The Transceiver Unit of the SAILOR Fleet33 has the following hardware interfaces:

- Analogue RJ11 number 1
- Analogue RJ11 number 2
- Handset (4 wire)
- Ethernet
- RS-232
- 4 Discrete I/O
- Power Connector

All connectors for these interfaces are found on the rear of the Transceiver Unit.

Two Analogue RJ11 interfaces:



The RJ11 ports as shown above can be used for connection of analogue phones and G3 fax machines.

Selection of service for the interfaces is independent of each other. If the mini-M voice is selected, a phone must be connected as only voice connections can be established.

Cradle/Handset interface:



The transceiver has one 4-wire handset port with RS-485 data control. The Handset can be used to set-up the terminal and it can be used to make or receive phone calls.

Ethernet interface:

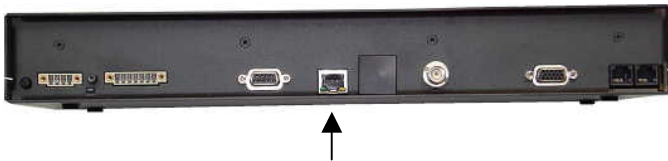

The Ethernet interface is a RJ45 connector. It can be used for the following service types:

- MPDS service
- Connection of an IP Router

RS-232 interface:

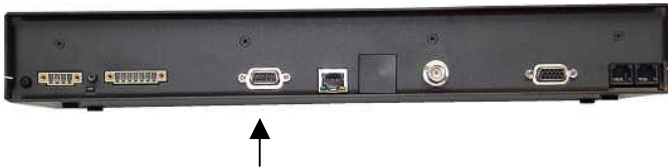

The RS-232 interface is a standard 9-pin serial port, with a maximum port speed of 115.2 kbps. It can be used for the following service types:

- MPDS service
- 9.6 kbps data
- Configuration of the terminal via FleetCP software
- Connection of a IP Router

When using the FleetCP program, the PC must be connected to the RS-232 interface (see section 5.1).

Discrete I/O interface:



The transceiver also has a discrete I/O interface, containing 4 configurable input/output.

Power Connector:



For connection of power, see Installation Manual.

2.4 The Handset

The Handset is the primary interface for the SAILOR Fleet 33 system. It enables the user to dial numbers, it displays error and status messages, and it is used to configure the transceiver.

The Handset is divided into 3 distinct and inter-working sections.

1. The first is the Liquid Crystal Display (LCD) and Light Emitting Diodes (LED) section. This section gives the user visual indications about the operation and status of the system.

2. The second is the Function buttons section. This section enables the user to interact with the software menu system of the transceiver.
3. The third is the Alpha-Numeric section. This section enables the user to dial and perform data entry functions into the transceiver.

In the following these sections are described in details.

2.4.1 LCD/LED





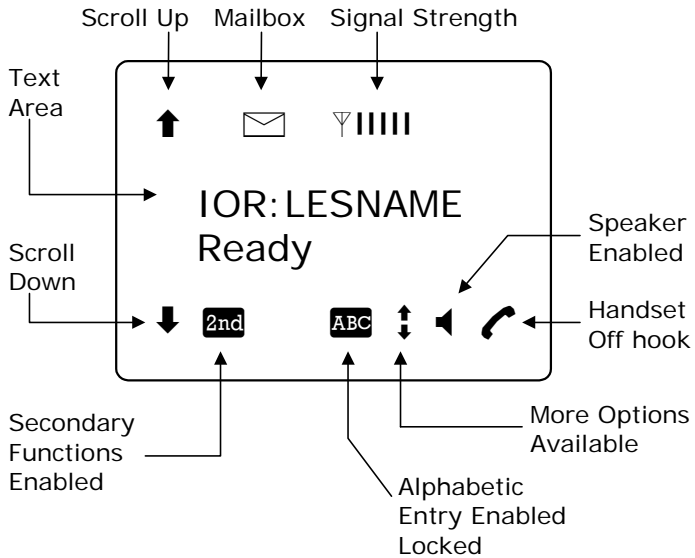





As shown in the picture above, the top of the handset contains the LCD for displaying information to the user. It can be adjusted for contrast and is backlit for viewing in dimly lit areas or night operations. The LCD display is graphically shown below:



The display contains a set of symbols, which together with the 4 indicators situated below the display gives continuous indication of current status.

Symbol	Meaning
↑	More menu entries above.
↓	More menu entries below
2nd	Turned on when the 2nd key has been pressed.
ABC	Turned on when the keypad is in alpha mode. Alpha mode is used to enter letters (for example names in the phone book).
↕	The value in a menu must be selected

Symbol	Meaning
	between certain predefined values by means of the  and  keys.
	The speaker. The user can turn the external speaker on and off by pressing   . The  symbol is displayed in the LCD when on.
	Short message stored at a LES – see section 4.3.4 and 4.4.21 Mail Box for further information.
	The number of bars (I) following this antenna symbol indicates received signal strength. Up to 5 bars. The number of displayed bars may fluctuate during a call. This is due to a power reduction, negotiated between the terminal and the LES.
	The handset is off hook

There are four LED's under the LCD display (see below). From left to right they are Power (GREEN) – Alarm (RED) – Connected (AMBER) – Synchronization (GREEN).

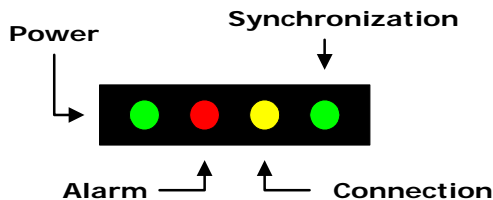

POWER LED (GREEN): The Power LED indicates that the system is powered up.

ALARM LED (RED): The Alarm LED will illuminate when the system detects a fault. An error code will also be displayed in the LCD and in the error log.

CONNECTION LED (AMBER): The Connection LED will flash when a call is ringing at the receiving end and will illuminate steady when a connection is made.

SYNCHRONIZATION LED (GREEN): This is a dual function LED. Initially, the LED will illuminate when the system has synchronization with a satellite. When the system has established a data call, the LED assumes its secondary function as a data transfer light. When data is being transferred (sent or received), the LED will light. This is a quick visual reference during data communications.

2.4.2 Function Buttons







The Function buttons, as shown above, enables the user to enter the menu system of the transceiver and change various settings. Each button is described in detail below. Some of the function buttons have a 2nd function shown in italics at the upper right corner of the function button. To use this 2nd function of a function button, press the "2nd" button and then press the function button.





Key	Function
-----	----------





This key has two functions.

- 1) If system is 'ON', this key will either – by a single press - enter the top level of the menu system (see section 4.3 Menu System) or – by holding down for about 5 sec. - power down the system.
- 2) If system is 'OFF', this key will force

Key	Function
	the system to power up.
	<p>This use of this key is depending on the present MMI status.</p> <p>In the <u>Menu system</u> this key will exit the current submenu until main level is reached.</p> <p>When <u>asked YES or NO</u> by the system, this key will be interpreted as a 'NO' response.</p> <p>When <u>entering data</u> into the system, this key will cancel the entry.</p>
	<p>This use of this key is depending on the present MMI status.</p> <p>In the <u>Menu system</u> this key will enter the chosen submenu.</p> <p>When <u>asked YES or NO</u> by the system, this key will be interpreted as a 'YES' response.</p> <p>When <u>entering data</u> into the system, this key will accept the entry.</p>
	<p>This key has two functions.</p> <p>The primary function is to <u>clear</u> the last entered character. It is similar in function to the backspace key on a PC.</p> <p>The secondary function is to <u>insert</u> new characters. This is used when inserting new Inmarsat Mobile Numbers (IMN's), Phonebook entries, etc.</p>
	<p>This key has two functions.</p> <p>The primary function is to <u>scroll upwards</u> to menu items not shown on the 2-line display of the LCD.</p>











Key	Function
	The secondary function is to <u>edit</u> previously entered information.
	This key has two functions. The primary function is <u>toggle</u> between normal mode and alphanumeric mode. The secondary function is to <u>delete</u> previously entered information.
	This key is used to access secondary key functions.
	This key has two functions. The primary function is to <u>scroll downwards</u> to menu items not shown on the 2-line display of the LCD. The secondary function is presently not used.
	This key toggles between 'on hook' and 'off hook'.

2.4.3 Alpha-Numeric Section

The keypad can be in normal (numeric) mode or alpha mode. Normal mode is used to enter digits (phone numbers) whereas alpha mode is used to enter letters (names in the phone book). The  is used to toggle between the two modes. The display indicates if in alpha mode. In alpha mode each of the numeric keys (plus ) can be used to select between subsets of the alphabet (and certain special characters) by pressing the key a number of times until the wanted letter/character is shown on the display. To insert the letter C it is necessary to press  3 times in alpha mode. Below is an overview of the relevant keys in alpha mode.



Key Toggles between when pressed in alpha mode

	- ? ! , . : ' \$ () + / 1
	A B C 2
	D E F 3
	G H I 4
	J K L 5
	M N O 6
	P Q R S 7
	T U V 8
	W X Y Z 9
	0 or Move cursor (forced)

Key _____ Toggles between when pressed in alpha mode _____

 <space>

A number of keys have a 2nd function.

Key _____ Function _____

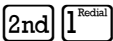
 Recalls the last dialed number.

 Not used

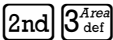

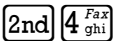
 Shortcut to the area selection submenu, see section 4.3.2 A.

 Used to establish a fax call from the handset if the fax does not have a keypad. See section 4.1.3 Fax Call.

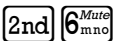
 Not used.

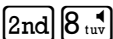

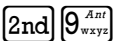



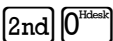

 Toggles the handset microphone 'ON' or 'OFF'.

 Toggles the cradle speaker 'ON' or 'OFF'.

 Shows C/No "signal strength" in the display. Pressing  or  returns to the previous state.

 Sets the brightness of the LED's. See section 4.4.15 below LED Dimm.

 Short cut to the Help desk menu. See section 4.3.5 below Help Desk.

Key	Function
 	Insert an entry (for example in phone book)
 	Edit an existing entry (for example in phone book)
 	Delete an existing entry (for example in phone book)
 	Not used.

3 Getting Started

3.1 Get Ready to Make a Call

3.1.1 How to Power-Up the System.

There are two ways to power up the system:

- Power Key on handset
- Power Button on back panel of Transceiver Unit

The handset power button is also the menu button. To power up you may simply press the button once.

The transceiver power button is placed on the back panel of the unit. See figure below.



Press and hold the power button for a few seconds until the green LED on the front of the terminal lights up.

3



The display and all LED's on the handset will light up for a few seconds.

Below is a view of the normal handset display readout, while the System is booting.

Initialising

▽
**AORE:
Wait for NCS**

▽IIIIII
**AORE:
Wait for NCS**



The system may stay in the "Wait for GPS" state for an extended period, if e.g. the antenna has been turned off for a long time or there is not a free view to the GPS satellites. The time to get the GPS position may be several minutes.

When the display reads "READY" as shown above, the system is ready to make and receive calls.

3.1.2 How to Shut Down the System.

Note: To make sure that writing to the configuration module is completed, please wait at least 10 seconds after any changes to the configuration, before shutting the system down.

To shut down the system from the handset, you press the  button for 3 sec. The display now shows that if you press the key for further 4 sec the terminal will power down. The display counts down to zero, but by releasing the button any time before it reaches zero, you may abort the power down procedure.

To shut down the system from the transceiver press and hold the power button for a few seconds, until the handset display shows the message shown below.



Release the button and the system will shut down.

Note: After a shut down please wait at least 5 seconds, before trying to power up the system again.

3

3.2 Use of PIN Codes.

Access to some terminal functionality is restricted by PIN codes. Two different kinds of User PIN codes are used in the system: one for the Super User and one for the Service User.

Both PIN codes are composed of digits between 0 and 9 and the length must be between 4 and 8 digits.

The normal everyday user (**Normal User**) can make and receive calls, access the phonebook, chose an ocean region and a default LES, read the alarm log and status and make calls from the Helpdesk. For a description of these functions refer to section 4.3 "Menu System". All other functionality has to be carried out by a Super User or a Service User.

Super User

The Super User has the same rights as the Normal User. In addition the Super User can access the Super User menu (see section 4.4 for details). A Super User will typically be a person responsible for setting up and maintaining the system. It is only possible to have one Super User PIN

code. If the code is entered incorrectly 3 times, the PIN becomes blocked. A blocked Super User PIN can only be unblocked by a PUK code or the Service User. The factory PIN code is '12345678'.

Service User PIN

The Service User has access to all functionality in the Fleet system, which is accessible through the handset. Only T&T and/or the supplier of the equipment will normally know this PIN. If the PIN is entered incorrectly 3 times, the PIN becomes blocked. Only a PUK code can unblock a blocked Service User PIN. Refer to the "TT-3088A SAILOR Fleet33 Installation Manual" for the use of the service menu.















3.3 Normal Calls

3.3.1 Calling From the TT-3088A

When making calls from a handset or from a fax keypad just type in the phone number as if you were making an international call (with prefix for automatic international calls equal to 00).

Example:

To dial the number of Thrane & Thrane (+45 39558800), press:

-   for international calls
-   for country code then
-         followed by
-  or .

The display on the terminal handset will show how the call proceeds.

You hang up by pressing . After hanging up, the display will show how long the call lasted.

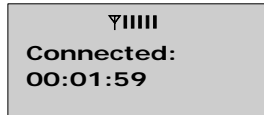

The Phone Book can also be used to initiate a call, either by selecting an entry in the phone book or by using the short code. See section 4.1.1 for details.

3

3.3.2 Calling To the TT-3088A

Calling the terminal or a device connected to the terminal is similar to making international calls. The specific IMN-number (a terminal may have more numbers as different services exist and more devices may be connected to the different hardware interfaces of the terminal) has to be preceded by one of the five possible international access codes. This depends on whether you know which area the terminal is within or not:

870: Area of terminal not known
(Requires that the LES supports Mobility Management).

871: AORE
872: POR
873: IOR
874: AORW

To call a terminal positioned in IOR, dial:

00873 followed by the IMN number.

3.4 Data Calls

Please note: The data connection services are only available when the vessel is positioned inside an area with Spot Beam coverage.

3.4.1 MPDS Connection

The Mobile Packet Data Service (MPDS) provides the mobile user with an economic and flexible data connection. The user is only charged by the transferred traffic (in MB). This means that for applications like Web browsing, email services, IP/LAN connectivity, small to medium size file transfer, the MPDS will be the most economic and convenient solution. The maximum data transfer rate is 64 kbit/s to the terminal and 28 kbps from the terminal.

A connection can be started automatically by an application like Internet Explorer or Outlook Express. The connection can also be established manually. In windows, open Dial-Up networking and double click the appropriate icon. Enter username and password if necessary. Click 'Connect'. Wait for the connection to be completed, indicated by a 'Dial-up Networking' icon in the task bar tray.

To disconnect: Right click the tray icon and choose 'Disconnect'.

See section 5.2.1 on how to setup the computer and transceiver for an MPDS connection.

While in MPDS mode the TT-3088A is flagged busy in the Inmarsat network. This means that the Fleet system is not able to receive any incoming calls until it returns to normal idle mode. However, the user can enable the Call Waiting Notification feature. This allows the system to receive voice

calls during an ongoing MPDS call. For further information about this feature, see section 3.4.2.

3.4.2 Call waiting

As indicated in the previous section the user can enable the Call Waiting Notification in order to receive incoming voice calls during an MPDS session. The enabling can optionally be restricted to specific phone numbers.

The 4-wire and 2-wires interfaces can be configured for usage for the Call Waiting Notification. When the notification arrives, the user is notified by a special ringing tone and a message is shown in the display if the 4-wire handset is selected for the service.

In case of an incoming call during an MPDS session with the Call Waiting Notification enabled, the user has three options:

1. The user can reject the pre-emption of the MPDS connection by pressing "*" or "Exit" on the 4-wire handset (if enabled) or by taking an enabled 2-wire phone off hook, pressing "*" and placing the phone on hook again. The ringing stops on all handsets that are configured for the service.
2. The user can accept the pre-emption of the MPDS connection by pressing "OK" or "#" on the 4-wire handset (if enabled) or by taking an enabled 2-wire phone off hook, pressing "#" and placing the phone on hook again. The MPDS session is now deregistered and the call gets through after a short while. The phone(s) to which the call is routed starts ringing and the call can be answered. Note that the call can be answered on another interface than the interface that was used to accept the call – e.g. a fax will normally only be

routed to a specific RJ11 connector and not the 4-wire handset.

3. The user may also choose to do nothing. After a certain time the notification stops and the pre-emption of the MPDS connection is implicitly rejected, if no other lines have accepted the notification.

Configuration of the Call Waiting notification is described in paragraph 4.4.24.

3.4.3 9600 Data Connection

3

9.6 kbps data is a circuit switched service, i.e. you have the 9.6 kbps speed all the time, and you pay for the time you are connected. This service will be the most economic solution for batch data transfers.

The connection can be established manually. In windows, open Dial-Up networking and double click the appropriate icon. Enter username and password if necessary. Click 'Connect'. Wait for the connection to be completed, indicated by a 'Dial-up Networking' icon in the task bar tray.













To disconnect: Right click the tray icon and choose 'Disconnect'.

See section 5.2.2 on how to setup the computer and transceiver for a 9.6 kbps data connection.

4 Operation

4.1 Call Functions













4.1.1 Calls Using the Phone Book

The phone book can be used to initiate calls, either by selecting an entry in the phone book, and then pressing  or , or by using the short code. The latter is done by pressing  followed by the short code. Pressing  afterwards will establish the call. Pressing  instead will show the actual number and the call can then be established by pressing  or . Short code 0 contains the last dialed number, thus   or   followed by  will redial the last number.

4.1.2 Call From Handset Connected to RJ11

Making a call from a (normal 2-wire PSTN) phone connected to one of the two analogue RJ11 interfaces is done in the same way as a call from the handset. Just keep in mind to press the  key in order to signal the terminal, that the number is complete.

To Call Thrane & Thrane in Denmark (country code 45) is done by pressing the following keys on the phone:

When using one of the RJ11 analogue interfaces please make sure that the selected interface is configured for a service, which supports voice. See section 4.4.21. Routing

The display on the handset will show how the call proceeds.

After hanging up (on the 2-wire phone), the display will show how long the call lasted.

4.1.3 Fax Calls

Fax calls can be made whether the fax has a keypad or not.

Calls from a fax *with* keypad are done as international calls followed by [#]. To call Thrane & Thrane in Denmark (country code 45) press the following keys on the fax:

[0] [0] [4] [5] [3] [9] [5] [5] [8] [8] [8] [8] [#]

Please make sure that the analogue RJ11 interface to which the fax is connected is configured for a service, which supports fax.

The display on the handset will show how the call proceeds.

After hanging up, the display will show how long the call lasted.

Calls from a fax *without* keypad are done by using the keypad on the terminal handset. To call Thrane & Thrane in Denmark (country code 45) press the following keys on the SAILOR Fleet handset:

[0] ^{Memo} [0] ^{Memo} [4] ^{Fax} [5] ^R [3] ^{Area} [9] ^{Area} [5] ^R [5] ^R [8] [↑] [8] [↑] [8] [↑] [8] [↑] [2nd] [4] ^{Fax}

Then press the start-button on the fax.

To hang up after faxing please refer to fax user manual.

4.1.4 Internal Calls

It is possible to make internal calls between the RJ11 (2 wire) interfaces. To initiate a call press the interface code from the table below and then .

Interface	Interface Code	Interface port
RJ11 #1	2	X1
RJ11 #2	3	X2

4.2 Using the Menu System

The level of access to the menus is divided into 3 groups of users. A Normal User, a Super User and a Service User.

The Normal User has access to normal everyday functions. The Super User has the same rights, but can additionally access different setup menus. The Service User menu is only accessible to the supplier or Thrane & Thrane. Both Super User and Service User menus are protected by PIN codes.



To access the menu system press: .

To scroll through menu use the keys  and .

To enter a submenu press: .

To exit to a previous level press: .

An entry in the menu system can also be reached by pressing  and a number corresponding to the entry

level, e.g. pressing   will access the 'Alarm Log' menu.

The complete menu tree can be found in Appendix A - Menu Tree.

4.3 Menu System – All Users

This section describes the functions in the menu system available to all users.

4.3.1 Phonebook

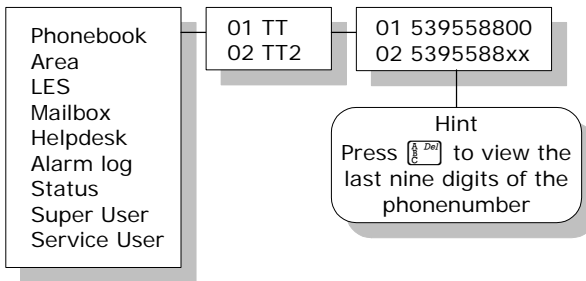

The terminal **PhoneBook** contains 99 entries. Each entry contains the following information:

- Name
- Telephone number
- Short code

The telephone number includes call prefix for automatic calls and international access code. The telephone number can hold up to 22 digits.

The name can hold from 0 to 16 characters.

The short code can be used for quick access when dialing. To use the short code, press <short code> and press again to dial.

The list of entries in the phone book is sorted according to short code.

An entry in the phone book is displayed as a short code and a name if in alpha mode or as a short code and a telephone number if in normal mode.

Use to select an entry and press . The phone number is displayed.

Press or to dial.

Inserting an entry in the phone book from within the phone book menu is done in the following way. In this example the number to T&T, 004539558800, with short code 14 is inserted.

THRANE

Editing or deleting an entry is done by selecting the entry in the phone book and pressing and respectively.



4.3.2 Area

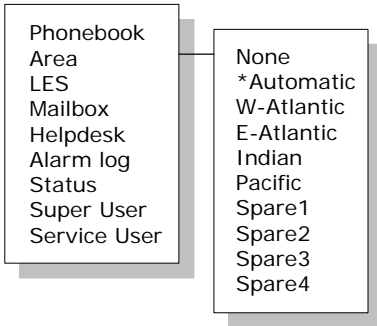

The **Area** menu is used to select satellite/ocean region. The possible options are:

- None (no satellite is selected)
- Automatic (automatic satellite selection)
- W-Atlantic (AOR-W satellite)
- E-Atlantic (AOR-E satellite)
- Indian (IOR satellite)
- Pacific (POR satellite)
- Spare 1 (for future use)
- Spare 2 (for future use)
- Spare 3 (for future use)
- Spare 4 (for future use)

If **Automatic** is selected the system will search through the options and select based on signal strength.

To change the selection: Choose an area and press . The selection will be marked with an *.

The coverage map can be found in the FleetCP configuration program (see section 5.1 System Set-up).

4.3.3 LES

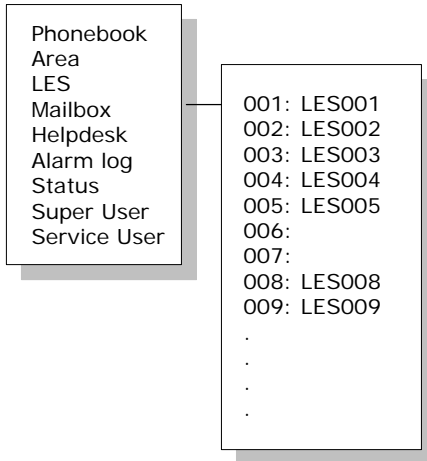

The **LES** list contains a list of those LES operators, which may be selected as gateway to the terrestrial network. The last used LES will be marked with * and this LES will also be the first LES tried next time the terminal is logged on. Use to select. The Area selected in section 4.3.2 A, will decide, which LES's will be available for selection (see section 4.4.23 LES Config for further information about LES configuration).

4.3.4 Mailbox

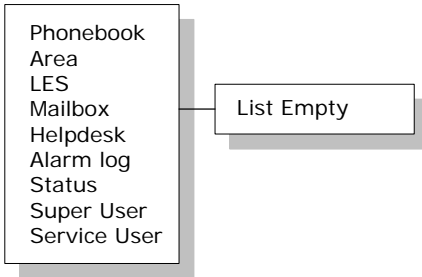

The **Mailbox** feature is not supported by all LES operators. The feature handles messages sent from the LES operator. If a call is made to a terminal, which is busy, switched off, etc. the LES operator may offer the facility to record a short message. When the terminal again becomes operational a message is sent indicating that the LES operator has recorded a short message for the terminal.

The  symbol in the handset display indicates the presence of such messages.

Each message can be seen in the **Mailbox** menu and contains the following information:

- LES Access Code
- Service type (voice, fax, data).

To View a entry, select the message and press . See how to delete a message in section 4.4.21 Mail Box.

4.3.5 Help Desk

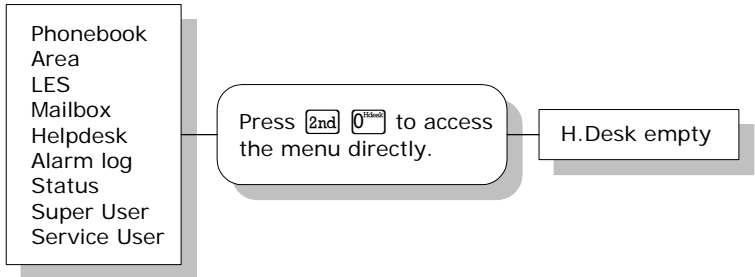



The **Help Desk** is a secondary phone book that can be used for storing up to 10 support phone numbers (e.g. Thrane & Thrane support centers).

Editing/inserting and deleting entries is done in exactly the same way as with the phone book, but it can only be done from the super user menu. Each entry contains a phone number, name of the entry, and a LES access code.

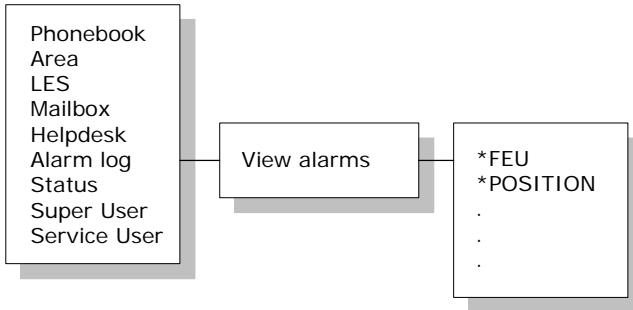
4.3.6 Alarm Log



The **Alarm Log**, logs all the alarms in the system (cf. 6.1 List of Error messages). From this menu, the alarm can be viewed only. To clear the alarm list see section 4.4.17. Scroll through the list, using the   keys. A * in front of the Alarm name, indicates that the alarm is still active. Select an alarm for viewing, by pressing . Each entry for an alarm contains an alarm description and the time and date when the alarm occurred. See section 6.1 for a list of alarms.

The alarm log can contain up to 20 entries. The log will wrap around when the log is full.

4.3.7 Status

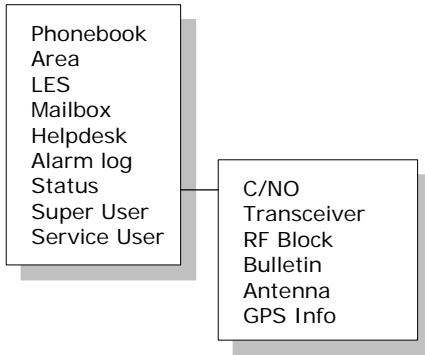

The **Status** menu has the following sub menus:

- C/No
- Transceiver
- RF Block
- Bulletin
- Antenna
- GPS Info

C/No:

Choosing C/No will display the signal strength in dBHz. Pressing **[Exit]** will return to the previous state.

Transceiver

Release date:	Software release date.
Unit Type:	Type of unit.
Serial No.:	T&T serial number.
ISN:	Inmarsat serial number.
PCB No.:	Serial number of main CPU board.
Forward ID:	Terminals Forward ID number.
SW Ver.:	Software version.

RF Block

RX Frequency:	Receiving frequency in MHz.
---------------	-----------------------------

TX Frequency:	Transmitting frequency in MHz
Freq. offset:	Frequency offset between 0-1500 Hz.
Acc. offset:	Acc offset between 0-1500 Hz.
AGC:	AGC between 0-1024.
Gain:	Gain between 0-256.
TX level:	TX level equals LOW or OK.
Lo1-Lo3:	Lox In or Out of lock.
Temperature:	Temperature in deg. C.
Power mode:	Power mode in sleep or normal.

Bulletin

Ocean Region:	AORW, AORE, POR or IOR.
NSR state:	Not initialized, initializing or initialized.
Type:	Mini-M or NG
Bulletin page 1-6:	Page 1 to 255 or Invalid.
Spot beam ID:	Spot beam ID number between 1-255.
SU CC Rxed:	Between 0000-9999.
SU CC Txed:	Between 0000-9999.

Antenna

The antenna information is divided into two parts: Front End Unit and Antenna Control Unit and is primarily intended for service use.

FEU:	Unit type:
	Serial no.:
	SW version:
	Mode:
	Power:
	Temperature:
	Cable loss:
	Reset count:
	Date:

If cable loss is 100%, it means that the cable loss compensation is at its maximum, and may therefore not be able to compensate fully for the cable loss. A cable with a lower RF loss should be used.

ACU: Unit type:
Serial no.:
State:
Input power:
Control ver.:
Loader ver.:
FPGA ver.:
SU ver.:
RX2 ver.:
Loader CRC:
Control CRC:
FPGA CRC:
Config CRC:

GPS Info

PositionInfo: Not ready or Latitude and Longitude.
Heading: Not ready, heading 0-360 degrees or
Heading N/A Low speed (If speed is
equal to or below 1 knot).
Speed: Not ready or speed in knots.
UTC Time: Not ready or YYYY:MM:DD HH:MM:SS
Internal GPS: Not ready or Active and ready.

4.4 Menu System - Super User

This section contains a description of the items in the Super User Menu. Please remember that the **ABC** button can be used to toggle short codes on and off.

4.4.1 Call Logs

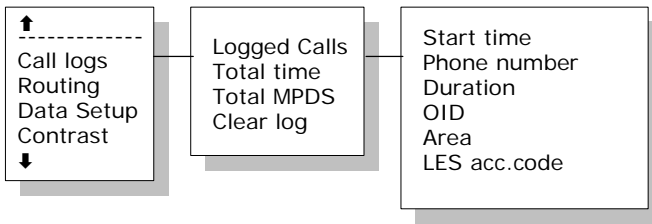

The **Call log** menu has the following sub-menus

- Logged calls
- Total Time
- Total MPDS
- Clear log

By entering the **Logged calls** menu it is possible to inspect information about each of the outgoing calls made on the terminal. The following information is logged for each call:

- Start time of call.
- Destination phone number.
- Duration of call
- Originating ID. (Description of service used).
- Ocean region used.
- LES access code.

- Terrestrial network identity (always 0).
- Call priority.
- Number of received bytes in MPDS.
- Number of transmitted bytes in MPDS.
- Total number of bytes in MPDS.

Total Time shows the total accumulated call time since last reset.

Total MPDS shows the total accumulated number of bytes, used in MPDS sessions.

To clear the Call Log select the **Clear Log** menu. Press **OK** to clear or **Exit** to abort.

The call log can contain up to 100 entries. After that it will do a wrap around and start overwriting the oldest entry.

A warning will be generated when the call log contains more than 70 entries. You may then back up your log data by Fleet CP PC software. If you also clear the log, you will get a warning again when 30 entries are left.



4.4.2 Routing

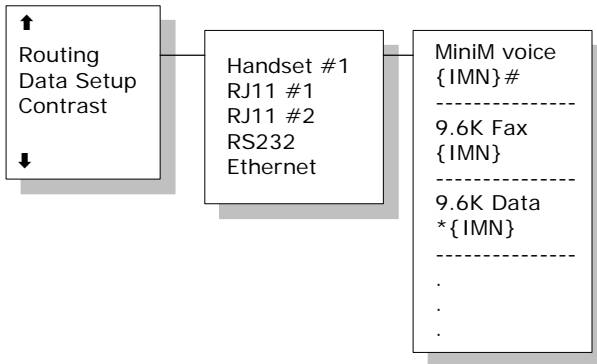

This menu has been divided into a submenu pr. interface plus a print menu:

- Handset #1
- RJ11 #1
- RJ11 #2
- RS-232 #1
- Ethernet

Note 1: The IMN-number has to be defined, before the service can be routed to an interface. The service will not be listed in the routing table, unless it has an IMN-number defined.

Note 2: Some users want the IMN number to reflect the corresponding telephone number. In this case the user should EDIT the default IMN number. The INSERT function is only for adding additional IMN numbers (or for creating the first IMN in case the list is empty).

When entering one of the above submenus it is possible to scroll through a list of all relevant IMN-numbers for the interface. In the handset menu, you will see all IMN's associated with voice: i.e. mini-M voice. If an IMN has an incoming route to an interface it is marked with "*". If it has an outgoing route to an interface, it is marked with a "#". It is possible to change the routing-status for each IMN to the opposite by pressing * for incoming and #^{Dim} for outgoing.

It is possible to route one IMN to more interfaces. E.g. an IMN can be routed to both RJ11 interfaces at the same time. This will make it possible, to have an incoming call being routed to two 2-wire phones simultaneous.

4.4.3 Data Setup

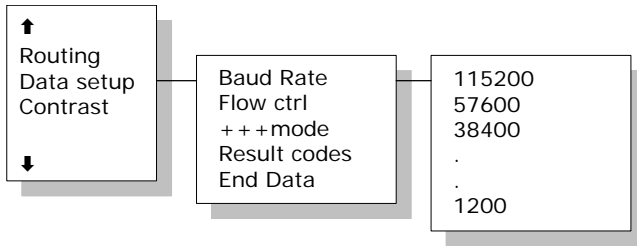

This menu is used to setup baud rate and dataflow control for the RS-232 interface. The following settings can be configured.

Baud Rate:	115200-1200
Flow Ctrl:	None Xon/Xoff Hardware
+++mode:	Disabled Enabled
Result codes:	Disabled Enabled



4.4.4 Contrast

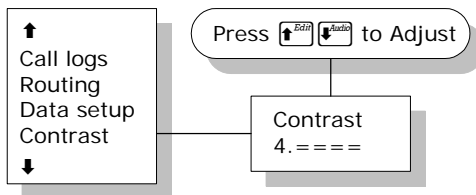

The display contrast of the handset can be adjusted. To change the contrast level, select the **Contrast** menu and adjust the value with and . Setting can be adjusted between 1 and 8. Default value is 4.

4.4.5 Ring Setup

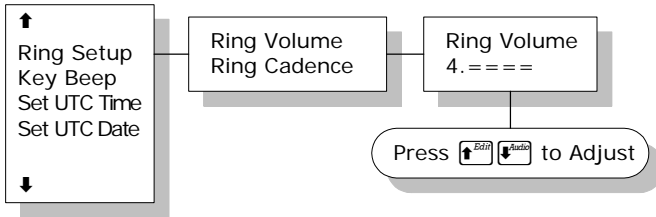

Ring setup gives the possibility to change the ringing tone and the handset volume. Adjustable values are:

Ring Volume: Off|1|2|3|4, default is 4.

Ring Cadence: 1|2|3|4|5|6|7|8, default is 1.

Both settings are adjusted with and .

4

4.4.6 Key Beep

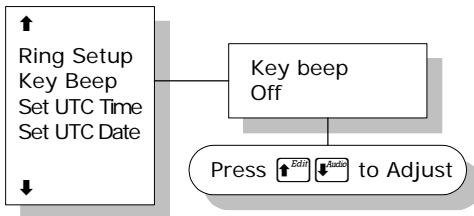

Key Beep, the sound that's heard when a key is pressed, can be set to Off, 1, 2, 3 or 4. The setting is adjusted with and . Key Beep is default off.

4.4.7 Set UTC Time

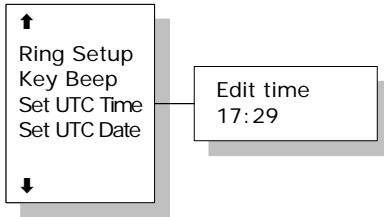

The current UTC time can be viewed and modified. The time is displayed in 24 hour format {hh:mm}. Enter a new time and press **OK** to update or **Exit** to cancel. If the clock is set to a non-UTC time a clock error message will appear after a while. By pressing *, the GPS time is automatically transferred.

4.4.8 Set UTC Date

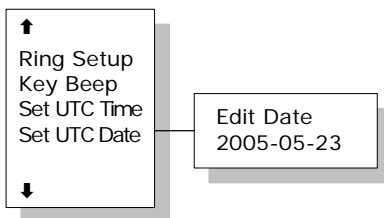

The current UTC date can be viewed and modified. The date is displayed in the format {yyyy:mm:dd}. Enter a new date and press **OK** to update or **Exit** to cancel. By pressing *, the GPS date is automatically transferred.

4.4.9 Disclose Pos.

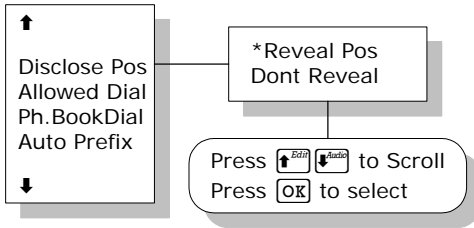

It is possible to disable the automatic reporting of position, from the GPS system. This menu gives the option to change this. Select 'Reveal Pos' or 'Don't reveal' with the and key. Select function with the key. Current status is marked with a *.

Note: Disabling automatic reporting of position, means that the terminal will report spot beam ID instead.

4

4.4.10 Allowed Dial

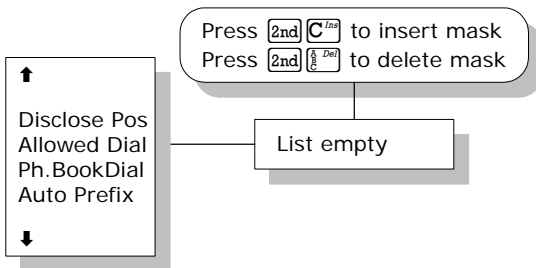

Allowed Dial is a function that allows the Super User to specify a phone number mask, to restrict outgoing calls.

A phone number matches a dial mask, if the number contains at least as many digits as the mask and when the

digits in the mask matches the corresponding digits in the phone number, starting from the first digit.

Press **[2nd][C^{Ins}]** to insert a mask and **[2nd][$\frac{1}{2}$ Del]** to delete an entry.

Examples:

Mask	00453955
Valid number	004539558800
Valid number	004539558888
Invalid number	39558800
Invalid number	004539

The terminal can contain up to 99 entries and each entry can be 22 digits long.



The phone number you enter in the dialer for making an MPDS connection, is a dummy number that is not used. Therefore the "Allowed Dial" list has no effect on MPDS connecting.

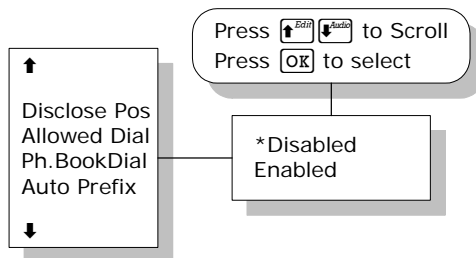

4.4.11 Ph.Book Dial





When this function is enabled, Normal User will only be able to make calls using the phone book or the Help desk from a SAILOR handset.

Use  and  to scroll between 'Enable' or 'Disable' and press  to select.

The function is by default disabled.

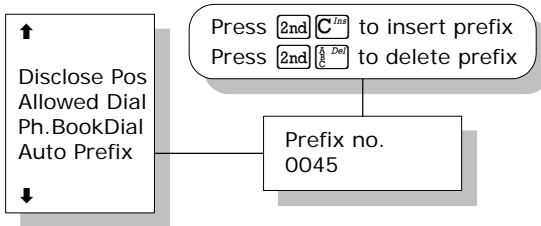
4.4.12 Auto Prefix



A prefix, e.g. 0045 for Denmark, can automatically be added to any dialed number. The prefix is not added to numbers dialed from the phonebook. One prefix number with up to 22 characters can be defined. By default no Auto Prefix number is specified. Press  to insert a prefix and  to delete the prefix.

4.4.13 BarServiceIn

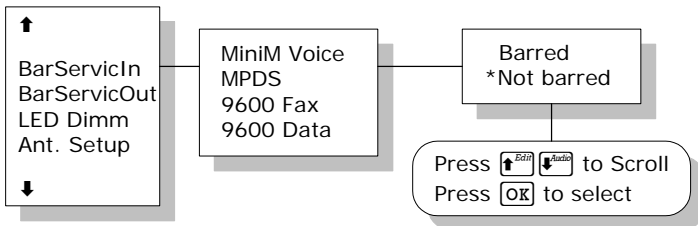

All incoming calls on a specific service can be barred. Scroll through the services with  . Select the service with

4

OK. The service can then be set to 'Barred' or 'Not barred' with **Edin** **Audio** and **OK**.

4.4.14 BarServiceOut

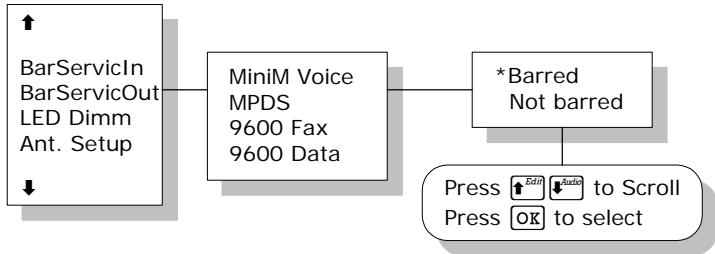

All outgoing calls on a specific service can be barred. Scroll through the services with **Edin** **Audio**. Select the service with **OK**. The service can then be set to 'Barred' or 'Not barred' with **Edin** **Audio** and **OK**.



4.4.15 LED Dimm

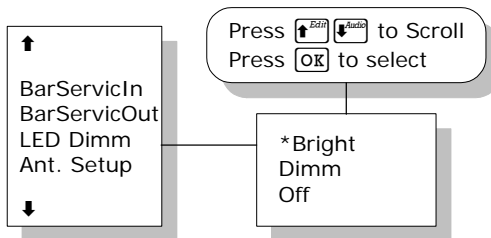

The brightness of the 4 Handset LED's can be adjusted. To change the brightness level, select the **LED Dimm** menu and adjust the value with **Edin** and **Audio**. Setting can be adjusted to Bright, Dimm and Off. Default value is Bright.

4.4.16 Ant.Setup

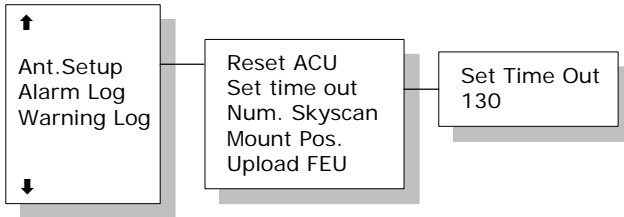

The **Ant.Setup** menu has the following sub menus:

Reset ACU: This function will reset the ACU in the antenna. The DC power running in the antenna cable will be turned of for a few seconds, causing the ACU to restart. This can be useful if the antenna control freezes or locks up.

Set time out: This function sets the number of seconds the system waits without a satellite signal before it assumes the tracking is lost. Valid range is 1 to 300 seconds. Default is 130 seconds. Press **OK** to validate changes.

Num. Skyscan: Enables the user to define the number of sky scans. Valid range is 1 to 10 scans. Default is 1 scan. Press **OK** to validate changes.

Mount Pos.: Because of the build in GPS, the antenna is capable of finding the satellite within a few seconds. A heading of the ship is also needed, but since the GPS does not supply the antenna with this information, a relative angle of the antenna compared to the ships bow, has to be known. Select the antennas mounted position, relative to the ships bow. Valid angles are 0, 90, 180, and 270 deg, positive in a clockwise direction. Default angle is 0 deg. Changes must confirmed by pressing **OK**.

Upload FEU: If a new FEU (Part of the antenna) is installed, this command will upload software to the FEU, thereby pairing the system software with FEU. If the FEU software version in the antenna is different from the version that is stored in the system, you will get a warning. You may then use the "Upload FEU" command to remove this difference.

4.4.17 Alarm log

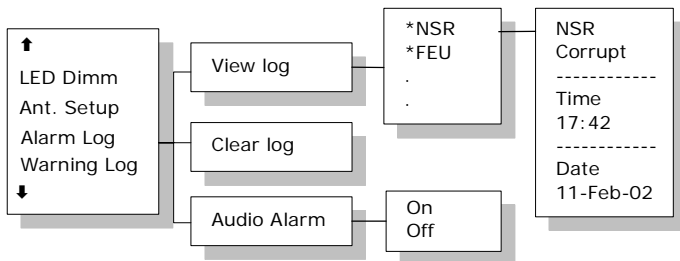

The **Alarm Log**, logs all the alarms in the system. From this menu, the alarm can be viewed and cleared. To clear the alarm list, select the submenu "Clear alarms" and confirm the message "Delete all?" by pressing **OK**. Scroll through the alarm list, using the **Enter** **Audio** keys. A * in front of the Alarm name, indicates that the alarm is still active. Select an alarm for viewing, by pressing **OK**. Each entry for an alarm contains an alarm description and the time and date when the alarm occurred. See section 6.1 for a list of alarms.

The alarm log can contain up to 20 entries. The log will wrap around when the log is full.

You may get an audio alarm when an alarm is added to the alarm log. This may be turned on and off by entering the Audio Alarm menu.

4.4.18 Warning Log

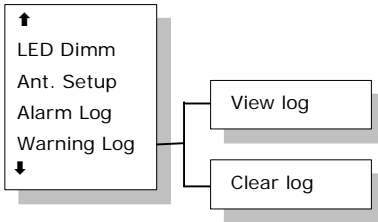
**4**

The Warning Log logs the warnings in the system. Warnings are not as serious as alarms. From this menu, the warnings can be viewed and cleared. To clear the warning list, select the submenu "Clear log" and confirm the message "Delete all?" by pressing **OK**. Scroll through the warning log, using the **Up** Edin and **Down** Audio keys. A * in front of the warning name, indicates that the warning is still active. Select a warning for viewing, by pressing **OK**. Each entry for a warning contains a warning description and the time and date when the warning occurred.

4.4.19 Help Desk

Help Desk. Please refer to section 4.3.5.

4.4.20 PIN codes

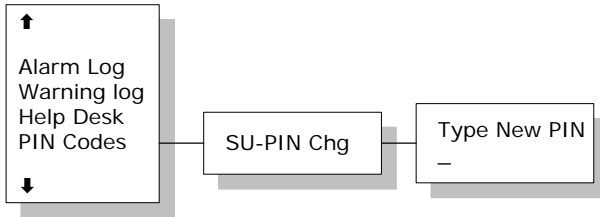

The **PIN codes** menu is where the Super User PIN is changed. For a description of the pin codes, see section 3.2 Use of PIN Codes. The **PIN codes** menu has the following sub menu.

SU-PIN Chg: The Super User PIN is changed here. Type the new PIN and press **OK** to accept the change.



4.4.21 Mail Box

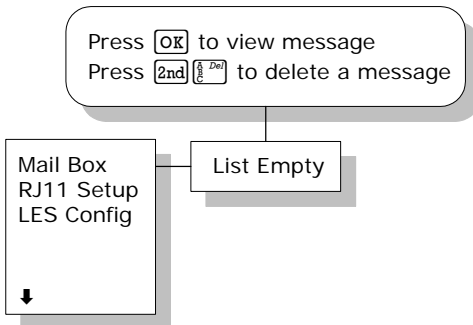

The **Mailbox** feature handles messages being sent from the LES operator. If a call is made to a terminal, which is busy, switched off, etc. the LES operator may offer the facility to record a short message. When the terminal again becomes operational a message is sent indicating that the

LES operator has recorded a short message for the terminal.



The  symbol in the handset display indicates the presence of such messages.

Each message can be seen in the **Mailbox** menu and contains the following information:

- LES Access Code
- Service type (voice, fax, data).

The following operations are possible:

- View entries
- Delete entries.



To View an entry, select the message and press . To delete an entry, select the message and press  .

4

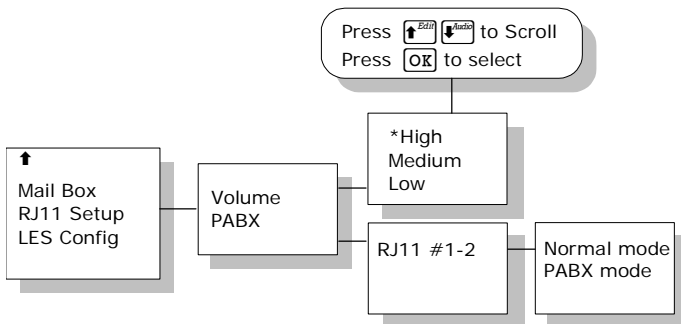
4.4.22 RJ11 Setup



2-wire phones, connected to the RJ11 interfaces, may vary in sensitivity. The output volume from the interfaces can therefore be adjusted. The volume can be set to **High**,

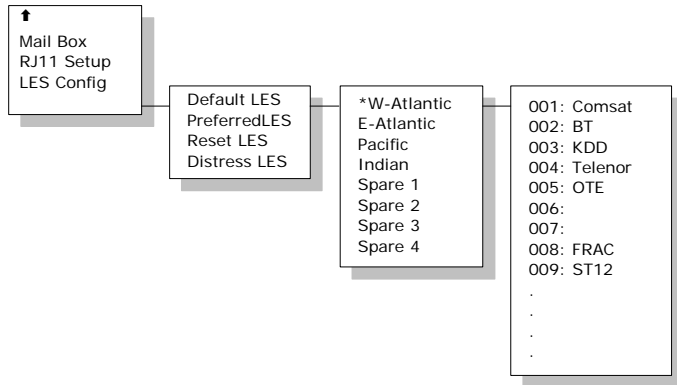

Medium or **Low**. The setting is adjusted with  *Edit* and  *Audio* and selected with . The default value is **High**.

4.4.23 LES Config



This menu is used to select a list of LES operators. It contains the following sub menus:

- Default LES
- PreferredLES
- Reset LES

The **Default LES** list contains a list of those LES operators, which may be selected as gateway to the terrestrial network. The last used LES will be marked with * and this LES will also be the first LES tried next time the terminal is logged on. If there's no LES list selected under Allowed or Preferred LES, the Default LES list will contain the LES list from the satellite bulletin board, meaning all available LES in the selected Ocean region. Use  *Edit*  *Audio* and  to select a Ocean region and then a LES.

You may also edit the LES names in the "Default LES" list. Press **[2nd] [↑ Edit]** to start editing the selected name. You may clear the name by pressing **[2nd] [⌫ Del]**.

An **Allowed LES** list can be selected under the Service User menu. If an Allowed LES list exists, only the LES's in this list can be selected under Default and Preferred LES. An Allowed LES list contains all available LES operators in the selected ocean region. Those operators marked with * can be used as Default LES operators and thus appears in the Default LES list above. If all LES operators are allowed and can be used there are no markings.





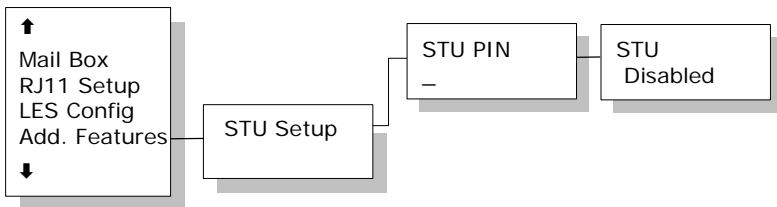

As there are many operators, you can use **PreferredLES** to make selections easier. The Preferred LES list can be used to indicate in which order LES operators should appear on the Default LES list. This is done by pressing **[2nd] [C Ins]** for each LES intended to be on the list and in the order they should appear in the Default LES list. Press **[OK]** to update the preferred LES list. To remove a LES from the list, press **[2nd] [⌫ Del]** and then **[OK]** to update the list.

The **Reset LES** command reset all the LES names to default names.

4

4.4.24 Additional Features







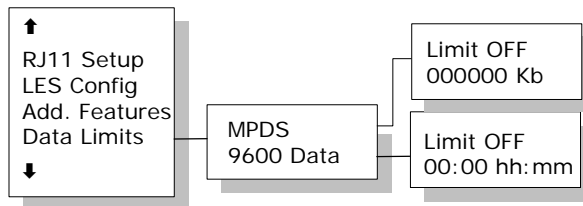







The Additional Features contains one sub menu: **STU Setup** (Secure Telephone Unit). To enable the STU service a PIN code must be entered. The PIN code can be retrieved from your distributor. If the PIN code is successfully entered a new screen appears. Here the service can be enabled or disabled. Use     to toggle and  to change. Press  to leave the sub menu.

4.4.25 Data Limits



The Data Limits menu enables the user to enter an upper limit for the use of each high speed connection. This feature is an effective way of preventing that a user by mistake forgets to close a connection.

The Data Limits menu contains two sub menus **MPDS** and **ISDN**. Use     to and  to choose among them.

The **MPDS** sub menu contains two parameters **Limit** and a value for the maximum allowed amount of kilobytes that can be transferred in each call. **Limit** can be either **ON** or **OFF**. If set to **ON** the MPDS connection will automatically be closed down if the transferred data amount gets beyond the entered maximum value. If set to **OFF**, there will be no limits for the amount of data that can be transferred. Use     to select **Limit** and  to manipulate. To enter a maximum limit press . Then use the numeric buttons to enter a value and press  to save. Press  to leave the sub menu.

The **ISDN** sub menu contains two parameters **Limit** and a maximum duration for each call. **Limit** can be either **ON** or **OFF**. If set to **ON** the call will automatically be closed down if the call has lasted longer than the entered maximum duration. If set to **OFF**, there will be no boundaries on the call duration. Use to select **Limit** and to manipulate. To enter a maximum call duration press . Then use the numeric buttons to enter the duration in hours and minutes and press to save. Press to leave the sub menu.

4.4.26 Call Waiting Notification

4

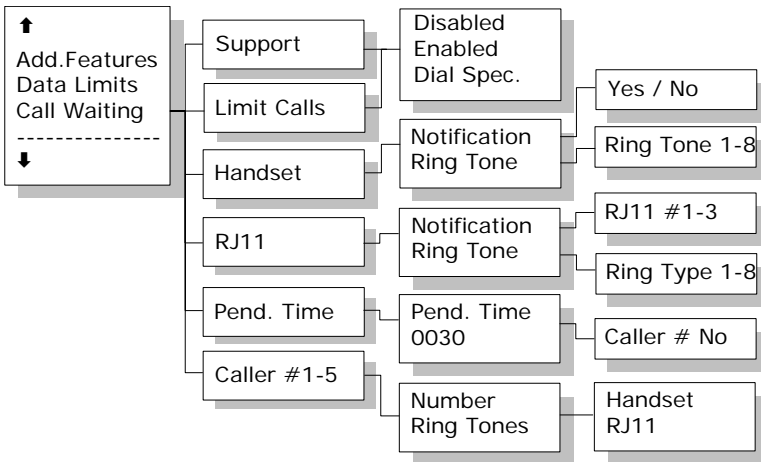

The Call Waiting menu contains a number of sub menus. Use to and to choose among them. Press to save the changes and press leave a menu. Please refer to section 3.4.2 for general information about the Call Waiting Notification.

The first menu item is **Support** and it is used for enabling or disabling the Call Waiting Notification service. A third option "**Dial Spec.**" makes it possible to control the **Support** setting using the AT shell command¹. Choose the settings by pressing and press leave the menu.

The second menu item is **Limit Calls**. The user may not want all calls to interrupt the MPDS sessions. It is possible to enter up to five phone numbers that are allowed to interrupt the MPDS sessions while all others will be rejected. If **Limit Calls** is set to "**Enabled**" only the five phone numbers are allowed to interrupt. If **Limit Calls** is set to "**Disabled**" all calls are allowed to interrupt. The third option "**Dial Spec.**" makes it possible to control the **Limit Calls** setting using the AT command². Please note that the **Limit Calls** service is not supported by the LES at present time. However, it will most likely be available in near future. Choose the settings by pressing and press leave the menu.

The third menu item is **Handset** and it contains two sub items: **Notification** and **Ring Tone**. **Notification** can be either **Yes** or **No** and it controls whether or not the 4-Wire Handset should be used for Call Waiting Notification. **Ring Tone** can be used for choosing among the 8 Ring Tones.

¹ If "**Dial Spec.**" is chosen, support of Call Waiting Notification can be controlled using the AT shell command "+WCWNS=<value>" during the MPDS call setup. Possible values for the AT shell command are: 0 = **DISABLED**, 1 = **ENABLED**, 2 = **AUTOMATIC**.

² If "**Dial Spec.**" is chosen the **Limit Calls** setting can be controlled using the AT command² "+WCWNR=<value>" during the MPDS call setup. Possible values are: 0 = **DISABLED**, 1 = **ENABLED**.

Choose the settings by pressing **[OK]** and press **[Exit]** leave the menu.

The fourth menu item is **RJ11** and it contains two sub items: **Notification** and **Ring Tone**. **Notification** can be either **Yes** or **No** for each of the three RJ11 2-wire connectors. The item **Ring Tone** can be used for choosing a common 2-wire ring tone among eight ring tones. The ring tones are described with the two symbols '#' (sound) and ' ' (no sound). Choose the settings by pressing **[OK]** and press **[Exit]** leave the menu.

The fifth menu item is **Pending Time** and this value is by default set to 30 seconds. The Call Waiting Notification will continue for a number of seconds corresponding to the value of **Pending Time**. If the user chooses to ignore the notification for a longer period the incoming call will be ignored. Enter a value and press **[OK]** to save when leaving the menu. Press **[Exit]** to leave the menu without saving.

The last menu items are **Caller #1-5** and each of these can contain a phone number that is allowed to interrupt the MPDS sessions if this is enabled in the menu item **Limit Calls**. Each number can be individually associated with a ring tone and with the 4-Wire handset and/or a number of the RJ11 2-Wire connectors. Configuration is done as described in the menu items **Handset** and **RJ11**.

5 PC Programs

5.1 System Set-up using FleetCP

System set-up can be managed from a PC program called **FleetCP**, instead of from the handset. **FleetCP** can be installed from the enclosed CD-ROM. The following pages contain a short introduction to **FleetCP**. The picture below shows the initial screen, when the program is started.

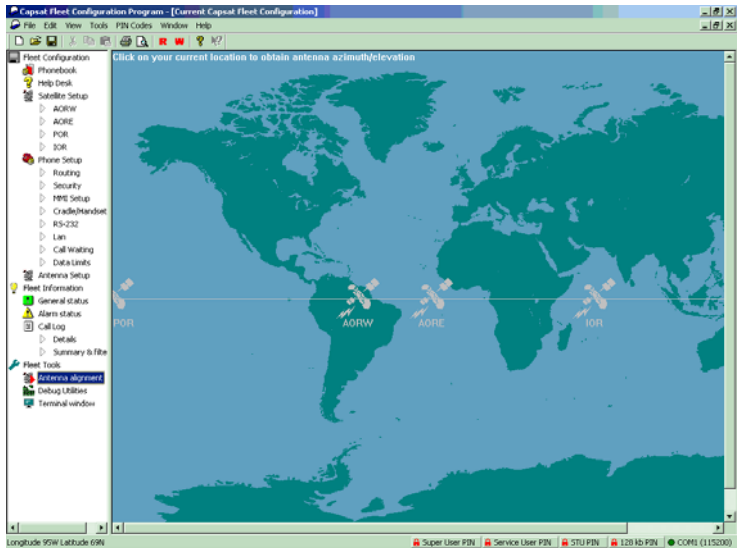

Connect the transceiver to PC using a standard RS-232.

When connected, clicking the red R button on the top toolbar will read the current configuration from the terminal. Clicking the red W button, will write any changes to the terminal.

The functions can be selected by clicking in the left menu window. The menu window is divided into the following groups: Phonebook, Help Desk, Phone Setup, Antenna Setup, General Status, Alarm Status, Call Log, Antenna Alignment, Debug Utilities and Terminal Window.

5.1.1 The Map

Clicking the map will show the Azimuth and Elevation to the satellites reachable in that area. See picture below.

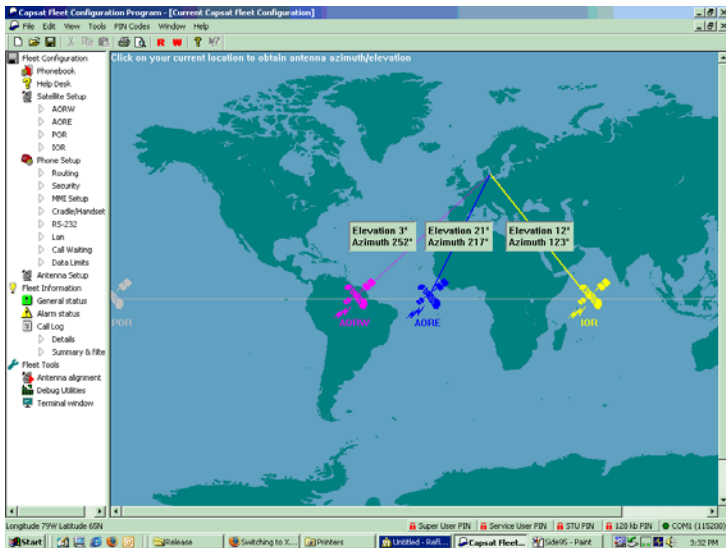

5

The status bar in the lower part of the window, will show longitude and latitude as the cursor is moved around the screen.

5.1.2 Pin Codes

The status of the PIN codes can be seen on the right side of the status bar. If no PIN codes are entered, all locks will be red and locked. Click the appropriate button to enter or change a PIN code. See picture below. If a PIN is entered, the lock will become unlocked and turn green. At the same time a new logout button will appear next to the PIN code buttons. Clicking this button resets the status of the all PIN codes.

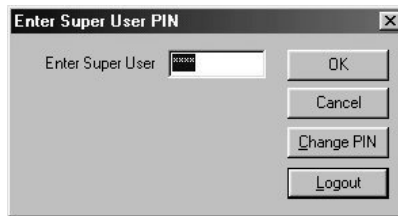

If a change to the configuration is made without entering a PIN code first, a prompt will appear when the write button is pressed, asking for the PIN. See below.



To read more about PIN codes see section 3.2 Use of PIN Codes.

5.1.3 Phonebook

Phonebook entries is made by selecting Phonebook and right clicking in the phonebook area. Entries here can be modified or deleted in the same way. See picture below. Further information can be found 4.3.1 Phonebook.

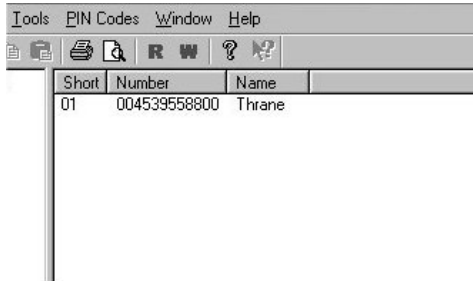

5

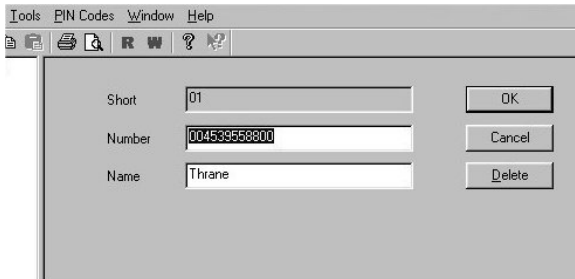

Inserting, editing and deleting entries in the Helpdesk works in a similar way. See the Installation Manual for further information.

5.1.4 Satellite Setup

Satellite Setup offers an easy way of setting up Allowed, Preferred and default LES. LES operators are dragged and dropped between the three tables. Setup is made for each ocean region. See picture below.

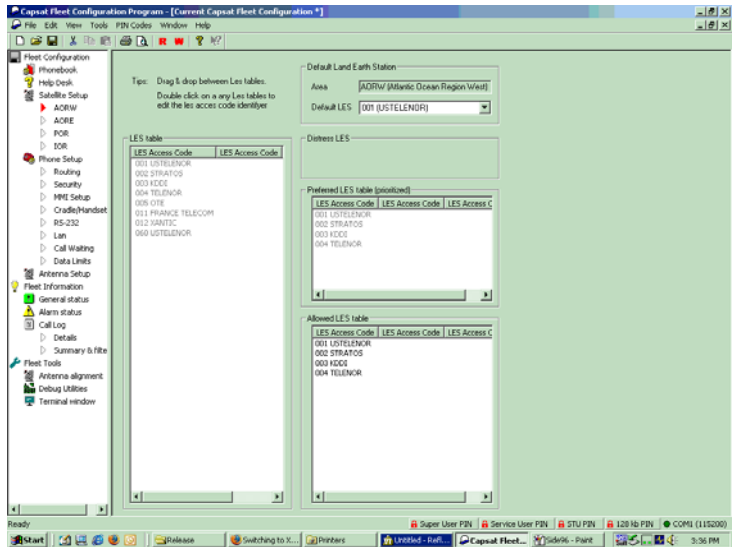

Read more about LES configuration in section 4.4.23 LES Config.

5.1.5 Routing

To route calls, use the table in the Routing window. Click in the cell that correspond to service/interface that is to be changed. Click the * or # button in lower part of the screen to define it as a incoming or outgoing call. To add a IMN, click the New IMN/ID button. See picture.

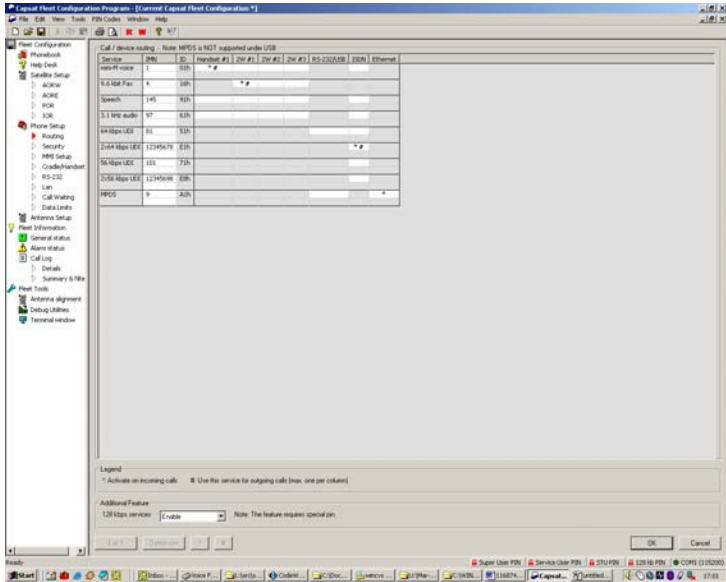

5

See section 4.4.2 Routing and IMN Config in the Installation manual for a detailed explanation about routing, IMN and ID's.

5.1.6 Setting up Time and Date

To correct the time/date or in the future, the language, use the MMI setup window. Click the Use PC time button to import the time and date from the PC clock. If the clock is set to a non-UTC time a clock error message will appear on the 4-W handset on the transceiver after a while.



5.1.7 Barring Services

In the security window call restrictions can be enabled or disabled and an Auto prefix inserted.

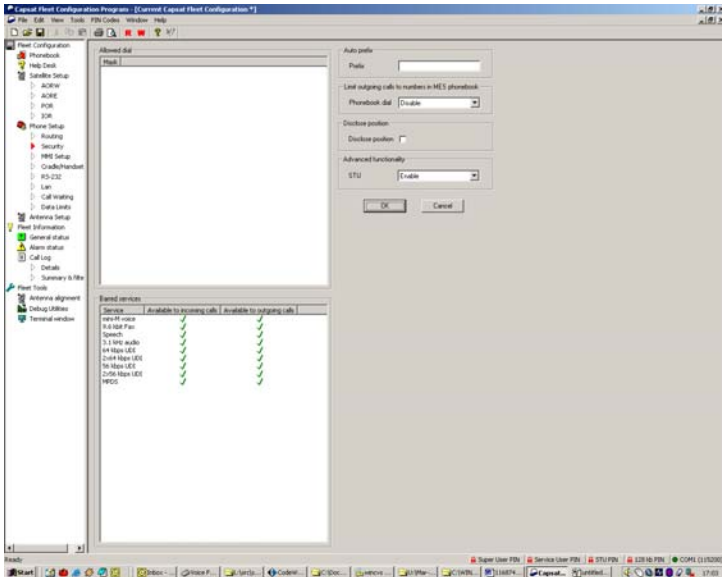

5

See section 4.4.10 Allowed Dial, 4.4.13 BarServiceIn and 4.4.14 BarServiceOut for more details.

5.1.8 Settings

In the Cradle/Handset window it is possible to setup ring type, ring volume, LED brightness and display contrast.

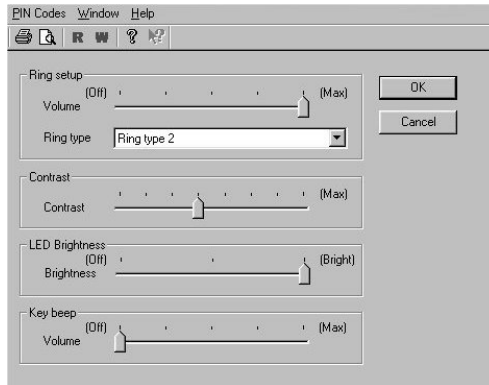

RS-232 parameters of the terminal can be changed in the RS-232 window.

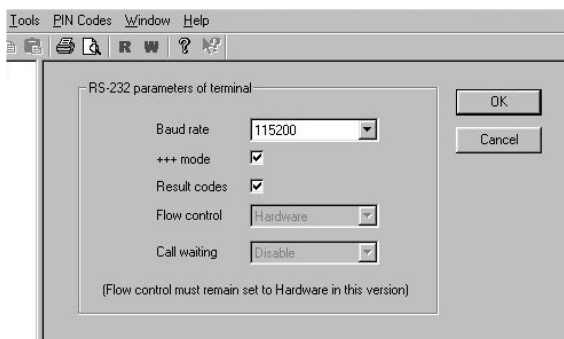

5.1.9 Antenna

The antenna setup gives a possibility to change Long term failure timeout, number of allowed sky scans and the antennas mount position relative to the ships bow. See section 4.4.16 Ant.Setup for details. The antenna can be rebooted by clicking the Reset ACU button.

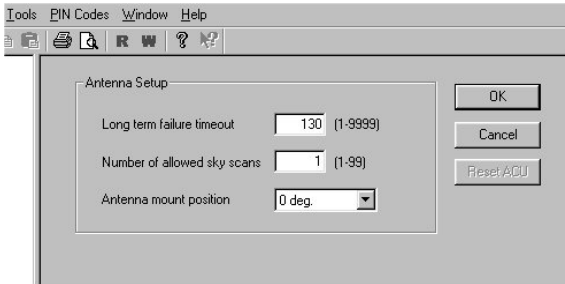

The terminal window makes it possible to run AT commands in the same way as the Windows program HyperTerminal.

5

5.2 Set-up Using RS-232

The illustrations below shows a typical hardware setup for a MPDS or 9.6 kps data connection using the RS-232 interface.



MPDS or 9.6 kps data Hardware Connection.

For a MPDS or 9.6 kps data session, connect a RS-232 cable between the COM port of the computer and the RS-232 interface on the Fleet system.

5.2.1 Set-up for MPDS

The terminal is connected to a PC or similar equipment via a standard RS-232 cable. In this manual, the setup of a PC running a MS-Windows operating system is described.

Configuring the TT-3088A

The transceiver has to be configured for the right ocean region and LES operator that provides the MPDS service. This is done using the handset user interface.

The transceivers RS-232 configuration shall be (using the handset user interface):

- Baud Rate: 115200 baud
- Flow control: Hardware

Setting up your PC

In this section the setting up of a MS-Windows based PC is described in general terms covering Windows 95, 98, 2000 and NT. The screen dumps below is from Windows 98. For a detailed description with more screen dumps of the installations, you are referred to the Application Note "Configuring SAILOR Fleet77 for MPDS" on your MES Software distribution disk or at our web site www.thrane.com.

Step 1: Install a standard modem

- From the Control Panel select Modems and add a Standard modem. Do not let Windows detect the modem, but manually choose a standard 28800 bps Modem.
- Select the appropriate COM port (i.e. the COM port that is connected to the terminal).
- Set maximum speed to 115200
- Set Data bits = 8, Parity = None and Stop bits = 1

5

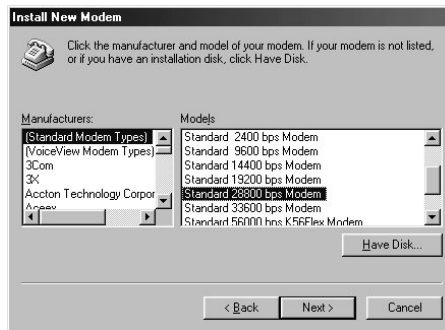

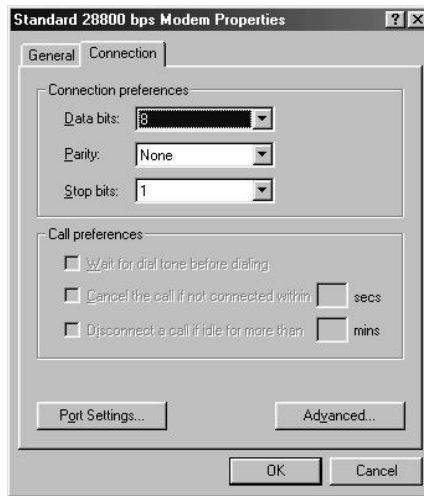
**Important:**

- Enter Advanced settings and type the initialization command `AT+WS45=4` in the Extra settings field. This string is transferred to the terminal when setting up a connection. If the MPDS connection is to use another LES than the one already selected, you use the initialization command = `AT+WS45=4; +WLES=XXX`, where XXX is the LES number.
- If the terminal is to stay in MPDS mode with no activity, for longer periods of time, then the automatic “disconnect when idle” setting in Windows must be disabled. Refer to your Windows manual on how to do this.

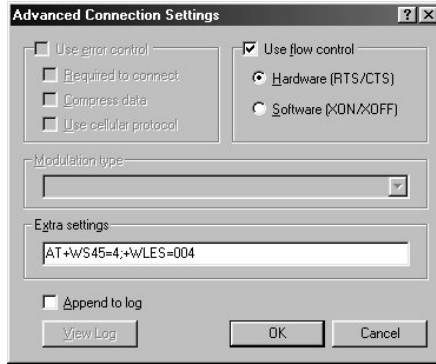

Step 2: Create a Dial-up connection

Open Dial-up Networking from My computer. Click "Make new connection"

- Select the standard modem defined during step 1 as the dial up device
- Enter a dummy telephone number (the number is not used but has to be defined – write e.g. "123" as the phone number)
- Give the connection a recognizable name e.g. MPDS connection

5

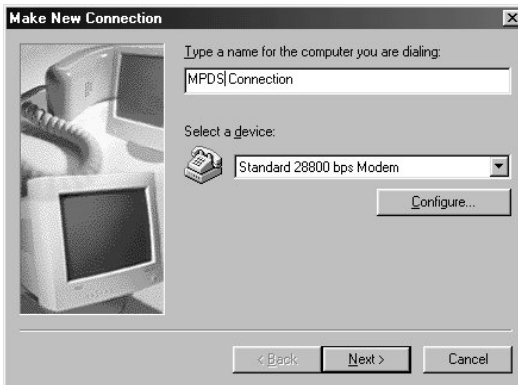

Include TCP/IP as allowed network protocol and use default TCP/IP settings (Server assigned IP address, Server assigned name server addresses etc.)

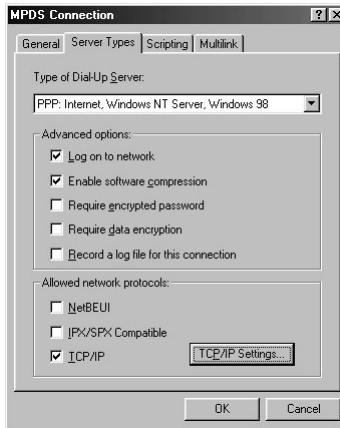

5.2.2 Set-up for 9600 Data

The correct routing has to be configured via the handset. See section 4.4.2 on how to route the data interface.

In the example below, is shown how to setup an Internet connection via 9.6K data interface.

Step 1: Install a modem

- From the Control Panel select Modems and add a modem.
- Let Windows detect the modem automatically.

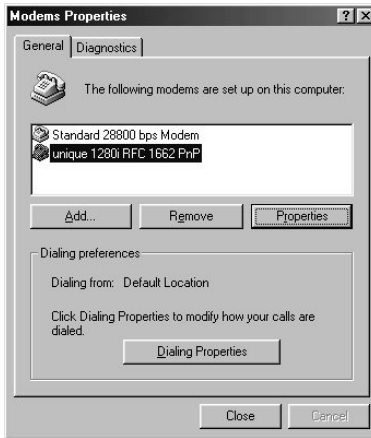
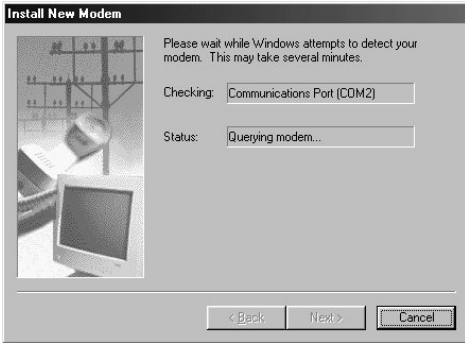

5

Step 2: Create a Dial-up connection

Open Dial-up Networking from My computer. Click "Make new connection"

- Select the Lasat modem defined during step 1 as the dial up device
- Enter the telephone number to the Internet Service Provider. Remember country code and area code if necessary.

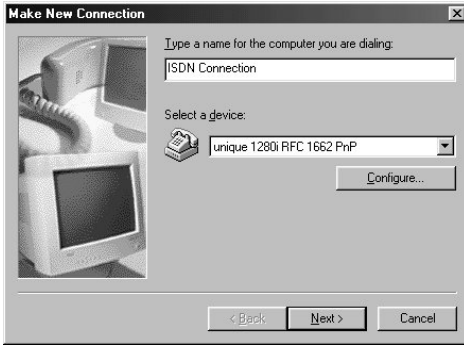

- Give the connection a recognizable name e.g. ISDN connection

Include TCP/IP as allowed network protocol and use TCP/IP settings (Server assigned IP address, Server assigned name server addresses etc.) as recommended by the ISP.

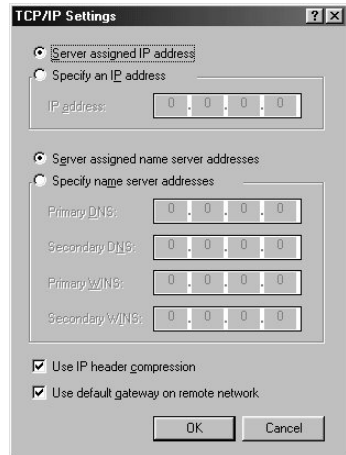
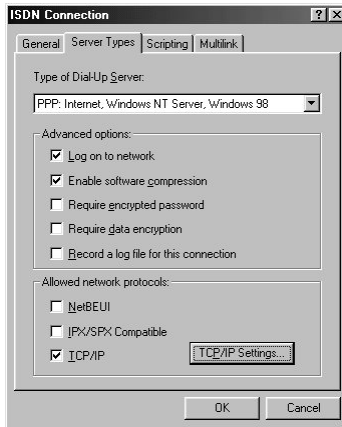

After this the connection can be made as described in section 3.4.1 MPDS Connection.

Please note: The data connection services are only available when the vessel is positioned inside an area with Spot Beam coverage.

5.3 Set-up using Ethernet/PPPoE

This chapter describes the set-up and operation of data connections via Ethernet and PPPoE using various PPPoE clients.

5.3.1 Windows XP with Built-in PPPoE Client

Prerequisites

The PC must have an Ethernet adapter and Windows XP installed and both must be operational. There must be a network connection between the PC and the Fleet system. As an example the the transceiver can be connected to the computer through a switch or hub or directly using a crossover cable.

Setting up the Connection

1. From the "Start" menu select "Settings" then "Network Connections" and then "Create New Connection". This brings up the "New Connection Wizard".
2. Click "Next".
3. Select "Connect to the Internet" and click "Next".
4. Select "Setup my connection manually" and click "Next".

5. Select "Connect using broadband connection requiring user name and password" and click "Next".
6. Type a name for the connection, e.g. "MPDS via PPPoE" and click "Next".
7. Select "Anyone" and click "Next".
8. Type a random user name and password and click "Next".
9. Select the shortcut on desktop option.
10. Click "Finish".
11. Now click the new shortcut on the desktop named "MPDS via PPPoE". The SAILOR F33 system should now make the connection.

Note:

Because of the relatively long set-up time for a data connection, the PPPoE connection may some times time out.

5.3.2 Windows 2000 WinPoET PPPoE Client

The data connection via Ethernet and PPPoE can be established using various PPPoE clients.

The PPPoE client WinPoet can be obtained through your local Thrane & Thrane distributor and works for both Macintosh and PC.

Prerequisites

The computer must have a working Ethernet adapter. Connect the transceiver to the computer through a switch or hub or connect directly using a crossover cable.

Installation

The WinPoET program will most likely be installed from a CD.

1. Double click the 'Setup.exe' icon, and the installation begins.

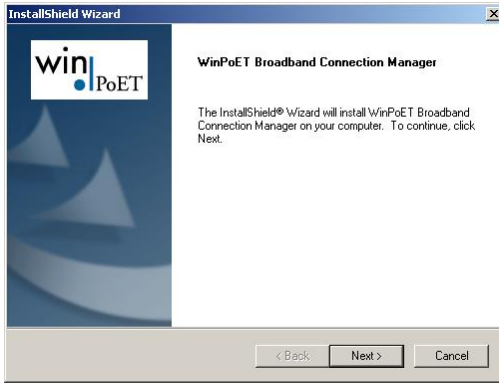

5

2. Click 'Next' and 'Yes' to accept the accept license agreement.



3. Choose the installation directory and click 'Next' to install. The program will now be installed.



4. When done click 'Finish' to restart the computer
5. Find the shortcut on the desktop called 'WinPoET Broadband Connection Manager' and double click.

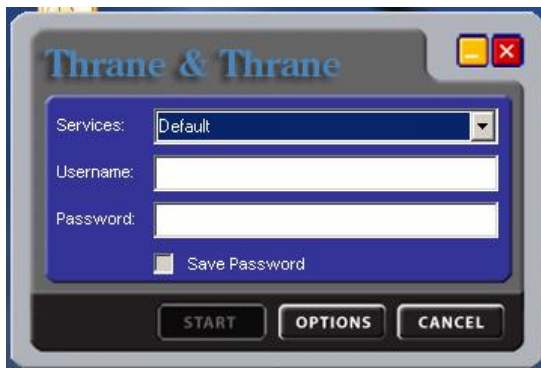

6. Enter random user name and password and then click 'START'.

The status field tells you how far you have reached in the connection process.

After a successful authentication the status of the terminal will be 'Connected'. The user is now capable of using the Internet like with any traditional connection.

6 Troubleshooting

6.1 List of Error messages

6.1.1 Satellite Network Messages

Within the satellite network a number of messages are defined to indicate the network status. This section describes the possible messages (Cause Codes) that might be displayed in the TT-3620G Handset.

Cause Code	Description	Event
1001	Normal (not shown in the handset)	MES is clearing the call as instructed by the relevant MES terminal equipment.
1011	Called party is busy.	MES is rejecting the call because the specified MES terminal number is currently busy, and MES has not been authorized to divert calls which are addressed to that number
1012	Called party is busy	MES is clearing the fixed-originated call because subsequent to the acceptance of the call and the signaling of the identity of the mobile terminal to which the call will actually be routed, that terminal has become busy and hence cannot be rung
1021	No User	MES is clearing the call because

Cause Code	Description	Event
	responded	appropriate "off-hook" signaling has not been received from the addressed MES terminal (including any authorized diversions) within the allowed time limit
1081	Identified channel does not exist	MES is rejecting the call because the specified MES terminal number has not been installed, and MES has not been authorized to divert calls which are addressed to that number
1091	Destination out of order	MES is rejecting the call because the specified MES terminal number is currently out-of-service, and MES has not been authorized to divert calls which are addressed to that number
1092	Destination out of order	MES is clearing the fixed-originated call because subsequent to the acceptance of the call and the signaling of the identity of the mobile terminal to which the call will actually be routed, that terminal has become out-of-service and hence cannot be rung
1141		Call cleared, MES initiated pre-emption
1142		Call cleared, MES initiated pre-emption
1143	Preemption	MES is prematurely clearing the fixed-originated call which is in the process of being established because the MES user has initiated a call from a terminal which is authorized to automatically preempt an existing fixed-originated call

6

Cause Code	Description	Event
1144	Reserved	
1145	Preemption	MES is prematurely clearing the mobile-originated call which is in the process of being established because the MES user has initiated a call from a terminal which is authorized to automatically pre-empt an existing mobile-originated call
1146	Normal.	MES is prematurely clearing the mobile-originated call which is in the process of being established because the MES user has abandoned the call (by placing the originating terminal "on-hook")
11A0		LES is clearing the call because the credit card being used is not valid (at this LES) for calls to the country indicated in the "service address" information received from the MES
11D1	Inconsistency in designated outgoing access information and subscriber class.	LES is rejecting the call because the "Service Nature" and/or "Service Type" and/or "Channel parameter" information received from the MES is invalid (e.g., not currently defined in the SDM, mutually contradictory, or not applicable to a MES-originated call)
11D2	Invalid number format (address incomplete)	LES is clearing the call because the "service address" information received from the MES is invalid (i.e., less than 2 digits)

Cause Code	Description	Event
11D3	Protocol error, unspecified	LES is clearing the call because the "service address" information received from the MES is a 2-digit address which is either undefined or which is currently unavailable at this LES
11D4	Protocol error. Unspecified	LES is clearing the call because "credit card data" information received from the MES is invalid. [This does not imply that the credit card itself is invalid]
11D5	Protocol error, unspecified	LES is clearing the call because the "service address" information received from the MES contains a country code which is regarded (by this LES) as invalid
11D6	Inconsistency in designated outgoing access information and subscriber class.	LES is clearing the call because the "PID" information received from the MES in the "scrambling vector" message (type 8DH) is not consistent with the PID information in the Fixed/MES-Originated (PID) and PID/MES Registration Tables at the LES as it relates to this call.
11D7		
11D8		
11E0		LES is clearing the call because the credit card PIN received from the MES is not considered (at this LES) to be valid.
11E1		LES is clearing the call because it has been determined that an excessive number of consecutive call attempts with

Cause Code	Description	Event
		invalid credit card PINs have been made
1201	Reserved	
1261	Reserved	
1262		Call cleared, MES time-out (Distress Test exceeded 120s)
1281	Channel type not implemented	MES is rejecting the call because the MES is not equipped to provide the specified service
1291	Requested circuit/channel not available.	MES is rejecting the call because although it is equipped to provide the specified service, it is not currently able to do so
12B1	Interworking. Unspecified	MES is rejecting or clearing the call for a reason which is not covered by any of the currently defined "Cause" events
12C1		Call failed, MES time-out (no scrambling vector ack)
12C2	Protocol error. Unspecified	MES is clearing the call because a "credit card valid" message (type A7H) has not been received by the MES within the allowed time limit
12C3	No response from terrestrial side	MES is clearing the call because a "LES Connect" message (type 8CH) has not been received by the MES within the allowed time limit



Cause Code	Description	Event
12C4	Protocol error. Unspecified	MES is clearing the call because the "authentication query" ISU message (type B4H) and/or the "authentication query" SSU message (type B5H) have not been received by the MES within the allowed time limit
12C5	Protocol error. Unspecified	MES is clearing the call because an expected supplementary services SU(s) has(have) not been received by the MES within the allowed time limit
12C6	Protocol error. Unspecified	MES is clearing the call because the "supplementary services interrogation" ISU (type B2H), and/or "subscriber digits" SSU (type ADH) messages have not been received by the MES within the allowed time limit
12C7	Protocol error. Unspecified	MES is clearing the call because a "SCPC channel release" SU (type 8AH) has not been received by the MES, in response to the transmission of a "notification acknowledge" message (type BAH) during the supplementary services call diversion information retrieval process, within the allowed time limit
12D1	Protocol error, unspecified.	LES is rejecting the call because the "spot-beam ID" information received from the MES is invalid (i.e., ID is not allocated on satellite in use)
12D2	Protocol error.	LES is clearing the call because the "Scrambling Vector" information received

Cause Code	Description	Event
	Unspecified	from the MES is invalid (ie,0000H, 6959H or 7FFFH)
1351		MES is clearing the call because the MES currently has insufficient free memory in which to store the short message
1361	Temporary failure	MES is clearing the call because the Above-decks equipment is about to "cable unwrap"
1362	Recovery on timer expiry.	MES is clearing the call because a long-term interruption in reception has occurred (the definition of a "long-term interruption" depends upon the service type, see Section B)
1363	Preemption	A Secondary Functional Center of a Multi-channel MES is clearing the call because the Primary Functional center has commanded the Above-decks equipment to repoint to a different Ocean Region
1392		Call cleared, spot beam transition
1451	No circuit/channel available.	LES is rejecting the call because an appropriate terrestrial circuit is not currently available at this specific LES
1452	No circuit/channel available.	LES is rejecting the call because an appropriate channel unit and associated terrestrial circuit are not currently available at this LES. [This "cause" is only utilized when there is a permanent "one-to-one" connection between appropriate

Cause Code	Description	Event
		channel units and their terrestrial circuits]
1541		Call cleared, pre-empted at LES
1551		LES is rejecting the call because an appropriate satellite channel is not currently available at this specific LES
1552	Reserved	
1581	Requested circuit/channel not available.	LES is rejecting the call because the requested service is not provided by this specific LES
1591	Temporary failure.	LES is rejecting the call because the requested service is temporarily not available at this specific LES
1592		LES is clearing the call because the specified credit card type is not currently supported by this specific LES
15A1	Bearer capability not authorized	LES is rejecting the call because the specified MES is not authorized for any service at this specific LES
15A2	Bearer capability not authorized	LES is rejecting the call because the specified MES is not authorized to use specific requested service via this specific LES
15A3		LES is clearing the call because the "credit card data" information received from the MES has been rejected by the credit card

Cause Code	Description	Event
		authorization process
15A4		LES is clearing the call because the data received from the MES in the "authentication reply" message (type B6H) has been declared "invalid" by the LES authentication process
15A5	Bearer capability not authorized	LES is rejecting the call because the specified PID is not authorized for any service at this specific LES
15A6	Bearer capability not authorized	LES is rejecting the call because the specified PID is not authorized to use specific requested service via this specific LES
15A7		
15B1	Interworking. Unspecified	LES is rejecting or clearing the call for a reason which is not covered by any of the currently defined "Cause" events
15C1	Protocol error, unspecified	LES is rejecting the call because an appropriate "Channel Assignment" message has not been received by the LES within the allowed time limit
15C2	Protocol error. Unspecified	LES is clearing the call because the "service address" information has not been received by the LES within the allowed time limit
15C3	Protocol error, unspecified	LES is clearing the call because a "Scrambling Vector" message (type 8DH)

Cause Code	Description	Event
		has not been received by the LES within the allowed time limit
15C4	Protocol error. Unspecified	LES is clearing the call because neither the "service address" information nor a "Scrambling Vector" message (type 8DH) has been received by the LES within the allowed time limit
15C5	Protocol error. Unspecified	LES is clearing the call because the complete "credit card data" information has not been received by the LES within the allowed time limit
15C6	Reserved	Call failed, LES time-out (return carrier identifier)
15C7	No answer from user (user alerted)	LES is clearing the call because a "MES Connect" message (type 99H) has not been received by the LES within the allowed time limit
15C8	Reserved	
15C9		LES is clearing the call because a "authentication reply" message (type B6H) has not been received by the LES within the allowed time limit
15CA		LES is clearing the call because a "notification acknowledge" message (type BAH) has not been received by the LES within the allowed time limit
15CB		LES is clearing the call because the

Cause Code	Description	Event
		request sequence number contained in the received "notification acknowledge" message (type BAH) is not valid (i.e. either not '0' or not the next value in the sequence)
15D1	Message with unrecognized parameter, discarded	LES is rejecting the call because the "Channel Assignment" message received from the NCS contains inappropriate or conflicting information
15D2	CES → NCS Signaling only.	LES is clearing this MES ID and channel number in the busy lists at LES and NCS because a new call to/from this MES is being set-up (and thus any previous call to/from this MES must have cleared)
15E1	Preemption - circuit reserved for reuse	LES is attempting to clear an MES which has sent an SCPC channel release message but is found still to be transmitting 5.12 s later
1651	No circuit/channel available.	LES is rejecting the call because an appropriate channel unit is not currently available at this specific LES
1661	Recovery on timer expiry	LES is clearing the call because of an interruption in reception of the MES carrier exceeding the allowed time limit
16C1	Reserved	
16C2	Recovery on timer expiry	LES is clearing the call because an appropriate SCPC MES carrier has not been received by the LES (at the

Cause Code	Description	Event
		commencement of the call) within the allowed time limit
1790		LES is clearing the call because of a malfunction in the credit card validity checking database or in the communications links thereto
1791		LES is clearing the call because of a malfunction in the authentication checking database or in the communications links thereto
1811	Called party is busy	NCS is rejecting the call because the specified MES ID is in the "MES busy" list at the NCS.
1841		Call cleared, NCS initiated preemption for incoming Pri 1 call
1842		Call cleared, NCS initiated preemption for incoming Pri 2 call
1843		Call cleared, NCS initiated preemption for incoming Pri 3 call
1844		Call cleared, NCS initiated channel preemption
1851	No circuit/channel available.	NCS is rejecting the call because an appropriate SCPC channel is not currently available
1852		

Cause Code	Description	Event
1853		
1854		NCS is rejecting the call because the MES is outside the spot beam coverage area
1855		Call rejected, preemption failed, no channel available
1856		Call rejected, spot beam selection failed
18A1	Bearer capability not authorized	NCS is rejecting the call because the specified MES ID was not found in the "Forward and Return MES ID" cross-reference table
18A2		NCS is rejecting the call because the MES is outside the spot beam coverage area
18A3		NCS is rejecting the call because the specified LES is not authorized for the requested service at the NCS
18B1	Interworking, unspecified	NCS is rejecting or clearing the call for a reason which is not covered by any of the currently defined "Cause" events
18B2		
18C1	Subscriber absent	NCS is rejecting the call because no message was received from the specified MES (in reaction to a Call Announcement message) within the allowed time limit
18D1		

Cause Code	Description	Event
18E1	Called Party is busy	NCS is rejecting the call because the specified MES ID is in the "MES busy" list at the NCS, and is listed as being busy with a call through the same LES as that now requesting a "call announcement" addressed to that MES
18E2		
18E4		
18E5		
1C61		
1F01	Normal (not shown in the handset)	LES is clearing the call because of the receipt of "on-hook" signalling from the relevant terrestrial circuit.
1F11	Called Party is busy	LES is clearing the call because the terrestrial called party is engaged (busy)
1F21	No User responded	LES is clearing the call because appropriate "off-hook" signalling from the terrestrial called party has not been received by the LES within the allowed time limit
1F61	Destination out of order	LES is clearing the call because of the detection of a failure in the relevant terrestrial circuit
1F62	Normal	The LES is clearing the call because the terrestrial calling party or the terrestrial network has cleared the call before the

Cause Code	Description	Event
		"MES connect" message has been received by the LES.

6.1.2 TT-3088A Messages

Alarm Type	Alarm Message
Transceiver Alarms	Tx-Level Not Ok.
	1. LO Lock Not Ok.
	2. LO Lock Not Ok.
	3. LO Lock Not Ok.
	Vtune Alarm.
	Invalid position information received from GPS.
	MSR Corrupt
	MIR Corrupt
	MIDR Corrupt
	NAR Corrupt
	NSR Corrupt
	SVR Corrupt



Alarm Type	Alarm Message

Antenna Alarms	Antenna(FEU), Wrong Type, Check Conf.
	Antenna(FEU) Link Down, Check Cable
	FEU Reset, Powered Down
	FEU Reset, Sleep Mode
	FEU Error, To Follow
	FEU Status, heat alarm
	FEU Status, burst alarm
	FEU Status, power alarm
	FEU Status, reset
	FEU Version Mismatch, Try Upload
	ACU Comm, Failure
	ACU Reset, Powered Down
	ACU Reset, Sleep Mode
	ACU Error, To Follow
	Kernel Error, Float point

6

Kernel Error, Control task overrun
Kernel Error, SCI tsk overrun
Memory Error, Control SW CRC
Memory Error, ACU Cnf Data
Memory Error, ACU Cal CRC
Memory Error, FLASH mem
Memory Error, ACU SRAM
Memory Error, ACU EEPROM
Motor Error, Azm Drive
Motor Error, Elv Drive
Motor Error, Azm Winding
Motor Error, Elv Winding
Pos feedback, Azm Zero Ref
Sensor Err, Roll Incl
Sensor Err, Pitch Incl
Sensor Err, Roll Rate
Sensor Err, Pitch Rate
Sensor Err, Yaw Rate

	Sensor Err, Roll attitude our of range
	Sensor Err, Pitch attitude out of range
	Sensor Err, Inclinator meas. out of range
	Ctrl Logic, ACU Matrix inversion error
	Ctrl Logic, ACU resett.
	Ctrl Logic, Floating point error type and address
Handset Alarms	Handset COM Error ¹

6

¹ This error means that the communication between handset and transceiver has stopped for some reason. It does not need to be an error caused by the handset, but it may be cause by errors in e.g. transceiver, antenna, and connection cables.

7 Index

- 2nd functions 20
- 64 kbit/s 29
- Abbreviations 1
- ACU 56, 76
- Additional Features 63
- ADU 6
- Alarm 14, 42, 89
- Alarm Log 42, 57
- Antenna 6, 56, 76
- Area 38, 39
- AT commands 76
- Azimuth 68
- Barring 54, 74
- Baudrate 49, 78
- BDU 7
- Brightness 55, 75
- Bulletin board 61
- C/No 43
- Call log 46
- Call Waiting Notification 30, 64
- Calling the terminal 28
- Connectors 9
- Contrast 49, 75
- Country code 5
- Data Limits 63
- Data setup 49
- Dataflow 49
- Date 51, 73
- Dial-Up networking 29, 31, 80
- Discrete I/O 9, 11
- Display symbols 13
- Elevation 68
- Email 29
- Fax 34
- File transfer 29
- FleetCP 67
- Function buttons 16
- Geo-stationary 3
- GPS 6, 52
- Handset 6, 9, 11, 48
- Help Desk 41, 58
- IMN 5, 48, 72
- Inmarsat 3
- Internal calls 35
- International access codes 28
- Internet Explorer 29
- IP/LAN 29
- ISDN 77
- ISN 43
- ISP 5
- Key Beep 50
- Language 73
- LED 55
- LES 39, 61, 71
- LESO 3
- Mailbox 40, 59
- Mask 52
- Menu 36
- Microwave iii
- Mounting position 56, 76
- MPDS 4, 29, 77
- NCS 3
- Normal User 26, 35
- Ocean region 38, 61
- Outlook Express 29
- Phonebook 33, 36, 70

- PIN code..... 26, 59, 63, 69
- Position 52
- Power..... 14
- Power button..... 23, 26
- PPPoE..... 85
- Prefix 27, 54, 74
- PUK code 27
- Redial..... 33
- Ring setup 50, 75
- Ringing tone..... 50
- RJ11 9, 33, 35, 48
- Routing 48, 72
- RS-232.. 9, 10, 48, 49, 75, 77
- Satellite..... 3
- Secure Telephone Unit 63
- Service User..... 27, 35
- Setup using Ethernet & PPPoE
..... 84
- Short code 33, 37
- Short message 40, 59
- Sky scans 56, 76
- Software version..... 43
- Spot-beams 3
- Status 43
- STU 63
- Super User..... 26, 35
- Synchronization 14
- Time 51, 73
- Time out..... 56, 76
- Transceiver unit..... 6
- Volume..... 50, 75
- Warning Log..... 58
- Web browsing..... 29
- Windows 2000 and PPPoE.. 85
- Windows XP and PPPoE 84

Appendix A - Menu Tree

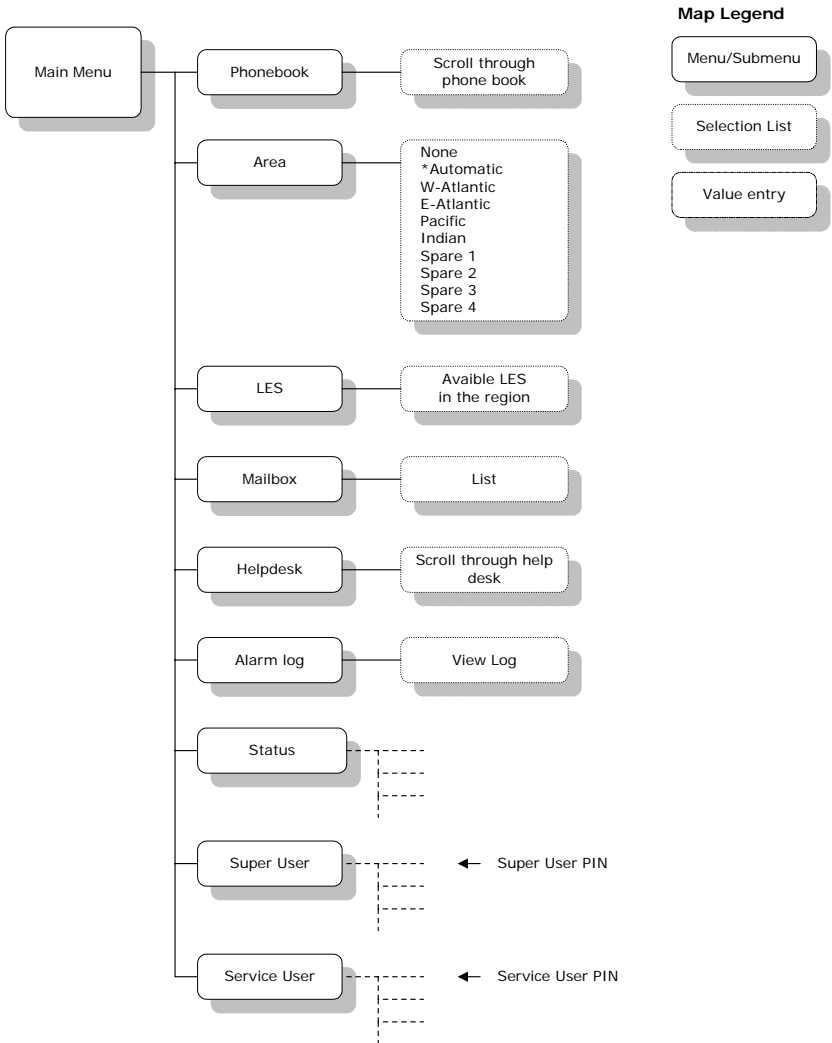

Appendix A - Menu Tree

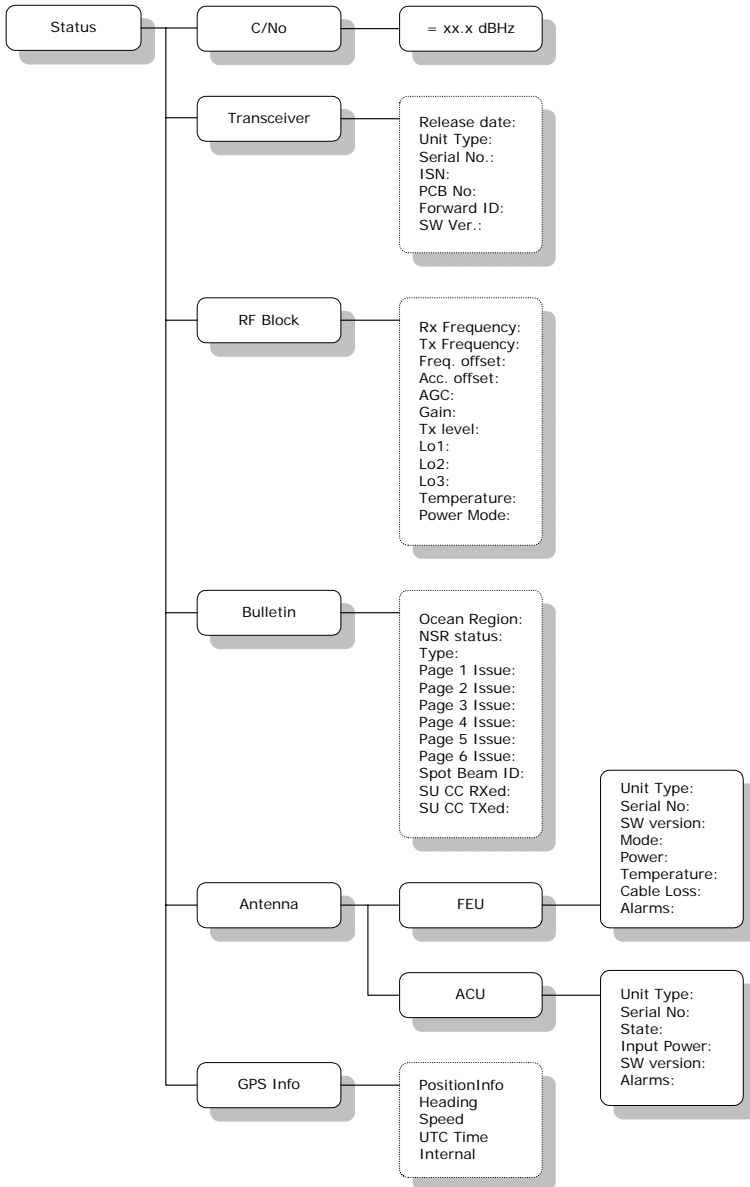

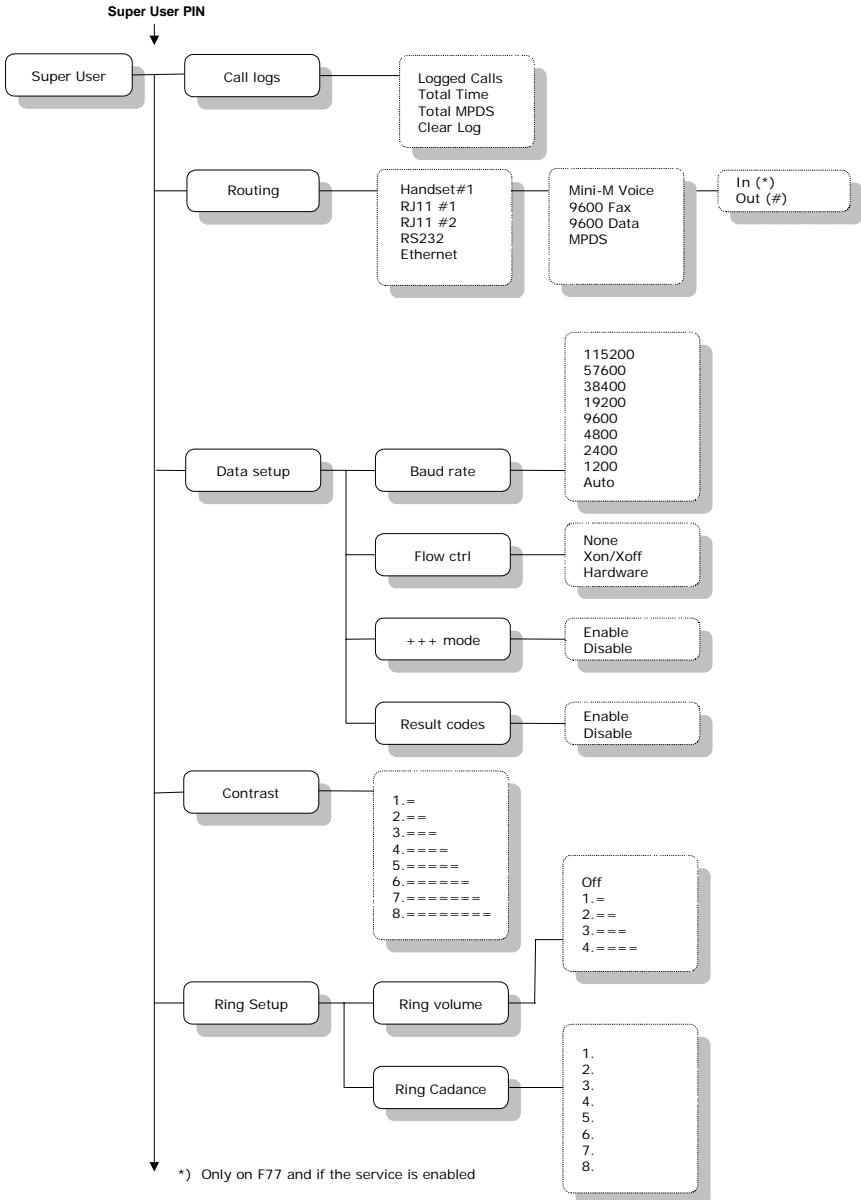

Appendix A - Menu Tree

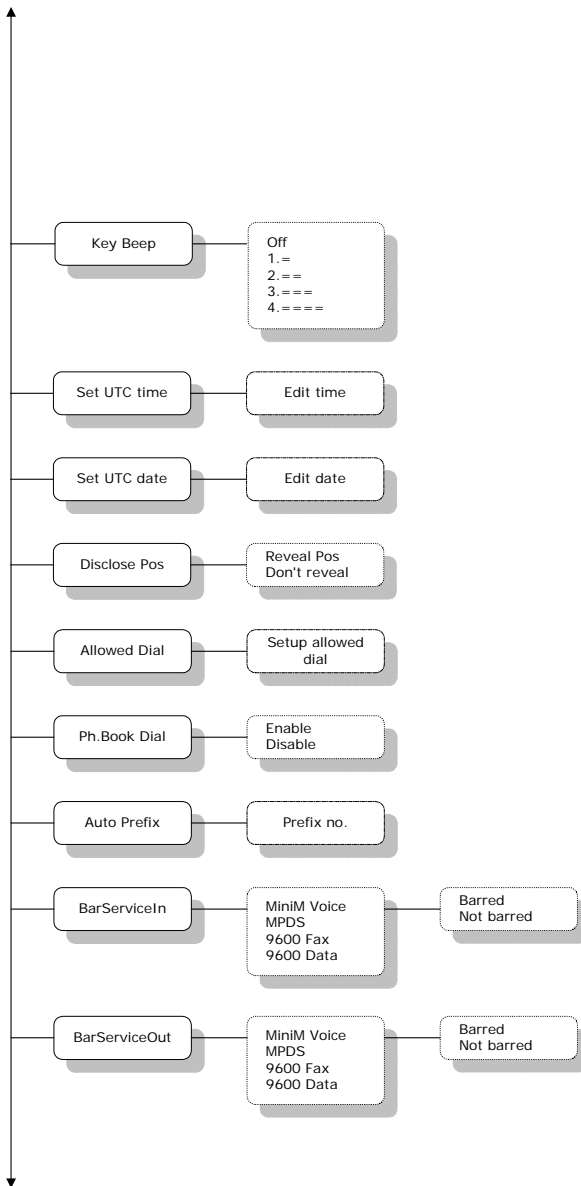

A

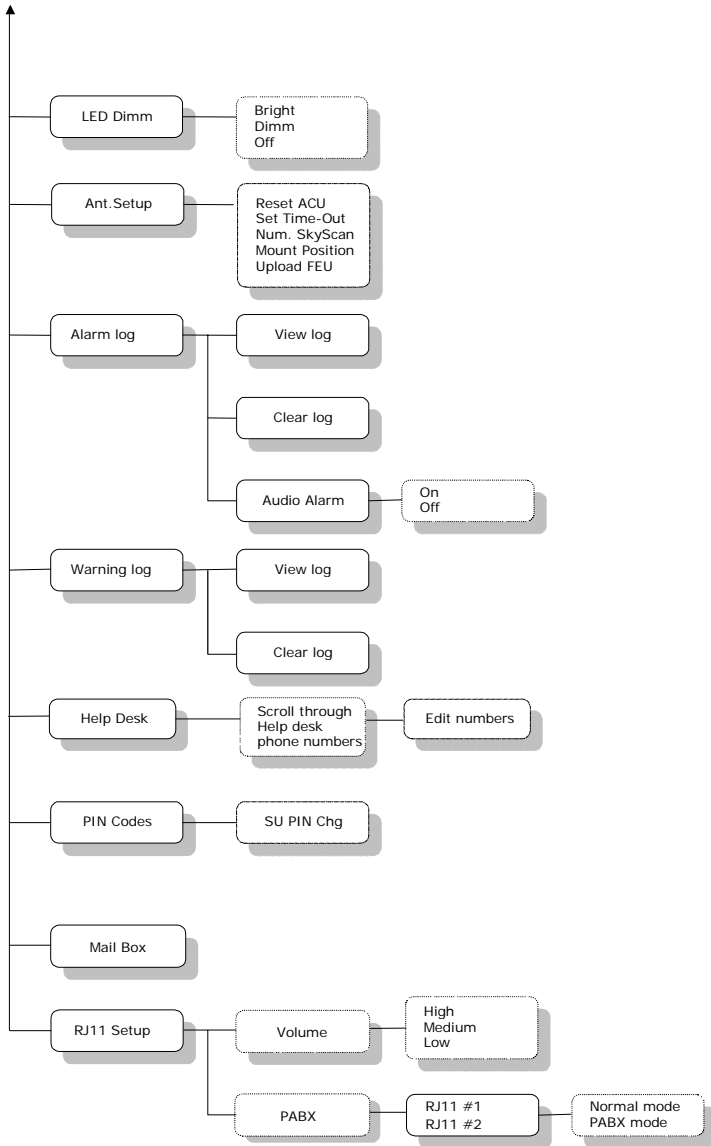

Appendix A - Menu Tree

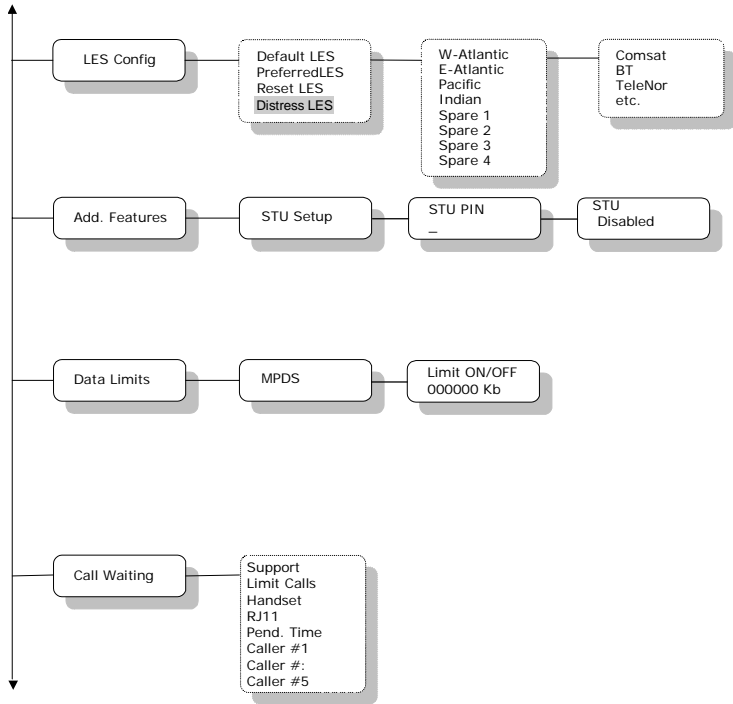

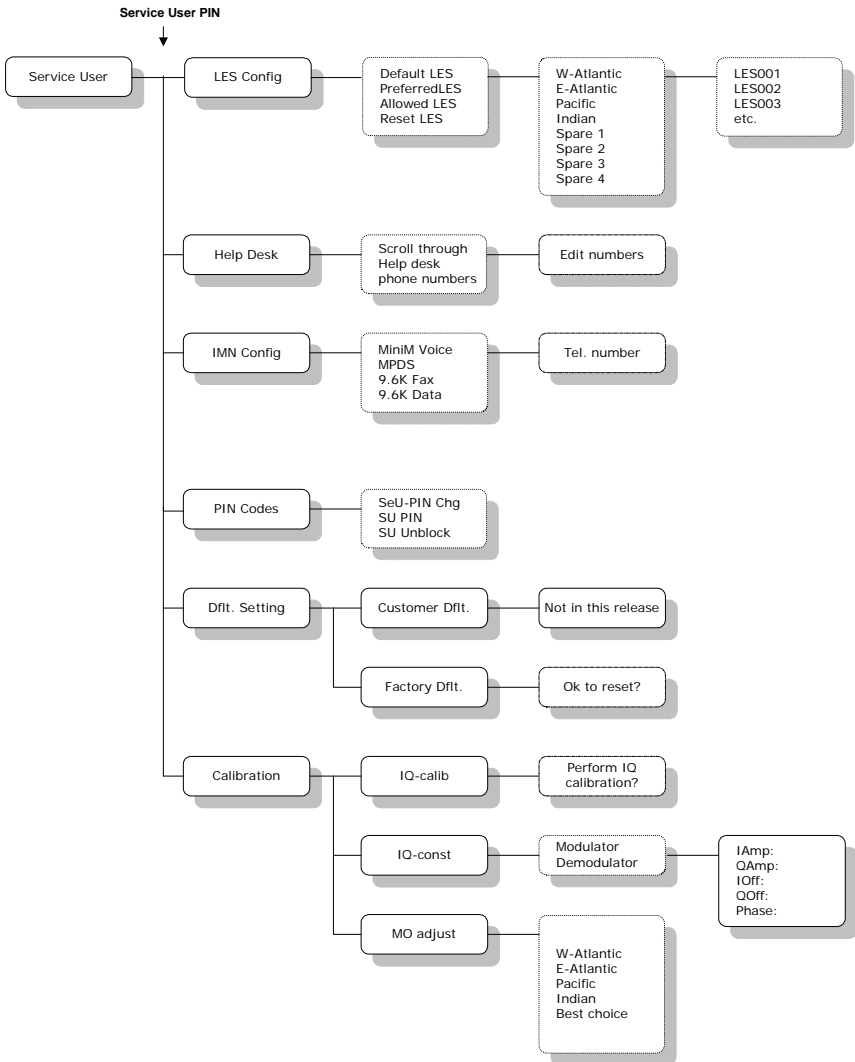



KVH Industries, Inc.

50 Enterprise Center • Middletown, RI 02842-5279 • U.S.A.
Phone: +1 401 847-3327 • Fax: +1 401 849-0045
E-mail: info@kvh.com Internet: www.kvh.com

KVH Europe A/S

Kokkedal Industripark 2B 2980 Kokkedal Denmark
Phone: +45 45 160 180 Fax: +45 45 160 181
E-mail: info@kvh.dk Internet: www.kvh.com

Free Manuals Download Website

<http://myh66.com>

<http://usermanuals.us>

<http://www.somanuals.com>

<http://www.4manuals.cc>

<http://www.manual-lib.com>

<http://www.404manual.com>

<http://www.luxmanual.com>

<http://aubethermostatmanual.com>

Golf course search by state

<http://golfingnear.com>

Email search by domain

<http://emailbydomain.com>

Auto manuals search

<http://auto.somanuals.com>

TV manuals search

<http://tv.somanuals.com>