

FAX OPERATION GUIDE

FS-3140MFP



Safety Conventions in This Guide

Please read the Operation Guide before using the facsimile. Keep it close to the facsimile for easy reference.

The sections of this handbook and parts of the facsimile marked with symbols are safety warnings meant to protect the user, other individuals and surrounding objects, and ensure correct and safe usage of the facsimile. The symbols and their meanings are indicated below.

 **WARNING:** Indicates that serious injury or even death may result from insufficient attention to or incorrect compliance with the related points.

 **CAUTION:** Indicates that personal injury or mechanical damage may result from insufficient attention to or incorrect compliance with the related points.

Symbols

The \triangle symbol indicates that the related section includes safety warnings. Specific points of attention are indicated inside the symbol.

 **[General warning]**

 **[Warning of danger of electrical shock]**

 **[Warning of high temperature]**

The \otimes symbol indicates that the related section includes information on prohibited actions. Specifics of the prohibited action are indicated inside the symbol.

 **[Warning of prohibited action]**

 **[Disassembly prohibited]**

The \bullet symbol indicates that the related section includes information on actions which must be performed. Specifics of the required action are indicated inside the symbol.

 **[Alert of required action]**

 **[Remove the power plug from the outlet]**

 **[Always connect the machine to an outlet with a ground connection]**

Please contact your service representative to order a replacement if the safety warnings in this Operation Guide are illegible or if the guide itself is missing. (fee required)

<Note>

Due to performance updating, information in this Operation Guide is subject to change without notice.

Contents

1	Part Names and Functions	
	Operation Panel	1-2
	Machine	1-4
2	Preparation Before Use	
	Selection of Telephone Line (Inch version only)	2-2
	Selection of Transmit Terminal Identification (TTI)	2-3
	Setting the TTI information	2-4
	Date and Time Entry	2-6
	Connection to PBX (Europe only)	2-8
3	FAX Operation (Basic)	
	Automatic Send	3-2
	FAX Automatic Reception	3-8
	Cancelling Communication	3-10
	Using the Address Book	3-13
	Using One-touch Keys	3-22
	Dialing the Same Receiving System (Redial)	3-24
4	FAX Operation (Advanced)	
	Delayed Transmission	4-2
	Broadcast Transmission	4-4
	Standby Transmission	4-5
	Interrupt Send	4-6
	Chain Dial	4-7
	Manual Send	4-8
	Manual Reception	4-9
	Remote Switch Function	4-11
	Printing/Forwarding Received Documents (Memory Forwarding)	4-13
	Sub Address Communication	4-25
	Sub Address Box Function	4-27
	Program Dial	4-32
	Polling Communication	4-33
	Account Management	4-42
	Other Convenient Functions	4-46
5	Checking Transmission Results and Registration Status	
	Various Tools for Checking Transmission Results and Registration Status	5-2
	Checking FAX Job History	5-3
	Printing Administrative Reports	5-5
	Reporting FAX Receipt Result by E-mail	5-10
6	Setup and Registration	
	FAX/TEL Auto Switch Reception	6-2
	FAX/Answering Machine Auto Switch Reception	6-4
	Rings	6-6
	Volume Adjustment	6-7
	Retry Times	6-8
	Receiving Mode	6-9
	Reception Date/Time	6-10
	Media Type for Print Output	6-11
	DRD Reception	6-13

Transmission Restriction	6-15
Encryption	6-24
Duplex Print Output	6-30
2 in 1 Reception	6-31
Print all at once [Batch Print]	6-32
Select Key Set	6-33
Remote Diagnostics	6-34
Prohibiting FAX Printing at Specified Times (Unusable Time)	6-35
7 About Network FAX	
What is Network FAX?	7-2
Setup	7-3
8 Troubleshooting	
Indicators During Sending/Receiving Operation	8-2
Precautions When Turning Power OFF	8-2
Error Messages	8-3
Troubleshooting	8-5
Appendix	
Character Entry Method	Appendix-2
Specifications (Fax function)	Appendix-6
Menu List	Appendix-7
Received FAX Sizes and Paper Priority (Inch Model)	Appendix-9
Received FAX Sizes and Paper Priority (Metric Model)	Appendix-10
Error Code List	Appendix-11

Safety Information

About this Operation Guide

This Operation Guide contains information on using the facsimile functions of this machine. Please read the Operation Guide before you start using the machine. Keep it close to the machine for easy reference.

When using the machine, refer to the Safety Guide (booklet) and the Operation Guide for the machine (on the CD-ROM) for information on the topics below.

- Caution Labels
- Installation Precautions
- Precautions for Use
- Loading Paper
- Toner Container and Waste Toner Box Replacement
- Clearing Paper Jams
- Solving Malfunctions
- Cleaning

Power supply/Grounding the machine

Do not connect this machine to the same outlet as an air conditioner or copier, etc.

General Notice

Legal Notice

WE SHALL HAVE NO LIABILITY FOR LOSS, WHETHER OR PARTIAL, OF RECEIVED DOCUMENTS WHEN SUCH LOSS IS CAUSED BY DAMAGES TO THE FAX SYSTEM, MALFUNCTIONS, MISUSE, OR EXTERNAL FACTORS SUCH AS POWER OUTAGES; OR FOR PURELY ECONOMIC LOSSES OR LOST PROFITS RESULTING FROM MISSED OPPORTUNITIES ATTRIBUTABLE TO MISSED CALLS OR RECORDED MESSAGES RESULTING THEREFROM.

Trademark Information

- Adobe and Acrobat are registered trademarks of Adobe Systems Incorporated.

All other company and product names in this Operation Guide are trademarks or registered trademarks of their respective companies. The designations™ and ® are omitted in this guide.

FCC PART 68 REQUIREMENTS

- 1** This equipment complies with Part 68 of the FCC rules and the requirements adopted by the ACTA. On the rear side of the equipment to install Assembly Board is a label that contains, among other information, a product identifier in the format US:AAAEQ##TXXXX. If requested, this number must be provided to the telephone company.
- 2** This equipment connects to the network via USOC RJ11C.
- 3** A plug and jack used to connect this equipment to the premises wiring and telephone network must comply with the applicable FCC Part 68 rules and requirements adopted by the ACTA. A compliant telephone cord and modular plug is provided with this product. It is designed to be connected to a compatible modular jack that is also compliant. See installation instructions for details.
- 4** The REN is used to determine the number of devices that may be connected to a telephone line. Excessive RENs on a telephone line may result in the devices not ringing in response to an incoming call. In most but not all areas, the sum of RENs should not exceed five (5.0). To be certain of the number of devices that may be connected to a line, as determined by the total RENs, contact the local telephone company. For products approved after July 23, 2001, the REN for this product is part of the product identifier that has the format US:AAAEQ##TXXXX. The digits represented by ## are the REN without a decimal point (e.g., 03 is a REN of 0.3). For earlier products, the REN is separately shown on the label.
- 5** If this equipment causes harm to the telephone network, the telephone company will notify you in advance that temporary discontinuance of service may be required. But if advance notice isn't practical, the telephone company will notify the customer as soon as possible. Also, you will be advised of your right to file a complaint with the FCC if you believe it is necessary.
- 6** The telephone company may make changes in its facilities, equipment, operations or procedures that could affect the operation of the equipment. If this happens the telephone company will provide advance notice in order for you to make necessary modifications to maintain uninterrupted service.

- 7 If trouble is experienced with this equipment, please contact the following company for repair and (or) warranty information:

KYOCERA MITA AMERICA, INC.

225 Sand Road,
Fairfield, New Jersey 07004-0008
TEL : (973) 808-8444

If the equipment is causing harm to the telephone network, the telephone company may request that you disconnect the equipment until the problem is resolved.

- 8 This equipment cannot be used on public coin service provided by the telephone company. Connection to Party line service is subject to state tariffs. Contact the state public utility commission, public service commission or corporation commission for information.
- 9 If your home has specially wired alarm equipment connected to the telephone line, ensure the installation of this equipment does not disable your alarm equipment. If you have questions about what will disable alarm equipment, consult your telephone company or a qualified installer.
- 10 The Telephone Consumer Protection Act of 1991 makes it unlawful for any person to use a computer or other electronic device, including FAX machines, to send any message unless such message clearly contains in a margin at the top or bottom of each transmitted page or on the first page of the transmission, the date and time it is sent and an identification of the business or other entity, or other individual sending the message and the telephone number of the sending machine or such business, other entity, or individual. (The telephone number provided may not be a 900 number or any other number for which charges exceed local or long-distance transmission charges.)
In order to program this information into your FAX machine, you should complete the following steps: (Insure that it will be transmitted, see *Local FAX Name Registration on page 2-4*, *Local FAX Information Entry on page 2-4*, *Date and Time Entry on page 2-6*, and *Selection of Transmit Terminal Identification (TTI) on page 2-3*.)

IMPORTANT SAFETY INSTRUCTIONS

When using your telephone equipment, basic safety precautions should always be followed to reduce the risk of fire, electric shock and injury to persons, including the following:

CAUTION: To reduce the risk of fire, use only No.26 AWG or larger UL listed or CSA certified telecommunication line cord.

- 1 Do not use this product near water, for example, near a bath tub, wash bowl, kitchen sink or laundry tub, in a wet basement or near a swimming pool.
- 2 Avoid using a telephone (other than a cordless type) during an electrical storm. There may be a remote risk of electric shock from lightning.
- 3 Do not use the telephone to report a gas leak in the vicinity of the leak.
- 4 Use only the power cord and batteries indicated in this manual. Do not dispose of batteries in a fire. They may explode. Check with local codes for possible special disposal instructions.

SAVE THESE INSTRUCTIONS

IMPORTANTES MESURES DE SECURITE

Certaines mesures de sécurité doivent être prises pendant l'utilisation de matériel téléphonique afin de réduire les risques d'incendie, de choc électrique et de blessures. En voici quelques unes:

- 1** Ne pas utiliser l'appareil près de l'eau, p. ex., près d'une baignoire, d'un lavabo, d'un évier de cuisine, d'un bac à laver, dans un sous-sol humide ou près d'une piscine.
- 2** Eviter d'utiliser le téléphone (sauf s'il s'agit d'un appareil sans fil) pendant un orage électrique. Ceci peut présenter un risque de choc électrique causé par la foudre.
- 3** Ne pas utiliser l'appareil téléphonique pour signaler une fuite de gaz s'il est situé près de la fuite.
- 4** Utiliser seulement le cordon d'alimentation et le type de piles indiqués dans ce manuel. Ne pas jeter les piles dans le feu: elles peuvent exploser. Se conformer aux règlements pertinents quant à l'élimination des piles.

CONSERVER CES INSTRUCTIONS

CANADIAN IC REQUIREMENTS

"This product meets the applicable Industry Canada technical specifications"

"The Ringer Equivalence Number is an indication of the maximum number of devices allowed to be connected to a telephone interface. The termination on an interface may consist of any combination of devices subject only to the requirement that the sum of the RENs of all the devices does not exceed five."

The REN (CANADA) of this product is 0.4.

CONDITIONS DE L'IC CANADIENNE

"Le présent matériel est conforme aux spécifications techniques applicables d'Industrie Canada."

"L'indice d'équivalence de la sonnerie (IES) sert à indiquer le nombre maximal de terminaux qui peuvent être raccordés à une interface téléphonique. La terminaison d'une interface peut consister en une combinaison quelconque de dispositifs, à la seule condition que la somme d'indices d'équivalence de la sonnerie de tous les dispositifs n'excède pas 5."

Le IES (CANADA) pour ce produit est 0.4.



Declarations to European Directives

DECLARATION OF CONFORMITY TO 2004/108/EC, 2006/95/EEC, 93/68/EEC, 1999/5/EC and 2009/125/EC

We declare under our sole responsibility that the product to which this declaration relates is in conformity with the following specifications.

Limits and methods of measurement for immunity characteristics of information technology equipment	EN55024
Limits and methods of measurement for radio interference characteristics of information technology equipment	EN55022 Class B
Limits for harmonic currents emissions for equipment input current $\leq 16A$ per phase	EN61000-3-2
Limitation of voltage fluctuations and flicker in low-voltage supply systems for equipment with rated current $\leq 16A$	EN61000-3-3
Safety of information technology equipment, including electrical business equipment	EN60950-1
Terminal Equipment (TE); Attachment requirements for pan-European approval for connection to the analogue Public Switched Telephone Networks (PSTNs) of TE (excluding TE supporting the voice telephony service) in which network addressing, if provided, is by means of Dual Tone Multi Frequency (DTMF) signalling.	TBR 21

Technical regulations for terminal equipment

This terminal equipment complies with:

- TBR21
- AN 01R00 AN for P
- AN 02R01 AN for CH and N
- AN 05R01 AN for D, E, GR, P and N
- AN 06R00 AN for D, GR and P
- AN 07R01 AN for D, E, P and N
- AN 09R00 AN for D
- AN 10R00 AN for D
- AN 11R00 AN for P
- AN 12R00 AN for E
- AN 16R00 General Advisory Note
- DE 03R00 National AN for D
- DE 04R00 National AN for D
- DE 05R00 National AN for D
- DE 08R00 National AN for D
- DE 09R00 National AN for D
- DE 12R00 National AN for D
- DE 14R00 National AN for D
- ES 01R01 National AN for E
- GR 01R00 National AN for GR
- GR 03R00 National AN for GR
- GR 04R00 National AN for GR
- NO 01R00 National AN for N
- NO 02R00 National AN for N
- P 03R00 National AN for P
- P 04R00 National AN for P
- P 08R00 National AN for P

Network Compatibility Declaration

The manufacturer declares that the equipment has been designed to operate in the public switched telephone networks (PSTN) in the following countries:

- | | | | |
|-------------------|-----------|-----------------|--------------|
| ■ Austria | ■ Germany | ■ Liechtenstein | ■ Slovakia |
| ■ Belgium | ■ Greece | ■ Lithuania | ■ Slovenia |
| ■ Bulgaria | ■ Cyprus | ■ Hungary | ■ Luxembourg |
| ■ Spain | ■ Czech | ■ Iceland | ■ Malta |
| ■ Sweden | ■ Denmark | ■ Ireland | ■ Norway |
| ■ Switzerland | ■ Estonia | ■ Italy | ■ Poland |
| ■ The Netherlands | ■ Finland | ■ Latvia | ■ Portugal |
| ■ United Kingdom | ■ France | ■ Romania | |

Introduction

About This Guide

This guide consists of the following chapters.

Chapter 1 - Part Names and Functions

Explains the parts of the machine and keys on the operation panel.

Chapter 2 - Preparation Before Use

Explains the settings required before using fax.

Chapter 3 - FAX Operation (Basic)

Explains general usage of the fax function such as sending originals and receiving originals.

Chapter 4 - FAX Operation (Advanced)

Explains convenient fax functions such as setting the transmission time, continuous sending of the same originals to multiple recipients and scheduling the next transmission. Also explains advanced fax communication such as limiting the destinations and systems from which you receive originals, as well as forwarding, saving, and printing the received originals for each requirement. Furthermore, explains sub address communication functions of the machine that are compatible with other makers' systems and job accounting functions convenient for checking the communication status of fax.

Chapter 5 - Checking Transmission Results and Registration Status

Explains how to check the status of recent transmissions on the message display. Also, explains how to print administrative reports to check communication results and settings and registration status of the machine.

Chapter 6 - Setup and Registration

Explains various settings and registration pertaining to functions, such as adjusting the volume of the alarm sound.

Chapter 7 - About Network FAX

Explains how to use Network FAX functions. Read the *Network FAX Driver Operation Guide* in the included CD-ROM (online manual) as well.

Chapter 8 - Troubleshooting

Explains how to respond to error indications and trouble.

Appendix

Explains character entry and the specifications of the machine.

Conventions in This Guide

The following conventions are used depending on the nature of the description.

Convention	Description	Example
Bold	Indicates the operation panel keys or a computer screen.	Press the Start key.
[Regular]	Indicates a selection item on the Message Display.	Select [System].
<i>Italic</i>	Indicates a message displayed on the Message Display.	<i>Ready to copy</i> is displayed.
	Used to emphasize a key word, phrase or references to additional information.	For more information refer to <i>Sleep and Auto Sleep on page 3-5</i> .
Note	Indicates supplemental information or operations for reference.	NOTE:
Important	Indicates items that are required or prohibited so as to avoid problems.	IMPORTANT:
Caution	Indicates what must be observed to prevent injury or machine breakdown and how to deal with it.	CAUTION:

1 Part Names and Functions

This chapter explains the names of parts of the fax device.

For other parts, refer to the machine's *Operation Guide*.

- Operation Panel 1-2
- Machine 1-4

Operation Panel

For the names of keys and indicators required when functions other than FAX are used, refer to the machine's *Operation Guide*.

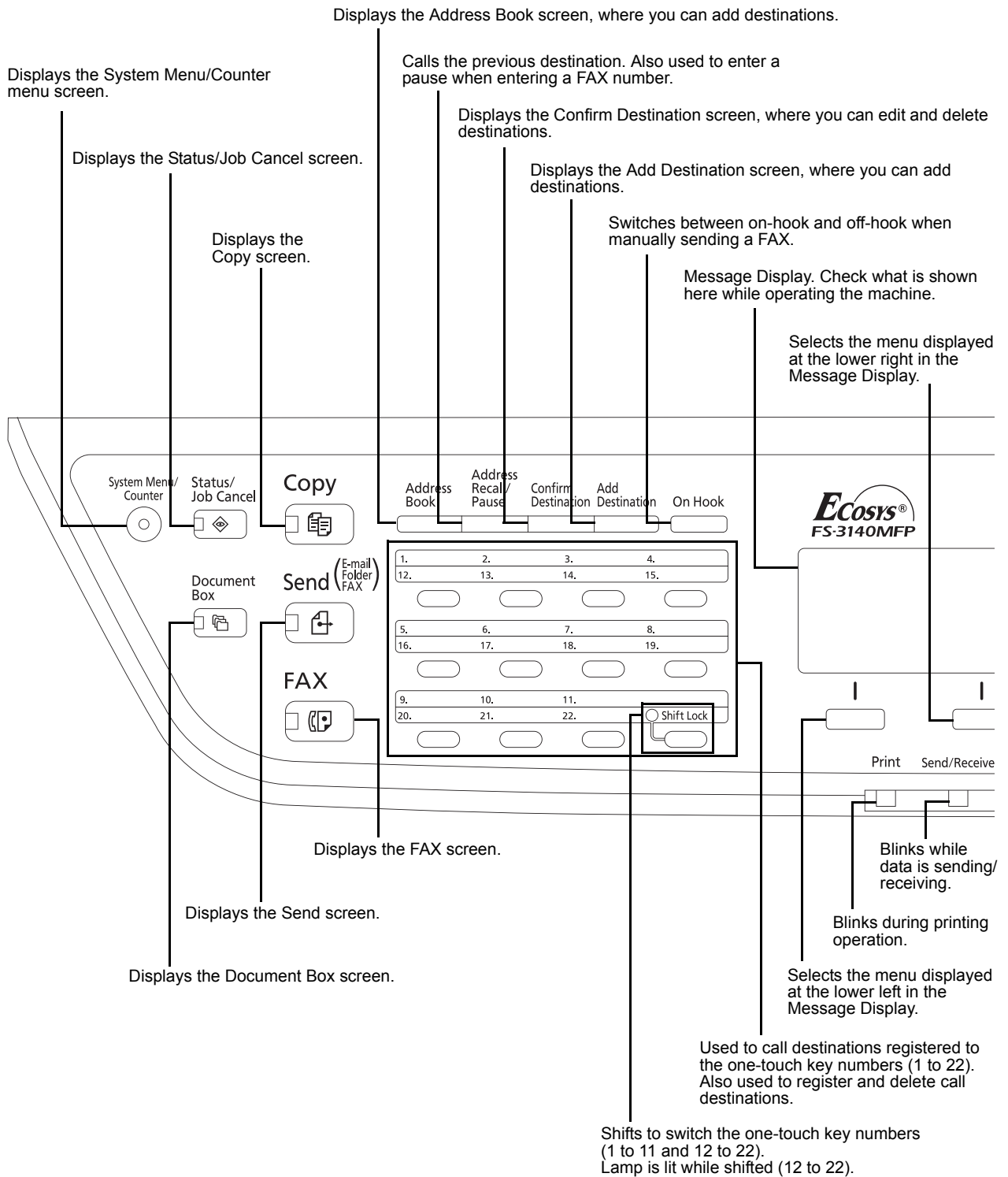

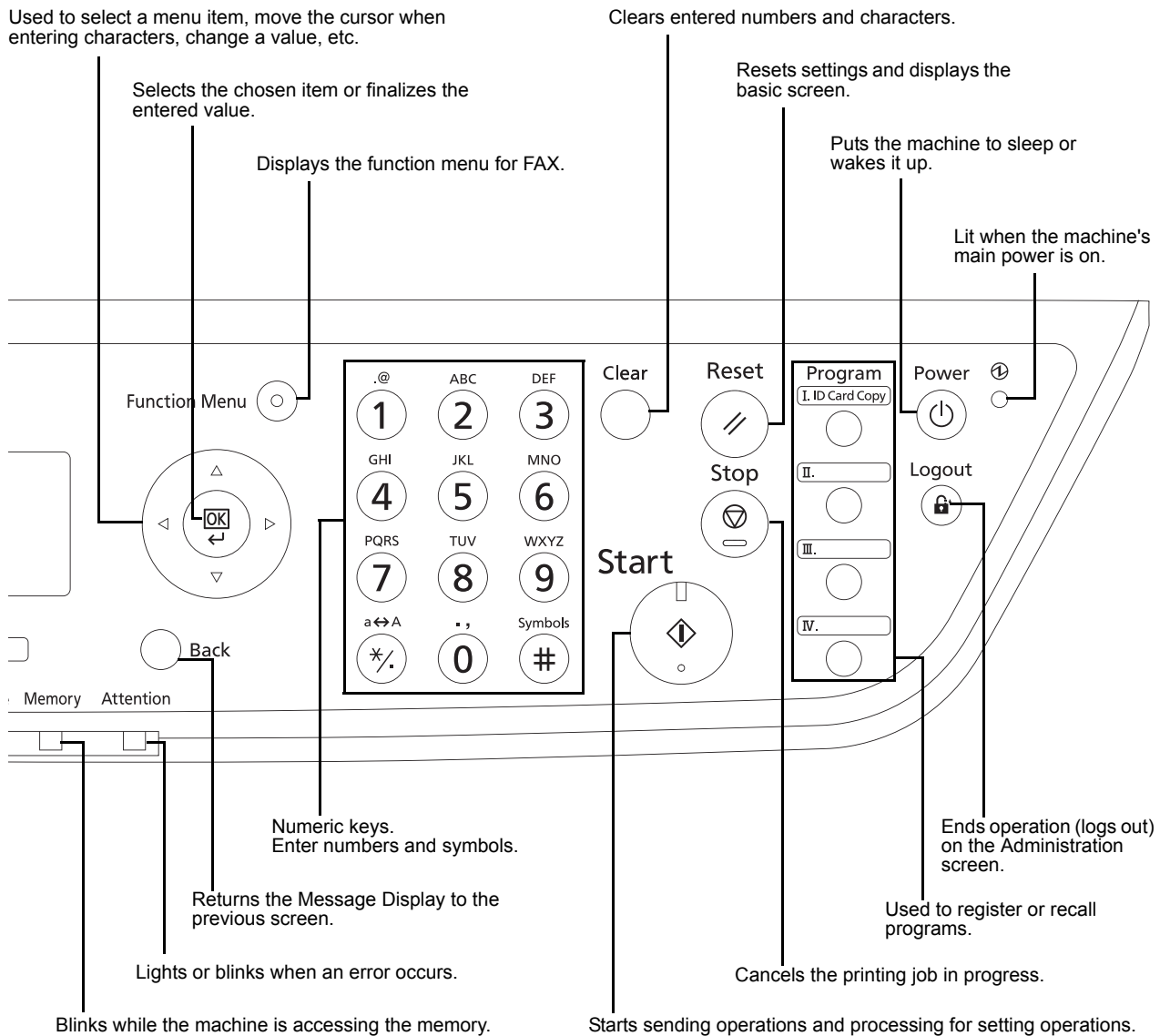

Machine

This chapter explains the names of parts of the fax device.

For the parts required when functions other than FAX are used, refer to the machine's *Operation Guide*.

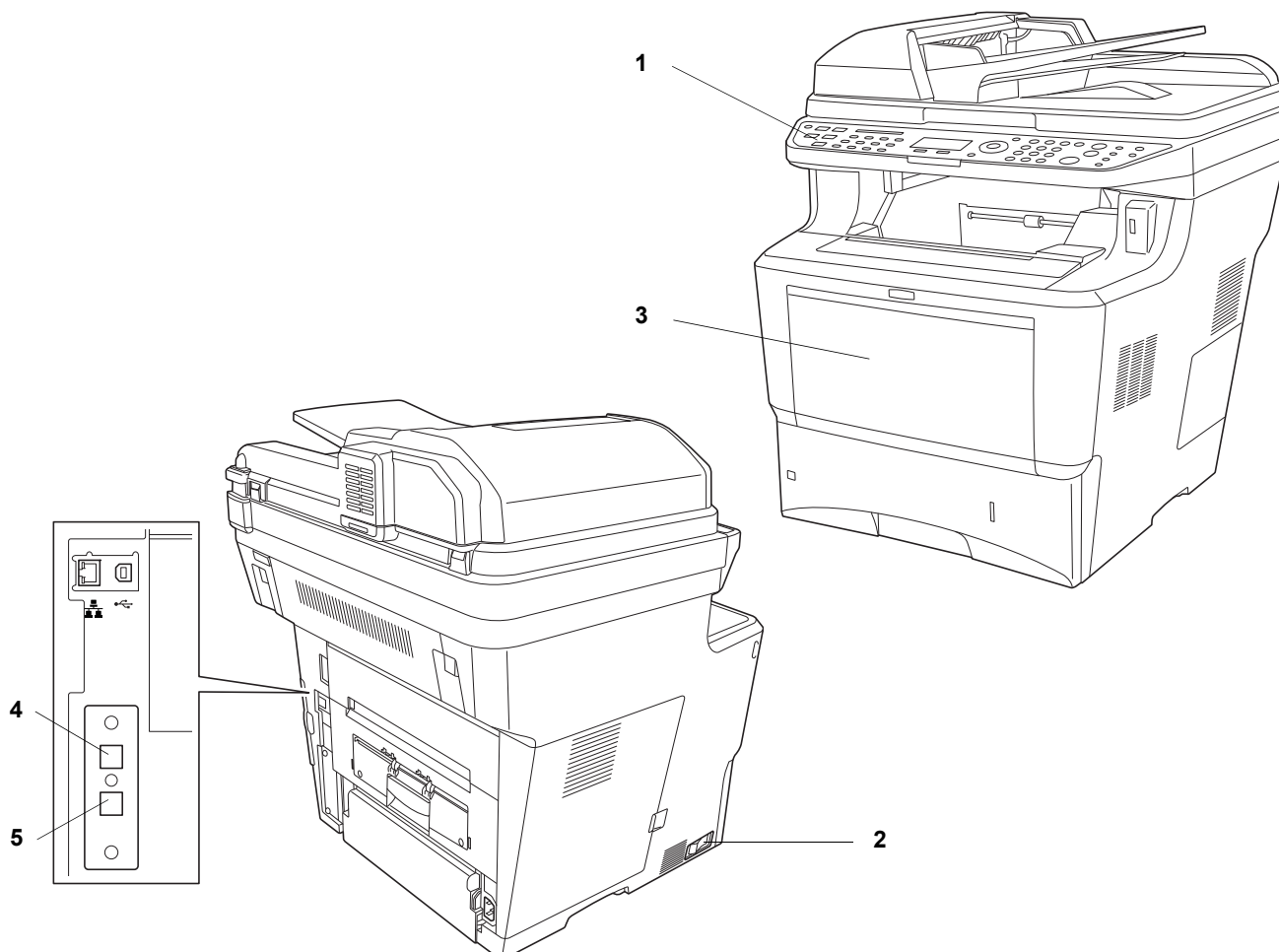

1	Operation panel	Perform the fax operation with this panel.
2	Main power switch	Set this switch to the ON (I) side when performing the fax or copier operation. The message display lights to enable operation.
3	MP (Multi Purpose) tray	Set the paper in this tray when using a type of paper other than the cassette (e.g., when using special paper).
4	LINE connector	Connect the modular cord for the telephone line to this connector.
5	TEL connector	When using a commercially available telephone set, connect the modular cord to this connector.

IMPORTANT: You cannot automatically receive a fax when the main power switch is turned off. To put the machine to sleep, press the **Power** key on the operation panel.

Document Processor

1

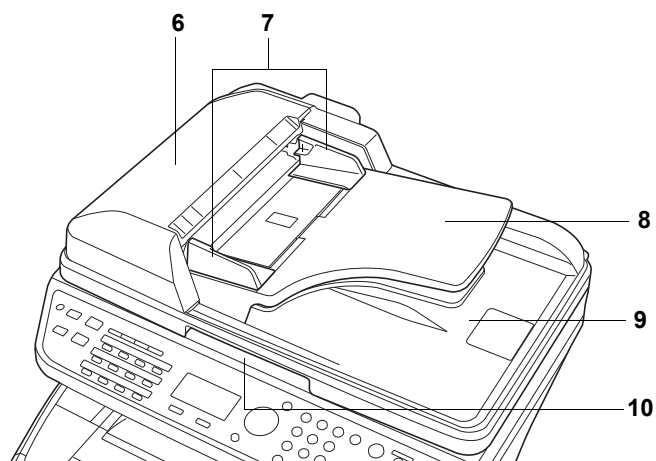

6	Top cover	Open this cover when the original jammed in the Document Processor.
7	Original width guides	Adjust these guides according to the original width.
8	Original table	Stack the sheet originals on this table.
9	Original eject table	Read originals are ejected onto this table.
10	Opening handle	Hold this handle when opening or closing the Document Processor.

2 Preparation Before Use

This chapter explains the preparation necessary before the machine is used.

There is no need for the customer to undertake this preparation if it has already been carried out by a service representative.

- Selection of Telephone Line (Inch version only).....2-2
- Selection of Transmit Terminal Identification (TTI)2-3
- Setting the TTI information2-4
- Date and Time Entry2-6
- Connection to PBX (Europe only)2-8

Selection of Telephone Line (Inch version only)

Select the telephone line according to the type you are contracted with. Please note that selecting a wrong telephone line will prevent you from sending fax.

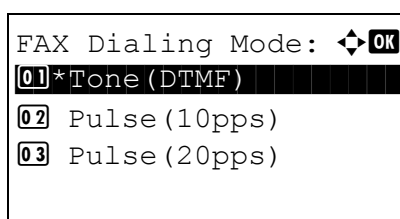

- 1 Press the **System Menu/Counter** key.
- 2 Press the Δ or ∇ key to select [FAX].
- 3 Press the **OK** key.
- 4 Press the Δ or ∇ key to select [Transmission].
- 5 Press the **OK** key.
- 6 Press the Δ or ∇ key to select [FAX Dialing Mode].
- 7 Press the **OK** key.
- 8 Press the Δ or ∇ key to select [Tone(DTMF)] , [Pulse(10pps)] or [Pulse(20pps)] according to the type of telephone line you are contracted with.
- 9 Press the **OK** key.

Selection of Transmit Terminal Identification (TTI)

The transmit terminal identification (TTI) is the information about the machine (transmit terminal) to be printed out on the fax on the receiving system. The information includes transmission date and time, the number of transmission pages, and the Local FAX number/ID. This machine enables the user to select if the TTI is printed out on the fax on the receiving system. Regarding the location of the information to be printed, you can select inside or outside of the page image being sent.

NOTE: Normally, the Local FAX Name is printed in the transmit terminal identification (TTI). However, when job accounting has been enabled, and you send originals after entering an Account ID, the Account Name is printed.

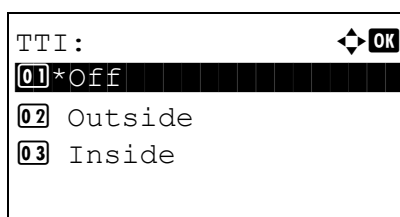

- 1 Press the **System Menu/Counter** key.
- 2 Press the Δ or ∇ key to select [FAX].
- 3 Press the **OK** key.
- 4 Press the Δ or ∇ key to select [Transmission].
- 5 Press the **OK** key.
- 6 Press the Δ or ∇ key to select [TTI].
- 7 Press the **OK** key.
- 8 Press the Δ or ∇ key to select the desired location for printing the information or [Off] if you don't want to print it.
- 9 Press the **OK** key.

Setting the TTI information

Register the name (local FAX name), fax number, and local FAX ID printed in the transmit terminal identification (TTI) area.

By registering the TTI data, the receiver can easily find out where the FAX came from.

Local FAX Name Registration

Register the local FAX name printed on in the transmit terminal identification.

NOTE: To change the entry, follow the same operation.

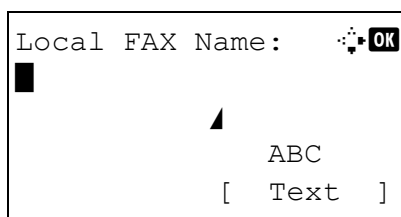

- 1 Press the **System Menu/Counter** key.
- 2 Press the Δ or ∇ key to select [FAX].
- 3 Press the **OK** key.
- 4 Press the Δ or ∇ key to select [Transmission].
- 5 Press the **OK** key.
- 6 Press the Δ or ∇ key to select [Local FAX Name].
- 7 Press the **OK** key.
- 8 Enter the *Local FAX Name* to be registered. Up to 32 characters can be entered.

NOTE: For details on character entry, refer to *Specifications (Fax function) on Appendix-6*.

- 9 Press the **OK** key.

Local FAX Information Entry

Register the local FAX information (local FAX number/ID) printed on in the transmit terminal identification (TTI) area. The Local FAX ID is used for transmission limit purposes. (Refer to *Transmission Restriction on page 6-15*.)

- 1 Press the **System Menu/Counter** key.
- 2 Press the Δ or ∇ key to select [FAX].
- 3 Press the **OK** key.
- 4 Press the Δ or ∇ key to select [Transmission].
- 5 Press the **OK** key.

When you register the Local FAX Number, go to next step. When you register the Local FAX ID, go to step 10.

Local FAX Number Entry

- 6 Press the Δ or ∇ key to select [Local FAX Number].

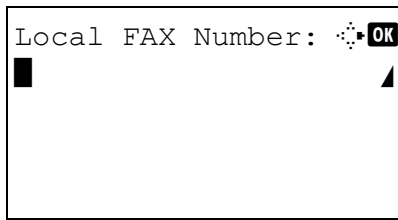

- 7 Press the **OK** key.
- 8 Use the numeric keys to enter the local FAX number to be registered. Up to 20 digits can be entered.

NOTE: Press the ◀ or ▶ key to move the cursor.

To correct the number, press the **Clear** key to delete the digits one by one before reentering the number. To delete all entered digits and return to the default screen, press the **Reset** key.

Local FAX ID Entry

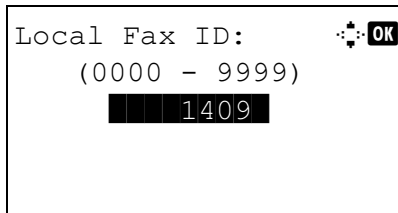

- 9 Press the **OK** key.
- 10 Press the Δ or ∇ key to select [Local FAX ID].
- 11 Press the **OK** key.
- 12 Use the numeric keys to enter the local FAX ID number in 4 digits.
- 13 Press the **OK** key.

Date and Time Entry

Register the date and time of the machine's built-in clock. Because the FAX delayed transmission is conducted based on the time registered here, be sure to register the correct date and time.

IMPORTANT: Correct the time displayed on the operation panel regularly. The time displayed may deviate from the current time due to errors.

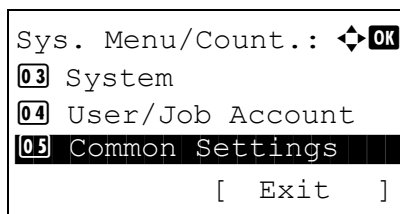

- 1 In the Sys. Menu/Count. menu, press the Δ or ∇ key to select [Common Settings].

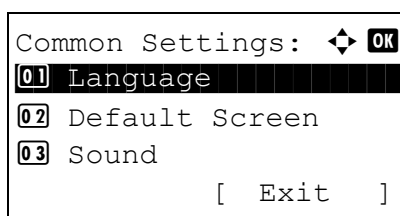

- 2 Press the **OK** key. The Common Settings menu appears.

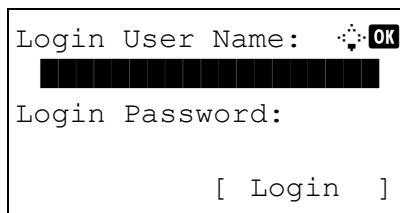

- 3 Press the Δ or ∇ key to select [Date Setting], and press the **OK** key.

A login screen will appear. Then, enter the user ID and password with administrator privileges to log in, and press [Login] (the **Right Select** key).

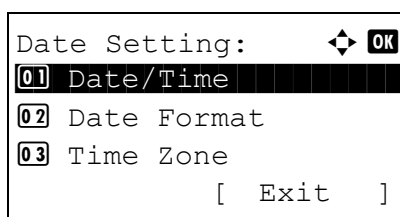

- 4 The Date Settings menu appears.

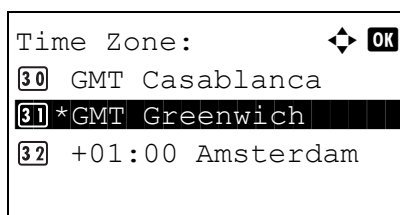

- 5 Press the Δ or ∇ key to select [Time Zone].
- 6 Press the **OK** key. Time Zone appears.

- 7 Press the Δ or ∇ key to select your region, and press the **OK** key.

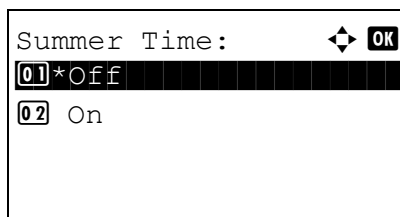

- 8 Press the Δ or ∇ key to select [Summer Time]. Summer Time appears.

NOTE: If you select a region that does not utilize summer time, the summer time setting screen will not appear.

2

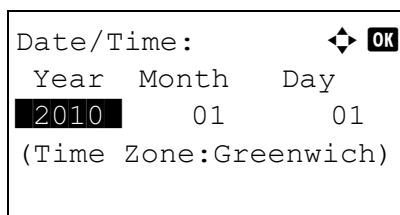

- 9 Press the Δ or ∇ key to select [On] or [Off], and press the **OK** key.

- 10 Press the Δ or ∇ key to select [Date/Time], and press the **OK** key. The screen to enter the date of Date/Time appears.

- 11 Press the \triangleleft or \triangleright key to move to the item (Year / Month / Day) you want to enter.

Press the Δ or ∇ key to set each item.

- 12 Press the **OK** key. The screen to enter the time of Date/Time appears.

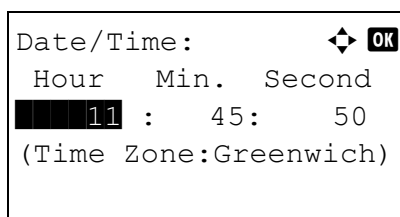

- 13 Set the time.

Press the \triangleleft or \triangleright key to move to the item (Hour / Min. / Second) you want to enter.

Press the Δ or ∇ key to set each item.

- 14 Press the **OK** key. *Completed.* is displayed and the screen returns to the Date Settings menu.

Connection to PBX (Europe only)

When using this machine in environment in which PBX (Private Branch Exchange) for connection to multiple phones for business use is installed, perform the following PBX setting.

NOTE: Before connecting this machine to PBX, it is recommended to contact the company that installed the PBX system to request connection of this machine. Note that correct operation cannot be guaranteed in environment in which this machine is connected to PBX because the functions of this machine may be restricted.

PBX-Setting

Item	Setting value	Description
PSTN/PBX-setting	PSTN	Use when connecting this machine to a public switched telephone network (default).
	PBX	Use when connecting this machine to PBX.
Outside call number setting	0 - 9 00 - 99	Set a number to access an outside line. For the number, contact the PBX administrator.

- 1** Press **System Menu/Counter**.
- 2** Press Δ or ∇ to select *Adjust/Maint.*. Press the **OK** key.
- 3** Press Δ or ∇ to select *Service Setting*. Press the **OK** key.
- 4** Press Δ or ∇ to select *FAX Call Set.*. Press the **OK** key.
- 5** Press Δ or ∇ to select *Exchange Select.*. Press the **OK** key.
- 6** Press Δ or ∇ to select *PBX*. Press the **OK** key.
- 7** Press Δ or ∇ to select *Dial No. to PSTN*. Press the **OK** key.
- 8** Use the numeric keys to enter the number to access the outside line. Press the **OK** key.

Press [Exit] (the **Right Select** key) to return to the basic screen.

3 FAX Operation (Basic)

This chapter explains the following basic operations.

- Automatic Send 3-2
- FAX Automatic Reception 3-8
- Cancelling Communication..... 3-10
- Using the Address Book..... 3-13
- Using One-touch Keys 3-22
- Dialing the Same Receiving System (Redial)..... 3-24

Automatic Send

General transmission using the numeric keys is explained.

Switching to the Send Screen

Ready to send. 2009/05/25 12:30 Text+Photo 200x100dpi [Orig.Img] [FAX Res.]
--

- 1 Press the **FAX** key. Check that the basic send screen is displayed.

NOTE: Depending on the settings, the Address Book screen may appear. In this event, press **Reset** to display the basic screen for sending.

Selection of Transmission Method

- 2 There are two transmission methods - memory transmission and direct transmission. The default is memory transmission.

To select direct transmission, use the following procedure.

- 1 Press the **Function Menu** key.
- 2 Press the Δ or ∇ key to select [FAX Direct TX].
- 3 Press the **OK** key.
- 4 Press the Δ or ∇ key to select [On].
- 5 Press the **OK** key.

Setting for Direct transmission	Description
Off	Starts memory transmission. After originals are scanned into memory, the communication starts.
On	Starts direct transmission. Dials the receiving system, and after the communication has started, originals are scanned.

NOTE: In direct transmission, you can designate only one destination for one transmission.

Memory Transmission (When originals are placed in the document processor)

After originals placed in the document processor are scanned and stored in the memory, the receiving system is dialed. This method is very convenient because you can have originals returned to you without waiting for sending of the originals to be completed. It is suitable for sending multiple-page sheet originals.

Memory Transmission (When originals are placed on the glass surface)

This method is suitable for sending book originals that cannot be placed in the document processor. After originals placed on the glass surface are scanned and stored in the memory, the receiving system is dialed.

NOTE: When continuous scan is set, you can continue with scanning of a next original after an original on the glass surface has been stored in memory. Every time one page is scanned, you perform an operation to allow continued scanning, and after all the originals have been stored in memory, the receiving system is dialed.

Direct Transmission (When originals are placed in the document processor)

After the telephone line has connected with the receiving system, scanning of the originals placed in the document processor starts. When multiple-page originals are placed, each page is scanned after the previous one is sent.

Direct Transmission (When originals are placed on the glass surface)

This method is suitable for sending book originals that cannot be placed in the document processor. After the telephone line has connected with the receiving system, the originals placed on the glass surface are scanned and sent.

NOTE: When continuous scan is set, you can continue with scanning of a next original after an original on the glass surface has been sent. Every time one page is scanned, you perform an operation to allow continued scanning.

Placing Originals

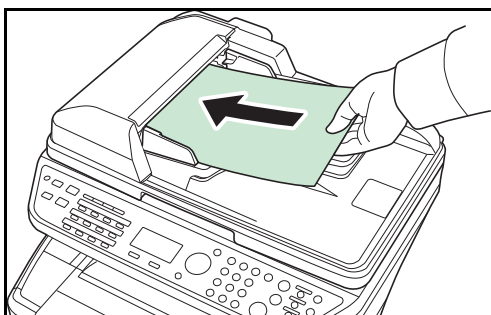

- 3 Place the originals on the glass surface or in the document processor. Refer to the machine's *Operation Guide* for placing originals.

Dial the Receiving System

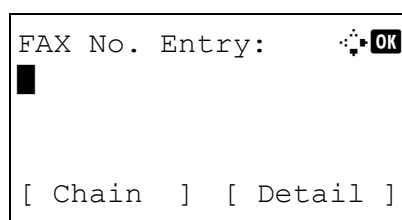

- 4 Enter the fax number of the receiving system using the numeric keys.

NOTE: When you press the numeric keys to enter numbers, the screen changes to the entry screen for the fax number.

NOTE: Up to 64 digits can be entered as the fax number of the receiving system.



Spaces will be automatically inserted if you use \triangleright at the end of the row to advance the cursor before entering more characters.

Use \triangleleft or \triangleright to move the cursor.

To correct the number, press the **Clear** key to delete the digits one by one before reentering the number. To delete all entered digits and return to the default screen, press the **Reset** key.

Address Recall/Pause

Pressing this key adds about three seconds of waiting time during dialing. For example, when dialing the receiving system on an external line, you can use this method to insert a pause before resuming dialing after you dial a specific number.

FAX No. Entry:		
0123456789		
[Chain]	[Detail]	

Make detailed settings for sending as necessary. Press [Detail] (the **Right Select** key) to display the FAX Detail menu. Press the ◀ or ▶ key to select [Sub Address], [Encrypted TX], [TX Start Speed] or [ECM] and change settings, and then press the **OK** key.

Key	Description
Sub Address	To communicate using the sub address, change this setting. For details, refer to <i>Sub Address Communication on page 4-25</i> .
Encrypted TX	To send faxes using encryption, change this setting. For details, refer to <i>Encryption on page 6-24</i> .
TX Start Speed	To change the transmission start speed, change this setting. Select the speed from 33,600 bps, 14,400 bps, and 9,600 bps.
ECM	ECM (error correction mode) is a function to automatically resend an image that has not been correctly sent or received due to the effects of noise on the telephone line during transmission. To change the ECM communication setting, change this setting.

On Hook

Press this key to connect to the telephone line.

When the FAX number has been entered, the machine starts dialing to the receiving system.

After pressing this key, you can dial the number of the receiving system using the numeric keys. For details, refer to *Manual Send on page 4-8*.

Dialing methods without using the numeric keys

- Using the Address Book (*Refer to page 3-13*.)
- Using One-touch keys (*Refer to page 3-22*.)
- Manual Redial (recall) (*Refer to page 3-24*.)

NOTE: In addition to fax, you can include e-mail transmission and/or folder (SMB/FTP) transmission in a single transmission job (Multi Sending). For details, refer to *Sending in the Operation Guide* for the machine.

Selecting the Resolution

- 5 Select the resolution suitable for sending originals.
 - 200 × 100 dpi (Normal): when sending originals with standard size characters
Typical character size: 10.5 point (example: Resolution Resolution)
 - 200 × 200 dpi (Fine): when sending originals with relatively small characters and thin lines
Typical character size: 8 point (example: Resolution Resolution)
 - 200 × 400 dpi (Super Fine): when sending originals with minute characters and lines
Typical character size: 6 point (example: Resolution Resolution)
 - 400 × 400 dpi (Ultra Fine): when sending originals with minute characters and lines more finely
Typical character size: 6 point (example: Resolution Resolution)

NOTE: The default setting is 200 × 100 dpi (Normal).

The higher the resolution, the clearer the image. However, higher resolution also means longer send times. Normally, 400 × 400 dpi (Ultra Fine) is recommended.

The machine does not support resolution of 300 × 300 dpi when sending faxes. If you have selected 300 × 300 dpi, the machine sends faxes after lowering the resolution to 200 × 200 dpi (Fine).

The scan resolution should be equal to or higher than the fax resolution. If the selected resolutions are not in this condition, the machine automatically adjusts the resolution and changes the selection.

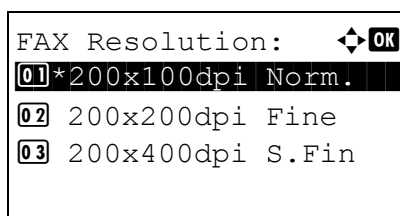

- 1 Press the **Function Menu** key.
- 2 Press the Δ or ∇ key to select [FAX Resolution].
- 3 Press the **OK** key.
- 4 Press the Δ or ∇ key to select the desired resolution.
- 5 Press the **OK** key.

IMPORTANT:

- If you select a high resolution, the image becomes clearer. However, the higher the resolution is, the longer the send time is.
- When you send originals at a resolution of 200 × 400 dpi (Super Fine) or higher, the fax machine on the receiving system needs to be capable of receiving the originals at such image quality. When the receiving system does not have such capability, originals are sent at an image quality of 200 × 200 dpi (Fine).

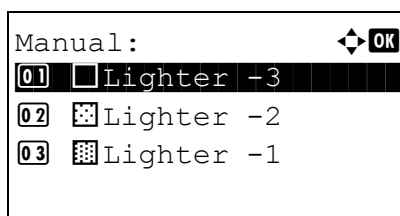
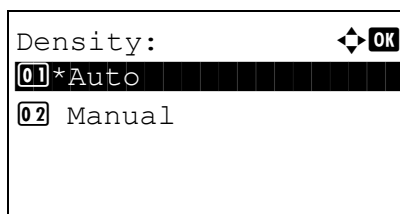
Selecting the Density**6** Adjusting the density when scanning originals

- Manual (-3 to +3): You can adjust the density using seven levels.
- Auto: The optimal density is chosen according to the density of the originals.

- 1 Press the **Function Menu** key.
- 2 Press the Δ or ∇ key to select [Density].
- 3 Press the **OK** key.
- 4 Press the Δ or ∇ key to select [Auto] or [Manual].
- 5 Press the **OK** key. Proceed to the next step if you selected [Manual] in step 4.
- 6 Press the Δ or ∇ key to select the desired density.

- 7 Press the **OK** key.

Send Start

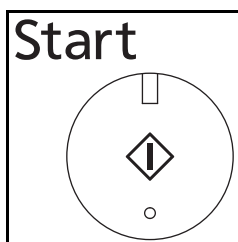

- 7 Press the **Start** key. Transmission begins.

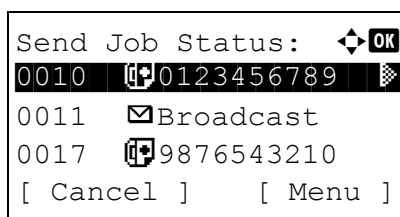
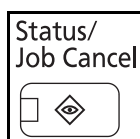

Checking the Send Status

- 1 Press the **Status/Job Cancel** key.
- 2 Press the Δ or ∇ key to select [Send Job Status].
- 3 Press the **OK** key. A list of send job statuses appears.

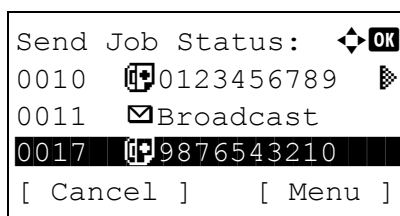

Cancelling the Transmission

- 1 In the above screen for checking send jobs, press the Δ or ∇ key to select the job you want to cancel.
- 2 Press [Cancel] (the **Left Select** key).
- 3 Press [Yes] (the **Left Select** key). This cancels the transmission.

NOTE: Pressing the **Stop** key on the operation panel while originals are being scanned cancels the transmission.

FAX Automatic Reception

When using this machine as a FAX-dedicated machine that does not receive telephone calls, set the machine to FAX-dedicated reception. No special operation is required when receiving faxes.

NOTE: When you are receiving DRD service from a telephone company, change the reception method to [Auto (DRD)]. For details, refer to *DRD Reception on page 6-13*.

Reception Method

This machine allows the following five reception methods.

- Auto (Normal)
- Auto (FAX/TEL) (*Refer to page 6-2.*)
- Auto (TAD) (*Refer to page 6-4.*)
- Auto (DRD) (*Refer to page 6-13.*)
- Manual (*Refer to page 4-9.*)

Checking and Changing the Reception Method

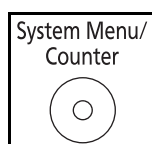

- 1** Press the **System Menu/Counter** key.
- 2** Press the Δ or ∇ key to select [FAX].
- 3** Press the **OK** key.
- 4** Press the Δ or ∇ key to select [Reception].
- 5** Press the **OK** key.
- 6** Press the Δ or ∇ key to select [RX Settings].
- 7** Press the **OK** key.
- 8** Press the Δ or ∇ key to select [Auto(Normal)].
- 9** Press the **OK** key.

Reception Starts

- 1 When a fax has been sent to you, the machine rings the registered number of times, and then starts receiving the fax.

After reception has started, the **Receive** indicator blinks.

NOTE: You can change the number of times the ringing tone rings. (Refer to *Rings* on page 6-6.)

To cancel the reception, refer to *Cancelling Transmission (Disconnection of Communication)* on page 3-11.

3

Reception Print

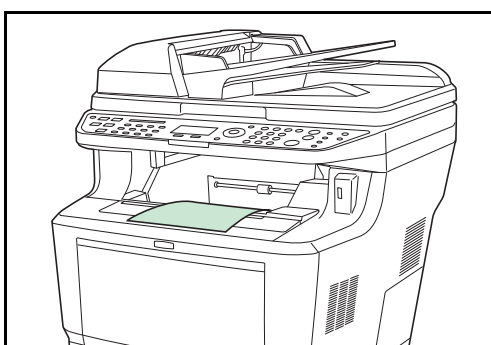

- 2 Received originals are output on the top tray with the print side facing downward. Up to 500 sheets of plain paper (80 g/m²) can be held on the top tray. However, the number of sheets varies with the condition of the paper to be used.

IMPORTANT:

- When the number of sheets to be printed exceeds the number of sheets that can be held, remove all the paper on the top tray.
 - Even if the machine is not capable of printing due to paper running out or a paper jam, it can still receive faxes (memory reception).
-

Memory Reception

When the machine cannot print a fax due to paper running out or a paper jams, it temporarily stores originals that have been sent in the image memory. When the machine returns to the printable state, printing starts.

During memory reception, FAX Reception Printing Jobs are displayed on Printing Jobs of the Status screen. To print the received originals, supply paper or remove jammed paper.

NOTE: For the Status screen, refer to the machine's *Operation Guide*.

Cancelling Communication

The method for cancelling communication with this machine differs depending on the transmission method (memory transmission or direct transmission) and communication form. Methods of cancelling in various cases are explained here.

Cancelling Memory Transmission (while originals are being scanned)

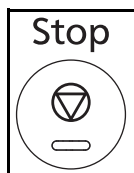

During memory transmission, to cancel scanning of originals, press the **Stop** key on the operation panel. Scanning of originals is canceled, and the originals are ejected. When originals remain in the document processor, take them out from the original output table.

Cancelling Memory Transmission (during communication)

During memory transmission, to cancel communication after it has started following the completed scanning of originals, use the following procedure.

NOTE: If user management is set to On, the administrator or the user who performs the memory transmission can be canceled the job.

You can cancel transmission by disconnecting the telephone line. For details, refer to *Cancelling Transmission (Disconnection of Communication)* on page 3-11.

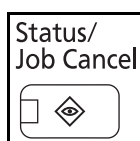

- 1 Press the **Status/Job Cancel** key.
- 2 Press the Δ or ∇ key to select [Send Job Status].
- 3 Press the **OK** key.
- 4 Press the Δ or ∇ key to select the job you want to cancel.
- 5 Press [Cancel] (the **Left Select** key).
- 6 Press [Yes] (the **Left Select** key). Communication is canceled.

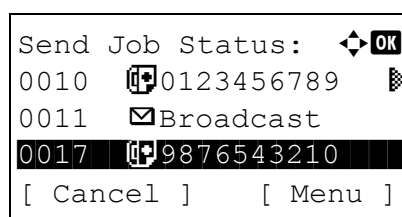

NOTE: Canceling is also possible by pressing [Menu] (the **Right Select** key), then selecting [Cancel Job] and pressing the **OK** key.

Cancelling and Sending Delayed Transmissions (Queued)

To cancel delayed transmissions that are queued, or to send delayed transmissions immediately rather than waiting for the specified time, use the procedure below.

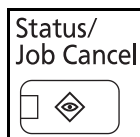

- 1 Press the **Status/Job Cancel** key.
- 2 Press the Δ or ∇ key to select [Scheduled Job].
- 3 Press the **OK** key.
- 4 Press the Δ or ∇ key to select the job you want to cancel. Or, select the job you want to send immediately.
- 5 Press [Menu] (the **Right Select** key).
- 6 Press the Δ or ∇ key to select [Cancel Job]. Or, select [Start Now] to send the job immediately.
- 7 Press the **OK** key.
- 8 Press [Yes] (the **Left Select** key). Communication is canceled. Or, communication starts if sending the job immediately.

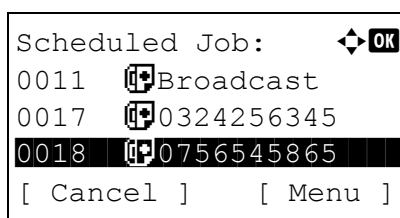

Cancelling Direct Transmission

During direct transmission, to cancel communication during transmission, press the **Stop** key on the operation panel. The originals that have been scanned are ejected, and the screen returns to the default screen for sending. When originals remain in the document processor, take them out.

Cancelling Transmission (Disconnection of Communication)

When you cancel sending or receiving by disconnecting the telephone line during communication, use the following procedure.

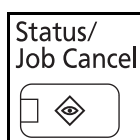

- 1 Press the **Status/Job Cancel** key.
- 2 Press the Δ or ∇ key to select [FAX].
- 3 Press the **OK** key.

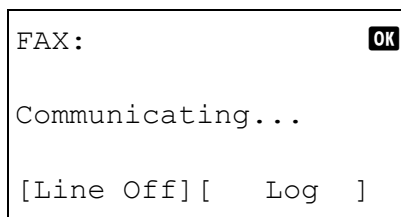

4 Press [Line Off] (the **Left Select** key).

5 Press [Yes] (the **Left Select** key). This disconnects the line in communication.

Canceling Polling or Bulletin Board Transmissions

To cancel a polling or bulletin board transmission, delete the polling transmission original saved in the polling box. For information on how to delete the saved original, refer to *Deleting Originals in a Polling Box* on page 4-40.

Using the Address Book

You can select the FAX destination from the Address Book.

Registering a New Destination

You can register new destinations to the Address Book. There are two registration methods - contact registration; and, group registration for registering several contact registrations as a unit.

Contact Registration (fax)

Up to 100 destinations can be registered. Destination name, fax number, sub address communication, encryption, transmission start speed, and ECM communication can be registered for each destination.

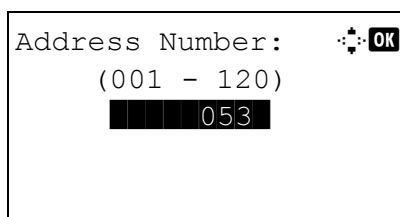
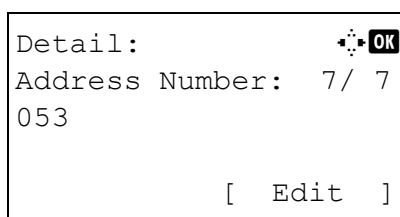
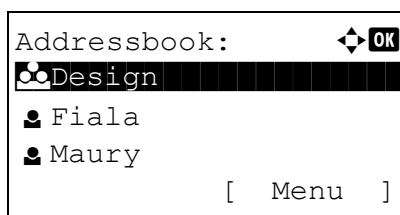

- 1 Press the **System Menu/Counter** key.
- 2 Press the Δ or ∇ key to select [Edit Destination].
- 3 Press the **OK** key.
- 4 Press the Δ or ∇ key to select [Addressbook].
- 5 Press the **OK** key.
- 6 Press [Menu] (the **Right Select** key).
- 7 Press the Δ or ∇ key to select [Add Address].
- 8 Press the **OK** key.
- 9 Press the Δ or ∇ key to select [Contact].
- 10 Press the **OK** key.
- 11 Press the \triangleleft or \triangleright key to select [Address Number].
- 12 Press [Edit] (the **Right Select** key).
- 13 Use the numeric keys to enter any address number between 001 and 120.
- 14 Press the **OK** key.

NOTE: An address number is an identification number for each destination. You can select any available number out of 120 numbers - 100 for individuals and 20 for groups.

```

Detail:                               [OK]
Contact Name      1/ 7
Sally

[ Edit ]

```

15 Press the < or > key to select [Contact Name].

```

Contact Name:                          [OK]
Sally█
                                     ▲
                                     ABC
[ Text ]

```

16 Press [Edit] (the **Right Select** key).

17 Use the numeric keys to enter the destination name to be displayed in the Address Book. Up to 32 characters can be entered.

NOTE: For details on character entry, refer to *Specifications (Fax function) on Appendix-6*.

```

Detail:                               [OK]
[FAX] FAX Number:      3/ 7
0667640000

[ Edit ]

```

18 Press the **OK** key.

19 Press the < or > key to select [FAX Number].

```

FAX No. Entry:                        [OK]
0667640000█
                                     ▲
[ Detail ]

```

20 Press [Edit] (the **Right Select** key).

21 Use the numeric keys to enter the destination FAX number. Up to 32 digits can be entered.

NOTE: For details on character entry, refer to *Specifications (Fax function) on Appendix-6*.

Address Recall/Pause

Pressing this key adds about three seconds of waiting time during dialing. For example, when dialing the receiving system on an external line, you can use this method to insert a pause before resuming dialing after you dial a specific number.

```

FAX Detail:                          [OK]
Sub Address:      1/ 4
1234567890123
*****
[ Edit ]

```

22 Press [Detail] (the **Right Select** key) and then use the < or > key to select [Sub Address]. If you do not use Sub Address, proceed to step 28.

23 Press [Edit] (the **Right Select** key).



- 24** Use the numeric keys to enter the sub address. Up to 20 digits can be entered.

NOTE: A sub address can be entered using numerals from 0 to 9, spaces, and characters "#" and "*".

- 25** Press the **OK** key.

- 26** Use the numeric keys to enter the sub address password. Up to 20 digits can be entered.

NOTE: A sub address password can be entered using numerals from 0 to 9, spaces, and characters "#" and "*".

- 27** Press the **OK** key.

- 28** Use the \triangleleft or \triangleright key to select [Encrypted TX]. If you do not use Encrypted TX, proceed to step 38.

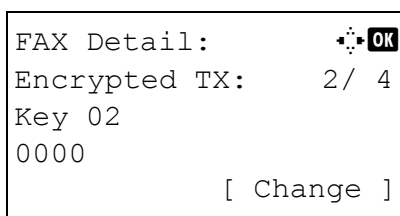

- 29** Press [Change] (the **Right Select** key).

- 30** Press the \triangle or ∇ key to select [On].

- 31** Press the **OK** key.

- 32** Press the \triangle or ∇ key to select the desired encryption key number.

- 33** Press the **OK** key.

NOTE: Register the encryption key in advance. For details, refer to *Registering an Encryption Key on page 6-25*.

- 34** Press the \triangle or ∇ key to select [On] or [Off].

- 35** Press the **OK** key. Proceed to the next step or step 38 when [On] or [Off] is selected in step 34, respectively.

- 36** Use the numeric keys to enter the encryption box number (4 digits).

- 37** Press the **OK** key.

FAX Detail:	OK
TX Start Speed: 3/ 4	
33600bps	
[Change]	

- 38** Use the ◀ or ▶ key to select [TX Start Speed] or [ECM] and change settings as necessary, and then press the **OK** key.

Item	Description
TX Start Speed	To change the transmission start speed, change this setting. Select the speed from 33,600 bps, 14,400 bps, and 9,600 bps.
ECM	ECM (error correction mode) is a function to automatically resend an image that has not been correctly sent or received due to the effects of noise on the telephone line during transmission. To change the ECM communication setting, change this setting.

- 39** Use the ◀ or ▶ key to check if each item was entered correctly.
- 40** Press the **OK** key.
- 41** Press the **OK** key again.
- 42** Use the ◀ or ▶ key to check if the destination was set correctly.
- 43** Press the **OK** key. The destination is added to the Address Book.

Group Registration

You can register several destinations that have been registered to be contacted as a unit. This method is convenient because several destinations can be designated at one time. Up to 20 groups can be registered.

NOTE: Group registration requires destinations that have been registered as contact registration. Perform the necessary contact registration in advance.

- 1** Press the **System Menu/Counter** key.
- 2** Press the Δ or ∇ key to select [Edit Destination].
- 3** Press the **OK** key.
- 4** Press the Δ or ∇ key to select [Addressbook].
- 5** Press the **OK** key.

```

Addressbook: [OK]
Design
  Fiala
  Maury
[ Menu ]

```

6 Press [Menu] (the **Right Select** key).

```

Detail: [OK]
Address Number: 4/ 4
019
[ Edit ]

```

7 Press the Δ or ∇ key to select [Add Address].

8 Press the **OK** key.

9 Press the Δ or ∇ key to select [Group].

10 Press the **OK** key.

11 Press the \triangleleft or \triangleright key to select [Address Number].

```

Address Number: [OK]
(001 - 120)
  053

```

12 Press [Edit] (the **Right Select** key).

13 Use the numeric keys to enter any address number between 001 and 120.

NOTE: An address number is an identification number for each destination. You can select any available number out of 120 numbers - 100 for individuals and 20 for groups.

```

Detail: [OK]
Group Name: 1/ 4
[ Edit ]

```

14 Press the **OK** key.

15 Press the \triangleleft or \triangleright key to select [Group Name].

```

Group Name: [OK]
GUI Section
  ▲
      ABC
[ Text ]

```

16 Press [Edit] (the **Right Select** key).

17 Use the numeric keys to enter the group name to be displayed in the Address Book. Up to 32 characters can be entered.

NOTE: For details on character entry, refer to *Specifications (Fax function) on Appendix-6*.

18 Press the **OK** key.

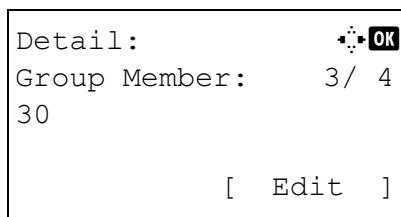

19 Press the ◀ or ▶ key to select [Group Member].

20 Press [Edit] (the **Right Select** key).

21 Press [Menu] (the **Right Select** key).

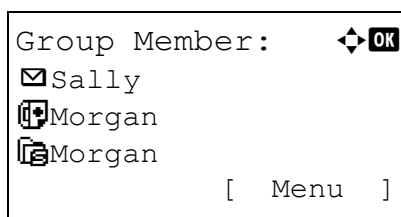

22 Press the ▲ or ▼ key to select [Add Member].

23 Press the **OK** key.

24 Press the ▲ or ▼ key to select the destination (individual) you want to register to the group.

NOTE: You can search for a destination by destination name.

25 Press [Menu] (the **Right Select** key).

26 Press the ▲ or ▼ key to select [Select].

27 Press the **OK** key.

28 To add more destinations, repeat steps 21 to 27.

29 Press the **OK** key.

30 Use the ◀ or ▶ key to check if the group was set correctly.

31 Press the **OK** key. The group is added to the Address Book.

Selecting a Destination from the Address Book

Select a destination registered in the Address Book.

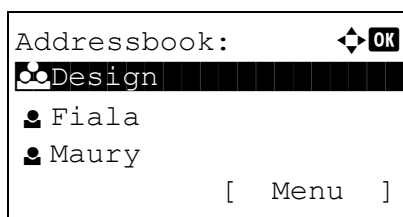
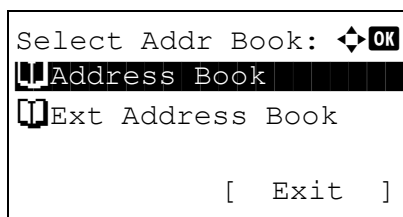
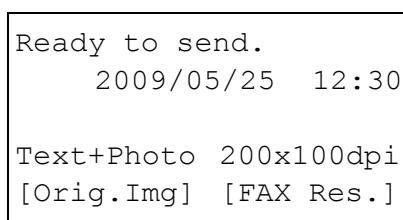

- 1 In the basic screen for FAX, press the **Address Book** key.
- 2 Press the Δ or ∇ key to select [Address Book].
- 3 Press the **OK** key.
- 4 Press the Δ or ∇ key to select the desired destination.
- 5 Press the **OK** key. The selected destination is registered in the destination list.

Searching for a Destination

You can search for a destination registered in the Address Book.

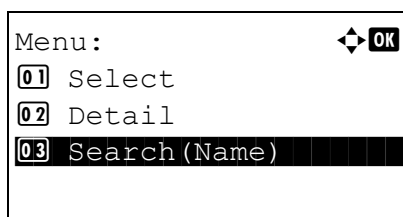

- 1 In the basic screen for sending, press the **Address Book** key.
- 2 Press the Δ or ∇ key to select [Address Book].
- 3 Press the **OK** key.
- 4 Press [Menu] (the **Right Select** key).
- 5 Press the Δ or ∇ key to select [Search(Name)].
- 6 Press the **OK** key.

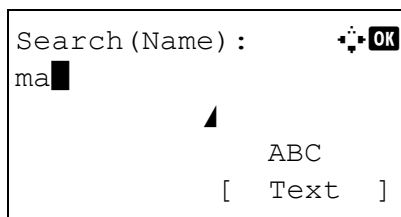

- 7 Use the numeric keys to enter the destination name for which you want to search.

NOTE: For details on character entry, refer to *Specifications (Fax function) on Appendix-6*.

- 8 Press the **OK** key. The search result appears.

Changing/Deleting Registration Contents

You can change or delete the contents of destinations (contact) or groups.

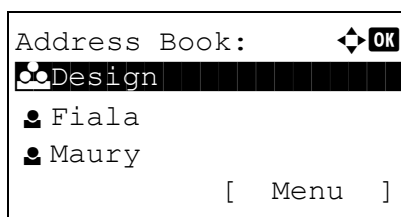

- 1 Press the **System Menu/Counter** key.
- 2 Press the Δ or ∇ key to select [Edit Destination].
- 3 Press the **OK** key.
- 4 Press the Δ or ∇ key to select [Address Book].
- 5 Press the **OK** key.
- 6 Press the Δ or ∇ key to select the destination or group to edit.

- 7 Press [Menu] (the **Right Select** key).

8 When editing the destination of a contact registration

- 1 Press the Δ or ∇ key to select [Detail/Edit].
- 2 Press the **OK** key.
- 3 Change the contents of the destination. For details, refer to steps 11 to 39 in *Contact Registration (fax)*.

When editing a group

- 1 Press the Δ or ∇ key to select [Detail/Edit].
- 2 Press the **OK** key.
- 3 Change the contents of the group. For details, refer to steps 11 to 18 in Group Registration. When adding more destinations to the group, refer to steps 19 to 27 in *Group Registration*.

When deleting the destination of a contact registration or group

- 1 Press the Δ or ∇ key to select [Delete].
- 2 Press the **OK** key.

- 3 Press [Yes] (the **Left Select** key). This deletes the selected destination or group.
- 9 Press the **OK** key.
- 10 Press [Yes] (the **Left Select** key). The change or deletion of the registration contents is reflected on the Address Book.

Printing Address List

You can print the list of destinations registered in the Address Book.

You can sort the list in the order of names or address numbers of the destinations.

- 1 Press the **System Menu/Counter** key.
- 2 Press the Δ or ∇ key to select [Edit Destination].
- 3 Press the **OK** key.
- 4 Press the Δ or ∇ key to select [Print List].
- 5 Press the **OK** key.
- 6 Press the Δ or ∇ key to select [FAX List(Index)] or [FAX List(No.)].
- 7 Press the **OK** key.
- 8 Press [Yes] (the **Left Select** key). The list is printed.

Using One-touch Keys

With **One-touch** keys on the operation panel, you can invoke the Address Book.

Registering a New One-touch Key

You can register the destination (contact or group) in the Address Book to a **One-touch** key. Up to 22 destinations can be registered.

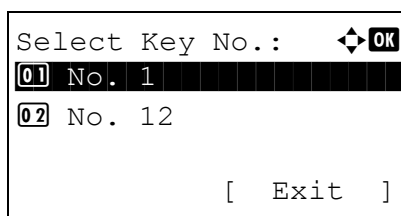
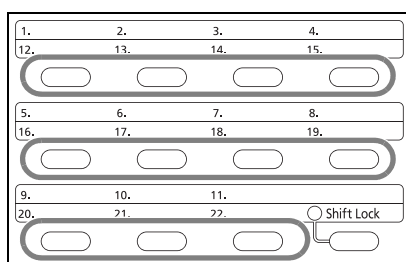

- 1 In the basic screen for FAX, press the **One-touch** key that you want to register and hold it (2 seconds).
- 2 Press the Δ or ∇ key to select the number to which you want to register the destination. Numbers 12 to 22 are the **One-touch** key numbers when the **Shift Lock** key is pressed.
- 3 Press the **OK** key.
- 4 Press the Δ or ∇ key to select the destination (individual or group) you want to register to the **One-touch** key from the Address Book.
- 5 Press the **OK** key. The destination is added to the **One-touch** key.

Selecting a Destination by One-touch Key

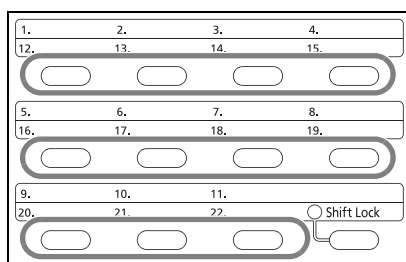

In the destination entry screen, press the **One-touch** key where the destination is registered.

When recalling from **One-touch** keys 12 to 22, press the **Shift Lock** key to turn on the lamp next to the keys, and then press the **One-touch** key where the destination is registered.

Changing/Deleting Registration Contents

You can change the destination registered to a **One-touch** key to another destination, or delete the registration contents of the **One-touch** key.

NOTE: When changing the destination information in the Address Book, the information registered to the **One-touch** key is updated.

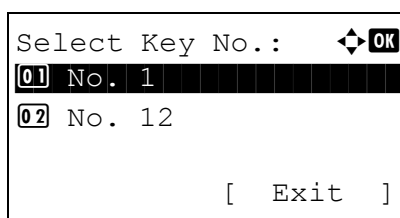
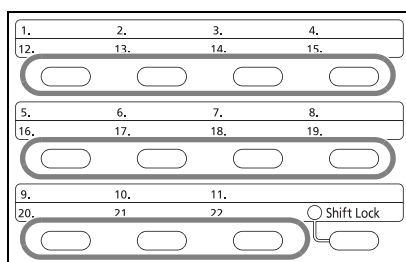

1 In the basic screen for FAX, press the **One-touch** key that you want to change and hold it (2 seconds).

2 Press the Δ or ∇ key to select the number you want to edit.

Numbers 12 to 22 are the **One-touch** key numbers when the **Shift Lock** key is pressed.

3 Press the **OK** key.

4 **When changing the destination to another destination**

1 Press the Δ or ∇ key to select [Edit].

2 Press the **OK** key.

3 Press the Δ or ∇ key to select the new destination (individual or group).

4 Press the **OK** key.

5 Press [Yes] (the **Left Select** key). The destination is registered to the **One-touch** key.

When deleting registration contents

1 Press the Δ or ∇ key to select [Delete].

2 Press the **OK** key.

3 Press [Yes] (the **Left Select** key). This deletes the content registered to the **One-touch** key.

5 Press [Exit] (the **Right Select** key).

Dialing the Same Receiving System (Redial)

Redial is a function allowing you to dial the last entered number once again.

Automatic Redial

This function automatically redials a receiving system that does not respond when you try to send fax.

No particular setting is required for automatic redial. Because the machine redials repeatedly at a regular interval, you do not need to worry even when the communication by the receiving system is prolonged.

NOTE: When using direct transmission, the machine does not automatically redial.

You can change the number of automatic redials from between 0 and 14. For details, refer to *Retry Times on page 6-8*. You cannot send delayed transmission immediately while the machine is waiting for redial.

Manual Redial (Recall)

Use this when the receiving system does not respond when you have tried to send a fax. When you want to send the fax to the same receiving system, press the **Address Recall/Pause** key, and you can call the receiving system you dialed on the destination list.

```
Ready to send.  
      2009/05/25  12:30  
  
Text+Photo 200x100dpi  
[Orig.Img]  [FAX Res.]
```

- 1 Press the **Address Recall/Pause** key. The receiving system you dialed is displayed on the destination list.

NOTE: When the last transmission included multi-address transmissions and computers and e-mail destinations, they are also displayed. If necessary, add or delete the receiving system.

- 2 Press the **Start** key. The transmission will start.

NOTE: Recall information is canceled in the following conditions.

- When you turn the power off
 - When you send a next fax (new recall information is registered)
 - When you log out
-

4 FAX Operation (Advanced)

This chapter explains the method to effectively use FAX.

- Delayed Transmission 4-2
- Broadcast Transmission 4-4
- Standby Transmission 4-5
- Interrupt Send 4-6
- Chain Dial 4-7
- Manual Send 4-8
- Manual Reception 4-9
- Remote Switch Function 4-11
- Printing/Forwarding Received Documents (Memory Forwarding)..... 4-13
- Sub Address Communication 4-25
- Sub Address Box Function 4-27
- Program Dial 4-32
- Polling Communication..... 4-33
- Account Management 4-42
- Other Convenient Functions..... 4-46

Delayed Transmission

When you have set a transmission start time, this function automatically sends originals at the preset time. You can use delayed transmission together with the broadcast transmission function, etc.

The method for sending originals to one destination after setting the start time is explained here.

IMPORTANT: If the current time is incorrect, the communication cannot be performed correctly at the specified time. If the indicated current time is incorrect, adjust the time correctly. In this case, adjust the time. For details, refer to *Date and Time Entry on page 2-6*.

NOTE: You cannot select direct transmission.

Set the time from between 00:00 and 23:59 in one-minute increments.

Together with standby transmission and interrupt send, you can set up to 30 destinations for delayed transmission.

When two or more delayed transmissions are set for the same time, the communication will start in the order that the delayed transmissions have been set. When delayed transmissions have been set in reverse order, however, sending of originals to be sent to the same destination is prioritized over the ones to be sent to different destinations.

You can cancel a delayed transmission any time before the specified transmission time. You can also send a delayed transmission before the specified time. (Refer to *Cancelling and Sending Delayed Transmissions (Queued) on page 3-11*.)

You can change destinations of a delayed transmission any time before the specified transmission time. (Refer to *Checking Scheduled Job on page 4-3*.)

Batch Transmission Function

When fax originals to be sent to the same destination are set to the same transmission start time with delayed transmission, you can send up to 10 groups of originals using batch transmission. This function prevents repeated communication to the same destination and reduces the communication cost.

NOTE: You cannot send originals as a batch transmission in the case of direct transmission.

You cannot select destinations using a combination of direct entry and One-touch keys.

In the case of broadcast transmission, when you have set two or more groups of originals to the same transmission start time, and each group includes the same receiving system fax number, you cannot send the originals as a batch transmission.

When the transmission start time has come, and there are fax originals waiting for redial to the same receiving system, the waiting originals are also sent together as a batch transmission.

When job accounting is ON, only the originals with the same account ID set using delayed transmission are sent as a batch transmission.

- 1 Press the **FAX** key.
- 2 Place the originals.
- 3 Press the **Function Menu** key.
- 4 Press the Δ or ∇ key to select [FAX Delayed TX].
- 5 Press the **OK** key.
- 6 Press the Δ or ∇ key to select [On].
- 7 Press the **OK** key.

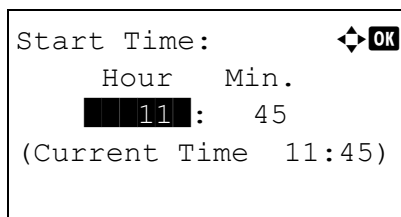

8 Press the < or > key to move the cursor position, and enter hours and minutes.

9 Press the **OK** key.

10 Set the destination, and press the **Start** key.

Originals are scanned, and transmission begins at the preset time.

Checking Scheduled Job

You can check the details of a scheduled job.

NOTE: For cancelling memory transmission or sending a scheduled job immediately, refer to *Cancelling Memory Transmission (during communication)* on page 3-10.

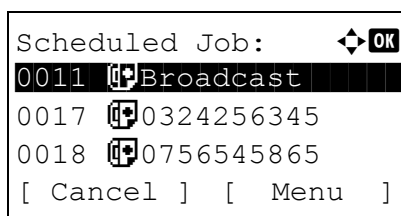

1 Press the **Status/Job Cancel** key.

2 Press the Δ or ∇ key to select [Scheduled Job].

3 Press the **OK** key.

4 Press the Δ or ∇ key to select the job you want to check.

5 Press [Menu] (the **Right Select** key).

6 Press the Δ or ∇ key to select [Detail].

7 Press the **OK** key.

8 Press the < or > key to check the details of the job.

9 Press the **OK** key.

Broadcast Transmission

This function allows you to send the same originals to several destinations in one operation. The machine stores (memorizes) originals to send in memory temporarily, and automatically repeats dialing and transmission to the set destination afterwards.

NOTE: You can send originals to up to 100 destinations in one operation.

You can use this function together with sub address communication and delayed transmission.

When direct transmission has been selected, it changes to memory transmission at the time of transmission.

1 Press the **FAX** key.

2 Place the originals.

3 Select the destination.

Enter the fax number

1 Use the numeric keys to enter the fax number.

2 Press the **OK** key. You can enter the next fax number.

Select the destination from the Address Book

1 Press the **Address Book** key.

2 Press the Δ or ∇ key to select the desired destination.

3 Press the **OK** key. You can select the destination by pressing the **Address Book** key.

Select the destination from the One-touch keys

Press all the **One-touch** keys to which necessary destinations are registered.

NOTE: For details of the Address Book, refer to *Using the Address Book on page 3-13*. For details of One-touch keys, refer to *Using One-touch Keys on page 3-22*.

You can select destinations using a combination of direct entry, the Address Book and **One-touch** keys.

4 After selecting all the destinations, press the **Start** key. Transmission begins.

NOTE: In addition to fax, you can include e-mail transmission and/or folder (SMB/FTP) transmission in a single transmission job (Multi Sending). For details, refer to *Sending in the Operation Guide* for the machine.

Standby Transmission

During a communication, you can scan originals and schedule a next transmission. When the first communication is completed, the machine automatically starts the scheduled next transmission. When using standby transmission, you do not need to wait when a communication has prolonged due to broadcast transmission.

NOTE: Together with delayed transmission, up to 30 transmissions can be scheduled.

You can use other functions such as broadcast transmission.

- 1** Press the **FAX** key.
- 2** Place the originals.
- 3** Select the destination, and set transmitting functions if you want to use any.
- 4** Press the **Start** key. Scanning of the originals starts, and the next transmission is scheduled.
- 5** When the communication is completed, the scheduled transmission will begin.

Interrupt Send

During communication, when you scan originals by selecting direct transmission, you can use interrupt send. Even when the communication is prolonged due to broadcast transmission or a next transmission being scheduled, the machine will first send originals for which interrupt send has been set.

NOTE: When the number of standby transmissions and delayed transmissions has already reached 30, you cannot use interrupt send.

Depending on the timing of the interruption, you may not be able to interrupt transmission immediately.

- 1 Press the **FAX** key.
- 2 Load the originals to be sent using Interrupt Send.
- 3 Press the **Function Menu** key.
- 4 Press the Δ or ∇ key to select [FAX Direct TX].
- 5 Press the **OK** key.
- 6 Press the Δ or ∇ key to select [On].
- 7 Press the **OK** key.
- 8 Set the destination, and press the **Start** key. The panel display will switch to the standby screen, and the transmission will start when transmission becomes possible.

NOTE: For operation of direct transmission, refer to *Selection of Transmission Method on page 3-2*.

To cancel transmission while waiting for interrupt send, press the **Stop** key on the operation panel. For details, refer to *Cancelling Communication on page 3-10*.

- 9 When the interrupt send is completed, the canceled communication and standby transmission will automatically resume.

Chain Dial

Chain dial is a function that allows you to dial by linking fax numbers of the receiving systems with a chain number created with a number common to several destinations. By setting a toll free number and an area code to a chain number, you do not need to enter such numbers for each transmission.

NOTE: You can use the chain number at the head of the fax number of the receiving system.

As an example, when using '212' as the chain number

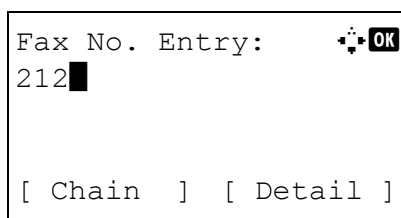

- 1 Press the **FAX** key.
- 2 Place the originals.
- 3 Enter '212' using the numeric keys.
- 4 Press [Chain] (the **Left Select** key).

- 5 Enter the fax number to connect to the chain number.

Use the numeric keys to enter a fax number

- 1 '212' is already entered, and then enter the fax number.
- 2 After entering all the destinations, press the **OK** key.

Select fax number from the Address Book

- 1 Press the **Address Book** key.
- 2 Press the Δ or ∇ key to select [Address Book] or [Ext Address Book].

NOTE: If an expansion address book is not registered, the address book selection screen will not appear.

- 3 Press the **OK** key.
- 4 Press the Δ or ∇ key to select the desired destination.
- 5 Press the **OK** key. '212' is automatically added to the destination.

Select fax number from One-touch key

Select the destination from **One-touch** keys. The chain number '212' is automatically added to the destinations.

- 6 Press the **Start** key. Transmission begins.

Manual Send

This method allows you to send originals by pressing the **Start** key after confirming that the telephone line has connected to the receiving system. Connecting a telephone set (commercially available product) to this machine enables you to talk with the person at the receiving system before sending originals.

Using after Confirming the Connection to the Receiving System

You can send originals after confirming that the telephone line has connected to the receiving system.

- 1 Press the **FAX** key.
- 2 Set the originals.
- 3 Press the **On Hook** key.
- 4 Use the numeric keys to enter the number of the receiving system.

NOTE: To cancel the operation, press the **On Hook** key or **Reset** key.

- 5 When you hear the fax tone, the telephone line has connected to the receiving system. Press the **Start** key. Transmission begins.

Using a Telephone to Send

When you want to talk to the person at the receiving system or the receiving system needs to switch to fax, use this method to send originals.

- 1 Set the originals.
- 2 Lift the handset, and dial the number of the receiving system.
- 3 Check if the telephone line has connected to the fax of the receiving system.

When you hear the fax tone

The receiving system is on fax.

- 1 Press the **FAX** key.
- 2 Press the **On Hook** key.
- 3 Press the **Start** key. Transmission begins.

When you hear a voice from the receiving system

The telephone line has connected to the telephone of the receiving system. When the conversation is over, follow steps 1 to 3 above.

- 4 When sending starts (when the **Send/Receive** indicator on the operation panel starts blinking), return the handset to its original position.

Manual Reception

This method allows you to receive faxes by operating this machine after confirming that the telephone line has connected to the sending system. Connecting a telephone set (commercially available product) to this machine enables you to receive originals after talking to the person at the sending system.

NOTE: FAX Automatic Reception has been preset for the receiving mode of this machine. To use Manual Reception, you need to change the receiving mode to Manual Reception. To change to manual mode, refer to *Receiving Mode on page 6-9*.

Receiving after Confirming Connection to the Sending System

You can receive originals after confirming by sound that the telephone line has connected to the sending system.

- 1 When there is an incoming call, the machine makes a ringing tone.
- 2 Press the **FAX** key.
- 3 Press the **On Hook** key.
- 4 Press [ManualRX] (the **Left Select** key).
- 5 After the sending side has started transmission, the machine starts receiving the originals.

Using the Telephone to Receive

Use this method when you want to receive originals after talking to the person at the sending system.

- 1 When there is an incoming call, the telephone connected to the machine makes a ringing tone.
- 2 Lift the handset of the telephone.
- 3 Check if the telephone line has connected to the fax of the sending system.

When you hear the fax tone

The sending system is on fax.

- 1 Press the **Status/Job Cancel** key.
- 2 Press the **On Hook** key.
- 3 Press [ManualRX] (the **Left Select** key).
Reception will start.

NOTE: When using a telephone set that can send tone signals, use the telephone to start the reception of originals with the remote switch function. (Refer to *Remote Switch Function on page 4-11*.)

When you hear a voice from the receiving system

The telephone line has connected to the telephone of the sending system. When the conversation is over, follow steps 1 to 2 above.

After the sending system has started transmission, the machine starts receiving originals.

- 4** When reception starts (when the **Send/Receive** indicator on the operation panel starts blinking), return the handset to its original position.

Remote Switch Function

You can start fax reception by operation from the connected telephone set. This function is convenient for using this machine and a telephone set (commercially available product) in combination installed at places distant from each other.

To start fax reception by operation from the connected telephone set, use the following operation.

NOTE: In order to use remote switch, it is necessary to connect the tone signal-sending telephone set (commercially available product) to the machine. However, even if it is a tone signal-sending telephone set, this function may not be used satisfactorily depending on the type of telephone set. For details, contact our agent or the store where you purchased this machine.

How to Register Remote Switch Dial

Remote switch dial is set to 55 at the factory, but you can change the dial number.

- 1 Press the **System Menu/Counter** key.
- 2 Press the Δ or ∇ key to select [FAX].
- 3 Press the **OK** key.
- 4 Press the Δ or ∇ key to select [Reception].
- 5 Press the **OK** key.
- 6 Press the Δ or ∇ key to select [Remote SW Dial].
- 7 Press the **OK** key.
- 8 Use the numeric keys to enter the number to be newly registered (00 to 99).
- 9 Press the **OK** key.

Using the Remote Switch Dial

To start fax reception by operation from the connected telephone set, use the following operation.

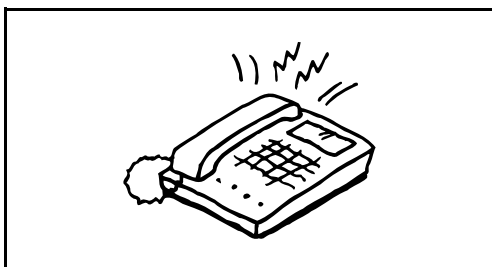

- 1 The connected telephone set makes a ringing tone.

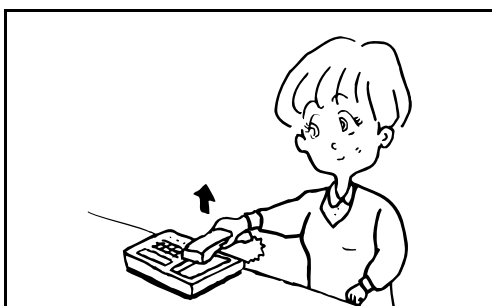

- 2 Lift the handset of the telephone.

- 3 When you hear the fax tone from the handset, enter the two-digit remote switch dial number using the dial button on the telephone set.

NOTE: The remote switch dial is set to 55 at the factory.

- 4 The telephone line switches to the machine, and reception starts.

Printing/Forwarding Received Documents (Memory Forwarding)

When you have received a fax, you can forward the received image to other fax machines, computers, and Sub Address Boxes, or print the image.

Type of Forwarding Destination and Forwarding Requirements

Only one forwarding destination can be specified. When forwarding is set to [On], all received documents will be forwarded to the specified destination.

Type of Forwarding Destination

You can forward the document to other fax machines or Sub Address Boxes, or for e-mail transmission or folder (SMB or FTP) transmission.

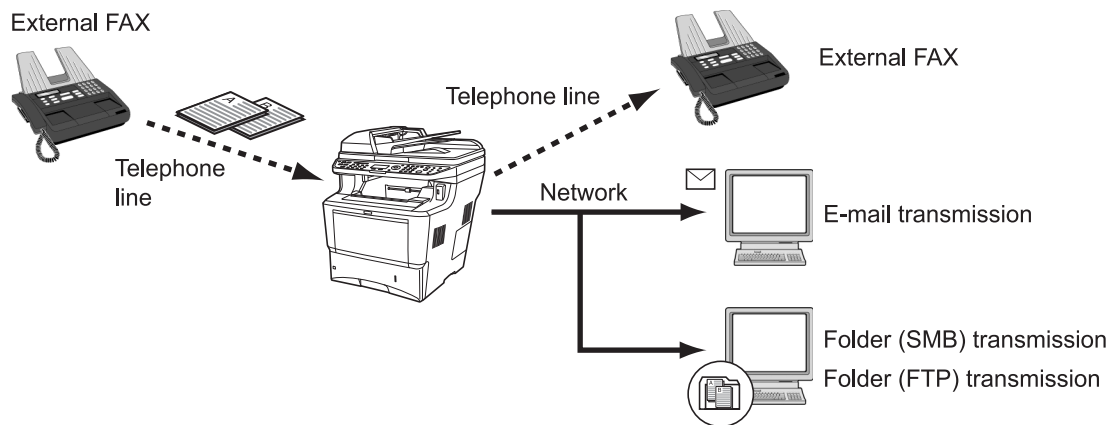

Setting Forwarding

Use the procedure below to set forwarding.

- 1 Press the **System Menu/Counter** key.
- 2 Press the Δ or ∇ key to select [FAX].
- 3 Press the **OK** key.
- 4 Press the Δ or ∇ key to select [Reception].
- 5 Press the **OK** key.
- 6 Press the Δ or ∇ key to select [Forward Settings].
- 7 Press the **OK** key.
- 8 Press the Δ or ∇ key to select [Forwarding].
- 9 Press the **OK** key.
- 10 Press the Δ or ∇ key to select [On] or [Off].
- 11 Press the **OK** key.

Registering Forwarding Destination

Use the procedure below to register a forwarding destination.

- 1 Press the **System Menu/Counter** key.
- 2 Press the Δ or ∇ key to select [FAX].
- 3 Press the **OK** key.
- 4 Press the Δ or ∇ key to select [Reception].
- 5 Press the **OK** key.
- 6 Press the Δ or ∇ key to select [Forward Settings].
- 7 Press the **OK** key.
- 8 Press the Δ or ∇ key to select [Forward Dest.].
- 9 Press the **OK** key.
- 10 Press the Δ or ∇ key to select [Register].
- 11 Press the **OK** key.

12 Selecting Forwarding Destination from Address Book

- 1 Press the Δ or ∇ key to select [Address Book].
- 2 Press the **OK** key.
- 3 Press the Δ or ∇ key to select [Address Book] or [Ext Address Book].
- 4 Press the **OK** key.
- 5 Press the Δ or ∇ key to select the destination (individual) you want to register as a forwarding destination.

Entering Forwarding Destination Directly

- 1 Press the Δ or ∇ key to select [Address Entry].
- 2 Press the **OK** key.
- 3 Press the Δ or ∇ key to select [FAX], [E-mail], [Folder(SMB)] or [Folder(FTP)].
- 4 Press the **OK** key.
- 5 Use the numeric keys to enter the address to be registered as a forwarding destination. Up to 128 digits can be entered.

NOTE: For details on character entry, refer to *Specifications (Fax function) on Appendix-6*.

If you select [Folder(SMB)] or [Folder(FTP)], enter the host name, path, login user name, login password and encryption method of the forwarding destination.

- 13 Press the **OK** key.

Changing and Deleting Registration Contents

Use the procedure below to change or delete registration contents.

- 1 Press the **System Menu/Counter** key.
- 2 Press the Δ or ∇ key to select [FAX].
- 3 Press the **OK** key.
- 4 Press the Δ or ∇ key to select [Reception].
- 5 Press the **OK** key.
- 6 Press the Δ or ∇ key to select [Forward Settings].
- 7 Press the **OK** key.
- 8 Press the Δ or ∇ key to select [Forward Dest.].
- 9 Press the **OK** key.
- 10 Press the Δ or ∇ key to select [Confirmation].
- 11 Press the **OK** key.
- 12 Press the **OK** key again.

13 Changing Forwarding Destination

- 1 Press the Δ or ∇ key to select [Edit].
- 2 Press the **OK** key.
- 3 Change the forwarding destination.
- 4 Press the **OK** key. The forwarding destination is changed.

Deleting Forwarding Destination

- 1 Press the Δ or ∇ key to select [Delete].
- 2 Press the **OK** key.
- 3 Press [Yes] (the **Left Select** key). The forwarding destination is deleted.

- 14 Press [Exit] (the **Right Select** key).

Forwarding Time Setting

Register the start time and end time between which forwarding is enabled.

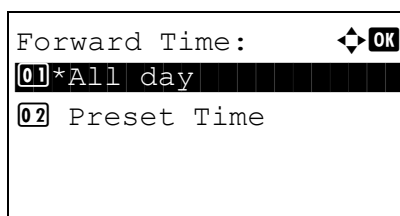

- 1 Press the **System Menu/Counter** key.
- 2 Press the Δ or ∇ key to select [FAX].
- 3 Press the **OK** key.
- 4 Press the Δ or ∇ key to select [Reception].
- 5 Press the **OK** key.
- 6 Press the Δ or ∇ key to select [Forward Settings].
- 7 Press the **OK** key.
- 8 Press the Δ or ∇ key to select [Forward Time].
- 9 Press the **OK** key.
- 10 Press the Δ or ∇ key to select [All day] or [Preset Time].
- 11 Press the **OK** key. Proceed to the next step if you selected [Preset Time] in step 10.
- 12 Press the \triangleleft or \triangleright key to move the cursor position, and enter the hours and minutes of the start time.
- 13 Press the **OK** key.
- 14 Press the \triangleleft or \triangleright key to move the cursor position, and enter the hours and minutes of the end time.
- 15 Press the **OK** key.

NOTE: Enter the time on the 24 hours system.

File Format Setting (for Each Requirement)

If you are sending the file as an E-mail attachment or transferring it to a folder (SMB or FTP), select PDF or TIFF as the file format.

- 1 Press the **System Menu/Counter** key.
- 2 Press the Δ or ∇ key to select [FAX].
- 3 Press the **OK** key.
- 4 Press the Δ or ∇ key to select [Reception].
- 5 Press the **OK** key.

- 6 Press the Δ or ∇ key to select [Forward Settings].
- 7 Press the **OK** key.
- 8 Press the Δ or ∇ key to select [File Format].
- 9 Press the **OK** key.
- 10 Press the Δ or ∇ key to select [PDF] or [TIFF].
- 11 Press the **OK** key.

E-mail Subject Add. Info Setting

Specify whether any information will be added to the subject of the E-mail. When adding information, you can select either *Sender Name* or *Sender*.

- 1 Press the **System Menu/Counter** key.
- 2 Press the Δ or ∇ key to select [FAX].
- 3 Press the **OK** key.
- 4 Press the Δ or ∇ key to select [Reception].
- 5 Press the **OK** key.
- 6 Press the Δ or ∇ key to select [Forward Settings].
- 7 Press the **OK** key.
- 8 Press the Δ or ∇ key to select [Subject Add.Info].
- 9 Press the **OK** key.
- 10 Press the Δ or ∇ key to select [Off], [Sender Name] or [Sender FAX/Add.].
- 11 Press the **OK** key.

FTP Encrypted TX Setting

Specify whether to use FTP encryption when you send data.

- 1 Press the **System Menu/Counter** key.
- 2 Press the Δ or ∇ key to select [FAX].
- 3 Press the **OK** key.
- 4 Press the Δ or ∇ key to select [Reception].
- 5 Press the **OK** key.
- 6 Press the Δ or ∇ key to select [Forward Settings].
- 7 Press the **OK** key.
- 8 Press the Δ or ∇ key to select [FTP Encrypted TX].
- 9 Press the **OK** key.

- 10 Press the Δ or ∇ key to select [On] or [Off].
- 11 Press the **OK** key.

Print Setting

You can set whether the machine should print received originals when forwarding them.

- 1 Press the **System Menu/Counter** key.
- 2 Press the Δ or ∇ key to select [FAX].
- 3 Press the **OK** key.
- 4 Press the Δ or ∇ key to select [Reception].
- 5 Press the **OK** key.
- 6 Press the Δ or ∇ key to select [Forward Settings].
- 7 Press the **OK** key.
- 8 Press the Δ or ∇ key to select [Print].
- 9 Press the **OK** key.
- 10 Press the Δ or ∇ key to select [On] or [Off].
- 11 Press the **OK** key.

File Name Registration

You can set the file name to be created when forwarding. You can append information such as the date/time and the job number or fax number.

- 1 Press the **System Menu/Counter** key.
- 2 Press the Δ or ∇ key to select [FAX].
- 3 Press the **OK** key.
- 4 Press the Δ or ∇ key to select [Reception].
- 5 Press the **OK** key.
- 6 Press the Δ or ∇ key to select [Forward Settings].
- 7 Press the **OK** key.
- 8 Press the Δ or ∇ key to select [File Name Entry].
- 9 Press the **OK** key.
- 10 Use the numeric keys to enter the document name. Up to 32 characters can be entered.

NOTE: For details on character entry, refer to *Specifications (Fax function) on Appendix-6*.

Please note that when you have not add any additional information, file names become the same, and, therefore, old files are overwritten when received originals are forwarded

with folder (SMB) transmission and folder (FTP) transmission.

11 Press the **OK** key.

12 When Not Appending Information to Document Name

- 1 Press the Δ or ∇ key to select [None].
- 2 Press the **OK** key.
- 3 Press the Δ or ∇ key to select [On] or [Off] for appending of sender information.

When Appending Information to Document Name

- 1 Press the Δ or ∇ key to select [Date], [Job No.], [Job No. + Date] or [Date + Job No.].
- 2 Press the **OK** key.
- 3 Press the Δ or ∇ key to select [None], [Add.Info.+Sender] or [Sender+Add.Info.] for appending of sender information.

13 Press the **OK** key.

Settings for Memory Forwarding from COMMAND CENTER (Forward)

You can use COMMAND CENTER on a computer connected to the network to specify the memory forwarding settings on this machine.

Refer to the machine's *Operation Guide* for information on the network settings.

Accessing COMMAND CENTER



- 1 Open the web browser.
- 2 In the Address or Location bar, enter the machine's IP address as the URL, e.g. `http://192.168.48.21/`. *The web page displays basic information about the machine and COMMAND CENTER as well as the current status of the machine.*

- 3 Select a category from the navigation bar on the left to view and set values for that particular category.
- 4 If administrator privileges have been enabled on COMMAND CENTER, remember to enter the correct user name and password when trying to access the relevant screens.

Setting Administrator Password restricts general users' access to pages other than the Start page. For security purposes, setting the Administrator password is highly recommended. The default Administrator password is factory-set as **admin00**.

Forward Settings

FAX > Common > Forward > General

Specify the forward settings.

The settings available on the Forward page are shown below.

Item	Description
On	All received faxes are forwarded.
Off	Faxes are not forwarded.
Activating Time Setting	Specifies whether a time is specified.
Activating Time	Registers times when the specified requirements are enabled or disabled. You can register any time between 00:00 and 23:59.
File Name	Sets the name of the file created when a fax is forwarded.
Additional Information	Appends information such as the date/time, job number and destination address to the file name.
Add Sender Information	Sets the position appended in the additional information. The additional information consists of the local FAX number for a FAX transmission and the e-mail address of this machine in the case of an i-FAX transmission.
Print	To print the fax, click Print . The Print page is displayed. (Refer to <i>Print Settings on page 4-22</i> .)
Forward	To select the forwarding destination, click Forward . The Forwarding page is displayed. (Refer to <i>Forwarding Settings on page 4-23</i> .)

After completing the settings, click **Submit** to save the settings.

Print Settings

FAX > Common > Forward > Print

Use this page to specify the print settings.

The settings available on the Print page are shown below.

Item	Description
Print	Specifies whether faxes forwarded to this machine are printed.

After completing the settings, click **Submit** to save the settings.

Forwarding Settings

FAX > Common > Forward > Forward

Use this page to select forwarding destinations.

The settings available on the Forward page are shown below.

Item	Description
File Format	Choose either PDF or TIFF as the file format used for storing forwarded files.
FTP Encrypted TX	Turn On to enable encryption for transmission. Note the SSL protocol must also be turned on.
Subject Additional Information	When a forwarding address is specified as destination, Sender Name or Sender FAX No./ Address is appended at forwarding. When None , these will not be appended.
Page Separate	Choose whether pages are separated when faxes are forwarded to a computer.
Forward Destination Settings	Displays the registered destinations. Click the checkboxes for the destinations to be enabled so that they are ticked. To change a destination, click the name of the destination to be changed. The Forward - Edit page is displayed. Change the destination information and click Submit .
Delete	To delete a destination, click the checkbox for the destination to be deleted so that it is ticked and then click Delete .

After completing the settings, click **Submit** to save the settings.

Editing Destinations

FAX > Common > Forward > Forward > Edit

Use this page to edit destinations.

The settings available on the Forward - Edit page are shown below.

Item	Description
Address Type	Select the destination type. <ul style="list-style-type: none">• E-mail• SMB• FTP• FAX

If you selected **E-mail** as the destination type, specify the settings below.

- E-mail

If you selected **SMB** or **FTP** as the destination type, specify the settings below.

- Host Name
- Port number
- Path
- Login User Name
- Login Password

If you selected **FAX** as the destination type, specify the settings below.

- FAX Number
- Transmit Start Speed
- ECM
- Sub Address
- Password
- Encryption Key No.
- Encryption Box
- Encryption Box No.

After completing the settings, click **Submit** to save the settings.

Sub Address Communication

Sub Address Communication

Sub address communication is communication in which data is sent and received with sub addresses and passwords attached in conformance with the ITU-T (International Telecommunication Union) recommendations. Sub addresses enable communication modes with third-party machines that were previously only possible between our brand machines. These include confidential delivery (sending originals to an original delivery box set up in the receiving system) and polling communication (reception of documents from a source machine that is controlled from the receiving machine). Using sub address communication and the memory forwarding function on this machine also allows advanced communication functions such as storing received originals in Sub Address Boxes and forwarding originals to other fax machines.

NOTE: In order to conduct sub address communication, the other party's system also needs to be equipped with sub address communication functions of the same type.

Sub address-based communication can be used together with various kind of functional communication. When registering a sub address and sub address password in the Address Book and **One-touch** keys, you can omit their entry before transmission. For details, refer to the explanations in the procedure of each communication method and registration method.

Sub Address

With the machine, sub address and sub address passwords are called sub address.

Sub Address

Use the numbers from 0 to 9, ' (space)', and '#' and '*' characters to enter a sub address of up to 20 digits. When the machine receives originals, the sub address is used as the forward requirement for memory forwarding.

Sub Address Password

Use the numbers from 0 to 9, alphabets, ' (space)', and '#' and '*' characters to enter a sub address password of up to 20 digits. When the machine receives originals, a sub address password is not used.

Sub Address Transmission

To use sub address transmission, follow the steps below.

NOTE: To use sub address transmission, check that a sub address and password have been set in the receiving system in advance.

For the setting method when the machine receives originals, refer to *Printing/Forwarding Received Documents (Memory Forwarding)* on page 4-13.

- 1 Press the **FAX** key.
- 2 Place the originals.

NOTE: When a sub address has been registered to the destination of the Address Book, you can use the destination. When a sub address-registered destination in the Address Book is used for a One-touch key, you can also use the **One-touch** key. In this case, go to step 9.

```

Fax No. Entry:  [OK]
0123456789█
[ Chain ] [ Detail ]

```

- 3 Use the numeric keys to enter the fax number of the other party.

```

FAX Detail:  [OK]
Sub Address:  1/4
1234567890123
*****
[ Edit ]

```

- 4 Press [Detail] (the **Right select** key).
- 5 Press the < or > key to select [Sub Address], and press [Edit] (the **Right Select** key).

```

Sub Address:  [OK]
1234567890123█

```

- 6 Enter the sub address using the numeric keys.

NOTE: You can use up to 20 digits including the numbers from 0 to 9, ' (space)', '#', and '*' characters to enter a sub address.

- 7 Press the **OK** key and enter the sub address password using the numeric keys.

NOTE: You can use up to 20 digits including the numbers from 0 to 9, ' (space)', '#', and '*' characters to enter a sub address password. When the machine receives originals, a sub address password is not used.

- 8 Press the **OK** key.
- 9 Press the **OK** key again.
- 10 Press the **Start** key. Transmission begins.

Sub Address Box Function

Sub Address Box

A Sub Address Box is a box for storing received originals on the machine to which the FAX System is to be installed. Using the memory forwarding function, you can store received originals in a personal Sub Address Box.

Registering a Sub Address Box

Up to 20 Sub Address Boxes can be registered.

- 1 Press the **System Menu/Counter** key.
- 2 Press the Δ or ∇ key to select [Document Box], and press the **OK** key.
- 3 Press the Δ or ∇ key to select [Sub Address Box], and press the **OK** key.
- 4 Press the Δ or ∇ key to select [Detail/Edit], and press the **OK** key.
- 5 Press [Menu] (the **Right Select** key).
- 6 Press the Δ or ∇ key to select [Add Box], and press the **OK** key.
- 7 Use the numeric keys to enter the sub address.
- 8 Press the **OK** key, and use the numeric keys to enter the name of Sub Address Box.
- 9 Press the **OK** key, and use the numeric keys to enter the box numnr of Sub Address Box.
- 10 Press the **OK** key.
- 11 Press the Δ or ∇ key to select [Exit], and press the **OK** key.

Changing Sub Address Box

- 1 Follow steps 1 to 4 of *Registering a Sub Address Box on page 4-27*.
- 2 Select the box to be changed, and press the **OK** key.
- 3 Press the \triangleleft or \triangleright key to move the item to be changed, and press [Edit] or [Change] (the **Right Select** key).
- 4 Use the numeric keys to edit the item.
Repeat the step 3 and 4 for the other items.

NOTE: When User Login authentication is enabled, User setting menu and Permission menu appear.

Follow the steps to change the user name.

- 1 Press the Δ or ∇ key to select [Local User], [Network User] or [None].
- 2 When selecting [Local User], press the Δ or ∇ key to select user name form the Local User List. When selecting [Network User], use the numeric keys to enter the login user name.
- 3 Press the **OK** key.

Follow the steps to change the permission of the subaddress box.

- 1 Press the Δ or ∇ key to select [Shared] or [Private].
- 2 Press the **OK** key.

Follow the steps to change the setting of the deletion after printing the originals.

- 1 Press the Δ or ∇ key to select [On] or [Off] in Del. afterPrint menu.
- 2 Press the **OK** key.

Deleting Sub Address Box

- 1 Follow steps 1 to 4 of *Registering a Sub Address Box on page 4-27*.
- 2 Select the box to be deleted.
- 3 Press [Menu] (the **Right Select** key).
- 4 Press the Δ or ∇ key to select [Delete], and press the **OK** key.
- 5 When the deletion confirmation screen appears, press [Yes] (the **Left Select** key).

Printing Originals from a Sub Address Box

To print the originals that have been sent to a Sub Address Box, use the following operation.

- 1 Press the **Document Box** key.
- 2 Press the Δ or ∇ key to select [Sub Address Box], and press the **OK** key.
- 3 Press the Δ or ∇ key to select the Sub Address Box.
- 4 Press [Menu] (the **Right Select** key).
- 5 Press the Δ or ∇ key to select [Open], and press the **OK** key.

NOTE: You must enter a box password in the following situations:

- If user login is disabled
 - If user login is enabled but the Sub Address Box has been selected by another user when you login with user privileges
-

- 6** Press the Δ or ∇ key to select the document form the list, press [Select] (the **Right Select** key).

The selected originals are check-marked.

NOTE: To cancel the selection, press [Select] (the **Right Select** key) again and delete the checkmark.

When pressing [Menu] (the **Left Select** key) and press the Δ or ∇ key to select [Select All], and press the **OK** key, all the documents are selected.

From a Sub Address Box, only printing is available. Sending cannot be done.

- 7** Press the **OK** key.
- 8** Press the Δ or ∇ key to select [Print].The print starts.

Deleting Originals after Printing from a Sub Address Box

To automatically delete the originals printed form the Sub Address Box, use the following operation.

- 1** Follow steps 1 to 3 in *Printing Originals from a Sub Address Box on page 4-28*.
- 2** Press the **Function Menu** key.
- 3** Press the Δ or ∇ key to select [Del. afterPrint] .
- 4** Press the **OK** key.
- 5** Press the Δ or ∇ key to select [On].
- 6** Press the **OK** key.

Deleting Originals from a Sub Address Box

Use the procedure below to delete an original that you have forwarded to a Sub Address Box.

- 1** Follow steps 1 to 7 in *Printing Originals from a Sub Address Box on page 4-28*.
- 2** Press the Δ or ∇ key to select [Delete], and press the **OK** key.
- 3** When the deletion confirmation screen appears, press [Yes] (the **Left Select** key). The original is deleted.

Checking Details and Renaming Files

You can use the procedure below to check the details of documents forwarded to a Sub Address Box. You can also use this procedure to rename files.

- 1** Follow steps 1 to 5 in *Printing Originals from a Sub Address Box* on page 4-28.
- 2** Press the Δ or ∇ key to select the document, press [Menu] (the **Left Select** key).
- 3** Press the Δ or ∇ key to select [Detail/Edit], press the **OK** key.
- 4** Press the \triangleleft or \triangleright key to move the item to be changed, and press [Edit] (the **Right Select** key).

The details for the selected original are displayed.

Item	Description
File Name	File name of the original Press [Edit] to rename the file.
Number of Pages	Number of pages in the original
Resolution	Resolution of the original
Date and Time	The date and time the original was forwarded.

- 5** Use the numeric keys to edit the item.

Repeat the step 4 and 5 for the other items.

Printing a Sub Address Box List

You can print the Sub Address Box list in which the list of Box No.'s and Box names of the registered Sub Address Boxes are described. When there are originals in the Sub Address Boxes, *the number of pages* is displayed.

NOTE: The list can be printed when user login has been enabled and the machine is logged in with administrator privileges.

- 1 Press the **System Menu/Counter** key.
- 2 Press the Δ or ∇ key to select [Document Box], and press the **OK** key.
- 3 Press the Δ or ∇ key to select [SubAddr. Box List], and press the **OK** key.
- 4 When the printing confirmation screen appears, press [Yes](the **Left Select** key). The machine prints a list of the Sub Address Boxes.

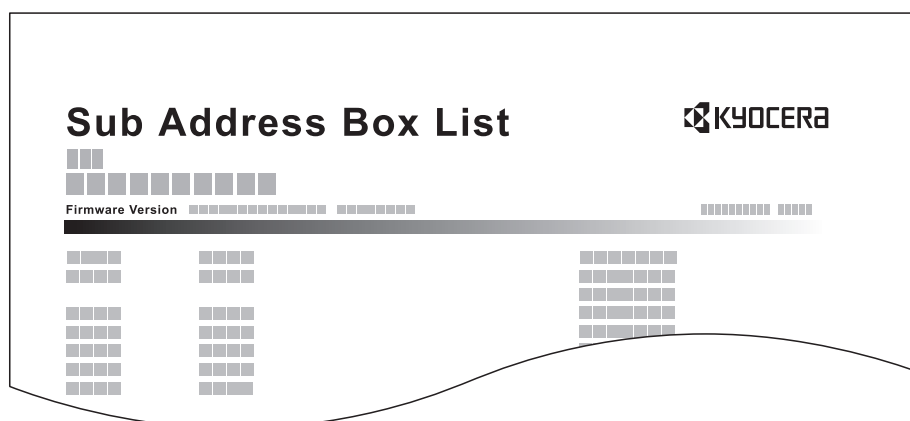

Program Dial

You can register transmission requirements such as the other party to which you send originals and transmission time as a program. After registration, you can recall transmission requirements only by pressing the program number. Also, you can assign names to programs to make recalling programs easier and more convenient.

NOTE: The copy function can be also registered to the program. Up to 4 programs including copying and sending functions can be registered.

When user login has been enabled, only the administrator can register.

Registering Programs

- 1 With transmission requirements to be registered are set, press the **Program** key and hold it (2 seconds). The program is registered to the key. When you press a number where a program is already registered, proceed to the next step.
- 2 Press the Δ or ∇ key to select [Overwrite].
- 3 Press the **OK** key.
- 4 Press [Yes] (the **Left Select** key). The program is registered, overwriting the previous one.

Deleting Registration Contents

- 1 Press the **Program** key where a program you want to delete is registered, and hold it (2 seconds).
- 2 Press the Δ or ∇ key to select [Delete].
- 3 Press the **OK** key.
- 4 Press [Yes] (the **Left Select** key). The program is deleted.

Using Program Dial

- 1 Press the **Program** key.
- 2 Place the originals.

NOTE: You can also use the program you have called up to change transmission requirements such as changing the other party.

- 3 Press the **Start** key. Transmission begins.

Polling Communication

Polling communication is a communication mode in which the transmission of originals on the sending machine is controlled by the receiving machine. This allows the receiving machine to tailor the reception of originals to its own circumstances. This machine supports both polling transmission and polling reception.

IMPORTANT: Because the receiving machine dials the sending machine in polling communication, call charges are normally borne by the recipient.

Polling Transmission

Originals to be used in polling transmissions should be stored in a Polling box. When a polling request is received from the destination, the stored originals are sent automatically.

Once originals intended for polling transmission have been sent to the destination, they are automatically deleted. However, if you set *Delete TX File* to [Off], the originals are stored in the Polling box until you delete them. You can use polling transmission with the same originals as many times as you wish. (Refer to page 4-34.)

NOTE: You can store up to 10 originals for polling transmission.

You can also add to or overwrite originals up until a polling request arrives from the destination. Refer to *Overwrite Setting* on page 4-35.

Bulletin Board Communication

This is a communication mode that allows a Polling box to be used like a bulletin board, giving multiple recipients free access to the stored originals. Set *Delete TX File* to [Off] so that the same original can be polled multiple times.

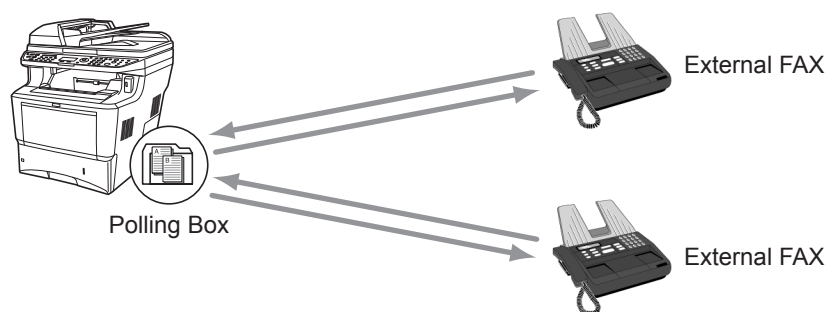

Deleting Originals After Polling Transmission

Originals intended for polling transmission are automatically deleted after they have been sent to the destination. To allow polling transmission of the same original to multiple destinations, set this option to [Off].

- 1** Press the **System Menu/Counter** key.
- 2** Press the Δ or ∇ key to select [Document Box].
- 3** Press the **OK** key.
- 4** Press the Δ or ∇ key to select [Polling Box].
- 5** Press the **OK** key.
- 6** Press the Δ or ∇ key to select [Delete TX File].
- 7** Press the **OK** key.
- 8** Press the Δ or ∇ key to select [On] or [Off].
- 9** Press the **OK** key.

Overwrite Setting

Use the procedure below to overwrite the existing document if the same name is added to the new file. To allow overwriting, set this option to [Allowed].

- 1 Press the **System Menu/Counter** key.
- 2 Press the Δ or ∇ key to select [Document Box].
- 3 Press the **OK** key.
- 4 Press the Δ or ∇ key to select [Polling Box].
- 5 Press the **OK** key.
- 6 Press the Δ or ∇ key to select [OverwriteSetting].
- 7 Press the **OK** key.
- 8 Press the Δ or ∇ key to select [Allowed] or [Not Allowed].
- 9 Press the **OK** key.

Using Polling Transmission

- 1 Press the **Document Box** key.
- 2 Place the originals.
- 3 Press the Δ or ∇ key to select [Polling Box].
- 4 Press the **OK** key.
- 5 Press the Δ or ∇ key to select [Store File].
- 6 Press the **OK** key.
- 7 Press the **Function Menu** key.
- 8 Change the required functions for the original to be stored. For information on using the functions, refer to the machine's *Operation Guide*.

Function	Description
Original Size	Select the size of originals to be scanned. Be sure to select the original's size when using custom size originals.
Original Image	Select image quality.
Scan Resolution	Chooses the level of detail used for scanning originals.

Function	Description
Orig. Orientation	To ensure that the originals are stored in the correct orientation, this indicates which end of the original is the top. To use the following functions, select the orientation of the originals. <ul style="list-style-type: none">• 1-sided / 2-sided Selection• Border Erase
Continuous Scan	Allows you to divide originals that cannot be placed in the document processor at one time into multiple scans and then store the result as a single file. With this function, originals continue to be scanned until you press [END Scan] (the Right Select key).
File Name Entry	Allows you to rename the files created from scanned originals. You can also use this function to add the job number and/or date.
Job Finish Notice	Sends a notice by an e-mail when a transmission is complete.
Density	Adjusts the density used for scanning originals.
Duplex	Select the type and binding of originals.

- 9 Press the **Start** key. The originals are scanned and stored in the Polling box.

Polling Reception

This function automatically triggers transmission of originals stored on the sending machine when the receiving machine dials the sending machine's number.

NOTE: To use polling reception, you must first ensure that the sending machine is set up for polling transmission. (Refer to *Polling Transmission on page 4-33.*)

Using Polling Reception

NOTE: When the other party is using sub addresses, refer to *Using Polling Reception with Sub Addresses* below.

- 1 Press the **FAX** key.
- 2 Press the **Function Menu** key.
- 3 Press the Δ or ∇ key to select [FAX RX Polling].
- 4 Press the **OK** key.
- 5 Press the Δ or ∇ key to select [On].
- 6 Press the **OK** key.
- 7 Select the destination.

NOTE: Only fax numbers can be selected as destinations. You can select destinations using the numeric keys input and Address Book or **One-touch** keys selection.

- 8 Press the **Start** key. The operations for reception begin.

Using Polling Reception with Sub Addresses

For polling reception, enter the sub address (on this machine, sub address and sub address password) set at the sending machine. This communication is still possible when the other party is using a third-party machine provided it is equipped with the same type of sub address communication function.

IMPORTANT: Check the sub address set by the sender beforehand.

- 1 Press the **FAX** key.
- 2 Select the destination. Here, refer to *Sub Address Transmission on page 4-25* when entering the sub address.

NOTE: Only fax numbers can be selected as destinations. You can select destinations using the numeric keys input, **One-touch** keys selection and selection from the Address Book containing registered sub addresses.

- 3 Press the **Start** key. The operations for reception begin.

Printing from a Polling Box

Use this procedure to print an original stored in a Polling box.

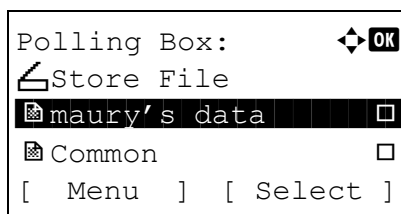

- 1 Press the **Document Box** key.
- 2 Press the Δ or ∇ key to select [Polling Box].
- 3 Press the **OK** key.
- 4 Press the Δ or ∇ key to select the desired original.

4

- 5 Press [Select] (the **Right Select** key). The selected original is indicated by a checkmark. To cancel the selection, press [Select] (the **Right Select** key) again.

6 Selecting Two or More Originals

Repeat steps 4 to 5.

Selecting/Cancelling All Originals

- 1 Press [Menu] (the **Left Select** key).
- 2 Press the Δ or ∇ key to select [Select All] or [Clear All].
- 3 Press the **OK** key.
- 7 Press the **OK** key.
- 8 Press the Δ or ∇ key to select [Print].
- 9 Press the **OK** key.
- 10 Press the **Start** key. Printing starts.

Deleting Originals in a Polling Box

Use this procedure to delete an original stored in a Polling box.

NOTE: If *Delete TX File* is set to [On], originals are automatically deleted following polling transmission. (Refer to page 4-34.)

- 1** Follow steps 1 to 7 in *Printing from a Polling Box* on page 4-39.
- 2** Press the Δ or ∇ key to select [Delete].
- 3** Press the **OK** key.
- 4** Press [Yes] (the **Left Select** key). The original is deleted.

Checking Details and Renaming Files

Use this procedure to check the details of an original stored in a Polling box. You can also use this procedure to rename files.

- 1 Follow steps 1 to 4 in *Printing from a Polling Box* on page 4-39.
- 2 Press [Menu] (the **Left Select** key).
- 3 Press the Δ or ∇ key to select [Detail/Edit].
- 4 Use the \triangleleft or \triangleright key to check the details of the selected original.

4

Item	Description
File Name	File name of the original Press [Edit] (the Right Select key) to rename the file.
Page	Number of pages in the original
Resolution	Resolution used during scanning
Date and Time	The date/time when the original was stored.

- 5 When you have finished checking the details, press the **OK** key.

Account Management

Account management is user management that specifies the users who can use the machine and job accounting that controls the usage per account. In user accounting, up to 21 users can be managed using User ID and Password. In job accounting, the status of fax use per account can be known for up to 20 accounts for sending of originals and making communication reservation after entering Account ID. For each management method, refer to the machine's *Operation Guide*.

Description of User Accounting

Item	Description
Registration of User	Register user access privileges, User ID and Password.
Enable/Disable User accounting	Enable User accounting.

NOTE: For details, refer to the machine's *Operation Guide*.

Description of Job Accounting

Item	Description
Registration of Account	Register Account Name and Account ID. Up to 8 digits can be entered.
Enable/Disable job accounting	Enable job accounting.
FAX send restriction	Restricts the number of fax sheets that can be sent. You can prohibit the use of this sending function or cancel the sending restriction.
Counting of the number of used sheets	You can reset the counting, referring to the number of fax sheets to be sent and the time required for sending fax by all the accounts or by account.
Print of Accounting Report	You can print the printed and sent page numbers that have been counted by all the accounts.

NOTE: For details, refer to the machine's *Operation Guide*.

Communication modes subject to job accounting

- Normal transmission
- Delayed transmission
- Broadcast transmission
- Sub address transmission
- Encrypted transmission
- Manual send when dialed from this machine to the receiving system
- Polling transmission
- Polling reception
- Network FAX transmission

Restriction of use function

When you have enabled job accounting, you need to enter an Account ID when performing the following operations.

- Normal transmission
- Delayed transmission
- Broadcast transmission
- Sub address transmission
- Output from Sub Address Box
- Encrypted transmission
- Manual send when dialed from this machine to the receiving system
- Polling transmission
- Polling reception
- Network FAX transmission

IMPORTANT: You can use 'Make a call', 'Checking FAX Job History' and 'Communication Control Report Output' functions without entering an Account ID or Administrator No.

When job accounting has been enabled, batch transmission function works only for communication to be performed for the same Account ID. The communication to be performed with a different Account ID is not conducted as a batch transmission.

Normally, the Local FAX Name is printed in the transmit terminal identification (TTI). However, when job accounting has been enabled, and you send originals after entering an Account ID, the Account Name is printed.

Logging in when User Accounting has been Enabled

When user accounting has been enabled, you need to enter a User ID and Password to use the machine.

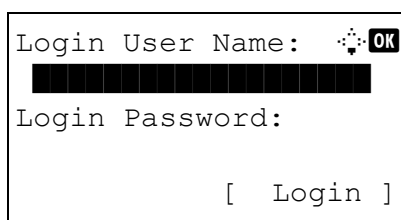

```

Login User Name:  [OK]
████████████████
Login Password:
[ Login ]
  
```

- 1 If the screen below appears during the operations, perform the following login operations.

NOTE: If [Netwk Authentic.] is selected as the user authentication method, press [Menu] (the **Left Select** key) to select the authentication destination.

- 2 Press the Δ or ∇ key to select [Login User Name].
- 3 Press the **OK** key.
- 4 Use the numeric keys to enter the login user name.

NOTE: For details on character entry, refer to *Specifications (Fax function) on Appendix-6*.

- 5 Press the **OK** key.
- 6 Press the Δ or ∇ key to select [Login Password].
- 7 Press the **OK** key.
- 8 Use the numeric keys to enter the login password.

NOTE: For details on character entry, refer to *Specifications (Fax function) on Appendix-6*.

- 9 Press the **OK** key.
- 10 Check the login user name and password are correct, and press [Login] (the **Right Select** key).
- 11 Perform the fax operation.

NOTE: When the operation is completed, press the **Logout** key.

Logging in when Job Accounting has been Enabled

When job accounting has been enabled, you need to enter an Account ID when using the machine.

NOTE: When both user accounting and job accounting have been enabled, the screen for entering a *User ID and Password* is displayed.

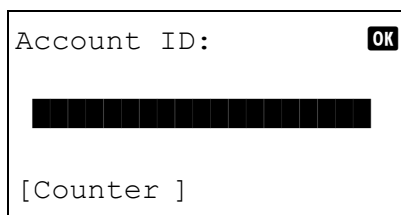

Account ID: OK

[Counter]

- 1 Use the numeric keys to enter Account ID, and press the **OK** key.

NOTE: You can check the number of pages used by a department by entering the Account ID and pressing [Counter] (the **Left Select** key).

- 2 Perform the fax operation.

NOTE: When the operation is completed, press the **Logout** key.

Other Convenient Functions

Functions that are convenient when sending fax are introduced here. For usage of each function, refer to the machine's *Operation Guide*.

Original Size Selection

Select the size of originals to be scanned. Be sure to select the original's size when using custom size originals.

1-sided / 2-sided Selection

Select the type and binding of originals.

Original	Type	Binding	Orientation
1-sided sheet original	1-sided	–	–
2-sided sheet original	2-sided	Binding Left/Right, Biding Top	Top Edge Top, Top Edge Left

Original Orientation

To ensure that the originals are sent in the correct orientation for reading, indicate which end of the original is the top. To use the following functions, select the orientation of the originals.

- 1-sided / 2-sided Selection

Selection of Original Image

Select Original Image.

Item	Detail
Text + Photo	Suitable for originals containing a mixture of text and photos.
Text	Sharply renders pencil text and fine lines.
Photo	For enhanced copies of photographs.
for OCR †	Image quality suitable for OCR software (Applications converting images into text data)†

†. When you send fax, this is changed to [Text].

Continuous Scan

When you cannot place multi-page originals into the document processor at one time, the multi-page originals can be scanned in batches and sent as one job. In this method, originals are scanned until you press [END Scan] (the **Right Select** key).

Job Finish Notice

This function is used to inform when the transmission of e-mail is completed.

5 Checking Transmission Results and Registration Status

This chapter explains how to check fax transmission results and functional registration status.

- Various Tools for Checking Transmission Results and Registration Status 5-2
- Checking FAX Job History..... 5-3
- Printing Administrative Reports..... 5-5
- Reporting FAX Receipt Result by E-mail..... 5-10

Various Tools for Checking Transmission Results and Registration Status

Check the fax transmission results and registration status using the following tools.

Tool	Display Location	Contents to Check	Timing of Check	Reference Page
FAX job history check	Display	History of latest 16 send and receipt results stored	Any time	5-3
Send result report / Receipt result report	Report printing	Latest send or receipt result	Automatic printout after every sending or receiving operation (No Print Output or Error Only is also optionally available.)	5-5
Activity report	Report printing	Latest 50 send or receipt results	Any time, and automatic printout after every 50 sending/receiving	5-7
Status page	Report printing	Registration status of Local FAX Number, Local FAX Name, fax line setting, etc.	Any time	5-9
Reporting of FAX receipt result by E-mail	PC	Fax receipt	Fax reception is reported by e-mail.	5-10

Checking FAX Job History

Display the history of the latest 16 each of send and receipt results on the display for checking.

NOTE: Even when job accounting is enabled, 16 each of send and receipt results are displayed regardless of the account ID.

For details of the job history check, refer to the machine's *Operation Guide*.

Displaying Job Log Screen

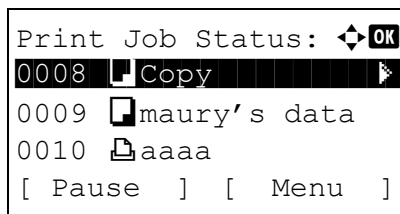

- 1 Press the **Status/Job Cancel** key.
- 2 Press the Δ or ∇ key to select [Print Job Log] to check reception results, [Send Job Log] to check transmission results, or [Store Job Log] to check results of storage in Sub Address Boxes, Polling Boxes and USB memory.
- 3 Press the **OK** key.
- 4 Press the Δ or ∇ key to select the job you want to check.
- 5 Press the **OK** key.
- 6 Press the \triangleleft or \triangleright key to check the details of the job.
- 7 Press the **OK** key.

Description of Detailed Information Screen

Item	Description
Result	Result is indicated. OK: Job ended properly. Cancel: Job was canceled. Error: Job ended improperly due to error.
Accepted Time	Time when job was accepted
End Time	Time when job ended
Job Name	Job name
Job Type	Job type
User Name	User name Blank if no information is available
Page and Copy	Number of pages in the printing page and copies
Original Pages	Number of pages in the original
Color/B & W	Color mode used during scanning

Item	Description
Sender Info.	Transmission information
Destination	Recipient <i>The number of destinations is displayed.</i>

Printing Administrative Reports

You can print various administrative reports to check the results of fax transmission or the status of the functional setup.

Send Result Reports

Each time you send a fax, you can print a report to confirm whether the fax was sent successfully. You can also print the transmitted image in the send result report.

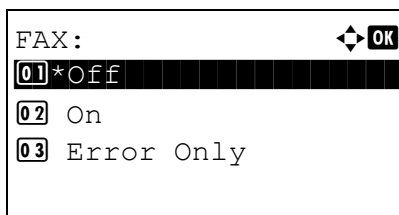

- 1 Press the **System Menu/Counter** key.
- 2 Press the Δ or ∇ key to select [Report].
- 3 Press the **OK** key.
- 4 Press the Δ or ∇ key to select [Result Rpt Set.].
- 5 Press the **OK** key.
- 6 Press the Δ or ∇ key to select [Send Result].
- 7 Press the **OK** key.
- 8 Press the Δ or ∇ key to select [FAX].
- 9 Press the **OK** key.
- 10 Press the Δ or ∇ key to select [Off] (not to print), [On] (to print) or [Error Only].
- 11 Press the **OK** key. Proceed to the next step if you selected [Error Only] or [On] in step 10.
- 12 Press the Δ or ∇ key to select [On] or [Off] for attachment of the transmitted image.

With transmitted image

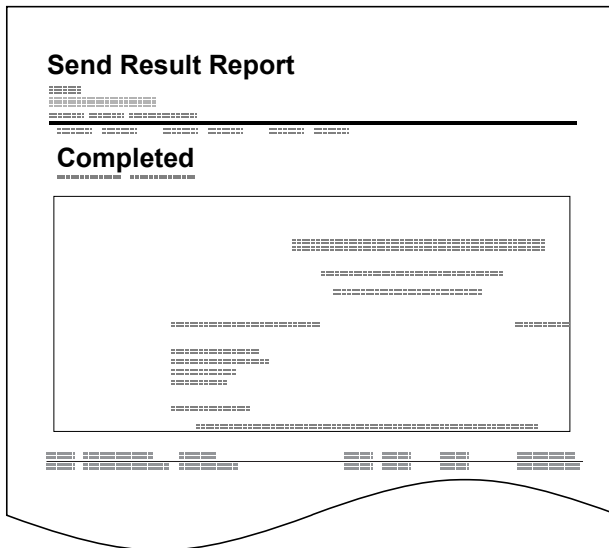

Without transmitted image

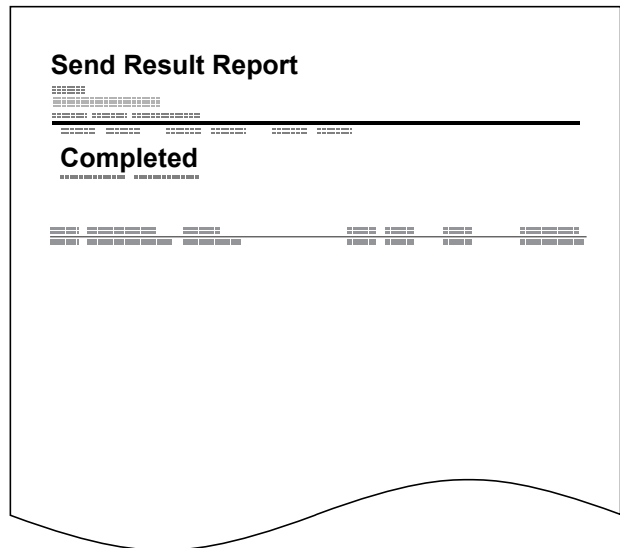

FAX RX Result Reports

Each time you receive a fax, you can print a report to confirm whether the fax was received successfully.

NOTE: Fax receipt can also be notified by e-mail instead of checking the receipt result report. (Refer to *Reporting FAX Receipt Result by E-mail on page 5-10.*)

- 1 Press the **System Menu/Counter** key.
- 2 Press the Δ or ∇ key to select [Report].
- 3 Press the **OK** key.
- 4 Press the Δ or ∇ key to select [Result Rpt Set.].
- 5 Press the **OK** key.
- 6 Press the Δ or ∇ key to select [FAX RX Result].
- 7 Press the **OK** key.
- 8 Press the Δ or ∇ key to select [Off] (not to print), [On] (to print) or [Error/SubAddress].

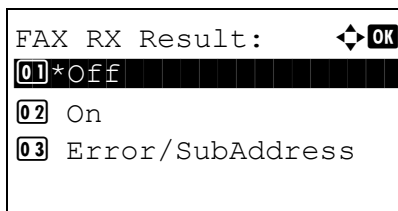

- 9 Press the **OK** key.

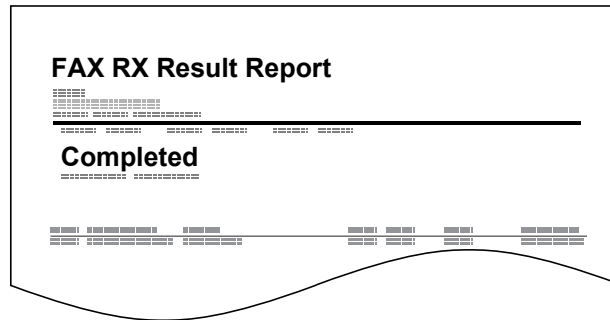

Activity Report

Activity reports are reports of both the sent faxes and the received faxes. Each report lists the history of the latest 50 sent or received fax data. When automatic printout is selected, a report is printed out automatically after every 50 faxes sent or received.

Printing Activity Reports

The latest 50 sent or received fax data are printed as a report.

- 1 Press the **Status/Job Cancel** key.
- 2 Press the Δ or ∇ key to select [FAX].
- 3 Press the **OK** key.
- 4 Press [Log] (the **Right Select** key).
- 5 Press the Δ or ∇ key to select [Outgoing FAX Rpt] to print the sent fax report, or [Incoming FAX Rpt] to print the received fax report.
- 6 Press [Yes] (the **Left Select** key). The report is printed.

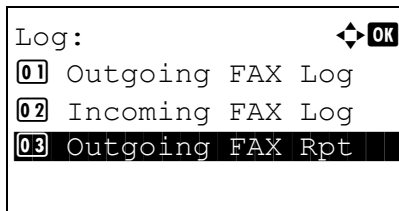

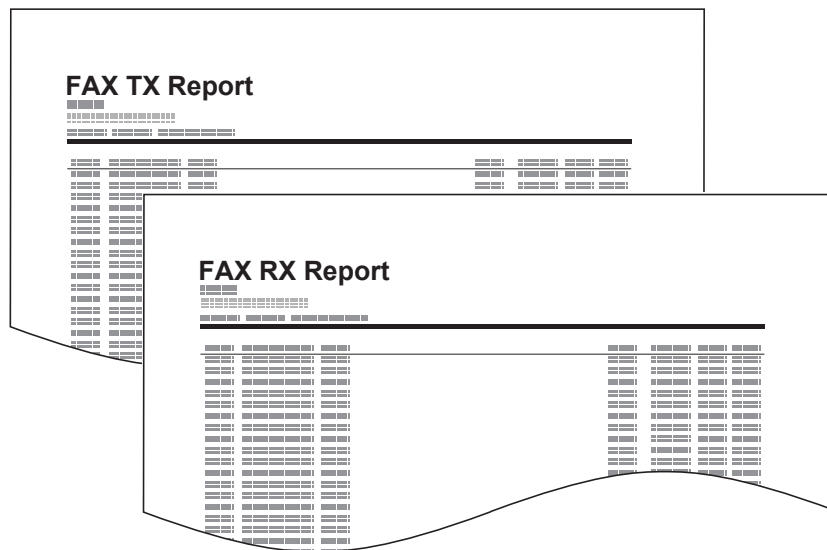

Automatic Printout

An activity report is printed out automatically after every 50 faxes sent or received.

- 1 Press the **System Menu/Counter** key.
- 2 Press the Δ or ∇ key to select [Report].
- 3 Press the **OK** key.
- 4 Press the Δ or ∇ key to select [Admin Rpt Set.].
- 5 Press the **OK** key.
- 6 Press the Δ or ∇ key to select [Outgoing FAX Rpt] or [Incoming FAX Rpt].
- 7 Press the **OK** key.
- 8 Press the Δ or ∇ key to select [Off] (not to print) or [On] (to print).
- 9 Press the **OK** key.

Status Page

A status page provides information on a number of user setups.

FAX-related information includes the Local FAX Number, Local FAX Name, fax line setting, etc. You can print it out as necessary.

- 1 Press the **System Menu/Counter** key.
- 2 Press the Δ or ∇ key to select [Report].
- 3 Press the **OK** key.
- 4 Press the Δ or ∇ key to select [Report Print].
- 5 Press the **OK** key.
- 6 Press the Δ or ∇ key to select [Status Page].
- 7 Press the **OK** key.
- 8 Press [Yes] (the **Left Select** key). The status page is printed.

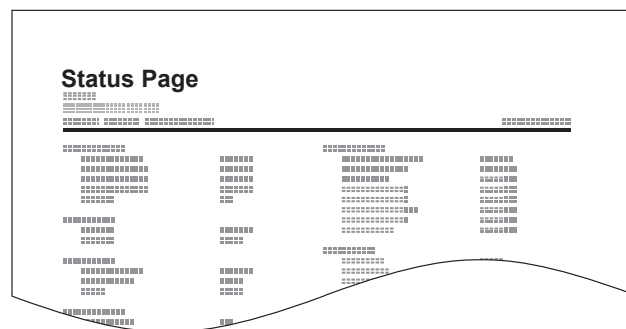

Reporting FAX Receipt Result by E-mail

```

Job No.: 000019
Result: OK
End Time: Sun 23 Apr 2006 14:53:38
File Name: doc23042006145300

Result Job Type Address
-----
OK FAX 123456

-----
XX-XXXX
[00:c0:ee:1a:01:24]
    
```

Fax receipt can also be notified by e-mail instead of checking the receipt result report.

NOTE: This setting is displayed when the *FAX RX Result Report* setting is [On] or [Error/SubAddress]. For details, refer to *FAX RX Result Reports on page 5-6*.

Fax receipt results are reported by e-mail according to the settings of *FAX RX Result Report*. If the *FAX RX Result Report* setting is [On], E-mail notification is provided for every fax. If the setting is [Error/SubAddress], E-mail notification is only provided when an error occurs or the received original is forwarded to other faxes, computers, and Sub Address Boxes.

- 1 Press the **System Menu/Counter** key.
- 2 Press the Δ or ∇ key to select [Report].
- 3 Press the **OK** key.
- 4 Press the Δ or ∇ key to select [Result Rpt Set.].
- 5 Press the **OK** key.
- 6 Press the Δ or ∇ key to select [FAX RX Result].
- 7 Press the **OK** key.
- 8 Press the Δ or ∇ key to select [On] or [Error/SubAddress].
- 9 Press the **OK** key.
- 10 Press the Δ or ∇ key to select [E-mail].
- 11 Press the **OK** key.
- 12 **Selecting Destination from Address Book**
 - 1 Press the Δ or ∇ key to select [Address Book].
 - 2 Press the **OK** key.
 - 3 Press the Δ or ∇ key to select the destination you want to register as the report destination.

Entering Destination Directly

- 1 Press the Δ or ∇ key to select [Address Entry].
- 2 Press the **OK** key.
- 3 Use the numeric keys to enter the address you want to register as the report destination. Up to 64 digits can be entered.

NOTE: For details on character entry, refer to *Character Entry Method on Appendix-2*.

- 13 Press the **OK** key.

6 Setup and Registration

This chapter explains how to perform various setups and registrations.

- FAX/TEL Auto Switch Reception 6-2
- FAX/Answering Machine Auto Switch Reception 6-4
- Rings 6-6
- Volume Adjustment 6-7
- Retry Times 6-8
- Receiving Mode..... 6-9
- Reception Date/Time 6-10
- Media Type for Print Output 6-11
- DRD Reception 6-13
- Transmission Restriction 6-15
- Encryption 6-24
- Duplex Print Output 6-30
- 2 in 1 Reception 6-31
- Print all at once [Batch Print] 6-32
- Select Key Set..... 6-33
- Remote Diagnostics 6-34
- Prohibiting FAX Printing at Specified Times (Unusable Time)..... 6-35

FAX/TEL Auto Switch Reception

This reception method is convenient when using both telephone and fax on a single telephone line. When fax originals have been sent, the machine automatically receives them, and when the other party is calling from a telephone, the machine makes a ringing tone urging the user to respond.

IMPORTANT:

- In order to use FAX/TEL Auto Switch Reception, it is necessary to connect a telephone set (commercially available product) to the machine.
- After the telephone has made a ringing tone for the preset number of times, the other party is required to pay phone line charges even if the receiving system does not respond.

Flow of reception

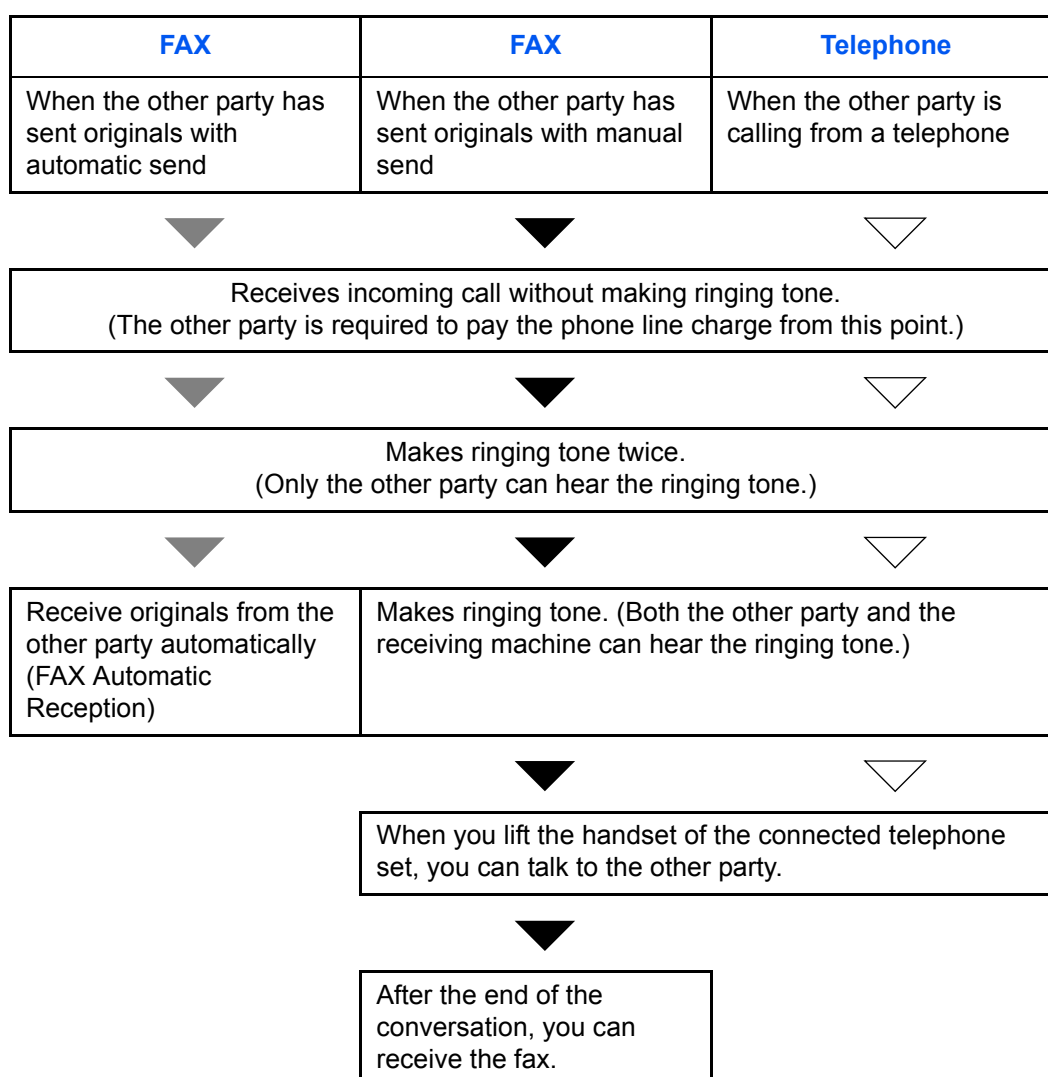

NOTE: At the end of the conversation, you can also manually receive the originals. (Refer to *Manual Reception on page 4-9.*)

Preparation: Refer to *Receiving Mode on page 6-9* to select [Auto (FAX/TEL)].

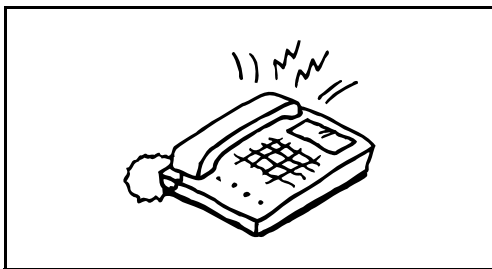

- 1 The connected telephone set makes a ringing tone. Note that if [0] (zero) is set as the number of rings (for FAX/TEL Auto Switch), the connected telephone does not ring.

NOTE: You can change the number of times the ringing tone rings. (Refer to *Rings* on page 6-6.)

2 When the call is from a telephone

- 1 The machine makes a ringing tone urging the user to respond. Lift the handset of the telephone within 30 seconds.

NOTE: If you do not lift the handset within 30 seconds, the machine switches to fax reception.

- 2 Talk to the other party.

NOTE: At the end of the conversation, you can manually receive the originals. (Refer to *Manual Reception* on page 4-9.)

When the call is from a fax

The machine starts receiving fax originals.

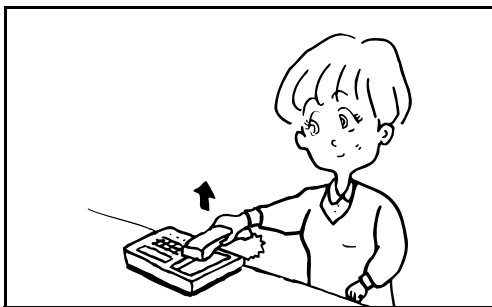

FAX/Answering Machine Auto Switch Reception

This method is convenient when using both the answering machine and fax. When fax originals have been sent, the machine receives them automatically, and when the call is from a telephone, the machine follows the functions of the connected answering machine. Therefore, when the user is absent, the other party can leave a message on the answering machine.

IMPORTANT: When using FAX/Answering Machine Auto Switch Reception function, if a silence continues for at least 30 seconds before one minute passes after the machine has received a call from the other party, the machine's silence detection function comes into operation and the machine switches to fax reception.

NOTE: In order to use FAX/Answering Machine Auto Switch Reception, it is necessary to connect an answering machine-equipped telephone set (commercially available product) to the machine.

For details, such as responding to messages, refer to the Operation Guide of each answering machine.

Set the number of rings to be made by the machine more than the number of rings to be made by the answering machine. (Refer to *FAX/TEL Auto Switch Reception on page 6-2.*)

Flow of reception

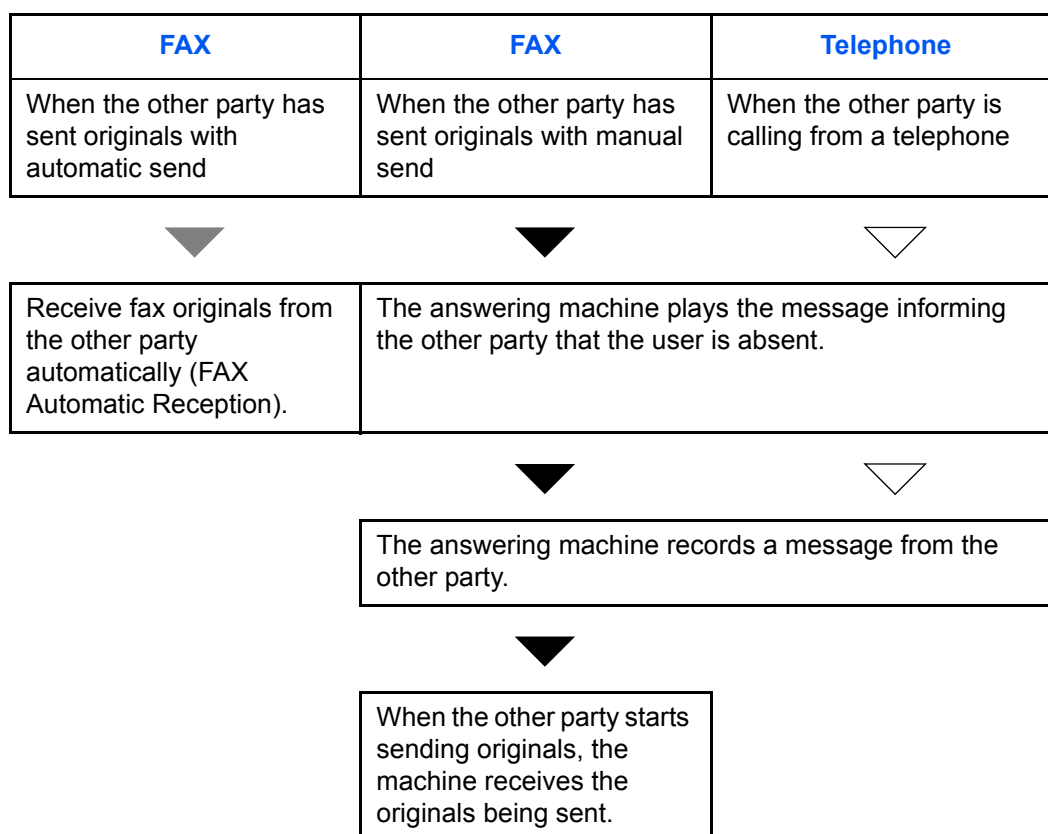

Preparation: Refer to *Receiving Mode* on page 6-9 to select [Auto (TAD)].

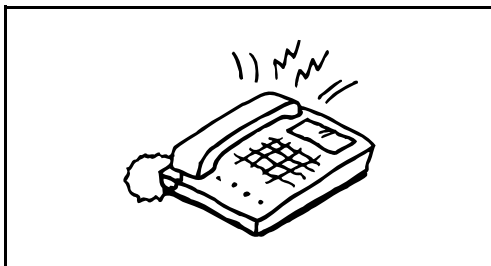

- 1 The connected telephone set makes ringing tone the set number of times.

NOTE: If you lift the handset while the telephone set is still making the ringing tone, the machine enters a status the same as manual reception. (Refer to *Manual Reception* on page 4-9.)

- 2 The answering machine responds.

When the call is from a telephone, but the user is absent

The answering machine plays a response message, and starts recording the other party's message.

NOTE: When silence continues for at least 30 seconds during recording, the machine switches to fax reception.

When the call is from a fax

The machine starts receiving fax originals.

Rings

You can change the number of times to let the phone ring before answering a call as needed. The number of ringing times can be changed independently for each receiving mode of Auto (Normal), Auto (TAD) and Auto (FAX/TEL).

NOTE: The number of ringing times can be set to between 1 and 15 times for Rings (Normal) and Rings (TAD), and 0 and 15 times for Rings (FAX/TEL).

For Rings (FAX/TEL), this change is possible with some countries.

- 1** Press the **System Menu/Counter** key.
- 2** Press the Δ or ∇ key to select [FAX].
- 3** Press the **OK** key.
- 4** Press the Δ or ∇ key to select [Reception].
- 5** Press the **OK** key.
- 6** Press the Δ or ∇ key to select [Rings(Normal)], [Rings(TAD)] or [Rings(FAX/TEL)].
- 7** Press the **OK** key.
- 8** Use the numeric keys to enter the number of ringing times.
- 9** Press the **OK** key.

Volume Adjustment

Adjust the volume of the speaker and monitor.

Speaker Volume: Volume of the built-in speaker when the line is connected by pressing the **On Hook** key.

Monitor Volume: Volume of the built-in speaker when the line is connected without pressing the **On Hook** key such as in memory transmission.

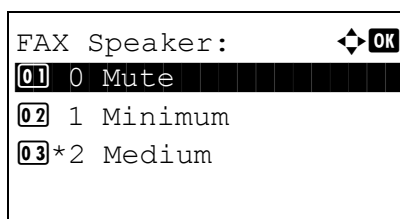

- 1 Press the **System Menu/Counter** key.
- 2 Press the Δ or ∇ key to select [Common Settings].
- 3 Press the **OK** key.
- 4 Press the Δ or ∇ key to select [Sound].
- 5 Press the **OK** key.
- 6 Press the Δ or ∇ key to select [FAX Speaker] or [FAX Monitor].
- 7 Press the **OK** key.
- 8 Press the Δ or ∇ key to select the desired volume of the speaker.
- 9 Press the **OK** key.

Retry Times

The number of retry times can be changed automatically.

NOTE: Retry times can be set to between 0 and 14.

For Redial, refer to *Dialing the Same Receiving System (Redial)* on page 3-24.

- 1** Press the **System Menu/Counter** key.
- 2** Press the Δ or ∇ key to select [FAX].
- 3** Press the **OK** key.
- 4** Press the Δ or ∇ key to select [Transmission].
- 5** Press the **OK** key.
- 6** Press the Δ or ∇ key to select [Retry Times].
- 7** Press the **OK** key.
- 8** Use the numeric keys to enter the number of retry times.
- 9** Press the **OK** key.

Receiving Mode

The following five receiving modes are available.

- FAX Automatic Reception [Auto (Normal)]
- FAX/TEL Auto Switch Reception [Auto (FAX/TEL)] (*Refer to page 6-4.*)
- FAX/Answering Machine Auto Switch Reception [Auto (TAD)] (*Refer to page 6-4.*)
- DRD Reception [Auto (DRD)] (*Refer to page 6-13.*)
- Manual Reception [Manual] (*Refer to page 4-9.*)

Select the mode appropriate for the way the machine is used.

NOTE: DRD reception mode is available for some countries.

- 1 Press the **System Menu/Counter** key.
- 2 Press the Δ or ∇ key to select [FAX].
- 3 Press the **OK** key.
- 4 Press the Δ or ∇ key to select [Reception].
- 5 Press the **OK** key.
- 6 Press the Δ or ∇ key to select [RX Settings].
- 7 Press the **OK** key.
- 8 Press the Δ or ∇ key to select the desired receiving mode.
- 9 Press the **OK** key. Proceed to the next step if you selected [Auto(DRD)] in step 11.
- 10 Press the Δ or ∇ key to select the DRD Pattern.

Pattern	Description
Pattern 1	Normal Ring
Pattern 2	Double Ring
Pattern 3	Short-Short-Long
Pattern 4	Short-Long-Short

- 11 Press the **OK** key.

Reception Date/Time

Reception Date/Time function adds the reception date/time, sender information and number of pages on the top of each page when the message is printed out. It is useful for confirming the time of reception if the fax is from a different time zone.

NOTE: When the received data is printed on multiple pages, the reception date/time is printed on the first page only. It is not printed on the pages that follow.

When the received fax data is forwarded after retrieving it from memory, the reception date/time is not added to the forwarded data.

- 1** Press the **System Menu/Counter** key.
- 2** Press the Δ or ∇ key to select [FAX].
- 3** Press the **OK** key.
- 4** Press the Δ or ∇ key to select [Reception].
- 5** Press the **OK** key.
- 6** Press the Δ or ∇ key to select [RX Date/Time].
- 7** Press the **OK** key.
- 8** Press the Δ or ∇ key to select [On].
- 9** Press the **OK** key.

Media Type for Print Output

Specify the paper type to be used for print output of the received fax.

Supported paper types: All Media Type, Plain, Rough, Vellum, Labels, Recycled, Bond, Cardstock, Color, Envelope, Thick, High Quality, Custom 1 to 8

NOTE: Refer to the machine's *Operation Guide* for details on Custom Paper 1 to 8.

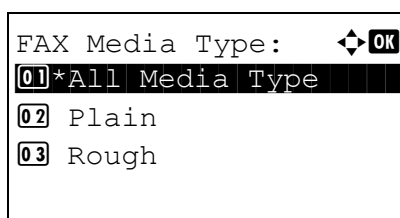

- 1 Press the **System Menu/Counter** key.
- 2 Press the Δ or ∇ key to select [FAX].
- 3 Press the **OK** key.
- 4 Press the Δ or ∇ key to select [Reception].
- 5 Press the **OK** key.
- 6 Press the Δ or ∇ key to select [FAX Media Type].
- 7 Press the **OK** key.
- 8 Press the Δ or ∇ key to select the desired paper type. If you do not specify any paper type, select [All Media Type].
- 9 Press the **OK** key.

Setting the cassette for the print output of received faxes

By specifying the media type, faxes can be received on the corresponding cassette. Faxes will be automatically reduced to the set paper size.

- 1 Press the **System Menu/Counter** key.
- 2 Press the Δ or ∇ key to select [Common Settings].
- 3 Press the **OK** key.
- 4 Press the Δ or ∇ key to select [Orig./Paper Set.].
- 5 Press the **OK** key.
- 6 Press the Δ or ∇ key to select [Cassette 1 Set.], [Cassette 2 Set.], [Cassette 3 Set.] or [Cassette 4 Set.].

NOTE: [Cassette 2], [Cassette 3] and [Cassette 4] are shown when the optional paper feeder is installed.

- 7 Press the **OK** key.

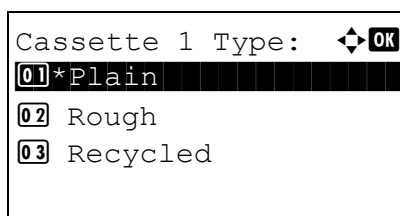
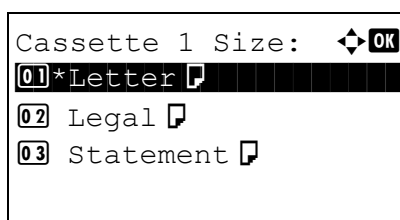

- 8 Press the Δ or ∇ key to select [Cassette 1 Size], [Cassette 2 Size], [Cassette 3 Size] or [Cassette 4 Size].
- 9 Press the **OK** key.
- 10 Press the Δ or ∇ key to select the desired paper size.
- 11 Press the **OK** key. The previous screen reappears.
- 12 Press the Δ or ∇ key to select [Cassette 1 Type], [Cassette 2 Type], [Cassette 3 Type] or [Cassette 4 Type].
- 13 Press the **OK** key.
- 14 Press the Δ or ∇ key to select the desired paper type.
- 15 Press the **OK** key. The previous screen reappears.
- 16 Press the **Back** key to return to the default System Menu screen.
- 17 Now, make the FAX-receiving settings. Refer to *Media Type for Print Output on page 6-11* for the setting procedure.

Select the same paper type as that selected in step 14.

DRD Reception

This reception mode utilizes the Distinctive Ring Pattern service available through some telephone companies. With this service, you can use two or more fax numbers on a single telephone line. Thus, you can use this fax and a telephone on the same line, and you can still designate a different fax number for each of them. As each number is given a different ring pattern, the machine is able to differentiate between incoming calls. If one of these numbers is designated for the machine, and a desired ring pattern is designated for that number in advance, fax reception will be initiated automatically whenever the machine detects the ring pattern distinctive to the fax.

NOTE: Using DRD Reception to receive a telephone call is only possible if a separately purchased telephone is connected to the machine. DRD reception is only possible if you subscribe to the Distinctive Ring Pattern service provided by your telephone company. Contact your telephone company for further information on the Distinctive Ring Pattern service available.

Flow of reception

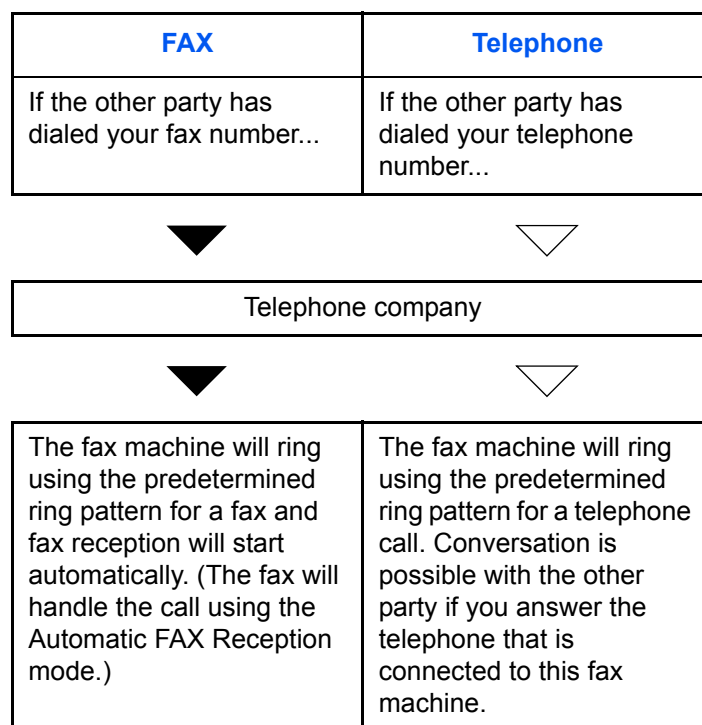

Preparation: Refer to *Receiving Mode on page 6-9* to select [Auto (DRD)].

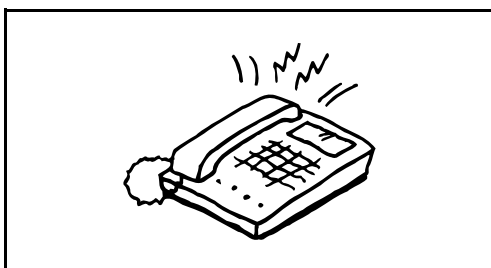

- 1 When a call comes in, the telephone will ring.

NOTE: If you lift the handset while the telephone is still ringing, the machine will deal with the call in the same manner as standard Manual FAX Reception. For details, refer to *Manual Reception on page 4-9*.

- 2 The machine will then ring using the predetermined ring pattern.



When the call is from a telephone

Lift the handset and speak with the other party. When the conversation is over, fax reception can be initiated manually.

When the call is from a fax

Once the ringing tone stops, fax reception will start automatically.

Transmission Restriction

This function allows you to send or receive originals only when communication requirements are met. Using this function can limit other parties with which you can communicate.

Specifically, you must register communication requirements (Permit FAX No./Permit ID No.) and set the transmission limit in advance. When the machine sends or receives originals, you do not need to perform a special operation for this particular function, and you can operate the machine normally. When sending or receiving has actually started, the machine correctly conducts transmission that meets communication requirements, but when the transmission does not meet the requirements, the machine indicates an error. This mode also allows you to set a [Reject List] for Reception Restriction so that reception from senders on the list of Rejected FAX numbers or from senders whose Local FAX Number is not registered are rejected.

NOTE: Before using transmission restriction, be sure to read the following prerequisites, communication establishing requirements, and reception rejection requirements thoroughly, and consult with the other parties with which you communicate.

6

	Prerequisites	Communication Establishing Requirements
Send Restrictions	<ul style="list-style-type: none"> Register Permitted FAX numbers or Permitted ID numbers.[†] (Refer to <i>Registering Permit FAX No. on page 6-16</i> or <i>Registering Permit ID No. on page 6-21.</i>) Send restriction settings are specified in [Permit + Addr Book] in Send Restrictions. (Refer to <i>Setting Send Restriction on page 6-23.</i>) Register the Local FAX Numbers or Local FAX IDs of other parties. 	<ul style="list-style-type: none"> The recipient's Local FAX Number matches a Permitted FAX No. registered on the machine. The recipient's Local FAX ID matches a Permitted ID registered on the machine. When the number was dialed using the Address Book or One-touch keys, the last 4 digits of the dialed number match the last 4 digits of the recipient's Local FAX Number. (Excludes manual transmissions.)
Reception Restrictions	<ul style="list-style-type: none"> Register Permitted FAX numbers or Permitted ID numbers.^{††} (Refer to <i>Registering Permit FAX No. on page 6-16</i> or <i>Registering Permit ID No. on page 6-21.</i>) Reception restriction settings are specified in [Permit + Addr Book] in Reception Restrictions. (Refer to <i>Setting Reception Restriction on page 6-23.</i>) Register the Local FAX Numbers or Local FAX IDs of other parties. 	<ul style="list-style-type: none"> The sender's Local FAX Number matches a Permitted FAX No. registered on the machine. The sender's Local FAX ID matches a Permitted ID registered on the machine. A fax number that matches the last 4 digits of the sender's Local FAX Number is registered in the Address Book on this machine.

[†]. If there is neither a Permitted FAX No. nor a Permitted ID No. registered for the recipient, sending is not rejected.

^{††}. If there is neither a Permitted FAX No. nor a Permitted ID No. registered for the sender, reception is not rejected.

	Prerequisites	Reception Rejection Requirements
Reception Rejection	<ul style="list-style-type: none"> Register Reject FAX numbers.[†] (Refer to <i>Registering Reject FAX No. on page 6-18.</i>) Reception restriction settings are specified in [Reject List] in Reception Restrictions. (Refer to <i>Setting Reception Restriction on page 6-23.</i>) 	<ul style="list-style-type: none"> The sender's Local FAX Number is not registered. The sender's Local Fax Number matches a Reject FAX No. registered on the machine.

†. If there are no Reject FAX numbers registered, calls are only rejected from senders whose Local FAX Numbers (Indicates local FAX information entries, not the actual line numbers.) are not registered.

Registering Permit FAX No.

NOTE: Up to 10 Permit FAX numbers can be registered.

- 1 Press the **System Menu/Counter** key.
- 2 Press the Δ or ∇ key to select [FAX].
- 3 Press the **OK** key.
- 4 Press the Δ or ∇ key to select [TX/RX Restrict.].
- 5 Press the **OK** key.
- 6 Press the Δ or ∇ key to select [Permit No. List].
- 7 Press the **OK** key.
- 8 Press [Menu] (the **Right Select** key).
- 9 Press the Δ or ∇ key to select [Add FAX Number].
- 10 Press the **OK** key.

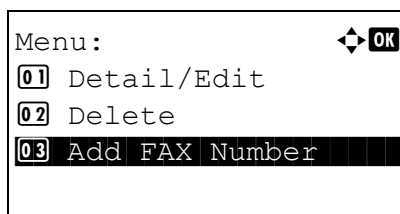
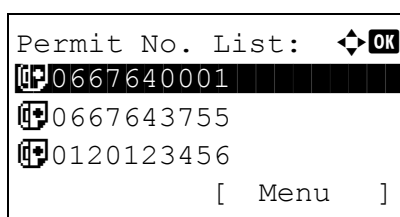

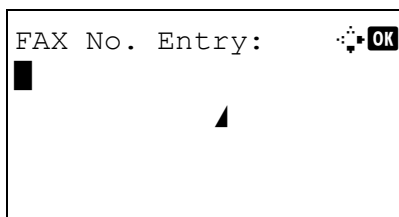

- 11 Use the numeric keys to enter a Permit FAX number. Up to 32 digits can be entered.

NOTE: Press the **Address Recall/Pause** key to insert a pause (-) between two digits.

Press the ◀ or ▶ key to move the cursor.

To correct the number, press the **Clear** key to delete the digits one by one before reentering the number. To delete all entered digits and return to the default screen, press the **Reset** key.

- 12 Press the **OK** key.

- 13 When registering other Permit FAX numbers, repeat steps 8 to 12.

Changing and Deleting Permit FAX No.

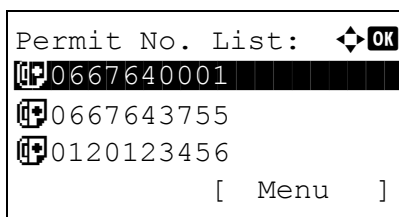

- 1 Follow steps 1 to 7 of *Registering Permit FAX No. on page 6-16*.
- 2 Press the ▲ or ▼ key to select the Permit FAX No. to be changed or deleted.

- 3 Press [Menu] (the **Right Select** key).

4 Changing Permit FAX No.

- 1 Press the ▲ or ▼ key to select [Detail/Edit].

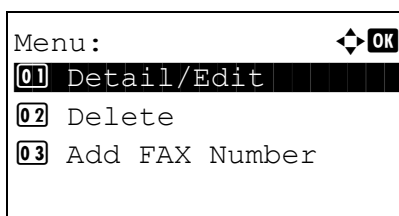

- 2 Press the **OK** key.

- 3 Use the numeric keys to reenter the Permit FAX number. Up to 32 digits can be entered.

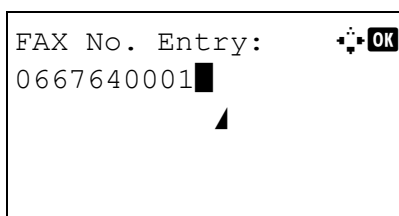

NOTE: Press the **Address Recall/Pause** key to insert a pause (-) between two digits.

Press the ◀ or ▶ key to move the cursor.

To correct the number, press the **Clear** key to delete the digits one by one before reentering the number. To delete all entered digits and return to the default screen, press the **Reset** key.

- 4 Press the **OK** key. Proceed to step 12.

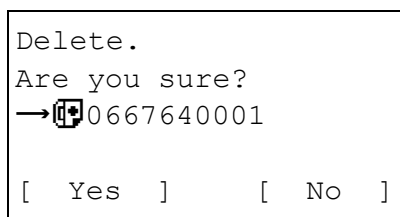
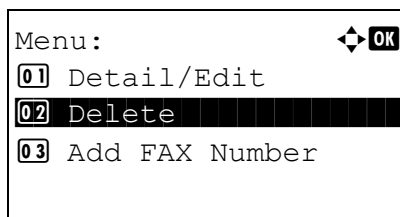

Deleting Permit FAX No.

- 1 Press the Δ or ∇ key to select [Delete].
- 2 Press the **OK** key.
- 3 Press [Yes] (the **Left Select** key). This deletes the Permit FAX number.

- 5 To change or delete other Permit FAX numbers, repeat steps 2 to 4.

Registering Reject FAX No.

NOTE: Up to 10 Reject FAX numbers can be registered.

- 1 Press the **System Menu/Counter** key.
- 2 Press the Δ or ∇ key to select [FAX].
- 3 Press the **OK** key.
- 4 Press the Δ or ∇ key to select [TX/RX Restrict.].
- 5 Press the **OK** key.
- 6 Press the Δ or ∇ key to select [Reject No. List].
- 7 Press the **OK** key.
- 8 Press [Menu] (the **Right Select** key).
- 9 Press the Δ or ∇ key to select [Add FAX Number].

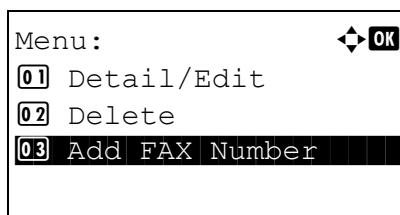
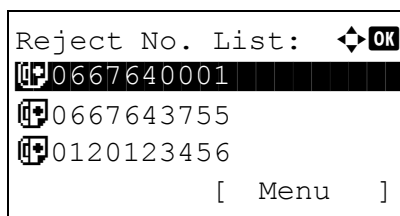

- 10 Press the **OK** key.

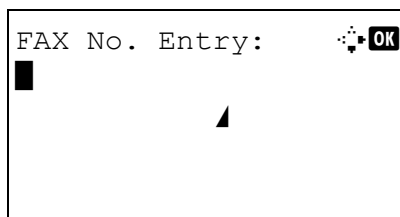

- 11 Use the numeric keys to enter a Reject FAX number. Up to 32 digits can be entered.

NOTE: Press the **Address Recall/Pause** key to insert a pause (-) between two digits.

Press the ◀ or ▶ key to move the cursor.

To correct the number, press the **Clear** key to delete the digits one by one before reentering the number. To delete all entered digits and return to the default screen, press the **Reset** key.

- 12 Press the **OK** key.

- 13 To register other Reject FAX numbers, repeat steps 8 to 12.

Changing and Deleting Reject FAX No.

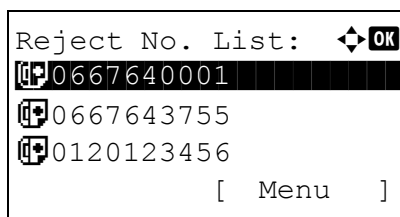

- 1 Follow steps 1 to 7 of *Registering Reject FAX No. on page 6-18*.
- 2 Press the ▲ or ▼ key to select the Reject FAX No. to be changed or deleted.

- 3 Press [Menu] (the **Right Select** key).

4 Changing Reject FAX No.

- 1 Press the ▲ or ▼ key to select [Detail/Edit].

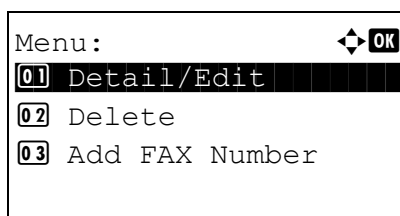

- 2 Press the **OK** key.

- 3 Use the numeric keys to reenter the Reject FAX number. Up to 32 digits can be entered.

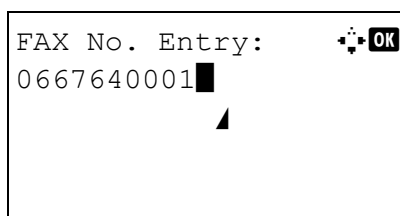

NOTE: Press the **Address Recall/Pause** key to insert a pause (-) between two digits.

Press the ◀ or ▶ key to move the cursor.

To correct the number, press the **Clear** key to delete the digits one by one before reentering the number. To delete all entered digits and return to the default screen, press the **Reset** key.

- 4 Press the **OK** key.

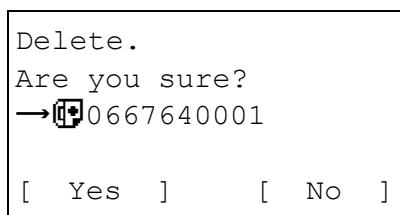
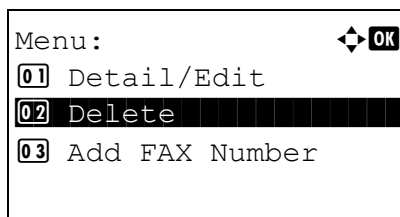

Deleting Reject FAX No.

- 1 Press the Δ or ∇ key to select [Delete].
- 2 Press the **OK** key.
- 3 Press [Yes] (the **Left Select** key). This deletes the Reject FAX number.
- 5 To change and delete other Reject FAX numbers, repeat steps 2 to 4.

Registering Permit ID No.

NOTE: Up to 5 Permit ID numbers can be registered.

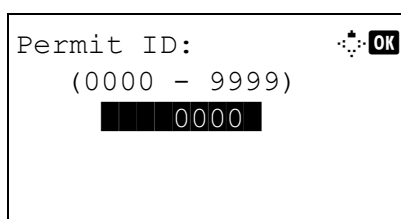
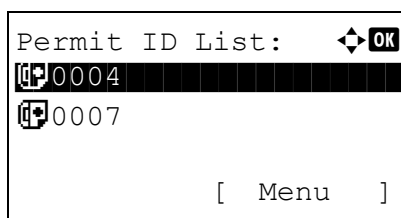

- 1 Press the **System Menu/Counter** key.
 - 2 Press the Δ or ∇ key to select [FAX].
 - 3 Press the **OK** key.
 - 4 Press the Δ or ∇ key to select [TX/RX Restrict.].
 - 5 Press the **OK** key.
 - 6 Press the Δ or ∇ key to select [Permit ID List].
 - 7 Press the **OK** key.
 - 8 Press [Menu] (the **Right Select** key).
 - 9 Press the Δ or ∇ key to select [Add FAX ID].
 - 10 Press the **OK** key.
 - 11 Use the numeric keys to enter a Permit ID number (0000 to 9999).
- NOTE:** Press the **Clear** key to display the previous number.
- 12 Press the **OK** key.
 - 13 To register other Permit ID numbers, repeat steps 8 to 12.

Changing and Deleting Permit ID No.

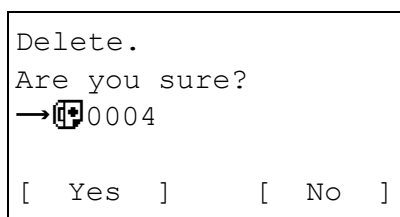
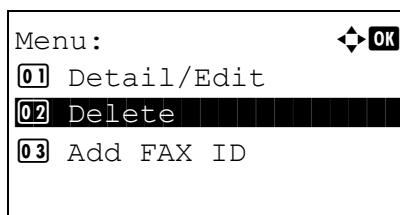
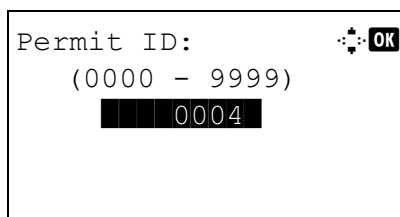
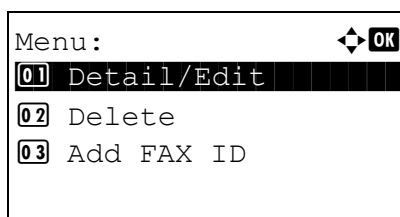
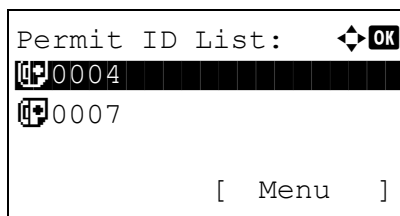

- 1 Follow steps 1 to 7 of *Registering Permit ID No.* on page 6-21.
- 2 Press the Δ or ∇ key to select the Permit ID No. to be changed or deleted.

- 3 Press [Menu] (the **Right Select** key).

4 Changing Permit ID No.

- 1 Press the Δ or ∇ key to select [Detail/Edit].

- 2 Press the **OK** key.

- 3 Use the numeric keys to reenter a Permit ID number (0000 to 9999).

NOTE: Press the **Clear** key to display the previous number.

- 4 Press the **OK** key.

Deleting Permit ID No.

- 1 Press the Δ or ∇ key to select [Delete].

- 2 Press the **OK** key.

- 3 Press [Yes] (the **Left Select** key). This deletes the Permit ID number.

- 5 To change and delete other Permit ID numbers, repeat step 2 to 4.

Setting Send Restriction

You can restrict the other parties to which you send originals only to the ones registered in Permit FAX No. and Permit ID No. as well as the ones registered in the Address Book. To change the sending restriction, follow the steps below.

- 1 Press the **System Menu/Counter** key.
- 2 Press the Δ or ∇ key to select [FAX].
- 3 Press the **OK** key.
- 4 Press the Δ or ∇ key to select [TX/RX Restrict.].
- 5 Press the **OK** key.
- 6 Press the Δ or ∇ key to select [TX Restriction].
- 7 Press the **OK** key.
- 8 Press the Δ or ∇ key to select sending restriction. To not use the sending restriction, select [Off]. To restrict the other parties only to the ones registered in Permit FAX No. and Permit ID No. as well as the ones registered in the Address Book, select [Permit+Addr Book].
- 9 Press the **OK** key.

Setting Reception Restriction

You can restrict incoming faxes so that you only receive originals from senders registered in Permit FAX No. and Permit ID No. and senders registered in your Address Book. This mode also allows you to set a [Reject List] for Reception Restriction so that reception from senders on the list of Rejected FAX numbers or from senders whose Local FAX Number is not registered are rejected. To change the reception restriction, follow the steps below.

- 1 Press the **System Menu/Counter** key.
- 2 Press the Δ or ∇ key to select [FAX].
- 3 Press the **OK** key.
- 4 Press the Δ or ∇ key to select [TX/RX Restrict.].
- 5 Press the **OK** key.
- 6 Press the Δ or ∇ key to select [RX Restriction].
- 7 Press the **OK** key.
- 8 Press the Δ or ∇ key to select reception restriction. To not use the reception restriction, select [Off]. To restrict the other parties only to the ones registered in Permit FAX No. and Permit ID No. as well as the ones registered in the Address Book, select [Permit+Addr Book]. To block incoming faxes from senders registered in Reject FAX No., select [Reject List].
- 9 Press the **OK** key.

Encryption

This method allows you to communicate with originals encrypted by the sending system. Therefore, even when a third party tries to view the originals in the middle of communication by some means, the third party is prevented from knowing the actual contents of the originals. The originals received are reverted to the originals as they were before transmission (decrypted) by the receiving system, and printed. This is an extremely effective communication method for sending confidential documents that are not to be opened by a third party.

IMPORTANT: In order to use encryption communication, the fax of the other party needs to be an our-brand system with the same type of encryption functions.

In encryption communication, in order to encrypt and decrypt originals, the sending and receiving systems must use the same 16-digit encryption key. When the encryption key differs between the sending system and the receiving system, the encryption cannot be conducted. Therefore, the sending system and the receiving system need to have the same encryption key and 2-digit key No. registered in advance.

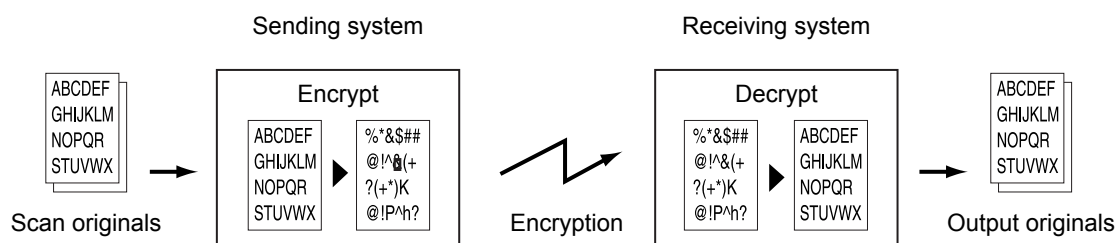

Description of settings at sending and receiving systems

Settings	Sending system	Receiving system	Reference page
Encryption Key No.	(A) 2 digits	(B) 2 digits	6-25
Encryption Key	(C) 16 digits	(C) 16 digits	6-25
Key No. of Address Book (or when the number is directly dialed)	(A) 2 digits		6-25
Receiving system encryption box number †	(D) 4 digits		6-27
Encryption Box No. †		(D) 4 digits	-
Key No. in reception setting		(B) 2 digits	6-28

†. When the machine receives originals, the Encryption Box is not used.

NOTE: Set the same characters for the numbers indicated by the same letter in parentheses. For example, the same characters should be used as the encryption key (C) in both the sending and receiving systems.

Registering an Encryption Key

An encryption key is required when registering the Address Book used for encryption communication (the other party is directly entered using the numeric keys) in the sending system and when setting encryption in the receiving system.

For the creation of the encryption key, numbers from 0 to 9 and letters from A to F are arranged to form 16 numbers and/or letters arbitrarily.

NOTE: Up to 20 encryption keys can be registered.

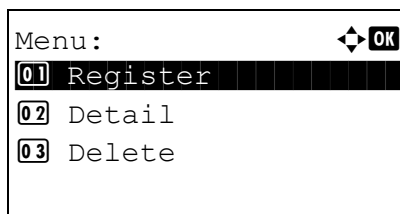
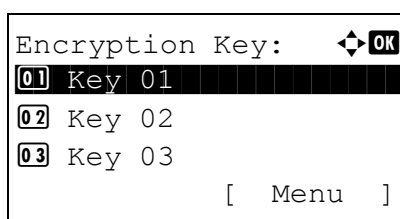

- 1 Press the **System Menu/Counter** key.
 - 2 Press the Δ or ∇ key to select [FAX].
 - 3 Press the **OK** key.
 - 4 Press the Δ or ∇ key to select [TX/RX Common].
 - 5 Press the **OK** key.
 - 6 Press the Δ or ∇ key to select [Encryption Key].
 - 7 Press the **OK** key.
 - 8 Press the Δ or ∇ key to select an unregistered encryption key, and then press [Menu] (the **Right Select** key).
 - 9 Press the Δ or ∇ key to select [Register].
- NOTE:** Refer to *Character Entry Method* on Appendix-2 for details on entering characters.
- 10 Press the **OK** key.
 - 11 Use the numeric keys to enter the encryption key. Up to 16 digits can be entered.
 - 12 Press the **OK** key.
 - 13 Repeat steps 8 to 12 to register other encryption keys.

Confirming and Deleting Registration Contents of Encryption Key

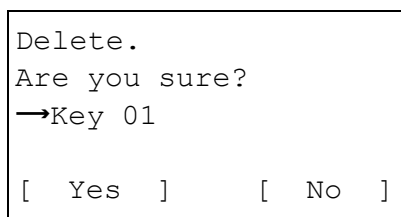
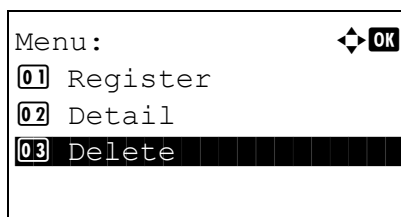
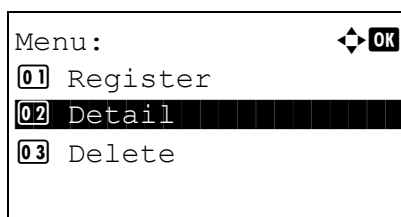
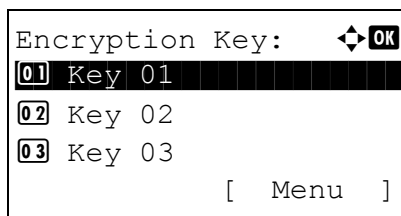

- 1 Follow steps 1 to 7 of *Registering an Encryption Key* on page 6-25.
- 2 Press the Δ or ∇ key to select the encryption key that you want to confirm or delete.

- 3 Press [Menu] (the **Right Select** key).

4 Confirming Registration Contents of Encryption Key

- 1 Press the Δ or ∇ key to select [Detail].

- 2 Press the **OK** key.

Deleting Encryption Key

- 1 Press the Δ or ∇ key to select [Delete].

- 2 Press the **OK** key.

- 3 Press [Yes] (the **Left Select** key). This deletes the encryption key.

- 5 Repeat steps 2 to 4 to confirm or delete other encryption keys.



Operation at the Sending System

When sending originals by encrypted transmission, use the Address Book registered for encryption or set encrypted transmission when dialing directly using the numeric keys.

NOTE: Encrypted transmission can be also used in broadcast transmission.

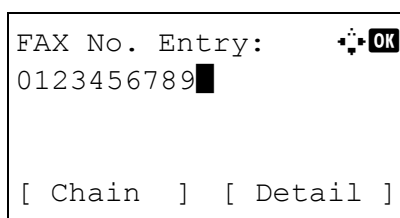
With encryption communication, you cannot conduct sub address communication.



FAX No. Entry: 
 0123456789 
 [Chain] [Detail]

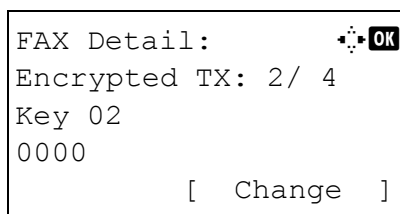

FAX Detail: 
 Encrypted TX: 2 / 4
 Key 02
 0000
 [Change]

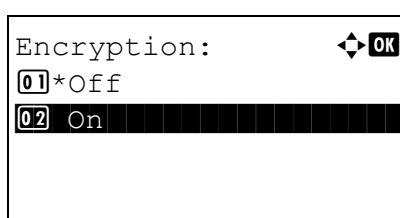

Encryption: 
 01 *Off
 02 On

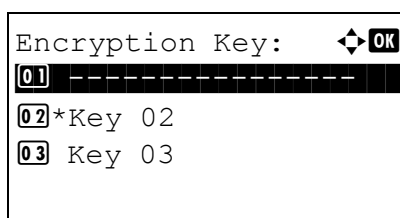

Encryption Key: 
 01 -----
 02 *Key 02
 03 Key 03

- 1 Register the encryption key you have arranged with the receiving system. (Refer to *Registering an Encryption Key on page 6-25.*) When an encryption key has already been registered, go to the next step.
- 2 Press the **FAX** key.
- 3 Place the originals.
- 4 Use the numeric keys to enter the FAX number of the other party, and press [Detail] (the **Right Select** key).

NOTE: When encrypted transmission has been set to a destination in the Address Book or **One-touch** keys, you can use the destination.

- 5 Press the < or > key to select [Encrypted TX].
- 6 Press the **OK** key.
- 7 Press the Δ or ∇ key to select [On].
- 8 Press the **OK** key.
- 9 Press the Δ or ∇ key to select the desired encryption key number.
- 10 Press the **OK** key.

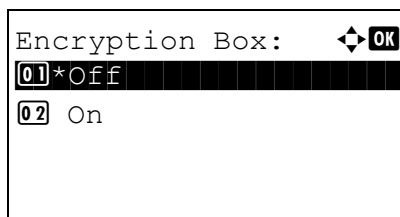

11 Press the Δ or ∇ key to select [On] or [Off].

NOTE: When the machine receives originals, the encryption box is not used.

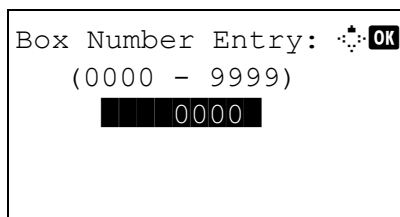

12 Press the **OK** key. Proceed to the next step or step 15 when [On] or [Off] is selected in step 11, respectively.

13 Use the numeric keys to enter the box number (0000 to 9999).

14 Press the **OK** key.

15 Press the **Start** key. The transmission will start.

Operation at the Receiving System

To conduct encryption communication operating the receiving system, follow the steps below.

NOTE: In encryption communication, sub address communication cannot be used.

- 1** Register the encryption key you have arranged with the sending system. (Refer to *Registering an Encryption Key on page 6-25.*)
- 2** Press the **System Menu/Counter** key.
- 3** Press the Δ or ∇ key to select [FAX].
- 4** Press the **OK** key.
- 5** Press the Δ or ∇ key to select [Reception].
- 6** Press the **OK** key.
- 7** Press the Δ or ∇ key to select [Encryption RX].
- 8** Press the **OK** key.
- 9** Press the Δ or ∇ key to select [On].

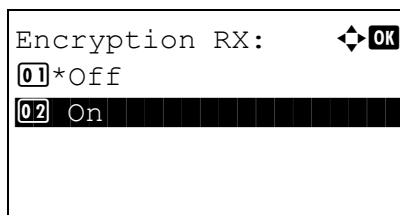

10 Press the **OK** key.

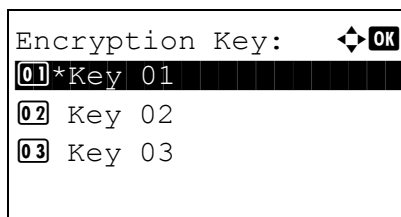

11 Press the Δ or ∇ key to select the desired encryption key number.

12 Press the **OK** key.

13 The sending system conducts encrypted transmission. When encryption communication is conducted normally, the machine decrypts the encrypted originals received and prints the originals.

Duplex Print Output

When received multiple pages of data are the same width, they can be printed out on both sides of paper having the same width as the data.

- 1** Press the **System Menu/Counter** key.
- 2** Press the Δ or ∇ key to select [FAX].
- 3** Press the **OK** key.
- 4** Press the Δ or ∇ key to select [Reception].
- 5** Press the **OK** key.
- 6** Press the Δ or ∇ key to select [Duplex Printing].
- 7** Press the **OK** key.
- 8** Press the Δ or ∇ key to select [On] or [Off].
- 9** Press the **OK** key.

2 in 1 Reception

When you receive a multi-page Statement or A5 size original, this function prints 2 pages of the original at a time on one Letter or A4 size sheet of paper.

- 1 Press the **System Menu/Counter** key.
- 2 Press the Δ or ∇ key to select [FAX].
- 3 Press the **OK** key.
- 4 Press the Δ or ∇ key to select [Reception].
- 5 Press the **OK** key.
- 6 Press the Δ or ∇ key to select [2 in 1 Printing].
- 7 Press the **OK** key.
- 8 Press the Δ or ∇ key to select [On] or [Off].
- 9 Press the **OK** key.

Print all at once [Batch Print]

When a multi-page fax is received, if [On] is set, the pages are printed in a batch after all pages are received. If [Off] is set, each page is printed as it is received.

- 1 Press the **System Menu/Counter** key.
- 2 Press the Δ or ∇ key to select [FAX].
- 3 Press the **OK** key.
- 4 Press the Δ or ∇ key to select [Reception].
- 5 Press the **OK** key.
- 6 Press the Δ or ∇ key to select [Batch Print].
- 7 Press the **OK** key.
- 8 Press the Δ or ∇ key to select [On] or [Off].
- 9 Press the **OK** key.

Select Key Set

If you register a function to the **Left Select** key or **Right Select** key, you can quickly set the function when using fax functions.

You can register one of the following functions to each key.

- None
- Original Size
- Original Image
- FAX Resolution
- Orig.Orientation
- Continuous Scan
- File Name Entry
- JobFinish Notice
- FAX Delayed TX
- FAX Direct TX
- FAX RX Polling
- Density
- Duplex

- 1** Press the **System Menu/Counter** key.
- 2** Press the Δ or ∇ key to select [FAX].
- 3** Press the **OK** key.
- 4** Press the Δ or ∇ key to select [Select Key Set.].
- 5** Press the **OK** key.
- 6** Press the Δ or ∇ key to select [Left] or [Right].
- 7** Press the **OK** key.
- 8** Press the Δ or ∇ key to select the function you want to register to the flexible key.
- 9** Press the **OK** key.

IMPORTANT: If you try to set the function that is registered to the other flexible key, you cannot set it and *This function is already registered.* is displayed.

Remote Diagnostics

If a problem arises with this machine and you contact our service representative, this feature enables our Service Center computer to access the machine over the phone and check the machine's status or look for problems.

NOTE: To use Remote Diagnostics, you must first sign an agreement with our service representative and register a Predetermined ID on the machine. For more information, contact your Service Representative or Authorized Service Center.

- 1** Press the **System Menu/Counter** key.
- 2** Press the Δ or ∇ key to select [Adjust/Maint.].
- 3** Press the **OK** key.
- 4** Press the Δ or ∇ key to select [Service Setting].
- 5** Press the **OK** key.
- 6** Press the Δ or ∇ key to select [Remote Diag.Set.].
- 7** Press the **OK** key.
- 8** Press the Δ or ∇ key to select [On].
- 9** Press the **OK** key.
- 10** Press the Δ or ∇ key to select [Remote Diag. ID].
- 11** Use the numeric keys to enter the prespecified remote diagnostics ID number (0000 to 9999).
- 12** Press the **OK** key.

Prohibiting FAX Printing at Specified Times (Unusable Time)

This feature sets a time period during which the machine will not print received faxes.

Faxes received during this Unusable Time are printed when the setting is unlocked.

IMPORTANT: When Unusable Time is set, in addition to FAX printing, all other operations are all prohibited during the unusable time period, including printing of copy jobs, printer jobs and received e-mails, printing and sending from USB Memory and Network FAX transmission.

- 1 Press the **System Menu/Counter** key.
- 2 Press the Δ or ∇ key to select [Common Settings].
- 3 Press the **OK** key.
- 4 Press the Δ or ∇ key to select [Timer Setting].
- 5 Press the **OK** key.
- 6 Press the Δ or ∇ key to select [Unusable Time].
- 7 Press the **OK** key.
- 8 Press the Δ or ∇ key to select [On].
- 9 Press the **OK** key.
- 10 Press the Δ or ∇ key to enter the start time.
- 11 Press the **OK** key.
- 12 Press the Δ or ∇ key to enter the end time.
- 13 Press the **OK** key.

NOTE: If the same time is set as the start time and end time, you cannot use all day.

- 14 Specify the code to temporarily cancel the unusable setting during unusable time.

Set a four digit [Unlock Code] using the numeric keys.

NOTE: To use the machine temporarily during unusable time, press [Code] (the **Right Select** key) in the Unusable Time message screen. Then, enter the Unlock code using the numeric keys and press [Login] (the **Right Select** key).

- 15 Press the **OK** key.

7 About Network FAX

This chapter explains how to use Network FAX.

Please also read the *Network FAX Driver Operation Guide* (Online Manual) contained in the included CD-ROM, which describes how to operate your PC to send a fax using Network FAX and make various settings.

- What is Network FAX? 7-2
- Setup 7-3

What is Network FAX?

The Network FAX function enables any PC, which is networked to the machine, to perform sending and receiving of faxes. Its primary features include the following.

- PC-prepared document can be sent and received by fax without being printed out.
- An Address Book (in the machine/PC) can be used to specify a desired destination.
- Addition of a cover page.
- Transmission and printing can be done simultaneously.
- E-mail reporting of the transmission result.
- Sub address transmission is available.
- Operation is as simple as printing.

Flow of Network FAX Sending

Network FAX sending is performed in the following sequence.

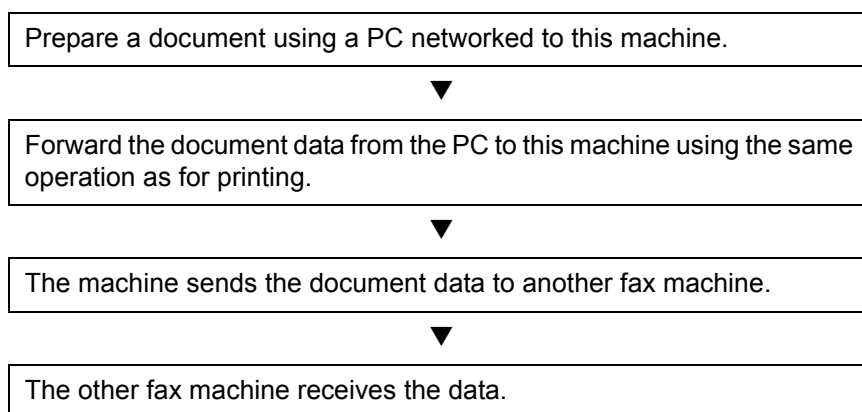

Flow of Network FAX Receiving

Network FAX receiving is performed in the following sequence.

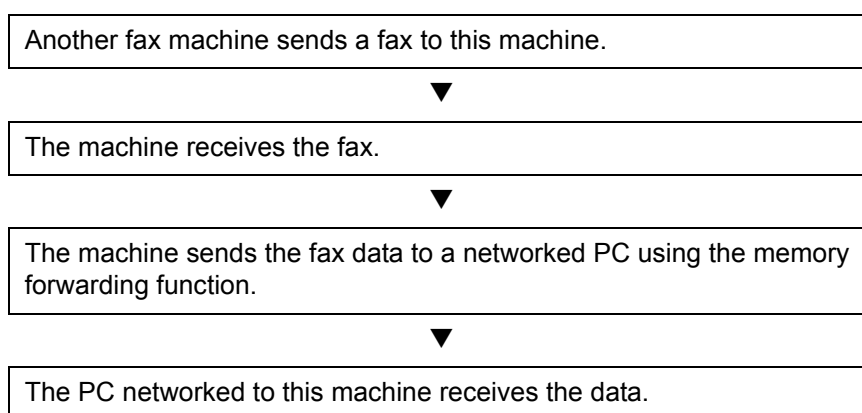

NOTE: The memory forwarding function allows not only reception by the networked PC, but also forwarding of the received fax by e-mail, forwarding to another fax machine, or storing in the Sub Address Box.

Setup

The following preparation is needed before using Network FAX.

Flow of Setup

Connection to a PC

Connect the machine to a PC using the network cable. For details, refer to the machine's *Operation Guide*.

Machine Registration

Using the memory transmission function, select the recipient PC or file format.

NOTE: Use the memory transmission function to forward the received fax to the PC or forward it as an e-mail attachment. For details, refer to *Printing/Forwarding Received Documents (Memory Forwarding)* on page 4-13.

Installing Software on the PC

Install the dedicated software (included in the supplied CD-ROM) on your PC required to use Network FAX. For details, refer to the *Network FAX Driver Operation Guide* contained in the included CD-ROM.

Network FAX Driver Operation Guide

The *Network FAX Driver Operation Guide* (Online Manual) is contained in the included CD-ROM in PDF (Portable Document Format). The main contents include the following.

- Installing Network FAX Driver
- Performing Network FAX Sending
- Specifying the Network FAX Transmission Settings
- Specifying the Cover Letter Settings

Opening the Online Manual

Follow the steps below to refer to the online manual.

- 1** Insert the CD-ROM supplied with the machine into the CD-ROM drive. *An explanation of the licensing agreement* is displayed. If you agree to the terms of the agreement, click **Accept**. The main menu screen then appears.
- 2** Click **Software Documentation**, and then **Network FAX Driver**. The online manual appears.

NOTE: Adobe Reader 8.0 or later needs to be installed to view the online manual.

8 Troubleshooting

This chapter explains how to deal with problems.

- Indicators During Sending/Receiving Operation 8-2
- Precautions When Turning Power OFF..... 8-2
- Error Messages 8-3
- Troubleshooting..... 8-5

Indicators During Sending/Receiving Operation

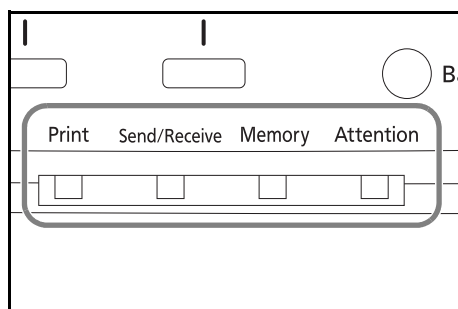

The **Send/Receive** and **Memory** indicators show the fax transmission status.

- The **Send/Receive** indicator blinks when the machine is sending/receiving a fax.
- The **Memory** indicator blinks when source data is being stored in memory for memory transmission.
- The **Memory** indicator is lit when there is source data stored in the memory for delayed transmission.

Precautions When Turning Power OFF

To receive faxes with the power turned off, press the **Power** key on the operation panel. You cannot automatically receive a fax when the main power switch is turned off.

Before turning off the main power switch, press the **Power** key on the operation panel. Make sure that the **Memory** indicator is off before turning off the main power switch.



CAUTION: The device may still be operating as long as the **Memory** indicator is lit. Turning the machine off at the main power switch while the memory indicator lites, may cause malfunctions.

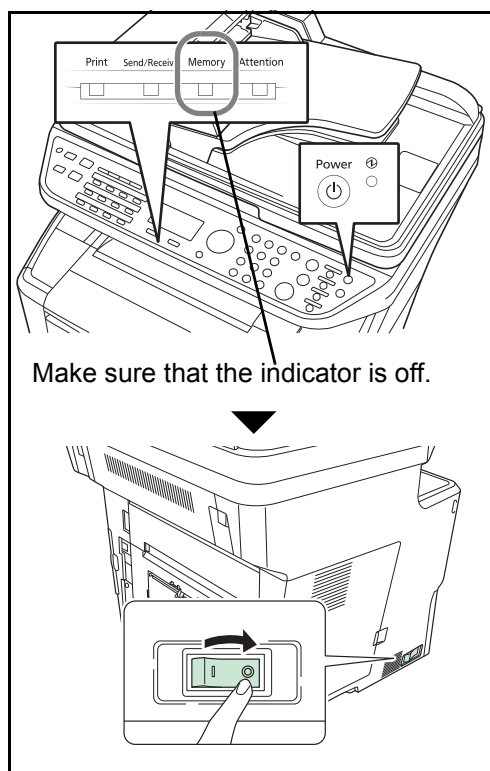

Error Messages

When an error occurs, the display may show one of the error messages listed below. These will help you identify and correct the problem.

NOTE: When a transmission error occurs, a sent/receipt result report is produced. Check the error code shown in the report and refer to the *Error Code List on page 11 of the Appendix* for a description. To print the sent/receipt result report, refer to *Send Result Reports on page 5-5* and *FAX RX Result Reports on page 5-6*.

You may also check error codes using the activity report. (Refer to *Activity Report on page 5-7*.)

Message	Checkpoint	Corrective Action	Reference Page
<i>Machine failure. Call service.</i>	–	Turn the main power switch off and on, or unplug the power cord and plug it in again. If the message still appears, note the error code. Turn the main power switch off and unplug the power cord. Call your service representative.	–
<i>Polling box limit exceeded. Job is canceled.</i>	–	Polling box capacity is used up with document data. Press the OK key. The job is canceled. Try to perform the job again after printing or deleting the data in the polling box.	4-33
<i>Job Accounting restriction exceeded.</i>	–	The number of paper used has exceeded the limit preset by Job Accounting. No further operation is possible. Press the OK key. The job is canceled. Try to perform the job again after resetting the limit for paper use.	Refer to the machine's <i>Operation Guide</i> .
<i>Job Accounting restriction exceeded. Cannot scan.</i>	–	Fax transmission is prohibited by Job Accounting. No further operation is possible. Press the OK key. The job is canceled. Check the setting for Job Accounting.	Refer to the machine's <i>Operation Guide</i> .
<i>The phone receiver is off the hook. Hang Up.</i>	Is the phone (commercially available) connected to the machine off the hook?	Hang up the handset.	–

Message	Checkpoint	Corrective Action	Reference Page
<i>Scheduled sending jobs exceeded.</i>	–	The number of jobs has exceeded the limit set for delayed transmission. Press the OK key. The job is canceled. Wait until the delayed transmission is executed, or cancel the delayed transmission and then perform the job again.	4-2
<i>Add paper in cassette 1 (~3). or Add paper in MP tray.</i>	Is the indicated cassette or MP tray out of paper?	Add paper of the same size as indicated. When the type of printing paper is specified, the necessary paper types are also displayed. To use another paper source, select the paper source and press the OK key. To use another paper source, press [Paper] (the Right Select key), select the desired paper source, and then press the OK key.	–
	Is the type of printing paper specified?	The cassette for the specified paper type is not available. Press [Paper] (the Right Select key), select another paper source, and then press the OK key.	–
	Is the cassette securely loaded?	Remove the cassette and reload it completely.	–

Troubleshooting

When a problem occurs, first check the following. If the problem persists, contact your dealer or service representative.

Symptom	Checkpoint	Corrective Action	Reference Page
Cannot send document.	Is the modular cord connected correctly?	Connect the modular cord correctly.	–
	Is <i>Communication error</i> displayed?	Remedy the cause of error and send again.	<i>Appendix-11</i>
	Is TX (transmission) restriction activated?	Cancel the TX restriction.	6-15
Cannot perform broadcast transmission.	Is free space available in the memory?	Send after the memory has free space, or create free space in the memory.	4-4
Cannot perform encrypted communication.	Are the registrations correct both at sender and recipient?	Double-check the registrations both at sender and recipient.	6-24
Cannot use the remote switching function.	Is a pulse line used?	Some phones may transmit tone signals using buttons. Refer to the operation manual of your phone set.	–
	Is the remote switching number correct?	Check the registration. (Default: 55)	4-11
No print output after reception.	Is memory forwarding activated?	Check the forwarding destination.	–
Cannot receive document.	Is the modular cord connected correctly?	Connect the modular cord correctly.	–
	Is <i>Communication error</i> displayed?	Remedy the cause of error and ask the sender to retry.	<i>Appendix-11</i>
	Is RX (reception) restriction activated?	Cancel the RX restriction.	6-23
Cannot perform memory reception.	Is free space available in the memory?	Receive after the memory has free space, or create free space in the memory.	3-9

Symptom	Checkpoint	Corrective Action	Reference Page
Cannot perform sub address transmission.	Is the recipient fax machine equipped with a sub address transmission feature?	Sub address transmission cannot be performed unless the recipient fax machine has a similar sub address transmission feature.	–
	Is the entered sub address or sub address password identical to the sub address or sub address password registered in the recipient fax machine?	If your entry is correct, check with the recipient. This machine does not use a sub address password for reception.	4-25
	Is free space available in the memory of the recipient fax machine?	Check with the recipient.	–
Cannot perform memory forwarding.	Is memory forwarding set to [On]?	Check the memory forwarding setting.	4-13
Cannot perform memory forwarding using a sub address.	Is the recipient fax machine equipped with a sub address transmission feature?	Sub address transmission cannot be performed unless the recipient fax machine has a similar sub address transmission feature.	–
	Is the entered sub address identical to the sub address registered in the recipient fax machine?	If your entry is correct, check with the recipient. This machine does not use a sub address password for reception.	4-13
Cannot store memory forwarding data in a Sub Address Box.	Is the memory forwarding setting correctly?	Check the memory forwarding setting.	4-13
	Is free space available in the memory?	Receive after the memory has free space, or create free space in the memory.	4-25
Cannot output from a Sub Address Box.	Is the box password been set?	Enter the correct box password.	4-25
Cannot use polling reception.	Is polling transmission being used correctly on the sending machine?	Check with the recipient.	–
Cannot use sub address relay broadcast communication.	Is free space available in the memory?	Free up some space in memory and then send, or simply make some free space in memory.	–

Appendix

- Character Entry MethodAppendix-2
- Specifications (Fax function)Appendix-6
- Menu List.....Appendix-7
- Received FAX Sizes and Paper Priority (Inch Model).....Appendix-9
- Received FAX Sizes and Paper Priority (Metric Model)Appendix-10
- Error Code List.....Appendix-11

Character Entry Method

In character entry screens, use the procedure below to enter characters.

Keys Used

Use the following keys to enter characters.

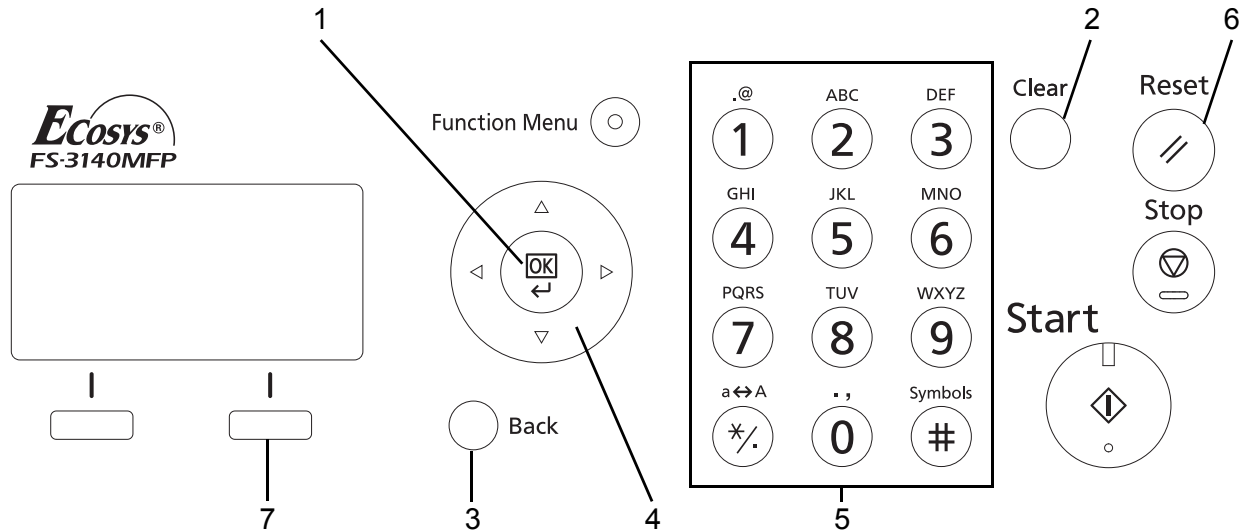

- 1. OK Key** Press this key to finalize the entered character(s).
- 2. Clear Key** Press this key to delete the character at the cursor position. If the cursor is at the end of the line, the character to the left of it is deleted.
- 3. Back Key** Press this key to return to the screen from which you invoked the character entry screen.
- 4. Cursor Keys** Use these to select the entry position, or select a character from the character list.
- 5. Numeric Keys** Use these keys to select the character you want to enter.
- 6. Reset Key** Press this key to cancel the character entry procedure and return to the standby screen.
- 7. Right Select Key** Press this key to select the type of characters you want to enter. (When [Text] is displayed)

Selecting Type of Characters

To enter characters, the following three types are available:

- ABC** To enter alphabets.
- 123** To enter numerals.
- Symbols** To enter symbols.

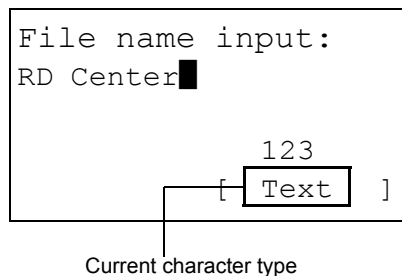

In a character entry screen, press [Text] (the **Right Select** key) to select the type of characters you want to enter.

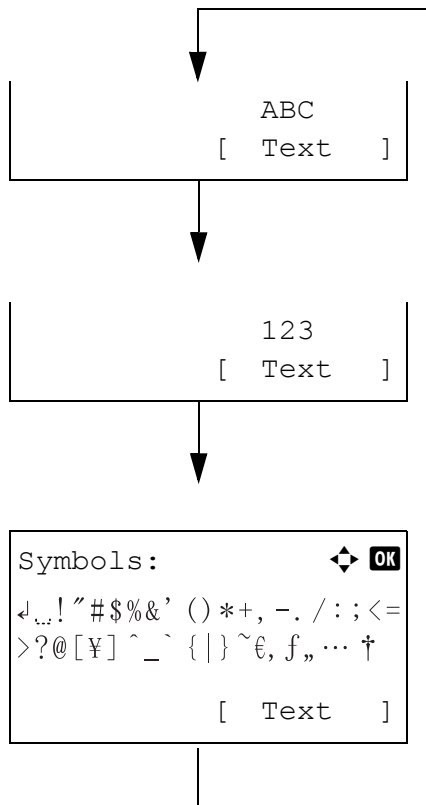

Each time you press [Text] (the **Right Select** key), the character type switches as follows: ABC, 123, Symbol, ABC ...

NOTE: By pressing on the numeric keys while entering characters, you can directly display the Symbols screen.

Entering Characters

After selecting a character type, use the procedure below to enter characters.

Entering Alphabets and Numerals

Referring to the table below, press the key corresponding to the character you want to enter until it is displayed.

Key	Entry mode	Available characters
① . @	Alphabetic/Symbol	. @ - _ / : ~ 1
	Numeric	1
② ABC	Alphabetic/Symbol	a b c A B C 2
	Numeric	2
③ DEF	Alphabetic/Symbol	d e f D E F 3
	Numeric	3
④ GHI	Alphabetic/Symbol	g h i G H I 4
	Numeric	4
⑤ JKL	Alphabetic/Symbol	j k l J K L 5
	Numeric	5
⑥ MNO	Alphabetic/Symbol	m n o M N O 6
	Numeric	6
⑦ PQRS	Alphabetic/Symbol	p q r s P Q R S 7
	Numeric	7
⑧ TUV	Alphabetic/Symbol	t u v T U V 8
	Numeric	8
⑨ WXYZ	Alphabetic/Symbol	w x y z W X Y Z 9
	Numeric	9
⑩ .,	Alphabetic/Symbol	. , - _ ' ! ? (space) 0
	Numeric	0
a↔A */.	Alphabetic/Symbol	Switch between upper-/lowercase
	Numeric	* or . (decimal point) [†]
Symbols #	Alphabetic/Symbol	#
	Numeric	

†. '*' is entered when [123] is selected in the character type selection, or '.' is entered when only numerals are entered and no character type is selected.

Characters associated with different keys can be entered consecutively. To enter a character associated with the same key after another, use cursor keys to move the cursor to the next entry position before entering it.

If you use cursor keys to move the cursor to an entry position apart from the end of the line and enter a character there, spaces are automatically entered in between.

Entering Symbols

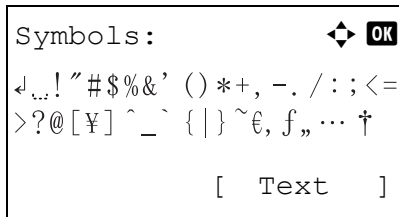

Press [Text] (the **Right Select** key) or # on the numeric keys to display the Symbols screen. Use cursor keys to select the symbol you want to enter and then press the **OK** key.

Entry When [Select Character] Is Selected in Login Operation Settings

In the login screen that appears when user management is enabled, the character entry method may vary depending on the settings. (For the Login Operation, refer to the machine's *Operation Guide*.)

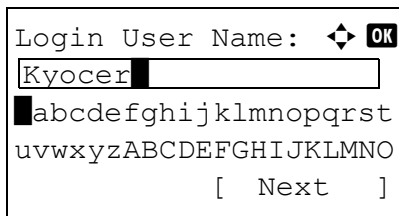

If a character palette appears on the screen, use cursor keys to select the desired character from the displayed characters, and then press the **OK** key to enter it.

NOTE: Numerals can be entered directly by pressing numeric keys.

Specifications (Fax function)

NOTE: Specifications are subject to change without notice.

Item	Description
Type	FS-3140MFP
Compatibility	G3
Communication Line	Subscriber telephone line
Transmission Time	3 seconds or less (33600 bps, JBIG, ITU-T A4 #1 chart)
Transmission Speed	33600/31200/28800/26400/24000/21600/19200/16800/14400/12000/9600/ 7200/4800/2400 bps
Coding Scheme	JBIG/MMR/MR/MH
Error Correction	ECM
Original Size	Max. width: 8.5"/215 mm, Max. length: 14"/355.6 mm
Automatic Document Feed	Max. 50 sheets
Scanner Resolution	Horizontal × Vertical 200 × 100 dpi Normal (8 dot/mm × 3.85 line/mm) 200 × 200 dpi Fine (8 dot/mm × 7.7 line/mm) 200 × 400 dpi Super Fine (8 dot/mm × 15.4 line/mm) 400 × 400 dpi Ultra Fine (16 dot/mm × 15.4 line/mm)
Printing Resolution	600 × 600 dpi
Gradations	256 shades (Error diffusion)
One-Touch Key	22 keys
Multi-Station Transmission	Max. 100 destinations
Substitute Memory Reception	256 sheets or more (when using ITU-T A4 #1)
Image Memory Capacity	3.5 MB (standard) (for incoming faxed originals)
Report Output	Sent result report, FAX RX result report, Activity report, Status page

Menu List

The function keys on the message display and operation panel have the following menus. Refer to this list as necessary when you operate the machine.

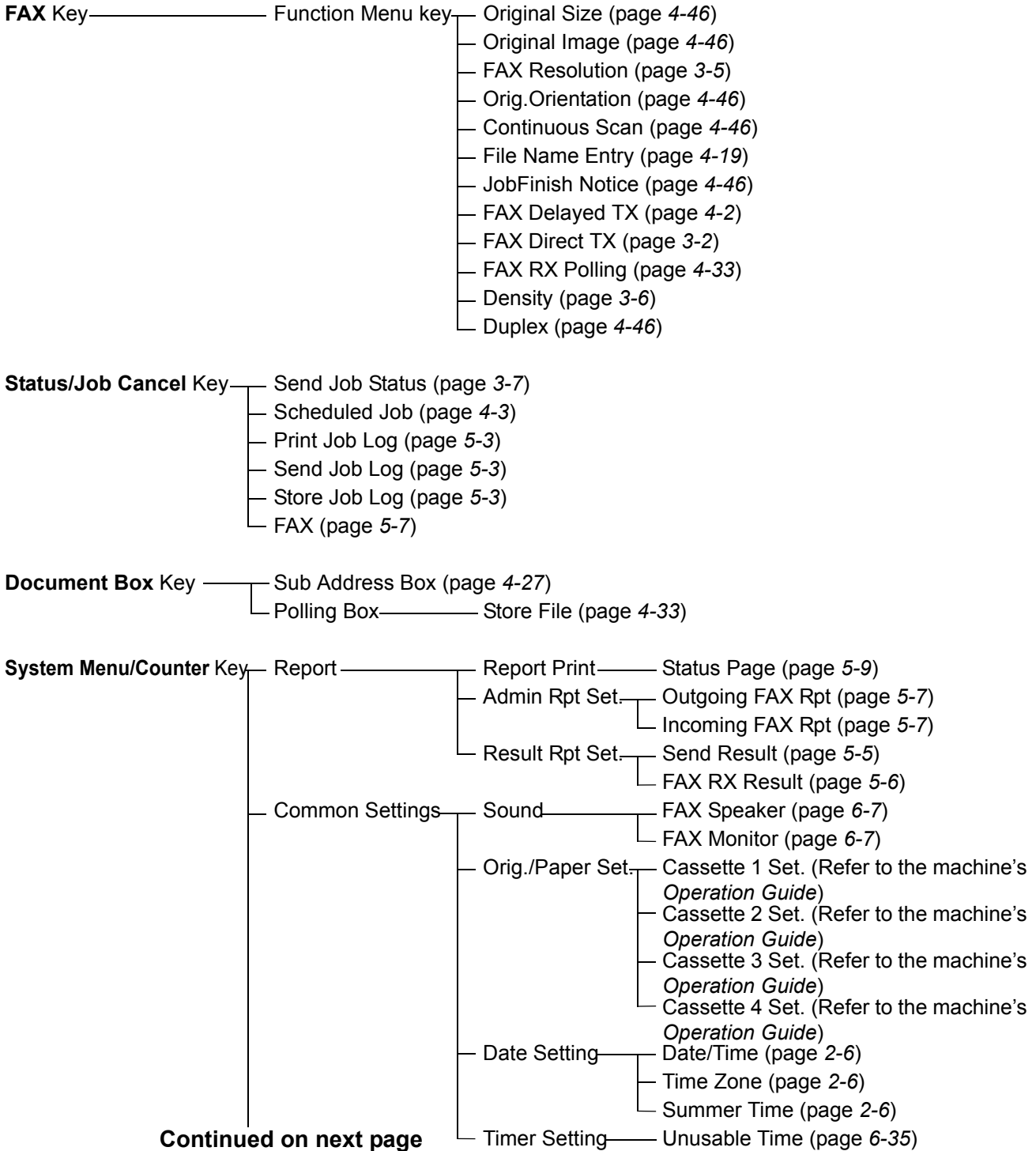

Continued from previous page

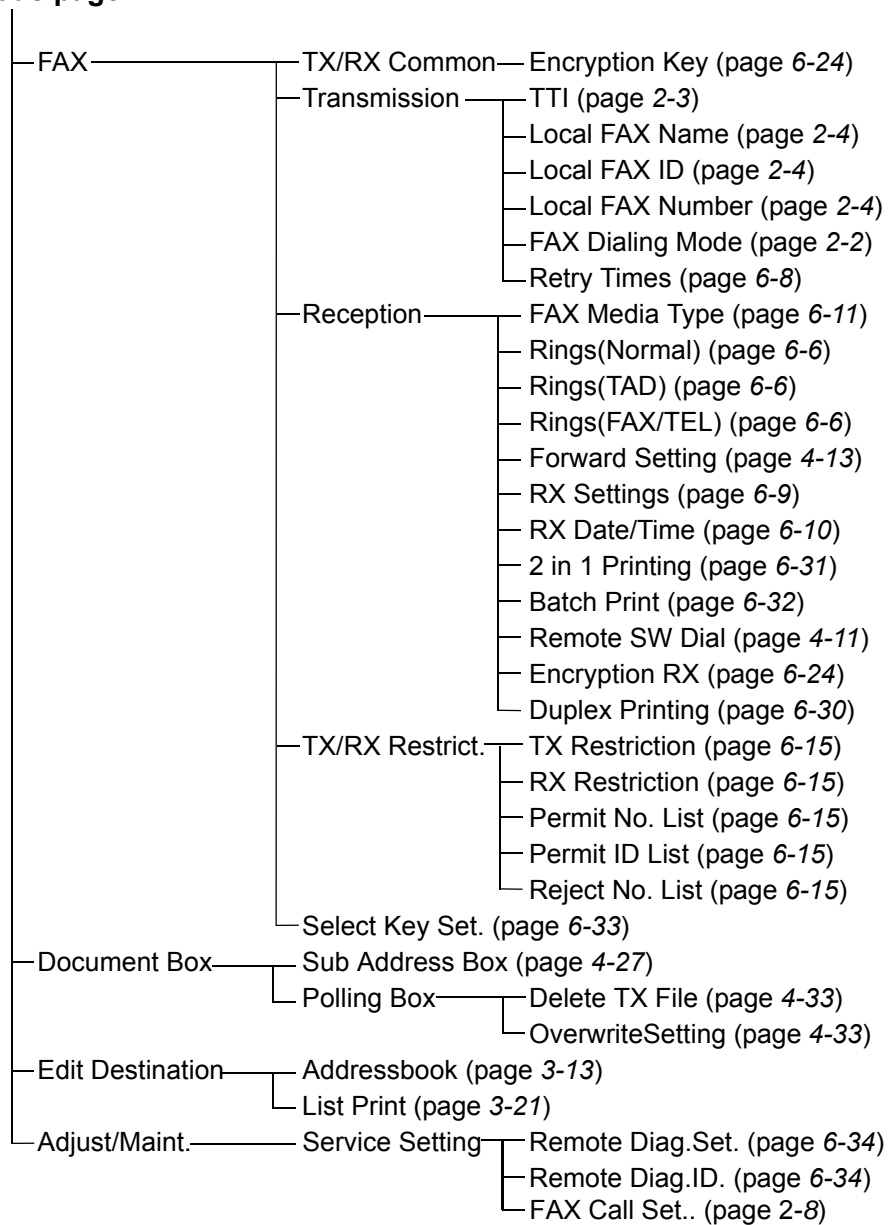

Received FAX Sizes and Paper Priority (Inch Model)

When no paper loaded in the cassettes matches the received fax size and orientation, the machine automatically chooses the printing paper according to the following priority.

Same Size Override

		Received FAX Size		
		ST	LT	LG
Paper Size	1	ST	LT	†, †† LT
	2	LT	LG	†† LT
	3	LG		† LT

†. Paper orientation is different from the received document. The image is printed after being rotated 90° automatically.

††. Received Legal size document is reduced to match Letter size paper.

: indicates print output on two sheets.

NOTE: The abbreviations denote the following paper sizes.

ST: Statement

LT: Letter

LG: Legal

When a paper type is selected in *Media Type*, a received fax is printed using the matching paper source. (Refer to page 6-11.)

Even if [All Media Types] is selected, paper types such as transparency cannot be used for fax printouts.

Received FAX Sizes and Paper Priority (Metric Model)

When no paper loaded in the cassettes matches the received fax size and orientation, the machine automatically chooses the printing paper according to the following priority.

Same Size Override

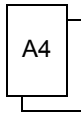
		Received FAX Size		
		A5	A4	FL
Paper Size	Priority			
	1	† A5	A4	† FL
	2	A4	FL	†, †† A4
	3	FL		A4 
4	† B5			

†. Paper orientation is different from the received document.
The image is printed after being rotated 90° automatically.

††. Folio size original is reduced to match A4 size paper.

: indicates print output on two sheets.

NOTE: The abbreviations denote the following paper sizes.

FL: Folio

When a paper type is selected in *Media Type*, a received fax is printed using the matching paper source. (*Refer to page 6-11.*)

Even if [All Media Types] is selected, paper types such as transparency cannot be used for fax printouts.

Error Code List

When a transmission error occurs, one of the following error codes is recorded in the TX/RX Result Report and Activity Report.

NOTE: If an error occurs during V34 communication, the *U* in the error codes is replaced by an *E*.

Error Code	Possible Cause/Action
Busy	Failed to establish connection with the recipient despite auto redialing the preset number of times. Send again.
CANCELED	Transmission was canceled due to an action to cancel transmission. Reception was canceled due to an action to cancel reception.
U00300	Paper depletion occurred at the recipient machine. Check with the recipient.
U00420 - U00462	Reception was canceled because of mismatching of communication features with the sender machine although the line connection was established.
U00600 - U00690	Communication was stopped due to the machine failure. Send or receive again.
U00700	Communication was stopped due to failure on the part of the sender or recipient machine.
U00800 - U00810	Page(s) not sent correctly. Send again.
U00900 - U00910	Page(s) not received correctly. Ask the sender to resend.
U01000 - U01092	Communication error occurred during transmission. Send again.
U01100 - U01199	Communication error occurred during reception. Ask the sender to resend.
U01400	Failed to establish communication with the sender or recipient machine because dialing registered for a push line system was used in a pulse line system.
U01500	Communication error occurred during high-speed transmission. Send again.
U01600	Communication error occurred during reception of high-speed transmission. Ask the sender to reduce the transmission speed and send again.
U01700 - U01720	Communication error occurred during high-speed transmission. Send again.

Error Code	Possible Cause/Action
U01721	Communication error occurred during high-speed transmission. Designated transmission speed may not be available for the recipient machine. Reduce the transmission start speed and send again.
U01800 - U01820	Communication error occurred during reception of high-speed transmission. Ask the sender to reduce the transmission speed and send again.
U01821	Communication error occurred during reception of high-speed transmission. Designated transmission speed may not be available for this machine. Ask the sender to reduce the transmission speed and send again.
U03000	During polling reception, a fax could not be received because no originals were set in the other party's fax machine. Check with the other party.
U03200	Sub address bulletin board reception was attempted and the other party's machine is an our-brand model, but the specified sub address box contained no data. Check with the other party.
U03300	<p>An error occurred due to either 1 or 2 below. Check with the other party.</p> <ol style="list-style-type: none"> 1 The other party's machine is an our-brand model and transmission restrictions were found set by the other party during polling reception. Communication was interrupted because the password was incorrect. 2 The other party's machine is an our-brand model and transmission restrictions were found set by the other party during sub address bulletin board reception. Communication was interrupted because the password was incorrect.
U03400	Polling reception was interrupted because the password entered by the other party did not match the Local FAX ID on the receiving machine. Check with the other party.
U03500	Sub address bulletin board reception was attempted and the other party's machine is an our-brand model, but the specified sub address box was not registered on the other party's machine. Check with the recipient.
U03600	The other party's machine is an our-brand model and sub address bulletin board reception was interrupted because the specified sub address password was incorrect. Check with the other party.

Error Code	Possible Cause/Action
U03700	Sub address bulletin board reception was attempted but the other party's machine either does not have a sub address bulletin board communication function or there were no originals in any of the originals transfer boxes (sub address boxes).
U04000	Specified sub address box is not registered in our-brand recipient machine, or the sub address does not match.
U04100	Recipient machine is not equipped with a sub address box function, or the sub address does not match.
U04200	Encrypted transmission was canceled because the specified box is not registered.
U04300	Encrypted transmission was canceled because the recipient fax is not equipped with an encrypted communication function.
U04400	Encrypted transmission was canceled because the encryption key does not match.
U04401	Encrypted transmission failed during dialing because the encryption key is not yet registered.
U04500	Encrypted reception was canceled because the encryption key does not match.
U05100	Transmission was canceled because communication requirements are not met due to the transmission restriction set on this machine. Check with the recipient.
U05200	Reception was canceled because communication requirements are not met due to the reception restriction set on this machine.
U05300	Reception was rejected by the recipient because communication requirements are not met due to the reception restriction set on the recipient machine. Check with the recipient.
U14000	Reception to the Sub Address Box was stopped because there is no more free space in the memory of this machine. Create free space by outputting the data stored in the memory, or cancel the reception to the Sub Address Box.
U14100	Transmission to the Sub Address Box or sub address box on our-brand recipient machine was stopped because there is no more free space in the memory of the recipient machine. Check with the recipient.

Error Code	Possible Cause/Action
U19000	Memory reception was stopped because there is no more free space in the memory of this machine. Create free space by outputting the data stored in the memory, and ask the sender to resend.
U19100	Transmission was stopped because there is no more free space in the memory of the recipient machine. Check with the recipient.
U19200	Memory transmission was stopped due to a data error occurring during transmission. Send again.
U19300	Transmission was stopped due to a data error occurring during transmission. Send again.
U19400	Reception was stopped due to a data error occurring during reception. Ask the sender to resend.

Index

Numerics

2 in 1 Reception [6-31](#)

A

About this Operation Guide [iv](#)
Account Management [4-42](#)
Address Book [3-13](#)
 Change/Deletion [3-20](#)
 Printing Address List [3-21](#)
 Registering a New Destination [3-13](#)
 Search [3-19](#)
 Select a Destination [3-19](#)
Automatic Send [3-2](#)

B

Batch Print [6-32](#)
Batch Transmission Function [4-2](#)
Broadcast Transmission [4-4](#), [8-5](#)
Bulletin Board Communication [4-33](#)

C

Cancel
 Cancelling Delayed Transmission [3-11](#)
 Cancelling Direct Transmission [3-11](#)
 Cancelling Memory Transmission [3-10](#)
 Cancelling Polling or Sub Address Bulletin Board Transmissions [3-12](#)
 Cancelling Transmission (Disconnection of Communication) [3-11](#)
Cannot perform memory reception [8-5](#)
Cannot perform sub address transmission [8-6](#)
Cannot receive document [8-5](#)
Cannot send document [8-5](#)
Cannot use sub address relay broadcast communication [8-6](#)
Chain Dial [4-7](#)
Checking Scheduled Job [4-3](#)
Checking Transmission Results and Registration Status [5-1](#)
Confirming and Deleting Registration

Contents of Encryption Key [6-26](#)
Continuous Scan [4-46](#)

D

Date [2-6](#)
Delayed Transmission [4-2](#)
 Cancel [3-11](#)
 Immediate Transmission [3-11](#)
Density [3-6](#)
Direct Transmission [3-2](#), [3-3](#)
 Cancel [3-11](#)
Document Processor [1-5](#)
DRD Reception [6-9](#), [6-13](#)
Duplex Print Output [6-30](#)

E

ECM Communication [3-4](#), [3-16](#)
E-mail Notice
 Job Finish Notice [4-46](#)
 Reporting FAX Receipt Result [5-10](#)
Encrypted Communication [8-5](#)
Encrypted TX [3-4](#)
Encryption Communication [6-24](#), [8-5](#)
 Encryption Key [6-24](#)
 Encryption Key No. [6-24](#)
 Operation at the Receiving System [6-28](#)
 Operation at the Sending System [6-27](#)
 Registering an Encryption Key [6-25](#)
Error Code List [Appendix-11](#)
Error Messages [8-3](#)

F

FAX Automatic Reception [3-8](#), [6-9](#)
FAX Box Function [8-6](#)
 FAX Box List [4-31](#)
 Renaming Files [4-30](#)
FAX Job History [5-3](#)
 Job Log Screen [5-3](#)
FAX/Answering Machine Auto Switch Reception [6-4](#), [6-9](#)
FAX/TEL Auto Switch Reception [6-2](#), [6-9](#)

I

Indicators [8-2](#)
Installation Precautions [iv](#)

Interrupt Send [4-6](#)

J

Job Accounting [4-42](#)
 Communication Form Subject to Job
 Accounting [4-43](#)
 Contents [4-42](#)
 Limit [4-43](#)
 Login [4-45](#)

L

Local FAX Information [2-4](#)
Local FAX Name [2-4](#)

M

Machine (Names) [1-4](#)
Manual Reception [4-9](#), [6-9](#)
Manual Send [4-8](#)
Media Type for Print Output [6-11](#)
Memory Reception [3-9](#), [8-5](#)
Memory Transmission [3-2](#)
 Cancel [3-10](#)
Menu List [Appendix-7](#)

N

Network FAX [7-1](#)
 Flow of Receiving [7-2](#)
 Flow of Sending [7-2](#)
 Online Manual [7-1](#), [7-3](#)
 Setup [7-3](#)
No Print Output [8-5](#)

O

One-touch Keys [3-22](#)
 Change/Delete [3-23](#)
 Registering a New Destination [3-22](#)
 Select Destination [3-22](#)
Operation Panel [1-2](#)
Original
 1-sided / 2-sided Selection [4-46](#)
 Original Orientation [4-46](#)
 Original Size Selection [4-46](#)

P

Part Names and Functions [1-1](#)
PBX Setting [2-8](#)
Permit Fax No.
 Change/Deletion [6-17](#)
 Registration [6-16](#)
Permit ID No.
 Change/Deletion [6-22](#)
 Registration [6-21](#)
Placing Originals [3-3](#)
Polling Communication [4-33](#)
 Checking [4-41](#)
 Deleting Originals in a Polling Box [4-40](#)
 Polling Reception [4-37](#), [8-6](#)
 Polling Transmission [4-33](#)
 Printing from a Polling Box [4-39](#)
 Renaming Files [4-41](#)
 Sub Address Bulletin Board
 Communication [4-33](#)
Precautions for Use [iv](#)
Precautions When Turning Power OFF [8-2](#)
Preparation Before Use [2-1](#)
Printing/Forwarding Received Documents
(Memory Forwarding) [4-13](#)
 Changing and Deleting Registration
 Contents [4-16](#)
 Registering Forwarding Destination [4-14](#)
 Setting Forwarding [4-14](#)
Printing/Sending Received Faxes by
Requirements (Memory Forwarding) [8-5](#), [8-6](#)
 COMMAND CENTER [4-21](#)
 Type of Forwarding Destination [4-13](#)
Program Dial [4-32](#)
 How to Change and Delete [4-32](#)
 How to Register [4-32](#)
 How to Use [4-32](#)

R

Received FAX Sizes and Paper Priority
[Appendix-9](#), [Appendix-10](#)
Receiving Mode [6-9](#)
Reception Date/Time [6-10](#)
Redial [3-24](#)
 Changing Retry Times [6-8](#)
Reject Fax No.
 Change/Deletion [6-19](#)
 Registration [6-18](#)
Remote Diagnostics [6-34](#)

Remote Switch Function [4-11](#), [8-5](#)

How to Register [4-11](#)

How to Use [4-12](#)

Report

Activity Report [5-7](#)

FAX RX Result Reports [5-5](#)

Send Result Reports [5-5](#)

Status Page [5-9](#)

Sub Address Box List [4-31](#)

Resolution [3-5](#)

Rings [6-6](#)

S

Safety Conventions [i](#)

Selection of Transmit Terminal Identification (TTI) [2-3](#)

Send Status [3-7](#)

Specifications [Appendix-6](#)

Standby Transmission [4-5](#)

Sub Address Box Function [4-27](#)

Checking [4-30](#)

Deleting Originals after Printing from a Sub Address Box [4-29](#)

Deleting Originals from a Sub Address Box [4-29](#)

How to Change [4-27](#)

How to Delete [4-28](#)

How to Register [4-27](#)

Printing Originals from Sub Address Box [4-28](#)

Sub Address Communication [3-4](#), [4-25](#)

How to Conduct [4-25](#)

Sub Address [4-25](#)

Sub Address Password [4-25](#)

Sub Address Relay Broadcast Communication [8-6](#)

T

Telephone Line [2-2](#)

Time [2-6](#)

Transmission Restriction [6-15](#)

Communication Establishing Requirements [6-15](#)

Permit FAX No. [6-16](#)

Permit ID No. [6-21](#)

Prerequisites [6-15](#)

Reception Rejection Requirements [6-16](#)

Reception Restriction Setting [6-23](#)

Reject FAX No. [6-18](#)

Send Restriction Setting [6-23](#)

Troubleshooting [8-5](#)

TX Start Speed [3-4](#), [3-16](#)

U

Unusable Time [6-35](#)

User Accounting [4-42](#)

Contents [4-42](#)

Login [4-44](#)

V

Volume Adjustment [6-7](#)



PASSIONATE PEOPLE. FROM ALL OVER THE WORLD.



KYOCERA MITA EUROPE B.V.



EUROPEAN HEADQUARTERS
Bloemlaan 4
2132 NP Hoofddorp
The Netherlands
Phone: +31 20 654 0000
Fax: +31 20 653 1256
www.kyoceramita-europe.com



KYOCERA MITA Europe B.V.,
Amsterdam (NL)
Zweigniederlassung Zürich
Hohlstrasse 614
CH-8048 Zürich
Phone: +41 1 908 49 49
Fax: +41 1 908 49 50
www.kyoceramita.ch

KYOCERA MITA SALES COMPANIES IN EMEA



KYOCERA MITA INTERNATIONAL SALES
(Europe, Middle East & North Africa)
Bloemlaan 4
2132 NP Hoofddorp
The Netherlands
Phone: +31 20 654 0000
Fax: +31 20 653 1256
www.kyoceramita-europe.com



AUSTRIA
KYOCERA MITA AUSTRIA GmbH
Eduard Kittenberger Gasse 95
A-1230 Wien
Phone: +43 1 86 338 0
Fax: +43 1 86 338 400
www.kyoceramita.at



BELGIUM
S.A. KYOCERA MITA Belgium N.V.
Sint-Martinusweg 199-201
BE-1930 Zaventem
Phone: +32 2 720 9270
Fax: +32 2 720 8748
www.kyoceramita.be



DENMARK
KYOCERA MITA Denmark A/S
Ejby Industrivej 1
DK-2600 Glostrup
Phone: +45 70 22 3880
Fax: +45 45 76 3850
www.kyoceramita.dk



FINLAND
KYOCERA MITA Finland OY
Kirvesmiehenkatu 4
FI-00880 Helsinki
Phone: +358 9 4780 5200
Fax: +358 9 4780 5390
www.kyoceramita.fi



FRANCE
KYOCERA MITA France S.A.
Parc les Algorithmes Saint Aubin
FR-91194 Gif-Sur-Yvette
Phone: +33 1 6985 2600
Fax: +33 1 6985 3409
www.kyoceramita.fr



GERMANY
KYOCERA MITA Deutschland GmbH
Otto-Hahn-Str. 12
D-40670 Meerbusch / Germany
Phone: +49 2159 918 0
Fax: +49 2159 918 100
www.kyoceramita.de



ITALY
KYOCERA MITA Italia S.P.A.
Via Verdi, 89/91
I-20063 Cernusco sul Naviglio (MI)
Phone: +39 02 921 791
Fax: +39 02 921 796 00
www.kyoceramita.it



THE NETHERLANDS
KYOCERA MITA Nederland B.V.
Beechavenue 25
1119 RA Schiphol-Rijk
Phone: +31 20 587 7200
Fax: +31 20 587 7260
www.kyoceramita.nl



NORWAY
KYOCERA MITA Norge
Olaf Helsetsvai 6
NO-0694 Oslo
Phone: +47 22 627 300
Fax: +47 22 627 200
www.kyoceramitanorge.no



PORTUGAL
KYOCERA MITA Portugal LDA.
Rua do Centro Cultural 41
PT-1700-106 Lisboa
Phone: +351 21 843 6780
Fax: +351 21 849 3312
www.kyoceramita.pt



SOUTH AFRICA
KYOCERA MITA South Africa (Pty) Ltd.
527 Kyalami Boulevard, Kyalami
Business Park · ZA-1685 Midrand
Phone: +27 11 540 2600
Fax: +27 11 466 3050
www.kyoceramita.co.za



SPAIN
KYOCERA MITA España S.A.
Avda. Manacor No. 2
ES-28290 Las Matas (Madrid)
Phone: +34 91 631 83 92
Fax: +34 91 631 82 19
www.kyoceramita.es



SWEDEN
KYOCERA MITA Svenska AB
Esbogatan 16B
SE-164 75 Kista
Phone: +46 8 546 550 00
Fax: +46 8 546 550 10
www.kyoceramita.se



UNITED KINGDOM
KYOCERA MITA UK Ltd.
8 Beacontree Plaza, Gillette Way,
Reading, Berkshire RG2 OBS
Phone: +44 1189 311 500
Fax: +44 1189 311 108
www.kyoceramita.co.uk

KYOCERA MITA WORLDWIDE



JAPAN
KYOCERA MITA Corporation
(Head Office)
2-28, 1-Chome, Tamatsukuri, Chuo-ku,
Osaka 540-8585, Japan
Phone: +81 6 6764 3555
Fax: +81 6 6764 3980
www.kyoceramita.com



USA
KYOCERA MITA America, INC.
(Head office)
225 Sand Road, P.O. Box 40008
Fairfield, New Jersey 07004-0008, USA
Phone: +1 973 808 8444
Fax: +1 973 882 6000
www.kyoceramita.com/us

KYOCERA CORPORATION



JAPAN
KYOCERA CORPORATION
(Corporate Headquarters)
6 Takeda Tobadono-cho, Fushimi-ku
Kyoto 612-8501, Japan
Phone: +81 75 604 3500
Fax: +81 75 604 3501
www.kyocera.co.jp





Free Manuals Download Website

<http://myh66.com>

<http://usermanuals.us>

<http://www.somanuals.com>

<http://www.4manuals.cc>

<http://www.manual-lib.com>

<http://www.404manual.com>

<http://www.luxmanual.com>

<http://aubethermostatmanual.com>

Golf course search by state

<http://golfingnear.com>

Email search by domain

<http://emailbydomain.com>

Auto manuals search

<http://auto.somanuals.com>

TV manuals search

<http://tv.somanuals.com>