

Troll Systems Corporation Ground-Based Products

VanLink System Installation Guide



Troll Systems Corporation Technical Publications
Document VLSG-01 Revision - 0
10/17/2008
www.trollsystems.com

NOTICE

The information in this document incorporates proprietary rights of

Troll Systems Corporation
24950 Anza Avenue
Valencia, CA 91355, U.S.A.

Any party accepting this document acknowledges that it contains proprietary confidential information and agrees that it shall not be duplicated in whole or in part, nor disclosed to others without the written consent of Troll Systems Corporation.

© 2008 Troll Systems Corporation

Table of Contents

Summary	1
VanLink Equipment Components	1
Required Hardware	P-1
Software Requirements	P-1
Abbreviations, Acronyms, Terms	P-2
Packaging	P-4
Warranty	P-4
Conventions Used in this Document	P-5
VanLink Component Set-up and Operation	P-5
Warnings, Cautions, Notes, and Hints	P-5
Warnings	P-5
Cautions	P-6
Notes	P-6
Hints	P-6
Contact Information	P-7
Hazard Advisory Placards/Signs	S-1
Know and Comply with Local, State, and Federal Safety Requirements	S-1
Do Not Service or Adjust Alone	S-1
Electrical Power/Shock Hazards	S-2
Be Familiar With Resuscitation Techniques	S-3
Coincidental Damage to Equipment in Cabinets	S-3
Lifting/Handling Hazards	S-3
Electrostatic Discharge Sensitive (ESDS) Components	S-4
System Overview	1-1
VanLink System Features	1-2
Remote Control from the Studio or Control Center	1-3
SPECIFICATIONS	1-4
Required System Components	1-4
Hardware Requirements	1-4

Master Controller Software Requirements	1-4
Introduction	2-1
Safety Recommendations	2-1
Installation Requirements	2-2
Power Requirements	2-2
Rack Installation	2-2
Rack Space Requirements	2-2
Cable Requirements	2-2
Running Cables	2-3
V750 Cable and Connector Requirements	2-3
Pan and Tilt Cabling and Connector Requirements	2-4
GPS/IMU Connectivity	2-5
EVDO/3G Router Connectivity	2-5
IP Connectivity	2-5
Master Controller(s) and TNS Accessibility	2-5
Typical Network Configuration for VanLink	2-7
GPS/IMU Mounting Considerations	2-7
GPS/IMU Assembly	2-7
GPS/IMU Mounting Considerations	2-7
VanLink GPS	2-8
Calibration	2-9
Magnetometer Calibration	2-9
Antenna Calibration	2-9
Remote and Local Control	2-9
Operating Requirements	2-10
Transmitter Control / Available Options	2-10
Introduction	3-1

INTRODUCTION

This *Installation Guide* is intended for use with the VanLink System featuring TouchStar™ Technology designed and fabricated by Troll Systems Corporation. The sections and appendices that make up this manual are as follows:

[Safety Considerations](#)

[Section 1 - Vanlink System Overview](#)

[Section 2 - VanLink System Requirements](#)

[Section 3 - Engineering Drawings](#)

This guide or manual is based on the latest information available at the time of publication.

SUMMARY

VanLink is a system composed of several Troll Systems components that are coordinated work in a synchronous manner using proprietary software. This complex and innovative system configuration enables complete studio control of a broadcast news van while it is in the field.

VANLINK EQUIPMENT COMPONENTS

Required Hardware

The VanLink system is comprised of the following hardware components:

- V750 - Troll Systems Remote VanLink controller
- GPS/IMU – Troll Systems GPS & Magnetometer assembly
- Quickset Pan/Tilt – Pan/Tilt pedestal w/ Azimuth and Elevation feedback
- Pan/Tilt controller – Pan/tilt controller with remote interface capability
- EVDO or 3G Router

Software Requirements

- TouchStar 2008 – Windows application providing the control interface for VanLink.
- TouchStar 02 Mapping Software – Displays and provides control for all receive sites including each vehicle equipped with VanLink.

ABBREVIATIONS, ACRONYMS, TERMS

Listing of general abbreviations, acronyms, and terms that may be used throughout this document are defined in the following list.

Term	Definition
AC	Alternating Current
ALT	Altitude
ANT	Antenna
AUX	Auxiliary
Az	Azimuth
BAS	Broadcast Auxiliary Service
CAL	Calibrate
CAM	Camera
Ch	Channel
COMM	Communication
COTS	Commercial-Off-The-Shelf
CPU	Central Processing Unit
dB	Decibel
DC	Direct Current
DMM	Digital Multimeter
e.g.	Latin: <i>exempli gratia</i> , meaning “for example”
EMI	Electro-Magnetic Interference
ENG	Electronic News Gathering
ESD	Electro-Static Discharge
et al	Latin: <i>et alia</i> , meaning “and others”
FM	Frequency Modulation
GPS	Global Positioning System
GUI	Graphic User Interface
HD	High Definition
Hz	Hertz
H/W	Hardware
I/O	Input/Output
i.e.	Latin: <i>id est</i> , meaning “that is”

Term	Definition
LAT	Latitude
LCD	Liquid Crystal Display
LED	Light Emitting Diode
LNA	Low-Noise Amplifier
LNG	Longitude
MICOWV	Microwave
NEMA	National Electrical Manufacturing Association
NIC	Network Interface Card
nm (NM)	Nautical Mile (note: 1 nautical mile equals 1.150782 miles)
NTSC	National Television System Committee
NAV	NavTrack
NV	Non-Volatile
PC	Personal Computer
PED	Pedestal
POL	Polarization
PRSETS	Presets
RAM	Random Access Memory
RF	Radio Frequency
RFI	Radio Frequency Interference
ROM	Read Only Memory
RPC	Remote Procedure Call
RX	Receiver/Receive
S/W	Software
SDI	Serial Digital Interface
SV	System Variable
TX	Transmitter/Transmit
V	Volt
VAC	Volts Alternating Current
VDC	Volts Direct Current
W	Watt

PACKAGING

Use the original packaging material used for your TNS3000 network Server if available and in good condition.

If you must return your product to Troll Systems Corporation for repair (and you no longer have your original box and packing materials), Troll will send you a packing box specifically designed to ship the product without damage.

WARRANTY

Troll warrants, to the original Customer only, that the product is free from defects in material and workmanship and conforms to the specification, if any. If no specification is listed, the items are warranted to conform to our currently published specification for the product. The warranty period is for a period of one year from the date of shipment. Troll will repair or replace (at its option) any such device which is returned to the Troll factory office, with transportation charges prepaid and within the warranty period. The liability of Troll shall be limited to the repair or replacement of the device and shall not include installation, or any other charge or expense incurred. This warranty shall not apply to any unit or part thereof which, in the opinion of Troll, has been installed or used improperly; damaged by accident, corrosion, misused, or negligence; or altered or repaired in such a manner as to impair performance. Troll must receive written notice of the defect within the warranty period. Customer must pay packing, crating and transportation costs to and from the factory. At the Customer's request, Troll will make reasonable efforts to provide warranty service at the Customer's premises, provided that Customer pays Troll's then current rates for field service and the associated travel and living expenses. If a fault has been caused by improper installation, maintenance or use, or by abnormal conditions of operation, those repairs will be billed at normal rates. Troll shall have the right of final determination as to the existence and cause of any such defect.

CONVENTIONS USED IN THIS DOCUMENT

VanLink Component Set-up and Operation

The Troll Systems V750 Remote Site Controller and its innovative capabilities is the heart of the VanLink system. For comprehensive information for this complex and dynamic component, consult the Troll Systems manual for the S750 Remote Site Controller manual which is identical to the V750 in almost all respects and functions.

Text appearing on the bottom line of the front panel display (just above the function keys) of the V750 Remote site controller (i.e., commands associated with function keys A, B, C, D, and E) appear in the font, **Arial Rounded MT Bold**

Text and terms that are emphasized to draw the reader's attention (due to their significance within the text) appear in italics. See the example below.

WARNINGS, CAUTIONS, NOTES, AND HINTS

Warnings

Warnings are included to alert the user that possible hazards are associated with the processes/procedures described. These may cause death or injury in any form, if the instructions in the operational or procedural task are not followed precisely. Warnings describe the potential hazards and possible impact that could occur if the warnings are not observed.



WARNING: This format is used for general warnings.



WARNING: This format is used for electrical warnings.



WARNING: This format is used for mechanical warnings.



WARNING: This format is used for warnings which include the risk of fire.

Cautions

Cautions are included to alert the user that damage to the equipment is possible if the instructions in the operational or procedural task are not followed precisely. Cautions describe the hazards and possible impact that could occur if the cautions are not observed.



CAUTION: This format is used for all cautions.

Notes

Notes are included to provide the user with supplemental information, which is helpful but does not necessarily belong in the core text. Many operational and procedural tasks are easier with the addition of notes.



NOTE: This format is used for all notes.

Hints

Hints are generally included to inform the user of special features and/or methods of performing various tasks. These are usually unique features/methods that provide streamlined use of the equipment and/or user interface.



Hint: This format is used for all hints.

CONTACT INFORMATION

Troll Systems Corporation is committed to providing its customers with quick and friendly service. If you have questions regarding your Troll product, or if you are experiencing a technical problem, please contact us at:

Troll Systems
24950 Anza Drive
Valencia, CA 91355

Phone: (661) 702-8900

Fax: (661) 702-8901

Alternatively, you can contact us via e-mail at:

Sales
sales@trollsystems.com

Service
service@trollsystems.com

Troll Systems Corporation is continually updating and enhancing its existing products while also developing new products for the Electronic News Gathering (ENG) and Airborne Law Enforcement (ALE) industries. Visit us on the world wide web at:

www.trollsystems.com



NOTES

SAFETY CONSIDERATIONS

GENERAL SAFETY PRECAUTIONS

The following general safety precautions are not related to any specific procedures and therefore do not appear elsewhere in this publication. They are, however, precautions that personnel need to understand and apply when operating or repairing equipment. Installation, operation, and maintenance should be performed only by qualified personnel.

Hazard Advisory Placards/Signs

Read and heed all hazard advisory placards or signs affixed to the equipment or surrounding enclosures. They warn of potential hazards to personal safety and possible damage to equipment if correct maintenance practices are not followed. Ignoring hazard advisory placards (WARNINGS/CAUTIONS) places personnel at risk for serious injury or death.

Know and Comply with Local, State, and Federal Safety Requirements

You should be familiar with all local, state, and federal safety requirements applicable to the equipment, processes, and materials you use during maintenance. Before using any substances or materials marked toxic or hazardous, always refer to the Material Safety Data Sheets (MSDS) for that substance/material for any special protective equipment, handling, and/or disposal requirements.

Do Not Service or Adjust Alone

Do not start a maintenance or adjustment procedure if that procedure requires more than one technician to be safely performed. It is particularly important that such work not be performed in a remote area, away from other qualified personnel who may be needed to render assistance. When a maintenance task requires two or more personnel to be safely accomplished, delay the task until qualified personnel are available to assist you.

VanLink Safety Considerations

For safety reasons Troll Systems does not offer control of masts. There are, however, methods for implementing safety measures to prevent any damage to the antenna or surrounding equipment by monitoring the mast's position and locking out control when the mast is down. Due to the number of unique vehicle configurations and mast controls available this shall be considered an option that will require additional preparation and information from the customer/installer prior to implementation. Currently it is the operator's responsibility to ensure that the antenna is clear from any obstructions before enabling remote control for the studio.

Electrical Power/Shock Hazards



WARNING: Potentially lethal voltage/current is present throughout many electrical installations. Maintenance personnel shall employ positive power lockout devices and post all required warning tags/signs when applicable to ensure that no unauthorized application of power can occur during maintenance. Failure to heed this warning could result in serious injury or death by electrocution.

Always verify that electrical power is disconnected and that applicable safety procedures have been followed before doing maintenance on any electrical/electronic equipment. High voltage electrical energy is stored in some electrical equipment (electrolytic capacitors, UPS batteries, etc.) even after the source of primary external power has been disconnected. Always remove external power, deactivate equipment, or discharge the potential to ground (when applicable) before working on the equipment.

If a high-potential insulation test is required, follow the procedures and precautions outlined in the appropriate National Electrical Manufacturing Association (NEMA) standards. Check with the area supervisor if unfamiliar with these standards, specific equipment, or procedures.

When electrical troubleshooting of a system must be accomplished with power applied, first verify that all personnel in the hazard area are advised, that the equipment is tagged, and/or that an assistant is posted at the point of power control.

Be Familiar With Resuscitation Techniques

Personnel working with or near high voltages should be familiar with modern methods of resuscitation. It is beneficial to ensure that personnel are capable of performing Cardio-pulmonary resuscitation (CPR) should the need arise.

Coincidental Damage to Equipment in Cabinets



CAUTION: Pushing or forcing equipment into/out of equipment cabinets and enclosures can easily damage surrounding equipment, cables/wiring, or fiber optic cable installations. Be alert to avoid coincidental damage to equipment when accessing crowded installations. Coincidental damage is often difficult to detect and even more difficult to troubleshoot.

When removing equipment from cabinets/consolas, exercise care so that surrounding wiring installations and equipment are not physically damaged in the process. Disconnect and secure any surrounding wiring or hardware which could cause damage to or be damaged by the equipment being removed.

When installing equipment into cabinets/consolas, exercise care to protect surrounding wiring installations and equipment from being physically damaged in the process. Neatly stow excess cable/wiring and replace all tie wraps, clamps, and other retaining devices which were removed. Neat installations reduce the chances of coincidental damage to adjacent equipment and promote more efficient air circulation and equipment cooling.

Lifting/Handling Hazards

The removal and installation of large, heavy, or awkward component assemblies, especially equipment attached to the external areas of the aircraft, will require a minimum of two (2) personnel to safely handle. Alternatively, the use of appropriately rated material handling equipment can be used when determined to be safe. Where limited access prevents the use of material handling equipment, ensure that an adequate number of personnel are present to safely handle the anticipated loads.

Electrostatic Discharge Sensitive (ESDS) Components



CAUTION: Beware of electrostatic buildup. Delicate solid-state Integrated Circuits (ICs) can be damaged by improper handling procedures. Use proper electrostatic safeguards when installing/removing circuit cards and handling ESD sensitive assemblies. As required, wear a grounded wrist strap, use antistatic floor and table mats, and minimize the handling of sensitive solid-state devices. Keep all ESD sensitive components in their original containers until ready for use. Always discharge personal static before handling ESD sensitive components and do not slide solid state devices over any surface. Handle plug-in card assemblies only by their non-conductive edges.

Computers, microprocessors, and other solid state components (circuit cards, I/O boards, etc.) which are not clearly marked with the ESDS symbol will be handled as ESD sensitive components until determined otherwise. Retain protective ESDS packing and shipping bags, containers, non-conductive foam pads, etc. (see [Figure S-1](#)) for use in the return of repairable components.

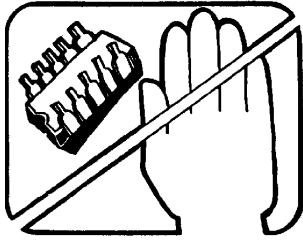

Minimize Handling.

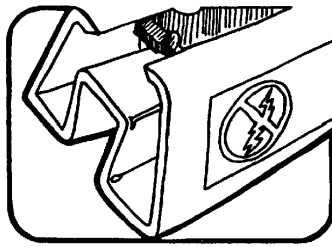

Keep parts in original containers until ready for use.

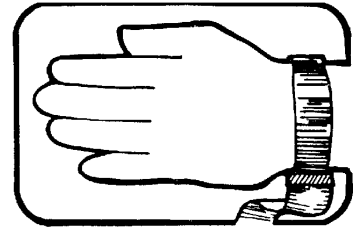

Discharge personal static before handling devices.

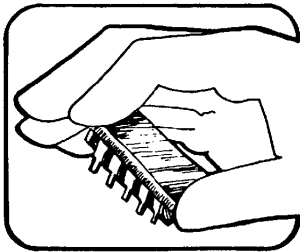

Handle devices by the body.

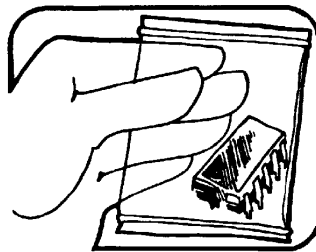

Use anti-static containers for handling and transport.

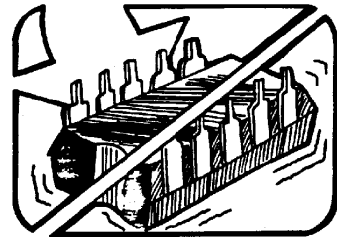

Do not slide devices over any surface.

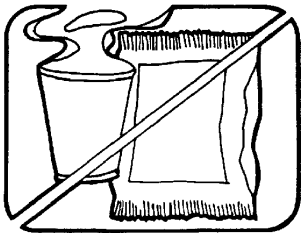

Avoid plastic, vinyl and styrofoam in work area.

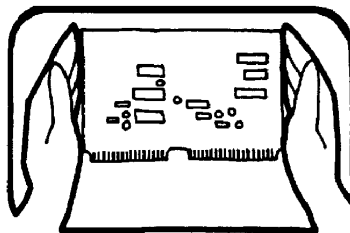

When removing plug-in assemblies, handle only by non-conductive edges and never touch open edge connector except at static-free work station. Placing shorting strips on edge connector usually provides complete protection to installed devices.

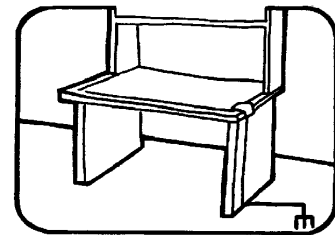

Handle devices only at a static-free work station.

Only anti-static type solder suckers should be used.

Only grounded tip soldering irons should be used.

Figure S-1. Procedures for Handling Electrostatic Sensitive Components

NOTES

SECTION 1

VANLINK SYSTEM OVERVIEW

1.1 SYSTEM OVERVIEW

The Troll Systems VanLink remote broadcast van control interface is a comprehensive and dynamic system designed to be integrated into vehicles utilized in Electronic News Gathering functions in the field. Refer to [Figure 1-1](#) through [Figure 1-3](#).

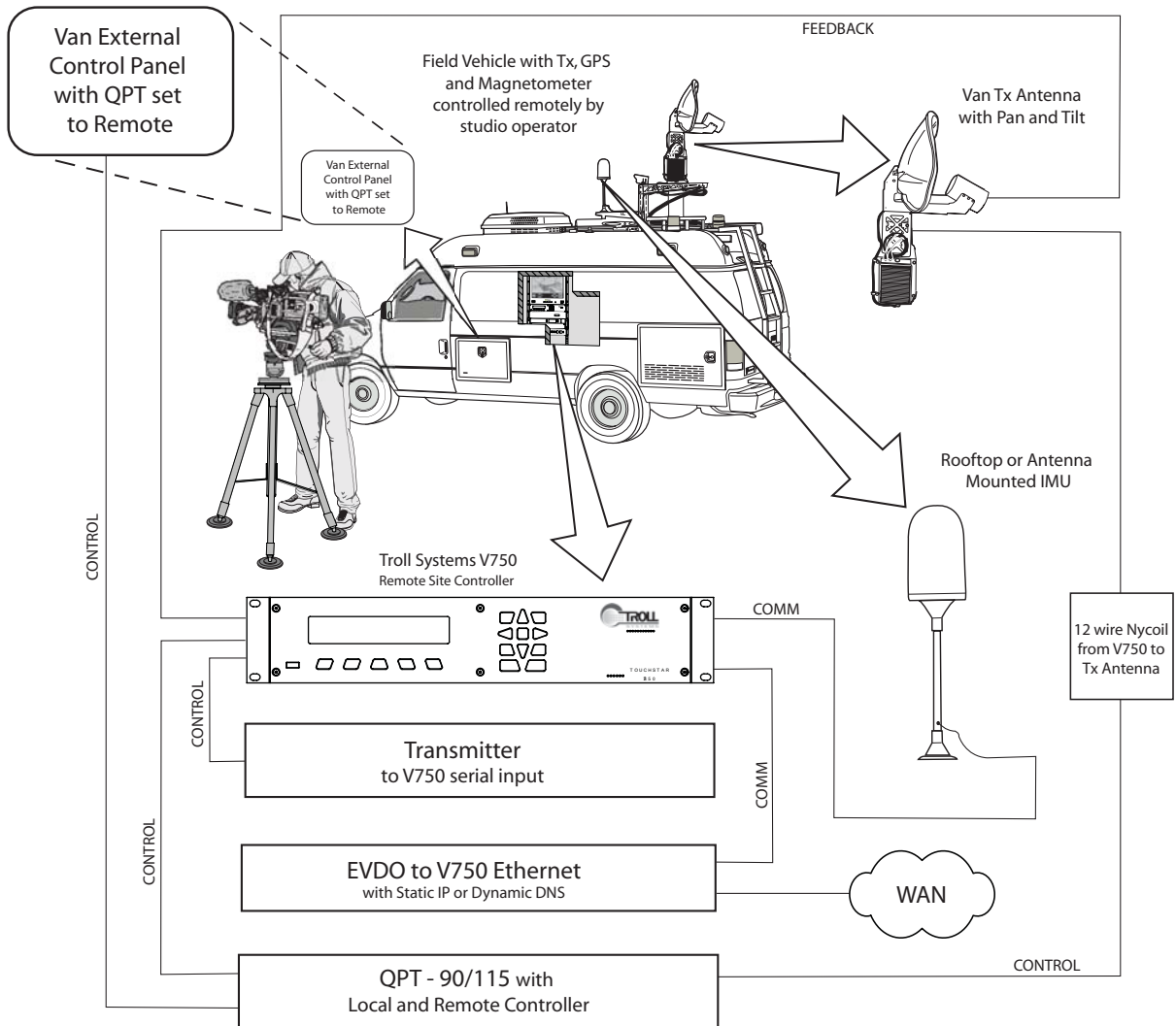

Figure 1-1. VanLink System ENG Vehicle Configuration

1.1.1 VanLink System Features

This system enables several operations of the ENG vehicle to be controlled remotely from the broadcast studio including such key functions as:

- Remote tracking of vehicle heading and location including locations of all vehicles that are mutually equipped with VanLink
- Troll MC17 Master Controller with Graphic User Interface featuring the control page and GPS enabled screen MAP
- Transmitter antenna control including pan and tilt for azimuth and elevation feedback
- Optional roof mount or mast mount of the GPS/IMU to minimize EMI interference
- Automatic tracking of the HD signal with self-optimization of the vehicle transmitter antenna in real time using the V750's preprogrammed ability to analyze and compensate for signal integrity in reference to the studio's coordinates and the vehicle's GPS/IMU location feedback. (see [Figure 1-2](#))

Troll Systems V750 Remote Site Controller
communicating with van IMU GPS and Magnetometer while
coordinating with preprogrammed site latitude and
longitudinal data for accurate signal tracking in real time

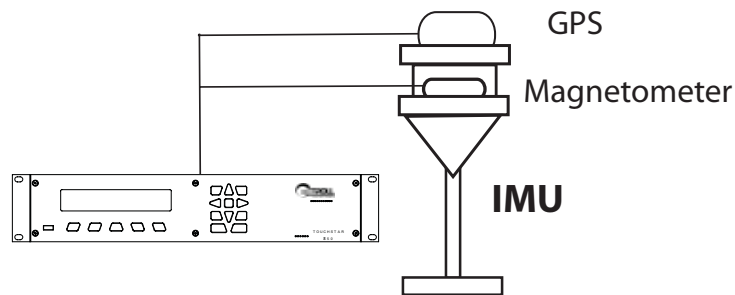

Figure 1-2. VanLink IMU Configuration

1.1.1.1 Remote Control from the Studio or Control Center

Comprehensive remote control of ancillary vehicle functions including pan and tilt, vehicle tracking and signal optimization. (see [Figure 1-3](#)).

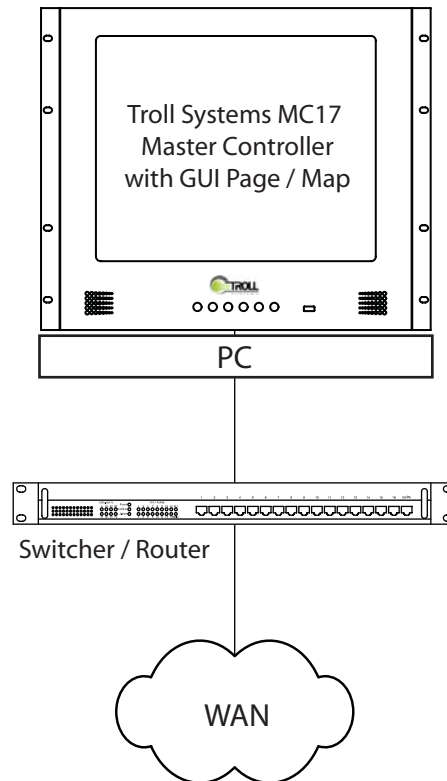

Figure 1-3. VanLink Remote Studio Configuration

1.2 SPECIFICATIONS

1.2.1 Required System Components

1.2.1.1 Hardware Requirements

The VanLink system of comprised of the following hardware components:

- V750 - Troll Systems VanLink controller
- GPS/IMU – Troll Systems GPS & Magnetometer assembly
- Quickset Pan/Tilt – Pan/Tilt pedestal w/ Azimuth and Elevation feedback*
 - 115VDC
- Pan/Tilt controller – Pan/tilt controller with remote interface capability
 - C90VS-DC115A
- EVDO or 3G Router** – Cellular data service router which utilizes either a Static public IP address or Dynamic DNS***
 - Kyocera One

*Optional potentiometer kits are available for most units

**Requires additional EVDO/3G card with service activated

***May incur monthly charges for additional Dynamic DNS services

1.2.1.2 Master Controller Software Requirements

The VanLink system of comprised of the following software components at the Master Controller:

- TouchStar 2008 – Windows application that provides control interface for VanLink including any additional device control that has been implemented.
- TouchStar 02 Mapping Software – Displays and provides control for all receive sites including each vehicle equipped with VanLink.

SECTION 2

VANLINK SYSTEM REQUIREMENTS

2.1 INTRODUCTION

This section provides information detailing the system requirements and theory of operation of the Vanlink Control System. The following topics are discussed:

- Safety Recommendations
- System Requirements
- Theory of operation and recommendations

2.2 SAFETY RECOMMENDATIONS

Equipment installation and operation should only be performed by qualified personnel that are familiar with the type of equipment being installed.

The following guidelines will help ensure your safety and protect the equipment from damage. However, these guidelines do not cover all potentially hazardous situations you might encounter during system installation. Refer also to the Safety Considerations of this guide for additional safety information.

- Always disconnect all power connections before installing or removing the Vanlink System and its associated components (i.e. the V750 Master Controller).
- Keep the rack and/or installation area clear and free of dust during and after installation.
- Keep tools and chassis components away from walk areas.
- Comply with all local safety laws and guidelines.
- Do not wear loose clothing, jewelry (including rings and chains), or other items that could get caught in the equipment. Fasten or remove loose ties, scarves, sleeves, and other items before you start installation procedures.
- Equipment grounding must meet local and national electrical codes.

2.3 INSTALLATION REQUIREMENTS

The Vanlink System components install easily in a standard 19-inch equipment rack. Physical characteristics of the Vanlink System components are provided in the applicable assembly drawings. Both standard and custom rack installations must meet these dimensional requirements in order to properly accommodate the installation of the controller.

2.3.1 Power Requirements

Power provided at the vehicle must meet either of the following requirements:

- 120VDC for the V750 Remote Site Controller
- 120VDC for the Router
- 120VDC for the V750 Pan and Tilt Controller

2.3.2 Rack Installation

Vanlink System components rack space requirements are as follows:

2.3.2.1 Rack Space Requirements

- V750 – Requires two rack spaces
- Pan/Tilt controller – Requires two rack spaces unless otherwise specified
- EVDO/3G Router – One rack space (not necessarily rack mounted)

2.3.3 Cable Requirements

All applicable cables may be able to be installed (with the ready connectors) after installing the Vanlink System components into the equipment rack. Connectors and cables may vary depending upon each customer's installation requirements.

Cables may be fabricated in the factory. In some cases, customers may choose to fabricate the cables themselves to custom lengths for the best possible configuration or fit within their equipment rack. It is recommended to refer to the System Interconnect Diagram that will accompany your system to determine the cable requirements for your system.

2.3.3.1 Running Cables

Cables should only be installed by qualified personnel who are familiar with the electrical requirements and safety precautions that are necessary to properly and safely install (run) these items.

The cables should be inspected prior to installation. Connectors should be visually inspected prior to connecting to their mating connector.

2.3.3.2 V750 Cable and Connector Requirements

The V750 cable and connector requirements are as follows:

- Cabling consisting of four (4) wires will be required between the V750 and the pan/tilt for azimuth and elevation feedback.
 - Some pan/tilts may already have the potentiometers installed in which case the wires needed may already be terminated and run through the NYCOIL.
- The harness for the GPS/IMU can be extended to reach the roof of the vehicle if necessary.

Refer to [Figure 2-1](#)

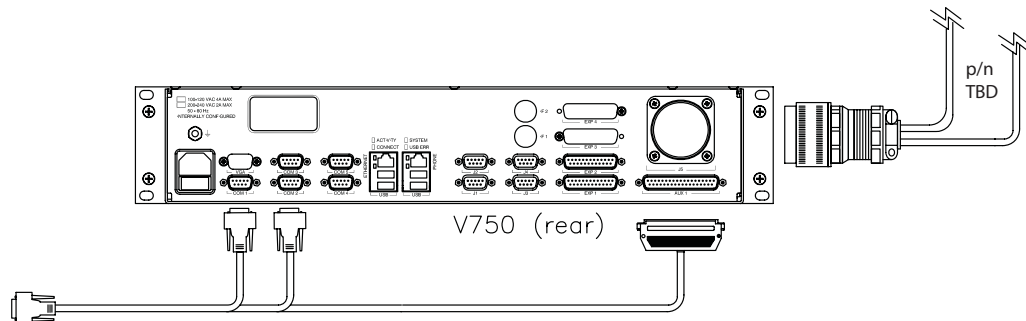

Figure 2-1. Cable Connector/Adapters E-201-0101-01

2.3.3.3 Pan and Tilt Cabling and Connector Requirements

The pan and tilt cable and connector requirements are as follows (refer to [Figure 2-2](#)):

- The pan/tilt controller is connected directly to the QPT pedestal on the roof via a terminal strip in the rear of the controller.
 - An additional four (4) wires are required for azimuth/elevation feedback.
 - The four (4) wires will connect to the V750 or to the pan/tilt controller depending on whether or not the model has feedback capability.
 - For installations using the C90VS-DC115A, the 4 wires will terminate at the 26p circular connector on the rear of the V750.

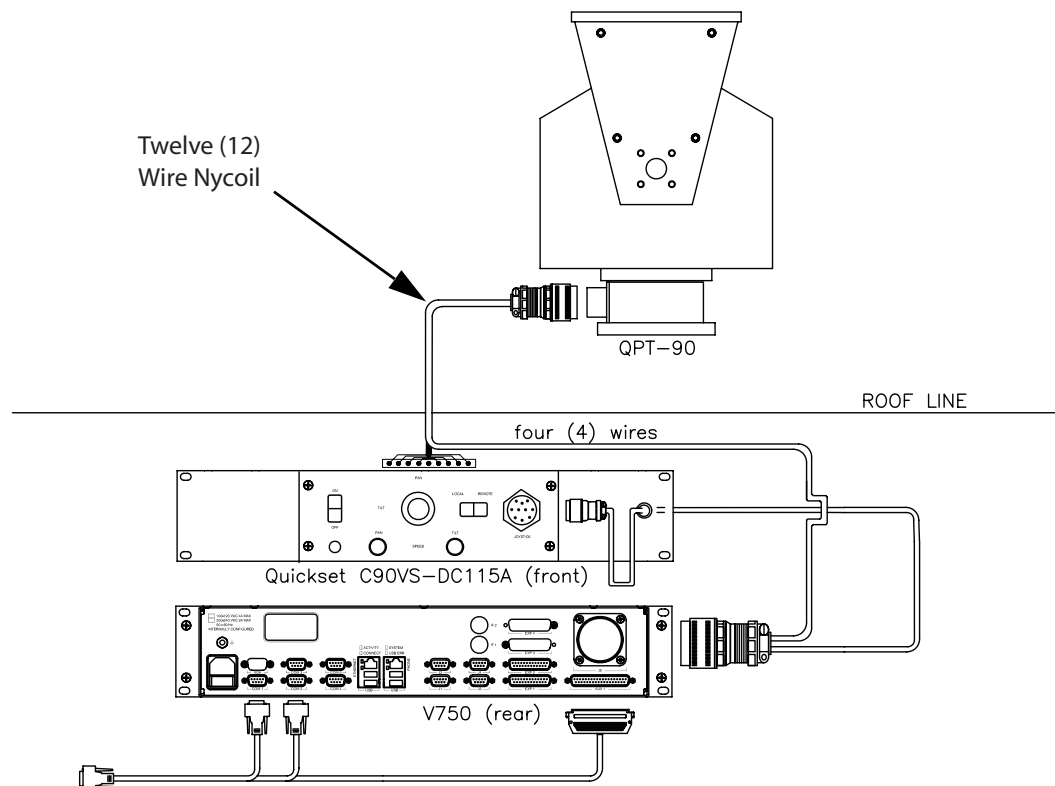

Figure 2-2. Typical Network Configuration

2.3.3.4 GPS/IMU Connectivity

- Cabling consisting of six (6) wires will need to run from the V750 to the GPS/IMU.
 - It is possible to use existing wires to avoid running new wires by creating an extension with a DB9 connector on each end of the wires. Otherwise the cable from the GPS/IMU will be run from the roof down to the V750 where it will connect to the harness.
- +12VDC power is provided by the V750

2.3.3.5 EVDO/3G Router Connectivity

- Requires EVDO/3G PCMIA Card with service activated (provided by customer on their service plan).
- Requires 120VDC
- Requires one CAT5 cable

2.3.4 IP Connectivity

In order for VanLink to work remotely from the studio, the MC-17s and TNS (if equipped with Controll2_TNS1 software) must have access to the internet (WAN). Most studios have a unique configuration as well as their own unique security measures and policies which must be discussed and necessary preparations should be coordinated with their own respective IT departments. The minimum open port requirements for the master controller(s) running TouchStar to establish communications with the V750 inside the vehicles running VanLink are as follows:

2.3.4.1 Master Controller(s) and TNS Accessibility

Master Controller(s) and TNS (if equipped with Controll2_TNS1 software) must have access to the outside internet (see [Figure 2-3](#)).

- Open ports required are: 80, 2000, 2009, 2050, and 2099
 - Port 80* (TCP/IP) is the HTTP port required for the MC-17 or TNS to resolve Dynamic DNS IP addresses.
 - Port 2000 (TCP/IP & UDP) is for terminal access (TELNET) for remote configuration of the V750 primarily via the Forge application
 - Port 2009 (UDP) is the port TouchStar uses to communicate with the program running at the V750
 - Port 2050 (TCP/IP) is the port used also used for terminal access for applications other than Forge
 - Port 2099 (TCP/IP & UDP) is another port being utilized by Forge for remote configuration



NOTE: Port 80 is not required if the EVDO/3G router utilizes a static IP address

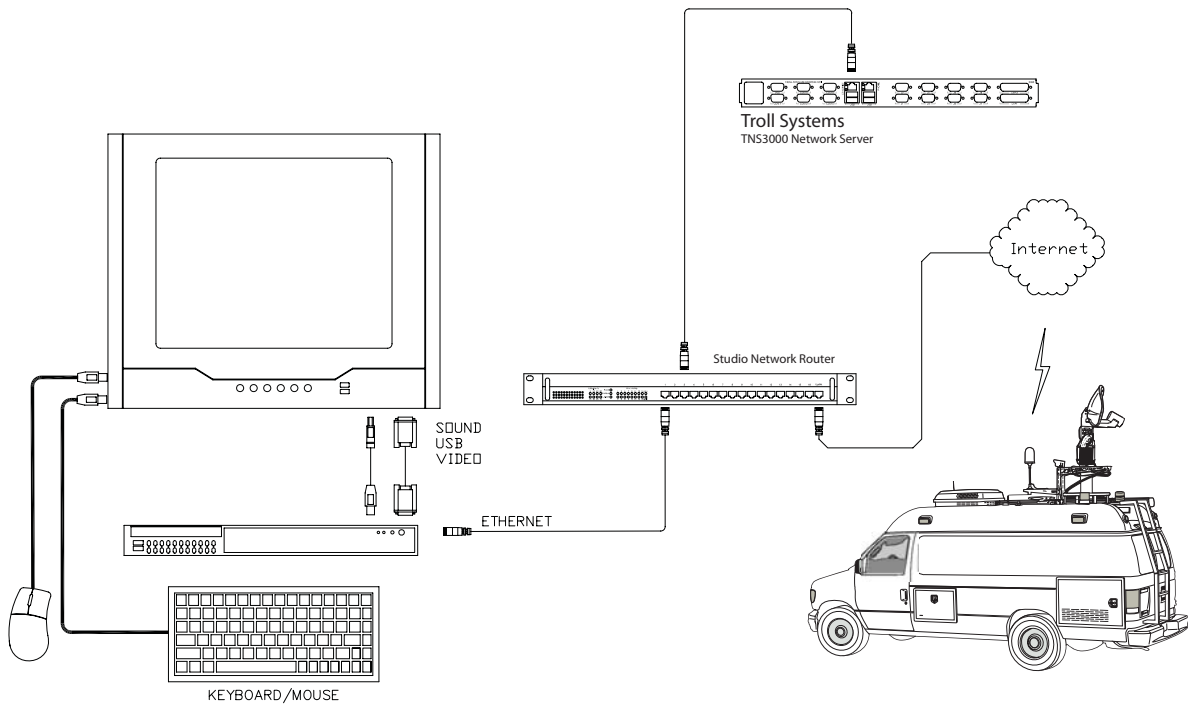

Figure 2-3. Typical VanLink Network Configuration

2.3.5 Typical Network Configuration for VanLink

2.3.5.1 GPS/IMU Mounting Considerations

In order for the GPS/IMU to continually provide accurate heading information a few considerations need to be made when mounting the assembly on the roof of the vehicle.

- The GPS/IMU assembly must be mounted as far away from any significant sources of current such as flood lights or motors as possible because it is sensitive to EMI generated by these types of devices.
- It's recommended that it be installed at least 24" from the pan/tilt device so as not to be affected by the EMI generated by the DC motors.
- The GPS/IMU can be mounted either on the mast using a bracket or on the roof of the van in an area least likely to be affected by EMI.
 - If it is mounted on the mast, six (6) additional wires will be needed to be run through the NYCOIL.

2.4 GPS/IMU ASSEMBLY

2.4.1 GPS/IMU Mounting Considerations

If the GPS/IMU (see [Figure 2-4](#)) is to provide continuously accurate heading information, a few mounting considerations need to be made when the assembly is to be installed onto the roof of the vehicle.

- The GPS/IMU assembly must be mounted as far away from any significant sources of electrical current as possible such as flood lights or motors because its sensitivity to the EMI generated by these types of devices.
 - It is recommended that the GPS/IMU be installed at least 24" from the pan/tilt device so it will not to be affected by the EMI generated by the DC motors.
- The GPS/IMU can be mounted either on the mast using a bracket or on the roof of the van in an area least likely to be affected by EMI.
- If it is mounted on the mast, six (6) additional wires will be needed to be run through the NYCOIL

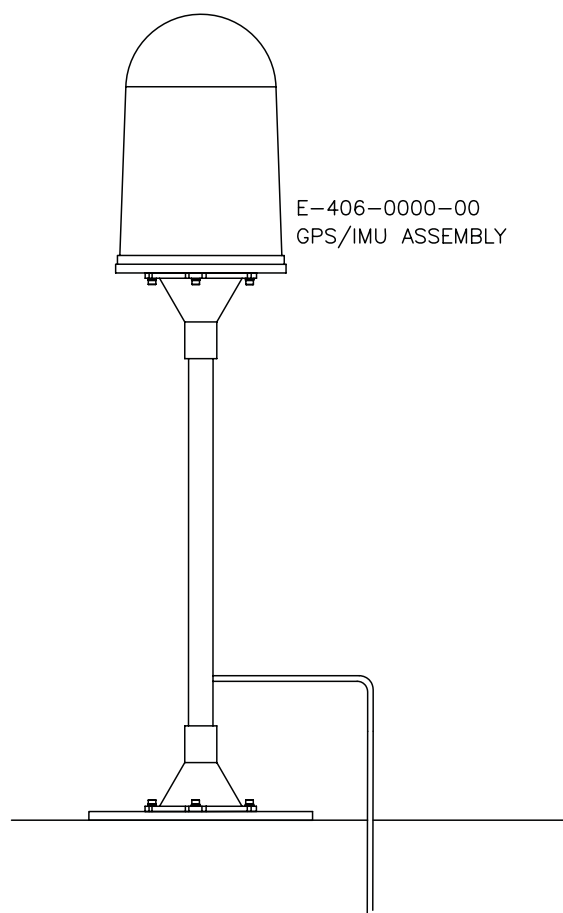

Figure 2-4. GPS/IMU Assembly

2.4.2 VanLink GPS

One of the key functional features of VanLink is its ability to utilize the vehicles current location (Latitude/Longitude), its orientation (Reference to magnetic North), and the static coordinates of each receive site in order to point the dish to the appropriate azimuth. For this feature to be operational, Troll Systems will require a list of each receive site and its coordinates (preferably in DD:MM.MM – Degrees Minutes Hundredths of a Minute) to be programmed into the V750 in advance of system field operation.

Additional sites can be added at any time. The procedure will require an update to both the V750 and TouchStar. Typically, the update to the V750 can be accomplished from the studio provided that there are communications established between the vehicle and TouchStar (hence all of the open ports required).

2.5 CALIBRATION

There are two components of VanLink requiring calibration that need to be performed prior to successful operation of the VanLink operational system. The first component to be calibrated is the magnetometer. The second component to be calibrated is the antenna.

2.5.1 Magnetometer Calibration

After installation, the magnetometer (part of the GPS/IMU assembly) needs to be calibrated. This procedure acquires a magnetic footprint created by any surrounding magnetically impeding structures on/in the vehicle so, regardless of the it's orientation to magnetic north, the V750 can accurately pinpoint the current heading.

- In order to perform calibration on the IMU (magnetometer), the vehicle must be in a location free of magnetic interference and as far away as possible from any nearby structures which could potentially interfere with the magnetometer's reference to North.
- The vehicle must be capable of driving in a tight 360 degree circle with a laptop that is connected to the GPS/IMU and running the calibration software.

2.5.2 Antenna Calibration

Typically calibrated to Magnetic North (to maintain compatibility with the Troll Systems standard configuration NavTrack feature), the antenna's orientation is calculated with an offset to the magnetometer's current heading. This is required to accurately orient the dish to each respective receive site in reference to the vehicle's GPS coordinates and orientation to North.

2.6 REMOTE AND LOCAL CONTROL

Even without remote control, VanLink is a powerful tool. An operator can quickly press a few buttons and have the antenna accurately align itself to the desired receive site with very little training required. While the V750 is in LOCAL mode, only personnel in the vehicle have control of the V750.

Full control of the antenna, including site selection as well as most control for any additional devices, is available from the front panel. It is possible to remotely reset the V750 to enable remote control; otherwise the personnel in the vehicle must enable remote control from the front panel of the V750.

2.7 OPERATING REQUIREMENTS

In order for VanLink to be effective there has to be GPS coverage and a clear microwave path for ENG operations from where the vehicle is located.

For remote control of VanLink, the vehicle will also need to be in an area that has the coverage from the customer's particular cellular service provider.

2.7.1 Transmitter Control / Available Options

There are Control-PACs already written for most transmitters in use for ENG. Most commonly used are MRC's Strata, PTX-Pro, and CR2 along with Nucomm's Channel Master and NewsCasters series. Besides transmitter control, there are an almost infinite number of possibilities for remote control of other components using the V750. For example, it would be relatively easy to remotely control the vehicle's door locks or additional devices mounted in the vehicle's racks. Some devices may require drivers to be written for control, while others may require only simple contact closures. Feel free to contact a Troll Systems representative to learn more about the many possible solutions that VanLink can improve the your ENG operations needs.

SECTION 3

ENGINEERING DRAWINGS

3.1 INTRODUCTION

This section contains top level engineering drawings, such as assembly drawings, schematics, and interconnect diagrams that define the configuration of the equipment used in a typical VanLink System

PROPRIETARY NOTICE:
 TECHNICAL DATA AND DESIGNS DISCLOSED HEREIN ARE THE EXCLUSIVE PROPERTY OF TROLL SYSTEMS CORPORATION AND / OR CONTAIN PROPRIETARY RIGHTS OF OTHERS AND ARE NOT TO BE USED FOR MANUFACTURE OR OTHER PURPOSE WITHOUT PRIOR WRITTEN AUTHORITY OF TROLL SYSTEMS CORPORATION.

REVISIONS				
ECD#	REV	DESCRIPTION	DATE	DRAWN BY
6304	1	INITIAL RELEASE	10/05/08	A. Wheeler

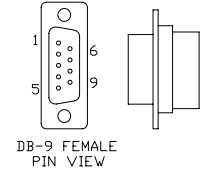
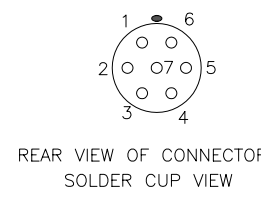

CONNECTOR: C-062-0022-00
 CONTACTS: C-155-0001-00
 HOOD: C-062-0111-00

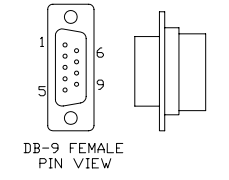
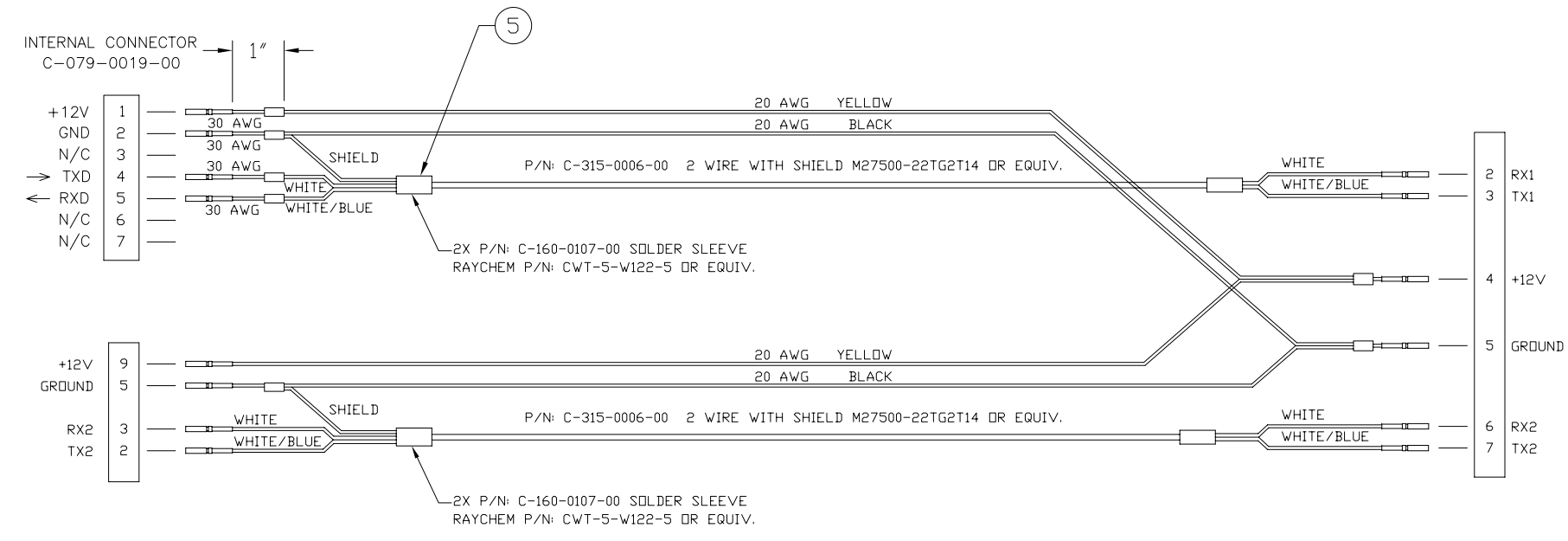

DB9 Female Connector
C-062-0022-00

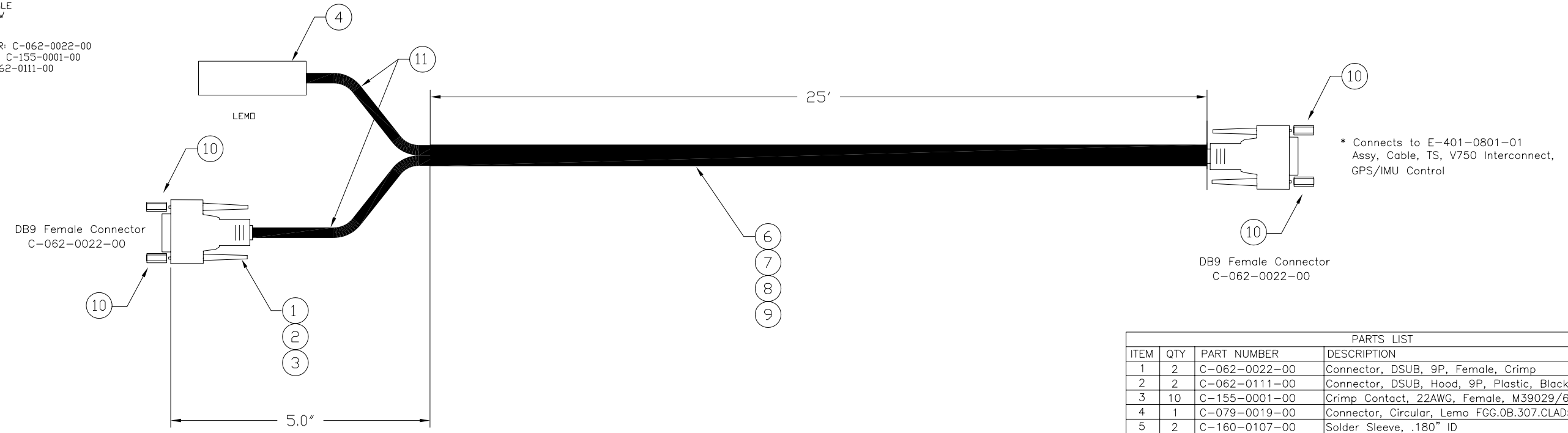

PARTS LIST			
ITEM	QTY	PART NUMBER	DESCRIPTION
1	2	C-062-0022-00	Connector, DSUB, 9P, Female, Crimp
2	2	C-062-0111-00	Connector, DSUB, Hood, 9P, Plastic, Black
3	10	C-155-0001-00	Crimp Contact, 22AWG, Female, M39029/63-368
4	1	C-079-0019-00	Connector, Circular, Lemo FGG.0B.307.CLAD52, use w/XSENS
5	2	C-160-0107-00	Solder Sleeve, .180" ID
6	25'	C-160-0122-00	Sleeving, Braided, 1/4" TechFlex Nylon
7	305"	C-315-0006-00	Wire, 2 Cond, 22AWG, Tefzel
8	305"	C-319-0000-00	Wire, 20AWG, Black, Teflon
9	305"	C-319-0004-00	Wire, 20AWG, Yellow, Teflon
10	4	C-255-0046-00	Standoff, F/F, 4-40, 0.250L, 3/16 Hex, AL Gold
11	12"	C-160-0128-00	Sleeving, Braided, 1/8" TechFlex Nylon
12	4"	C-326-0000-00	Wire, 30AWG, Black, Teflon

APPROVALS	DATE	 VALENCIA, CA 91355 USA (661) 702-8900 www.TROLLSYSTEMS.COM
DRAWN A. Wheeler	10/05/08	
ELEC.		TITLE
MECH.		Assy, Hrns, TS, GPS, IMU Control, V750
PRD.		SIZE PROJECT
QA		REF. P/N
CONFIG.		E-201-0101-01
	SCALE NONE	FILE TYPE/NAME
		ACAD/E-201-0101-01.DWG
		SHEET 1 OF 1

NOTES: UNLESS OTHERWISE SPECIFIED

PROPRIETARY NOTICE:
 TECHNICAL DATA AND DESIGNS DISCLOSED HEREIN ARE THE EXCLUSIVE PROPERTY OF TROLL SYSTEMS CORPORATION AND / OR CONTAIN PROPRIETARY RIGHTS OF OTHERS AND ARE NOT TO BE USED FOR MANUFACTURE OR OTHER PURPOSE WITHOUT PRIOR WRITTEN AUTHORITY OF TROLL SYSTEMS CORPORATION.

REVISIONS				
ECD#	REV	DESCRIPTION	DATE	DRAWN BY
6305	1	INITIAL RELEASE	10/03/08	A. Wheeler

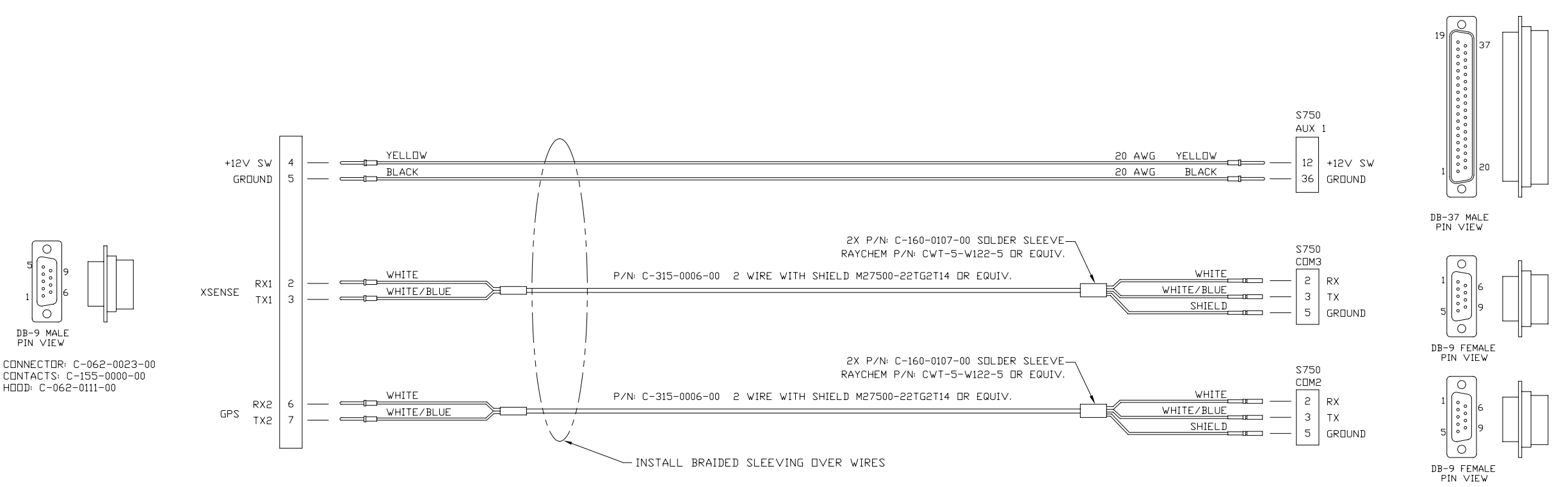

CONNECTOR: C-062-0017-00
 CONTACTS: C-155-0000-00
 HOOD: C-062-0113-00

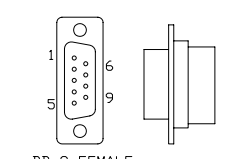
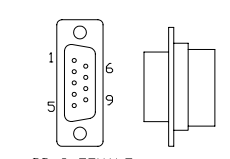
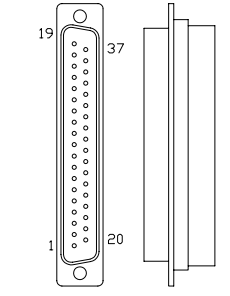

CONNECTOR: C-062-0022-00
 CONTACTS: C-155-0001-00
 HOOD: C-062-0111-00

* Connects to E-201-0101-01 Assy, Hrns, TS, GPS, IMU Control, V750

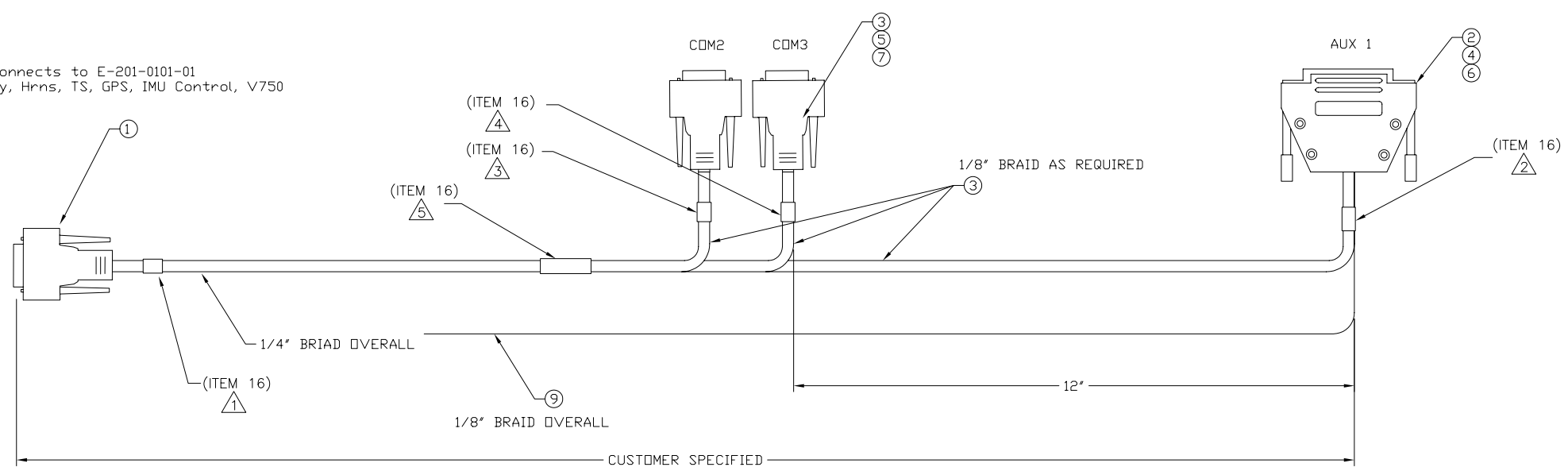

- ⑤ PRINT LABEL (ITEM 16) WITH "E-401-0108-01" AND APPLICABLE REV. LETTER.
 - ④ PRINT LABEL (ITEM 16) WITH "S750 COM3", PLACE WITHIN 5 INCHES OF CONNECTOR.
 - ③ PRINT LABEL (ITEM 16) WITH "S750 COM2", PLACE WITHIN 5 INCHES OF CONNECTOR.
 - ② PRINT LABEL (ITEM 16) WITH "S750 AUX1", PLACE WITHIN 5 INCHES OF CONNECTOR.
 - ① PRINT LABEL (ITEM 16) WITH "GPS/IMU", PLACE WITHIN 5 INCHES OF CONNECTOR.
- NOTES: UNLESS OTHERWISE SPECIFIED

PARTS LIST			
ITEM	QTY	PART NUMBER	DESCRIPTION
1	1	C-062-0023-00	Connector, DSUB, 9P, Male, Crimp
2	1	C-062-0017-00	Connector, DSUB, 37P, Male, Crimp
3	2	C-062-0022-00	Connector, DSUB, 9P, Female, Crimp
4	1	C-062-0113-00	Connector, DSUB, Hood, 37P, Plastic, Black
5	3	C-062-0111-00	Connector, DSUB, Hood, 9P, Plastic, Black
6	10	C-155-0000-00	Crimp Contact, 22AWG, Male, M39029/64-369
7	6	C-155-0001-00	Crimp Contact, 22AWG, Female, M39029/63-368
8	2	C-160-0107-00	Solder Sleeve, .180" ID
9	A/R	C-160-0128-00	Sleeving, Braided, 1/8" TechFlex Nylon
10	A/R	C-160-0122-00	Sleeving, Braided, 1/4" TechFlex Nylon
11	A/R	C-315-0006-00	Wire, 2 Cond, 22AWG, Tefzel
12	A/R	C-319-0000-00	Wire, 20AWG, Black, Teflon
13	A/R	C-319-0004-00	Wire, 20AWG, Yellow, Teflon

APPROVALS	DATE	VALENCIA, CA 91355 USA (661) 702-8900 www.TROLLSYSTEMS.COM	
DRAWN A. Wheeler	10/03/08	TROLL	
ELEC.		TITLE Assy, Cable, TS, V750 Interconnect, GPS/IMU control	
MECH.		SIZE PROJECT	REF. P/N
PRD.		B	E-401-0108-01
QA		SCALE	REV A
CONFIG.		NONE	
		FILE TYPE/NAME	SHEET OF
		ACAD/E-401-0108-01.DWG	1 1

PROPRIETARY NOTICE:
 TECHNICAL DATA AND DESIGNS DISCLOSED HEREIN ARE THE EXCLUSIVE PROPERTY OF TROLL SYSTEMS CORPORATION AND / OR CONTAIN PROPRIETARY RIGHTS OF OTHERS AND ARE NOT TO BE USED FOR MANUFACTURE OR OTHER PURPOSE WITHOUT PRIOR WRITTEN AUTHORITY OF TROLL SYSTEMS CORPORATION.

REVISIONS				
ECD#	REV	DESCRIPTION	DATE	DRAWN BY
-	1	INITIAL RELEASE	XX/XX/XX	

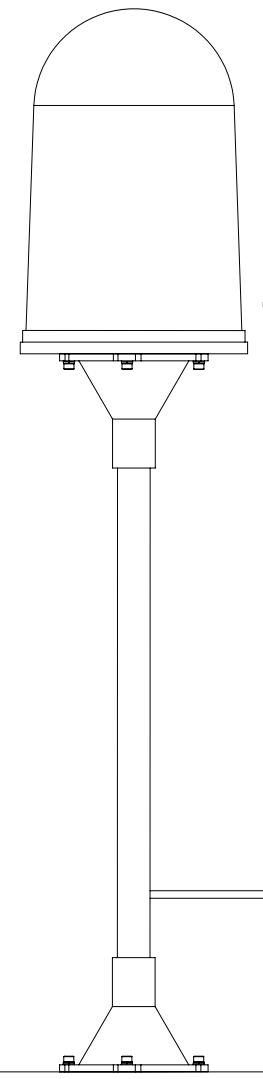

E-406-0000-00
GPS/IMU ASSEMBLY

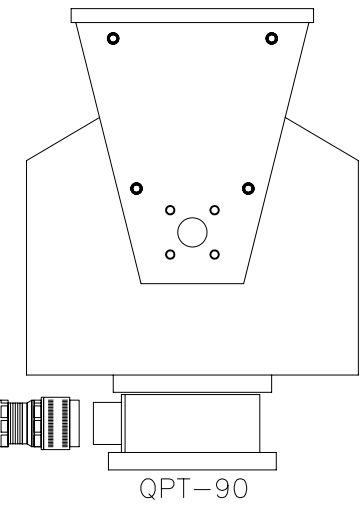

QPT-90

ROOF LINE

four (4) wires

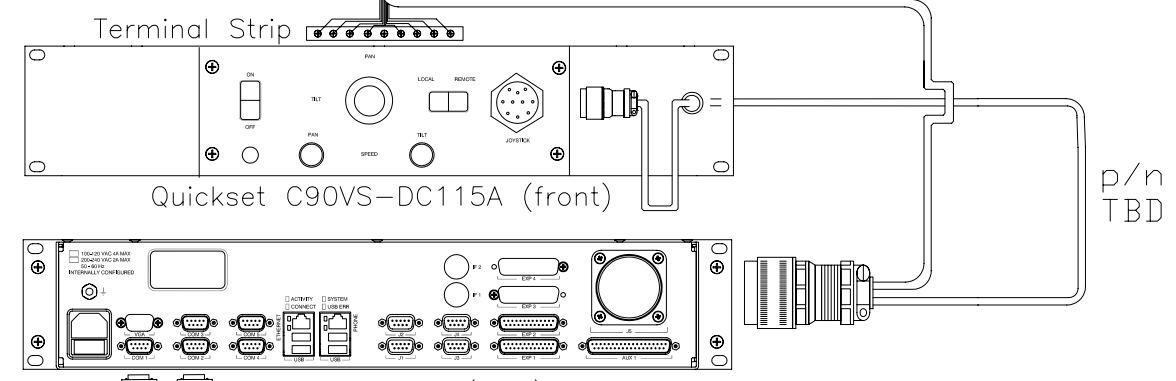

Terminal Strip

Quickset C90VS-DC115A (front)

V750 (rear)

p/n
TBD

Master Control

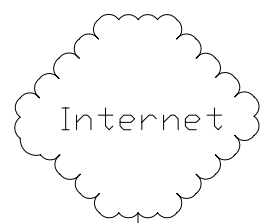

Internet

E-201-0101-01

E-401-0801-01

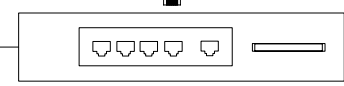

EVDO/3G Router

NOTES: UNLESS OTHERWISE SPECIFIED

APPROVALS	DATE		VALENCIA, CA 91355 USA (661) 702-8900 www.TROLLSYSTEMS.COM	
DRAWN A. Wheeler	10/03/08		TITLE VanLink System Drawing Roof Mounted GPS/IMU	
ELEC.		SIZE	PROJECT	REF. P/N
MECH.		B		
PROD.		SCALE	FILE TYPE/NAME	REV
QA		NONE	ACAD/VanLink System Drawing.DWG	1
CONFIG.				SHEET 1 OF 1

1.0 DESCRIPTION

The Model 7-090VS00-DC115 Pan/Tilt Controller is designed to control Pan/Tilt pedestals such as the QPT-90 which are driven by 115 VDC motors. The Model 7-090VS00-DC115 includes the required power supplies for driving the motors at up to full speed as well as an extra connection for the use of an external joystick. It is housed in an 3½ inch high chassis and accepts 115 VAC power.

1.1 Specifications

<u>Size:</u>	9"W x 3.50"H x 7"D
<u>Weight:</u>	8 lbs.
<u>Prime Power:*</u>	90 to 132 VAC, 50/60 Hz, 6 A max.
<u>Front Panel Controls:</u>	Power On Local / Remote Joystick Selector Pan / Tilt Joystick Pan and Tilt Speed Pots
<u>Front Panel Connectors:</u>	Remote Joystick
<u>Armature Output:</u>	90 to 130 VDC max., @ 0.5 A max.
<u>Field Output:</u>	100 VDC @ 1 A

***Note:** The use of a DC-AC inverter as a source of Prime Power can lead to malfunctions if the input waveform deviates significantly from a pure sine wave. The use of an isolation transformer or an in-line choke to obtain a cleaner signal is recommended in these applications.

1.2 Controls and Indicators

The front panel controls and indicators of the Model 7-090VS00-DC115 are shown in Figure 1.2-1. The rear panel (not shown) has only two connectors: prime power and a dual barrier strip for the pedestal connection.

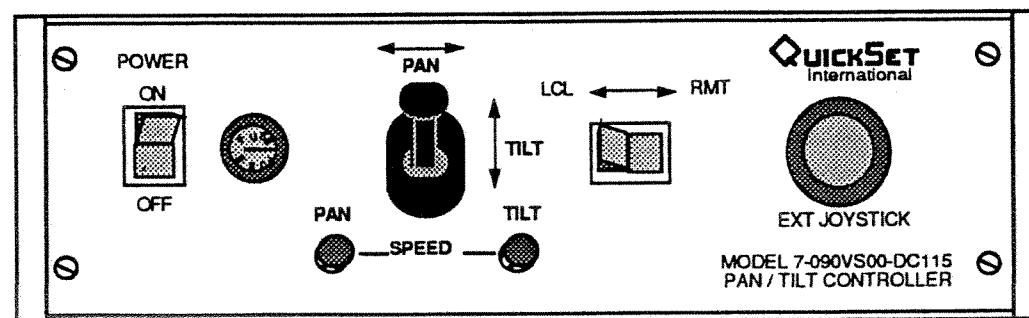

Front Panel View
Figure 1.2-1

Front Panel Controls:

- Power On:** Turns DC power on and off to the Pan / Tilt Controller.
- Pan/Tilt joystick:** This lever causes a drive signal to be applied to the Pan (or Tilt) motor that is directly proportional to the position of the associated pot. Maximum speed is obtained in the fully clockwise position.
- LCL / RMT:** This switch is used to determine whether the front panel-mounted joystick (LCL) or the external joystick (RMT) controls the unit.
- Pan and Tilt Speed Pots:** These knobs adjust the speed of the pan and the tilt. Turning the knob clockwise speeds up the pan or tilt movement. By turning the knob counterclockwise, the speed is reduced. Each knob works independently of the other.

2.0 OPERATION

The Model 7-090VS00-DC115 Pan/Tilt Controller can be operated from the front panel by simply moving the joystick to achieve the desired actions. Pedestal speed is controlled by adjusting the associated speed control pot. Additionally, this unit can be operated from an external joystick assembly by setting the front panel switch control to RMT.

3.0 TROUBLESHOOTING and REPAIR

Troubleshooting of the Model 7-090VS00-DC115 Pan/Tilt Controller should follow the logical sequence outlined below:

- (1) Verify DC power is applied.
- (2) Verify fuse in front panel is not blown.
- (3) Verify that the suspected problem is not caused by a malfunctioning pedestal.
- (4) Verify that all external equipment connected to the Model 7-090VS00-DC115 meets the interface specifications of Section 5.0.
- (5) If the problem persists, turn off DC power to the unit, remove all connections, and turn power back on.
- (6) If the problem is only with the Pan or Tilt control, check that power is being delivered to the appropriate driver. If the power is OK, replace the driver.

J1 PAN / TILT CONNECTOR

<u>PIN</u>	<u>DESCRIPTION</u>
1	Right
2	Left
3	Up
4	Down
5	Pos. Field, Pan
6	Neg. Field, Pan
7	Pos. Field, Tilt
8	Neg. Field, Tilt

NOTE: Use either the Pan field supply (Pins 5 and 6) or the Tilt field supply (Pins 7 and 8) to energize the field windings in Pan/Tilt unit.

Located left of the A/C receptacle on the rear frame is the chassis ground stud.

DWG. NO. 100485 RSS

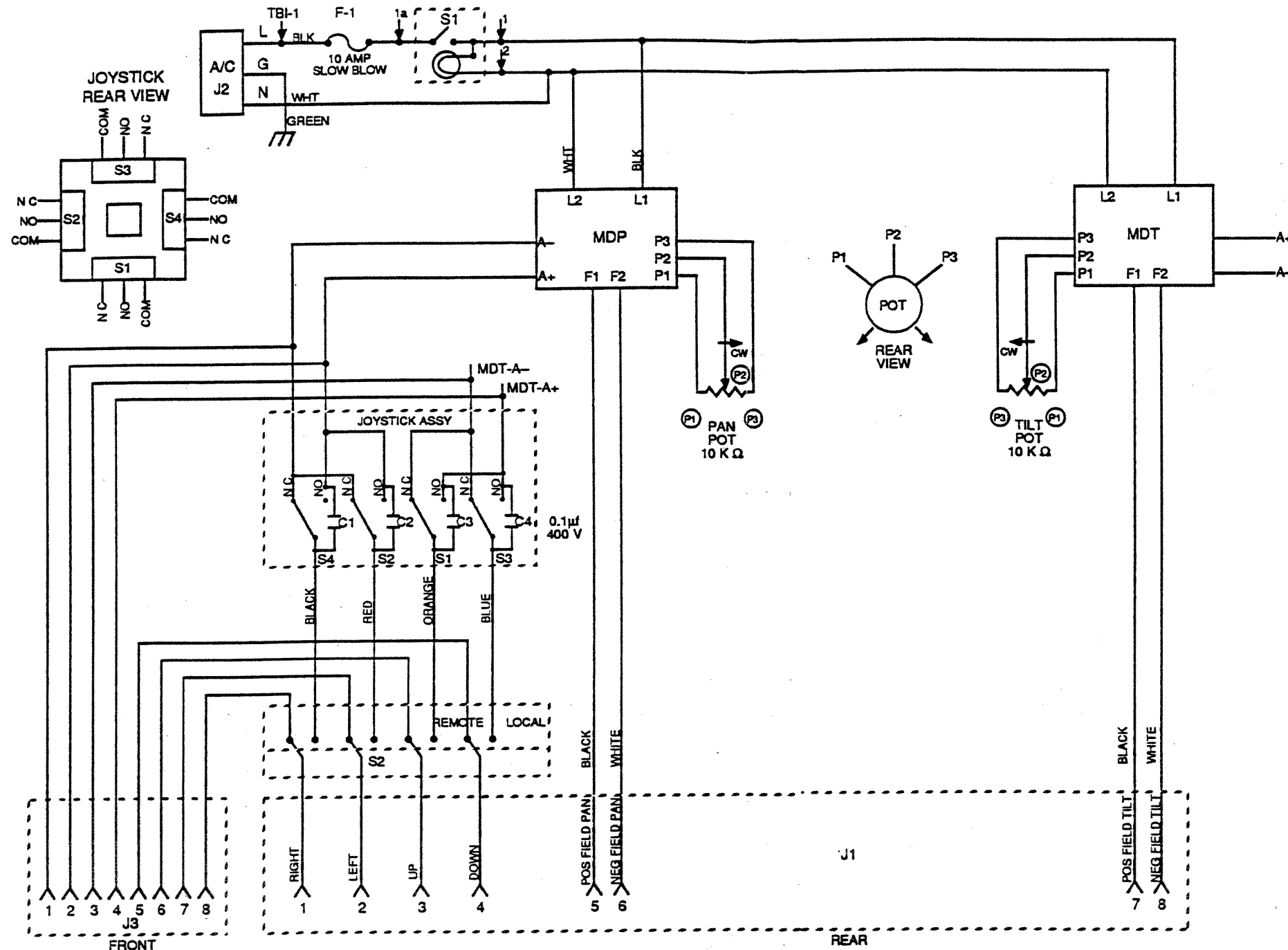

NOTES:
1. S2 SHOWN IN REMOTE POSITION

PART	LOCATION	P/N
MOTOR CONTROLLER	MDP, MDT	100560
TERMINAL STRIP	TB1	100561
AC RECEPTACLE	J2	100562
TERMINAL BLOCK	J1	100563
SWITCH, ROCKER	S1	100564
JOYSTICK		100565
FUSE	F1	100566
SWITCH, 4 PDT	S2	100567
CAPACITOR	C1-34	100568
CONNECTOR, 8 POS	J3	100602

CHG.	E. C. N. NO.	DATE	BY:	CK.
G		3/19/96		
F		11/29/95		
E		5/16/95		

UNLESS OTHERWISE SPECIFIED
 REMOVE ALL BURRS
 TOLERANCE ON ALL .X DIM. $\pm .016$
 TOLERANCE ON ALL .XX DIM. $\pm .010$
 TOLERANCE ON ALL .XXX DIM. $\pm .008$
 THREAD LENGTH DIMENSIONS ARE FOR FULL THREADS
 ALL CORNERS $.0006 / .010$ R.
 DO NOT SCALE DRAWING

DR.	DATE:
CK.	
APP.	
SCALE:	

QuickSet International, Inc.
 3650 Woodhead Drive
 Northbrook, IL 60062

QUICKSET

NAME:
7-090VS00-DC115 PEDESTAL CONTROLLER

MATERIAL:

DWG. NO.
100485 RSS

Free Manuals Download Website

<http://myh66.com>

<http://usermanuals.us>

<http://www.somanuals.com>

<http://www.4manuals.cc>

<http://www.manual-lib.com>

<http://www.404manual.com>

<http://www.luxmanual.com>

<http://aubethermostatmanual.com>

Golf course search by state

<http://golfingnear.com>

Email search by domain

<http://emailbydomain.com>

Auto manuals search

<http://auto.somanuals.com>

TV manuals search

<http://tv.somanuals.com>