



FS-1020D

Page Printer



Operation Guide

Caution

NO LIABILITY IS ASSUMED FOR ANY DAMAGE CAUSED BY IMPROPER INSTALLATION.

Notice on Software

SOFTWARE USED WITH THIS PRINTER MUST SUPPORT THE PRINTER'S EMULATION MODE. The printer is factory-set to emulate the PCL. The emulation mode can be changed by following the procedures described in [Chapter 1](#).

Notice

The information in this manual is subject to change without notification. Additional pages may be inserted in future editions. The user is asked to excuse any technical inaccuracies or typographical errors in the present edition.

No responsibility is assumed if accidents occur while the user is following the instructions in this manual. No responsibility is assumed for defects in the printer's firmware (contents of its read-only memory).

This manual, any copyrightable subject matter sold or provided with or in connection with the sale of the page printer, are protected by copyright. All rights are reserved. Copying or other reproduction of all or part of this manual, any copyrightable subject matter without the prior written consent of Kyocera Mita Corporation is prohibited. Any copies made of all or part of this manual, any copyrightable subject must contain the same copyright notice as the material from which the copying is done.

Regarding Tradenames

PRESCRIBE is a registered trademark of Kyocera Corporation. KPDL and KIR (Kyocera Image Refinement) are trademarks of Kyocera Corporation.

Diablo 630 is a product of Xerox Corporation. IBM Proprinter X24E is a product of International Business Machines Corporation. Epson LQ-850 is a product of Seiko Epson Corporation.

Hewlett-Packard, PCL, and PJI are registered trademarks of Hewlett-Packard Company. Centronics is a trade name of Centronics Data Computer Corp. PostScript is a registered trademark of Adobe Systems Incorporated. Macintosh is a registered trademark of Apple Computer, Inc. Microsoft, Windows, and Windows NT are registered trademarks of Microsoft Corporation. PowerPC is a trademark of International Business Machines Corporation. ENERGY STAR is a U.S. registered mark. All other brand and product names are registered trademarks or trademarks of their respective companies.

This Kyocera Mita page printer uses PeerlessPrintXL to provide the HP LaserJet compatible PCL6 language emulation. PeerlessPrintXL is a trademark of The Peerless Group, Redondo Beach, CA 90278, U.S.A.

This product was developed using the Tornado™ Real Time Operating System and Tools from Wind River Systems.

AGFA  This product contains UFST™ and MicroType® from Agfa Corporation.

IBM PROGRAM LICENSE AGREEMENT

THE DEVICE YOU HAVE PURCHASED CONTAINS ONE OR MORE SOFTWARE PROGRAMS (“PROGRAMS”) WHICH BELONG TO INTERNATIONAL BUSINESS MACHINES CORPORATION (“IBM”). THIS DOCUMENT DEFINES THE TERMS AND CONDITIONS UNDER WHICH THE SOFTWARE IS BEING LICENSED TO YOU BY IBM. IF YOU DO NOT AGREE WITH THE TERMS AND CONDITIONS OF THIS LICENSE, THEN WITHIN 14 DAYS AFTER YOUR ACQUISITION OF THE DEVICE YOU MAY RETURN THE DEVICE FOR A FULL REFUND. IF YOU DO NOT SO RETURN THE DEVICE WITHIN THE 14 DAYS, THEN YOU WILL BE ASSUMED TO HAVE AGREED TO THESE TERMS AND CONDITIONS.

The Programs are licensed not sold. IBM, or the applicable IBM country organization, grants you a license for the Programs only in the country where you acquired the Programs. You obtain no rights other than those granted you under this license.

The term “Programs” means the original and all whole or partial copies of it, including modified copies or portions merged into other programs. IBM retains title to the Programs. IBM owns, or has licensed from the owner, copyrights in the Programs.

1. License

Under this license, you may use the Programs only with the device on which they are installed and transfer possession of the Programs and the device to another party.

If you transfer the Programs, you must transfer a copy of this license and any other documentation to the other party. Your license is then terminated. The other party agrees to these terms and conditions by its first use of the Program.

You may not:

- 1) use, copy, modify, merge, or transfer copies of the Program except as provided in this license;
- 2) reverse assemble or reverse compile the Program; or
- 3) sublicense, rent, lease, or assign the Program.

2. Limited Warranty

The Programs are provided “AS IS.”

THERE ARE NO OTHER WARRANTIES COVERING THE PROGRAMS (OR CONDITIONS), EXPRESS OR IMPLIED, INCLUDING, BUT NOT LIMITED TO, THE IMPLIED WARRANTIES OF MERCHANTABILITY AND FITNESS FOR A PARTICULAR PURPOSE.

Some jurisdictions do not allow the exclusion of implied warranties, so the above exclusion may not apply to you.

SUPPLEMENT TO AGREEMENT FOR SOFTWARE BUNDLING AND DISTRIBUTION FOR ALDC

3. Limitation of Remedies

IBM’s entire liability under this license is the following;

1) For any claim (including fundamental breach), in any form, related in any way to this license, IBM’s liability will be for actual damages only and will be limited to the greater of:

- a) the equivalent of U.S.\$25,000 in your local currency; or
- b) IBM’s then generally available license fee for the Program

This limitation will not apply to claims for bodily injury or damages to real or tangible personal property for which IBM is legally liable.

IBM will not be liable for any lost profits, lost savings, or any incidental damages or other economic consequential damages, even if IBM, or its authorized supplier, has been advised of the possibility of such damages. IBM will not be liable for any damages claimed by you based on any third party claim. This limitation of remedies also applies to any developer of Programs supplied to IBM. IBM’s and the developer’s limitations of remedies are not cumulative. Such developer is an intended beneficiary of this Section. Some jurisdictions do not allow these limitations or exclusions, so they may not apply to you.

4. General

You may terminate your license at any time. IBM may terminate your license if you fail to comply with the terms and conditions of this license. In either event, you must destroy all your copies of the Program. You are responsible for payment of any taxes, including personal property taxes, resulting from this license. Neither party may bring an action, regardless of form, more than two years after the cause of action arose. If you acquired the Program in the United States, this license is governed by the laws of the State of New York. If you acquired the Program in Canada, this license is governed by the laws of the Province of Ontario. Otherwise, this license is governed by the laws of the country in which you acquired the Program.

Typeface Trademark Acknowledgement

All resident fonts in this printer are licensed from Agfa Corporation.

Helvetica, Palatino and Times are registered trademarks of Linotype-Hell AG.

ITC Avant Garde Gothic, ITC Bookman, ITC ZapfChancery and ITC Zapf Dingbats are registered trademarks of International Typeface Corporation.

Agfa Japan License Agreement Guidelines

- 1) "Software" shall mean the digitally encoded, machine readable, scalable outline data as encoded in a special format as well as the UFST Software.
- 2) You agree to accept a non-exclusive license to use the Software to reproduce and display weights, styles and versions of letters, numerals, characters and symbols ("Typefaces") solely for your own customary business. Agfa Japan retains all rights, title and interest to the Software and Typefaces and no rights are granted to you other than a License to use the Software on the terms expressly set forth in this Agreement.
- 3) To protect proprietary rights of Agfa Japan, you agree to maintain the Software and other proprietary information concerning the Typefaces in strict confidence and to establish reasonable procedures regulating access to and use of the Software and Typefaces.
- 4) You agree not to duplicate or copy the Software or Typefaces, except that you may make one backup copy.
- 5) This License shall continue until the last use of the Software and Typefaces, unless sooner terminated. This License may be terminated by Agfa Japan if you fail to comply with the terms of this License and such failure is not remedied within thirty (30) days after notice from Agfa Japan. When this License expires or is terminated, you shall either return to Agfa Japan or destroy all copies of the Software and Typefaces and documentation as requested.
- 6) You agree that you will not modify, alter, disassemble, decrypt, reverse engineer or decompile the Software.
- 7) Agfa Japan warrants that for ninety (90) days after delivery, the Software will perform in accordance with Agfa Japan-published specifications, Agfa Japan does not warrant that the Software is free from all bugs, errors and omissions.
THE PARTIES AGREE THAT ALL OTHER WARRANTIES, EXPRESSED OR IMPLIED, INCLUDING WARRANTIES OF FITNESS FOR A PARTICULAR PURPOSE AND MERCHANTABILITY, ARE EXCLUDED.
- 8) Your exclusive remedy and the sole liability of Agfa Japan in connection with the Software and Typefaces is repair or replacement of defective parts, upon their return to Agfa Japan.
IN NO EVENT WILL AGFA JAPAN BE LIABLE FOR LOST PROFITS, LOST DATA, OR ANY OTHER INCIDENTAL OR CONSEQUENTIAL DAMAGES, OR ANY DAMAGES CAUSED BY ABUSE OR MISAPPLICATION OF THE SOFTWARE AND TYPEFACES.
- 9) New York, U.S.A. law governs this Agreement.
- 10) You shall not sublicense, sell, lease, or otherwise transfer the Software and/or Typefaces without the prior written consent of Agfa Japan.
- 11) Use, duplication or disclosure by the Government is subject to restrictions as set forth in the Rights in Technical Data and Computer Software clause at FAR 252-227-7013, subdivision (b)(3)(ii) or subparagraph (c)(1)(ii), as appropriate. Further use, duplication or disclosure is subject to restrictions applicable to restricted rights software as set forth in FAR 52.227-19 (c)(2).
- 12) YOU ACKNOWLEDGE THAT YOU HAVE READ THIS AGREEMENT, UNDERSTAND IT, AND AGREE TO BE BOUND BY ITS TERMS AND CONDITIONS. NEITHER PARTY SHALL BE BOUND BY ANY STATEMENT OR REPRESENTATION NOT CONTAINED IN THIS AGREEMENT. NO CHANGE IN THIS AGREEMENT IS EFFECTIVE UNLESS WRITTEN AND SIGNED BY PROPERLY AUTHORIZED REPRESENTATIVES OF EACH PARTY.

Cautions for Toner Handling

- Do not incinerate the toner and toner containers. Dangerous sparks may cause burn.
- Never open the toner container or waste toner box.
- Make sure not to inhale the toner, and not to rub your eyes or touch your mouth with the hands stained with the toner. And make sure not to stick to your skin.
- For the disposal of old toner container and waste toner box, consult your dealer. Or dispose of the toner or toner containers in accordance with Federal, State and Local rules and regulations.
- Keep away the toner container from children.

Contents

Introduction	vii
Guide to the Manuals.....	viii
Guide to the Operation Guide.....	ix
Chapter 1 Basic Operations	1-1
1.1 Operator Panel.....	1-2
1.1.1 Indicators.....	1-3
1.1.2 Keys.....	1-3
Chapter 2 Maintenance	2-1
2.1 Toner Container Replacement	2-2
2.1.1 Toner Container Replacement Interval	2-2
2.1.2 Replenishing Toner	2-3
2.2 Cleaning the Printer	2-6
2.2.1 Printer Interior.....	2-6
Chapter 3 Troubleshooting	3-1
3.1 General Guide for Troubleshooting	3-2
3.2 Print Quality Problems	3-3
3.3 Indicators	3-6
3.3.1 Maintenance Messages	3-7
3.3.2 Errors Requiring Service Personnel Attention.....	3-9
3.3.3 Error Messages.....	3-12
3.3.4 Normal Indicator Display	3-14
3.4 Paper Jam Removal.....	3-15
3.4.1 Jam at the Face-down Tray and the Rear Cover.....	3-15
3.4.2 Jam at the Paper Cassette.....	3-16
3.4.3 Jam at the Duplexer	3-16
3.4.4 Jam Inside the Printer.....	3-18
3.4.5 Jam at the MP Tray.....	3-19

Chapter 4 Paper Selection.....	4-1
4.1 General Guidelines	4-2
4.1.1 Paper Availability.....	4-2
4.1.2 Paper Specifications	4-2
4.2 Selecting the Right Paper	4-3
4.3 Special Paper	4-7
4.3.1 Transparency (overhead projection film)	4-7
4.3.2 Adhesive-Backed Labels	4-8
4.4 Paper Type	4-11
Chapter 5 Fonts	5-1
5.1 Internal Fonts	5-2
5.2 List of Fonts	5-3
5.2.1 Internal Scalable and Bitmap Fonts and KPDL Fonts	5-3
Appendix A Options.....	A-1
A.1 Available Options	A-2
A.2 Expansion Memory Installation	A-3
A.3 Memory (CompactFlash) Card	A-8
A.4 Network Interface Card.....	A-10
Appendix B Host Computer Interface.....	B-1
B.1 Parallel Interface.....	B-2
B.1.1 Parallel Interface Communication Modes.....	B-2
B.1.2 Interface Signals.....	B-2
B.2 USB Interface	B-6
B.2.1 Specifications	B-6
B.2.2 Interface Signals.....	B-6
B.3 Serial Interface (Option)	B-7
B.3.1 RS-232C Interface	B-7
B.4 RS-232C Protocol.....	B-9
B.4.1 PRESCRIBE FRPO D0 Command	B-10
B.5 RS-232C Cable Connection.....	B-11
B.5.1 Obtain a Suitable RS-232C Cable	B-11
B.5.2 Connecting the Printer to the Computer	B-11

Appendix C Printer Specifications C-1
C.1 Printer Specifications..... C-2

Glossary Glossary-1

Index Index-1

Introduction

The Kyocera Mita page printer has many desirable features, such as the duplex printing mode which lets you print onto both sides of the paper and an Auto Media Type Selection function that automatically selects the media before printing.

This section explains the following topics:

- **Guide to the Manuals**
- **Guide to the Operation Guide**

Guide to the Manuals

Item	Description
Installation Guide (paper manual)	Describes procedures from printer setup to printing a test page.
KX Printer Driver Installation Guide (paper manual)	Describes the procedure to install the printer driver software.
Operation Guide (this manual)	Guides you through topics concerning the operations and maintenance of the printer.
KX Printer Drivers Operation Guide	Describes how to install and set the printer driver.
PRESCRIBE Command Technical Reference	PRESCRIBE is the native language of the Kyocera Mita printers. This Technical Reference contains the information about how the printing is performed using the PRESCRIBE commands as well as the font and emulation description. Also included is a list of permanent parameters and their explanation needed when customizing your printer.
PRESCRIBE Command Reference	Gives a detailed explanation of the PRESCRIBE command syntax and parameters with the aid of print examples.



Note

- For information on how to install the printer driver software, refer to the KX Printer Driver Installation Guide that is included with the printer.
- For information on how to use the printer driver software, refer to the KX Printer Driver Operation Guide that is included on the Kyocera Mita Document Library CD-ROM.

Guide to the Operation Guide

This *Operation Guide* guides you through the following topics:

Chapter 1 Basic Operations

This chapter describes the names and functions of the keys and indicators on top of the printer.

Chapter 2 Maintenance

This chapter explains how to replace the toner container and how to care for your printer.

Chapter 3 Troubleshooting

This chapter explains how to handle printer problems that may occur, such as paper jams.

Chapter 4 Paper Selection

This chapter explains the types of paper that can be used with the printer.

Chapter 5 Fonts

This chapter explains about and lists the printer's internal fonts.

Appendix A Options

This appendix explains available options, how to expand the printer's memory, and also how to install the memory card and the network interface card.

Appendix B Host Computer Interface

This appendix describes the pin assignment and specifications for the printer's parallel interface, USB interface, and optional serial interface.

Appendix C Printer Specifications

This appendix lists the printer's specifications.

Glossary

This glossary explains the terminology used in this guide.

Chapter 1 **Basic Operations**

This chapter explains the following topic:

- **Operator Panel**

1.1 Operator Panel

The operator panel on top of the printer consists of four indicators and two keys. The four indicators light, flash, and go off in combination, indicating the printer's status. The keys perform operations, such as canceling data, switching the printer mode between online and offline status, and printing status pages.

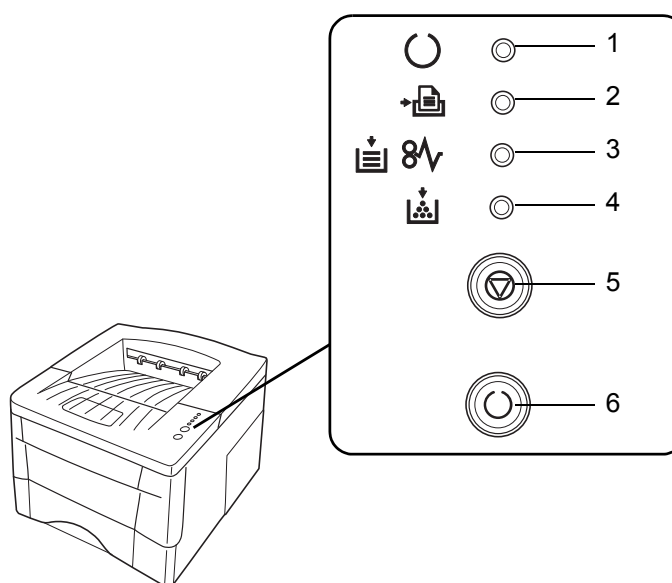

Figure 1-1



Note

The numbers used in the above figure are referred to in the Reference column of the table on the following page.

1.1.1 Indicators

Refer to the following table for the name and description of each indicator. The same indicator can have a variety of meanings, depending on the speed at which it is flashing. For details, see [Chapter 3](#).





Reference	Name	Status	Meaning
1	 (Green)	Lit	Indicates online status (printing is possible).
		Flashing	<ul style="list-style-type: none"> An error has occurred, but printing resumes when the  key is pressed. Offline status. You cannot print, but the printer can receive data. The printer is in sleep mode.
		Off	Printing has stopped because an error has occurred.
2	 (Green)	Lit	The printer is processing data.
		Flashing	The printer is receiving data.
3	 (Red)	Lit	The printer cover is open.
		Flashing	<ul style="list-style-type: none"> A paper jam has occurred. The paper cassette is not inserted properly or the paper has run out.
		Off	The printer status is normal.
4	 (Red)	Lit	The printer has stopped because the toner is exhausted.
		Flashing	The toner is running low.

Table 1-1

1.1.2 Keys

Refer to the following table for the name and description of the basic functions of each key.



Reference	Name	Function
5	 key (Cancel key)	Cancels printing in progress when pressed for 1 second or more.
6	 key (Go key)	<ul style="list-style-type: none"> Switches between online and offline when pressed for less than 3 seconds. Depending on the error message displayed in the KM-NET for Clients, there are cases where operation will continue after pressing this key. If such a message appears, operation resumes when this key is pressed. (The KM-NET for Clients utility is used for making printer setting from a computer and is contained on the Kyocera Mita Software Library CD-ROM that is supplied with the printer. For details, see the KM-NET for Clients Operation Guide.) Prints a standard status page[†] when pressed for 3 seconds or more and less than 10 seconds. Prints a service status page^{††} when pressed for 10 seconds or more.

Table 1-2

[†] For a full description of the standard status page, see the next page.

^{††} The service status page is used for service purposes.

Understanding the Status Page

The following is the printout of a typical standard status page. Its contents are explained in detail on the next page.

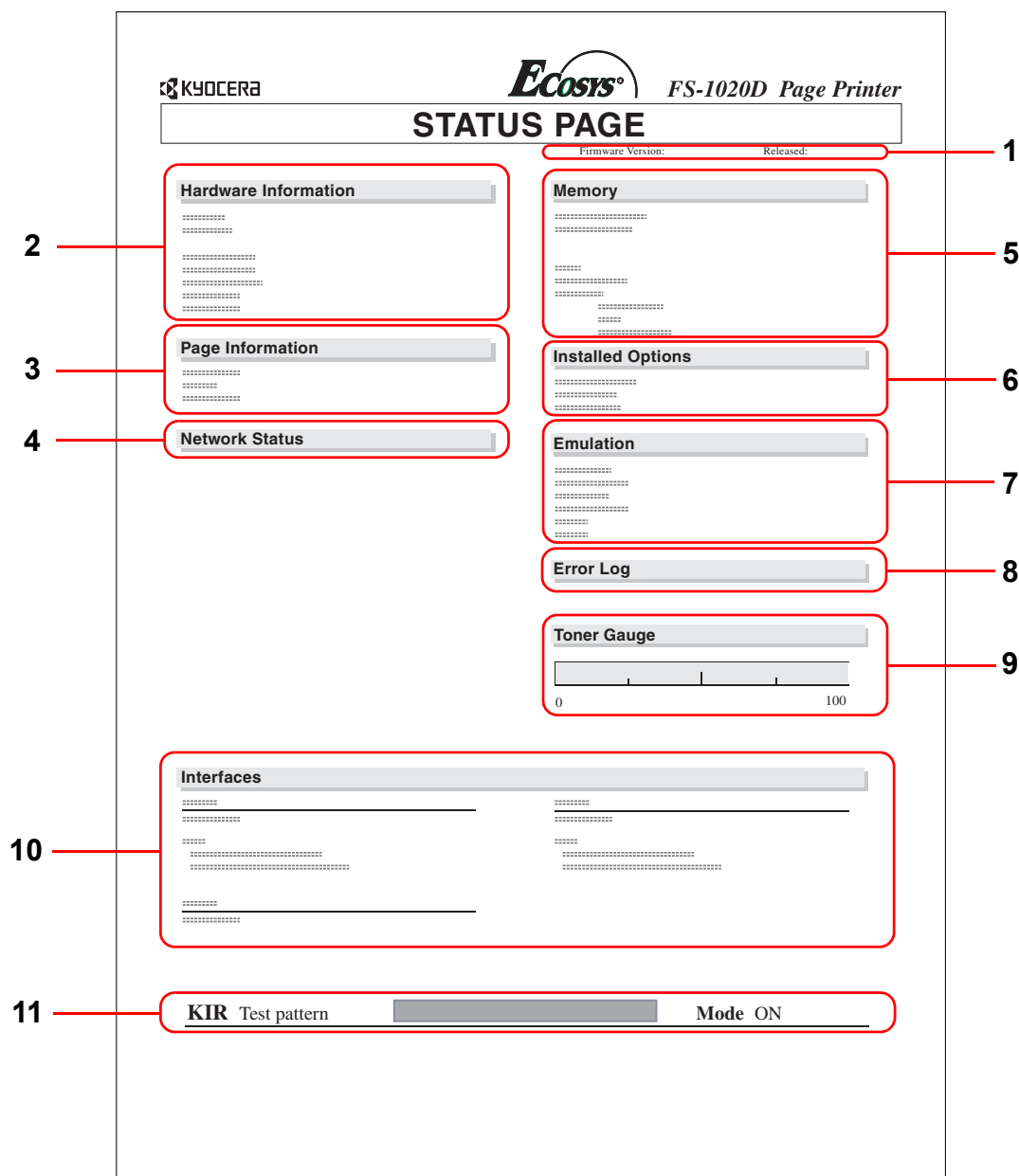

Figure 1-2



Note

Items and values on the status page may vary depending on the printer's firmware version.

1 — Software Version

This information shows the software (firmware) version and date of issue of the printer.

2 — Hardware Information

This information shows the currently selected paper source (indicated by an asterisk), paper size, and various other printer settings.

3 — Page Information

This information shows the currently selected resolution, number of copies printed to date, and the total page count.

4 — Network Status

This shows the IP address, subnet mask address, default gateway address and other settings for the network interface card installed in the printer.

5 — Memory

This information shows the amount of total memory installed in the printer, the amount of currently available memory, and the current status of the RAM disk.

6 — Installation Options

This shows the option(s) currently installed in the printer.

7 — Emulation

This shows all available emulations and the currently selected emulation (marked with an asterisk). The printer is shipped from the factory with PCL 6 emulation selected.

8 — Error Log

This shows the last three instances of the following six types of errors, listed in order of occurrence: KPDL Error Press GO; Memory overflow Press GO; Print overrun Press GO; File not found Press GO; MemoryCard err Press GO; RAM disk error Press GO. (These are displayed on the computer screen when using **KM-NET for Clients**.)

The most recent error is displayed on the top line of the Error Log. For error remedies, see [Chapter 3](#). Error information is cleared when the printer's power is turned off.

9 — Toner Gauge

This shows the approximate level of remaining toner. When the value is 100, the toner container is full. The closer to 0, the smaller the amount of remaining toner.

10 — Interface Information

This information shows all interfaces installed in the printer and the currently selected interface (marked with an asterisk).

The Font section shows the font that is automatically selected when the printer starts up (default font). It is possible to set different default fonts for each interface.

11 — KIR Test Pattern

This shows the KIR test pattern. You can confirm whether KIR is on or off.

Chapter 2 **Maintenance**

This chapter explains how to replace the toner container and how to clean parts such as the registration roller and charger wire.

This chapter explains the following topics:

- **Toner Container Replacement**
- **Cleaning the Printer**

2.1 Toner Container Replacement

When the printer runs low on toner, the  (toner) indicator flashes on the operator panel. Be sure to promptly replace the toner container and clean the inside of the printer when this message appears.

If the printer stops printing while the  (toner) indicator is lit, replace the toner container to continue printing.

2.1.1 Toner Container Replacement Interval

Assuming an average toner coverage of 5%, with EcoPrint mode turned off the toner container will need replacing approximately once every 7,200* printed pages.

- * In the case of a new printer in which a toner kit has been installed for the first time, the number of copies that can be printed will be approximately 3,600.

Toner Kit to be Used

Name: TK-18

Description: Toner container

Wiper cloth

Plastic bag

Installation Guide

(The kit supplied with the printer only contains the toner container and wiper cloth.)



Note

- Be sure to distance items such as floppy disks during toner container replacement.
- Be sure to clean the inside of the printer when replacing the toner container. For details, see section [2.2 Cleaning the Printer](#) on page [2-6](#).
- Use of original Kyocera Mita toner kits is highly recommended to prevent printer trouble and ensure the long life of the printer.

2.1.2 Replenishing Toner

- 1 Open the printer's top cover.

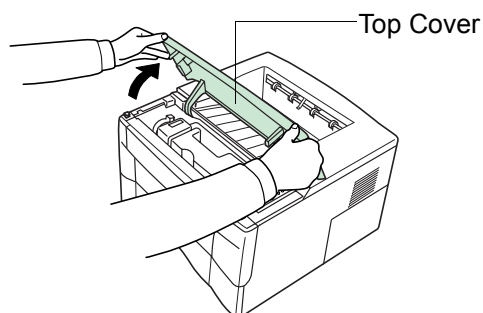

Figure 2-1

- 2 Pull lock lever #1 to the release (**UNLOCK**) position, then pull lock lever #2 to the release (right) position.

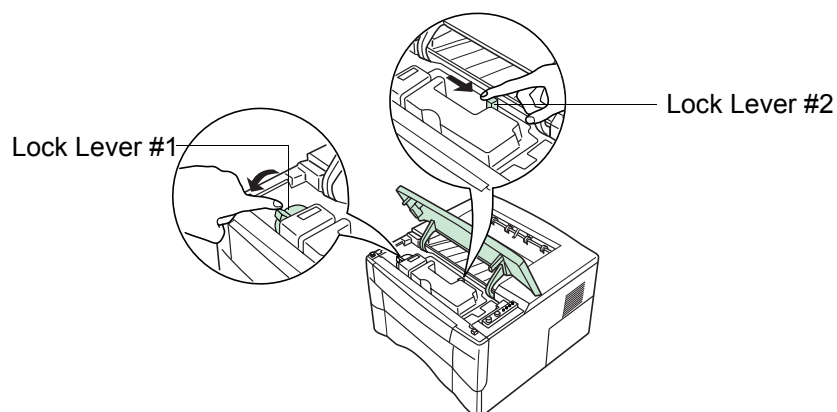

Figure 2-2

- 3 Gently remove the old toner container. Put it in the supplied plastic bag and dispose of it.

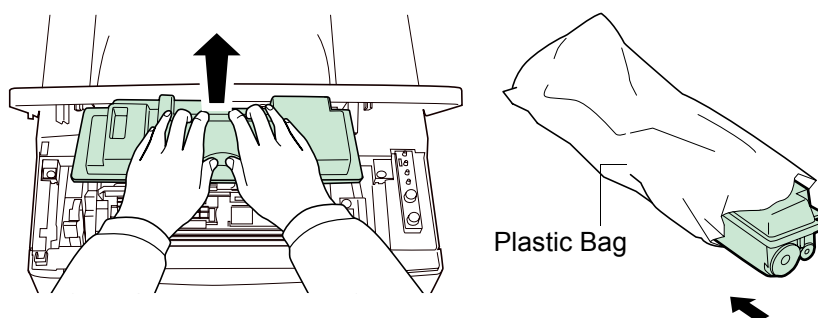

Figure 2-3

- 4** Take the new toner container from the bag. Hold it with the protective seal (orange-colored) facing up. Shake the toner container horizontally at least 5 times. This ensures that the toner is evenly distributed inside.

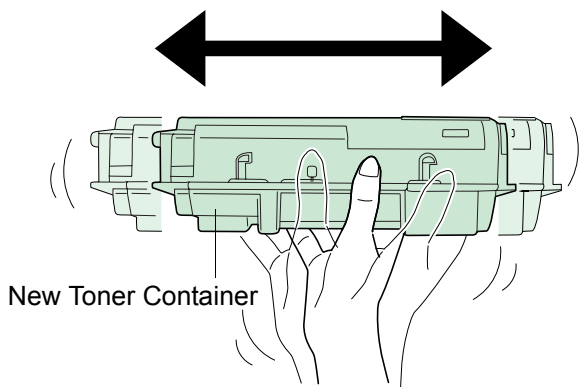

Figure 2-4

- 5** Carefully remove the protective seal (orange-colored).

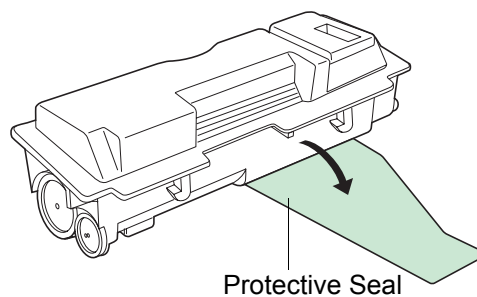

Figure 2-5

- 6** Install the new toner container in the printer. Push firmly on the top of the container at the positions marked **PUSH HERE** until you hear it click in place.

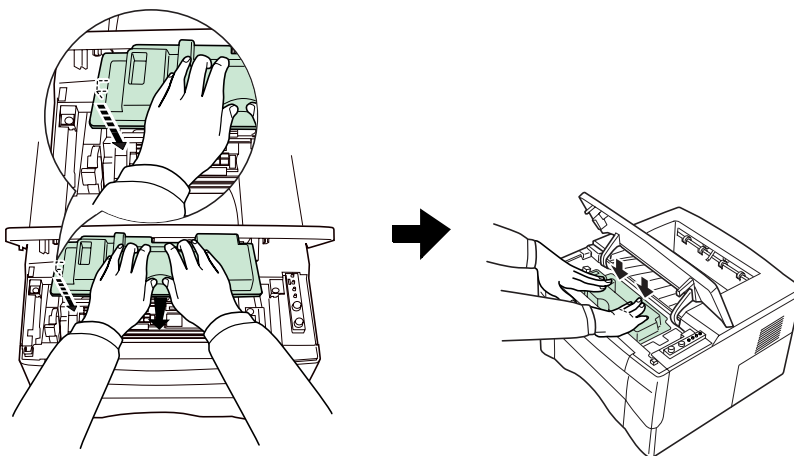

Figure 2-6

- 7** While pushing down on the toner container, push lock lever #1 to the lock (**LOCK**) position. (Lock lever #2 is automatically locked.)

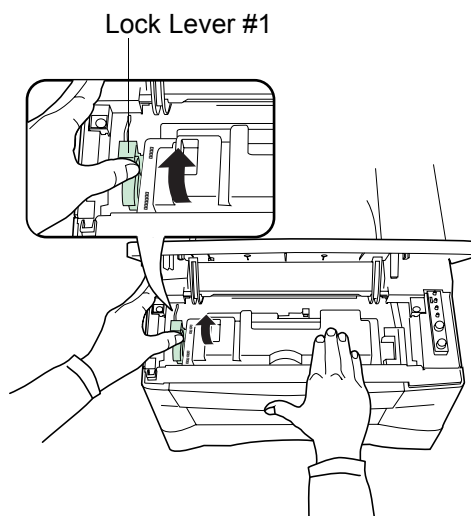



Figure 2-7



Note

- If the toner low indication flashes or remains lit after installing the new toner container, take the toner container out once, shake it well, then install again.
- After you have replaced the toner container, be sure to reset the internal toner counter. To reset the toner counter, next time you turn on the power to the printer, keep pushing the  key until the Ready indicator lights up.

2.2 Cleaning the Printer

To avoid print quality problems, the interior of the printer must be cleaned with every toner container replacement.



Note

Cleaning should be done from time to time to avoid print quality problems.

2.2.1 Printer Interior

To avoid print quality problems due to paper dust and debris, clean the interior of the printer in the following manner.

- 1 Open the printer's top and front covers.

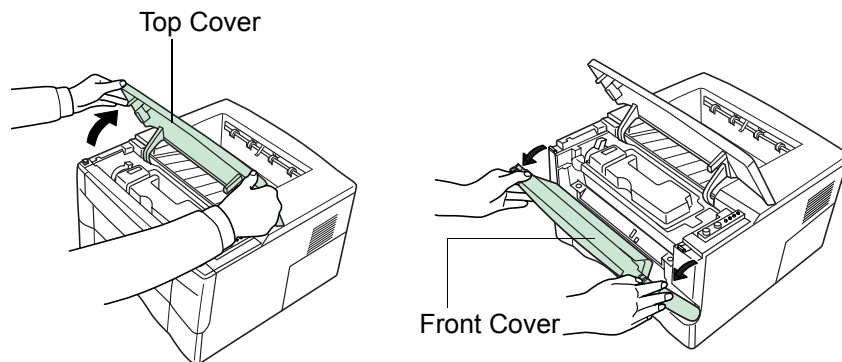

Figure 2-8

- 2 Lift the process unit together with the toner container out of the printer.



Note

The drum in the process unit is sensitive to light. Never expose the drum even to normal office lighting (500 lux) for more than five minutes.

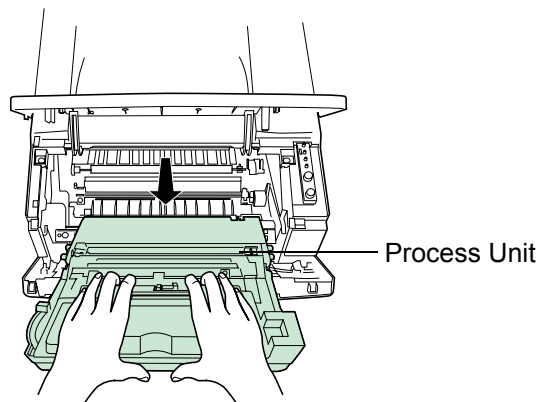

Figure 2-9



Note

Never stand the process unit on end.

NO

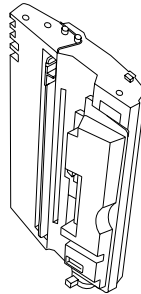

Figure 2-10

3 Use the supplied wiper cloth to clean dust and dirt away from the registration roller (metal).

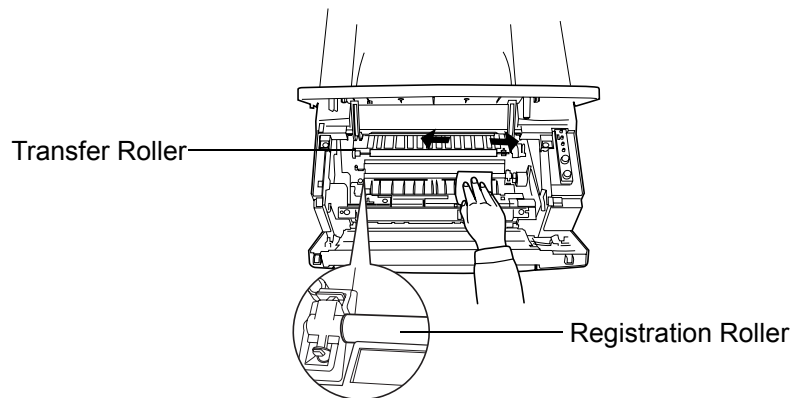

Figure 2-11



Note

While cleaning, be careful to avoid touching the transfer roller (the black roller).

- Slide the charger cleaner knob (green-colored) back and forth 2 to 3 times, then return it to its **CLEANER HOME POSITION** ↓.

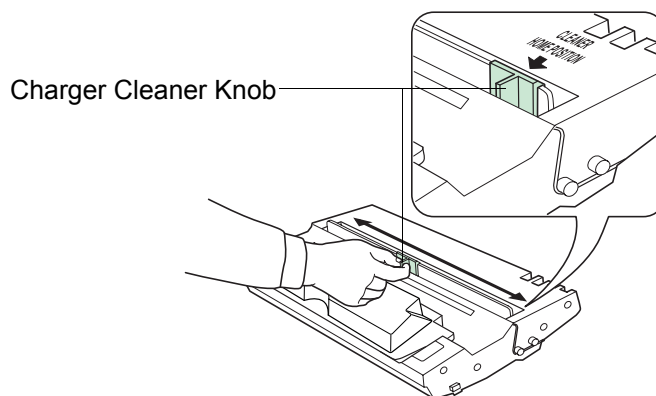

Figure 2-12

After cleaning, make sure you restore the charger cleaner to its home position.



Note

If the charger cleaner knob is not restored to its home position (marked **CLEANER HOME POSITION** ↓), a black band will print along the length of the page the next time you use the printer.

- After cleaning is done, put the process unit back in the printer. To do so, carefully align the guides at both ends of the process unit with the slots in the printer.

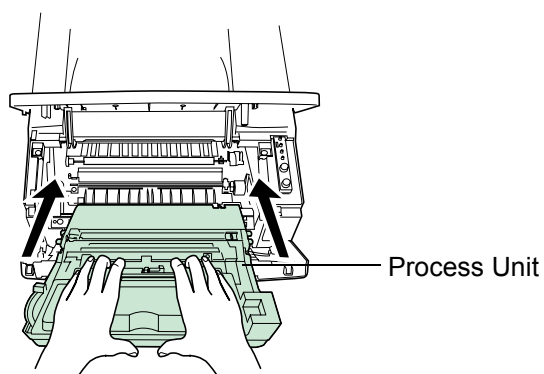

Figure 2-13

6 Close the front cover.

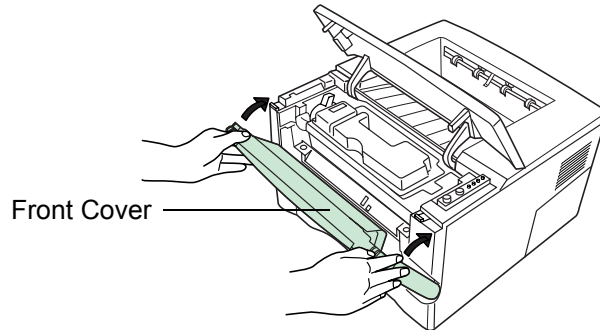

Figure 2-14

7 Close the top cover by pressing down on the front left and right corners of the top cover.

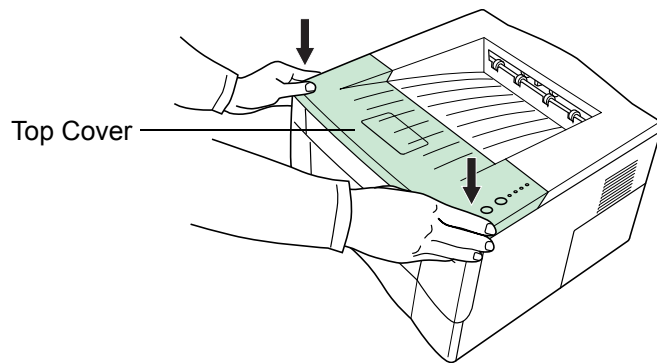

Figure 2-15

Chapter 3 **Troubleshooting**

This chapter explains how to handle printer problems that may occur. If a problem cannot be corrected, contact your Kyocera Mita dealer.

This chapter explains the following topics:

- **General Guide for Troubleshooting**
- **Print Quality Problems**
- **Indicators**
- **Paper Jam Removal**

3.1 General Guide for Troubleshooting

There are quite a few printer problems which may be corrected by the user. If some kind of printer problem should occur, check the following before concluding the printer is broken.

This section explains how to correct these problems.



Symptom	Check Items	Corrective Action	
The printer will not print from the computer.	Check the  indicator.	Off	Look through the items below and check anything that seems appropriate.
		Flashing	Rapid flashing: An error has occurred. For details on error warnings and remedies, see section 3.3 Indicators on page 3-6 . Flickering: The printer is offline. Pressing the  key switches the printer to online status.
		Lit	See the appropriate item below.
	Check if status page can be printed.	Status page can be printed.	There may be a problem with the computer's connection to the network. Also, look through the items below and check anything that seems relevant.
Print quality is not good.		See section 3.2 Print Quality Problems on page 3-3 .	
Paper is jammed.		See section 3.4 Paper Jam Removal on page 3-15 .	
Nothing lights on the operator panel even when power is turned on and the fan makes no noise.	Check that the power cord is properly plugged into the power outlet.	Turn off the printer's power, plug in the power cord securely, and try turning on the printer's power again.	
	Check that the power switch is really in the ON () position.		
The printer prints a status page, but data from the computer is not being printed normally.	Check the interface cable.	Connect both ends of the interface cable securely. Try replacing the printer cable. For details on the parallel interface for this printer, see Appendix B .	
	Check program files and application software.	Try printing another file or using another print command. If the problem occurs only with a specific file or application, check the printer settings for that application.	

Table 3-1

If you still cannot correct a printer problem even after checking the above, please contact your Kyocera Mita dealer.

3.2 Print Quality Problems

As the following table shows, there are many possible causes of print quality problems, such as blank output as. The troubleshooting procedure for each type of problem is explained below. If you still can not solve the problem, contact your Kyocera Mita dealer.



Printed Results	Corrective Action
<p>All-black printout</p> 	<p>Contact your Kyocera Mita dealer.</p>
<p>Dropouts, horizontal streaks, stray dots</p> 	<p>Clean the charger wire. Open the printer's top and front covers. Remove the process unit from the printer and slide the charger knob back and forth to clean the charger wire. (See Chapter 2)</p>
<p>Black or white vertical streaks</p> 	<p>Check the operator panel. When the  (toner) indicator flashes, install a new toner kit. Clean the printer after replacement. (See Chapter 2)</p> <p>Clean the charger wire. Open the printer's top and front covers. Remove the process unit from the printer and slide the charger knob back and forth to clean the charger wire. (See Chapter 2)</p> <p>Check the position of the charger cleaner knob. Open the printer's top and front covers. Remove the process unit from the printer. Make sure the charger cleaner knob is restored to its home position. (See Chapter 2)</p> <p>Change the corresponding custom paper type setting. When selecting the settings for the custom paper type under the Custom Paper Type Settings, be sure to select Normal 1 as the corresponding weight in the KM-NET for Clients. (See the KM-NET for Clients Operation Guide.)</p>

Table 3-2



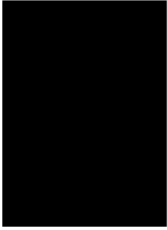
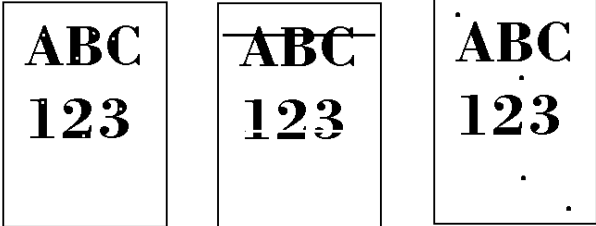
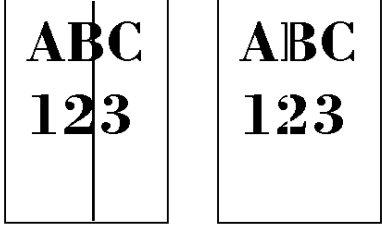

Printed Results	Corrective Action
<p>Faint or blurred printing</p> 	<p>Check the EcoPrint setting. When this setting is On, switch it to Off on the KM-NET for Clients. (See the <i>KM-NET for Clients Operation Guide</i>.)</p> <p>Confirm the  (toner) indicator. If the  (toner) indicator flashes, install a new toner kit. (See <i>Chapter 2</i>)</p> <p>Clean the charger wire. Open the printer's top and front covers. Remove the process unit from the printer and slide the charger knob back and forth to clean the charger wire. (See <i>Chapter 2</i>)</p> <p>Try setting the thin paper mode. Set the paper type to Thin in the KM-NET for Clients utility. (See the <i>KM-NET for Clients Operation Guide</i>.)</p> <p>If the toner is not being fixed well to the paper, adjust the corresponding custom paper type setting. When selecting the settings for the custom paper type under the Custom Paper Type Settings, be sure to select Normal 3 as the corresponding weight in the KM-NET for Clients. (See the <i>KM-NET for Clients Operation Guide</i>.)</p>
<p>Grey background.</p> 	<p>Check the operator panel. When the  (toner) indicator flashes, install a new toner kit. (See <i>Chapter 2</i>)</p> <p>Check the process unit. Open the printer's top and front covers, then check that the process unit is properly installed.</p>
<p>Dirt on the top edge or back of the paper</p> 	<p>Check the transfer roller. Open the printer's top and front covers. Remove the process unit from the printer and check whether the transfer roller is dirty. If so, print several pages to eliminate the dirt.</p> <p>Check the registration roller. Open the printer's top and front covers. Remove the process unit from the printer and check whether the registration roller is soiled with toner. If so, wipe it clean using the supplied wiper cloth.</p>

Table 3-2 (Continued)



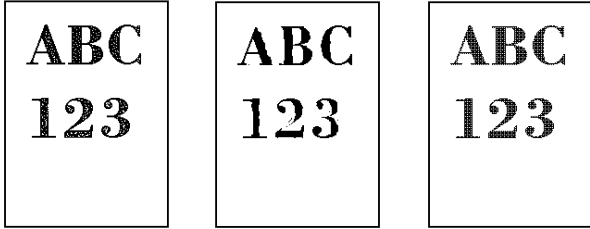

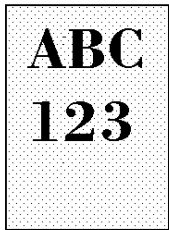
Printed Results	Corrective Action
<p>Characters out of position.</p> 	<p>Check the file or program. Check whether the problem is being caused by a PRESCRIBE command error. If the problem occurs only with a specific file or program, the most likely cause is an error in a parameter to a command or command syntax.</p> <p>Check the paper size setting. Check that the paper size set in the paper source and the paper size set on the KM-NET for Clients are the same. (See the <i>KM-NET for Clients Operation Guide</i>.)</p>

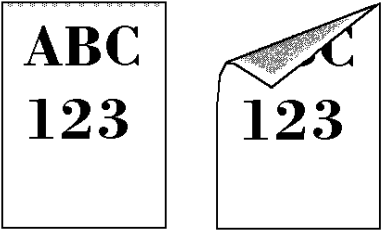
Table 3-2 (Continued)

3.3 Indicators

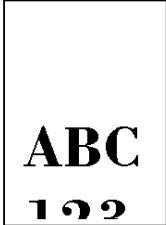
There are four indicators on the printer's operator panel. These light, flash, and turn off in combination to indicate the printer's current status. This section explains the indicators on the operator panel and the appropriate corrective action to take in each case.

Indicator displays can be classified into three categories: maintenance, errors, and normal. In the following table, indicators are shown to be lit, flashing, or off. Further, flashing is divided into two speeds, fast and slow.

	Lit
Red/Green	
	Fast Flashing
Red/Green	
	Slow flashing
Red/Green	
	Off
Grey	

By using the **KM-NET for Clients** utility, you can monitor the printer's status from the computer. When a printer error occurs, the error message is displayed on the computer's screen. The display for the **KM-NET for Clients** is described in the following tables.

3.3.1 Maintenance Messages

The following table lists error messages that can be dealt with by the user. Read the explanations carefully.







Indicator	KM-NET for Clients display	Corrective Action
	Add paper <paper source>	<p>The paper has run out. Add paper to the paper cassette (1 or 2) or MP tray. The paper source is displayed in the KM-NET for Clients.</p> <p>The paper cassette is not closed securely. Close the paper cassette properly.</p>
	Close top cover	<p>The top or front cover is open. Close the cover properly.</p>
	Load Cassette # <paper size><paper type>	<p>There is data for printing that matches with a paper cassette setting (paper size, paper type), but there is no paper in the paper cassette. Set paper of the size and type specified in the print data into the cassette (1 or 2) to resume printing. When you want to feed from a other paper source, press the  key to switch the paper source. The printer prints on the paper size and type set in that particular paper source.</p>
	Load MP tray <paper size><paper type>	<p>The cassette paper size and data paper size are not the same. The printer feeds from the MP Tray when the page in the paper cassette is a different size and type than that specified in the print data. Set paper of the size and type specified in the print data into the MP tray, then press the  key to resume printing. When you want to feed from a source other than the MP tray, make sure there is no paper in the MP tray, then press the  key to switch the paper source. The printer prints on the paper size set in that particular paper source.</p> <p> Feeding the paper having a paper size which does not match the current paper size from the MP tray can cause paper jam.</p> <p>Note</p>
	Paper jam #####	<p>Open the printer and clear the paper jam. The location of the paper jam is also indicated in place of #'s. For details on how to clear paper jams, see section 3.4 Paper Jam Removal on page 3-15.</p>

Table 3-3

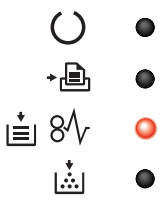
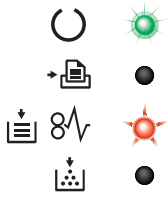

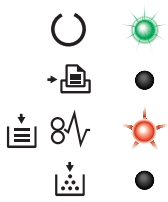

Indicator	KM-NET for Clients display	Corrective Action
	Paper path error	<p>There is no cassette in the feeder, or the cassette is not inserted properly. After reinserting the paper cassette, you should be able to print.</p>
	Replace toner	<p>There is no more toner in the toner container. The printer has stopped because there is no more toner. Replace with a new toner kit. After replacing, be sure to clean the printer. (See Chapter 2)</p>
	Set paper Press GO	<p>There is no paper in the MP tray. Add paper to the tray. Press the  key to resume printing.</p> <p> Feeding the paper having a paper size which does not match the current paper size from the MP tray can cause paper jam.</p> <p>Note</p>
	Toner low	<p>There is not enough toner inside the toner container. Promptly replace with a new toner as the printer will stop printing before long. Clean the printer after replacement. (See Chapter 2)</p>
(No indication patterns available)	Warning image adapt	<p>The print job cannot be done at current resolution because there is not enough internal memory. Try adding memory or changing resolution.</p>
(No indication patterns available)	Warning low memory	<p>The printer's memory is running low because of the number of downloaded fonts and macros. Print a status page to see how much user memory is left and try deleting unnecessary fonts and macros.</p>
	Warning waste toner box	<p>The waste toner reservoir is almost full. The waste toner reservoir will become full and the printer will stop printing. Contact your Kyocera Mita dealer.</p>

Table 3-3 (Continued)

3.3.2 Errors Requiring Service Personnel Attention

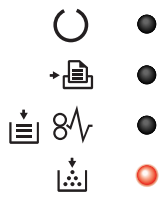
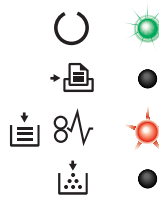
When the following errors occur, turn off your printer, remove the plug from the AC outlet, and contact your Kyocera Mita dealer. The indicators are shown in two different states, according to the way they alternate.

Indicator	Corrective Action
	<p>Main motor error (2000 error) Contact your Kyocera Mita dealer.</p>
	<p>Scanner motor error (4000 error) Contact your Kyocera Mita dealer.</p>
	<p>Scanner pin-photo error (4200 error) Contact your Kyocera Mita dealer.</p>
	<p>Eraser error (5300 error) Contact your Kyocera Mita dealer.</p>

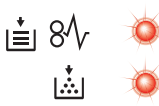
Table 3-4

Indicator	Corrective Action
	<p>Fuser error (6000 error) Contact your Kyocera Mita dealer.</p>
	<p>The waste toner reservoir is full (7980 error) Turn off the printer's power and remove the process unit from the printer. Gently shake the process unit horizontally a few times, then reinstall it into the printer. Turn on the printer's power. If this error message does not disappear, contact your Kyocera Mita dealer (less than 100,000 pages printing).</p>
	<p>The waste toner reservoir is full (7990 error) Same as above (100,000 pages printing or more).</p>
	<p>Controller check sum error (F010 error) Contact your Kyocera Mita dealer.</p>
	<p>Controller RAM read/write error (F020 error) Contact your Kyocera Mita dealer.</p>

Table 3-4 (Continued)

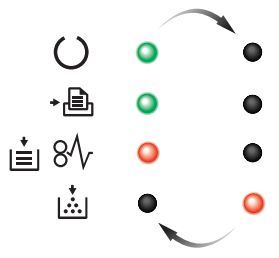
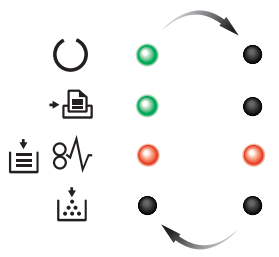
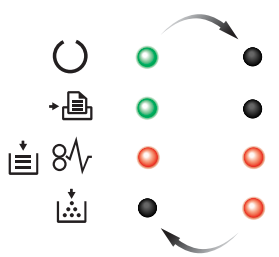
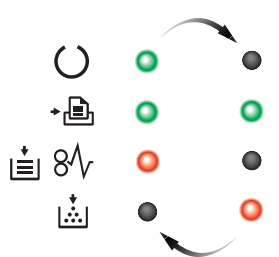

Indicator	Corrective Action
	<p>Controller system error (F030 error) Contact your Kyocera Mita dealer.</p>
	<p>Communication error (F040 error) Contact your Kyocera Mita dealer.</p>
	<p>Engine ROM check sum error (F050 error) Contact your Kyocera Mita dealer.</p>

Table 3-4 (Continued)

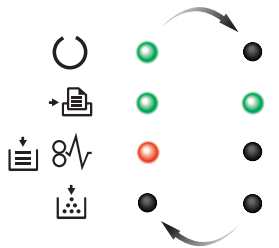
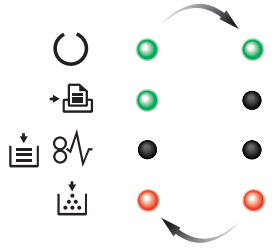
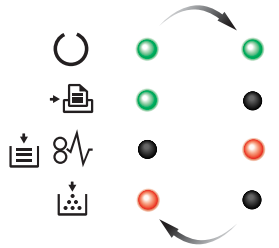
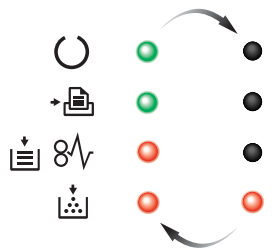
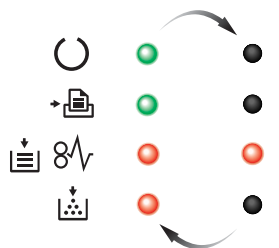
3.3.3 Error Messages

With the following errors, printing continues when you press the printer's  key. You can confirm these errors by printing a status page. (See pages 1-4 and 1-5.)

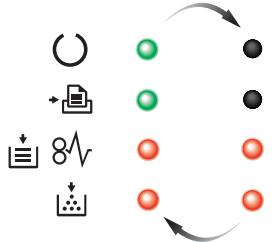
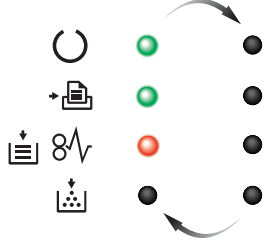
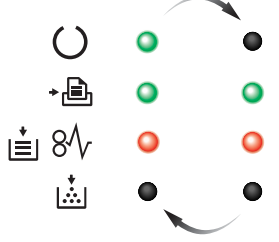









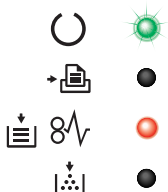

Indicator	KM-NET for Clients display	Corrective Action
	File not found Press GO	The specified file is not found. Press the  key to resume printing. You can abandon printing by pressing the  key.
	KPDL Error Press GO	Current print processing cannot continue. Press the  key to resume printing. You can abandon printing by pressing the  key.
	MemoryCard err## Press GO	An error has occurred during access to the memory card using the PRESCRIBE RWER command or from the KM-NET for Clients. Look at the error code given in place of ## and refer to the corresponding description given below. 04 :The capacity of the memory card is insufficient. Clean up files. 05 :Specified file not on memory card. 06 :No memory for use by memory card. Expand printer memory. Press the  key to resume printing. You can abandon printing by pressing the  key.
	Memory overflow Press GO	Printing cannot continue because there is not enough memory. Try adding more memory. Press the  key to resume printing. You can abandon printing by pressing the  key.
	Print overrun Press GO	Current print processing cannot continue due to complex data. The data transferred to the printer was too complex to print on a page. Press the  key to print data as far as it was stored. You can abandon printing by the  key.  To release the page protect mode, send the following command to the printer from the KM-NET for Clients after this error occurs: Note !R! FRPO R5, 1; EXIT;
	RAM DISK error ## Press GO	Check the error code displayed in ## and refer to the appropriate description below. 01: Abnormal format. Try turning the power off and on again. 02: RAM disk mode is Off. Turn RAM disk mode On. 04: No disk space. Clean up files. 05: Specified file is not on disk. 06: No memory for use by disk system. Expand printer memory.

Table 3-5



Indicator	KM-NET for Clients display	Corrective Action
	None	<p>The printer has halted because you attempted to insert/remove a memory card into/from the printer slot while the printer power is on. Turn the power switch off and then on to restart the printer.</p> <p> Make sure to turn the printer power off before inserting/removing a memory card.</p> <p>Note</p>
None	Format error Memory card	<p>This message appears when the printer is in the ready state and the memory card is not formatted, and therefore cannot be read or written. Format the memory card.</p>

Table 3-5 (Continued)

3.3.4 Normal Indicator Display

The following displays appear during normal printer operation.









Indicator	KM-NET for Clients display	Description
	Cancelling data	Data inside the printer is being canceled. The indicators light in sequence from the top, then go off in sequence from the bottom. This process is repeated twice. When the printer is switched on for the first time after the toner container is installed, (Adding toner) also appears.
	Please wait	The printer is warming up and is not ready to print. The indicators light in sequence twice from top to bottom. When the printer is switched on for the first time after the toner container is installed, (Adding toner) also appears.
	Processing	The printer is receiving data.
	Processing	The printer is processing data.
	Waiting	The printer is waiting for the end-of-job command before printing the last page. Pressing the  key allows you to obtain the last page immediately.
	Form Feed Timeout	The printer is printing the last page after a waiting period.
	Ready	The printer is ready to print.
		The printer is offline. The printer stores but does not print received data.
	Sleeping	The printer is in sleep mode. The  indicator flashes at 5-second intervals and all other indicators go off. The printer wakes from Sleep mode whenever a key on the operator panel is pressed, the cover is opened or closed, or data is received. The printer then warms up and goes online. (You can set the amount of time before the printer enters sleep mode from the KM-NET for Clients utility.)

Table 3-6

3.4 Paper Jam Removal

This section describes how to remove paper when it jams in the printer. The printer will stop whenever paper jams in the printer or paper is not fed from a paper cassette. The printer will go offline and  (paper jam) indicator will light in the operator panel. When a jam occurs, check the points indicated in the following and clear the jam as indicated.

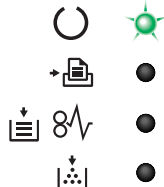
If paper jams occur frequently, try using a different type of paper, replace with paper from another ream, turn the stack of paper over, or turn the paper the other way around. Read the information in [Chapter 4](#). Also, look for tiny pieces of paper that may have been torn apart and overlooked when the jammed paper was removed.

If you cannot solve the problem by changing the paper, there may be a problem with the printer. Call a service person.



- **When pulling the paper, pull it gently so as not to tear it. Torn pieces of paper are difficult to remove and may be easily overlooked, deterring the jam recovery.**
- **Depending on where the jam occurred, the printer may or may not reprint the jammed page.**

3.4.1 Jam at the Face-down Tray and the Rear Cover

If paper is not completely ejected and has stopped only part way out, open the rear cover and remove the jammed paper by pulling it out. Open and close the printer's top cover to clear the error. The printer then automatically warms up and resumes printing.

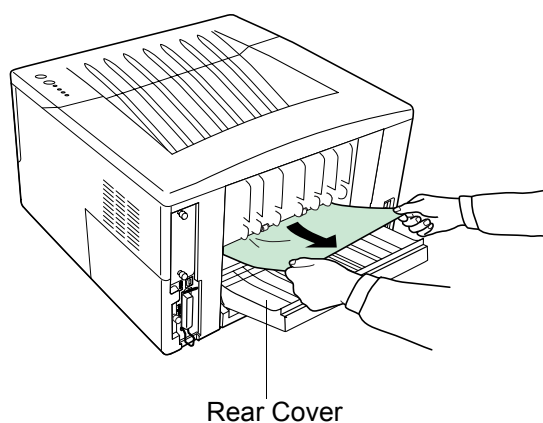

Figure 3-1

3.4.2 Jam at the Paper Cassette

Pull out the paper cassette and remove any partially fed paper, then re-close the paper cassette. Open and close the printer's top cover to clear the error. The printer then automatically warms up and resumes printing. Follow the same steps for clearing the jammed paper at the option paper feeder's paper cassette.

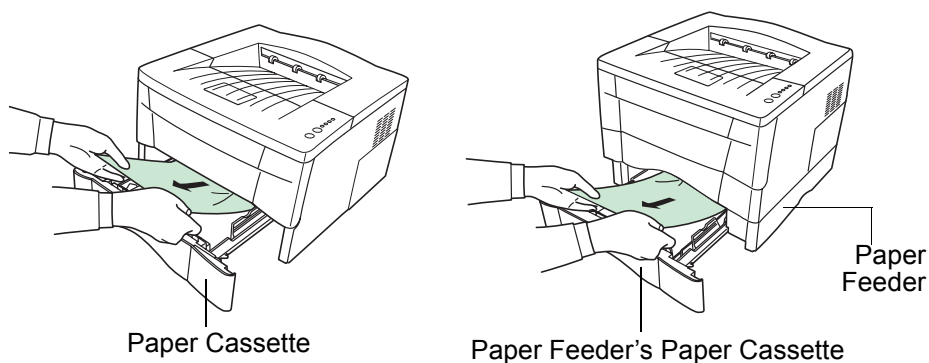

Figure 3-2

3.4.3 Jam at the Duplexer

When a paper jam occurs in the duplex section, clear it using the following procedure.

- 1 Open the rear cover and remove the jammed paper as shown in the figure.

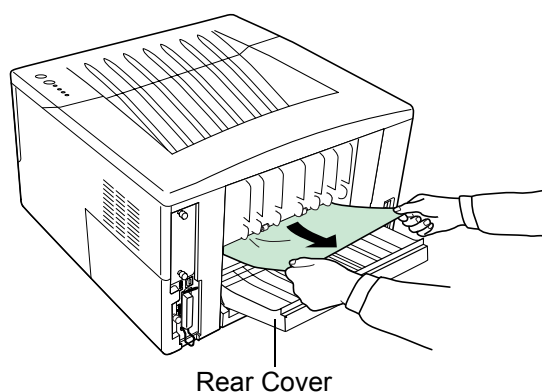

Figure 3-3

- 2** Pull the paper cassette all the way out of the printer.

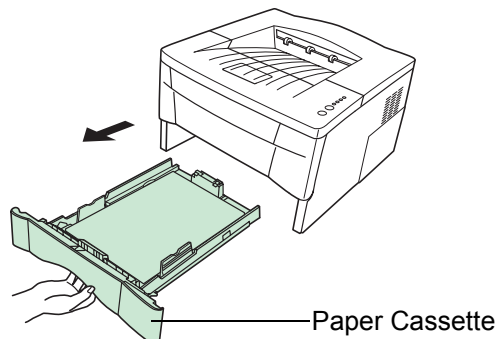

Figure 3-4

- 3** Open the duplexer's rear cover and remove any jammed paper.

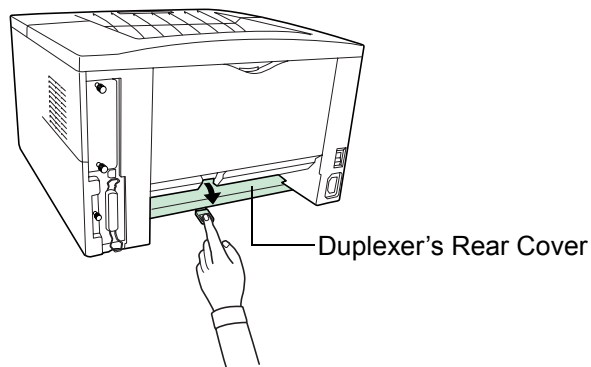

Figure 3-5

- 4** Open the duplexer's front cover and remove any jammed paper.

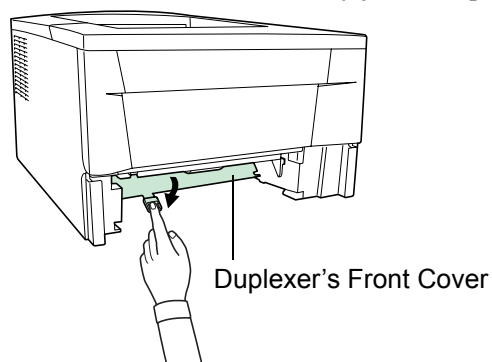

Figure 3-6

- 5** Insert the paper cassette into the slot in the printer.
- 6** Open and close the printer's top cover to clear the error. The printer then automatically warms up and resumes printing.

3.4.4 Jam Inside the Printer

When a paper jam occurs inside the printer, clear it using the following procedure.

- 1 Open the printer's top and front covers.

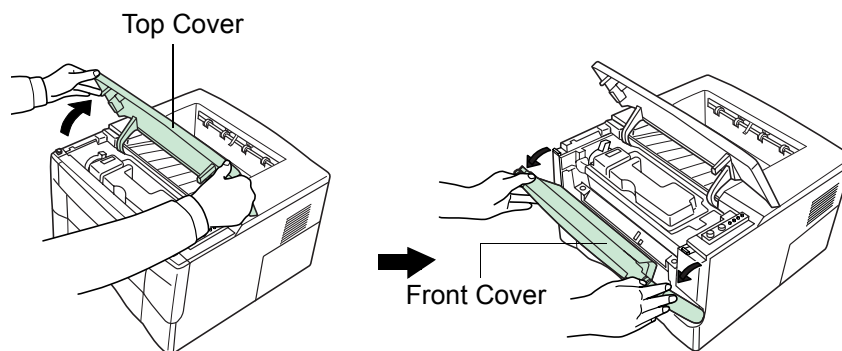

Figure 3-7

- 2 Remove the process unit from the printer as shown in the figure.

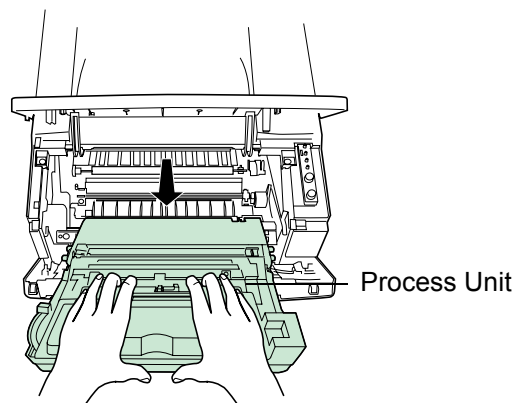

Figure 3-8

- 3 Remove the jammed paper from the printer as shown in the figure.

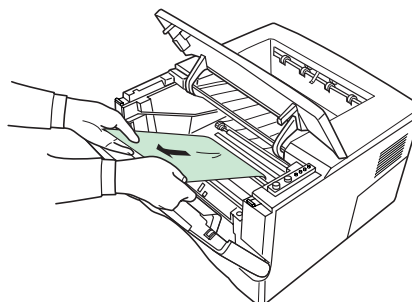

Figure 3-9



Note

When the jammed paper appears to be pinched by rollers, pull it along the normal paper running direction.

- 4 After you have removed the jammed paper, put the process unit back into the printer.
- 5 Close the printer's front cover and top cover. The printer then automatically warms up and resumes printing.

3.4.5 Jam at the MP Tray

When a paper jam occurs in the MP tray, clear it using the following procedure.

- 1 Leaving any paper that may be jammed there, remove the rest of the paper from the MP tray.

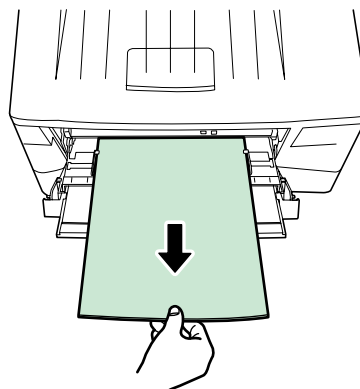

Figure 3-10



Note

Do not try to forcefully pull out paper that has already been fed partially in to the MP tray. Instead, proceed to the next step.

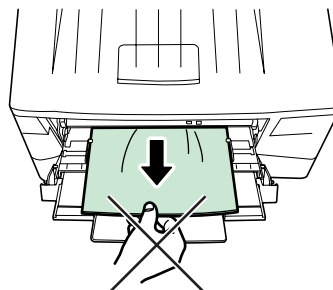

Figure 3-11

- 2** Open the printer's top and front covers.

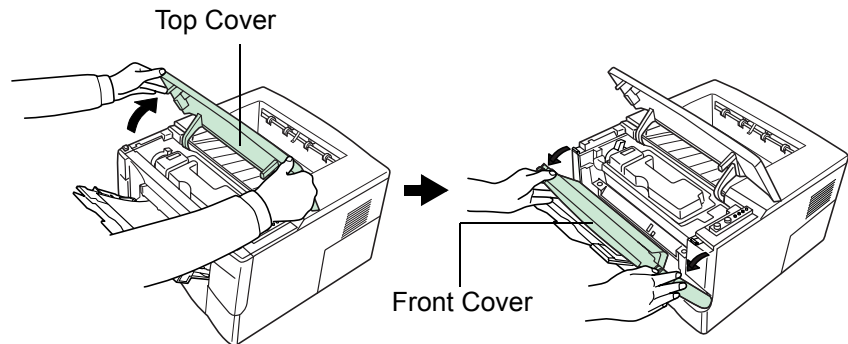

Figure 3-12

- 3** Remove the process unit from the printer as shown in the figure.

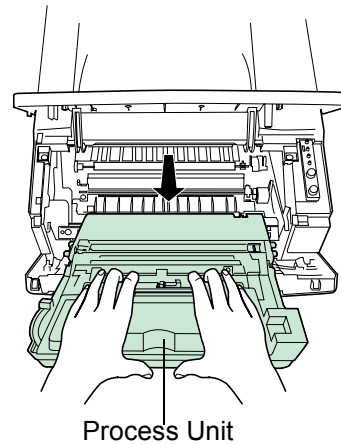

Figure 3-13

4 Use the following procedure that corresponds to the status of the jammed paper, in order to remove that paper.

(A) If the leading edge of the jammed paper has been fed further into the printer than the metal registration roller, remove the jammed paper by its leading edge.

(B) If the paper has not been fed as far as the metal registration roller, remove the jammed paper from the MP tray side.

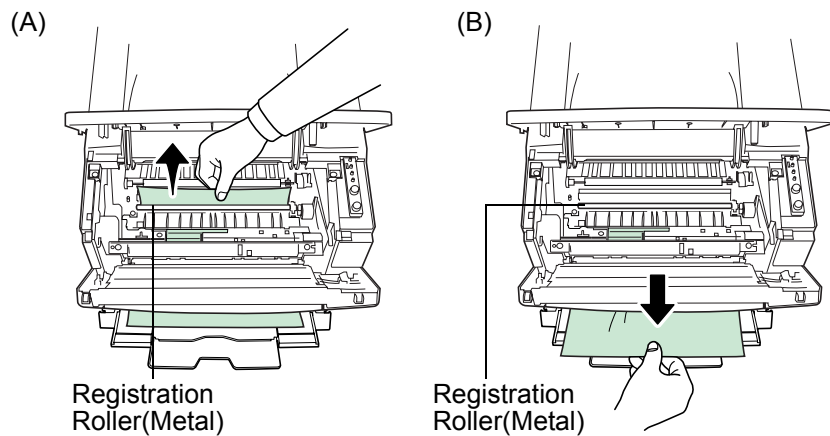

Figure 3-14

Chapter 4 **Paper Selection**

This chapter explains the following topics:

- **General Guidelines**
- **Selecting the Right Paper**
- **Special Paper**
- **Paper Type**

4.1 General Guidelines

The printer is designed to print on high-quality copier bond paper (the kind used in ordinary dry copier machines), but it can also accept a variety of other types of paper within the limits specified below.



Note

The manufacturer assumes no liability for problems that occur when paper not satisfying these requirements is used.

Selection of the right paper is important. Using the wrong paper can result in paper jams, misfeeding, curling, poor print quality, and paper waste, and in extreme cases can damage the printer. The guidelines given below will increase the productivity of your office by ensuring efficient, trouble-free printing and reducing wear and tear on the printer.

4.1.1 Paper Availability

Most types of paper are compatible with a variety of machines. Paper intended for xerographic copiers can also be used with the printer.

There are three general grades of paper: economy, standard, and premium. The most significant difference between grades is the ease with which they pass through the printer. This is affected by the smoothness, size, and moisture content of the paper, and the way in which the paper is cut. The higher the grade of paper you use, the less risk there will be of paper jams and other problems, and the higher the level of quality your printed output will reflect.

Differences between paper from different suppliers can also affect the printer's performance. A high-quality printer cannot produce high-quality results when the wrong paper is used. Low-priced paper is not economical in the long run if it causes printing problems.

Paper in each grade is available in a range of basis weights (defined later). The traditional standard weights are 16, 20, and 28 pounds (60 to 105 g/m²).

4.1.2 Paper Specifications

The following table summarizes the basic paper specifications. Details are given on the following pa

Item	Specification
Weight	Cassette : 60 to 105 g/m ² (16 to 28 lb/ream) MP tray : 60 to 163 g/m ² (16 to 43 lb/ream)
Thickness	0.086 to 0.110 mm (3.4 to 4.3 mils)
Dimensional accuracy	±0.7 mm (±0.0276 inches)
Squareness of corners	90° ±0.2°
Moisture content	4% to 6%
Direction of grain	Long grain
Pulp content	80% or more

Table 4-1

4.2 Selecting the Right Paper

Laser printing is a process involving laser light, electrostatic discharge, toner, and heat. In addition, as the paper passes through the printer it undergoes considerable sliding, bending, and twisting motions. A high-quality printing paper matching the printer's requirements withstands all these stresses, enabling the printer to turn out clean, crisp printed copies consistently.

Remember that all paper is not the same. Some of the factors to consider when selecting paper for the printer are as follows:

Condition of the Paper

Avoid using paper that is bent at the edges, curled, dirty, torn, embossed, or contaminated with lint, clay, or paper shreds.

Use of paper in these conditions can lead to illegible printing, misfeeding, and paper jams, and can shorten the life of the printer. In particular, avoid using paper with a surface coating or other surface treatment. The paper should have as smooth and even a surface as possible.

Composition

Do not use paper that has been coated or surface-treated and contains plastic or carbon. The heat of fusing can cause such paper to give off harmful fumes.

Bond paper should contain at least 80% pulp. Not more than 20% of the total paper content should consist of cotton or other fibers.

Paper Size

Cassettes and an MP tray are available for the paper sizes listed in [Table 4-2](#). The dimensional tolerances are ± 0.7 mm (± 0.0276 inches) for the length and width. The angle at the corners must be $90^\circ \pm 0.2^\circ$.

Multi-Purpose tray	Size	Cassette or multi-purpose tray	Size
Monarch	3-7/8 × 7-1/2 inches	Legal (Not available with the MP tray)	8-1/2 × 14 inches
Business	4-1/8 × 9-1/2 inches		
ISO DL	11 × 22 cm	Letter	8-1/2 × 11 inches
ISO C5	16.2 × 22.9 cm	ISO A4	210 × 297 mm
ISO B5	17.6 × 25 cm	ISO A5	148 × 210 mm
Executive	7-1/4 × 10-1/2 inches	JIS B5	182 × 257 mm
Commercial 9	3-7/8 × 8-7/8 inches	Custom	Cassette: 148 to 216 mm × 210 to 297 mm, and Legal (5-13/16 to 8-1/2 inches × 8-1/4 to 11-11/16 inches) MP tray: 70 to 216 mm × 148 to 297 mm (2-13/16 to 8-1/2 inches × 5-13/16 to 11-11/16 inches)
Commercial 6-3/4	3-5/8 × 6-1/2 inches		
ISO A6	105 × 148 mm		
JIS B6	128 × 182 mm		
Oficio II	8-1/2 × 13 inches		
16K	197 × 273 mm		
Statement	5-1/2 × 8-1/2 inches		
Folio	210 × 330 mm		
Hagaki	100 × 148 mm		
OufukuHagaki	148 × 200 mm		
Youkei 2	114 × 162 mm		
Youkei 4	105 × 235 mm		

Table 4-2

Smoothness

The paper should have a smooth, uncoated surface. Paper with a rough or sandy surface can cause voids in the printed output. Paper that is too smooth, however, can cause multiple feeding and fogging problems. (Fogging is a gray background effect.)

Basis Weight

Basis weight is the weight of a standard quantity of paper. In the traditional system the standard quantity is a ream consisting of 500 sheets measuring 17 × 22 inches each. In the metric system the standard quantity is 1 square meter.

Paper that is too light or too heavy can cause misfeeding, jams, and premature wear of the printer. Uneven paper weight can cause multiple feeds, print defects, poor toner fusing, blurring, and other print quality problems. The proper weight is 60 to 105 g/m² for the paper cassette, and 60 to 163 g/m² for the MP tray.

Thickness (Caliper)

Thick paper is referred to as high-caliper paper and thin paper as low-caliper paper. The paper used with the printer should be neither extremely thick nor extremely thin. If you are having problems with paper jams, multiple feeds, and faint printing, the paper you are using may be too thin. If you are having problems with paper jams and blurred printing the paper may be too thick. The proper thickness is 0.086 to 0.110 mm (3.4 to 4.3 mils).

Moisture Content

Moisture content is defined as the percent ratio of moisture to the dry mass of the paper. Moisture can affect the paper's appearance, feedability, curl, electrostatic properties, and toner fusing characteristics.

The moisture content of the paper varies with the relative humidity in the room. When the relative humidity is high and the paper absorbs moisture, the paper edges expand, becoming wavy in appearance. When the relative humidity is low and the paper loses moisture, the edges shrink and tighten, and print contrast may suffer.

Wavy or tight edges can cause misfeeding and alignment anomalies. The moisture content of the paper should be 4 to 6%.

To ensure the proper moisture content it is important to store the paper in a controlled environment. Some tips on moisture control are:

- Store paper in a cool, dry location.
- Keep the paper in its wrapping as long as possible. Rewrap paper that is not in use.
- Store paper in its original carton. Place a pallet etc. under the carton to separate it from the floor.
- After removing paper from storage, let it stand in the same room as the printer for 48 hours before use.
- Avoid leaving paper where it is exposed to heat, sunlight, or damp.

Paper Grain

When paper is manufactured, it is cut into sheets with the grain running parallel to the length (long grain) or parallel to the width (short grain). Short grain paper can cause feeding problems in the printer. All paper used in the printer should be long grain.

Other Paper Properties

Porosity: Refers to the density of the paper structure; that is, to how openly or compactly the fibers are bonded.

Stiffness: Limp paper can buckle inside the printer, while paper that is too stiff may bind. Either way the result is a paper jam.

Curl: Most paper has a natural tendency to curl in one direction. The paper should be loaded so that the natural curl is downward, to counteract the upward curl imparted by the printer. Printed sheets will then come out flat. Most paper also has a top and bottom surface. Loading instructions are usually given on the paper package.



If the paper is considerably curled in one direction, e.g. when the paper was used to print on one side, try to roll the paper in the opposite direction to counteract the curl. Printed sheets will then come out flat.

Electrostatic properties: During the printing process the paper is electrostatically charged to attract the toner. The paper must be able to release this charge so that printed sheets do not cling together in the output tray.

Whiteness: The contrast of the printed page depends on the whiteness of the paper. Whiter paper provides a sharper, brighter appearance.

Quality control: Uneven sheet size, corners that are not square, ragged edges, welded (uncut) sheets, and crushed edges and corners can cause the printer to malfunction in various ways. A quality paper supplier should take considerable care to ensure that these problems do not occur.

Packaging: Paper should be packed in a sturdy carton to protect it from damage during transport. Quality paper obtained from a reputable supplier is usually properly packaged.

4.3 Special Paper

The following types of special paper can be used:

- Transparency (overhead projection film)
- Adhesive-backed label paper
- Envelopes
- Colored paper
- Preprinted paper
- Recycled paper

Use paper that is sold specifically for use with copiers (heat-fusing type). Transparency, label paper, and envelopes should not be placed in the paper cassette; they must be fed from the MP tray and delivered in the face up stack.

Since the composition and quality of special paper vary considerably, special paper is more likely than white bond paper to give trouble during printing. No liability will be assumed if moisture and so forth given off during printing on special paper causes harm to the machine or operator.



Note

Before purchasing any type of special paper, test a sample on the printer and check that printing quality is satisfactory.

Specifications for each type of special paper are given below.

4.3.1 Transparency (overhead projection film)

Transparency must be able to withstand the heat of fusing during the printing process. It should satisfy the conditions in [Table 4-3](#).

Item	Specification
Tolerance of heat	Must tolerate at least 190°C (374°F)
Thickness	0.100 to 0.110 mm (3.9 to 4.3 mils)
Material	Polyester
Dimensional accuracy	±0.7 mm (±0.0276 in)
Squareness of corners	90° ± 0.2°

Table 4-3

If transparency jams frequently, pull the top of the sheet very gently as it leaves the printer.

4.3.2 Adhesive-Backed Labels

The basic rule for printing on adhesive labels is that the adhesive must never come into contact with any part of the printer. Adhesive paper sticking to the drum or rollers will damage the printer.

Label paper must be manually fed.

Label paper has a structure comprising of three layers, as shown in [Table 4-4](#) on page 4-8. The top sheet is printed on. The adhesive layer consists of pressure-sensitive adhesives. The carrier sheet (also called the linear or backing sheet) holds the labels until use. Due to the complexity of its composition, adhesive-backed label paper is particularly likely to give trouble in printing.

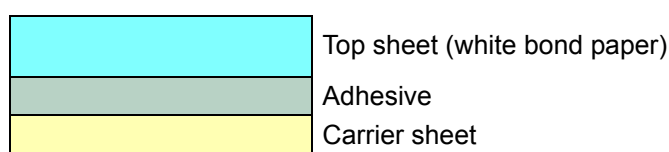

Figure 4-1

Adhesive label paper must be entirely covered by its top sheet, with no spaces between the individual labels. Labels with spaces in between are apt to peel off, causing serious paper jam problems.

Some label paper is manufactured with an extra margin of top sheet around the edge. Do not remove the extra top sheet from the carrier sheet until after printing is finished.

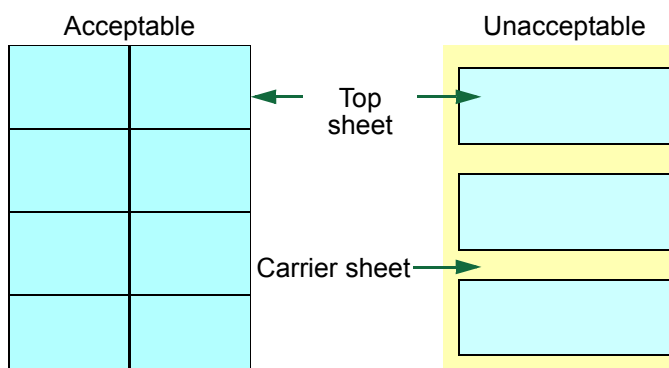

Figure 4-2

[Table 4-4](#) lists the specifications for adhesive label paper.

Item	Specification
Weight of top sheet	44 to 74 g/m ² (12 to 20 lb/ream)
Composite weight	104 to 151 g/m ² (28 to 40 lb/ream)
Thickness of top sheet	0.086 to 0.107 mm (3.9 to 4.2 mils)
Composite thickness	0.115 to 0.145 mm (4.5 to 5.7 mils)
Moisture content	4 to 6% (composite)

Table 4-4

Postcards

Fan the stack of postcards and align the edges before loading them in the MP tray. Make sure the postcards you are going to set are not curled. Feeding curled postcards may cause paper jams.

Some postcards have rough edges on the back (those are created when the paper is cut). In this case, put the postcards on a flat place and rub the edges with, for example, a ruler to smooth them.

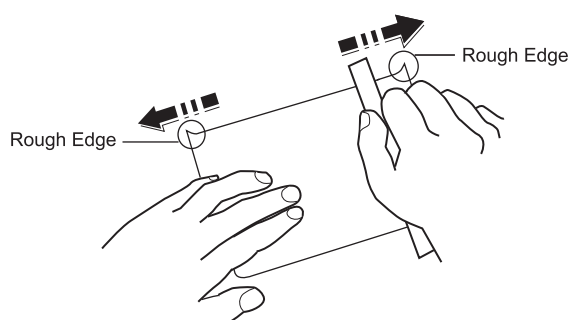

Figure 4-3

Envelopes

The printer can print on envelopes using paper with a basis weight of 60 to 79 g/m² (16 to 21 lb/ream). Envelopes must be manually fed.

An envelope is a more complex object than a single sheet of paper. For this reason, it may not be possible to obtain consistent printing quality over the entire envelope surface.

Many envelopes have a diagonal grain orientation. (See [Paper Grain](#) on page 4-5.) This orientation is more likely to wrinkle and crease on its way through the printer. Before purchasing envelopes for use with the printer, test a sample to verify the envelope's suitability.

Do not use envelopes that have an encapsulated liquid adhesive.

Avoid long printing runs consisting of envelopes only. Extensive envelope printing can cause premature printer wear.

To avoid jamming due to curled envelopes, do not leave more than approximately 10 printed envelopes stacked in the paper trays during multiple envelope printing.

Thick Paper

Fan the stack of paper and align the edges before loading them in the MP tray. Some types of paper have rough edges on the back (those are created when the paper is cut). In this case, put the paper on a flat place and rub the edges once or twice with, for example, a ruler to smooth them in the same way as described in *Postcards* on page 4-9. Feeding rough edged paper may cause paper jams.



Note

If the paper jams even after you smooth it out in such a way, set the paper in the MP tray with the leading edge raised up a few millimeters as shown in the illustration.

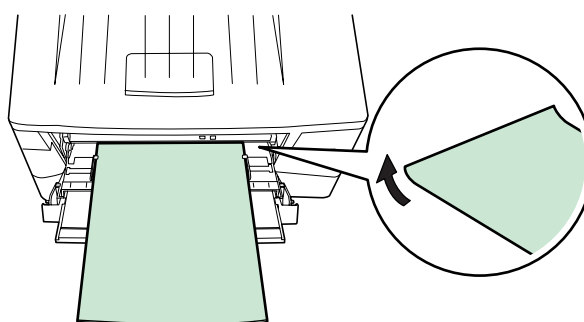

Figure 4-4

Colored Paper

Colored paper should satisfy the same conditions as white bond paper, listed in *Table 4-1* on page 4-2. In addition, the pigments used in the paper must be able to withstand the heat of fusing during the printing process (up to 200°C or 392°F).

Preprinted Paper

Preprinted paper should have a bond paper base. The preprinted ink must be able to withstand the heat of fusing during the printing process, and must not be affected by silicone oil.

Do not use paper with any kind of surface treatment, such as the type of paper commonly used for calendars.

Recycled Paper

Select recycled paper that meets the same specifications as the white bond paper (see *Table 4-1* on page 4-2.) except whiteness.



Note

Before purchasing recycled paper, test a sample on the printer and check that the printing quality is satisfactory.

4.4 Paper Type

The printer is capable of printing under the optimum setting for the type of paper being used.

Setting the paper type for the paper source by using the **KM-NET for Clients** utility will cause the printer to automatically select the paper source and print in the mode best suited to that type of paper.

A different paper type setting can be made for each paper source including the MP tray. Not only can preset paper types be selected, but it is also possible for you to define and select customized paper types. See the [KM-NET for Clients Operation Guide](#).

Not all paper types are available to feed from the paper cassette. Certain types of paper should be fed using the MP tray. See the table below.

Paper Source Paper Type	MP Tray	Paper Cassette	Paper Weight
Plain	Yes	Yes	Normal 2
Transparency	Yes	No	Extra heavy
Preprinted	Yes	Yes	Normal 2
Labels	Yes	No	Normal 2
Bond	Yes	Yes	Normal 2
Recycled	Yes	Yes	Normal 2
Vellum	Yes	No	Light
Rough	Yes	Yes	Heavy 1
Letterhead	Yes	Yes	Heavy 1
Color	Yes	Yes	Heavy 2
Prepunched	Yes	Yes	Heavy 1
Envelope	Yes	No	Heavy 3
Cardstock	Yes	No	Heavy 2
Thick	Yes	No	Heavy 2
Custom 1 (to 8) [†]	Yes	Yes	Normal 2

Yes : Can be stored No : Cannot be stored

Table 4-5

[†] This is a paper type defined and registered by the user. Up to eight types of user settings may be defined. For details, see the [KM-NET for Clients Operation Guide](#).

Chapter 5 **Fonts**

This chapter describes the types of fonts installed with the printer.

- **Internal Fonts**
- **List of Fonts**

5.1 Internal Fonts

A font is a set of characters of a particular design. The design is referred to as a typeface. Several characteristics identify a font. These include the code set (for details on code sets, please read the *Technical Reference* provided on the CD-ROM supplied with the printer), spacing, pitch, height, style, stroke weight, and typeface family.

The printer has 80 PCL/PS compatible fonts and 1 bitmap font. Fonts may also be downloaded to the printer's memory. These are referred to as downloadable or soft fonts. The printer accepts as many downloadable fonts as its user available memory permits.

5.2 List of Fonts

This section contains a full list of the printer's internal fonts.

5.2.1 Internal Scalable and Bitmap Fonts and KPDL Fonts

Font number	Font samples
0	This is a sample of Courier font.
1	This is a sample of CGTimes font.
2	This is a sample of CGTimes-Bd font.
3	<i>This is a sample of CGTimes-It font.</i>
4	<i>This is a sample of CGTimes-BdIt font.</i>
5	This is a sample of CGOmega font.
6	This is a sample of CGOmega-Bd font.
7	<i>This is a sample of CGOmega-It font.</i>
8	<i>This is a sample of CGOmega-BdIt font.</i>
9	<i>This is a sample of Coronet font.</i>
10	This is a sample of Clarendon-Cd font.
11	This is a sample of Univers-Md font.
12	This is a sample of Univers-Bd font.
13	<i>This is a sample of Univers-MdIt font.</i>
14	<i>This is a sample of Univers-BdIt font.</i>
15	This is a sample of Univers-MdCd font.
16	This is a sample of Univers-BdCd font.
17	<i>This is a sample of Univers-MdCdIt font.</i>
18	<i>This is a sample of Univers-BdCdIt font.</i>
19	This is a sample of AntiqueOlive font.
20	This is a sample of AntiqueOlive-Bd font.
21	<i>This is a sample of AntiqueOlive-It font.</i>
22	This is a sample of GaramondAntiqua font.
23	This is a sample of Garamond-Hlb font.
24	<i>This is a sample of Garamond-Krsv font.</i>
25	<i>This is a sample of Garamond-HlbKrsv font.</i>
26	<i>This is a sample of Marigold font.</i>
27	This is a sample of Albertus-Md font.
28	This is a sample of Albertus-ExBd font.
29	This is a sample of Arial font.
30	This is a sample of Arial-Bd font.

Font number	Font samples
70	This is a sample of Courier-Bd font.
71	<i>This is a sample of Courier-It font.</i>
72	<i>This is a sample of Courier-BdIt font.</i>
73	This is a sample of LetterGothic font.
74	This is a sample of LetterGothic-Bd font.
75	<i>This is a sample of LetterGothic-It font.</i>
76	This is a sample of CourierPS font.
77	This is a sample of CourierPS-Bd font.
78	<i>This is a sample of CourierPS-Ob font.</i>
79	<i>This is a sample of CourierPS-BdOb font.</i>
80	This is a sample of LinePrinterBM8.5-Roman font.

Font

KPD L Fonts (1)

This is a sample of Albertus-ExtraBold font.

This is a sample of Albertus-Medium font.

This is a sample of AntiqueOlive font.

This is a sample of AntiqueOlive-Bold font.

This is a sample of AntiqueOlive-Italic font.

This is a sample of Arial font.

This is a sample of Arial-Bold font.

This is a sample of Arial-BoldItalic font.

This is a sample of Arial-Italic font.

This is a sample of AvantGarde-Book font.

This is a sample of AvantGarde-BookOblique font.

This is a sample of AvantGarde-Demi font.

This is a sample of AvantGarde-DemiOblique font.

This is a sample of Bookman-Demi font.

This is a sample of Bookman-DemiItalic font.

This is a sample of Bookman-Light font.

This is a sample of Bookman-LightItalic font.

This is a sample of CGOmega font.

This is a sample of CGOmega-Bold font.

This is a sample of CGOmega-BoldItalic font.

This is a sample of CGOmega-Italic font.

This is a sample of CGTimes font.

This is a sample of CGTimes-Bold font.

This is a sample of CGTimes-BoldItalic font.

This is a sample of CGTimes-Italic font.

This is a sample of Clarendon-Condensed-Bold font.

This is a sample of Coronet font.

This is a sample of Courier font.

This is a sample of Courier-Bold font.

This is a sample of Courier-BoldOblique font.

This is a sample of Courier-Oblique font.

This is a sample of CourierPCL font.

This is a sample of CourierPCL-Bd font.

This is a sample of CourierPCL-BoldItalic font.

This is a sample of CourierPCL-Italic font.

This is a sample of Garamond-Antiqua font.

This is a sample of Garamond-Halbfett font.

This is a sample of Garamond-Kursiv font.

This is a sample of Garamond-KursivHalbfett font.

Appendix A Options

This appendix explains available options, how to expand the printer's memory, and also how to install the memory card and the network interface card.

- **Available Options**
- **Expansion Memory Installation**
- **Memory (CompactFlash) Card**
- **Network Interface Card**

A.1 Available Options

The following options are available for the printer:



Note

Either the network interface card or the serial interface board can be installed in the printer.

PF-17 Paper Feeder

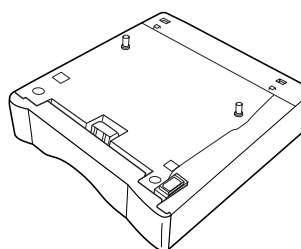

Figure A-1

IB-11 Serial Interface Board Kit

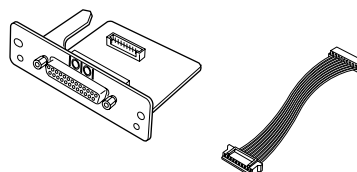

Figure A-2

IB-20/21E/22 Network Interface Card

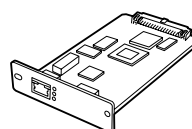

Figure A-3

Memory (CompactFlash) Card

Contact your Kyocera Mita dealer for information on purchasing the memory card that is best suited for use with this printer.

A.2 Expansion Memory Installation

This appendix begins by explaining how to install a DIMM (dual in-line memory module) on the main circuit board.

The FS-1020D comes supplied with 16 MB of memory installed. A slot is provided for expanding the memory in your printer so that more complex printing can be done, as well as increasing the printing speed. By installing optional DIMM into your printer, the memory in the FS-1020D can be increased to a maximum of 272 MB.



Note

- The expansion memory should be installed only by a Kyocera Mita authorized dealer or Kyocera Mita certified technician. Kyocera Mita shall not be liable for damage due to improper installation of the expansion memory.
- The following instructions are intended for the technician only.

Notes on Handling the Main Circuit Board and DIMM

Protect the electronics by taking these precautions:

- Before touching a DIMM, touch a water pipe or other large metal object to discharge yourself of static electricity. While doing the work, it is recommended that you wear an antistatic wrist strap.
- Touch the main circuit board and DIMM only by the edges.

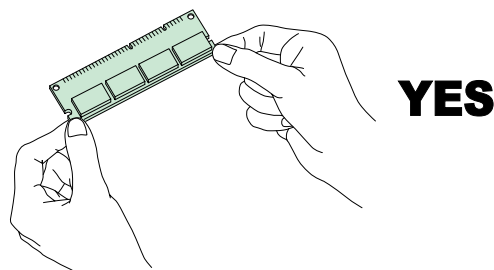

Figure A-4

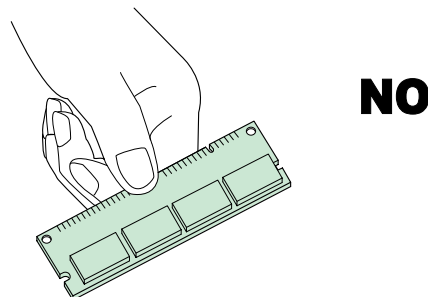

Figure A-5

DIMM to be used

Contact your Kyocera Mita dealer for information on purchasing the DIMM that are best suited for use with this printer.

Either an 8 MB, 16 MB, 32 MB, 64 MB, 128 MB, or 256 MB DIMM can be used for memory expansion.

Installing the DIMM

Insert the DIMM into the socket as follows:

- 1** Turn the printer's power off, then unplug the printer's power cable and disconnect the printer from the host computer.
- 2** Remove the screw from the rear of the printer.

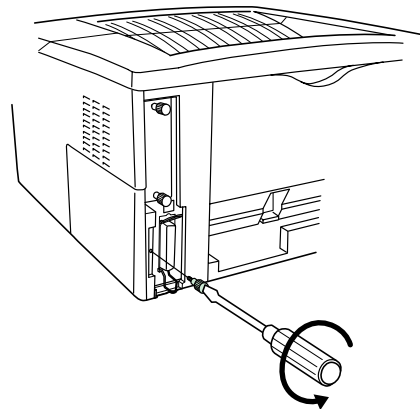

Figure A-6

- 3** Remove the side cover as shown in the figure.

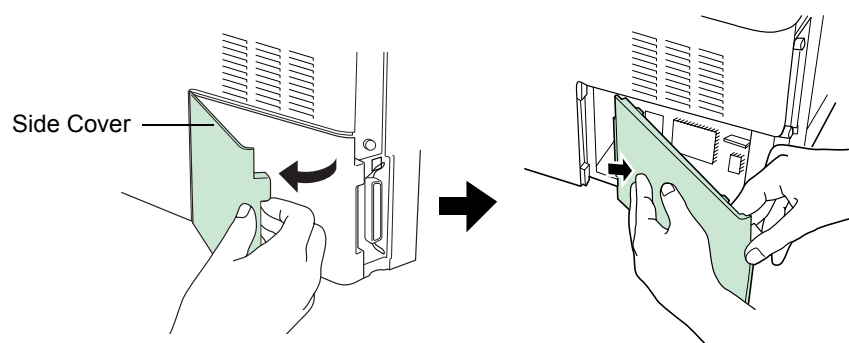

Figure A-7

After removing the side cover, you can see the DIMM socket on top of the main circuit board.

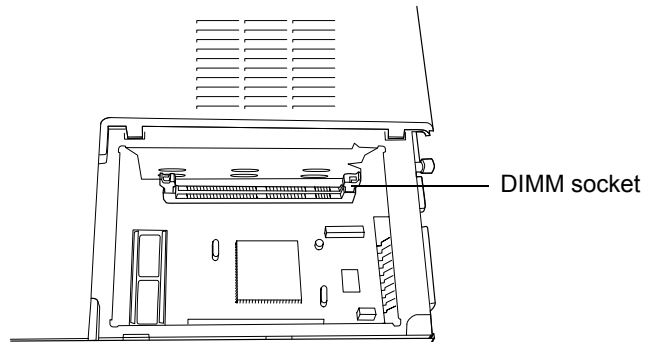

Figure A-8

- 4** Remove the DIMM from its package.
- 5** Open the clips on both ends of the DIMM socket.

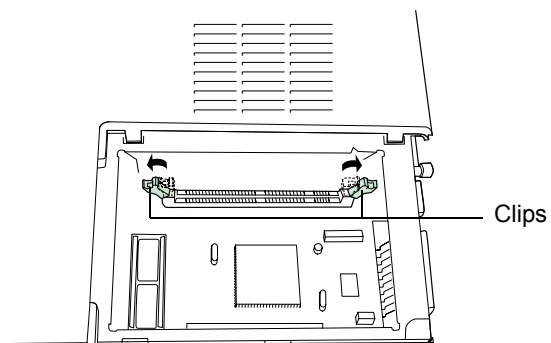

Figure A-9

- 6** Insert the DIMM into the DIMM socket so that the notches on the DIMM align with the corresponding protrusions in the slot.

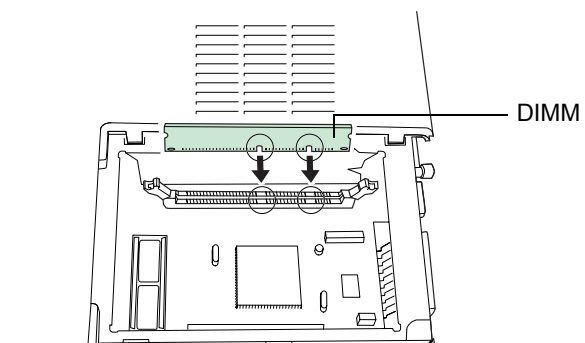

Figure A-10

- 7 Close the clips on the DIMM slot to secure the DIMM.

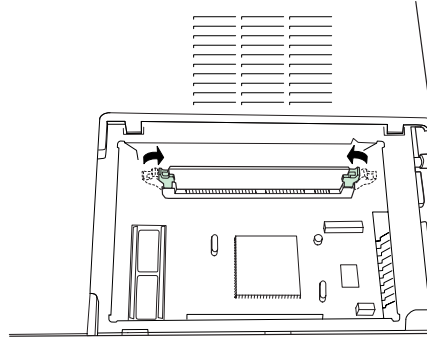

Figure A-11

- 8 When you have finished installing the DIMM, replace the side cover and fasten it with the screw.

To remove a DIMM:

Remove the side cover as shown in steps 1 to 3 on page [A-4](#), then carefully pull the end clips outwards and pull the DIMM out of the socket.

Testing the Expansion Memory

After you have finished installing DIMM in the printer, test the printer to see if installation succeeded.

To test the expansion memory, proceed as follows:

- 1 Make sure the power switch is off. Plug the power cord into the printer and turn on the power.
- 2 When the printer is online, press and hold the  key for 3 seconds or more.
- 3 If the installation succeeded, the amount of memory shown on the status page will correspond with the amount of expansion memory. (The factory installed memory size is 16 MB.)

Setting the Printer Driver

After you install the additional memory to the printer, follow the instructions below to set the printer driver so that the printer can use the memories efficiently.

1 Click the Windows **Start** button, and then click **Printers and Faxes**.

2 Right click the **Kyocera Mita FS-1020D KX** icon, and click **Properties**.

The **Properties** dialog box will open. Click the **Device Settings** tab.

3 Enter the total memory size installed to the printer (up to 272 MB) in the **Memory** box.

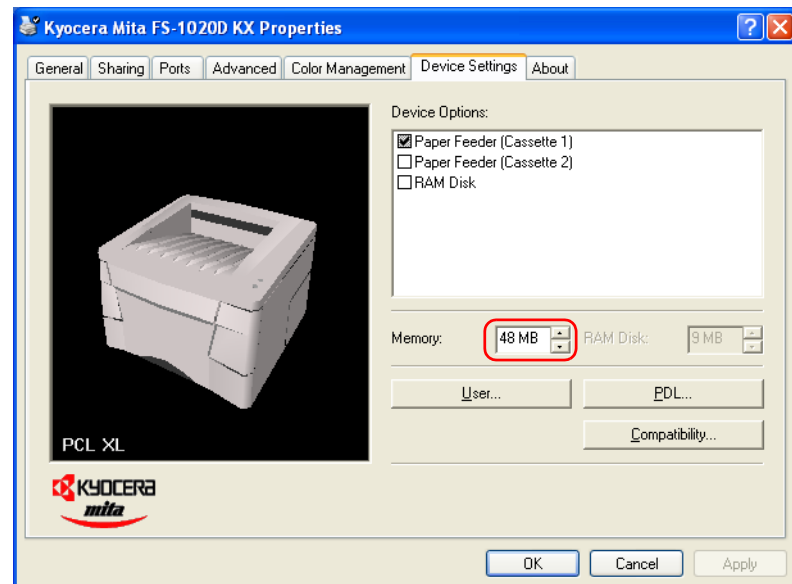

A.3 Memory (CompactFlash) Card

Insert the memory (CF) card into the card slot located on the rear of the printer. A memory card is a microchip card that may contain option fonts, macros, forms, etc. The printer reads the contents of the card into its internal memory when printer is turned on. The presence of this data in the printer memory can be confirmed on the status page printout.

For details of available memory cards, contact your Kyocera Mita dealer.

- 1 Turn off the printer.



Note

Never insert or remove a memory card while the printer power is on. Failure to turn the power switch off will immediately halt the printer with the four indicators turned on. It also could result in damage to the printer's electronic parts or the memory card. Turn the power switch on again to restart the printer.

- 2 Remove the two screws from the option interface slot cover and remove the slot cover.

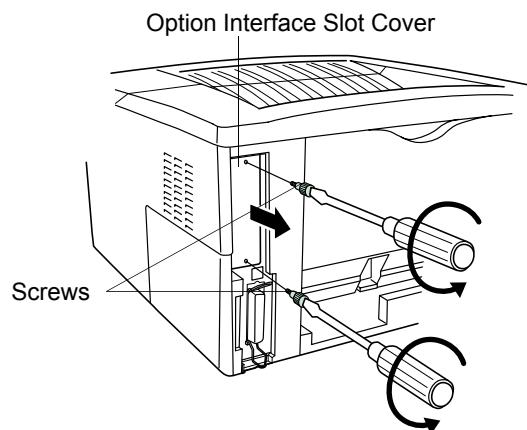

Figure A-12

If the Network Interface Card or the Serial Interface Board is installed

Remove the two screws from the network interface card or the serial interface board and remove it.

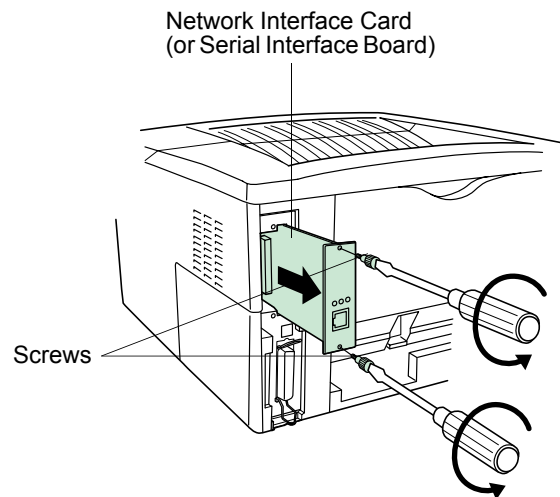

Figure A-13

- 3** Insert the memory card in the slot. Insert as shown in the figure. Push it in all the way.

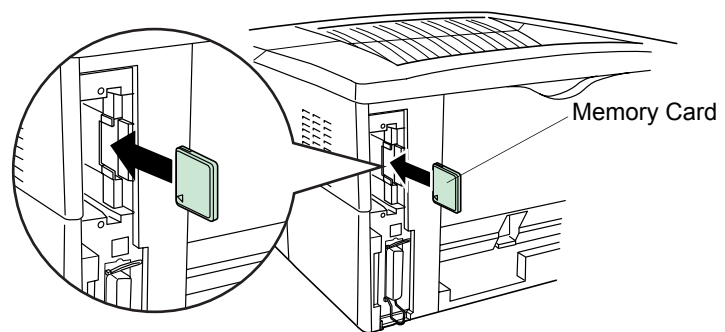

Figure A-14

- 4** Close and secure the slot cover. If the network interface card or the serial interface board kit is removed in the step 2 above, reinstall and secure the card or the kit.

A.4 Network Interface Card



Note

If the serial interface board kit is installed, remove it to use the network interface card.

Insert the option network interface card into the option interface slot at the rear of the printer. The network interface card enables the printer to be used in a network.

- 1 Turn off the printer and disconnect the power cord and printer cable.
- 2 Remove the two screws from the option interface slot cover and remove the slot cover.

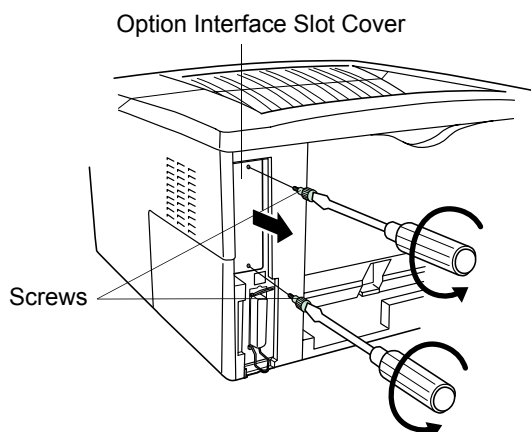

Figure A-15

- 3 Insert the network interface card and secure it with the screws removed in step 2.

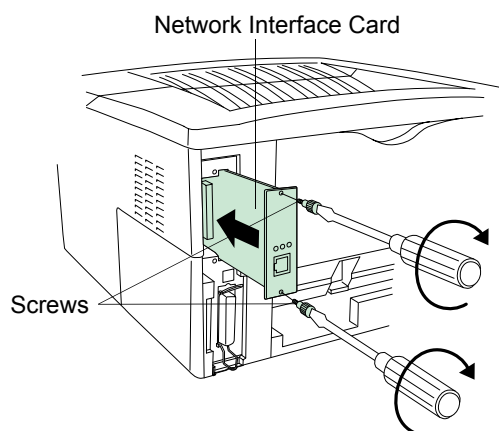

Figure A-16

Appendix B **Host Computer Interface**

This appendix describes the signals used in the laser printer's parallel, USB, and serial (option) interfaces. It also lists pin assignments, signal functions, timings, connector specifications, and voltage levels. For details on the network interface, refer to the IB-21E/IB-22 User's Manual contained on the CD-ROM that is supplied with the printer.

This appendix explains the following topics:

- **Parallel Interface**
- **USB Interface**
- **Serial Interface (Option)**
- **RS-232C Protocol**

B.1 Parallel Interface

B.1.1 Parallel Interface Communication Modes

The printer features fast data transmission on the parallel interface. The parallel interface mode can be activated from the **KM-NET for Clients** utility contained on the **Kyocera Mita Software Library** CD-ROM supplied with the printer as follows:



Note

Use a parallel printer cable that complies with the IEEE1284 standard.

Auto [default]

The printer automatically changes its communication mode to the one the host computer is currently using. Ordinarily, you should leave this setting unchanged.

Nibble (high)

High speed data communication is used in compliance with the IEEE 1284 standard.

Normal

The printer uses the standard communication method prescribed for Centronics interfaces.

High-speed

This mode enables faster data transmission between the printer and the host computer. (Select this mode if printing problems occur when the printer is connected to a workstation.)

B.1.2 Interface Signals

The pins of the parallel interface connector carry the signals listed in **Table B-1**. Asterisks in the table indicate signals that are active low. The table also indicates whether each signal is incoming or outgoing with respect to the printer.

Pin	In/out	Description
1	In	Strobe* [nStrobe]
2	In	Data 0 [Data 1]
3	In	Data 1 [Data 2]
4	In	Data 2 [Data 3]
5	In	Data 3 [Data 4]
6	In	Data 4 [Data 5]
7	In	Data 5 [Data 6]
8	In	Data 6 [Data 7]
9	In	Data 7 [Data 8]
10	Out	Acknowledge* [nAck]
11	Out	Busy [Busy]
12	Out	Paper Empty [PErrror]
13	Out	Online (Select) [Select]
14	In	Ignored [nAutoFd]
15	-	Not connected
16	-	0V DC
17	-	Chassis GND
18	-	+5V DC
19	-	Ground return
20	-	Ground return
21	-	Ground return
22	-	Ground return
23	-	Ground return
24	-	Ground return
25	-	Ground return
26	-	Ground return
27	-	Ground return
28	-	Ground return
29	-	Ground return
30	-	Ground return
31	In	Reset [nInit]
32	Out	Error*, returns error status if FRPO O2=2 [nFault]
33	-	-
34	-	Not connected
35	Out	Power Ready
36	In	Select In [nSelectIn]

Table B-1

[*]: Signal names in the Auto mode and Nibble (high) mode (IEEE 1284). In the Auto mode and Nibble (high) mode, these signals are bi-directional.

Detailed descriptions of the signals follow.

Strobe* [nStrobe] (Pin 1)

A negative-going Strobe* pulse causes the printer to read and latch the data on the Data 0 [1] to Data 7 [8] signal lines.

Data 0 [1] to Data 7 [8] (Pins 2 to 9)

These eight signals form the data byte sent from the host computer to the printer. Data 7 [8] is the most significant bit.

Acknowledge* [nAck] (Pin 10)

This negative-going pulse acknowledges the previous character received by the printer.

Busy [Busy] (Pin 11)

This signal is high when the printer is busy and low when it is able to accept more data.

Paper Empty [PError] (Pin 12)

This signal goes high when the printer runs out of paper.

Online [Select] (Pin 13)

This signal is high when the printer is online and low when the printer is offline. It goes low when the upper unit is raised, or when the  key is pressed to set the printer offline.

+5V DC (pin 18)

This line is connected to the printer's +5V DC line (+5 V \pm 0.5 V, maximum 400 mA, fused.)

Reset [nInit] (Pin 31)

This signal is used in the standard Centronics interface to enable the computer to reset the printer.

Error* [nFault] (Pin 32)

When the high-speed parallel line control is on (FRPO O2=2), this line returns error status.

Auxiliary output 1 (Pin 33)

This signal line is not used.

Power Ready (Pin 35)

This signal is high when the printer's power is on.

Select In [nSelectIn] (Pin 36)

This signal is used in some versions of the Centronics interface to enable the computer to force the printer online.



Note

The Paper Empty, Online, and Error signals are not used unless enabled by the FRPO command (O2 parameter).

B.2 USB Interface

This printer supports the Full-Speed USB (Universal Serial Bus) 2.0. USB interface specifications and interface signals are as follows.

B.2.1 Specifications

Basic specification

Complies with the Full-Speed USB 2.0.

Connectors

Printer: B-type receptacle (female) with upstream port

Cable: B-type plug (male)

Cable

Use shielded cable that complies with the Full-Speed USB 2.0 standards and not longer than 5 meters (16 feet).

Transfer Mode

Full speed (max. 12 Mbps)

Power Control

Self-power device

B.2.2 Interface Signals

Pin	Signal	Description
1	Vbus	Power supply (+5 V)
2	D-	Data transmission
3	D+	Data transmission
4	GND	Signal ground
Shell		Shield

Table B-2

B.3 Serial Interface (Option)

Installing the optional serial interface board kit (IB-11) in the printer enables connection to a computer with an RS-232C standard serial interface.

B.3.1 RS-232C Interface

Interface Signals

The pins of the printer's RS-232C interface connector carry the signals listed in *Table B-3*. The table also indicates whether each signal is incoming or outgoing with respect to the printer.

Pin	In/out	Signal	Description
1	-	FG	Frame ground
2	Out	TXD	Transmit Data
3	In	RXD	Receive Data
4	Out	RTS	Request To Send
5	In	CTS	Clear To Send
6	In	DSR	Data Set Ready
7	-	SG	Signal Ground
20	Out	DTR	Data Terminal Ready

Table B-3

Brief descriptions of the signals follow.

FG - Frame Ground - (Pin 1)

This pin is connected directly to the printer frame.

TXD - Transmit Data - (Pin 2)

This output carries asynchronous data sent by the printer to the computer. It is used mainly in handshaking protocols.

RXD - Receive Data - (Pin 3)

This input carries serial asynchronous data sent by the computer to the printer.

RTS - Request To Send - (Pin 4)

This output is always held high (above 3 volts).

CTS - Clear To Send - (Pin 5)

DSR - Data Set Ready - (Pin 6)

Unused.

SG - Signal Ground - (Pin 7)

All signals can transmit between the printer and the host computer to send each signal with a signal ground.

DTR - Data Terminal Ready - (Pin 20)

This output is used as a buffer nearly-full handshake line. It is held high (above 3 volts) when the buffer can accept more data.

RS-232C Interface Voltage Levels

The voltage levels of the interface signals conform to EIA RS-232C specifications. SPACE is from 3 volts to 15 volts. MARK is from -3 volts to -15 volts. Voltages between -3 volts and 3 volts are undefined.

B.4 RS-232C Protocol

A protocol is a set of rules the computer follows in sending data to the printer. The RS-232C parameters are stored in battery backed-up memory. They are indicated on the status printout. They can be changed by the FRPO (firmware reprogram) command described in the *Technical Reference* provided on the CD-ROM supplied with the printer. The parameters and their identification codes are given below.

H1: Baud rate

Parameter value	Baud rate
12	1200
24	2400
48	4800
96	9600
19	19200
38	38400
57	57600
11	115200

The factory setting is 9600 baud.

H2: Data bits

7 or 8, factory-set to 8.

H3: Stop bits

1 or 2, factory-set to 1.

H4: Parity

Parameter value	Meaning
0	None
1	Odd
2	Even
3	Ignore

The factory setting is None (0 on the status printout).

H5: Protocol logic

Parameter value	Meaning
0	Combination of 1 and 3 below
1	DTR/DSR, positive logic
2	DTR/DSR, negative logic
3	XON/XOFF
4	ETX/ACK
5	XON/XOFF recognized only as protocol

The factory setting is **0**.

H6: Buffer nearly-full threshold

This is a percentage from 0 to 99. The factory setting is 90.

H7: Buffer nearly-empty threshold

This is a percentage from 0 to 99. The factory setting is 70.

The factory settings of the buffer nearly-full and nearly-empty thresholds (H6 and H7) are subject to change without notification.

The gap between the nearly-full and nearly-empty thresholds allows the computer to send a fairly large amount of data in a continuous stream.

H8: Received-data buffer size

This is the size of the input buffer, specified in units of 10 Kbytes. The factory-set value is 6, meaning 60 Kbytes.

B.4.1 PRESCRIBE FRPO D0 Command

The PRESCRIBE FRPO D0 command provides control over XON/XOFF operation when an error occurs on the serial interface. The following table summarizes the error status corresponding to different D0 values.

		Serial interface error	
		Error not handled	Error handled
Timing of XON transfer to host while Ready or Waiting	XON sent every 3-5 seconds	D0=0 (default)	D0=1
	XON not sent	D0=10	D0=11

Table B-4

B.5 RS-232C Cable Connection

B.5.1 Obtain a Suitable RS-232C Cable

Make sure that the RS-232C cable is wired correctly. The cable must be a null modem cable; that is, one in which pin 2 on either end of the cable is connected to pin 3 on the other end. You cannot use a straight cable such as IBM communication adapter cable type 1502067 unless you purchase a null modem adapter.

B.5.2 Connecting the Printer to the Computer

Check that the power of both the printer and the computer is switched off.

- 1** Discharge yourself of static electricity by touching a metal object such as a doorknob.
- 2** Remove the plastic cap from the printer's RS-232C interface connector.
- 3** Plug the printer end of the RS-232C interface cable into the printer's RS-232C connector and screw it in place.
- 4** Plug the other end of the cable into the computer's RS-232C interface connector.
- 5** Switch on the printer's power.
- 6** The printer's RS-232C parameters are factory-set to the following values:

Baud rate=9600 bps, data bits (character length)=8 bits, stop bits=1, parity=none

The two RS-232C protocols are XON/XOFF and DTR. The printer performs both of them simultaneously, using positive logic for DTR.

If you are uncertain as to the printer's current parameter settings, you can reset them to the values listed above. See the *[KM-NET for Clients Operation Guide](#)*.
- 7** Set the computer to the same parameters as the printer. On many computers this can be done by setting DIP switches before the power is turned on. Another method is as follows:

With Windows XP, proceed as follows:

- 1 Click on the **Start** button in the Windows XP task bar and align the cursor with **Settings**, then click on **Control Panel** from among the items displayed.
- 2 The **Control Panel** window opens. Double click on **System**.
- 3 **System Properties** window opens. Click on the Hardware tab, then click on the **Device Manager** button, and double click on **Ports (COM & LPT)**.

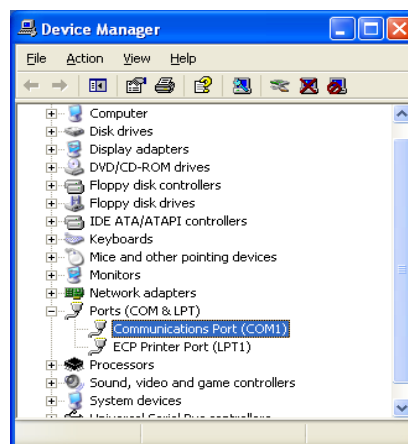

- 4 Double click on **Communications Port**.
- 5 The **Communications Port Properties** dialog is displayed for the selected COM port. Click on the **Port Settings** tab and set the port properties.

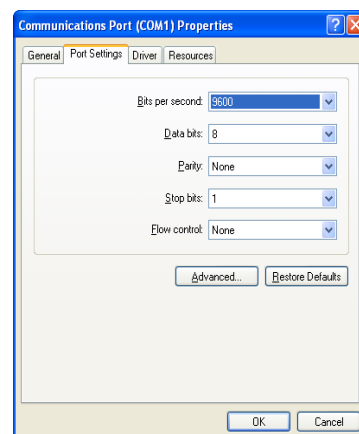

- 6 After setting the properties, click the **OK** button.

In DOS, enter the following commands:

```
C:\>MODE COM1:96,N,8,1,P
```

```
C:\>MODE LPT1:=COM1
```

To test the interface, enter the following:

```
CTRL P
```

```
C:\>DIR
```

```
CTRL P
```

The software settings made using the above procedures are temporary. On most computers, permanent settings must be made with DIP switches.

Appendix C Printer Specifications

C.1 Printer Specifications

Item	Description
Printing method	Electrophotography, laser scan
Printing speed	Simplex printing : 20 pages/minute (A4 size/Plain) 21 pages/minute (Letter size/Plain) Duplex printing : 10 pages/minute (A4/Letter size/Plain) When printing multiple copies of the same page
Resolution	Fast 1200 mode 600 dpi (vertical and horizontal) with KIR (Kyocera Image Refinement) 300 dpi (vertical and horizontal) with KIR (Kyocera Image Refinement)
First print	Approx. 10 seconds or less (A4 or letter size), depends on input data
Warm-up time	Approx. 15 seconds or less (from power on) at 23°C, 120 or 220 V
Controller	PowerPC 405 266 MHz
Main memory	16 MB, expandable up to 272 MB
Self test	Performed at power-up
Maximum duty cycle	15,000 pages/month
Drum	Organic Photoconductor
Developer	Mono-component dry developer
Main charger	Positive scorotron charger
Transferring	Negative charger roller
Separation	Curvature separation
Drum cleaning	Blade cleaner
Drum discharging	Illumination by eraser LED array
Fuser	Heat roller and pressure roller
Toner saving	EcoPrint mode
Paper	Plain paper (See Chapter 3)
Waste toner capacity	More than 100,000 pages (with 5% print coverage)
Paper feed trays	Cassette: Legal, Oficio II, Folio and A5 to A4/letter size universal cassette [148 to 216 mm (5-13/16 to 8-1/2") × 210 to 297 mm (8-1/4 to 11-11/16")]. Holds 250 sheets of thickness 0.11 mm MP tray: 70 to 216 mm (2-4/5 to 8-1/2") × 148 to 297 mm (5-13/16 to 11-11/16") (see page 4-4). Holds 50 sheets of thickness 0.11 mm. Duplex printing is only available for A4 or Letter, or Legal size paper.
Capacity of output trays	Face-down tray: 250 sheets of thickness 0.11 mm

Table C-1

Item	Description
Ambient conditions	Temperature: 10 to 32.5°C Humidity: 20 to 80% RH Optimum conditions: 23°C (73.4°F), 60% RH Altitude: Max. 2000 m (6500 feet) Illumination: Max. 1500 lux
Power requirements	110 V, 60 Hz, max. 6.5 A 120 V, 60 Hz, max. 7.1 A 220 to 240 V, 50 Hz/60 Hz, max. 3.8 A Max. allowable voltage fluctuation: ±10% Max. allowable frequency fluctuation: ±2%
Power consumption	Max.: 714 W (110 V), 819 W (120 V), 809 W (220 to 240 V) During sleep mode: 4.4 W (110 V, 60 Hz) 4.5 W (120 V, 60 Hz) 4.3 W (220 to 240 V, 50 Hz/60 Hz)
Operating noise (in accordance with ISO 7779 [Bystander Position, sound pressure level at the front])	During printing: LpA=53 dB (A) During standby: LpA=28 dB (A) During sleep mode: Immeasurably low
Dimensions	378 (14-7/8) wide × 235 (9-1/4) high × 375 mm (14-3/4") deep (Excl. the paper tray)
Weight	10.5 kg (23-1/8 lbs)

Table C-1 (Continued)

Glossary

Cassette mode

This is an operation mode for the MP tray. When this mode is used, approximately 50 sheets of plain paper can be fed continuously, the same as for the cassette.

dpi (dots per inch)

This indicates the number of dots printed per inch, and is the unit of printer resolution.

EcoPrint

This is a printing mode that controls toner consumption. Pages printed in the EcoPrint mode are lighter than pages printed in the normal mode. The default setting is Off.

Emulation

This refers to emulation of manufacturers' printers. The printer emulates operation of the following printers: PCL, Line printer, IBM Proprinter, DIABLO 630, EPSON LQ-850, KPDL.

Expansion memory

This option is used to increase printer memory. The printer has one expansion slot, and you can install a 8 MB, 16 MB, 32 MB, 64 MB, 128 MB, or 256 MB DIMM (Dual Inline Memory Module). Contact your Kyocera Mita dealer to purchase the DIMM that is best suited for use with this printer.

First mode

This is an operation mode for the MP tray. Because the MP tray default setting is set to first mode (priority printing from the MP tray), if there is paper inserted in the MP tray, the first paper will always feed from there even if another paper source is selected. First mode is specified as the factory default, but you can change this setting from the **KM-NET for Clients**.

IEEE1284

This is a standard used when connecting a printer to a computer, and was established by the Institute of Electrical and Electronic Engineers in 1994.

KIR (Kyocera Image Refinement)

This is Kyocera Mita's original smoothing function. It uses software to enhance the printer's resolution and produce high-quality printing. The default setting is On.

KM-NET for Clients

This is a utility that displays a virtual printer operation panel on your computer screen. You can make various settings from the **KM-NET for Clients**, such as the current paper source and paper size. The **KM-NET for Clients** is contained on the **Kyocera Mita Software Library** CD-ROM supplied with the printer.

KM-NET VIEWER

This is a network management tool that can be used with the printer. You can view information for printers connected to the network using SNMP commands. **KM-NET VIEWER** is contained on the **Kyocera Mita Software Library** CD-ROM supplied with the printer.

KPDL (Kyocera Printer Description Language)

This is Kyocera Mita's version of Adobe PostScript 3.

MB (mega byte)

This unit is used to express data quantities and memory capacities. 1 MB is equivalent to 1024 KB, or 1,048,576 bytes.

MP tray

This is an abbreviation for Multi-Purpose tray. The MP tray is used instead of the cassette when printing on envelopes, postcards, transparency sheets, and labels.

Offline

The printer can receive data, but cannot print. Turn the printer online if you want to print.

Online

The printer can output received data.

Operator panel

This is located on the top right side of the printer. The panel consists of four indicators and two keys. The four indicators light, flash, and go off in combination to indicate the printer's status. Press the keys when you want to switch the printer between online and offline status, or to cancel printing.

Outline font

With outline fonts, characters outlines are represented by numerical expressions, and fonts can be enlarged, reduced, or painted in different ways by changing the numeric values of those expressions. Printing remains clear even if you enlarge fonts, since the letters are defined by an outline. You can specify font size in steps of 0.25 points up to 999.75 points.

Parallel interface

With this interface, data transfer between the printer and the computer takes place on 8-bit chunks. The printer can perform IEEE1284 compatible bi-directional communications.

PRESCRIBE commands

This is the Kyocera Mita page printer control language installed on Kyocera Mita printers. PRESCRIBE commands enable most print settings necessary for pagination, and are easy to understand because they are written in text format, allowing you to do programming yourself. For information on the commands and how to use them, refer to the *Command Reference and Technical Reference* contained on the CD-ROM supplied with the printer.

Printer driver

The printer driver makes it possible for you to print data created using application software. The printer driver for the printer is contained on the **Kyocera Mita Software Library** CD-ROM supplied with the printer. Install the printer driver on the computer connected to the printer.

Process unit

This is the printer's main module and contains the photosensitive drum and developer unit.

RAM disk

This is a virtual disk drive that uses part of the printer's memory. With RAM disk you can set any memory size arbitrarily, and use electronic sorting (to reduce print time).

Simple Network Management Protocol (SNMP)

This is a protocol for the management of networks that use TCP/IP (Transmission Control Protocol/Internet Protocol).

Sleep mode

This mode is activated after a specified amount of time elapses. The printer goes into economy mode and a minimum amount of power is consumed. You can change the amount of time before the printer goes into sleep mode from the **KM-NET for Clients**. The default setting is 5 minutes.

Status page

This lists printer conditions, such as the printer's memory, the total number of copies printed, and paper source settings. You can print the status page by pressing the  key for 3 seconds or more.

USB (Universal Serial Bus)

An interface standard for low to middle speed serial interfaces. This printer supports Full-Speed USB 2.0. The maximum transfer rate is 12 Mbps and the maximum cable length is 5 meters (16 feet).

Index

A

Adhesive label 4-8

C

Charger wire 3-3, 3-4
 Cleaner home position 2-8
 Cleaning 2-6
 CompactFlash card A-8

D

DIMM
 installing A-4
 removing A-6
 socket A-5
 test A-6
 Downloadable font 5-2

E

EcoPrint *Glossary-2*
 Emulation *Glossary-2*
 Envelope 4-9
 Error messages 3-9, 3-12
 Expansion memory A-3,
 Glossary-2

F

Feed selection 1-5
 Font
 characteristics 5-2
 definition 5-2
 identifying 5-3
 Font list 5-3
 Front cover 2-6

I

IB-11 A-2, B-7
 Indicators 1-3, 3-6
 Interface B-1, B-2
 Internal font 5-2

K

Keys 1-3
 KIR 1-6, *Glossary-2*

KM-NET VIEWER *Glossary-2*
 KPDL *Glossary-2*
 Kyocera Mita Document Library
 viii

L

Label 4-8
 Lock lever 2-3

M

Main circuit board A-5
 Maintenance messages 3-7
 Memory card A-2, A-8
 Memory expansion A-3,
 Glossary-2
 MP tray *Glossary-3*
 cassette mode *Glossary-2*
 first mode *Glossary-2*

N

Network A-2
 Network interface card A-2, A-10

O

Online/Offline 1-3, *Glossary-3*
 Operator panel 1-2, *Glossary-3*
 Options A-2

P

Paper
 adhesive label 4-8
 colored paper 4-10
 condition 4-3
 envelope 4-9
 grain 4-5
 preprinted paper 4-10
 recycled paper 4-10
 selection 4-1
 size 4-4
 special paper 4-7
 specifications 4-2
 thick paper 4-10
 thickness 4-5
 transparency 4-7
 type 4-11
 weight 4-4

Paper cassette 3-7, 3-16
 Paper feeder (PF-17) A-2
 Paper jam 3-7, 3-15
 Paper size 4-4
 Paper type 4-11
 Parallel interface B-2,
 Glossary-3
 communication modes B-2
 transmission mode B-2
 Power requirements C-3
 PRESCRIBE command *viii*,
 B-10, *Glossary-3*
 Print quality 3-3
 Printer driver A-7, *Glossary-3*
 Process unit 2-6, *Glossary-3*
 charger wire 3-3, 3-4
 cleaner home position 2-8
 Protocol B-9

R

RAM disk *Glossary-3*
 Ready indicator 1-3
 Recycled paper 4-10
 Registration roller 2-7, 3-4
 RS-232C B-7, B-9, B-11

S

Serial interface B-7
 protocol B-9
 RS-232C mode B-7
 Serial Interface Board Kit
 (IB-11) A-2, B-7
 Side cover A-4
 Simple Network Management
 Protocol (SNMP) *Glossary-3*
 Sleep mode *Glossary-2*,
 Glossary-4
 Specifications C-1, C-2
 Status page 1-3, 1-4, *Glossary-4*

T

Toner counter 2-5
 Toner kit (TK-18) 2-2
 installing 2-3
 plastic bag 2-3
 protective seal 2-4
 replacement 2-3, 3-8
 toner container 2-2

wiper cloth 2-7
Top cover 2-3, 3-7
Transfer roller 2-7, 3-4
Transparency 4-7
Troubleshooting
 error messages 3-12
 guidelines 3-2
 indicators 3-6
 interface 3-2
 maintenance messages 3-7
 quality problems 3-3
Typeface 5-2

U

USB interface B-6, *Glossary-4*

W

Windows B-12

KYOCERA MITA EUROPE B.V.

Hoeksteen 40, 2132 MS Hoofddorp,
The Netherlands
Phone: +31.(0)20.654.000
Home page: <http://www.kyoceramita-europe.com>
Email: info@kyoceramita-europe.com

KYOCERA MITA NEDERLAND B.V.

Hoeksteen 40 2132 MS Hoofddorp
The Netherlands
Phone: +31.(0)20.587.7200

KYOCERA MITA (UK) LTD.

8 Beacontree Plaza
Gillette Way,
Reading Berks RG2 0BS, UK
Phone: +44.(0)118.931.1500

KYOCERA MITA ITALIA S.P.A.

Via Verdi 89 / 91 20063 Cernusco sul Naviglio,
Italy
Phone: +39.02.92179.1

S.A. KYOCERA MITA BELGIUM N.V.

Hermesstraat 8A 1930 Zaventem Belgium
Phone: +32.(0)2.720.9270

KYOCERA MITA FRANCE S.A.

Parc Les Algorlthmes
Saint Aubin
91194 GIF-SUR-YVETTE
France
Phone: +33.(0)1.6985.2600

KYOCERA MITA ESPAÑA S.A.

Edificio Kyocera, Avda de Manacor N. 2,
Urb. Parque Rozas 28290 Las Rozas,
Madrid, Spain
Phone: +34.(0)91.631.8392

KYOCERA MITA FINLAND OY

Kirvesmiehenkatu 4 00810 Helsinki,
Finland
Phone: +358.(0)9.4780.5200

KYOCERA MITA (SCHWEIZ) AG

Holzliwisen Industriestrasse 28
8604 Volketswil, Switzerland
Phone: +41.(0)1.908.4949

KYOCERA MITA DEUTSCHLAND GMBH

Mollsfeld 12 D-40670 Meerbusch,
Germany
Phone: +49.(0)2159.918.0

KYOCERA MITA GMBH AUSTRIA

Eduard-Kittenberger Gasse 95
1230 Wien, Austria
Phone: +43.(0)1.86338.0

KYOCERA MITA SVENSKA AB

Box 1402 171 27 Solna, Sweden
Phone: +46.(0)8.546.550.00

KYOCERA MITA NORGE

Postboks 150 Oppsal, NO 0619 Oslo
Olaf Helsetsvei 6, NO 0694 Oslo
Phone: +47.(0)22.62.73.00

KYOCERA MITA DANMARK A/S

Hovedkontor: Slotsmarken 11,
DK-2970 Hørsholm, Denmark
Phone: +45.(70)22.3880

KYOCERA MITA PORTUGAL LDA.

Rua do Centro Cultural, no 41 1700-106
Lisbon, Portugal
Phone: +351.(0)21.842.9100

KYOCERA MITA SOUTH AFRICA (PTY) LTD.

527 Kyalami Boulevard,
Kyalami Business Park 1685 Midrand South
Phone: +27.(0)11.466.3290

KYOCERA MITA AMERICA, INC.

Headquarters:

225 Sand Road,
Fairfield, New Jersey 07004-0008,
U.S.A.
Phone: (973) 808-8444

KYOCERA MITA AUSTRALIA PTY. LTD.

Level 3, 6-10 Talavera Road, North Ryde,
N.S.W. 2113 Australia
Phone: (02) 9888-9999

KYOCERA MITA NEW ZEALAND LTD.

1-3 Parkhead Place, Albany
P.O. Box 302 125 NHPC, Auckland,
New Zealand
Phone: (09) 415-4517

KYOCERA MITA (THAILAND) CORP., LTD.

9/209 Ratchada-Prachachem Road,
Bang Sue, Bangkok 10800, Thailand
Phone: (02) 586-0320

KYOCERA MITA SINGAPORE PTE LTD.

121 Genting Lane, 3rd Level,
Singapore 349572
Phone: 67418733

KYOCERA MITA HONG KONG LIMITED

11/F., Mita Centre,
552-566, Castle Peak Road,
Tsuen Wan, New Territories,
Hong Kong
Phone: 24297422

KYOCERA MITA TAIWAN

Corporation.

7F-1~2, No.41, Lane 221, Gangchi Rd.
Neihu District, Taipei, Taiwan, 114. R.O.C.
Phone: (02) 87511560

KYOCERA MITA Corporation

2-28, 1-chome, Tamatsukuri, Chuo-ku
Osaka 540-8585, Japan
Phone: (06) 6764-3555
<http://www.kyoceramita.com>

Free Manuals Download Website

<http://myh66.com>

<http://usermanuals.us>

<http://www.somanuals.com>

<http://www.4manuals.cc>

<http://www.manual-lib.com>

<http://www.404manual.com>

<http://www.luxmanual.com>

<http://aubethermostatmanual.com>

Golf course search by state

<http://golfingnear.com>

Email search by domain

<http://emailbydomain.com>

Auto manuals search

<http://auto.somanuals.com>

TV manuals search

<http://tv.somanuals.com>