

[Table of Contents](#)



- Français
- Italiano



FS-1700/3700

User's Manual

Kyocera Laser Printers

Caution

NO LIABILITY IS ASSUMED FOR ANY DAMAGE CAUSED BY IMPROPER INSTALLATION.

SOFTWARE USED WITH THIS PRINTER MUST SUPPORT THE PRINTER'S EMULATION MODE. The printer is factory -set to emulate the HP LaserJet 4 Plus. The emulation mode can be changed by following the procedures described in *Chapter 2* (on CD-ROM).

Notice on Software

SOFTWARE USED WITH THIS PRINTER MUST SUPPORT THE PRINTER'S NATIVE MODE OR ONE OF ITS EMULATION MODES.

Notice

The information in this manual is subject to change without notification. Additional pages may be inserted in future editions. The user is asked to excuse any technical inaccuracies or typographical errors in the present edition.

No responsibility is assumed if accidents occur while the user is following the instructions in this manual. No responsibility is assumed for defects in the printer's firmware (contents of its read-only memory).

This manual, any copyrightable subject matter sold or provided with or in connection with the sale of the page printer, are protected by copyright. All rights are reserved. Copying or other reproduction of all or part of this manual, any copyrightable subject matter without the prior written consent of Kyocera Corporation is prohibited. Any copies made of all or part of this manual, any copyrightable subject must contain the same copyright notice as the material from which the copying is done.

Regarding Tradenames

PRESCRIBE is a registered trademark of Kyocera Corporation. PRESCRIBE II, KPDL, and KIR (Kyocera Image Refinement) are trademarks of Kyocera Corporation.

Diablo 630 is a product of Xerox Corporation. IBM Proprinter X24E is a product of International Business Machines Corporation. Epson LQ-850 is a product of Seiko Epson Corporation.

HP LaserJet 4 Plus is a product of Hewlett-Packard Company. Hewlett-Packard, PCL, and PJI are registered trademarks of Hewlett-Packard Company. Centronics is a trade name of Centronics Data Computer Corp. PostScript is a registered trademark of Adobe Systems Incorporated. Macintosh is a registered trademark of Apple Computer, Inc. AppleTalk is a trademark of Apple Computer, Inc. Microsoft, Windows, and MS-DOS are registered trademarks of Microsoft Corporation. Adobe and Acrobat are trademarks of Adobe Systems Incorporated which may be registered in certain jurisdictions.

This Kyocera page printer uses PeerlessPrint5 to provide the HP LaserJet compatible PCL5 language emulation. PeerlessPrint5 is a trademark of The Peerless Group, Redondo Beach, CA 90278, U.S.A.

This Kyocera printer uses STAC LZS to provide the compression technology. STAC LZS is a product of Stac Electronics.

Typeface Trademark Acknowledgement

All resident fonts in this printer are licensed from Bitstream Inc., Cambridge, Massachusetts, U.S.A.

Dutch801, Swiss742, Incised901, ZapfCalligraphic801, ZapfHumanist601, OriginalGaramond, and Chianti are trademarks of Bitstream Inc.

Century Schoolbook, Stymie, and Cooper-Black are trademarks of Kingsley-ATF Type Corporation.

ITC ZapfDingbats, ITC Souvenir, ITC Benguiat, and ITC Bookman are registered trademarks of International Typeface Corporation.

Revue is a trademark of Esselte Pendaflex Corporation in the U.S., Letraset Canada Ltd. in Canada, and Esselte Letraset Ltd. elsewhere.

Bitstream Sublicense Agreement

FONTWARE/TrueDoc developed by BITSTREAM INC. is provided as part of this Printer by KYOCERA CORPORATION under license. KYOCERA, as a Licensee of BITSTREAM, grants you, the Sublicensee, non-exclusive right to use FONTWARE/TrueDoc installed in this Printer, if you agree to and at all times comply with the following items:

1. Ownership

As the Sublicensee, you own the Printer in which FONTWARE/TrueDoc is originally installed, but BITSTREAM retains title to and ownership in the software program of FONTWARE/TrueDoc. The Sublicense is not a sale of the original software program of FONTWARE/TrueDoc or any portion or copy of it.

2. Copy Restrictions

FONTWARE/TrueDoc is copyrighted. Unauthorized copying of FONTWARE/TrueDoc even if modified, merged, or included with other software, is expressly forbidden. You may be held legally responsible for any copyright infringement.

3. Unauthorized Use

FONTWARE/TrueDoc may not be removed, disclosed and transferred to any third party for any length of time without the prior written consent of KYOCERA or BITSTREAM. Also, you may not modify, adapt, translate, reverse engineer, decompile, or create derivative works based on FONTWARE/TrueDoc.

4. Term

This agreement should remain in full force and effect forever thereby allowing the Sublicensee to use the FONTWARE/TrueDoc forever unless the Sublicensee violates the terms of paragraphs 2. or 3. above. In the event of such violation, this agreement will terminate automatically without notice from KYOCERA. Upon termination, you should destroy FONTWARE/TrueDoc and all copies of them, in part and in whole, including modified copies, if any.

FCC statement

This device complies with Part 15 of the FCC Rules. Operation is subject to the following two conditions: (1) This device may not cause harmful interference, and (2) this device must accept any interference received, including interference that may cause undesired operation.

This equipment has been tested and found to comply with the limits for a Class B digital device, pursuant to Part 15 of the FCC Rules. These limits are designed to provide reasonable protection against harmful interference in a residential installation. This equipment generates, uses, and can radiate radio frequency energy and, if not installed and used in accordance with the instructions, may cause harmful interference to radio communications. However, there is no guarantee that interference will not occur in a particular installation. If this equipment does cause harmful interference to radio or television reception, which can be determined by turning the equipment off and on, the user is encouraged to try to correct the interference by one or more of the following measures:

- Reorient or relocate the receiving antenna.
- Increase the separation between the equipment and receiver.
- Connect the equipment into an outlet on a circuit different from that to which the receiver is connected.
- Consult the dealer or an experienced radio/TV technician for help.

Changes or modifications not expressly approved by the manufacturer for compliance could void the user's authority to operate the equipment.

Shielded circular cable should be used for interfacing with the computer.

Caution to user

Any modification without prior permission may cause harmful interference.

If any modification/change is introduced to this equipment without prior permission, Kyocera as the manufacturer cannot guarantee compliance with FCC rules.

To use equipment which does not comply with FCC rules is prohibited.

The printer may be optionally installed with the following units:

Conforming to the Class A limits

- HS-3E Bulk Paper Stacker
- PF-7E Bulk Paper Feeder

Conforming to the Class B limits

- DU-20 Duplexer
- EF-1 Envelope Feeder
- HS-20 Paper Handler/Stacker
- IB-3 AppleTalk Interface Board
- PF-20 Paper Feeder
- PF-20mini Paper Feeder
- PK-series KPD L Upgrade Kit
- SO-6 Sorter/Stacker
- ST-20 Bulk Paper Stacker

Interface connectors

Important note on the interface connectors

Be sure to turn off printer power before connecting or disconnecting an interface cable to the printer. For protection against static discharge which may be applied to the printer's internal electronics through the interface connector(s), keep any interface connector which is not in use capped using the protective cap supplied.

 **Use shielded interface cable.**

Safety information

Laser safety

This printer is certified as a Class 1 laser product under the U.S. Department of Health and Human Services (DHHS) Radiation Performance Standard according to Radiation Control for Health and Safety Act of 1968. This means that the printer does not produce hazardous laser radiation. Since radiation emitted inside the printer is completely confined within protective housings and external covers, the laser beam cannot escape from the printer during any phase of user operation.

Laser notice

This printer is certified in the U.S. to conform to the requirements of DHHS 21 CFR Subchapter for Class I (1) laser products, and elsewhere is certified as a Class I laser product conforming to the requirements of IEC 825.

Caution Use of controls or adjustments or performance of procedures other than those specified herein may result in hazardous radiation exposure.



(European/Asian
countries)

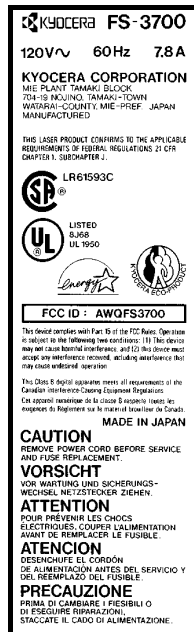

(U.S.A./Canada)

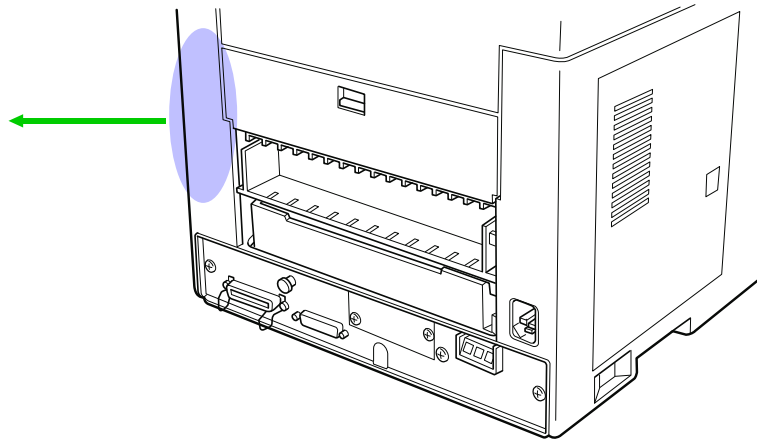

CDRH regulations

The Center of Devices and Radiological Health (CDRH) of the U.S. Food and Drug Administration implemented regulations for laser products on August 2, 1976. These regulations apply to laser products manufactured after August 1, 1976. Compliance is mandatory for products marketed in the United States. A label indicating compliance with the CDRH regulations must be attached to laser products marketed in the United States.

Ozone concentration

The printers generate ozone gas (O₃) which may concentrate in the place of installation and cause an unpleasant smell. To minimize concentration of ozone gas to less than 0.1 ppm, we recommend you not to install the printer in a confined area where ventilation is blocked.

IMPORTANT SAFEGUARDS

1. Read all of these instructions and save these instructions for later use.
2. Unplug this product from the wall outlet before cleaning.
3. Do not use this product near water.
4. Do not place this product on an unstable cart, stand, or table. The product may fall, causing serious damage to the product.
5. Slots and openings in the cabinet and the back are provided for ventilation to ensure reliable operation of the product and to protect it from overheating, these openings must not be blocked or covered. The openings should never be blocked by placing the product on a bed, sofa, rug, or other similar surface. This product should never be placed near or over a radiator or heat register. This product should not be placed in a built-in installation unless proper ventilation is provided.
6. This product is equipped with a 3-wire grounding type plug, a plug having a third (grounding) pin. This plug will only fit into a grounding-type power outlet. This is a safety feature. If you are unable to insert the plug into the outlet, contact your electrician to replace your obsolete outlet. Do not defeat the purpose of the grounding-type plug.
7. Do not allow anything to rest on the power cord. Do not locate this product where persons will walk on the cord.
8. If an extension cord is used with this product, make sure that the total of the ampere ratings on the products plugged into the extension cord do not exceed the extension cord ampere rating.
9. Never push objects of any kind into this product through cabinet slots as they may touch dangerous voltage points or short out parts that could result in a risk of fire or electric shock. Never spill liquid of any kind on the product.
10. Except as explained elsewhere in *User's Manual*, do not attempt to service this product yourself. Removing covers may expose you to dangerous voltage points or other risks. Refer all servicing in those compartments to service personnel.
11. Unplug this product from the wall outlet and refer servicing to qualified service personnel under the following conditions:
 - A— When the power cord or plug is damaged or frayed.
 - B— If liquid has been spilled into the product.
 - C— If the product has been exposed to rain or water.
 - D— If the product does not operate normally when the operating instructions are followed. Adjust only those controls that are covered by the operating instructions since improper adjustment of other controls may result in damage and will often require extensive work by a qualified technician to restore the product to normal operation.
 - E— If the product has been dropped or the cabinet has been damaged.

Canadian Department of Communications compliance statement

This Class B digital apparatus meets all requirements of the Canadian Interference-Causing Equipment Regulations.

Avis de conformité aux normes du ministère des Communications du Canada

Cet appareil numérique de la classe B respecte toutes les exigences du Règlement sur le matériel brouilleur du Canada.

ISO 7779

Maschinenlärminformationsverordnung 3. GSGV, 18.01.1991: Der höchste Schalldruckpegel beträgt 70 dB(A) oder weniger gemäß ISO 7779.

Disclaimer

We shall have no liability or responsibility to customers or any other person or entity with respect to any liability, loss or damage caused or alleged to be caused directly or indirectly by equipment sold or furnished by us, including but not limited to, any interruption of service, loss of business or anticipatory profits, or consequential damages resulting from the use or operation of the equipment or software.

Prolonged Non-Use and Moving the Printer

Prolonged Non-use

If you ever leave the printer unused for a long period of time, remove the power cord from the wall outlet.

We recommend you consult with your dealer about the additional actions you should take to avoid possible damages that may occur when the printer is used next time.

Moving the Printer

When you move the printer:

- Move it gently.
- Keep it as level as possible, to avoid spilling toner inside the printer.

- ❑ If you ship the printer, remove and ship the developer unit (and the waste toner bottle) separately. The printer is originally supplied with a shipping container specifically designed for the developer unit. Pack the developer unit in this container and the waste toner bottle in the plastic bag obtainable from a toner kit and ship them separate from the printer itself. Be sure to consult a serviceman before attempting long-distance transportation of the printer.

ENERGY STARSM



As an ENERGY STAR Partner, Kyocera Corporation has determined that this product meets the ENERGY STAR guidelines for energy efficiency.

The basic objective of the ENERGY STAR Program is to reduce environmental pollution by encouraging the manufacture and sale of equipment that uses energy more efficiently.

This printer is equipped with a sleep timer function that conforms with the standards of the ENERGY STAR Program. This function makes it possible to reduce the amount of electrical power consumed by the printer.

For maximum power savings, turn off the printer's power supply when not using the printer for extended periods of time.

For details on the sleep timer function and printer power consumption, refer to the instruction manual provided with the printer.

Initial settings of the sleep timer function and power saved using the sleep timer function:

	Initial sleep mode setting	Power consumption in sleep mode
FS-1700	30 minutes (30 minutes)	19 W (30 W)
FS-3700	30 minutes (60 minutes)	20 W (45 W)

() : ENERGY STAR program guideline



This product has been expressly developed and produced in the interest of protecting the environment over its entire product life and beyond.

Through the use of a new amorphous silicon drum and developer Kyocera has created a revolutionary printing system that does not require the wasteful replacement and disposal of a cartridge.

Introduction

The Kyocera laser printer has many extremely desirable features. It was designed to make a contribution to a cleaner environment as well as to represent the latest generation of page printer technology.

Maintenance Features

Compact design—Thanks to the inboard paper cassette configuration, the printer requires no more space than the average computer.

Ultra long life modules—The main modules for developing image and printing, such as the drum, developer, and the fuser, are specifically designed for extraordinarily long life and need no periodic replacement. The drum is made of amorphous silicon which is environmentally benign and is designed as a permanent component in the printer. The only maintenance regularly needed is to replenish the toner supply in the developer approximately every 10,000 pages and to clean some parts inside the printer.

Amorphous silicon drum—Kyocera's own unique ceramics technology has led to the development of an extremely hard and durable drum with extraordinarily long service life. Also, the drum has several excellent photoconductive properties, such as stability and reliability in varying temperatures, resistance to heat and solvent, etc., thus providing superb high resolution printing.

Print Engine Features

Superb print quality— With 600 dots-per-inch, the printout is close to typeset quality. Also, Kyocera Image Refinement (KIR) technology provides excellent sharpness and consistency.

High speed— A4-size pages typically print at the rate of 18 (12 for model FS-1700) pages per minute. (Actual time required varies according to page complexity.)

Large paper capacity — The printer accommodates a paper cassette with a capacity of approximately 250 sheets (75 g/m² [20 lb./ream] basis weight, 0.1 mm thickness) and a multi-purpose tray with a capacity of approximately 100 sheets (350 sheets in total).

Wide variety of print media— In addition to standard paper, the printer prints on special media of a wide range of types and sizes, including recycled paper, envelopes, labels and OHP film.

Sleep mode (Ecopower)— conserves energy during the printer's idle periods.

Ecoprint mode— extends toner yield by reducing the amount of toner used on the page.

Standard bi-directional parallel interface— supports high-speed data exchange with the computer.

Software Features

Bitmapped and scalable typefaces— In addition to its 79 internal bitmap fonts, the printer provides 45 fully-scalable resident typefaces that are equivalent to HPLJ fonts. The scalable typefaces can be used at any size desired up to 999.75 points, in 0.25-point increments.

A new printer control language, PRESCRIBE II, is provided with features including advanced graphics capabilities that allow you to print any conceivable outline shape or solid form. Also provided are a variety of special effects, such as patterned fills, gray-scale shading, a user-accessible print image model, and multiple page orientations and print directions within the same page.

PDF417 two-dimensional bar code— The printer includes the capability that allows the user to implement the two-dimensional stacked bar code symbology, PDF417, or Portable Data File 417. This expanded functionality is achieved by using the PRESCRIBE II language commands.

Automatic rotation of fonts and graphics— Images and scalable fonts are automatically rotated to match the page orientation.

A wide variety of internal symbol sets— The printer supports most Hewlett-Packard LaserJet 4 Plus compatible symbol sets for both bitmap and scalable fonts.

Display of printer messages in any of three languages— English, French, or German. As an option it is also possible to have the messages displayed in other languages. Please contact your Kyocera dealer.

Memory card slot for option fonts, macros, forms, etc.— Data in the memory card can be selectively read from the printer's control panel.

Simple Network Management Protocol (SNMP) compliance— Offers network managers complete open system network management.

Kyocera PrintMonitor (KPM)— Provides network wide management of the Kyocera FS family of laser printers. Please refer to the readme file located in the Kyocera Digital Library (included with the printer) for details.

Options

The following options are available for the printer.

DU-20	Duplexer
EF-1	Envelope Feeder
HS-3E	Bulk Paper Stacker
HS-20	Paper Handler/Stacker
IB-3	AppleTalk Interface Board
PA-1	Paper Path Adaptor
PA-20	Paper Path Adaptor
PC-20	Paper Cassette for PF-20 (universal size; adjustable to A5 through Legal sizes)
PC-21	Paper Cassette for the printer (available in A5, JIS B5, A4, Letter, or Letter/Legal size)
PF-7E	Bulk Paper Feeder
PF-20	Paper Feeder (A5, JIS B5, A4, Letter, Legal)
PF-20mini	Paper Feeder (A5, JIS B5, A4, Letter)
PK-series	KPDL Upgrade Kit
SO-6	Sorter/stacker
ST-20	Bulk Paper Stacker

Guide to the Manual

Unless specifically stated otherwise, information in this manual applies to printer models FS-1700/FS-3700. The printer illustrations and printed samples used in this manual are of the FS-3700.

Installation Manual

The *Installation Manual* guides you through the following topics:

- Installation
- Printer basic operation

CD-ROM (Kyocera Digital Library)

The CD-ROM supplied contains the printer User's Manual, PRESCRIBE II Programming Manual, and PDF417 Two Dimensional Bar Code Implementation Manual. To gain access to these documents, insert the CD-ROM into the appropriate drive and follow the instructions on the insert accompanying the CD-ROM. To view these documents, you need the Adobe Acrobat software installed in your computer. For details, read the instructions on the CD-ROM package.

The User's Manual guides you through topics concerning the operations and maintenance of the printer.

The PRESCRIBE II Programming Manual explains how to use the PRESCRIBE II commands in document files for formatting, and their parameters in detail for experienced users, using pictures and samples.

User's Manual (on CD-ROM):

- Installation
- Printer operation
- Control panel operations
- Fonts
- Maintenance and troubleshooting
- Symbol sets

PRESCRIBE II Programming Manual (on CD-ROM):

- PRESCRIBE II command reference
- Fonts
- Bar codes
- Printer permanent parameters
- Emulation

PDF417 Two Dimensional Bar Code Implementation Manual (on CD-ROM):

- PDF417 overview
- PRESCRIBE II commands for PDF417

Table of Contents

Chapter 1 Installing the Printer	1—1
1.1. Positioning the Printer	1—1
Clearance	1—1
Places to Avoid	1—1
Basic requirements	1—2
Power Supply	1—3
1.2. Unpacking and Inspection	1—3
List of shipped components	1—4
1.3. Names of Parts	1—5
Front View	1—5
Interior View	1—6
Rear View	1—6
1.4. Setting Up and Interfacing	1—7
1—Open the Top Cover	1—8
2—Install the Toner Container	1—8
3—Close the Top Cover	1—9
4—Install the Waste Toner Bottle	1—9
5—Add Paper	1—11
6—Open the Paper Stopper on the Face-down Output Tray	1—12
7—Install the Face-up Output Tray (if required)	1—12
8—Connect the Printer to the Computer	1—13
9—Attach the Power Cord	1—13
10—Print a Status Page	1—14
11—Test the Interface with the Computer	1—14
12—Set the Emulation Mode	1—14
13—Install the Printer Driver	1—15
1.5. Multi-Purpose Tray Feeding	1—17
Selecting the Multi-Purpose Tray	1—17
1.6. Memory Card	1—21
Handling Memory Cards	1—22
1.7. Memory Expansion Installation	1—23
Removing the Main Circuit Board	1—23
SIMM to be used	1—25
Installing and Removing SIMMs	1—26
Testing the Expansion Memory	1—27

Chapter 2 Operating the Laser Printer 2—1

2.1. Control Panel	2—1
Message Display	2—2
Interface Indicator	2—2
Resolution Indicator	2—2
Paper Size Indicator	2—3
Copy Indicator	2—3
Symbolic Indicators	2—4
Control Keys	2—5
2.2. Operating Procedures	2—6
Switching Power On	2—6
Stack Selection	2—6
Feed Selection	2—7
On-line/Off-line Setting	2—7
Abandoning a Printing Job	2—7
Status Printout	2—8
Form Feed	2—11
2.3. Using the Mode Select Menu	2—12
Mode Select Menu	2—12
2.4. Sleep (Ecopower) Mode	2—14
2.5. KIR Level	2—15
2.6. Ecoprint mode	2—16
2.7. Resource Protection	2—17
2.8. Adjusting the Print Density	2—17
2.9. Setting the Audio Warning (Buzzer)	2—18
2.10. Operating a Memory Card	2—20
Hints on Writing Fonts to the Memory Card	2—20
Reading Fonts/Data from a Memory Card	2—20
Writing Data to a Memory Card	2—21
Deleting Data from a Memory Card	2—22
Formatting a Memory Card	2—23
Printing a list of data names	2—24

Chapter 3 Fonts **3—1**

3.1. Bitmap and Scalable Fonts	3—1
Bitmap fonts	3—2
Scalable fonts	3—2
3.2. List of Fonts	3—3
Bitmap Fonts	3—3
Scalable Fonts	3—3
Option Fonts	3—3
3.3. Symbol set	3—11

Chapter 4 Maintenance **4—1**

4.1. Toner Kit Replacement	4—1
Toner Kit to be Used	4—1
Supplying Toner	4—2
Replace the Waste Toner Bottle	4—4
4.2. Cleaning	4—6
Main Charger Unit	4—6
Paper Feed Unit	4—8

Chapter 5 Troubleshooting **5—1**

5.1. General Guide	5—1
5.2. Power Problems	5—2
5.3. Interface Problems	5—2
5.4. Print Quality Problems	5—3
Completely blank printout	5—3
All-black printout	5—3
Dropouts, horizontal streaks, stray dots	5—4
Black or white vertical streaks	5—4
Faint or blurred printing	5—5
Grey background	5—5
Dirt on the top edge or back of the paper	5—6
Characters out of position	5—6
5.5. Indicators and Messages	5—7
Indicators	5—7
Maintenance Messages	5—8
Error Messages	5—9
5.6. Correcting a Paper Jam	5—11

Chapter 6 Symbol Set Tables 6—1

6.1. IBM Symbol Sets 6—2
6.2. Diablo 630 Symbol Sets 6—8
6.3. LQ-850 Symbol Sets 6—11
6.4. HP LaserJet 4 Plus Symbol Sets 6—13

Appendix A Printer Specifications A—1

Appendix B Paper Selection B—1

B.1. General Guidelines B—1
 Paper Availability B—1
 Paper Specifications B—2
B.2. Selecting the Right Paper B—2
B.3. Special Paper B—5
 Overhead Projection (OHP) Film B—5
 Adhesive-Backed Labels B—6

Appendix C Host Computer Interface C—1

C.1. Parallel Interface C—1
 Parallel interface communication modes C—1
 Interface Signals C—2
C.2. RS-232C/RS-422A Interface C—5
 RS-232C interface C—5
 RS-422A interface C—6
C.3. RS-232C/RS-422A Protocol C—10
 PRESCRIBE II FRPO D0 command C—11
C.4. RS-232C Cable Connection C—12
 Preparing an RS-232C Cable C—12
 Connecting the Printer to the Computer C—12

Index Index—1

Mode Select Menu Last page

1.7. Memory Expansion Installation

In this section is explained how to expand the printer's memory. Expanded printer memory enables you to print more complex pages, download more fonts, and define more macros.

It begins by explaining how to remove the main circuit board from the printer, and explains how to install a SIMM (single in-line memory module) on the main circuit board.

 **The expansion memory should be installed only by a Kyocera authorized dealer or Kyocera certified technician. Kyocera shall not be liable for damage due to improper installation of the expansion memory.**

The minimum memory requirements for the printer with various options installed are listed in the table below. Please refer to this table when expanding the printer's memory.

Printing condition	Resolution	
	300 dpi	600 dpi
HP LaserJet 4 Plus only	2 MB	2 MB
HP LaserJet 4 Plus, duplex mode = on	2 MB	3 MB
HP LaserJet 4 Plus/KPDL, duplex mode = None	2 MB	3 MB
HP LaserJet 4 Plus/KPDL, duplex mode = on	3 MB	5 MB
HP LaserJet 4 Plus/KPDL, resource protection, duplex mode = None,	-	10 MB
HP LaserJet 4 Plus/KPDL, resource protection, duplex mode = on,	-	14 MB

Removing the Main Circuit Board

The main circuit board of the printer is equipped with two sockets for memory expansion. Expansion memory is available in the form of a SIMM.

 **The following instructions are intended for the technician only.**

Notes on Handling the Main Circuit Board and SIMM

Protect the electronics by taking these precautions:

- Before touching the main circuit board, touch a water pipe or other large metal object to discharge yourself of static electricity. While doing the work, it is recommended that you wear an antistatic wrist strap.
- Touch the main circuit board and SIMM only by the edges.

Withdrawing the Main Circuit Board from the Printer

- Be sure to remove the memory card first if inserted in the printer's memory card slot.

Withdraw the main circuit board completely from the printer as follows:

1. Turn the printer's power off. Unplug the printer's power cable and disconnect the printer from the host computer.
2. Remove the three screws from the printer's rear cover.

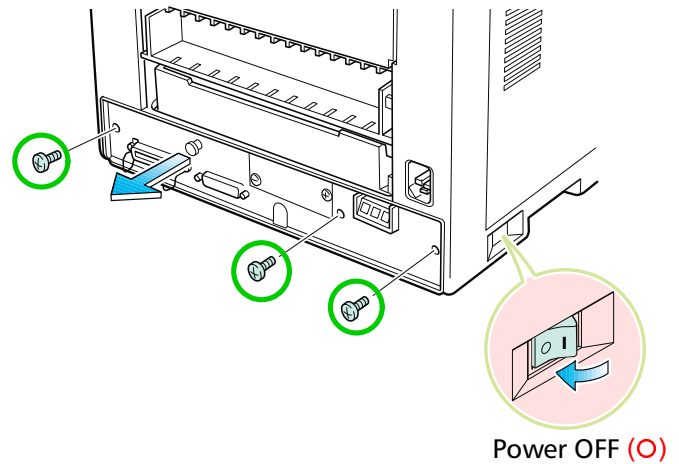

3. Pull the main circuit board all the way out of the printer.

- Before pulling the main board out, clean an area on the table, etc., at the back of the printer's rear panel. Foreign objects, accidentally sticking to the back of the main board, can cause serious damage to the printer.

Install the SIMM as described on the next page.

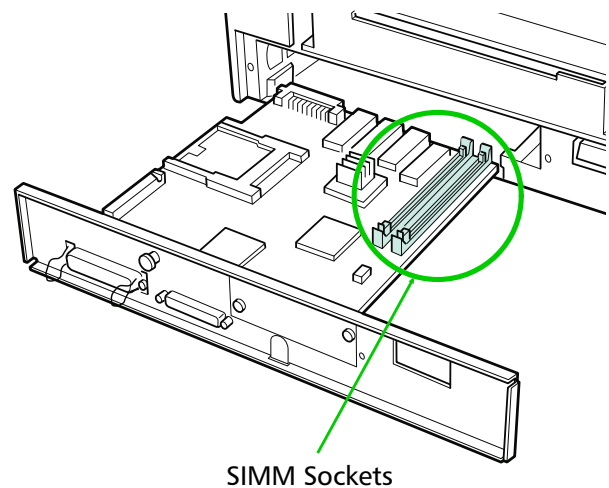

SIMM to be used

See your Kyocera dealer for purchasing information of the SIMMs that are best suited for use with this printer.

Either 1 MB, 2 MB, 4 MB, 8 MB, 16 MB or 32 MB SIMMs can be used for memory expansion. Together with the memory already present in the printer, this allows memory to be expanded up to a total of 66 MB.

The table below shows valid SIMM configurations for memory expansion.

Total printer memory required	Type and number of SIMMs
2 MB	(Factory default)
3 MB	1 MB SIMM x 1
4 MB	1 MB SIMM x 2 or 2 MB SIMM x 1
5 MB	1 MB SIMM and 2 MB SIMM
6 MB	4 MB SIMM x 1 or 2MB SIMM x 2
7 MB	1 MB SIMM and 4 MB SIMM
8 MB	2 MB SIMM and 4 MB SIMM
10 MB	4 MB SIMM x 2 or 8 MB SIMM x 1
11 MB	1 MB SIMM and 8 MB SIMM
12 MB	2 MB SIMM and 8 MB SIMM
14 MB	4 MB SIMM and 8 MB SIMM
18 MB	16 MB SIMM x 1 or 8 MB SIMM x 2
19 MB	1 MB SIMM and 16 MB SIMM
20 MB	2 MB SIMM and 16 MB SIMM
22 MB	4 MB SIMM and 16 MB SIMM
26 MB	8 MB SIMM and 16 MB SIMM
34 MB	32 MB SIMM x 1 or 16 MB SIMM x 2
35 MB	1 MB SIMM and 32 MB SIMM
36 MB	2 MB SIMM and 32 MB SIMM
38 MB	4 MB SIMM and 32 MB SIMM
42 MB	8 MB SIMM and 32 MB SIMM
50 MB	16 MB SIMM and 32 MB SIMM
66 MB	32 MB SIMM x 2

Installing and Removing SIMMs

Installing SIMMs

Insert the SIMM into the socket as shown right.

1. Insert the connector end of the SIMM into the socket.
2. Carefully push the board upright until it snaps into place. Make sure that the catches at the ends of the socket fit into the holes at the ends of the SIMM board.

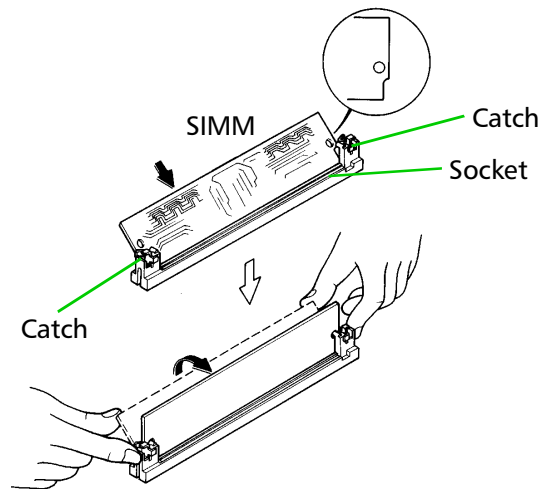

Removing SIMMs

To remove a SIMM, carefully pull the end catches slightly outwards and tilt the SIMM as shown, then pull the SIMM out of the socket.

Reverse the procedure under *Withdrawing the Main Circuit Board from the Printer* to put the main circuit board back into the printer.

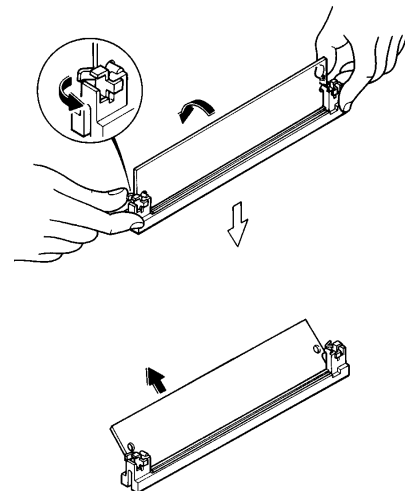

Testing the Expansion Memory

After you have finished installing SIMMs in the printer, test the printer to see if the installation has been successful.

To test the expansion memory, proceed as follows:

- 1.** Make sure the power switch is off. Plug the power cord into the printer and turn power on.
- 2.** When the printer is on-line, press the **STATUS** key.
- 3.** If the installation has been successful, the *Total memory* (Memory Allocation) of the status page will show the expanded memory size corresponding to the amount of memory added. (The factory installed memory size is 2 MB.)

Caution

NO LIABILITY IS ASSUMED FOR ANY DAMAGE CAUSED BY IMPROPER INSTALLATION.

SOFTWARE USED WITH THIS PRINTER MUST SUPPORT THE PRINTER'S EMULATION MODE. The printer is factory -set to emulate the HP LaserJet 4 Plus. The emulation mode can be changed by following the procedures described in *Chapter 2* (on CD-ROM).

Notice on Software

SOFTWARE USED WITH THIS PRINTER MUST SUPPORT THE PRINTER'S NATIVE MODE OR ONE OF ITS EMULATION MODES.

Notice

The information in this manual is subject to change without notification. Additional pages may be inserted in future editions. The user is asked to excuse any technical inaccuracies or typographical errors in the present edition.

No responsibility is assumed if accidents occur while the user is following the instructions in this manual. No responsibility is assumed for defects in the printer's firmware (contents of its read-only memory).

This manual, any copyrightable subject matter sold or provided with or in connection with the sale of the page printer, are protected by copyright. All rights are reserved. Copying or other reproduction of all or part of this manual, any copyrightable subject matter without the prior written consent of Kyocera Corporation is prohibited. Any copies made of all or part of this manual, any copyrightable subject must contain the same copyright notice as the material from which the copying is done.

Regarding Tradenames

PRESCRIBE is a registered trademark of Kyocera Corporation. PRESCRIBE II, KPDL, and KIR (Kyocera Image Refinement) are trademarks of Kyocera Corporation.

Diablo 630 is a product of Xerox Corporation. IBM Proprinter X24E is a product of International Business Machines Corporation. Epson LQ-850 is a product of Seiko Epson Corporation.

HP LaserJet 4 Plus is a product of Hewlett-Packard Company. Hewlett-Packard, PCL, and PJI are registered trademarks of Hewlett-Packard Company. Centronics is a trade name of Centronics Data Computer Corp. PostScript is a registered trademark of Adobe Systems Incorporated. Macintosh is a registered trademark of Apple Computer, Inc. AppleTalk is a trademark of Apple Computer, Inc. Microsoft, Windows, and MS-DOS are registered trademarks of Microsoft Corporation. Adobe and Acrobat are trademarks of Adobe Systems Incorporated which may be registered in certain jurisdictions.

This Kyocera page printer uses PeerlessPrint5 to provide the HP LaserJet compatible PCL5 language emulation. PeerlessPrint5 is a trademark of The Peerless Group, Redondo Beach, CA 90278, U.S.A.

This Kyocera printer uses STAC LZS to provide the compression technology. STAC LZS is a product of Stac Electronics.

Typeface Trademark Acknowledgement

All resident fonts in this printer are licensed from Bitstream Inc., Cambridge, Massachusetts, U.S.A.

Dutch801, Swiss742, Incised901, ZapfCalligraphic801, ZapfHumanist601, OriginalGaramond, and Chianti are trademarks of Bitstream Inc.

Century Schoolbook, Stymie, and Cooper-Black are trademarks of Kingsley-ATF Type Corporation.

ITC ZapfDingbats, ITC Souvenir, ITC Benguiat, and ITC Bookman are registered trademarks of International Typeface Corporation.

Revue is a trademark of Esselte Pendaflex Corporation in the U.S., Letraset Canada Ltd. in Canada, and Esselte Letraset Ltd. elsewhere.

Bitstream Sublicense Agreement

FONTWARE/TrueDoc developed by BITSTREAM INC. is provided as part of this Printer by KYOCERA CORPORATION under license. KYOCERA, as a Licensee of BITSTREAM, grants you, the Sublicensee, non-exclusive right to use FONTWARE/TrueDoc installed in this Printer, if you agree to and at all times comply with the following items:

1. Ownership

As the Sublicensee, you own the Printer in which FONTWARE/TrueDoc is originally installed, but BITSTREAM retains title to and ownership in the software program of FONTWARE/TrueDoc. The Sublicense is not a sale of the original software program of FONTWARE/TrueDoc or any portion or copy of it.

2. Copy Restrictions

FONTWARE/TrueDoc is copyrighted. Unauthorized copying of FONTWARE/TrueDoc even if modified, merged, or included with other software, is expressly forbidden. You may be held legally responsible for any copyright infringement.

3. Unauthorized Use

FONTWARE/TrueDoc may not be removed, disclosed and transferred to any third party for any length of time without the prior written consent of KYOCERA or BITSTREAM. Also, you may not modify, adapt, translate, reverse engineer, decompile, or create derivative works based on FONTWARE/TrueDoc.

4. Term

This agreement should remain in full force and effect forever thereby allowing the Sublicensee to use the FONTWARE/TrueDoc forever unless the Sublicensee violates the terms of paragraphs 2. or 3. above. In the event of such violation, this agreement will terminate automatically without notice from KYOCERA. Upon termination, you should destroy FONTWARE/TrueDoc and all copies of them, in part and in whole, including modified copies, if any.

FCC statement

This device complies with Part 15 of the FCC Rules. Operation is subject to the following two conditions: (1) This device may not cause harmful interference, and (2) this device must accept any interference received, including interference that may cause undesired operation.

This equipment has been tested and found to comply with the limits for a Class B digital device, pursuant to Part 15 of the FCC Rules. These limits are designed to provide reasonable protection against harmful interference in a residential installation. This equipment generates, uses, and can radiate radio frequency energy and, if not installed and used in accordance with the instructions, may cause harmful interference to radio communications. However, there is no guarantee that interference will not occur in a particular installation. If this equipment does cause harmful interference to radio or television reception, which can be determined by turning the equipment off and on, the user is encouraged to try to correct the interference by one or more of the following measures:

- Reorient or relocate the receiving antenna.
- Increase the separation between the equipment and receiver.
- Connect the equipment into an outlet on a circuit different from that to which the receiver is connected.
- Consult the dealer or an experienced radio/TV technician for help.

Changes or modifications not expressly approved by the manufacturer for compliance could void the user's authority to operate the equipment.

Shielded circular cable should be used for interfacing with the computer.

Caution to user

Any modification without prior permission may cause harmful interference.

If any modification/change is introduced to this equipment without prior permission, Kyocera as the manufacturer cannot guarantee compliance with FCC rules.

To use equipment which does not comply with FCC rules is prohibited.

The printer may be optionally installed with the following units:

Conforming to the Class A limits

- HS-3E Bulk Paper Stacker
- PF-7E Bulk Paper Feeder

Conforming to the Class B limits

- DU-20 Duplexer
- EF-1 Envelope Feeder
- HS-20 Paper Handler/Stacker
- IB-3 AppleTalk Interface Board
- PF-20 Paper Feeder
- PF-20mini Paper Feeder
- PK-series KPD L Upgrade Kit
- SO-6 Sorter/Stacker
- ST-20 Bulk Paper Stacker

Interface connectors

Important note on the interface connectors

Be sure to turn off printer power before connecting or disconnecting an interface cable to the printer. For protection against static discharge which may be applied to the printer's internal electronics through the interface connector(s), keep any interface connector which is not in use capped using the protective cap supplied.

 **Use shielded interface cable.**

Safety information

Laser safety

This printer is certified as a Class 1 laser product under the U.S. Department of Health and Human Services (DHHS) Radiation Performance Standard according to Radiation Control for Health and Safety Act of 1968. This means that the printer does not produce hazardous laser radiation. Since radiation emitted inside the printer is completely confined within protective housings and external covers, the laser beam cannot escape from the printer during any phase of user operation.

Laser notice

This printer is certified in the U.S. to conform to the requirements of DHHS 21 CFR Subchapter for Class I (1) laser products, and elsewhere is certified as a Class I laser product conforming to the requirements of IEC 825.

Caution Use of controls or adjustments or performance of procedures other than those specified herein may result in hazardous radiation exposure.



(European/Asian
countries)

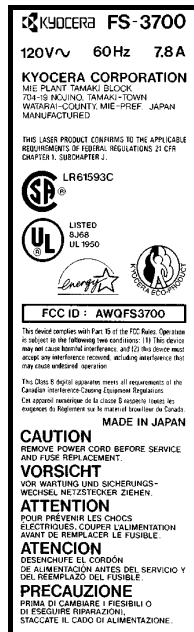

(U.S.A./Canada)

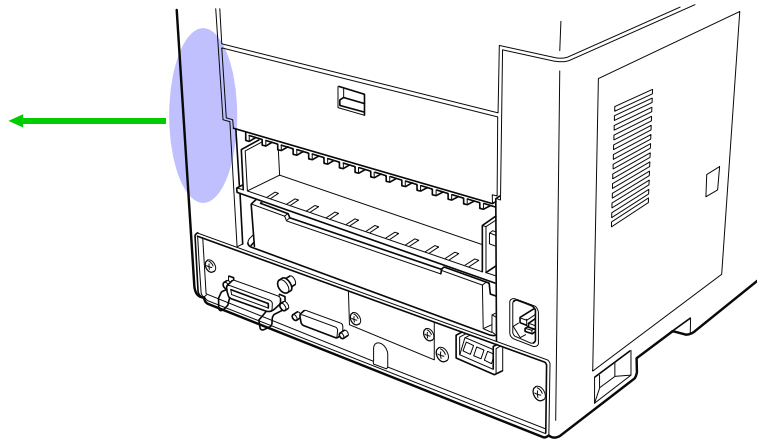

CDRH regulations

The Center of Devices and Radiological Health (CDRH) of the U.S. Food and Drug Administration implemented regulations for laser products on August 2, 1976. These regulations apply to laser products manufactured after August 1, 1976. Compliance is mandatory for products marketed in the United States. A label indicating compliance with the CDRH regulations must be attached to laser products marketed in the United States.

Ozone concentration

The printers generate ozone gas (O₃) which may concentrate in the place of installation and cause an unpleasant smell. To minimize concentration of ozone gas to less than 0.1 ppm, we recommend you not to install the printer in a confined area where ventilation is blocked.

IMPORTANT SAFEGUARDS

1. Read all of these instructions and save these instructions for later use.
2. Unplug this product from the wall outlet before cleaning.
3. Do not use this product near water.
4. Do not place this product on an unstable cart, stand, or table. The product may fall, causing serious damage to the product.
5. Slots and openings in the cabinet and the back are provided for ventilation to ensure reliable operation of the product and to protect it from overheating, these openings must not be blocked or covered. The openings should never be blocked by placing the product on a bed, sofa, rug, or other similar surface. This product should never be placed near or over a radiator or heat register. This product should not be placed in a built-in installation unless proper ventilation is provided.
6. This product is equipped with a 3-wire grounding type plug, a plug having a third (grounding) pin. This plug will only fit into a grounding-type power outlet. This is a safety feature. If you are unable to insert the plug into the outlet, contact your electrician to replace your obsolete outlet. Do not defeat the purpose of the grounding-type plug.
7. Do not allow anything to rest on the power cord. Do not locate this product where persons will walk on the cord.
8. If an extension cord is used with this product, make sure that the total of the ampere ratings on the products plugged into the extension cord do not exceed the extension cord ampere rating.
9. Never push objects of any kind into this product through cabinet slots as they may touch dangerous voltage points or short out parts that could result in a risk of fire or electric shock. Never spill liquid of any kind on the product.
10. Except as explained elsewhere in *User's Manual*, do not attempt to service this product yourself. Removing covers may expose you to dangerous voltage points or other risks. Refer all servicing in those compartments to service personnel.
11. Unplug this product from the wall outlet and refer servicing to qualified service personnel under the following conditions:
 - A— When the power cord or plug is damaged or frayed.
 - B— If liquid has been spilled into the product.
 - C— If the product has been exposed to rain or water.
 - D— If the product does not operate normally when the operating instructions are followed. Adjust only those controls that are covered by the operating instructions since improper adjustment of other controls may result in damage and will often require extensive work by a qualified technician to restore the product to normal operation.
 - E— If the product has been dropped or the cabinet has been damaged.

Canadian Department of Communications compliance statement

This Class B digital apparatus meets all requirements of the Canadian Interference-Causing Equipment Regulations.

Avis de conformité aux normes du ministère des Communications du Canada

Cet appareil numérique de la classe B respecte toutes les exigences du Règlement sur le matériel brouilleur du Canada.

ISO 7779

Maschinenlärminformationsverordnung 3. GSGV, 18.01.1991: Der höchste Schalldruckpegel beträgt 70 dB(A) oder weniger gemäß ISO 7779.

Disclaimer

We shall have no liability or responsibility to customers or any other person or entity with respect to any liability, loss or damage caused or alleged to be caused directly or indirectly by equipment sold or furnished by us, including but not limited to, any interruption of service, loss of business or anticipatory profits, or consequential damages resulting from the use or operation of the equipment or software.

Prolonged Non-Use and Moving the Printer

Prolonged Non-use

If you ever leave the printer unused for a long period of time, remove the power cord from the wall outlet.

We recommend you consult with your dealer about the additional actions you should take to avoid possible damages that may occur when the printer is used next time.

Moving the Printer

When you move the printer:

- Move it gently.
- Keep it as level as possible, to avoid spilling toner inside the printer.

- ❑ If you ship the printer, remove and ship the developer unit (and the waste toner bottle) separately. The printer is originally supplied with a shipping container specifically designed for the developer unit. Pack the developer unit in this container and the waste toner bottle in the plastic bag obtainable from a toner kit and ship them separate from the printer itself. Be sure to consult a serviceman before attempting long-distance transportation of the printer.

ENERGY STARSM



As an ENERGY STAR Partner, Kyocera Corporation has determined that this product meets the ENERGY STAR guidelines for energy efficiency.

The basic objective of the ENERGY STAR Program is to reduce environmental pollution by encouraging the manufacture and sale of equipment that uses energy more efficiently.

This printer is equipped with a sleep timer function that conforms with the standards of the ENERGY STAR Program. This function makes it possible to reduce the amount of electrical power consumed by the printer.

For maximum power savings, turn off the printer's power supply when not using the printer for extended periods of time.

For details on the sleep timer function and printer power consumption, refer to the instruction manual provided with the printer.

Initial settings of the sleep timer function and power saved using the sleep timer function:

	Initial sleep mode setting	Power consumption in sleep mode
FS-1700	30 minutes (30 minutes)	19 W (30 W)
FS-3700	30 minutes (60 minutes)	20 W (45 W)

() : ENERGY STAR program guideline



This product has been expressly developed and produced in the interest of protecting the environment over its entire product life and beyond.

Through the use of a new amorphous silicon drum and developer Kyocera has created a revolutionary printing system that does not require the wasteful replacement and disposal of a cartridge.

Introduction

The Kyocera laser printer has many extremely desirable features. It was designed to make a contribution to a cleaner environment as well as to represent the latest generation of page printer technology.

Maintenance Features

Compact design—Thanks to the inboard paper cassette configuration, the printer requires no more space than the average computer.

Ultra long life modules—The main modules for developing image and printing, such as the drum, developer, and the fuser, are specifically designed for extraordinarily long life and need no periodic replacement. The drum is made of amorphous silicon which is environmentally benign and is designed as a permanent component in the printer. The only maintenance regularly needed is to replenish the toner supply in the developer approximately every 10,000 pages and to clean some parts inside the printer.

Amorphous silicon drum—Kyocera's own unique ceramics technology has led to the development of an extremely hard and durable drum with extraordinarily long service life. Also, the drum has several excellent photoconductive properties, such as stability and reliability in varying temperatures, resistance to heat and solvent, etc., thus providing superb high resolution printing.

Print Engine Features

Superb print quality— With 600 dots-per-inch, the printout is close to typeset quality. Also, Kyocera Image Refinement (KIR) technology provides excellent sharpness and consistency.

High speed— A4-size pages typically print at the rate of 18 (12 for model FS-1700) pages per minute. (Actual time required varies according to page complexity.)

Large paper capacity — The printer accommodates a paper cassette with a capacity of approximately 250 sheets (75 g/m² [20 lb./ream] basis weight, 0.1 mm thickness) and a multi-purpose tray with a capacity of approximately 100 sheets (350 sheets in total).

Wide variety of print media— In addition to standard paper, the printer prints on special media of a wide range of types and sizes, including recycled paper, envelopes, labels and OHP film.

Sleep mode (Ecopower)— conserves energy during the printer's idle periods.

Ecoprint mode— extends toner yield by reducing the amount of toner used on the page.

Standard bi-directional parallel interface— supports high-speed data exchange with the computer.

Software Features

Bitmapped and scalable typefaces— In addition to its 79 internal bitmap fonts, the printer provides 45 fully-scalable resident typefaces that are equivalent to HPLJ fonts. The scalable typefaces can be used at any size desired up to 999.75 points, in 0.25-point increments.

A new printer control language, PRESCRIBE II, is provided with features including advanced graphics capabilities that allow you to print any conceivable outline shape or solid form. Also provided are a variety of special effects, such as patterned fills, gray-scale shading, a user-accessible print image model, and multiple page orientations and print directions within the same page.

PDF417 two-dimensional bar code— The printer includes the capability that allows the user to implement the two-dimensional stacked bar code symbology, PDF417, or Portable Data File 417. This expanded functionality is achieved by using the PRESCRIBE II language commands.

Automatic rotation of fonts and graphics— Images and scalable fonts are automatically rotated to match the page orientation.

A wide variety of internal symbol sets— The printer supports most Hewlett-Packard LaserJet 4 Plus compatible symbol sets for both bitmap and scalable fonts.

Display of printer messages in any of three languages— English, French, or German. As an option it is also possible to have the messages displayed in other languages. Please contact your Kyocera dealer.

Memory card slot for option fonts, macros, forms, etc.— Data in the memory card can be selectively read from the printer's control panel.

Simple Network Management Protocol (SNMP) compliance— Offers network managers complete open system network management.

Kyocera PrintMonitor (KPM)— Provides network wide management of the Kyocera FS family of laser printers. Please refer to the readme file located in the Kyocera Digital Library (included with the printer) for details.

Options

The following options are available for the printer.

DU-20	Duplexer
EF-1	Envelope Feeder
HS-3E	Bulk Paper Stacker
HS-20	Paper Handler/Stacker
IB-3	AppleTalk Interface Board
PA-1	Paper Path Adaptor
PA-20	Paper Path Adaptor
PC-20	Paper Cassette for PF-20 (universal size; adjustable to A5 through Legal sizes)
PC-21	Paper Cassette for the printer (available in A5, JIS B5, A4, Letter, or Letter/Legal size)
PF-7E	Bulk Paper Feeder
PF-20	Paper Feeder (A5, JIS B5, A4, Letter, Legal)
PF-20mini	Paper Feeder (A5, JIS B5, A4, Letter)
PK-series	KPDL Upgrade Kit
SO-6	Sorter/stacker
ST-20	Bulk Paper Stacker

Guide to the Manual

Unless specifically stated otherwise, information in this manual applies to printer models FS-1700/FS-3700. The printer illustrations and printed samples used in this manual are of the FS-3700.

Installation Manual

The *Installation Manual* guides you through the following topics:

- Installation
- Printer basic operation

CD-ROM (Kyocera Digital Library)

The CD-ROM supplied contains the printer User's Manual, PRESCRIBE II Programming Manual, and PDF417 Two Dimensional Bar Code Implementation Manual. To gain access to these documents, insert the CD-ROM into the appropriate drive and follow the instructions on the insert accompanying the CD-ROM. To view these documents, you need the Adobe Acrobat software installed in your computer. For details, read the instructions on the CD-ROM package.

The User's Manual guides you through topics concerning the operations and maintenance of the printer.

The PRESCRIBE II Programming Manual explains how to use the PRESCRIBE II commands in document files for formatting, and their parameters in detail for experienced users, using pictures and samples.

User's Manual (on CD-ROM):

- Installation
- Printer operation
- Control panel operations
- Fonts
- Maintenance and troubleshooting
- Symbol sets

PRESCRIBE II Programming Manual (on CD-ROM):

- PRESCRIBE II command reference
- Fonts
- Bar codes
- Printer permanent parameters
- Emulation

PDF417 Two Dimensional Bar Code Implementation Manual (on CD-ROM):

- PDF417 overview
- PRESCRIBE II commands for PDF417

Table of Contents

Chapter 1 Installing the Printer	1—1
1.1. Positioning the Printer	1—1
Clearance	1—1
Places to Avoid	1—1
Basic requirements	1—2
Power Supply	1—3
1.2. Unpacking and Inspection	1—3
List of shipped components	1—4
1.3. Names of Parts	1—5
Front View	1—5
Interior View	1—6
Rear View	1—6
1.4. Setting Up and Interfacing	1—7
1—Open the Top Cover	1—8
2—Install the Toner Container	1—8
3—Close the Top Cover	1—9
4—Install the Waste Toner Bottle	1—9
5—Add Paper	1—11
6—Open the Paper Stopper on the Face-down Output Tray	1—12
7—Install the Face-up Output Tray (if required)	1—12
8—Connect the Printer to the Computer	1—13
9—Attach the Power Cord	1—13
10—Print a Status Page	1—14
11—Test the Interface with the Computer	1—14
12—Set the Emulation Mode	1—14
13—Install the Printer Driver	1—15
1.5. Multi-Purpose Tray Feeding	1—17
Selecting the Multi-Purpose Tray	1—17
1.6. Memory Card	1—21
Handling Memory Cards	1—22
1.7. Memory Expansion Installation	1—23
Removing the Main Circuit Board	1—23
SIMM to be used	1—25
Installing and Removing SIMMs	1—26
Testing the Expansion Memory	1—27

Chapter 2 Operating the Laser Printer 2—1

2.1. Control Panel	2—1
Message Display	2—2
Interface Indicator	2—2
Resolution Indicator	2—2
Paper Size Indicator	2—3
Copy Indicator	2—3
Symbolic Indicators	2—4
Control Keys	2—5
2.2. Operating Procedures	2—6
Switching Power On	2—6
Stack Selection	2—6
Feed Selection	2—7
On-line/Off-line Setting	2—7
Abandoning a Printing Job	2—7
Status Printout	2—8
Form Feed	2—11
2.3. Using the Mode Select Menu	2—12
Mode Select Menu	2—12
2.4. Sleep (Ecopower) Mode	2—14
2.5. KIR Level	2—15
2.6. Ecoprint mode	2—16
2.7. Resource Protection	2—17
2.8. Adjusting the Print Density	2—17
2.9. Setting the Audio Warning (Buzzer)	2—18
2.10. Operating a Memory Card	2—20
Hints on Writing Fonts to the Memory Card	2—20
Reading Fonts/Data from a Memory Card	2—20
Writing Data to a Memory Card	2—21
Deleting Data from a Memory Card	2—22
Formatting a Memory Card	2—23
Printing a list of data names	2—24

Chapter 3 Fonts 3—1

3.1. Bitmap and Scalable Fonts	3—1
Bitmap fonts	3—2
Scalable fonts	3—2
3.2. List of Fonts	3—3
Bitmap Fonts	3—3
Scalable Fonts	3—3
Option Fonts	3—3
3.3. Symbol set	3—11

Chapter 4 Maintenance 4—1

4.1. Toner Kit Replacement	4—1
Toner Kit to be Used	4—1
Supplying Toner	4—2
Replace the Waste Toner Bottle	4—4
4.2. Cleaning	4—6
Main Charger Unit	4—6
Paper Feed Unit	4—8

Chapter 5 Troubleshooting 5—1

5.1. General Guide	5—1
5.2. Power Problems	5—2
5.3. Interface Problems	5—2
5.4. Print Quality Problems	5—3
Completely blank printout	5—3
All-black printout	5—3
Dropouts, horizontal streaks, stray dots	5—4
Black or white vertical streaks	5—4
Faint or blurred printing	5—5
Grey background	5—5
Dirt on the top edge or back of the paper	5—6
Characters out of position	5—6
5.5. Indicators and Messages	5—7
Indicators	5—7
Maintenance Messages	5—8
Error Messages	5—9
5.6. Correcting a Paper Jam	5—11

Chapter 6 Symbol Set Tables 6—1

6.1. IBM Symbol Sets 6—2

6.2. Diablo 630 Symbol Sets 6—8

6.3. LQ-850 Symbol Sets 6—11

6.4. HP LaserJet 4 Plus Symbol Sets 6—13

Appendix A Printer Specifications A—1

Appendix B Paper Selection B—1

B.1. General Guidelines B—1

 Paper Availability B—1

 Paper Specifications B—2

B.2. Selecting the Right Paper B—2

B.3. Special Paper B—5

 Overhead Projection (OHP) Film B—5

 Adhesive-Backed Labels B—6

Appendix C Host Computer Interface C—1

C.1. Parallel Interface C—1

 Parallel interface communication modes C—1

 Interface Signals C—2

C.2. RS-232C/RS-422A Interface C—5

 RS-232C interface C—5

 RS-422A interface C—6

C.3. RS-232C/RS-422A Protocol C—10

 PRESCRIBE II FRPO D0 command C—11

C.4. RS-232C Cable Connection C—12

 Preparing an RS-232C Cable C—12

 Connecting the Printer to the Computer C—12

Index Index—1

Mode Select Menu Last page

Feed Selection

The **FEED** key selects the paper feed cassette [Cassette] or multi-purpose tray [MP tray] (or the option paper feeder[s], if installed) as the paper source. The **FEED** key can be used whenever the message display indicates **Ready** or **Add paper** .

Press the **FEED** key. The selection cycles and is momentarily displayed in the message display as:

```
Cassette
MP tray
```

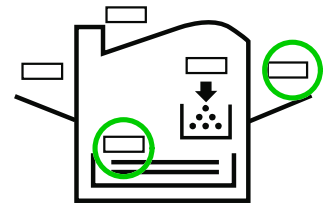

The current selection is indicated by a green light on the printer symbol above the key.

On-line/Off-line Setting

By pressing the **ON LINE** key you can change the printer between the on-line state, in which it prints the data it receives from the computer, and the off-line state, in which it stores the data for printing later.

1. Make sure that the message display indicates **Ready** .
2. Press the **ON LINE** key.

If the printer is on-line, it changes to off-line. If the printer is off-line, it changes back to on-line.

The ON LINE indicator lights when the printer is on-line.

Going off-line may or may not halt communication between the printer and computer, depending on details of the current interface. While off-line, the printer continues to accept any data that arrives until the current interface buffer is full, at which point it instructs the computer to stop sending data. Data stored while off-line are printed when the printer is returned to the on-line state.

Abandoning a Printing Job

You can abandon a printing job before it is completed. If the printer is simultaneously receiving data on more than one interface, you can selectively cancel the printing job on a particular interface.

This procedure can be used while the message display indicates **Processing** or **Waiting** .

1. Halt the printing program on the computer. The printer continues to print the data it has already received. It is a good idea to set the printer to off-line first.
2. Press the **CANCEL** key. The message display indicates `Print Cancel ?` and also the interface from which data is arriving, by the one of the following messages:

```
Parallel  
Serial  
Option
```

3. Press the **ENTER** key. This clears the printing job on the interface indicated on the message display.

 **If the printer is receiving data simultaneously on its interfaces, you must be sure which interface the job you wish to abandon is on. With `Print Cancel` indicated on the message display, press the **+** key repeatedly until the interface is displayed on the message display. Then, press the **ENTER** key to abandon the job.**

When a few pages have been printed out, the printer stops, ready to begin the next job.

 **If you do not stop the computer program first, after the printer executes the printing halt, it immediately starts printing again as it continues to receive data from the computer.**

Status Printout

If you want to check the printer's current status, including memory available, and option settings, you can find the information you need on the status page. To print out a status page, the printer must be on-line. Proceed as follows:

1. Make sure the message display indicates `Ready`.
2. Press the **STATUS** key. The printer prints a page of status information.

The message display indicates `Processing` during printing of the status page, then returns to `Ready`.

For a full description of the status page, see next page.

 **Items and values on the status page may vary depending on the printer model and printer's firmware version.**

SN: _____

PAGE	PRINTER	STATUS	PAGE
Software version		Released	
Current settings			
Current interface	PARALLEL	Emulation type	6
Font number	1	Codeset name	ISO-6 ASCII
Unit	Inches	Resolution (dpi)	600
Margins	Top 0.333	Line spacing	0.166
	Bottom 10.333	Character spacing	0.100
	Left 0.000	Pen width	0.010
	Right 8.000		
Interface dependent parameters			
--Environment--		--Parameters--	
User margins(inch)		RS232C/	PARALLEL
User top margin	A1 + A2/100	00.00	00.00
User left margin	A3 + A4/100	00.00	00.00
User page length	A5 + A6/100	13.61	13.61
User page width	A7 + A8/100	13.61	13.61
Font and orientation			
Default font number	C5*10000 + C2*100 + C3	00001	00001
Default font name	V3 (for scalable font)		
Default point size	V0*100 + V1 + V2/100	012.00	012.00
Default pitch	U8 + U9/100	10.00	10.00
Page orientation	C1	00	00
PCL font switch	C8	00	00
Emulation parameters			
Default emulation	P1	06	06
CR action/LF action	P2/P3	01/01	01/01
AES mode/Alt.emulation	P4/P5	00/06	00/06
AES option (1)/(2)	P7/P8	02/02	02/02
Line per inch	U0 + U1/100	06.00	06.00
Character per inch	U2 + U3/100	10.00	10.00
Country/Codeset number	U6/U7	00/00	00/00
Miscellaneous			
I/F release timeout	J2	06	06
Non interface dependent parameters			
--Environment--		--Parameters--	
Host interface		Option parameters	
Serial baud rate	H1 96	Default stacker	R0 01
Serial data bits	H2 08	Auto cassette	R1 00
Serial stop bits	H3 01	Default paper size	R2 00
Serial parity	H4 00	Reserved	R3 00
Protocol type	H5 00	Default cassette	R4 01
Xoff threshold(%)	H6 90	Page protect mode	R5 01
Xon threshold(%)	H7 70	Reserved	R6 00
Buffer size (*10 KB)	H8 06	Manual paper size	R7 08
F.F. timeout	H9 06	Daisywheel data bit	R8 07
Serial I/O control	D0 00	Envelope paper size	R9 00
Status send control	M1 00	Reserved	P0 00
Default interface	M2 02	Command recognition	P9 82
Buffer size option	M3 00	Status page print	U5 00
Buffer size rate (1)	M4 03	Reserved	C9 00
Buffer size rate (2)	M5 01	Partition name	I0
		Reserved	D1 00
		MPtray mode	T0 00
Standard parallel I/O	o0/o1/o2 70/01/00		
Default pattern switch	B8 00	Resolution	N8 01
		Resource protect	N9 00
Sleep timer	N5 06	Ecoprint mode	N6 00
Paper size error	D3 00	Paper type	T9 00
Print density	D4 03	Buzzer mode	D2 00
Memory allocation			
Total memory	2048 KB	User available	781 KB
Service information			
/0102/0123/1061/0811/	0/ 0/DN:		
/00/01/02/05/06/09/		Total page	1

Sample Status Page

1 — Firmware version information

The printer's firmware version number and release date.

2 — Current status information

This information gives the printer's temporary settings which are made by application or PRESCRIBE II commands or software. Note that this information pertains to the current interface only.

Emulation type is indicated by the one of the following numbers.

- 0-Line printer
- 1-IBM Proprinter X24E
- 2-Diablo 630
- 5-Epson LQ-850
- 6-HP LaserJet 4 Plus

3 — Interface-dependent parameters

By default, each one column for the serial and parallel interfaces appears on the status page and any changes in the settings affect the serial or parallel interface respectively. With an optional interface installed, a column for the option interface is also displayed.

These parameters may be set independently for each interface, i.e. changes made to the settings for one interface do not affect the other interface(s). Commands to change these settings affect the interface on which the command was received. Some of these settings may also be changed from the printer's front panel by first selecting the desired interface and then changing the setting. For more information on setting these parameters, see the *PRESCRIBE II Programming manual Chapter 5, Permanent Parameters*.

3a — Default font name (V3)

The power-up scalable font (if specified) for each interface is listed here. The example which follows indicates that the power-up scalable font is AudreyTwo-RegularSWC on the parallel interface.

Font and orientation			
Default font number	$C5*10000 + C2*100 + C3$	00001	00000
Default font name	V3 (for scalable font)	AudreyTwo-RegularSWC	3a

4 — Non interface dependent parameters

These parameters affect all interfaces simultaneously. Any changes made with these parameters may interfere with the jobs on the other interface(s).

5 — Memory allocation status

Total memory shows the total amount of memory installed in the printer, including the expanded memory, if installed. `User available` shows how much memory is available for storing information to be printed.

6 — Service information

This information is for service purposes.

7 — User defined font list

The second status page is a list of fonts (if any) and font information that has been downloaded from the computer.

In the example below, first three lines represent the numbers, font names (typefaces), and the sizes in kilobytes of three downloaded bitmap fonts. In line 4, you can see the Swiss742SWC-Bold font with font number 3000.

USER DEFINED FONTS			
Type	Number	Font Name	Size (KB)
Bitmap	50006	Swiss	18.00
Bitmap	50007	Symbol A Prop	21.50
Bitmap	50015	Dutch	15.75
Scalable	3000	Swiss742SWC-Bold	0.00

7

Form Feed

Depending on your software, there is sometimes a delay before the printer prints the last page of a job. This occurs when the printer is not informed by a code or command that the job is over.

If you wait a while, the printer will eventually time out and print the last page. If you do not want to wait, you can obtain the page immediately by pressing the **FORM FEED** key.

The **FORM FEED** key can be used when the printer is on-line and the message display indicates Waiting. The **FORM FEED** key does not operate while the printer is off-line. Form feed effects only the current interface. It will not feed out a page that may be in the other interface's buffer.

 **Most application software sends the end-of-job command automatically. Pressing the FORM FEED key in the middle of a printing job may cause an unexpected page break and other printing errors.**

2.3. Using the Mode Select Menu

This section explains how to use the **MODE** key on the control panel. The **MODE** key allows you to set or change the printer environment such as the number of copies to make, emulation, page orientation, code set, etc. to your specific needs.

The following items can be selected by using the **MODE**, **+** and **-**, and **ENTER** keys. Also, the diagram on the last page in this manual gives a quick reference to the full options and the sequence of selection.

Mode Select Menu

Item	Function	Default Setting
Interface >	Selects the interface on which the control panel settings are effective. This setting affects only the currently active interface. Parallel setting has a sub item in which one of three data transmission modes can be selected — Auto, Normal, or High speed Serial setting has five sub items, and sets the following RS-232C/RS-422A parameters: Baud rate Data bits Stop bits Parity Protocol	Parallel Auto 9600 8 1 None DTR(pos.)&XON
Number of copies	Sets the number of copies to be printed.	001
Emulation >	Changes the emulation mode on the current interface. The ► key allows access to sub item >Code set.	HP LJ 4Plus
Font >	Selects the bitmap or scalable font for the current interface. Sub items allow selection of typefaces and scaling of the scalable font.	Bitmap
Page orientation	The + and - keys toggle between portrait and landscape page orientations.	Portrait
Opt. ROM >	Reads information from the option ROM installed in the printer's main board.	—
MEMORY CARD >	Reads or writes data from or to an memory card in the printer's memory card slot. Also, this menu allows deletion of data from an memory card; and formatting the memory card.	—

Item	Function	Default Setting
MP tray mode >	Selects the multi-purpose tray mode from first, cassette, or manual. The ► key allows access to submenu >MP tray size , selects the size of multi-purpose tray.	First A4 or Letter
Envelope size	Selects the size of envelope for the optional envelope feeder.	DL or Business
Bulk feeder size	Selects the size of paper for the optional bulk paper feeder.	A4 or Letter
Paper type	Selects the paper type for printing — Normal (60 -90 g/m ²) or Thick (90-200 g/m ²) . We recommend that is fed from the Multi-purpose tray and printed paper output to the Face-up tray.	Normal
Duplex mode	Selects the binding mode for duplex printing —short-edge or long-edge binding.	None
Sorter mode >	Selects the sorter mode from stacker, collator, sorter, and mail box modes.	Stacker
Auto cassette	Selects one of the automatic paper cassette switching modes. Only available when the printer is installed with the optional paper feeder (PF -20/PF-20mini).	None
Others >	By pressing the ► (FORM FEED) key and + and - keys, the following settings can be made: To set the formfeed time-out time and sleep timer time-out time; to print in hexadecimal dump mode; to print a list of resident fonts; to reset the printer; to set the linefeed and carriage-return action, panel keep mode, and the message language; to read the total pages printed; to optimize the KIR level, and to set the Ecoprint mode, and the resource protection mode; optimize printing resolution; to adjust the print density .	—

 : These items are available only when the printer is installed with the applicable option unit/kit.

For items with the > mark on the message display, the ► (FORM FEED) key lets you go down to the sub items which give access to more items to change the relevant settings.

2.4. Sleep (Ecopower) Mode

The printer has a sleep timer to conserve power when the printer is not printing, processing, or receiving data. You can adjust the timer value, the length of time the printer waits before entering sleeping mode in the absence of data.

Any value from 0 to 120 [minutes] (the factory setting is 30 [minutes]) can be entered in 5-minute increments. You can use the ◀ or ▶ key to move the cursor back and forth through the figures to rapidly set a large value.

If the printer receives no data for the period adjusted as above, it times out and enters into sleeping mode, indicating `Sleeping` on the message display. When you send data for printing to the printer again or press a key on the control panel, the printer starts warming up, indicating `Please wait`, and becomes ready and on-line.

Opening and closing the printer's top cover or drawing out and closing the current paper cassette also awakens the printer to start warming up and become ready.

The printer also enters into sleeping mode if it times out while `MODE SELECTing`, or requesting the addition of paper or toner, indicating the appropriate maintenance message on its message display.

2.5. KIR Level

This printer incorporates the KIR (Kyocera Image Refinement) smoothing function. KIR provides high quality printing by providing a software-type improvement to the resolution. Three different types of KIR level can be selected.

You can print a KIR test pattern to see how the current KIR setting works. To print a test pattern, follow *Mode Select Menu* on the last page of this manual.

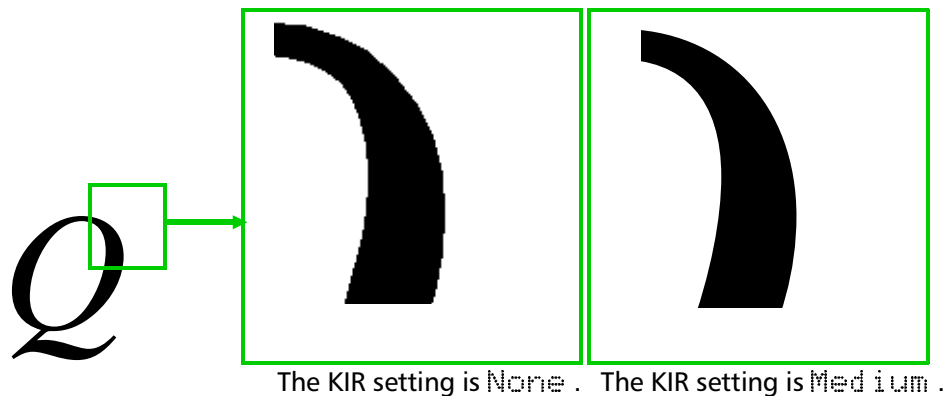

 To ensure the optimum KIR setting, the print density must be set to "03" using the printer's MODE SELECT.

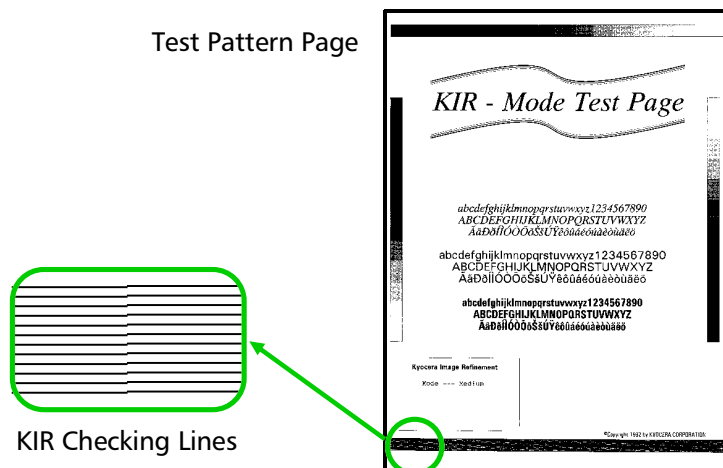

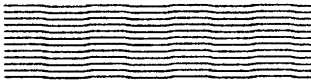

Optimized stripes

The current KIR setting is optimal.

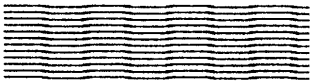

Dark vertical stripes

Set the KIR mode to **Light** or **Medium** . Try printing the test pattern again. If you still get dark vertical stripes, adjust the print density control to a lighter setting. (See the last page in this manual.)



White vertical stripes

Set the KIR mode to **Medium** or **Dark** . Try printing the test pattern again. If you still get white vertical stripes, adjust the print density control to a darker setting. (See the last page in this manual.)

2.6. Ecoprint mode

The Ecoprint enables you to reduce the amount of toner consumed on the page so as to save your printing costs. You can set to Ecoprint mode on, as follows. (The factory-setting is off .)

The Ecoprint mode setting is On when the printing image becomes lighter, yet very readable.

 **The Ecoprint setting has no effect on the print speed.**

A large, bold, black serif capital letter 'E'.

Ecoprint setting is Off (default).

A large, light gray serif capital letter 'E'.

Ecoprint setting is On .

2.7. Resource Protection

When you switch from the HP LaserJet emulation to another, all downloaded fonts and macros are lost. Resource protection preserves these PCL resources in memory so that they are intact when you change the emulation back to HP LaserJet 4 Plus.

By using the printer's MODE SELECT, you can select from two resource protection modes as follows:

```
>Resource prot.
  Permanent
```

In this mode, the printer stores fonts, macros, symbol sets, etc. in memory that were downloaded as permanent PCL resources. All temporary resources are lost when the emulation mode is changed from HP LaserJet 4 Plus to another or vice versa.

```
>Resource prot.
  Perm / Temp
```

In this mode, the printer stores both permanent and temporary resources when the emulation mode is changed from HP LaserJet 4 Plus to another or vice versa.

 **Resource protection requires extra memory to store the downloaded fonts and macros. The total size of the printer memory recommended for using the resource protection option is affected by several factors. See section 1.7. *Memory Expansion Installation*.**

2.8. Adjusting the Print Density

If necessary, the print density can be adjusted from the MODE SELECT MENU. The required print density can be selected from five different steps (01 - 05). The factory setting is 03, and there is normally no need to alter this setting.

When using the KIR function, please use the "03" setting.

2.9. Setting the Audio Warning (Buzzer)

In addition to the message displayed when the paper supply is exhausted, or when paper jamming occurs, an audio warning is made to sound. This is useful, for example, when the printer is in a location some distance from the user.

The audio alarm is set to ON when leaving the factory. An audio alarm corresponding to the type of printer error will sound according to the table below. If the alarm is set to OFF, it is made not to sound.

Type of Error and Corresponding Audio Alarm (Buzzer)

Priority	Error Message	Alarm Frequency	Remarks
		Short beeps: approx. 0.8 s Long beeps: approx. 0.4 s	
High  Low	Replace Toner Clean printr	short beeps	—
	Replace waste- toner bottle	short beeps	—
	Clean printer .. Press CONT	short beeps	—
	Paper jam	short beeps	—
	Face-down tray paper full	short beeps	*
	Option stacker paper full	short beeps	**
	Remove Opt. Stacker paper	short beeps	**
	Paper path error	short beeps	**
	Memory overflow .. Press CONT	short beeps	—
	Print overrun .. Press CONT	short beeps	—
	KPDL error .. Press CONT	short beeps	**
	MEMORYCARD err .. Press CONT	short beeps	**
	Opt. ROM error .. Press CONT	short beeps	**
	Set paper Press CONT	short beeps	—
	Load paper	short beeps	—
	Add paper	long beeps	—

* Model FS-3700 only

** These error messages are displayed if the relevant option is fitted.

The alarm will continue to sound while the error condition continues (if the printer is in the sleep mode, the alarm will be silent for that period alone). The alarm will cease to sound, however, when the **CANCEL** key is pressed.

To rectify the various error conditions listed above, please refer to *Chapter 5* of this manual, or to the operating manuals accompanying the various optional equipment.

-  ◆ **If you wish to cancel the data being processed while the audio alarm is sounding, press the CANCEL key twice. Firstly, the audio alarm will be turned OFF, and then the data processing will be canceled.**
- ◆ **After the audio alarm has been set to ON, even if the PRESCRIBE II FRPO INIT command is executed, the printer will not return to the initial (OFF) alarm setting. To set the audio alarm to OFF, reset using the mode selector menu from the control panel.**

2.10. Operating a Memory Card

Hints on Writing Fonts to the Memory Card

Some memory card writer utility programs are available for writing data to the memory card. If you write fonts into a memory card, we recommend you write them as font data and not as host data. Fonts written in a memory card as font data are automatically loaded in the printer when it is switched on and are usable on all the printer interfaces simultaneously. The printer reads only the header part of these fonts into its memory and therefore these fonts do not occupy a large area in the printer's memory.

If you write the fonts in the memory card as host data, the fonts are transferred directly from the memory card into the printer's memory when the card is read. This may require extra memory to be installed in the printer as they usually occupy a great amount of the printer's memory. Moreover, use of the fonts is restricted on only the interface that was active during the fonts were read from the memory card.

To properly write font data into the memory card, refer to the memory card writer manufacturer's instructions.

Reading Fonts/Data from a Memory Card

If the memory card is already inserted in the slot when the printer is powered on, the fonts are automatically read into the printer. To reread the fonts from a memory card, use the `>Read fonts` function.

-  **The PRESCRIBE II FRPO I0 command specifies the name of the partition in the memory card to be read automatically at power up. See *PRESCRIBE II Programming Manual, Chapter 5* .**

Writing Data to a Memory Card

A memory card can hold up to 127 data partition names, depending on its capacity. When writing to the card, a name is assigned automatically. You can use the procedure later in this section to print a list of data names for confirmation.

 **You cannot write font data to a memory card with the printer.**

To write data to a memory card, proceed as follows.

First check that the memory card can be writable (that the memory card is properly formatted, not write-protected, and its internal battery is not exhausted, for example). Otherwise, the `>Write data` message to be explained below will not be shown on the message display.

 **If the card inserted in the memory card slot is not formatted, the `>Format` option will automatically appear on the display. Refer to *Formatting a memory card* which follows this section and format the memory card.**

1. With the message display showing `>Write data`, press the **ENTER** key. A blinking question mark will appear as follows:

```
>Write data ?
```

2. Press the **ENTER** key. The message display changes to show `Processing`, then to `Waiting`. If you want to abandon writing, press the **CANCEL** key.
3. In this state, send the file from the computer to the printer as in the example below.

Example:

To send the file (data) `TEST.TXT` on drive C, enter the following at the DOS prompt (C:\):

```
COPY TEST.TXT PRN
```

The file is written onto the memory card given a destination name (also referred to as a *partition name*) which the printer automatically assigns one after another as follows:

```
DataS001 (first data), DataS002 (second data), DataS003 (third data),  
... DataS127 (last data)
```

In the example above, if the file `TEST.TXT` is the first data to be written onto the memory card, the destination name will be `DataS001`.

By using the PRESCRIBE II ICCD (read/write memory card) command to write data to a memory card, you can change the destination name to be the same as the original name or any other name you desire.

As the printer receives data, the message display changes to `Processing`, then when the end of the data is received, the message display changes to `Waiting`.

4. Check that the message display has changed to `Waiting`, then press the **▶ (FORM FEED)** key. This writes the file to the memory card and instructs the printer to automatically print out a memory card write information page as shown below.

```

                                MEMORY CARD WRITE INFORMATION
                                -----
Slot number      : A
Data Type       : 2/Data
Partition name  : DataS003   /System define
Write data length : 00001704
Others          :
```

Data type. Type of data written (currently only type 2 is supported).

Partition (data) name. The destination name of data written to the card.

Write data length. The size of the written data on the memory card in bytes.

Others. Error information.

When the memory card write information page is printed, the message display returns to `Ready`.

If the writing was not completed successfully, an error code appears on the message display. For details, see Section 5.5. *Indicators and Messages*. If this happens, press the **CONT** key. The message display returns to `Ready`.

5. Repeat above steps until you have transferred all data (files) that you want to write to the memory card. Each time you finish writing data, a memory card write information page is printed from the printer showing the information explained in step 4 above, but pertaining only to the data just written. To see all data contained in the memory card at once, print a list of data names as explained on the last page of this manual.

Deleting Data from a Memory Card

It is possible to use the printer to delete data from a memory card one by one.

First check that the memory card is writable (for example that the memory card is not write-protected, data exists on the card, and its internal battery is not exhausted). Otherwise, the `>Delete data` menu will not be shown on the message display.

When the deletion is completed, the printer automatically prints out a memory card status page as shown on page 2-24.

Formatting a Memory Card

Formatting allows data to be written to the card. A new memory card must be formatted before it can be used in the printer.

 **Formatting destroys any existing data on the memory card.**

First check that the memory card is writable (for example that the memory card is not write-protected, and its internal battery is not exhausted).

When the formatting operation is successfully completed, the printer automatically prints out a formatting information page as shown below.

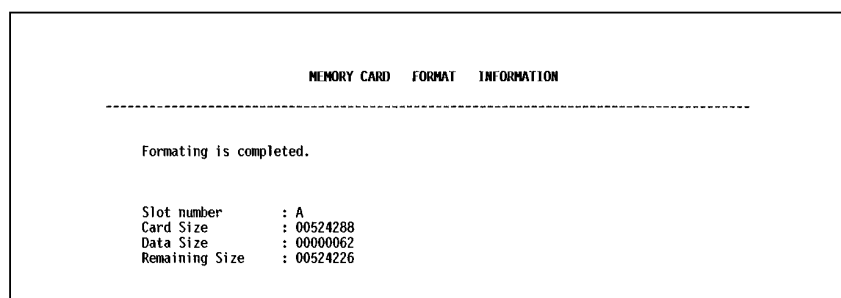

Card size. The total size of the memory card memory in bytes.

Data size. The size the printer uses for its system in bytes.

Remaining size. The size remaining in the memory card for storing data in bytes.

Printing a list of data names

The printer prints a list of all data names (referred to as *partitions*) stored in a memory card for reference. (Printing a list is also available for a font card.)

MEMORY CARD STATUS PAGE				
--Partition--	--Name--	--Size--	--Type--	--Slot--
1	DataS001	1980	Data	A
2	DataS002	32	Data	A
3	DataS003	1704	Data	A

-- Card Size --	-- Data Size --	-- Remaining Size --
A: 00524288	A: 00003992	A: 00520296

Current terminate string: WRED

The printout (example above) includes the following information.

Partition (data) number. Reference number for each written data.

Name. The destination name of the written data as assigned automatically by the printer.

Size. The size of the written data in bytes.

Type. The type of the written data i.e., whether it is host data (Data) or font data (Font).

Card size. The total capacity of the memory card in bytes.

Data size. The total size of the data stored in the memory card in bytes.

Remaining size. The size of the capacity remaining in the memory card for storing further data, including the amount of memory that the printer uses for its system (approximately 70 bytes).

Current terminating string. The PRESCRIBE II command that terminates a writing operation when writing to memory card using the PRESCRIBE II ICCD command; usually WRED.

Chapter 3

Fonts

This chapter describes the types of fonts you can use with the printer, including the printer's resident and KPD L fonts (option), and symbol sets.

3.1. Bitmap and Scalable Fonts

A font is a set of characters of a particular design. The design is referred to as a *typeface*. Several characteristics identify a font. These include the font type (bit map or scalable), symbol set, spacing, pitch, height, style, stroke weight, and typeface family.

The printer provides two types of resident fonts: *bitmap* fonts and *scalable* (outline) *fonts*. Also, fonts may be downloaded to the printer's memory from a memory card or disk. These fonts are referred to as *downloadable* or *soft* fonts. The printer accepts as many downloadable fonts as its user available memory permits.

Bitmap fonts

A bitmap font is made of a fixed bit pattern (Figure 3.1.). This pattern is stored in a special format for use in the printer. Bitmap fonts have a fixed height (size) for each character. Therefore, different font sets are required for different font sizes. For example, *Dutch801BM10-Roman* is a 10-point font and *Dutch801BM8-Roman* is an 8-point font.

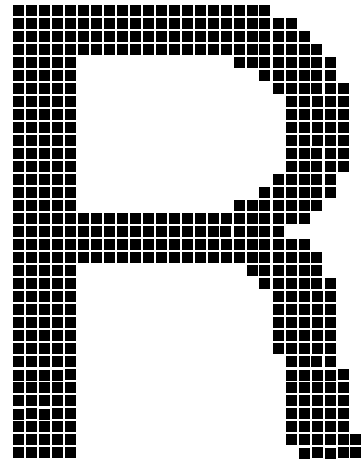

Figure 3.1. Bitmap Font Character

Scalable fonts

Scalable fonts provide the outline of the characters (Figure 3.2.). This outline is scaled according to the scaling information from the computer and filled in for printing. Depending on the capabilities of the software you use, the scalable fonts can be scaled from 0.25 point to 999.75 points in quarter point increments.

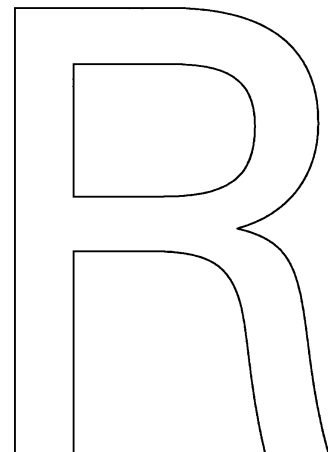

Figure 3.2. Scalable Font Character

3.2. List of Fonts

This section contains a full list of the printer's resident fonts. You can print the same font list from the printer by using the printer's control panel key. To print a list of fonts, refer to *Mode Select Menu , List of Resident fonts*.

Bitmap Fonts

The printer has 79 resident bitmap fonts. Note that all resident bitmap fonts include the letters BM in the typeface name.

Scalable Fonts

The printer has 45 resident scalable fonts. These fonts include the letters SWC or SWM in the typeface name and are equivalent to HP LaserJet 4 Plus fonts.

Option Fonts

You can install any of the KPDL option fonts.

KPDL fonts

The PostScript Type 1 compatible KPDL fonts are available when the printer is installed with the KPDL (Kyocera Page Description Language: Kyocera's version of PostScript) KPDL upgrade kit (PK-series).

Resident Bitmap Fonts (1)

KYOCERA PAGE PRINTER RESIDENT BITMAP FONT LIST			
Typeface [SFNT]	Selection [FSET] Print Sample	Font Number [FONT] (Port. - Land.)	Points/CPI
SFNT "CourierBM12-Roman";	FSET 0p10.0h12.0v0s0b3T; ABCDabcd\$%&0123ÃãÐðíêôúáé{ }~¼½	1 - 17	12.0/10.0
SFNT "Dutch801BM10-Roman";	FSET 1p10v0s0b5T; ABCDabcd\$%&0123ÃãÐðíêôúáé{ }~¼½	2 - 19	10/Prop.
SFNT "Dutch801BM10-Italic";	FSET 1p10v1s0b5T; ABCDabcd\$%&0123ÃãÐðíêôúáé{ }~¼½	3 - 20	10/Prop.
SFNT "Dutch801BM10-Bold";	FSET 1p10v0s3b5T; ABCDabcd\$%&0123ÃãÐðíêôúáé{ }~¼½	4 - 21	10/Prop.
SFNT "Dutch801BM8-Roman";	FSET 1p8v0s0b5T; ABCDabcd\$%&0123ÃãÐðíêôúáé{ }~¼½	5 - 22	8/Prop.
SFNT "PrestigeEliteBM10-Roman";	FSET 0p12.0h10v0s0b8T; ABCDabcd\$%&0123ÃãÐðíêôúáé{ }~¼½	6 - 23	10/12.0
SFNT "PrestigeEliteBM7.2-Roman";	FSET 0p16.67h7.2v0s0b8T; ABCDabcd\$%&0123ÃãÐðíêôúáé{ }~¼½	7 - 25	7.2/16.67
SFNT "LetterGothicBM12-Roman";	FSET 0p12.0h12.0v0s0b6T; ABCDabcd\$%&0123ÃãÐðíêôúáé{ }~¼½	8 - 26	12.0/12.0
SFNT "LetterGothicBM12-Bold";	FSET 0p12.0h12.0v0s3b6T; ABCDabcd\$%&0123ÃãÐðíêôúáé{ }~¼½	9 - 28	12.0/12.0
SFNT "Swiss721BM14.4-Bold";	FSET 1p14.4v0s3b4T; ABCDabcd\$%&0123ÃãÐðíêôúáé{ }~¼½	10 - 29	14.4/Prop.
SFNT "Swiss721BM12-Bold";	FSET 1p12.0v0s3b4T; ABCDabcd\$%&0123ÃãÐðíêôúáé{ }~¼½	11 - 30	12.0/Prop.
SFNT "Swiss721BM10-Bold";	FSET 1p10v0s3b4T; ABCDabcd\$%&0123ÃãÐðíêôúáé{ }~¼½	12 - 31	10/Prop.
SFNT "Swiss721BM8-Roman";	FSET 1p8v0s0b4T; ABCDabcd\$%&0123ÃãÐðíêôúáé{ }~¼½	13 - 32	8/Prop.
SFNT "Swiss721BM6-Roman";	FSET 1p6.0v0s0b4T; ABCDabcd\$%&0123ÃãÐðíêôúáé{ }~¼½	14 - 33	6.0/Prop.
SFNT "LinePrinterBM9-Roman";	FSET 0p16.67h9v0s0b0T; ABCDabcd\$%&0123ÃãÐðíêôúáé{ }~¼½	15 - 34	9/16.67
SFNT "LinePrinterBM7-Roman";	FSET 0p21.43h7.0v0s0b0T; ABCDabcd\$%&0123ÃãÐðíêôúáé{ }~¼½	16 - 36	7.0/21.43
SFNT "CourierBM12-Italic";	FSET 0p10.0h12.0v1s0b3T; ABCDabcd\$%&0123ÃãÐðíêôúáé{ }~¼½	37 - 18	12.0/10.0
SFNT "CourierBM12-Bold";	FSET 0p10.0h12.0v0s3b3T; ABCDabcd\$%&0123ÃãÐðíêôúáé{ }~¼½	38 - 67	12.0/10.0
SFNT "CourierBM12-BoldItalic";	FSET 0p10.0h12.0v1s3b3T; ABCDabcd\$%&0123ÃãÐðíêôúáé{ }~¼½	39 - 68	12.0/10.0
SFNT "Dutch801BM10-BoldItalic";	FSET 1p10v1s3b5T; ABCDabcd\$%&0123ÃãÐðíêôúáé{ }~¼½	40 - 69	10/Prop.

Resident Bitmap Fonts (2)

Typeface [SFNT]	Selection [FSET] Print Sample	Font Number [FONT] (Port. - Land.)	Points/CPI
SFNT "Dutch801BM8-Italic";	FSET 1p8v1s0b5T; <i>ABCDabcd\$%&0123ÃÄĐİêôúáé{ } ~ ¼½</i>	41 - ***	8/Prop.
SFNT "Dutch801BM8-Bold";	FSET 1p8v0s3b5T; ABCDabcd\$%&0123ÃÄĐİêôúáé{ } ~ ¼½	42 - 70	8/Prop.
SFNT "Dutch801BM8-BoldItalic";	FSET 1p8v1s3b5T; <i>ABCDabcd\$%&0123ÃÄĐİêôúáé{ } ~ ¼½</i>	43 - ***	8/Prop.
SFNT "PrestigeEliteBM10-Italic";	FSET 0p12.0h10v1s0b8T; <i>ABCDabcd\$%&0123ÃÄĐİêôúáé{ } ~ ¼½</i>	44 - 24	10/12.0
SFNT "PrestigeEliteBM10-Bold";	FSET 0p12.0h10v0s3b8T; ABCDabcd\$%&0123ÃÄĐİêôúáé{ } ~ ¼½	45 - 71	10/12.0
SFNT "PrestigeEliteBM10-BoldItalic";	FSET 0p12.0h10v1s3b8T; <i>ABCDabcd\$%&0123ÃÄĐİêôúáé{ } ~ ¼½</i>	46 - 72	10/12.0
SFNT "PrestigeEliteBM7.2-Italic";	FSET 0p16.67h7.2v1s0b8T; <i>ABCDabcd\$%&0123ÃÄĐİêôúáé{ } ~ ¼½</i>	47 - ***	7.2/16.67
SFNT "PrestigeEliteBM7.2-Bold";	FSET 0p16.67h7.2v0s3b8T; ABCDabcd\$%&0123ÃÄĐİêôúáé{ } ~ ¼½	48 - 73	7.2/16.67
SFNT "PrestigeEliteBM7.2-BoldItalic";	FSET 0p16.67h7.2v1s3b8T; <i>ABCDabcd\$%&0123ÃÄĐİêôúáé{ } ~ ¼½</i>	49 - ***	7.2/16.67
SFNT "LetterGothicBM12-Italic";	FSET 0p12.0h12.0v1s0b6T; <i>ABCDabcd\$%&0123ÃÄĐİêôúáé{ } ~ ¼½</i>	50 - 27	12.0/12.0
SFNT "LetterGothicBM12-BoldItalic";	FSET 0p12.0h12.0v1s3b6T; <i>ABCDabcd\$%&0123ÃÄĐİêôúáé{ } ~ ¼½</i>	51 - 79	12.0/12.0
SFNT "Swiss721BM14.4-BoldItalic";	FSET 1p14.4v1s3b4T; <i>ABCDabcd\$%&0123ÃÄĐİêôúáé{ } ~ ¼½</i>	52 - ***	14.4/Prop.
SFNT "Swiss721BM12-BoldItalic";	FSET 1p12.0v1s3b4T; <i>ABCDabcd\$%&0123ÃÄĐİêôúáé{ } ~ ¼½</i>	53 - ***	12.0/Prop.
SFNT "Swiss721BM10-BoldItalic";	FSET 1p10v1s3b4T; <i>ABCDabcd\$%&0123ÃÄĐİêôúáé{ } ~ ¼½</i>	54 - ***	10/Prop.
SFNT "Swiss721BM8-Italic";	FSET 1p8v1s0b4T; <i>ABCDabcd\$%&0123ÃÄĐİêôúáé{ } ~ ¼½</i>	55 - ***	8/Prop.
SFNT "Swiss721BM8-Bold";	FSET 1p8v0s3b4T; ABCDabcd\$%&0123ÃÄĐİêôúáé{ } ~ ¼½	56 - 74	8/Prop.
SFNT "Swiss721BM8-BoldItalic";	FSET 1p8v1s3b4T; <i>ABCDabcd\$%&0123ÃÄĐİêôúáé{ } ~ ¼½</i>	57 - ***	8/Prop.
SFNT "Swiss721BM6-Italic";	FSET 1p6.0v1s0b4T; <i>ABCDabcd\$%&0123ÃÄĐİêôúáé{ } ~ ¼½</i>	58 - ***	6.0/Prop.
SFNT "Swiss721BM6-Bold";	FSET 1p6.0v0s3b4T; ABCDabcd\$%&0123ÃÄĐİêôúáé{ } ~ ¼½	59 - 75	6.0/Prop.
SFNT "Swiss721BM6-BoldItalic";	FSET 1p6.0v1s3b4T; <i>ABCDabcd\$%&0123ÃÄĐİêôúáé{ } ~ ¼½</i>	60 - ***	6.0/Prop.

Resident Bitmap Fonts (3)

KYOCERA PAGE PRINTER RESIDENT BITMAP FONT LIST			
Typeface [SFNT]	Selection [FSET] Print Sample	Font Number [FONT] (Port. - Land.)	Points/CPI
SFNT "LinePrinterBM9-Italic";	FSET 0p16.67h9v1s0b0T; ABCDabcd\$%&0123ÄåÐðíêöûäé{ }~¼½	61 - 35	9/16.67
SFNT "LinePrinterBM9-Bold";	FSET 0p16.67h9v0s3b0T; ABCDabcd\$%&0123ÄåÐðíêöûäé{ }~¼½	62 - 76	9/16.67
SFNT "LinePrinterBM9-BoldItalic";	FSET 0p16.67h9v1s3b0T; ABCDabcd\$%&0123ÄåÐðíêöûäé{ }~¼½	63 - 77	9/16.67
SFNT "LinePrinterBM7-Italic";	FSET 0p21.43h7.0v1s0b0T; ABCDabcd\$%&0123ÄåÐðíêöûäé{ }~¼½	64 - ***	7.0/21.43
SFNT "LinePrinterBM7-Bold";	FSET 0p21.43h7.0v0s3b0T; ABCDabcd\$%&0123ÄåÐðíêöûäé{ }~¼½	65 - 78	7.0/21.43
SFNT "LinePrinterBM7-BoldItalic";	FSET 0p21.43h7.0v1s3b0T; ABCDabcd\$%&0123ÄåÐðíêöûäé{ }~¼½	66 - ***	7.0/21.43
SFNT "LinePrinterBM8.5-Roman";	FSET 0p16.67h8.5v0s0b0T; ABCDabcd\$%&0123ÄåÐðíêöûäé{ }~¼½	88 - ***	8.5/16.67

Resident Scalable Fonts (1)

KYOCERA PAGE PRINTER RESIDENT SCALABLE FONT LIST	
Typeface [SFNT]	Selection [FSET] Print Sample
SFNT "AudreyTwo-RegularSWC";	FSET 1p##v0s0b4297T; ABCDabcd\$%&0123ÃãÐðíêôúáé{ }~¼½
SFNT "Clarendon-CondensedSWC";	FSET 1p##v4s3b4140T; ABCDabcd\$%&0123ÃãÐðíêôúáé{ }~¼½
SFNT "Courier-BoldItalicSWC";	FSET 0p##h1s3b4099T; ABCDabcd\$%&0123ÃãÐðíêôúáé{ }~¼½
SFNT "Courier-BoldSWC";	FSET 0p##h0s3b4099T; ABCDabcd\$%&0123ÃãÐðíêôúáé{ }~¼½
SFNT "Courier-ItalicSWC";	FSET 0p##h1s0b4099T; ABCDabcd\$%&0123ÃãÐðíêôúáé{ }~¼½
SFNT "Courier-SWC";	FSET 0p##h0s0b4099T; ABCDabcd\$%&0123ÃãÐðíêôúáé{ }~¼½
SFNT "Dutch801-BoldItalicSWM";	FSET 1p##v1s3b16901T; ABCDabcd\$%&0123ÃãÐðíêôúáé{ }~¼½
SFNT "Dutch801-BoldSWM";	FSET 1p##v0s3b16901T; ABCDabcd\$%&0123ÃãÐðíêôúáé{ }~¼½
SFNT "Dutch801-ItalicSWM";	FSET 1p##v1s0b16901T; ABCDabcd\$%&0123ÃãÐðíêôúáé{ }~¼½
SFNT "Dutch801-RomanSWM";	FSET 1p##v0s0b16901T; ABCDabcd\$%&0123ÃãÐðíêôúáé{ }~¼½
SFNT "Dutch801SWC-Bold";	FSET 1p##v0s3b4101T; ABCDabcd\$%&0123ÃãÐðíêôúáé{ }~¼½
SFNT "Dutch801SWC-BoldItalic";	FSET 1p##v1s3b4101T; ABCDabcd\$%&0123ÃãÐðíêôúáé{ }~¼½
SFNT "Dutch801SWC-Italic";	FSET 1p##v1s0b4101T; ABCDabcd\$%&0123ÃãÐðíêôúáé{ }~¼½
SFNT "Dutch801SWC-Roman";	FSET 1p##v0s0b4101T; ABCDabcd\$%&0123ÃãÐðíêôúáé{ }~¼½
SFNT "Flareserif821-ExtraBoldSWC";	FSET 1p##v0s4b4362T; ABCDabcd\$%&0123ÃãÐðíêôúáé{ }~¼½
SFNT "Flareserif821-RomanSWC";	FSET 1p##v0s1b4362T; ABCDabcd\$%&0123ÃãÐðíêôúáé{ }~¼½
SFNT "Incised901SWC-Black";	FSET 1p##v0s3b4168T; ABCDabcd\$%&0123ÃãÐðíêôúáé{ }~¼½
SFNT "Incised901SWC-Italic";	FSET 1p##v1s0b4168T; ABCDabcd\$%&0123ÃãÐðíêôúáé{ }~¼½
SFNT "Incised901SWC-Roman";	FSET 1p##v0s0b4168T; ABCDabcd\$%&0123ÃãÐðíêôúáé{ }~¼½
SFNT "LetterGothic-BoldSWC";	FSET 0p##h0s3b4102T; ABCDabcd\$%&0123ÃãÐðíêôúáé{ }~¼½

Resident Scalable Fonts (2)

KYOCERA PAGE PRINTER RESIDENT SCALABLE FONT LIST	
Typeface [SFNT]	Selection [FSET] Print Sample
SFNT "LetterGothic-ItalicSWC";	FSET Op##h1s0b4102T; ABCDabcd\$%&0123ÃāĐđİēôûáé{ }~¼½
SFNT "LetterGothic-SWC";	FSET Op##h0s0b4102T; ABCDabcd\$%&0123ÃāĐđİēôûáé{ }~¼½
SFNT "MoreWingbats-RegularSWM";	CSET 579L;FSET 1p##v0s0b31402T; ☺☻☼☽☿♁♂♃♅♇♈♉♊♋♌♍♎♏♐♑♒♓♔♕♖♗♘♙♚♛♜♝♞♟♠♡♢♣♤♥♦♧♨♩♪♫♬♭♮♯♰♱♲♳♴♵♶♷♸♹♺♻♼♽♾♿♿
SFNT "OriginalGaramondSWC-Bold";	FSET 1p##v0s3b4197T; ABCDabcd\$%&0123ÃāĐđİēôûáé{ }~¼½
SFNT "OriginalGaramondSWC-BoldItalic";	FSET 1p##v1s3b4197T; ABCDabcd\$%&0123ÃāĐđİēôûáé{ }~¼½
SFNT "OriginalGaramondSWC-Italic";	FSET 1p##v1s0b4197T; ABCDabcd\$%&0123ÃāĐđİēôûáé{ }~¼½
SFNT "OriginalGaramondSWC-Roman";	FSET 1p##v0s0b4197T; ABCDabcd\$%&0123ÃāĐđİēôûáé{ }~¼½
SFNT "Ribbon131-RomanSWC";	FSET 1p##v1s0b4116T; ABCDabcd\$%&0123ÃāĐđİēôûáé{ }~¼½
SFNT "Swiss721-BoldObliqueSWM";	FSET 1p##v1s3b16602T; ABCDabcd\$%&0123ÃāĐđİēôûáé{ }~¼½
SFNT "Swiss721-BoldSWM";	FSET 1p##v0s3b16602T; ABCDabcd\$%&0123ÃāĐđİēôûáé{ }~¼½
SFNT "Swiss721-ObliqueSWM";	FSET 1p##v1s0b16602T; ABCDabcd\$%&0123ÃāĐđİēôûáé{ }~¼½
SFNT "Swiss721-SWM";	FSET 1p##v0s0b16602T; ABCDabcd\$%&0123ÃāĐđİēôûáé{ }~¼½
SFNT "Swiss742SWC-Bold";	FSET 1p##v0s3b4148T; ABCDabcd\$%&0123ÃāĐđİēôûáé{ }~¼½
SFNT "Swiss742SWC-BoldCondensed";	FSET 1p##v4s3b4148T; ABCDabcd\$%&0123ÃāĐđİēôûáé{ }~¼½
SFNT "Swiss742SWC-BoldCondensedItalic";	FSET 1p##v5s3b4148T; ABCDabcd\$%&0123ÃāĐđİēôûáé{ }~¼½
SFNT "Swiss742SWC-BoldItalic";	FSET 1p##v1s3b4148T; ABCDabcd\$%&0123ÃāĐđİēôûáé{ }~¼½
SFNT "Swiss742SWC-Italic";	FSET 1p##v1s0b4148T; ABCDabcd\$%&0123ÃāĐđİēôûáé{ }~¼½
SFNT "Swiss742SWC-ItalicCondensed";	FSET 1p##v5s0b4148T; ABCDabcd\$%&0123ÃāĐđİēôûáé{ }~¼½
SFNT "Swiss742SWC-Roman";	FSET 1p##v0s0b4148T; ABCDabcd\$%&0123ÃāĐđİēôûáé{ }~¼½
SFNT "Swiss742SWC-RomanCondensed";	FSET 1p##v4s0b4148T; ABCDabcd\$%&0123ÃāĐđİēôûáé{ }~¼½

Resident Scalable Fonts (3)

KYOCERA PAGE PRINTER RESIDENT SCALABLE FONT LIST	
Typeface [SFNT]	Selection [FSET] Print Sample
SFNT "Symbol-Set-SWM";	CSET 19M;FSET 1p##v0s0b16686T; ABXΔαβχδΞ%&0123(®©™Σ∞∫ ρ ⊗ ⊕ { } ~ /
SFNT "ZapfHumanist601SWC-Bold";	FSET 1p##v0s3b4113T; ABCDabcd\$%&0123ÃãÐðÍéôúáé{ } ~ ¼ ½
SFNT "ZapfHumanist601SWC-BoldItalic";	FSET 1p##v1s3b4113T; <i>ABCDabcd\$%&0123ÃãÐðÍéôúáé{ } ~ ¼ ½</i>
SFNT "ZapfHumanist601SWC-Demi";	FSET 1p##v0s0b4113T; ABCDabcd\$%&0123ÃãÐðÍéôúáé{ } ~ ¼ ½
SFNT "ZapfHumanist601SWC-DemiItalic";	FSET 1p##v1s0b4113T; <i>ABCDabcd\$%&0123ÃãÐðÍéôúáé{ } ~ ¼ ½</i>

KPDL Fonts

KPDL FONT LIST	
Century-Schoolbook-SWA	ABCabc012#\$\$%
Century-Schoolbook-ItalicSWA	<i>ABCabc012#\$\$%</i>
Century-Schoolbook-BoldSWA	ABCabc012#\$\$%
Century-Schoolbook-BoldItSWA	<i>ABCabc012#\$\$%</i>
Courier-SWA	ABCabc012#\$\$%
Courier-ItalicSWA	<i>ABCabc012#\$\$%</i>
Courier-BoldSWA	ABCabc012#\$\$%
Courier-BoldItalicSWA	<i>ABCabc012#\$\$%</i>
Dutch801-RomanSWA	ABCabc012#\$\$%
Dutch801-ItalicSWA	<i>ABCabc012#\$\$%</i>
Dutch801-BoldSWA	ABCabc012#\$\$%
Dutch801-BoldItalicSWA	<i>ABCabc012#\$\$%</i>
ITC-Avant-Garde-BookSWA	ABCabc012#\$\$%
ITC-Avant-Garde-BookObliqueSWA	<i>ABCabc012#\$\$%</i>
ITC-Avant-Garde-DemiSWA	ABCabc012#\$\$%
ITC-Avant-Garde-DemiObliqueSWA	<i>ABCabc012#\$\$%</i>
ITC-Bookman-LightSWA	ABCabc012#\$\$%
ITC-Bookman-LightItalicSWA	<i>ABCabc012#\$\$%</i>
ITC-Bookman-DemiSWA	ABCabc012#\$\$%
ITC-Bookman-DemilightSWA	<i>ABCabc012#\$\$%</i>
ITC-Garamond-LightSWA	ABCabc012#\$\$%
ITC-Garamond-LightItalicSWA	<i>ABCabc012#\$\$%</i>
ITC-Garamond-BoldSWA	ABCabc012#\$\$%
ITC-Garamond-BoldItalicSWA	<i>ABCabc012#\$\$%</i>
ITC-Korinna-RegularSWA	ABCabc012#\$\$%
ITC-Korinna-BoldSWA	ABCabc012#\$\$%
ITC-Korinna-KursivRegularSWA	<i>ABCabc012#\$\$%</i>
ITC-Korinna-KursivBoldSWA	<i>ABCabc012#\$\$%</i>
ITC-Zapf-Chancery-MediumItSWA	<i>ABCabc012#\$\$%</i>
ITC-Zapf-Dingbats-SWA	☼†‡•◊✻⊙⊛⊞⊠⊡⊢⊣⊤⊥⊦⊧⊨⊩⊪⊫⊬⊭⊮⊯ⓀⓁⓂⓃⓄⓅⓆⓇⓈⓉⓊⓗⓘⓙⓛⓜⓝⓞⓟⓠⓡⓢⓣⓤⓥⓦⓧⓨⓩ⓪⓫⓬⓭⓮⓯⓰⓱⓲⓳⓴⓵⓶⓷⓸⓹⓺⓻⓼⓽⓾⓿
Swiss721-SWA	ABCabc012#\$\$%
Swiss721-ObliqueSWA	<i>ABCabc012#\$\$%</i>
Swiss721-BoldSWA	ABCabc012#\$\$%
Swiss721-BoldObliqueSWA	<i>ABCabc012#\$\$%</i>
Swiss721-NarrowSWA	ABCabc012#\$\$%
Swiss721-NarrowObliqueSWA	<i>ABCabc012#\$\$%</i>
Swiss721-NarrowBoldSWA	ABCabc012#\$\$%
Swiss721-NarrowBoldObliqueSWA	<i>ABCabc012#\$\$%</i>
Swiss721-LightSWA	ABCabc012#\$\$%
Swiss721-LightObliqueSWA	<i>ABCabc012#\$\$%</i>
Swiss721-BlackSWA	ABCabc012#\$\$%
Swiss721-BlackObliqueSWA	<i>ABCabc012#\$\$%</i>
Symbol-Set-SWA	ABXαβχ012#∃%
Zapf-Calligraphic801-SWA	ABCabc012#\$\$%
Zapf-Calligraphic801-ItalicSWA	<i>ABCabc012#\$\$%</i>
Zapf-Calligraphic801-BoldSWA	ABCabc012#\$\$%
Zapf-Calligraphic801-BoldItSWA	<i>ABCabc012#\$\$%</i>

* Downloaded font

3.3. Symbol set

A *symbol set* is the set of alphabetical and numerical characters and symbols the printer prints. Each character is assigned to a particular character code.

The page printer offers not only a large selection of bitmap and scalable fonts but also a large selection of symbol sets (also referred to as *character sets*). This is because the printers the Kyocera page printer emulates have a number of their own symbol sets for printing in different languages and other purposes. Most of those symbol sets are the same regarding the letters of the alphabet, digits, and basic punctuation marks, but they differ considerably in their special symbols which lie in the upper half of the character code table, consisting of character codes 128 through 254 (hex 80 through FE).

The symbol set selection can also be made from the printer's control panel. See *Mode Select Menu* on the last page in this manual.

Table 3.1. Bitmap Fonts Symbol sets

SSET value	SSET ID	Symbol set
4	0D	ISO 60: Norway
9	0I	ISO 15: Italian
14	0N	ECMA-94 Latin 1
19	0S	ISO 11: Swedish
21	0U	ISO 6: ASCII
37	1E	ISO 4: U.K.
38	1F	ISO 69: France
39	1G	ISO 21: Germany
53	1U	US Legal
83	2S	ISO 17: Spain
277	8U	HP Roman-8
341	10U	PC-8
373	11U	PC-8 (D/N)
405	12U	PC-850

Table 3.2. Scalable Fonts Symbol sets

SSET value	SSET ID	Symbol set
4	0D	ISO 60: Norway
9	0I	ISO 15: Italian
14	0N	ECMA-94 Latin 1
19	0S	ISO 11: Swedish
21	0U	ISO 6: ASCII
37	1E	ISO 4: U.K.
38	1F	ISO 69: France
39	1G	ISO 21: Germany
53	1U	US Legal
78	2N	ISO: Latin 2
83	2S	ISO 17: Spain
173	5M	PS math *
174	5N	ISO: Latin 5
180	5T	Windows Latin 5
202	6J	MS publishing *
205	6M	Ventura math *
234	7J	Desktop
269	8M	Math 8 *
277	8U	HP Roman-8
293	9E	Windows Latin 2
308	9T	PC-Turkish
309	9U	Windows 3.0
330	10J	PS text
341	10U	IBM PC-8
373	11U	IBM PC-8 (D/N)
394	12J	Macintosh
405	12U	IBM PC-850
426	13J	Ventura international
458	14J	Ventura US
501	15U	Pi font *
565	17U	PC852
629	19U	Windows Latin 1

* : These symbol sets are available only for the fonts appearing on the following page.

AudreyTwo-RegularSWC	Incised901SWC-Black	Swiss742SWC-BoldCondensed
Clarendon-CondensedSWC	Incised901SWC-Italic	Swiss742SWC-BoldCondensedItalic
Courier-BoldItalicSWC	Incised901SWC-Roman	Swiss742SWC-BoldItalic
Courier-BoldISWC	LetterGothic-BoldSWC	Swiss742SWC-Italic
Courier-ItalicSWC	LetterGothic-ItalicSWC	Swiss742SWC-ItalicCondensed
Courier-SWC	LetterGothic-SWC	Swiss742SWC-Roman
Dutch801SWC-Bold	OriginalGalamondSWC-Bold	Swiss742SWC-RomanCondensed
Dutch801SWC-BoldItalic	OriginalGalamondSWC-BoldItalic	ZapfHumanist601SWC-Bold
Dutch801SWC-Italic	OriginalGalamondSWC-Italic	ZapfHumanist601SWC-BoldItalic
Dutch801SWC-Roman	OriginalGalamondSWC-Roman	ZapfHumanist601SWC-Demi
Flareserif821-ExtraBoldSWC	Ribbon131-RomanSWC	ZapfHumanist601SWC-DemItalic
Flareserif821-RomanSWC	Swiss742SWC-Bold	

Chapter 4

Maintenance

This printer is designed to provide years of trouble-free service without the necessity of printer module replacement. However, you must replace the toner container in the printer with a replacement container from a new toner kit. Also, to ensure good print quality, various parts inside the printer must be cleaned at regular intervals.

4.1. Toner Kit Replacement

The toner container in the printer should be replaced as soon as the message display shows `Toner low TK-20 Clean printer` or soon after. If you continue to use the printer, eventually the toner supply will be exhausted at which point the printer will stop printing and the `Replace Toner Clean printer` message will be shown instructing you to install a new toner kit.

Toner kit replacement interval

The life of the toner container will vary according to the density of print in your documents. If you print documents with an actual toner coverage of approximately 5% (with the Ecoprint mode* turned off), the toner container will need replacing approximately once every 10,000** pages (20,000 pages with the TK-20H).

* Turning the Ecoprint mode ON conserves toner. Refer to *Chapter 2* for details.

** In the case of a new printer in which a toner kit has been installed for the first time, the number of pages that can be printed will be 6,000.

Toner Kit to be Used

The toner kit to be used with this printer is the TK-20/TK-20H. It contains the following:

- Toner container
- Waste toner bottle
- Wiper (lint-free) cloth
- Grid cleaner
- 2 plastic bags (for disposal of the old toner container and waste toner bottle)
- Instructions

(The initial toner kit that comes with the printer does not include plastic bags for disposal.)

 **We strongly recommend you use only the original Kyocera toner kit. Use of original Kyocera toner assures the intended long term reliability of the printer.**

Supplying Toner

 Before proceeding, take note of the following:

- ◆ Do not leave floppy disks etc. lying around while performing this maintenance procedure. This procedure tends to raise a little toner dust which can harm magnetic recording media.
- ◆ Do not attempt to reuse the waste toner remaining in the toner container.
- ◆ Use only the toner kit exclusively designed for the printer. Use of a toner kit intended for use with other printer models may damage the printer and void the warranty.

To replace the toner container, proceed as follows.

1. Open the printer's top cover all the way.

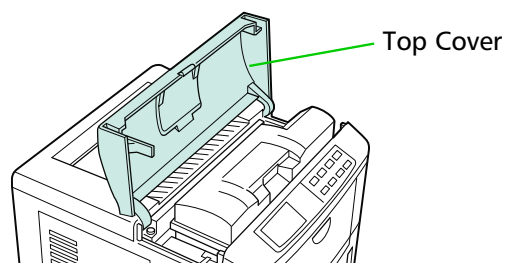

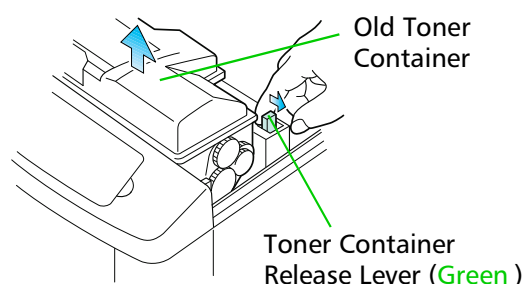

2. Press the toner container release lever (Green) to release the old toner container from the printer. Remove the old toner container as gently as possible.

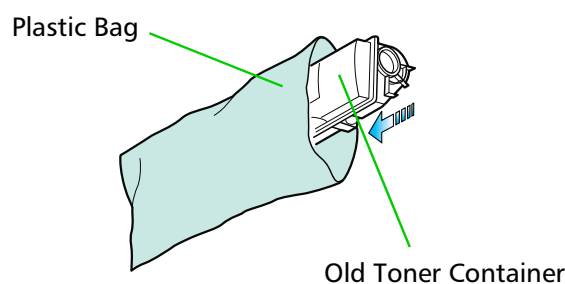

 **Keep the toner container as level as possible while removing.**

3. Put the old toner container in the plastic bag supplied with the toner kit. Dispose of the toner container.



 **The old toner container may be incinerated without the risk of generating harmful gas.**

4. Take the new toner container from its bag.

With the label side down, thoroughly shake the toner container (in the direction of the arrow) ten times or more to loosen and mix the toner inside.

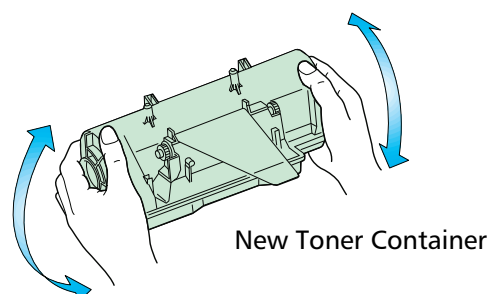

5. The bottom of the toner container is sealed with a plastic strip. Carefully pull the sealing strip off the toner container, making sure not to leak any toner. Dispose of the sealing strip.

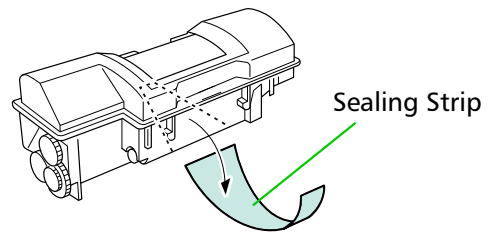

6. Install the toner container on the developer as shown in the diagram.

-  **Be sure to peel off the seal on the toner container before mounting the toner container on the developer unit.**

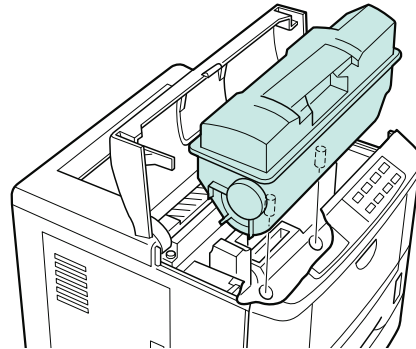

7. When the toner container is installed correctly on the developer.

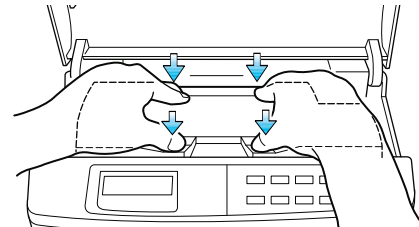

8. Push the top of the toner container unit ("**PUSH HERE**") until it locks in.

-  **Make sure that the toner container is properly locked in the printer.**

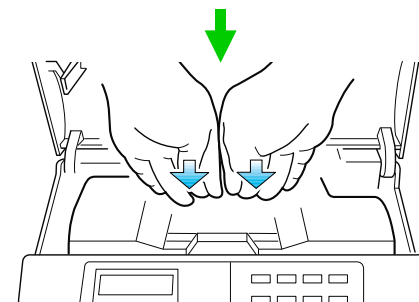

9. Close the top cover by pressing the arrowed part in this diagram.

-  **It is necessary to clean the inside of the printer after replacing the toner container.**

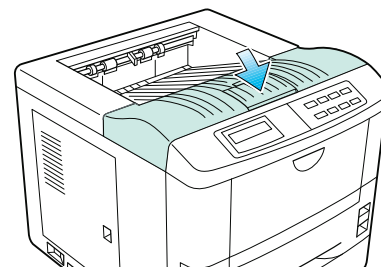

If the toner container is replaced when the message `Replace Toner` `Clean printer` is displayed, the message `Clean printer` `.. press CONT` will be displayed after replacement. After cleaning the inside of the printer (See Section 4.2. *Cleaning*), the message will disappear when the `CONT` key is pressed, and the printer will be ready for printing.

Replace the Waste Toner Bottle

 When replacing the toner container, the used waste toner bottle in the printer should also be replaced with a new one from the new toner kit.

1. Open the printer side cover.

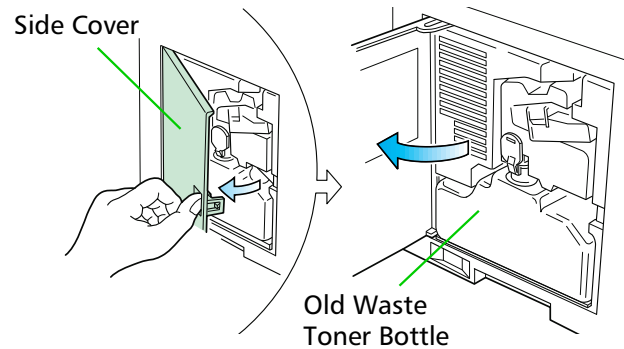

2. Remove the waste toner bottle as shown right.

 Remove the waste toner bottle as gently as possible so as not to scatter the waste toner inside. Do not let the opening of the waste toner bottle face downward.

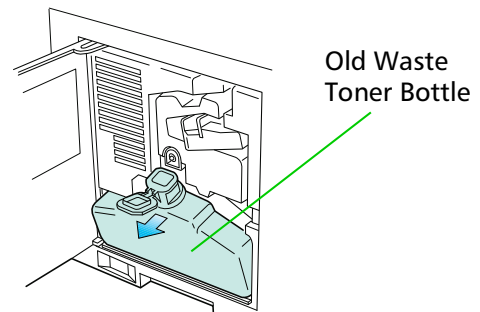

3. Cap the waste toner bottle after removing from the printer.

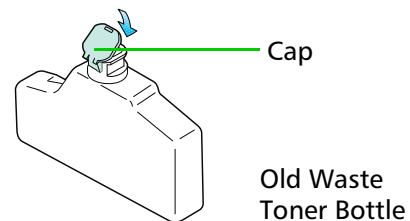

4. To avoid toner spilling, place the capped waste toner bottle in the plastic bag supplied before forwarding to proper disposal.

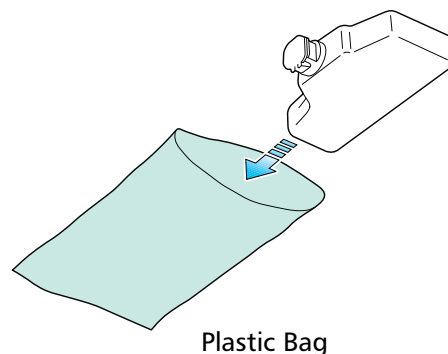

5. Locate the new waste toner bottle in the toner kit, and install in the printer as shown right.

 **Do not cap the new waste toner bottle.**

Insert the new waste toner bottle with the bottle tilted slightly towards you as shown in the figure.

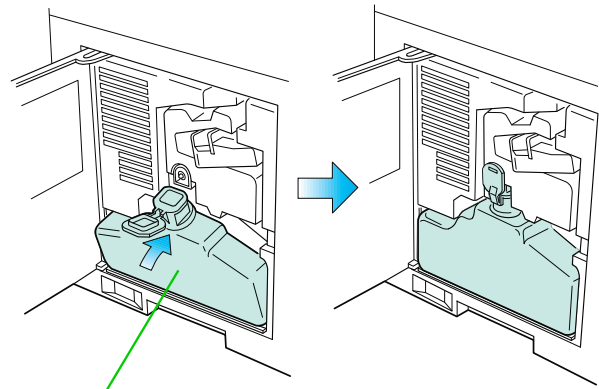

New Waste Toner Bottle

6. After ensuring that the bottle is correctly installed, close the side cover.

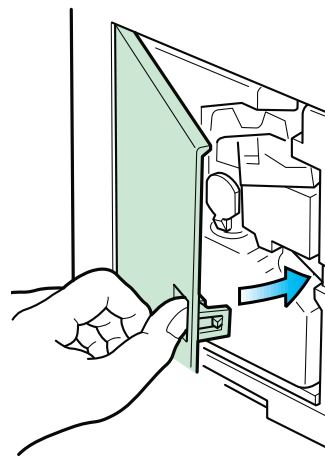

4.2. Cleaning

In addition to the maintenance procedures described on the following pages, the charger wire in the drum unit and paper feed unit should be cleaned from time to time, or whenever print quality problems occur.

To avoid print quality problems, the following printer parts must be cleaned with every toner container replacement.

👉 If the toner container has been replaced when the message `Replace Toner Clean printer` was displayed, the message `Clean printer ..press CONT` will be displayed after replacement. After cleaning the inside of the printer following the procedure shown below, press the **CONT key; the message will disappear and the printer will be ready for printing.**

Main Charger Unit

The main charger unit grid should be cleaned when the toner container is changed.

Cleaning the Charger Wire

1. Open the printer side cover.

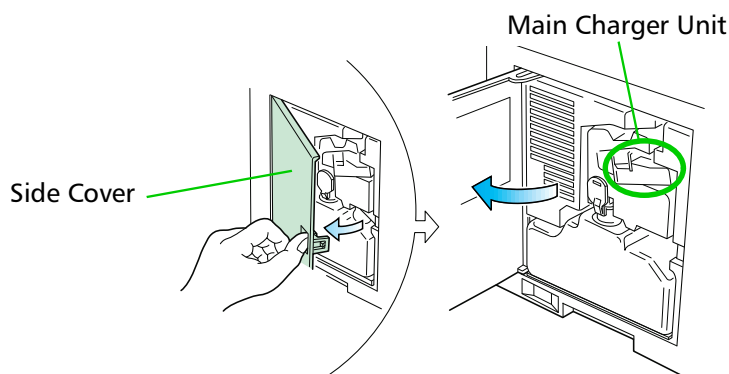

2. Pull the cleaning knob (green) slowly in and out a few times. This pulls a cleaning pad inside the drum unit along the wire.

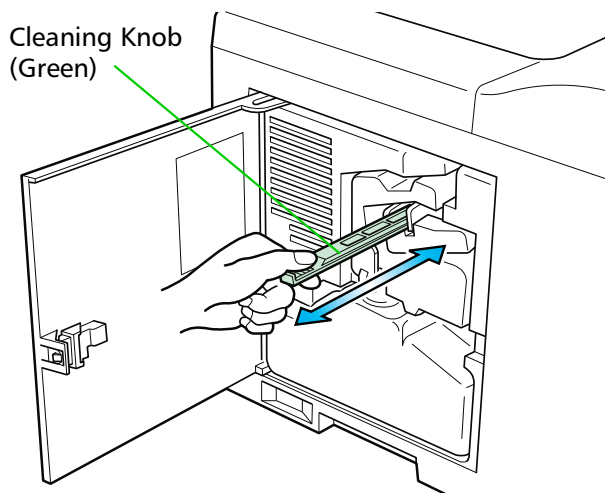

Cleaning the Grid

1. Take the grid cleaner from protective bag in the new toner kit, and remove the cap.

 **The grid cleaner pad is impregnated with water. Perform the following cleaning procedure before the pad dries.**

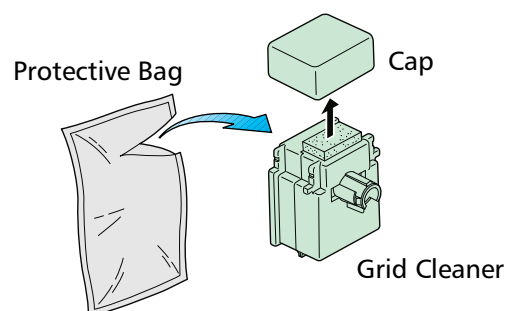

2. Attach the grid cleaner to the printer with the pad uppermost, as shown in the diagram.

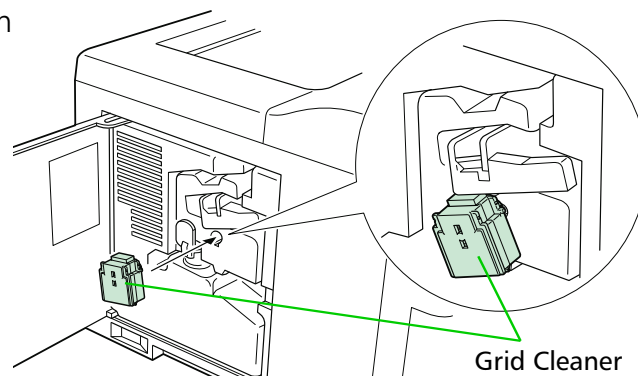

3. After attaching the grid cleaner, repeat the action of slowly pulling out and then pushing back in the main charger unit at least 5 times. It is easier to pull out the main charger for the first time if it is raised slightly, as shown in the figure.

The grid part underneath the main charger is cleaned by this procedure.

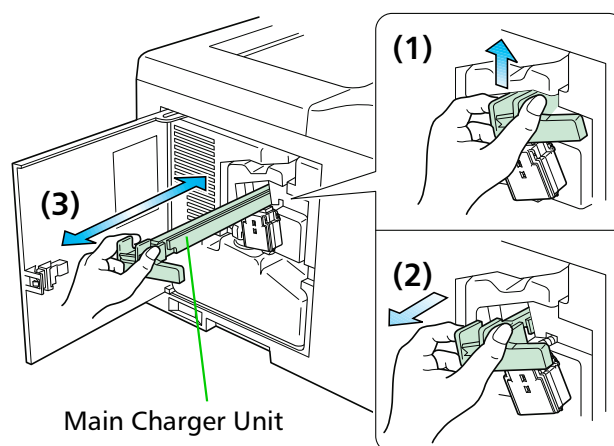

4. When the grid is clean, remove the grid cleaner from the printer and dispose of it. The grid cleaner is not re-usable.
5. After cleaning the charger wire, push the cleaning knob all the way in and close the side cover.

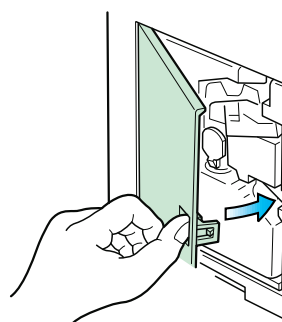

Paper Feed Unit

To avoid print quality problems due to paper dust and debris, clean the paper feed unit in the following manner.

1. Pull the paper feed unit release lever up and draw the paper feed unit all the way out until it stops.

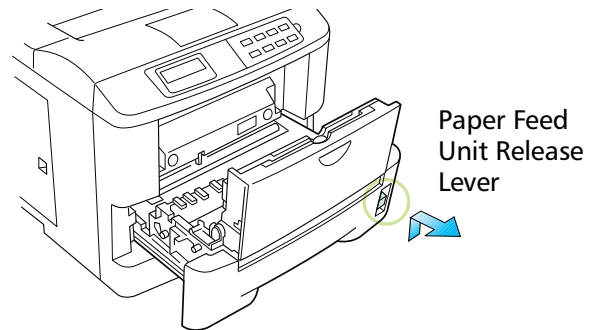

2. Wipe the paper dust on the registration roller and the paper ramp using the wiper cloth included in the toner kit.

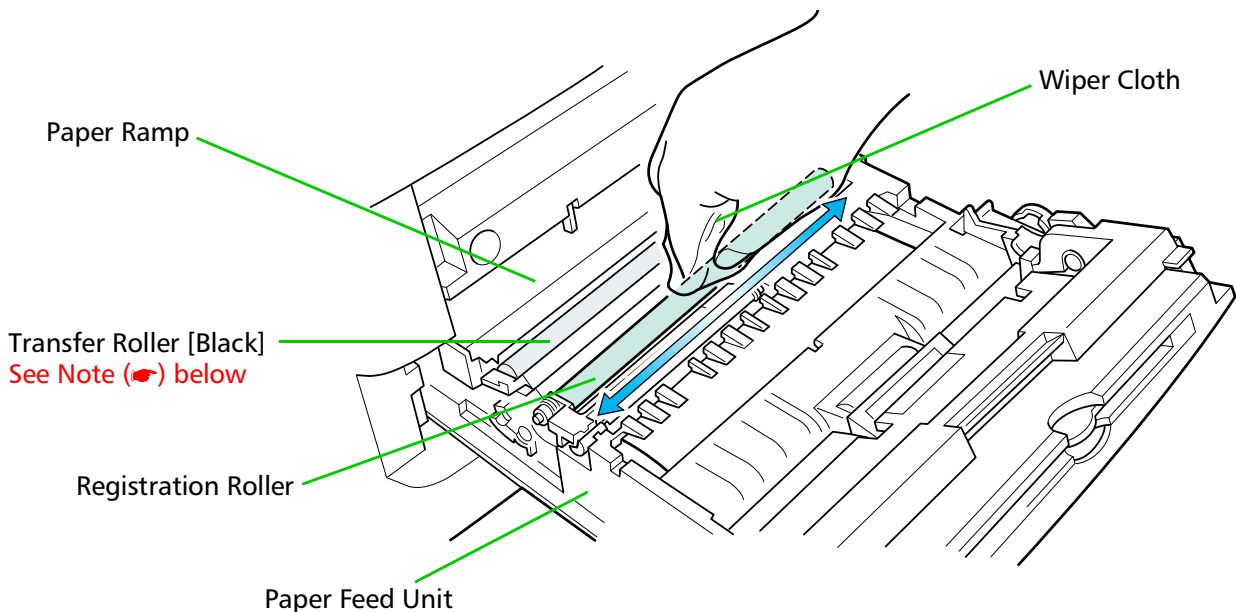

👉 **Do not touch the transfer roller (the black roller) when wiping the paper ramp.**

Chapter 5

Troubleshooting

This chapter explains how to handle printer problems which may or may not occur. The procedures are easy to follow. If a problem persists after you have completed the appropriate troubleshooting procedures, call for the assistance of a service person.

5.1. General Guide

If the printer does not print

If nothing is displayed on the message display on the front control panel, then you probably have a power problem. See section 5.2 .

If the printing is abnormal

With the printer on-line and ready, press the **STATUS** key to print a status page. You can print a KIR test pattern page for more precise printing criteria. To print a KIR test pattern page, refer to *Chapter 2*.

- If the result is normal, you may have an interface problem. See section 5.3.
- If the result is not normal, you have a print quality problem. See section 5.4.

If a maintenance message is displayed on the message display:

- See section 5.5. (For a paper jam, see section 5.6.)

If the printer does not print the entire page or indicates `Memory overflow` on its message display, try adding optional memory. To add optional memory, see *Chapter 1*.

5.2. Power Problems

 **The printer power rating must be within the voltage range in your country. If in doubt, consult your dealer.**

If nothing happens when you switch the printer's power on, you have a power problem. The symptoms are a dark control panel, no printing, and no fan sound. Proceed as follows.

Check the power switch.

The on position is marked "I".

The off position is marked "O".

Check the power cord.

If the cord is loose at either end, switch power off, plug the power cord in securely, then switch power on again.

Call for the assistance of a service person.

If the above checks do not solve the problem, call for the assistance of a service person.

5.3. Interface Problems

If the printer prints a status page correctly but does not print data from the computer correctly (or at all), there may be an interface problem.

Check the interface (network) cable.

Make sure the cable is plugged in securely at both ends.

Check your file and software.

Try printing a different file, or using a different print command.

Try using a different cable.

Compare the pin assignments listed in *Appendix C* with the specifications of your cable.

Call for the assistance of a service person.

If the above checks do not solve the problem, call for the assistance of a service person.

5.4. Print Quality Problems

Print quality problems range from uneven tone to completely blank output. The troubleshooting procedure for each type of problem is given below.

If the checks explained in this section do not solve the problem, call for the assistance of a service person.

Completely blank printout

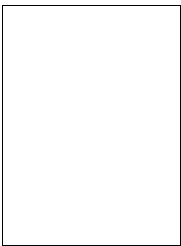

Check the developer unit.

Open the printer top cover and check that the developer unit is inserted correctly and check that the developer 's connector is connected properly.

Call for the assistance of a service person.

All-black printout

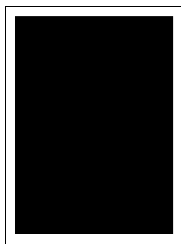

Check the Main Charger Unit

Open the printer side cover and check that the main charger unit is correctly installed.

Call for the assistance of a service person.

Dropouts, horizontal streaks, stray dots

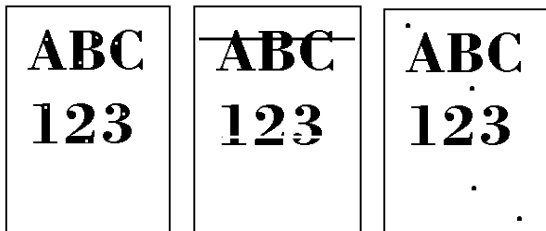

Clean the charger wire.

Open the printer side cover. Pull the green main charger wire cleaning knob slowly in and out a few times. See Section 4.2.

Note the spacing of the defects.

If the defects occur at regular intervals of 60.6 mm (2.4 inches), the problem may be a dirty transfer roller. Call for the assistance of a service person.

If the defects occur at regular intervals of 94 mm (3.7 inches), the problem may be a damaged drum unit or fuser roller. Call for the assistance of a service person.

Black or white vertical streaks

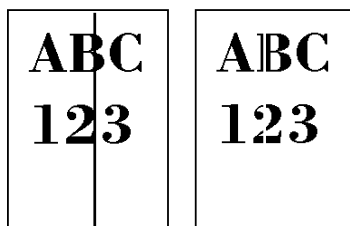

Check the control panel.

If the **Toner low TK-20 Clean printer** message is displayed and the  indicator is flashing, install a new toner kit. See Section 4.1.

Clean the charger wire.

Open the printer side cover. Pull the green main charger wire cleaning knob slowly in and out a few times. See Section 4.2.

Call for the assistance of a service person.

If the above checks do not solve the problem, call for the assistance of a service person.

Faint or blurred printing

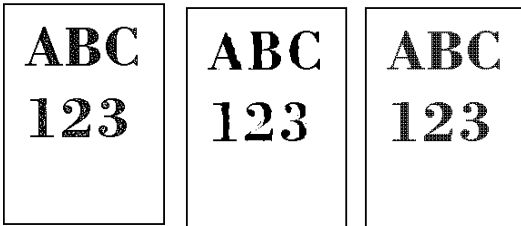

Check the control panel.

If the **Toner low TK-20 Clean printer** message is displayed and the  indicator is flashing, install a new toner kit. See Section 4.1.

Set the print density from the control panel to a higher level than the current setting. See Section 2.8.

Set the control panel **Paper type** setting to **Thick**.

Check the Ecoprint setting.

See Section 2.6.

Grey background

Check the control panel.

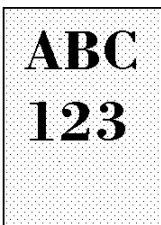

If the **Toner low TK-20 Clean printer** message is displayed and the  indicator is flashing, install a new toner kit. See Section 4.1.

Clean the main charger wire.

Open the printer's side cover. Pull the green main charger wire cleaning knob slowly in and out a few times. See Section 4.2.

Check the main charger unit installation.

Open the printer's side cover. Remove the main charger unit half way out, then reinstall it properly. See section 4.2.

Call for the assistance of a service person.

If the above checks do not solve the problem, call for the assistance of a service person.

Dirt on the top edge or back of the paper

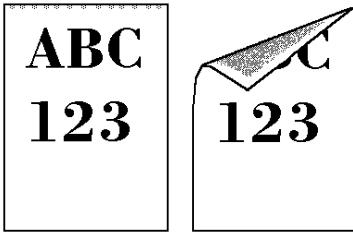

Check the paper chute and the ramp.

Draw out the paper feed unit and check for toner on the paper ramp. Clean the paper ramp (see Section 4.2.) using the wiper supplied, or a soft, dry, lint-free cloth.

Check the transfer roller.

If the transfer roller is dirty with toner, try printing several pages; or call for the assistance of a service person.

Characters out of position

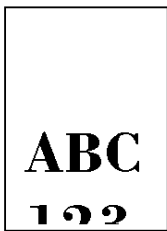

Check the file or program.

See if the problem is caused by incorrect PRESCRIBE II commands. If the problem occurs with only one file or program, the most likely cause is a command error.

Call for the assistance of a service person.



If the above checks do not solve the problem, call for the assistance of a service person.

5.5. Indicators and Messages

The tables on the following pages indicate how to respond to problems indicated by the control panel symbolic indicators and messages.

Indicators

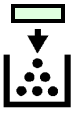
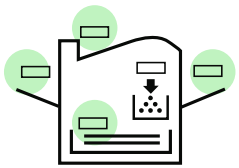
Table 5.1 Symbolic Indicators

Indicator	Condition	Corrective Action
	Flashing	The printer has run low on toner. The toner should be replaced as soon as possible.
	Lit	Install a new toner kit. See Section 4.1. (Toner Empty)
	Fast Flashing	There is a paper jam. There is a possibility that paper may be jammed at the point indicated by flashing, open and remove any jammed paper. See Section 5.6.
	Slow Flashing	The paper has run out in the paper cassette or multi-purpose tray. Please insert paper. See Section 1.4.
	Lit	This indicates either the current paper feeder or the paper output point.
 ATTENTION	Flashing	The printer has insufficient memory available or the printer is warming up (Please wait). Confirm the message indicated on the message display. See Section 5.5.
	Lit	Note the maintenance message on the message display and consult Table 5.2.

Maintenance Messages

Table 5.2 Maintenance Messages

Message	Corrective Action
Top cover Open	Open the top cover, then close tightly.
Side cover Open	Open the side cover, then close tightly.
Paper feed unit Open	Open the paper feed unit, then close tightly.
Face-down tray paper full	The face-down tray has become full (approx. 250 pages). You must remove all printed pages from the face-down tray. When the printer senses that the face-down tray is empty again, it will continue printing into the face-down tray. (Model FS-3700 only)
Add paper	Add paper to the paper cassette or multi-purpose tray.
Set paper Press CONT	Add a sheet of paper to the multi-purpose tray (manual mode), and press the CONT key.
Load paper (paper size)	The paper size does not match. The size of the paper in the cassette is different to the size specified by the application software or by PRESCRIBE II. Either put paper of the specified size into the cassette. See Section 1.4. If the CONT key is pressed, printing will be resumed. However, if more than one sheet is to be printed, the same message will again be displayed from the second sheet onward. You can abandon printing by pressing the CANCEL key.
Paper jam	Open the top cover or the paper feed unit and correct the paper jam (or paper mis-feeding in the cassette). See Section 5.6.
Warning Low memory	The printer's internal memory is running low due to the number of fonts and macros downloaded. Print a status page to see how much user memory is left, and try deleting unnecessary fonts and macros. See the PRESCRIBE II DELF and DELM commands explanation in the programming manual (CD-ROM).
Toner low TK-20 Clean printer	Replace the toner container using a new toner kit. See Section 4.1.
Replace Toner Clean printer	Replace the toner container using a new toner kit. The printer does not operate when this message is displayed. See section 4.1.
Clean printer .. Press CONT	Please clean the inside of the printer. See Section 4.2. This message will be displayed when replacing the toner container after the message <code>Replace Toner Clean printer</code> has been displayed. After cleaning the inside of the printer, press the CONT key and the printer will be ready for printing.
Replace Waste- toner bottle	Replace the old waste toner bottle with the new one which is included in the TK-20/TK-20H toner kit. The message will also be shown if the waste toner bottle has become full. The waste toner bottle should be replaced when the message display eventually shows <code>Toner low TK-20 Clean printer</code> . See Section 4.1.
Missing Waste- toner bottle	Install the waste toner bottle. See Section 1.4. The printer does not operate when this message is displayed.

Message	Corrective Action
Call service person En: 123456	Mechanical error (n = 0, 1, 2, ...)—Call a service person. The printer does not operate when a message beginning with E is displayed. The total number of pages printed is also indicated.
Call service person Fn: 123456	Controller error (n = 0, 1, 2, ...)—Call a service person. The printer does not operate when a message beginning with F is displayed. The total number of pages printed is also indicated.

Error Messages

Table 5.3 Error Messages

Message	Corrective Action
Memory overflow .. Press CONT	The total amount of data received by the printer exceeds the printer's internal memory. Try adding more memory (expansion RAM). Press the CONT key to resume printing. You can abandon printing by the CANCEL key.
Print overrun .. Press CONT	The data transferred to the printer was too complex to print on a page. Press the CONT key to resume printing. (The page may break in some pages.) You can abandon printing by the CANCEL key. Note: After this message has been displayed, Page protect mode will be On. To maintain optimum use of memory during printing, display >Page protect from the control panel, and re-select Auto. See the last page in this manual.
MEMORY CARD err Insert again	The memory card is accidentally removed from the printer's memory card slot during reading. If you continue reading the memory card, insert the same memory card into the slot again. The printer again reads it from the beginning of the data. Note: We recommend that you follow the reading procedure from the beginning to ensure correct reading of the memory card.
Insert the same MEMORY CARD	You have inserted the wrong memory card when the Insert again message was displayed. Remove the wrong memory card from the printer's memory card slot and insert the correct memory card. The printer again reads it from the beginning of the data.
Format error MEMORY CARD	This message appears when the printer is in the ready state and the memory card is not formatted, and therefore cannot be read or written. Follow the procedure on Section 2.10. to format the card.
Warning battery MEMORY CARD	This message appears when the printer is in the ready state and the battery in the memory card is low. You can still enter the memory card mode, but the battery should be changed as soon as possible.
Battery error MEMORY CARD	This message appears when the printer is in the ready state and the battery in the memory card is dead, or there is no battery at all. It is not possible to use the memory card mode until you insert a good battery in the card.

Message	Corrective Action
<pre>MEMORYCARD err ## .. Press CONT</pre>	<p>This message appears when an error occurs during access to the memory card using the PRESCRIBE II ICCD command or from the printer's control panel (codes 09 and 11 only). The error is indicated by one of the numbers ## listed below.</p> <p>01 : Card size error (An attempt was made to write data of greater than 16 MB in size.). Reduce the size of the data to be written from the host computer to 16 MB or less; or, a file name could not be found in the memory card.</p> <p>02 : No memory card inserted. Insert a proper memory card.</p> <p>03 : Non PCMCIA card. Replace the card with a PCMCIA card. This message appears when the printer attempts to identify the card.</p> <p>04 : Not RAM card. Use a SRAM-type card if you want to write data to an memory card.</p> <p>05 : Memory card battery error. Replace the memory card's internal battery with a new one.</p> <p>06 : Memory card protect error. Release the write protection on the memory card when you write data to the memory card.</p> <p>07 : Non-Kyocera format. Reformat the memory card using MODE SELECT (See page 2-21.).</p> <p>08 : Partition name error. Follow instructions given attempt in <i>Chapter 2</i> to properly name the destination.</p> <p>09 : Memory card data full error (An attempt was made to write data exceeding the capacity of the memory card). Abandon the writing operation on the host computer first. Press CONT key; when the message turns to <i>Waiting</i>, press FORM FEED key (<i>Ready</i>).</p> <p>11 : Data name full (An attempt was made to write more than 127 destination data names). Press CONT key (<i>Ready</i>).</p> <p>13 : Erase logic error with flash memory card. Try replacing the memory card.*</p> <p>15 : Non PCMCIA flash card. Replace the card with a PCMCIA flash card.*</p> <p>This message appears when the printer attempts manipulating data on a flash card.</p> <p>17 : Unable to write to the flash memory card due to insufficient printer memory. Either delete unnecessary macros or fonts stored in the printer, or extend the printer's available memory.*</p> <p>18 : Writing error. Try replacing the memory card.*</p> <p>* : Flash card only.</p>
<pre>>Read fonts Failed</pre>	<p>The amount of memory available for the fonts header parts of font is too small to load more fonts. Try deleting unnecessary fonts and macros.</p>
<pre>I/F occupied</pre>	<p>This message is displayed when you attempt to use the printer's control panel to change the environmental settings on the interface from which data are presently being received.</p>
<pre>Processing PAR FIT A4</pre>	<p>FIT (image FITing) flashes to indicate that a loss of raster data occurred when the data was compressed to be fitted within the currently available memory. Flashing FIT extinguishes automatically when the job times out; the printer receives the next data from the host computer; or if you press any key on the printer's control panel. Try adding more memory in the printer to prevent this error.</p>
<pre>Processing PAR 600 A4 ↓ Processing PAR 300 A4</pre>	<p>Change of the resolution indicator from 600 to 300 (flashing) means that the job in 600-dpi resolution was not able to run within the currently available memory. The resolution reverts to 600 dpi automatically when the job times out; the printer receives the next data from the host computer; or if you press any key on the printer's control panel. Try adding more memory in the printer to prevent this error.</p>

5.6. Correcting a Paper Jam

The **Paper jam** message is displayed on the message display when paper becomes stuck in the paper transport system, the paper feed timing is incorrect, or paper fails to feed at all. The jam can be corrected by removing the paper.

The printer goes off-line when the **Paper jam** message is displayed.

Compare the symbol on the front panel that is flashing to *Figure 5.1* and take the appropriate action listed below:

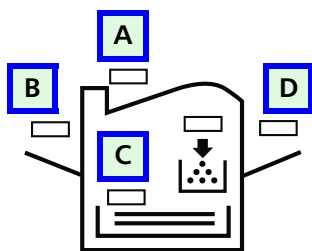

Figure 5.1. Printer Symbol

A	Check the face-down output tray.	If paper is partially fed out into the tray, pull the paper out the rest of the way by hand, then open and close the printer's top cover or the paper feed unit.
	Check the inside of the rear cover.	Open the printer's rear cover. Draw out the paper feed unit. Pull out the paper as shown in Figure 5.2. Close the printer's rear cover.
B	Check the face-up output tray.	Refer to A, above.
C	Check the paper feed cassette.	If paper is stacked in the paper cassette, not reaching the registration rollers, remove the paper cassette and draw out the paper feed unit. Remove the jammed paper. See Figure 5.3. Close the paper feed unit and install the paper cassette in the printer.
	Check the registration roller.	If the paper is caught by the registration rollers, draw out the paper feed unit half way and remove the jammed paper. See Figure 5.4. Return the paper feed unit to the printer.
D	Check the multi-purpose tray.	If the paper is stacked in the multi-purpose tray, remove the paper by pulling it out. Open and close the printer's top cover or the paper feed unit.

When the jammed paper has been removed, open and close the printer's top cover or the paper feed unit. Then the printer automatically warms up, goes on-line, and continues printing. Depending on the point at which the jam occurred, the printer may or may not print the jammed page.

If paper jams occur frequently, try using a different type of paper, replace with paper from another ream, turn the stack of paper over, or turn the paper the other way around. Read the information in *Appendix B*. Also, look for tiny pieces of paper that may have been torn off and overlooked when the jammed paper was removed.

If you cannot solve the problem by changing the paper, there may be a problem with the printer. Call a service person.

- When pulling the paper, pull it gently so as not to tear it. Torn pieces of paper are difficult to remove and may be easily overlooked, deterring the jam recovery.

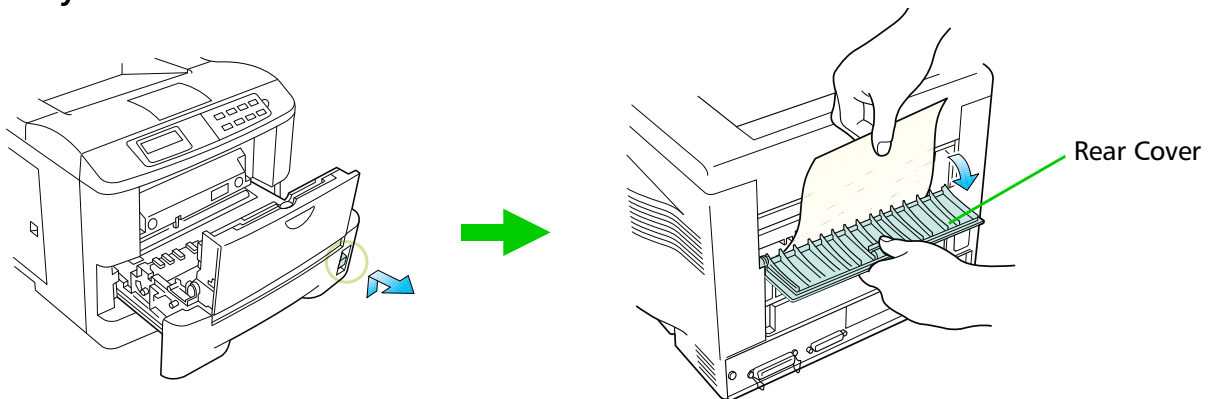

Figure 5.2. Rear Cover

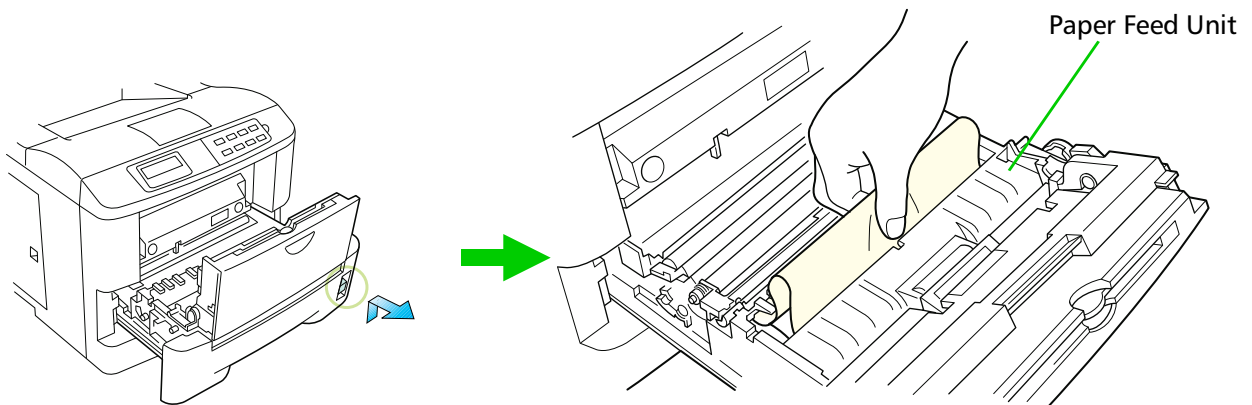

Figure 5.3. Paper Cassette

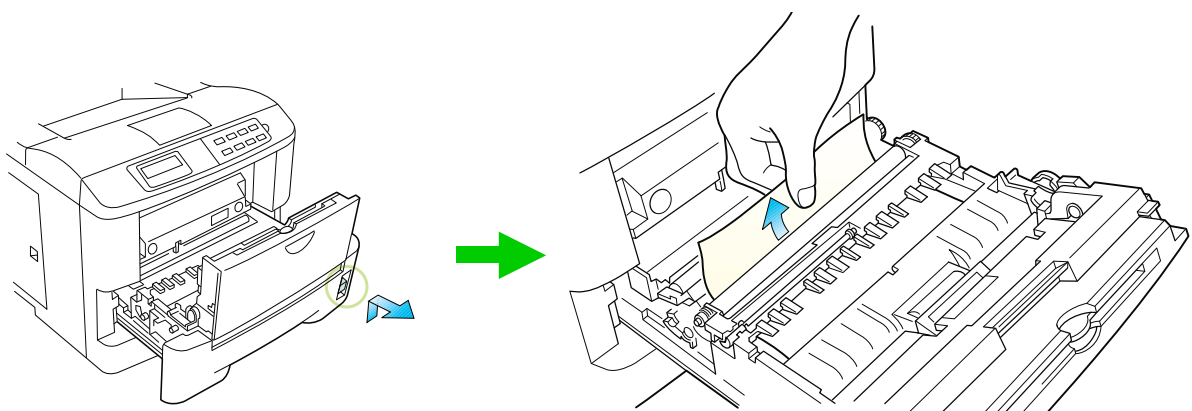
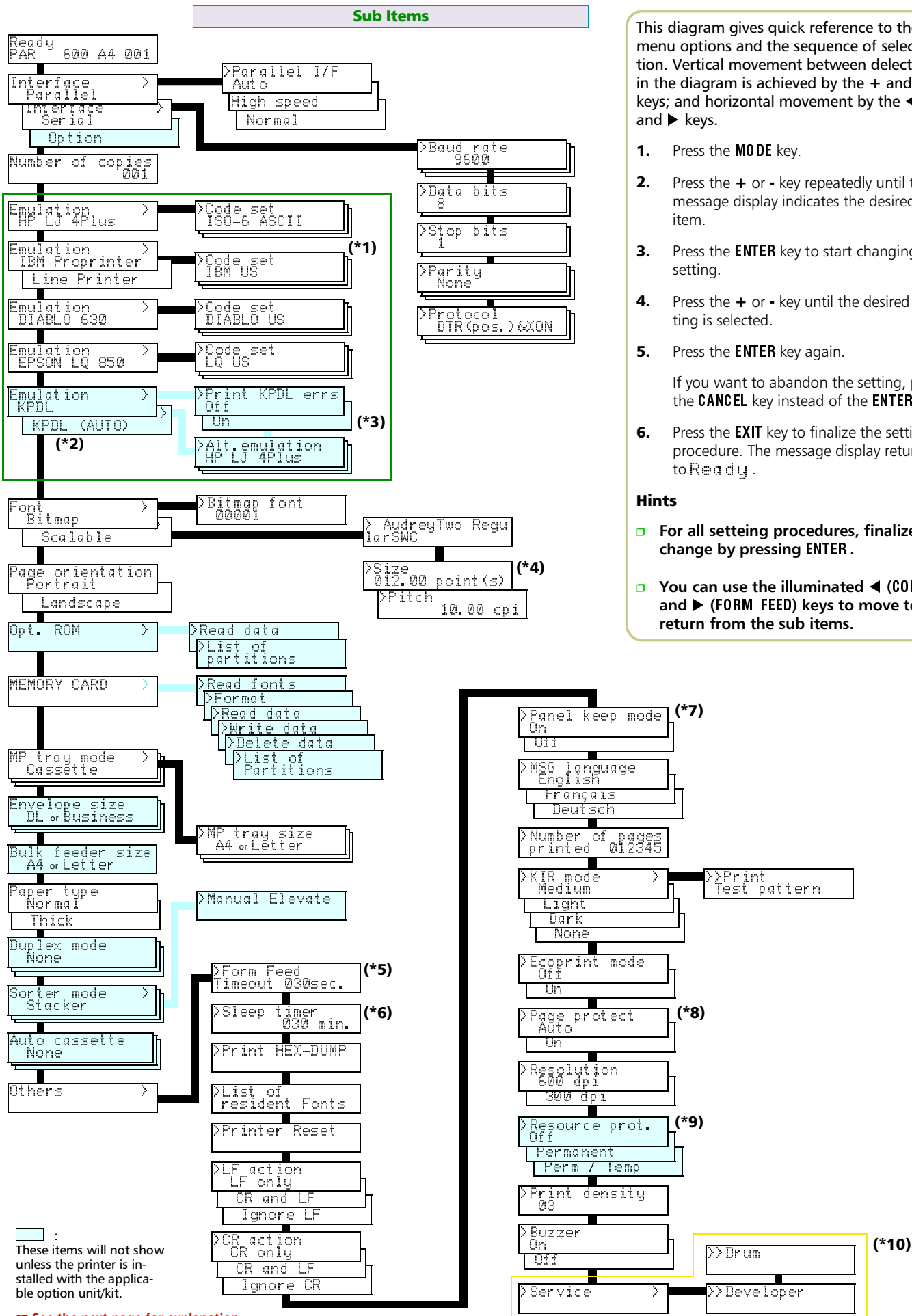

Figure 5.4. Paper Feed Unit

Mode Select Menu



This diagram gives quick reference to the full menu options and the sequence of selection. Vertical movement between selections in the diagram is achieved by the + and - keys; and horizontal movement by the ◀ and ▶ keys.

1. Press the **MODE** key.
 2. Press the + or - key repeatedly until the message display indicates the desired item.
 3. Press the **ENTER** key to start changing the setting.
 4. Press the + or - key until the desired setting is selected.
 5. Press the **ENTER** key again.
- If you want to abandon the setting, press the **CANCEL** key instead of the **ENTER** key.
6. Press the **EXIT** key to finalize the setting procedure. The message display returns to Ready.

- Hints**
- For all setting procedures, finalize the change by pressing **ENTER**.
 - You can use the illuminated ◀ (**CONT**) and ▶ (**FORM FEED**) keys to move to or return from the sub items.

← See the next page for explanation.

***1:** Depending on the emulation selected, the following code sets are available.

HP LaserJet 4 Plus	IBM Proprinter X24E or Line Printer	DIABLO 630	EPSON LQ-850
Bitmap and Scalable Fonts			
ISO 6: ASCII ISO 11: Sweden ISO 15: Italian ISO 17: Spain ISO 21: Germany ISO 60: Norway ISO 69: France HP Roman-8 ECMA-94 Latin 1 US Legal IBM PC-8 IBM PC-8 (D/N) IBM PC-850 ISO 4: U.K.	IBM US IBM D/N IBM PC-850 IBM PC-860 IBM PC-863 IBM PC-865 US Legal	DIABLO US DIABLO France DIABLO Germany DIABLO U.K. DIABLO Denmark DIABLO Sweden DIABLO Italy DIABLO Spain DIABLO Japan US Legal	LQ US LQ France LQ Germany LQ U.K. LQ Denmark LQ Sweden LQ Italy LQ Spain LQ Japan LQ Norway LQ Denmark 2 LQ Spain 2 Latin America IBM US IBM D/N IBM PC-850 IBM PC-860 IBM PC-863 IBM PC-865
Scalable Fonts Only			
Ventura Math Ventura International Ventura US PS math PS text Math-8 Pi font MS publishing Windows 3.0 Desktop ISO Latin 2 ISO Latin 5 Windows Latin 1 Windows Latin 2 Windows Latin 5 PC-852 Latin 2 PC-Turkish Macintosh			

***2:** Your dealer can install the KPD (Kyocera's version of Adobe's PostScript command language) upgrade kit in your printer. The printer needs at least 3 (2) MB of memory in order for the KPD option to work properly.

***3:** The printer can be set to print error data during KPD emulation. If this is set to **On**, error data will be printed if trouble occurs during printing. This is set to **Off** before leaving the factory.

***4:** The **>Size** menu is not available for the *Courier* and *Letter-Gothic* fonts. Use the **>Pitch** menu to scale these fixed fonts.

***5:** Any value from 0 to 495 [seconds] in 5-second increments. (The printer does not time out with the value set to 0.)

***6:** Any value from 0 to 120 [minutes] in 5-minute increments.

***7:** When ON, the following changes made with panel keys are kept in permanent memory so that they are not lost when power is switched off.

- Copy count
- Emulation
- Font
- Code set
- Page orientation
- Auto cassette mode
- Formfeed time-out time
- Linefeed action
- Carriage-return action
- KIR mode

***8:** **Auto** is the default setting, and this selection does not usually appear in the MODE SELECT menu. In the event of a **Print overrun . . . press CONT** error due to insufficient printer memory, the printer automatically switches to page protect mode **On**. In such a case this selection will appear in the MODE SELECT menu.

 **In order to maintain efficient use of printer memory, the setting should normally be set to **Auto**.**

***9:** Resource protection is available only when the printer has more than 10 MB (14 MB if the duplexer is on) of additionally installed main memory.

***10:** For service purpose only.

Appendix A

Printer Specifications

Item	Description	
	FS-1700	FS-3700
Printing method	Electrophotography, laser scan.	
Printing speed	12 pages/minute (A4 or letter-size paper, when printing multiple copies of the same page)	18 pages/minute (A4 or letter-size paper, when printing multiple copies of the same page)
Resolution	600 dots/inch (vertical and horizontal) with KIR (Kyocera Image Refinement)	
First print	Approx. 15 seconds (A4 or letter size), depends on input data.	Approx. 12 seconds (A4 or letter size), depends on input data.
Warm-up time	Approx. 50 seconds (at 23°C, 120 V or 220 V)	Approx. 40 seconds (at 23°C, 120 V or 220 V)
Controller	MC68EC040 (33 MHz)	
Main memory*	2 MB, expandable up to 66 MB	
Memory card slot	One, PC CARD (PCMCIA 2.1/JEIDA 4.2 [type I , memory card])	
Self test	Performed at power-up	
Scanning system	Laser diode, polygon mirror.	
Maximum duty cycle	25,000 pages/month	50,000 pages/month
Drum	Amorphous silicon drum	
Developer	Mono-component dry developer	
Main charger	Positive scorotron charger	
Transferring	Negative charger roller	
Separation	Curvature separation	
Drum cleaning	Blade cleaner	
Drum discharging	Illumination by eraser LED array	
Fuser	Heat roller and pressure roller	
Toner saving	Ecoprint mode	
Paper	Plain paper. See <i>Appendix B</i> .	
Paper feed trays	Cassette: A4 or letter size. Holds 250 sheets of weight 75 g/cm ² , thickness 0.1 mm. Multi-purpose tray: Adjustable to ISO A6 to Legal size. Holds 100 sheets of weight 75 g/cm ² , thickness 0.1 mm.	

* Including the raster memory (video-RAM). Extendable to 3 - 66 MB with optional memory.

Item	Description	
	FS-1700	FS-3700
Capacity of output trays	Face-down tray—250 sheets of thickness 0.1 mm. Face-up tray—250 sheets of thickness 0.1 mm.	
Ambient conditions	Temperature: 10°C to 32.5°C (50°F to 90.5°F) Humidity: 20% to 80% RH Optimum conditions: 20°C (68°F), 65% RH. Altitude: Max. 2000m (6500 feet) Illumination: Max. 1500 lux	
Power requirements	120 V, 60 Hz, max. 5.8 A (U.S.A./Canada) 220—240 V, 50Hz, max. 3 A (European countries) Max. allowable voltage fluctuation: ±10 % Max. allowable frequency fluctuation: ±2 %	120 V, 60 Hz, max. 7.8 A (U.S.A./Canada) 220—240 V, 50Hz, max. 4 A (European countries) Max. allowable voltage fluctuation: ±10 % Max. allowable frequency fluctuation: ±2 %
Power consumption	Max. 667 W During sleeping 19 W	Max. 898 W During sleeping 20 W
Noise	Max. 50 dB (A) when printing (excl. peak values) Max. 39 dB (A) when idling (excl. peak values) Immeasurably low when sleeping (Measured 1 m from the outside of the printer, main unit only)	Max. 53 dB (A) when printing (excl. peak values) Max. 39 dB (A) when idling (excl. peak values) Immeasurably low when sleeping (Measured 1 m from the outside of the printer, main unit only)
Dimensions	373 mm (14.7") wide x 310 mm (12.2") high x 383 mm (15.1") deep (Excl. the paper tray)	
Weight	14 kg (30 lbs.), main unit only	

Appendix B

Paper Selection

B.1. General Guidelines

The printer is designed to print on high-quality copier bond paper (the kind used in ordinary dry copier machines), but it can accept a variety of other types of paper as well within the limits specified below.

 **The manufacturer assumes no liability for problems that occur when paper not satisfying these requirements is used.**

Selection of the right paper is important. The wrong paper can result in jams, misfeeds, curl, poor print quality, and paper waste, and in extreme cases can damage the printer. The guidelines given below will increase the productivity of your office by ensuring efficient, trouble-free printing and reducing wear and tear on the printer.

Paper Availability

Most types of paper are compatible with a variety of machines. Paper intended for xerographic copiers can also be used with the printer.

There are three general grades of paper: economy, standard, and premium. The most significant difference between grades is the ease with which they pass through the printer. This is affected by the smoothness, size, and moisture content of the paper, and the way in which the paper is cut. The higher the grade of paper you use, the less risk there will be of paper jam and other problems, and the higher the level of quality your printed output will reflect.

Differences between paper from different suppliers can also affect the printer's performance. A high-quality printer cannot produce high-quality results when the wrong paper is used. Low-priced paper is not economical in the long run if it causes printing problems.

Paper in each grade is available in a range of basis weights (defined later). The traditional standard weights are 16, 20, and 24 pounds (60g/m² to 90g/m²).

Paper Specifications

The following table summarizes the basic paper specifications. Details are given on the following pages.

Table B.1 Specifications

Item	Specification
Weight	60 to 90 g/m ² (16 to 24 lbs./ream)
Thickness	0.086 to 0.110 mm (3.4 to 4.3 mils)
Dimensional accuracy	±0.7 mm (±0.0276 inches)
Squareness of corners	90° ± 0.2°
Moisture content	4% to 6%
Direction of grain	Long grain
Pulp content	80% or more

B.2. Selecting the Right Paper

Laser printing is a process involving laser light, electrostatic discharge, toner, and heat. In addition, as the paper passes through the printer it undergoes considerable sliding, bending, and twisting motions. A high-quality printing paper matching the printer's requirements withstands all these stresses, enabling the printer to turn out clean, crisp printed copy consistently.

Remember that all paper is not the same. Some of the factors to consider when selecting paper for the printer are as follows:

Condition of the Paper

Avoid using paper that is bent at the edges, curled, dirty, torn, embossed, or contaminated with lint, clay, or paper shreds

Use of paper in these conditions can lead to illegible printing, misfeeding, and paper jams, and can shorten the life of the printer. In particular, avoid using paper with a surface coating or other surface treatment. The paper should have as smooth and even a surface as possible.

Composition

Do not use paper that has been coated or surface-treated and contains plastic or carbon. The heat of fusing can cause such paper to give off harmful fumes.

Bond paper should contain at least 80% pulp. Not more than 20% of the total paper content should consist of cotton or other fibers.

Paper Size

Cassettes and a multi-purpose tray are available for the paper sizes listed in Table B.2. The dimensional tolerances are ± 0.7 mm (± 0.0276 inches) for the length and width. The angle at the corners must be $90^\circ \pm 0.2^\circ$.

Table B.2 Paper Sizes for Paper Feeding

Multi-Purpose tray	Size	Cassette or multi-purpose tray	Size
Monarch	3-7/8 x 7-1/2 inches	Legal	8.5 x 14 inches
Business	4-1/8 x 9-1/2 inches	Letter	8.5 x 11 inches
International DL	11 x 22 cm	ISO A4	210 x 297 mm
International C5	16.2 cm x 22.9 cm	ISO A5	148 x 210 mm
International B5	17.6 x 25 cm	JIS B5	182 x 257 mm
Executive	7-1/4 x 10-1/2 inches	Other sizes of paper can be fed manually. The minimum size of manually fed paper is 80 x 148 mm (3.1 x 5.8 inches), fed lengthwise. The maximum size is 216 x 356 mm (8.5 x 14 inches).	
Commercial 9	3-7/8 x 8-7/8 inches		
Commercial 6-3/4	3-5/8 x 6-1/2 inches		
ISO A6	105 x 148 mm		
JIS B6	128 x 182 mm		

Smoothness

The paper should have a smooth, uncoated surface. Paper with a rough or sandy surface can cause voids in the printed output. Paper that is too smooth, however, can cause multiple feeding and fogging problems. (Fogging is a gray background effect.)

Basis Weight

Basis weight is the weight of a standard quantity of paper. In the traditional system the standard quantity is a ream consisting of 500 sheets measuring 17 x 22 inches each. In the metric system the standard quantity is 1 square meter.

Paper that is too light or too heavy can cause misfeeding, jams, and premature wear of the printer. Uneven paper weight can cause multiple feeds, print defects, poor toner fusing, blurring, and other print quality problems. The proper weight is 60 to 90 g/m² (16 to 24 lbs/ream).

Thickness (Caliper)

Thick paper is referred to as high-caliper paper and thin paper as low-caliper paper. The paper used with the printer should be neither extremely thick nor extremely thin. If you are having problems with paper jams, multiple feeds, and faint printing, the paper may be too thin. If you are having problems with paper jams and blurred printing the paper may be too thick. The proper thickness is 0.086 to 0.110 mm (3.4 to 4.3 mils).

Moisture Content

Moisture content is defined as the percent ratio of moisture to the dry mass of the paper. Moisture can affect the paper's appearance, feedability, curl, electrostatic properties, and toner fusing characteristics.

The moisture content of the paper varies with the relative humidity in the room. When the relative humidity is high and the paper absorbs moisture, the paper edges expand, becoming wavy in appearance. When the relative humidity is low and the paper loses moisture, the edges shrink and tighten, and print contrast may suffer.

Wavy or tight edges can cause misfeeding and alignment anomalies. The moisture content of the paper should be 4% to 6%.

To ensure the proper moisture content it is important to store the paper in a controlled environment. Some tips on moisture control are:

- Store paper in a cool, dry location.
- Keep the paper in its wrapping as long as possible. Rewrap paper that is not in use.
- Store paper in its original carton. Place a pallet etc. under the carton to separate it from the floor.
- After removing paper from storage, let it stand in the same room as the printer for 48 hours before use.
- Avoid leaving paper where it is exposed to heat, sunlight, or damp.

Paper Grain

When paper is manufactured, it is cut into sheets with the grain running parallel to the length (long grain) or parallel to the width (short grain). Short grain paper can cause feeding problems in the printer. All paper used in the printer should be long grain.

Other Paper Properties

Porosity: Refers to the density of the paper structure; that is, to how openly or compactly the fibers are bonded.

Stiffness: Limp paper can buckle inside the printer, while paper that is too stiff may bind. Either way the result is a paper jam.

Curl: Most paper has a natural tendency to curl in one direction. The paper should be loaded so that the natural curl is downward, to counteract the upward curl imparted by the printer. Printed sheets will then come out flat. Most paper also has a top and bottom surface. Loading instructions are usually given on the paper package.

Electrostatic properties: During the printing process the paper is electrostatically charged to attract the toner. The paper must be able to release this charge so that printed sheets do not cling together in the output tray.

Whiteness: The contrast of the printed page depends on the whiteness of the paper. Whiter paper provides a sharper, brighter appearance.

Quality control: Uneven sheet size, corners that are not square, ragged edges, welded (uncut) sheets, and crushed edges and corners can cause the printer to malfunction in various ways. A quality paper supplier should take considerable care to ensure that these problems do not occur.

Packaging: Paper should be packed in a sturdy carton to protect it from damage during transport. Quality paper obtained from a reputable supplier is usually properly packaged.

B.3. Special Paper

The following types of special paper can be used:

- Overhead projection (OHP) film
- Adhesive-backed label paper
- Envelopes
- Colored paper
- Preprinted paper
- Recycled paper

Use paper that is sold specifically for use with copiers (heat-fusing type). OHP film, label paper, and envelopes should not be placed in the cassette; they must be fed manually and delivered in the face up stack.

Since the composition and quality of special paper vary considerably, special paper is more likely than white bond paper to give trouble during printing. No liability will be assumed if moisture etc. given off in printing on special paper causes harm to the machine or operator.

 **Before purchasing any type of special paper, test a sample on the printer and check that printing quality is satisfactory.**

Specifications for each type of special paper are given below.

Overhead Projection (OHP) Film

OHP film must be able to withstand the heat of fusing during the printing process. It should satisfy the conditions in Table B.3 .

Table B.3 OHP Film Specifications

Item	Specification
Tolerance of heat	Must tolerate at least 190°C (374°F)
Thickness	0.100 to 0.110 mm (3.9 to 4.3 mils)
Dimensional accuracy	±0.7 mm (±0.0276 in)
Squareness of corners	90° ±0.2°

To avoid trouble, OHP film must be delivered face-up.

If OHP film jams frequently, pull the top of the sheet very gently as it leaves the printer.

Adhesive-Backed Labels

The basic rule for printing on adhesive labels is that the adhesive must never come into contact with any part of the printer. Adhesive paper sticking to the drum or rollers will damage the printer.

Label paper must be manually fed.

Label paper has a structure comprising three layers, as shown in Figure B.1. The top sheet is printed on. The adhesive layer consists of pressure-sensitive adhesives. The carrier sheet (also called the linear or backing sheet) holds the labels until use. Due to the complexity of its composition, adhesive-backed label paper is particularly likely to give trouble in printing.

Adhesive label paper must be entirely covered by its top sheet, with no spaces between the individual labels. Labels with spaces in between are apt to peel off, causing serious jam problems.

Some label paper is manufactured with an extra margin of top sheet around the edge. Do not remove the extra top sheet from the carrier sheet until after printing is finished.

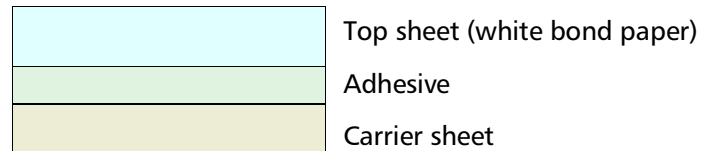
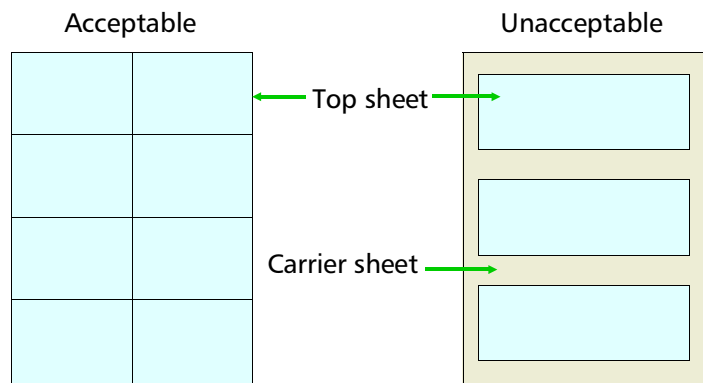

Figure B.1 Adhesive-back label



FigureB.2 Label arrangement

Table B.4 lists the specifications for adhesive label paper.

Table B.4 Adhesive Label Specifications

Item	Specification
Weight of top sheet	44 to 74 g/m ² (12 to 20 lbs/ream)
Composite weight	104 to 151 g/m ² (28 to 40 lbs/ream)
Thickness of top sheet	0.086 to 0.107 mm (3.9 to 4.2 mils)
Composite thickness	0.115 to 0.145 mm (4.5 to 5.7 mils)
Moisture content	4% to 6% (composite)

Envelopes

The printer can print on envelopes using paper with a basis weight of 60 to 79 g/m² (16 to 21 lbs/ream). Envelopes must be manually fed.

An envelope is a more complex object than a single sheet of paper. For this reason, it may not be possible to obtain consistent printing quality over the entire envelope surface.

Many envelopes have a diagonal grain orientation. (See *Paper Grain* above.) This orientation is more likely to wrinkle and crease on its way through the printer. Before purchasing envelopes for use with the printer, test a sample to verify the envelope's suitability.

Do not use envelopes having an encapsulated liquid adhesive.

Avoid long printing runs consisting of envelopes only. Extensive envelope printing can cause premature printer wear.

To avoid jamming due to curled envelopes, do not leave more than approximately 10 printed envelopes stacked in the paper trays during multiple printing of the envelopes.

Colored Paper

Colored paper should satisfy the same conditions as white bond paper, listed in Table B.1. In addition, the pigments used in the paper must be able to withstand the heat of fusing during the printing process (up to 200°C or 392°F).

Preprinted Paper

Preprinted paper should have a bond paper base. The preprinted ink must be able to withstand the heat of fusing during the printing process, and must not be affected by silicone oil.

Do not use paper with any kind of surface treatment, such as the type of paper commonly used for calendars.

Recycled Paper

Select recycled paper that meets the same specifications as the white bond paper (See Table B.1 on page B-2.) except whiteness.

 **Before purchasing recycled paper, test a sample on the printer and check that printing quality is satisfactory.**

Appendix C

Host Computer Interface

This appendix describes the signals used in the laser printer's parallel, RS-232C/RS-422A interfaces. It also lists pin assignments, signal functions, timings, connector specifications, and voltage levels. The RS-232C/RS-422A protocols are also covered. Finally, it explains the use of the printer in a multi-computer environment.

C.1. Parallel Interface

Parallel interface communication modes

The printer features the fast data transmission on the parallel interface. The parallel interface mode can be activated from the printer's control panel (see *Chapter 2, Operating the Page Printer*) as follows:

-  **Use a parallel printer cable that complies with the IEEE1284 standards.**

Auto

The printer automatically changes its communication mode to the one the host computer is currently using.

Normal

The printer uses the communication method described by the normal definitions of the Centronics interface.

High-speed

This mode enables faster data transmission between the printer and the host computer.

Interface Signals

The pins of the parallel interface connector carry the signals listed in Table C.1 . Asterisks in the table indicate signals that are active low. The table also indicates whether each signal is incoming or outgoing with respect to the printer.

Table C.1. Parallel Connector Pin Assignments

Pin	In/out	Description
1	In	Strobe* [nStrobe]
2	In	Data 0 [Data 1]
3	In	Data 1 [Data 2]
4	In	Data 2 [Data 3]
5	In	Data 3 [Data 4]
6	In	Data 4 [Data 5]
7	In	Data 5 [Data 6]
8	In	Data 6 [Data 7]
9	In	Data 7 [Data 8]
10	Out	Acknowledge* [nAck]
11	Out	Busy [Busy]
12	Out	Paper Empty [PErrror]
13	Out	On-Line (Select) [Select]
14	In	Auto-feed [nAutoFd]
15	—	Not connected
16	—	0V DC
17	—	Chassis GND
18	—	+5V DC
19	—	Ground return
20	—	Ground return
21	—	Ground return
22	—	Ground return
23	—	Ground return
24	—	Ground return
25	—	Ground return
26	—	Ground return
27	—	Ground return
28	—	Ground return
29	—	Ground return
30	—	Ground return
31	In	Ignored [nInit]
32	Out	Error*, returns error status if FRPO O2=2 [nFault]
33	—	—
34	—	Not connected
35	Out	Power Ready
36	In	Select In [NSelectIn]

[]: Signal names in the Auto mode. (IEEE 1284)

Detailed descriptions of the signals follow.

Strobe* [nStrobe] (Pin 1)

A negative-going Strobe* pulse causes the printer to read and latch the data on the Data 0 [1] to Data 7 [8] signal lines.

Data 0 [1] to Data 7 [8] (Pins 2 to 9)

These eight signals form the data byte sent from the host computer to the printer. Data 7 [8] is the most significant bit.

Acknowledge* [nAck] (Pin 10)

This negative-going pulse acknowledges the previous character received by the printer. Acknowledge* pulses are sent only when Busy is low.

Busy [Busy] (Pin 11)

This signal is high when the printer is busy and low when it is able to accept more data. Every high-to-low transition is followed by an Acknowledge* pulse.

Paper Empty [PError] (Pin 12)

This signal goes high when the printer runs out of paper.

On-Line [Select] (Pin 13)

This signal is high when the printer is on-line and low when the printer is off-line. It goes low when the upper unit is raised, or when the **ON LINE** key is pressed to set the printer off-line.

 **The Paper Empty and On-Line signals are not used unless enabled by the FRPO command (O2 parameter).**

Auto-Feed [nAutoFd] (Pin 14)

This signal is used in the Epson version of the Centronics interface to receive a carriage return. In high-speed mode, it is used as an interrupt.

+5V DC (pin 18)

This line is connected to the printer's +5V DC line (+5V ±0.5V, 250 mA maximum, fused).

Prime [nInit] (Pin 31)

This signal is used in the standard Centronics interface to enable the computer to reset the printer. It is ignored by the printer.

Error* [nFault] (Pin 32)

When the high-speed parallel line control is on (FRPO O2=2), this line returns error status.

Auxiliary output 1 (Pin 33)

This signal line is not used.

Power Ready (Pin 35)

This signal is high when the printer's power is on.

Select In [NSelectIn] (Pin 36)

This signal is used in some versions of the Centronics interface to enable the computer to force the printer on-line. In high-speed mode, it is used as an interrupt.

C.2. RS-232C/RS-422A Interface

RS-232C interface

Interface Signals

The pins of the printer's RS-232C interface connector carry the signals listed in Table C.2 . The table also indicates whether each signal is incoming or outgoing with respect to the printer.

Table C.2. RS-232C Signal Pin Assignments

Pin	In/out	Signal	Description
1	–	FG	Frame ground
2	Out	TXD	Transmit Data
3	In	RXD	Receive Data
4	Out	RTS	Request To Send
5	In	CTS	Clear To Send
6	In	DSR	Data Set Ready
7	–	SG	Signal Ground
20	Out	DTR	Data Terminal Ready

Brief descriptions of the signals follow.

FG – Frame Ground – (Pin 1)

This pin is connected directly to the printer frame.

TXD – Transmit Data – (Pin 2)

This output carries asynchronous data sent by the printer to the computer. It is used mainly in handshaking protocols.

RXD – Receive Data – (Pin 3)

This input carries serial asynchronous data sent by the computer to the printer.

RTS – Request To Send – (Pin 4)

This output is always held high (above 3 volts).

CTS – Clear To Send – (Pin 5)

DSR – Data Set Ready – (Pin 6)

Unused.

SG – Signal Ground – (Pin 7)

All signals can transmit between the printer and the host computer to send each signals with a signal ground.

DTR – Data Terminal Ready – (Pin 20)

This output is used as a buffer nearly-full handshake line. It is held high (above 3 volts) when the buffer can accept more data.

RS-232C Interface Voltage Levels

The voltage levels of the interface signals conform to EIA RS-232C specifications. SPACE is from 3 volts to 15 volts. MARK is from -3 volts to -15 volts. Voltages between -3 volts and 3 volts are undefined.

RS-422A interface

The serial interface of this printer was set to RS-232C mode before leaving the factory. However, by changing the jumper connector on the main circuit board, the interface can be changed to RS-422A mode.

In **RS-232C mode**, the printer can be connected to a personal computer (or similar device) equipped with an RS-232C serial interface. (The serial interface is set to RS-232C before leaving the factory.)

In **RS-422A mode**, the printer can be connected to a personal computer (or similar device) equipped with an RS-422A serial interface.

 **The changing of the main circuit board jumper connector should be carried out only by a Kyocera authorized dealer or Kyocera certified technician. Kyocera shall not be liable for damage due to improper changing of this main circuit board jumper connector.**

Removing the Main Circuit Board

 **The following instructions are intended for the technician only.**

Notes on Handling the Main Circuit Board

Protect the electronics by taking these precautions:

- Before touching the main circuit board, touch a water pipe or other large metal object to discharge yourself of static electricity. While doing the work, it is recommended that you wear an antistatic wrist strap.
- Touch the main circuit board only by the edge.

Withdrawing the Main Circuit Board from the Printer

-  **Be sure to remove the memory card first if inserted in the printer's memory card slot.**

Withdraw the main circuit board completely from the printer as follows:

1. Turn the printer's power off. Unplug the printer's power cable and disconnect the printer from the host computer.
2. Remove the three screws from the printer's rear cover.

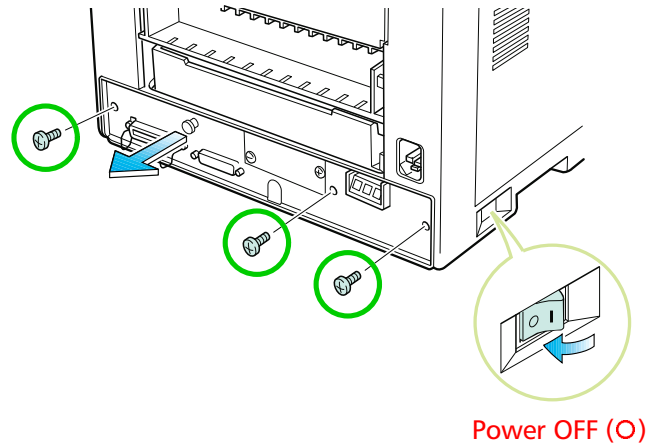

3. Pull the main circuit board all the way out of the printer.

-  **Before pulling the main board out, clean an area on the table, etc., at the back of the printer's rear panel. Foreign objects, accidentally sticking to the back of the main board, can cause serious damage to the printer.**

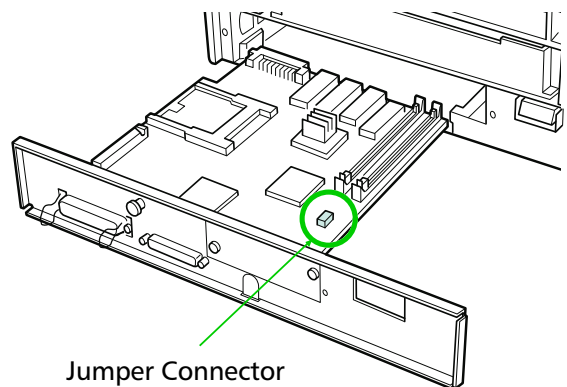

Changing the Jumper Connector

1. Carefully remove the jumper connector from the main circuit board, and reconnect to the pin position shown in the diagram.

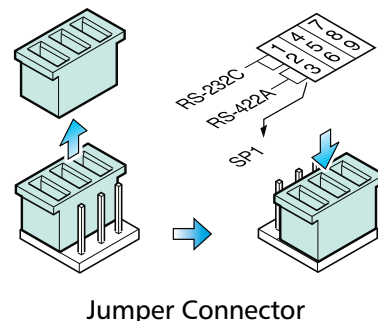

2. After completion of the above, return the main circuit board to the printer by reversing the procedure followed when removing it.

Verifying the Setting

The procedure described below should be followed to verify that the RS-422A mode had been correctly set.

1. Make sure the power switch is off. Plug the power cord into the printer and turn power on.
2. When the printer is on-line, press the **STATUS** key.
3. If the mode has been correctly set, "RS-422A" should be indicated on the status page printout. Please refer to the sample printout shown below.

[Printer Status Page]

```
-----
Interface dependent parameters
--Environment--      --Parameters--
User margins(inch)   RS422A/      PARALLEL
User top margin      00.00      00.00
User left margin     00.00      00.00
```

If RS-422A is indicated here, the setting was successful.

Interface Signals

The pins in the printer's RS-422A interface connector carry the signals listed in Table C.3 .

Table C.3. RS-422A Signal Pin Assignments

Pin	In/out	Signal	Description
1	–	FG	Frame ground
3	In	RDA	Receive data Inverted
7	–	SG	Signal ground
9	Out	SDA	Send data Inverted
10	Out	SDB	Send data
18	In	RDB	Receive data

Overview of Signals (RS-422A)

FG – Frame Ground – (Pin 1)

This pin is connected directly to the printer frame.

SG – Signal Ground – (Pin 7)

All signals can transmit between the printer and the host computer to send each signals with a signal ground.

RDB – Receive Data – (Pin 18)

RDA – Receive Data Inverted – (Pin 3)

These pins carry asynchronous data sent from the computer to the printer. (differential input)

SDB – Send Data – (Pin 10)

SDA – Send Data Inverted – (Pin 9)

These pins carry asynchronous data sent from the printer to the computer. (differential output)

RS-422A interface voltage levels

The interface signal voltage levels conform with the EIA RS-422A standard. The differential voltage varies from 200 mV to 6V.

SERIAL Connector

The connector marked "IOIOI" (RS-232C/RS-422A) on the rear panel is a DB-25S connector. Use a DB-25P connector (or equivalent) for the connector on the cable.

C.3. RS-232C/RS-422A Protocol

A protocol is a set of rules the computer follows in sending data to the printer. The RS-232C/RS-422A parameters are stored in battery backed-up memory. They are indicated on the status printout. They can be changed by the FRPO (firmware reprogram) command described in the *Programming Manual*. The parameters and their identification codes are given below.

H1: Baud rate

Parameter value	Baud rate
3	300
6	600
12	1200
24	2400
48	4800
96	9600
19	19200
38	38400
57	57600
11	115200

The factory setting is 9600 baud.

H2: Data bits

7 or 8, factory-set to 8.

H3: Stop bits

1 or 2, factory-set to 1.

H4: Parity

Parameter value	Meaning
0	None
1	Odd
2	Even
3	Ignore

The factory setting is "None" (0 on the status printout).

H5: Protocol logic

Parameter value	Meaning
0	Combination of 1 and 3 below
1	DTR/DSR, positive logic
2	DTR/DSR, negative logic
3	XON/XOFF
4	ETX/ACK
5	XON/XOFF recognized only as protocol

The factory setting is 0.

H6: Buffer nearly-full threshold

This is a percentage from 0 to 99. The factory setting is 90.

H7: Buffer nearly-empty threshold

This is a percentage from 0 to 99. The factory setting is 70.

The factory settings of the buffer nearly-full and nearly-empty thresholds (H6 and H7) are subject to change without notification.

The gap between the nearly-full and nearly-empty thresholds allows the computer to send a fairly large amount of data in a continuous stream.

H8: Received-data buffer size

This is the size of the input buffer, specified in units of 10K bytes. The factory-set value is 6 meaning 60K bytes.

 **Since DTR/DSR protocol is not used with the RS-422A standard, select a parameter value other than 0, 1, or 2 for the H5 setting when using the RS-422A interface.**

PRESCRIBE II FRPO D0 command

The PRESCRIBE II FRPO D0 command is provided to allow manipulating XON/XOFF when an error has occurred on the serial interface. The following table summarizes the error status corresponding to different D0 values.

		Serial interface error	
		error not handled	error handled
Timing of XON transfer to host while Ready or Waiting	XON sent every 3-5 seconds	D0 = 0 (default)	D0 = 1
	XON not sent	D0 = 10	D0 = 11

C.4. RS-232C Cable Connection

Preparing an RS-232C Cable

After obtaining an RS-232C cable, check that it is wired correctly, referring to the pin assignment table in *Appendix C*. If you have an IBM communication adapter cable type 1502067, you will have to resolder the wiring at the printer end of the cable. The procedure is as follows.

1. Unscrew the plastic cover from the printer end of the cable.
2. Next to each of the wires inside the cable is a bare shield wire. Solder all these shield wires together into a single bundle.
3. Using a section of flat wire about 3 mm wide and 15 mm long, connect the bundle of shield wires to the metal facing of the connector. Check that the solder connections are secure.
4. Desolder wires 2 and 3, then resolder them in crossed configuration. Solder wire 2 to pin 3 and wire 3 to pin 2. Cover the solder joints with thermofit tube.
5. Cut wires 4, 5, 6, and 20.
6. Solder wires 5 and 6 together and connect them to pin 20. Cover the solder joints with thermofit tube. Leave wire 4 unconnected.
7. Tape all remaining loose ends, or seal them with thermofit tube.
8. Screw the plastic cover back on.

Connecting the Printer to the Computer

1. Check that the power of both the printer and computer is switched off.
2. Discharge yourself by touching a metal object such as a doorknob.
3. Remove the plastic cap from the printer's RS-232C interface connector.
4. Plug the printer end of the RS-232C interface cable into the printer's RS-232C connector and screw it in place.
5. Plug the other end of the cable into the computer's RS-232C interface connector.
6. Switch on the printer's power.
7. The printer's RS-232C parameters are factory-set to the following values:

Baud rate=9600 bps, Data bits (character length)=8 bits,
Stop bits=1, Parity=None

The three RS-232C protocols are XON/XOFF and DTR. The printer performs all three of them simultaneously, using positive logic for DTR.

If you are uncertain as to the printer's current parameter settings, you can reset them to the values listed above by following the manner described in the last page in this manual.

8. Set the computer to the same parameters as the printer. On many computers this can be done by setting DIP switches before power is turned on. Another method is as follows:

In DOS, enter the following commands:

```
C>MODE COM1:96,N,8,1,P  
C>MODE LPT1:=COM1
```

To test the interface, then enter:

```
CTRL P  
C>DIR  
CTRL P
```

The software settings made by the procedures above are temporary. On most computers, permanent settings must be made with DIP switches.

If you want to use a different baud rate or change any of the other RS-232C parameters, you can use the printer's FRPO (firmware reprogram) command. See the *Programming Manual* for details.

Index

A

Abandoning a printing job 2-7
 Adhesive label B-6
 Amorphous silicon drum ix
 AppleTalk interface kit (IB-3) 1-15
 Auto cassette 2-13
 Automatic manual feeding 1-20

B

Bit pattern 3-2
 Bitmap font
 naming format 3-2
 Bitmap fonts 3-2, 3-3
 Buzzer (Audio warning) 2-18

C

Cassette size B-3
 Centronics 1-13
 Cleaning
 grid cleaner 4-1, 4-7
 main charger unit 4-6
 paper feed unit 4-8
 Code set 2-12
 Code sets *Last page*
 Contents of carton 1-4
 Control keys
 - key 2-5
 + key 2-5
 CANCEL key 2-5
 CONT key 2-5
 ENTER key 2-5
 EXIT key 2-5
 FEED keys 2-5
 FORM FEED key 2-5
 MODE key 2-5
 ON LINE key 2-5
 STACK key 2-5
 STATUS key 2-5
 Control panel
 control keys 2-5
 INTERFACE indicator 2-2
 message display 2-2
 PAPER SIZE indicator 2-3

RESOLUTION indicator 2-2
 symbolic indicators 2-4
 COPY indicator 2-3

D

Developer unit 1-8
 Downloadable font 3-1
 Ecoprint mode 2-16

E

Ecopower mode x, 2-14
 Ecoprint x
 setting 2-16
 Emulation 2-12, *Last page*
 code set *Last page*
 Envelopes B-7
 Error Messages
 resolution changing 5-10
 Error messages
 Battery error
 MEMORY CARD 5-9
 Format error
 MEMORY CARD 5-9
 I/F occupied 5-10
 image fit 5-10
 Insert the same
 MEMORY CARD 5-9
 MEMORY CARD err
 Insert again 5-9
 Memory overflow
 ..Press CONT 5-1, 5-9
 MEMORYCARD err ##
 .. Press CONT 5-10
 Print overrun
 ..Press ON LINE 5-9
 Read fonts failed 5-10
 Warning battery
 MEMORY CARD 5-9
 Expansion memory 1-23
 Extension cord 1-2

F

Face-up output tray
 install 1-12
 Feed selection 2-7
 Font
 bitmap font 3-2
 definition 3-1
 identifying characteristics 3-1
 scalable font 3-2
 symbol sets 3-11
 Form feed 2-11
 Form Feed Time out 2-2

G

Grid cleaner 4-1, 4-2

I

Indicators 5-7
 ATTENTION 2-4, 5-7
 DATA 2-4
 ON LINE 2-4
 Installing the printer 1-1
 basic requirements 1-2
 clearance 1-1
 location 1-1
 place to avoid 1-1
 power requirements 1-2
 Interfaces 1-13
 Interior view 1-6

K

KIR
 density control 2-15
 levels 2-15
 setting 2-15
 test pattern page 5-1
 KPDL 3-1, *Last page*
 Kyocera Digital Library xi
 User's Manual xi
 Kyocera PrintMonitor (KPM) x

M

Macintosh computer
 AppleTalk interface
 kit (IB-3) 1-15
 PostScript upgrade kit 1-15
 Main circuit board 1-23, C-6
 Maintenance messages
 Add paper 5-8
 Call service person En 5-9
 Call service person Fn 5-9
 Clean printer
 ..Press CONT 5-8
 Face-down tray paper full 5-8
 Load paper 5-8
 Missing Waste-
 toner bottle 5-8
 Paper feed unit Open 5-8
 Paper jam 5-8, 5-11
 Replace Toner
 Clean printer 5-8
 Replace Waste-
 toner bottle 5-8
 Set paper Press CONT 5-8
 Side cover Open 5-8
 Toner low TK-20
 Clean printer 5-4 - 5-5, 5-8
 Top cover Open 5-8
 Warning Low memory 5-8
 Memory card 3-1
 Delete 2-22
 Format 2-23
 handling 1-22
 ICCD command 2-21, 5-10
 insert 1-21
 List of data names 2-24
 Partition 2-24
 Read fonts/data 2-20
 remove 1-21
 Writing data 2-21
 Memory expansion
 installing 1-23
 minimum memory
 requirements 1-23
 Message display 2-2
 Mode select menu 2-12
 Multi-purpose tray 1-17
 cassette mode 1-18
 first mode 1-20
 manual mode 1-19
 OHP film 1-20
 paper guides 1-17
 protector bar 1-17
 selecting 1-17
 sub tray 1-17

N

Names of parts
 front view 1-5
 interior view 1-6
 rear view 1-6
 Net work x
 Note on power 1-3

O

OHP film B-5
 On Line 2-7
 Option interface 2-2
 Options xi

P

Packing 1-3
 Paper B-3
 adhesive label B-6
 colored paper B-7
 condition B-2
 envelope B-7
 grain B-4
 OHP film B-5
 preprinted paper B-7
 recycled paper B-7
 selection B-1
 size B-3
 special paper B-5 - B-7
 specifications B-2
 thickness B-3
 type 2-13
 weight B-3
 Paper cassette 1-11
 clips 1-11
 paper limit 1-11
 Paper feed unit
 release lever 1-5, 4-8
 Paper jam 1-2, 5-11
 Paper stopper 1-12
 Parallel interface 1-13, 2-2, C-1
 bi-directional/high-speed x
 clips 1-13
 communication modes C-1
 pin assignments C-2
 transmission mode 2-12
 Partition 2-24
 PDF417 x, xii
 Plastic bag 4-2
 Please wait 2-2
 PostScript 3-3
 Power cord 1-13

Power requirement 1-2
 Power switch 2-6
 PRESCRIBE command xii
 FRPO IO command 2-20
 PRESCRIBE commands
 2-5, 2-10, 5-6
 FRPO D0 command C-11
 FRPO IO command 2-20
 ICCD command 2-24
 Print density 2-17
 Print quality 5-3
 Printer driver 1-15
 Processing 2-2
 Protocol C-10

R

Ready 2-2
 Ready indicator 2-6
 Recycled paper B-7
 Registration roller 4-8
 Resident fonts 3-3
 Resolution 2-2
 Resource protection 2-17
 RS-232C 1-6, 2-2, C-5
 cable C-12
 pin assignments C-5
 RS-232C/422A C-12 - C-13
 RS-422A 1-6, 2-2, C-6
 jumper connector C-7
 pin assignments C-8

S

Scalable font 3-2
 outline 3-2
 Self test 2-2
 Serial interface 2-2, C-5
 PRESCRIBE FRPO
 D0 command C-11
 protocol C-10
 RS-232C mode C-6
 RS-422A mode C-6
 Set up 1-7
 Setup
 emulation 1-14
 face-up output tray 1-12
 interface 1-13
 paper 1-11
 paper cassette 1-11
 paper stopper 1-12
 power cord 1-13
 printer driver 1-15
 status page printing 1-14
 toner container 1-8

- SIMM
- installing 1-26
 - removing 1-26
 - sockets 1-24
 - test 1-27
- Simple Network Management Protocol (SNMP) x
- Sleep mode x, 2-14
- Please wait 2-14
 - Sleeping 2-14
- Sleep timer 2-14
- Soft fonts 3-1
- Stack selection 2-6
- Status page 1-14
- printing 2-8, 5-1
- Symbol sets 3-11, 6-1
- Diablo 630 symbol sets 6-8
 - HP LaserJet 4 Plus
 - symbol sets 6-13
 - IBM symbol sets 6-2
 - LQ-850 symbol sets 6-11
- T**
- Temperature and humidity 1-2
- Thick paper 2-13
- TK-20/TK-20H 4-1
- Toner container 4-2
- dispose 4-2
 - installing 1-8
 - life 4-1
 - release lever 4-2
 - replacement 4-1
 - sealing strip 1-8, 4-3
- Toner kit 4-1
- Top cover 1-8 - 1-9
- Troubleshooting
- error messages 5-9
 - guidelines 5-1
 - indicators 5-7
 - interface 5-2
 - maintenance messages 5-8
 - quality problem 5-3
- Two-dimensional bar code (PDF417) x
- Typeface 3-1
- U**
- User s Manual xii
- W**
- Waiting 2-2
- Waste toner bottle 1-9
- Windows 1-15
- Wiper cloth 4-8

Free Manuals Download Website

<http://myh66.com>

<http://usermanuals.us>

<http://www.somanuals.com>

<http://www.4manuals.cc>

<http://www.manual-lib.com>

<http://www.404manual.com>

<http://www.luxmanual.com>

<http://aubethermostatmanual.com>

Golf course search by state

<http://golfingnear.com>

Email search by domain

<http://emailbydomain.com>

Auto manuals search

<http://auto.somanuals.com>

TV manuals search

<http://tv.somanuals.com>