

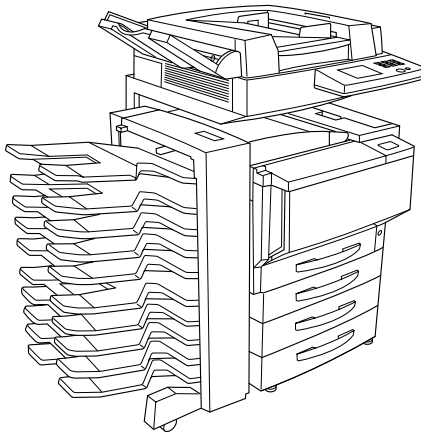

4004-7734-12

KM-C1530

INSTRUCTION HANDBOOK



Please read the instruction handbook before using the copier.

As an ENERGY STAR Partner, KYOCERA MITA AMERICA, INC. has determined that this product meets the ENERGY STAR guidelines for energy efficiency.

* ENERGY STAR is a U.S. registered mark.

All rights reserved. No part of this material may be reproduced or transmitted in any form or by any means, electronic or mechanical, including photocopying, recording or by any information storage and retrieval system, without permission in writing from the Publisher.

Legal Restriction On Copying

- It may be prohibited to copy copyrighted material without permission of the copy-right owner.
It is prohibited under any circumstances to copy domestic or foreign currencies.
Copying other items may be prohibited

Please read the instruction handbook before using the copier. Keep it in the designated location for easy reference.

The sections of this handbook and parts of the copier marked with symbols are safety warnings meant to protect the user, other individuals and surrounding objects, and ensure correct and safe usage of the copier. The symbols and their meanings are indicated below.

⚠ DANGER: Indicates that serious injury or even death will very possibly result from insufficient attention to or incorrect compliance with the related points.

⚠ WARNING: Indicates that serious injury or even death may result from insufficient attention to or incorrect compliance with the related points.

⚠ CAUTION: Indicates that personal injury or mechanical damage may result from insufficient attention to or incorrect compliance with the related points.

Symbols

The  symbol indicates that the related section includes safety warnings. Specific points of attention are indicated inside the symbol.



..... [General warning]



..... [Warning of danger of electrical shock]



..... [Warning of high temperature]

The  symbol indicates that the related section includes information on prohibited actions. Specifics of the prohibited action are indicated inside the symbol.



..... [Warning of prohibited action]



..... [Disassembly prohibited]

The  symbol indicates that the related section includes information on actions which must be performed. Specifics of the required action are indicated inside the symbol.



..... [Alert of required action]



..... [Remove the power plug from the outlet]



..... [Always connect the copier to an outlet with a ground connection]

Please contact your service representative to order a replacement if the safety warnings in the handbook are illegible or if the handbook itself is missing. (fee required)

1 IMPORTANT! PLEASE READ FIRST

⚠ CAUTION LABELS	1-1
⚠ INSTALLATION PRECAUTIONS	1-4
⚠ PRECAUTIONS FOR USE	1-6
LED Radiation Safety	1-11
1.1 Explanation of Basic Concepts and Symbols	1-11
Paper Feeding	1-11
“Width” and “Length”	1-12
Paper Orientation	1-12
Display Icons	1-12

2 Before Making Copies

2.1 Available Features	2-1
2.2 Components and Their Functions	2-6
2.3 Parts Names and Their Functions	2-10
Outside of Copier.....	2-10
Inside of Copier	2-12
Supplies and Parts	2-13
Duplexing Document Feeder (Optional)	2-14
Duplex Unit (Optional)	2-15
10-Mailbin Sorter (Optional)	2-16
Finisher (Optional)	2-17
Paper Feed Unit (Optional).....	2-18
Large-Capacity Cabinet (Optional)	2-19
Printer Controller FIERY X3e	2-19
2.4 Names of Control Panel Parts and Their Functions	2-20
Names of Control Panel Parts and Their Functions	2-20
2.5 Using the Touch Panel	2-22
Description of Touch Panel	2-22
Organization of Screens	2-22
Operating the Touch Panel.....	2-24
2.6 Useful Operations	2-25
Cancelling Settings.....	2-25
Auto Panel Reset.....	2-25
Energy Saver Mode	2-26
Delayed Copy Jobs	2-26
Sleep Mode	2-26
Interrupting Copy Jobs	2-27
To interrupt a copy job	2-27
Auto Paper Source Change Feature	2-27
Access Codes.....	2-28

To enter an access code.....	2-28
Printing From the Computer.....	2-28
Scanning From the Computer.....	2-28
2.7 Power Switch and Default Settings.....	2-29
Turning the copier on and off.....	2-29
To turn the copier on.....	2-29
To turn the copier off.....	2-29
Turning On the Copier.....	2-30
Default Settings.....	2-30

3 Copy Paper

3.1 Paper Specifications.....	3-1
Paper Types.....	3-1
Paper Sizes.....	3-2
Paper Types To Be Avoided.....	3-5
3.2 Print Area.....	3-6
3.3 Paper Storage.....	3-6
3.4 Loading Paper.....	3-7
To load paper into the 1st drawer (250-sheet multipurpose tray) ...	3-7
To set the paper size for the 1st drawer.....	3-11
To load paper into the 2nd drawer or the 500-sheet paper feed unit.....	3-13
To load paper into the large-capacity cabinet.....	3-15
To load paper into the manual bypass tray.....	3-17

4 Original Documents

4.1 Feeding the Document.....	4-1
Document Paper Types.....	4-2
Precautions for Multi-Sheet Feeding and Single-Sheet Feeding ...	4-2
Precautions for Manual Feeding.....	4-3
4.2 Feeding the Document Through the Duplexing Document Feeder.....	4-4
Multi-Sheet Feeding (Sheet Documents).....	4-4
To make copies using multi-sheet feeding (sheet documents).....	4-4
Multi-Sheet Feeding (Documents of Mixed Sizes).....	4-5
To make copies using multi-sheet feeding (documents of mixed sizes).....	4-6
Single-Sheet Feeding (Standard Paper/Thick Paper).....	4-7
To make copies using single-sheet feeding.....	4-7
Single-Sheet Feeding (Thin Paper).....	4-9
To make copies using single-sheet feeding.....	4-9

4.3	Positioning the Document on the Original Glass	4-10
	Manual Feeding (Sheet Documents).....	4-11
	To make copies using manual feeding (sheet documents)	4-11
	Manual Feeding (Transparent or Translucent Documents).....	4-12
	To make copies using manual feeding (transparent or translucent documents).....	4-12
	Manual Feeding (Books)	4-13
	To make copies using manual feeding (books).....	4-13
	Manual Feeding ("12-1/4 x 18" Paper)	4-14
	To make copies using manual feeding ("12-1/4 x 18" paper).....	4-14

5 Basic Operations

5.1	Making Copies	5-1
	To copy a document (To make a basic copy).....	5-1
5.2	Selecting the Paper Source	5-4
	To select the paper source before copying	5-4
5.3	Making Copies on Paper Loaded into the 1st Drawer (Multipurpose Paper Drawer)	5-5
	To copy a document.....	5-6
5.4	Feeding Paper Manually	5-7
	To feed the paper manually.....	5-7
	To make copies onto overhead projector transparencies.....	5-9
	To make copies onto postcards.....	5-11
	To make copies onto thick paper.....	5-12
5.5	Specifying a Zoom Setting	5-14
	To specify the zoom ratio before copying.....	5-15
	To record a zoom ratio	5-16
	To recall a recorded zoom ratio.....	5-17
5.6	Selecting the Original Image Type	5-18
	To select the document type before copying.....	5-19
5.7	Specifying the Copy Density	5-20
	To specify the copy density before copying.....	5-20
5.8	Interrupting a Copy Job	5-22
	To interrupt a copy job.....	5-22

6 Advanced Operations

6.1	Making Single-Sided/Double-Sided Copies	6-1
	Single-Sided ► Single-Sided:.....	6-1
	Single-Sided ► Double-Sided:.....	6-1
	Single-Sided ► Single-2in1:.....	6-1
	Single-Sided ► Double-2in1:	6-2

	Double-Sided ► Single-Sided:	6-2
	Double-Sided ► Double-Sided:	6-2
	Book (Separation) ► Single-Sided:	6-2
	Book (Spread) ► Single-Sided:	6-3
	Book (either Standard Book or RightBound) ► Book Erase:	6-3
	To make settings for single- or double-sided documents and copies	6-4
	To make settings for copying a book	6-5
6.2	Finishing (“Sort” and “Group” settings)	6-8
	Non-Sort:	6-8
	Sort:	6-8
	Group:	6-9
	Sorting/Grouping	6-10
	To select the finishing settings	6-11
6.3	Staple Binding	6-12
	Types of stapling	6-12
	Staple position	6-13
6.4	Hole Punching (“Hole-Punch” Setting)	6-15
	Types of hole punching	6-15
	Punched hole position:	6-15
6.5	Feeding Documents of Different Sizes (“Mixed Orig Detection” Function)	6-17
	To set the “Mixed Orig Detection” function	6-17
6.6	Erasing Edges (“Frame Erase” Function)	6-19
	To set the “Frame Erase” function	6-19
6.7	Creating Mirror Image Copy (“Mirror Image” Function)	6-21
	To set the “Mirror Image” function	6-21
6.8	Improving Copy Quality (“Color Adjustment” Function)	6-23
	To make color adjustments	6-23
	To make test prints	6-24
	To adjust the hue	6-25
	To adjust the saturation	6-25
	To adjust the brightness	6-26
	To adjust the sharpness	6-27
	To adjust the contrast	6-27
	To adjust the color balance	6-28
	To adjust the density	6-29
6.9	Inserting Pages Between Copies of Overhead Transparencies (“OHP Interleaving” Function)	6-30
	To set the “OHP Interleaving” function	6-30

6.10	Specifying Different Vertical and Horizontal Scaling Proportions (“X/Y Zoom” Function)	6-32
	To specify the vertical and horizontal scaling proportions	6-32
6.11	Reducing the Document to Postcard Size and Printing Multiple Copies on One Page (“Postcard” Function)	6-33
	To set the “Postcard” function	6-33
6.12	Tiling Copies (“Image Repeat” Function)	6-35
	To set the “Image Repeat” function	6-35

7 Utility Mode Operations

7.1	Resetting the Copier (“Default Settings” Function).....	7-1
	To specify the default settings	7-1
7.2	Viewing Counters (“Meter Count” Function)	7-2
	To view the meter counts	7-3
7.3	Storing and Recalling Jobs (“Job Memory Input” Function) ...	7-4
	To store a job.....	7-4
	To delete a job.....	7-5
	To recall a stored job	7-6
7.4	Specifying Default Settings (“User’s Choice” Function).....	7-8
	To change the User’s Choice settings.....	7-8
	To set the “Language selected” parameter	7-9
	To set the “2in1copy zoom” parameter.....	7-10
	To set the “Intelligent Sorting” parameter	7-11
	To set the “ACS Determination level Adjust.” parameter.....	7-12
	To set the “Confirmation Beep” parameter	7-13
	To set the “Mail Bin Assignment” parameter	7-14
	To set the “Auto Panel Reset” parameter	7-15
	To set the “Energy Save Mode” parameter	7-16
	To set the “Sleep Mode” parameter.....	7-17
	To set the “1st Drawer Paper Select” parameter.....	7-18

8 Administrator Mode Operations

8.1	Supervising Copier Use (“Copy Track” Function)	8-1
	To change the Administrator Mode settings	8-1
	To register access codes.....	8-3
	To change the account numbers registered	8-4
	To reset Copy Track mode	8-6
	To check the number of copies made by each account	8-7
	To reset the counters for each account.....	8-8
	To limit the type of copies for an account	8-9
	To limit the number of copies for an account.....	8-11

8.2	Adjusting the Gradation Levels (“Gradation Adjust” Function).....	8-13
	To adjust the gradation levels	8-13
8.3	Turning off the Sleep function (“Disable Sleep Mode” Function).....	8-15
	To turn off the Sleep function	8-15
8.4	Erasing Copy Edges (“Erase” Function)	8-18
	To set the “Erase” function.....	8-18
8.5	Specifying the Expert Settings (“Expert User’s Mode” Function).....	8-20
	To change the Expert User’s Mode settings	8-20
	To set the “Thick Paper and OHP Film Image Density” parameter.....	8-22
	To set the “Color Shift Correction” parameters	8-23
	To set the “Stabilizer” parameter.....	8-26
	To set the “PRT Area (Top Margin)” parameter	8-27
	To set the “PRT Area (Left Margin)” parameter	8-29
	To set the “PRT Area (Dup. Left Margin)” parameter.....	8-31
	To set the “Thin Orig.” parameter.....	8-33
8.6	Registering Scan Save Locations (“Scanner Addr. Input” Function).....	8-34

9 Touch Panel Messages

9.1	When the Message “Replenish paper.” Appears.....	9-1
	To load paper into the 1st drawer (250-sheet multipurpose paper drawer).....	9-2
	To load paper into the 500-sheet paper feed unit	9-3
	To load paper into the large-capacity cabinet	9-5
9.2	When the Message “Please add Toner.” Appears	9-6
	To add toner.....	9-8
9.3	When the Message “Replace Staple Cartridge X.” Appears....	9-11
	To replace the staple cartridge.....	9-11
9.4	When the Message “Misfeed detected.” Appears.....	9-16
	Paper Misfeed in the Manual Bypass Tray	9-19
	To clear a paper misfeed in the manual bypass tray	9-19
	Paper Misfeed in the Duplex Unit.....	9-21
	To clear a paper misfeed in the duplex unit	9-21
	Paper Misfeed in the Paper Feed Unit.....	9-22
	To clear a paper misfeed in the paper feed unit.....	9-22
	Paper Misfeed in the Copier.....	9-24
	To clear a paper misfeed in the copier.....	9-24
	Paper Misfeed in the Duplexing Document Feeder	9-28
	To clear a paper misfeed in the duplexing document feeder	9-28

	Paper Misfeed in Finisher F-8110/F-8430	9-30
	To clear a paper misfeed in finisher F-8110/F-8430.....	9-30
	Paper Misfeed in the 10-Mailbin Sorter	9-34
	To clear a paper misfeed in the 10-mailbin sorter	9-34
9.5	When the Message “Cannot staple.” Appears	9-37
	To clear jammed staples	9-37
9.6	When the Inspection Mark “” Appears	9-41
9.7	When the Message “Malfunction detected.” Appears	9-42
9.8	When the Message “Need to Replace XXXXX.” Appears	9-43
9.9	Other Messages.....	9-44

10 Troubleshooting

10.1	When Incorrect Copies are Produced	10-1
10.2	When the Copier Is Not Operating Correctly	10-3

11 Appendix

11.1	Specifications	11-1
	Copier KM-C1530.....	11-1
	Duplexing Document Feeder RADF-11	11-3
	500-sheet Paper Feed Unit ST-530.....	11-3
	Large-capacity Cabinet ST-2500.....	11-4
	Duplex Unit AD-35.....	11-4
	10-Mailbin Sorter AS-M4110	11-5
	Finisher F-8430	11-6
	Finisher F-8110	11-7
11.2	Care of the Copier	11-8
	Cleaning	11-8
	Housing cover.....	11-8
	Original glass.....	11-8
	Operation panel.....	11-8
	Document transfer belt	11-9
11.3	Function Combination Table	11-10
	Function combination table.....	11-10
	Function combination code keys	11-12
11.4	Paper Size and Zoom Ratio Tables.....	11-13
	Paper sizes.....	11-13
	Zoom ratios.....	11-14

1 IMPORTANT! PLEASE READ FIRST



CAUTION LABELS

Caution labels have been attached to the copier at the following locations for safety purposes. BE SUFFICIENTLY CAREFUL to avoid fire or electric shock when removing a paper jam or when replacing toner.

Label 1

This unit has more than one power-supply cord. To reduce the risk of electric shock disconnect all power supply cords before servicing. Only connect this equipment to an earthed socket outlet.

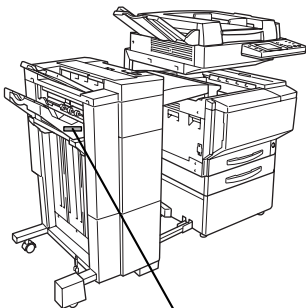
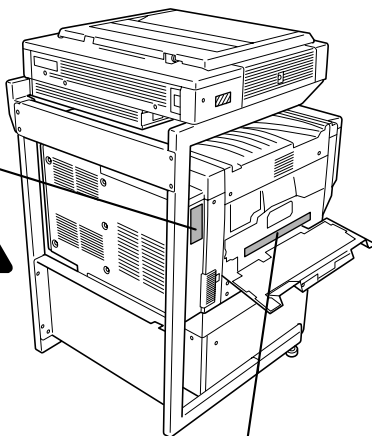

Label 3

Keep the space below this tray clear and unobstructed.



Label 2

Do not incinerate toner and toner containers. Dangerous sparks may cause burns.

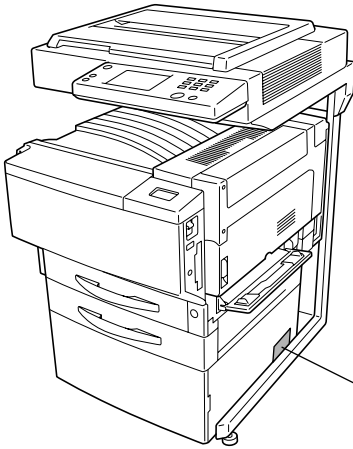

NOTE: DO NOT remove these labels.

**Label 4**

To reduce the risk of injury due to unstable equipment, use stabilizers before use.

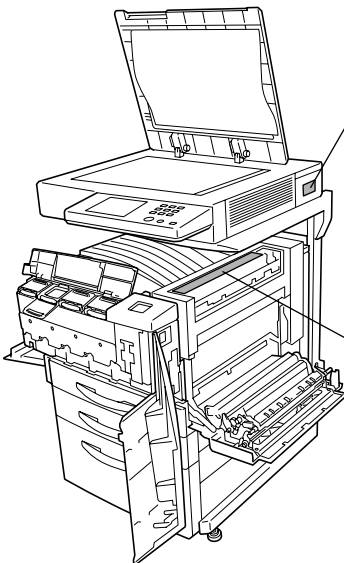
**Label 5**

This unit has more than one power-supply cord. To reduce the risk of electric shock disconnect all power supply cords before servicing. Only connect this equipment to an earthed socket outlet.

**Label 6**

High temperature inside. Do not touch parts in this area, because there is a danger of getting burned.



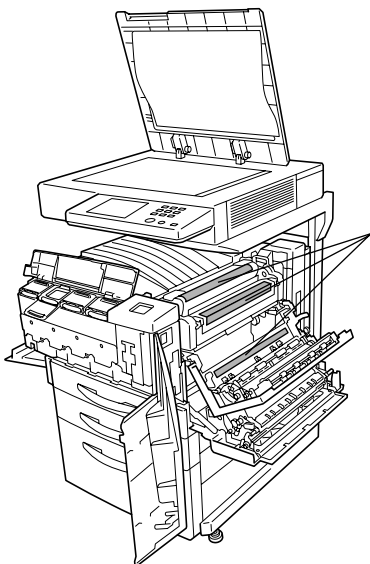

Label 7
High temperature inside. Do not touch parts in this area, because there is a dange of getting burned.

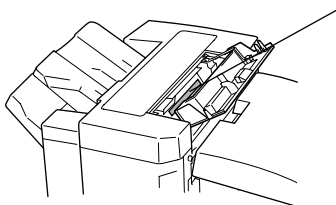

Label 8
High temperature inside. Do not touch parts in this area, because there is a dange of getting burned.



! INSTALLATION PRECAUTIONS

Environment

! CAUTION

- Avoid placing the copier on or in locations which are unstable or not level. Such locations may cause the copier to fall down or fail over. This type of situation presents a danger of personal injury or damage to the copier.....
- Avoid locations with humidity or dust and dirt. If dust or dirt become attached to the power plug, clean the plug to avoid the danger of fire or electrical shock.....
- Avoid locations near radiators, heaters, or other heat sources. or locations near flammable items, to avoid the danger of fire.
- To keep the copier cool and facilitate changing of parts and maintenance, allow access space as shown below. Leave adequate space, especially around the left cover, to allow air to be properly ventilated out of the copier.

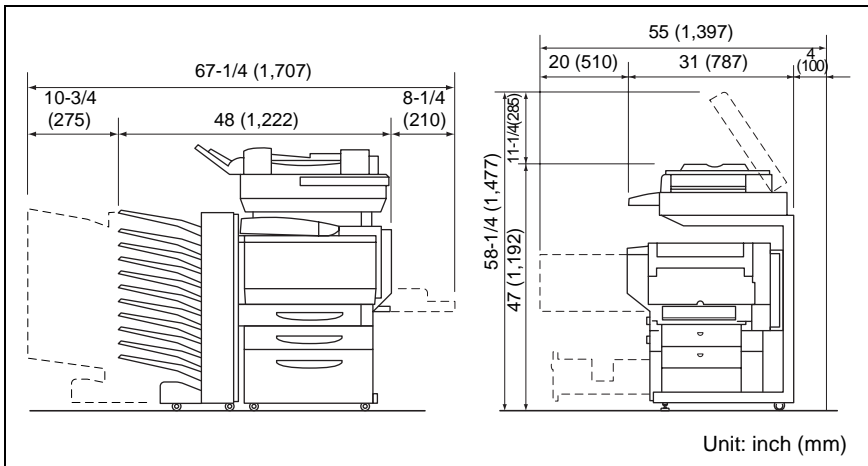

- Always use the caster stoppers to stabilize the copier once it is in place to keep it from moving and/or falling over and causing injury, in case of installing the large capacity cabinet and the scanner rack.....



Other precautions

- Adverse environmental conditions may affect the safe operation and performance of the copier. Install in an air-conditioned room (recommended room temperature: around 68°F, humidity: around 65%RH) and avoid the following locations when selecting a site for the copier.
 - Avoid locations near a window or with exposure to direct sunlight.
 - Avoid locations with vibrations.
 - Avoid locations with drastic temperature fluctuations.
 - Avoid locations with direct exposure to hot or cold air.
 - Avoid poorly ventilated locations.

Power supply/Grounding the copier

⚠ WARNING

- DO NOT use a power supply with a voltage other than that specified. Avoid multiple connections in the same outlet. These types of situations present a danger of fire or electrical shock.
- Plug the power cord securely into the outlet. If metallic objects come in contact with the prongs on the plug, it may cause a fire or electric shock.....
- Always connect the copier to an outlet with a ground connection to avoid the danger of fire or electrical shock in case of an electric short. If an earth connection is not possible, contact your service representative.



Other precautions

- Connect the power plug to the closest outlet possible to the copier.
- The power supply cord is used as the main disconnect device. Ensure that the socket/outlet is located/installed near the equipment and is easily accessible.

Handling of plastic bags

⚠ WARNING

- Keep the plastic bags that are used with the copier away from children. The plastic may cling to their nose and mouth causing suffocation.....



PRECAUTIONS FOR USE

Cautions when using the copier

WARNING

- DO NOT place metallic objects or containers with water (flower vases, flower pots, cups, etc.) on or near the copier. This type of situation presents a danger of fire or electrical shock should they fall inside.
- DO NOT remove any of the covers from the copier as there is a danger of electrical shock from high voltage parts inside the copier.....
- DO NOT damage, break or attempt to repair the power cord. DO NOT place heavy objects on the cord, pull it, bend it unnecessarily or cause any other type of damage. These types of situations present a danger of fire or electrical shock.
- NEVER attempt to repair or disassemble the copier or its parts as there is a danger of fire, electrical shock or damage to the laser. If the laser beam escapes, there is a danger of it causing blindness.
- If the copier becomes excessively hot, smoke appears from the copier, there is an odd smell, or any other abnormal situation occurs, there is a danger of fire or electrical shock. Turn the power switch OFF immediately, remove the power plug from the outlet and contact your service representative.
- If anything harmful (paper clips, water, other fluids, etc.) falls into the copier, turn the power switch OFF immediately. Next, remove the power plug from the outlet to avoid the danger of fire or electrical shock. Then contact your service representative.
- DO NOT remove or connect the power plug with wet hands, as there is a danger of electrical shock.
- ALWAYS contact your service representative for maintenance or repair of internal parts.....



⚠ CAUTION

- DO NOT pull the power cord when removing it from the outlet. If the power cord is pulled, the wires may become broken and there is a danger of fire or electrical shock. (ALWAYS grasp the power plug when removing the power cord from the outlet.).....
- ALWAYS remove the power plug from the outlet when moving the copier. If the power cord is damaged, there is a danger of fire or electrical shock.....
- If the copier will not be used for a short period of time (overnight, etc.), turn the power switch OFF.
If it will not be used for an extended period of time (vacations, etc.), remove the power plug from the outlet for safety purposes during the time the copier is not in use.
- ALWAYS hold the designated parts only when lifting or moving the copier.
- For safety purposes. ALWAYS remove the power plug from the outlet when performing cleaning operations.
- If dust accumulates within the copier, there is a danger of fire or other trouble. It is therefore recommended that you consult with your service representative in regard to cleaning of internal parts. This is particularly effective if accomplished prior to seasons of high humidity.
Consult with your service representative in regard to the cost of cleaning the internal parts of the copier.



Other precautions

- DO NOT place heavy objects on the copier or cause other damage to the copier.
- DO NOT open the front cover, turn off the power switch, or pull out the power plug during copying.
- During copying, some ozone is released, but the amount does not cause any ill effect to one's health. If, however, the copier is used over a long period of time in a poorly ventilated room or when making an extremely large number of copies, the smell may become unpleasant. To maintain the appropriate environment for copy work, it is suggested that the room be properly ventilated.

- When lifting or moving the copier, contact your service representative.
- Do not touch electrical parts, such as connectors or printed circuit boards. They could be damaged by static electricity.
- DO NOT attempt to perform any operations not explained in this handbook.
- CAUTION : Use of controls or adjustments or performance of procedures other than those specified herein may result in hazardous radiation exposure.

Cautions when handling consumables

 CAUTION

- Avoid inhalation, ingestion, skin or eye contact. If ingestion occurs, dilute stomach contents thoroughly with water and seek medical treatment. If skin contact occurs, wash with soap and water. If contact with eyes occurs, flush thoroughly with water and seek medical treatment.
- Prolonged inhalation of excessive dusts may cause lung damage. Use of this product, as intended, does not result in inhalation of excessive dusts.
- Keep away from children.
- Do not incinerate toner and toner containers. Dangerous sparks may cause burn.



Other precautions

- Always read the safety instructions which are included in the box or printed on the container when handling consumables.
- Dispose of the toner or toner containers in accordance with Federal, State and Local rules and regulations.
- Store consumables in a cool, dark location.
- If the copier will not be used for an extended period of time, remove the paper from the cassette, return it to its original package and reseal it.

USER INSTRUCTIONS**FCC PART 15 - RADIO FREQUENCY DEVICES (For U.S.A. Users)**

NOTE: This equipment has been tested and found to comply with the limits for a Class A digital device, pursuant to Part 15 of the FCC Rules. These limits are designed to provide reasonable protection against harmful interference when the equipment is operated in a commercial environment. This equipment generates, uses and can radiate radio frequency energy and, if not installed and used in accordance with the instruction manual, may cause harmful interference to radio communications. Operation of this equipment in a residential area is likely to cause harmful interference in which case the user will be required to correct the interference at his own expense.

WARNING: The design and production of this unit conform to FCC regulations, and any changes or modifications must be registered with the FCC and are subject to FCC control. Any changes made by the purchaser or user without first contacting the manufacturer will be subject to penalty under FCC regulations.

This device must be used with a shielded interface (Parallel) cable and shielded network (10/100BaseT) cable.

The use of non-shield cables is likely to result in interference with radio communications and is prohibited under FCC rules.

INTERFERENCE-CAUSING EQUIPMENT STANDARD (ICES-003 ISSUE 3) (For Canada Users)

This Class A digital apparatus complies with Canadian ICES-003.

Cet appareil numérique de la classe A est conforme à la norme NMB-003 du Canada.

For users in countries subject to Class B regulations

This device must be used with shielded interface (Parallel) cable and shielded network (10/100Base-T) cable.

The use of non-shield cables is likely to result in interference with radio communications and is prohibited under CISPR 22 and local rules.

For users in countries not subject to Class B regulations

WARNING

This is a Class A product. In a domestic environment this product may cause radio interference in which case the user may be required to take adequate measures.

This device must be used with shielded interface (Parallel) cable and shielded network (10/100Base-T) cable.

The use of non-shield cables is likely to result in interference with radio communications and is prohibited under CISPR 22 and local rules.

Ozone Release

Locate the machine in a Well Ventilated Room

A negligible amount of ozone is generated during normal operation of this machine. An unpleasant odor may, however, be created in poorly ventilated rooms during extensive machine operations. For a comfortable, healthy and safe operating environment, it is recommended that the room be well ventilated.

Placer l'appareil dans une pièce largement ventilée

Une quantité d'ozone négligeable est dégagée pendant le fonctionnement de l'appareil quand celui-ci est utilisé normalement. Cependant, une odeur désagréable peut être ressentie dans les pièces dont l'aération est insuffisante et lorsque une utilisation prolongée de l'appareil est effectuée. Pour avoir la certitude de travailler dans un environnement réunissant des conditions de confort, santé et de sécurité, il est préférable de bien aérer la pièce où se trouve l'appareil.

WARNING LABEL

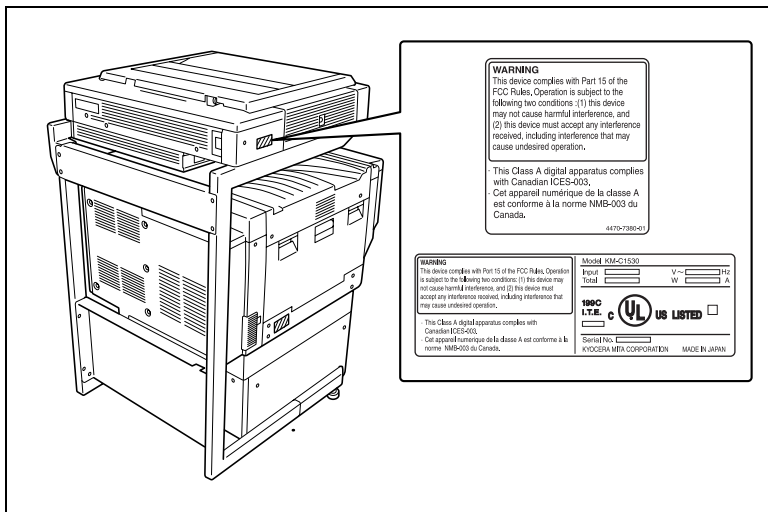

CAUTION

Install this machine so that it can quickly be unplugged from the electrical outlet in case of an emergency.

→ The socket-outlet shall be installed near the machine and shall be easily accessible.

LED Radiation Safety

This product is a copier which operates by means of a LED (light emitting diodes) exposure system. There is no possibility of danger from the LED optical radiation, because the LED optical radiation level does not exceed the accessible radiation limit of class 1 under all conditions of operation, maintenance, service and failure.

1.1 Explanation of Basic Concepts and Symbols

The use of words and symbols in this manual are explained below.

Paper Feeding

During printing, paper is supplied from the right side of the copier and fed into the output tray on top or the output option at the left with the printed surface of the page facing down. The paper feed direction is shown by the arrows in the diagram below.

During copying, paper is supplied from the right side of the copier and fed into the copy tray on the top or the output option at the left with the printed surface of the copy facing down. The paper feed direction is shown by the arrows in the diagram below.

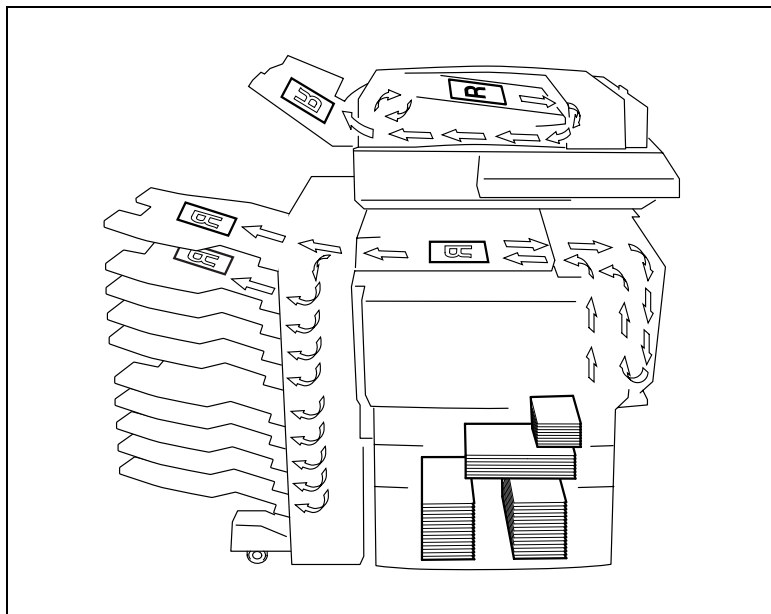

“Width” and “Length”

Whenever paper dimensions are mentioned in this manual, the first value always refers to the width of the paper (shown as “A” in the illustration) and the second to the length (shown as “B”).

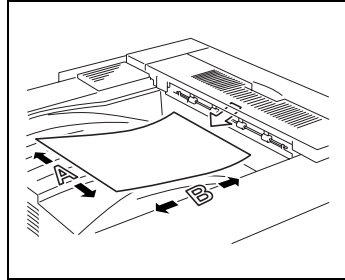



Paper Orientation

Lengthwise ()

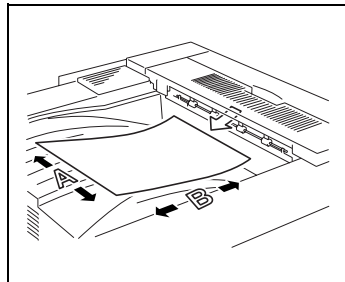
If the width (A) of the paper is shorter than the length (B), the paper has a vertical or portrait orientation, indicated by either “L” or .





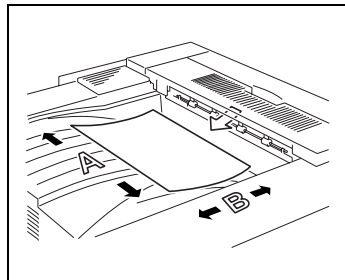

Crosswise ()

If the width (A) of the paper is longer than the length (B), the paper has a horizontal or landscape orientation, indicated by either “C” or .



Display Icons

The icons shown below are displayed when the corresponding paper is loaded or copy is made.

-  : Overhead projector transparencies
-  : Thick paper 1
-  : Second side of a double-sided copy
-  : Second side of a double-sided copy on thick paper

2 Before Making Copies

2.1 Available Features

The main copy settings available with this copier are listed below. For details on their operation, refer to the pages indicated.

Orig. ► Copy (Refer to page 6-1.)

- Single-Sided ► Single-Sided

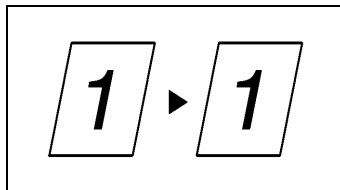

- Single-Sided ► Double-Sided

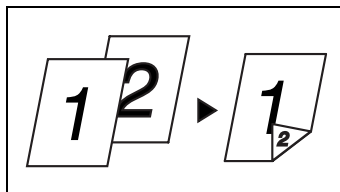

- Double-Sided ► Single-Sided

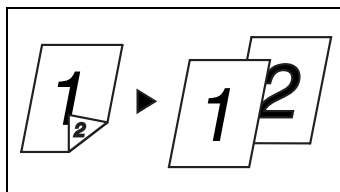

- Double-Sided ► Double-Sided

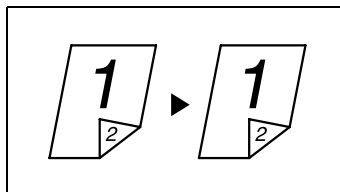

- Single-Sided ► Single-2in1

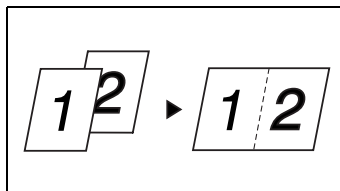

- Double-Sided ▶ Double-2in1

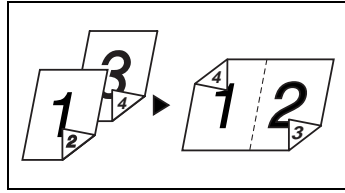

- Book ▶ Separation

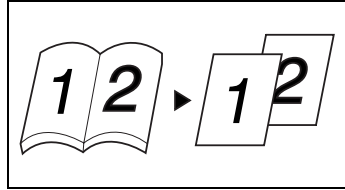

- Book ▶ Spread

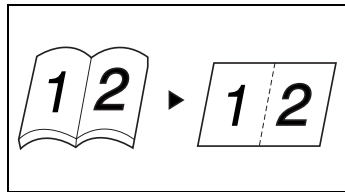

Note

The “Double-Sided” Original setting is only available if the duplexing document feeder is installed.

The “Double-Sided” and the “Double-2in1” Copy settings are only available if the duplex unit and the memory are installed.

Zoom settings (Refer to page 5-14.)

- Reduced/Full Size/Enlarged

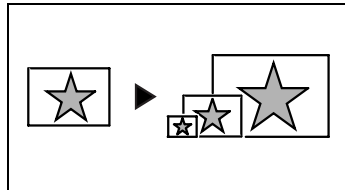

Finishing (Refer to page 6-8, page 6-12, and page 6-15.)

- “Sort” setting

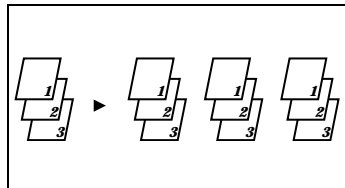

- “Group” setting

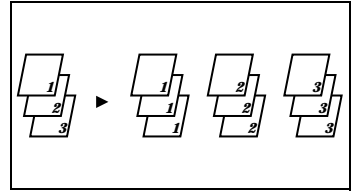

- “Staple” setting
- (Front staple)

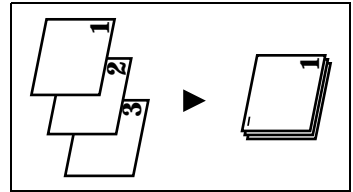

- (Rear staple)

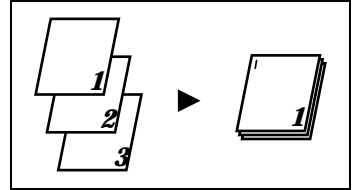

- (Double stapling)

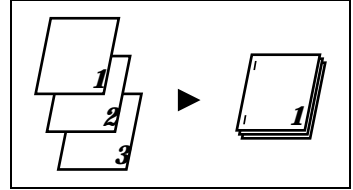

- “Hole-Punch” setting

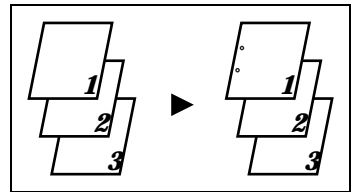
**Note**

The “Sort” and “Group” settings are only available if the 10-mailbin sorter is installed.

The “Staple” and “Hole-Punch” settings are only available if both the finisher and the printer controller are installed, and the print job is sent from the computer.

Applications

- “OHP Interleaving” function (Refer to page 6-30.)

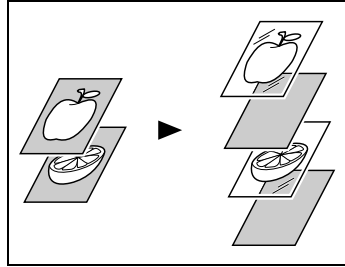

- “Frame Erase” function (Refer to page 6-19.)

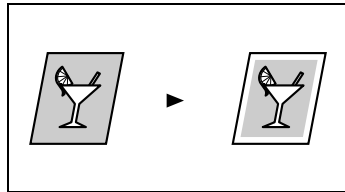

- “Mirror Image” function (Refer to page 6-21.)

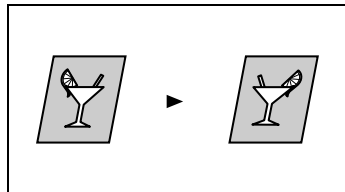

- “X/Y Zoom” function (Refer to page 6-32.)

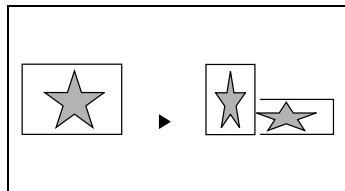

- “Postcard” function (Refer to page 6-33.)

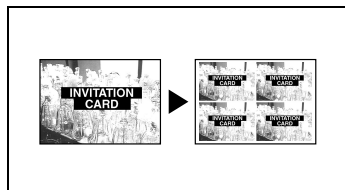

- “Image Repeat” function (Refer to page 6-35.)

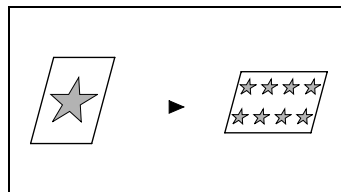
**Note**

The “X/Y Zoom”, “Postcard” and “Image Repeat” functions are only available if the memory is installed.

“Mixed Orig Detection” function (Refer to page 6-17.)

- Mixed originals

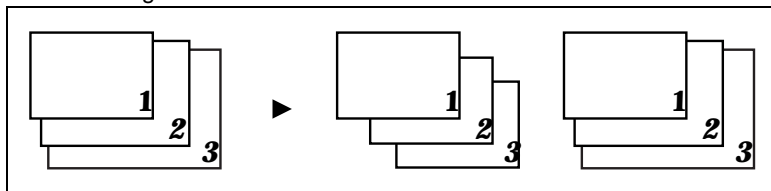
**Note**

The “Mixed Orig Detection” function is only available if the duplexing document feeder is installed.

2.2 Components and Their Functions

The following describes each of the units that the copier is composed of as well as their functions.

- Copier scanner section <scanner>
Scans the document

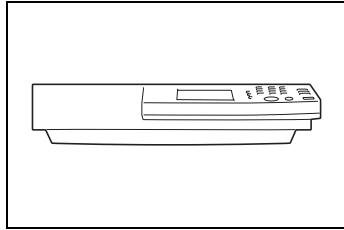

- Copier printer section <printer>
Prints the image scanned with the scanner

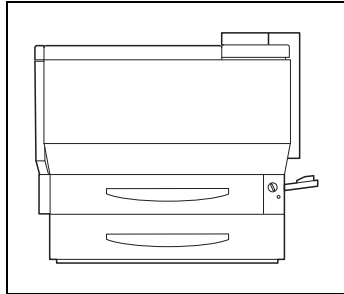

- Original cover PLATEN COVER
TYPE C(optional)
Presses down on the loaded document

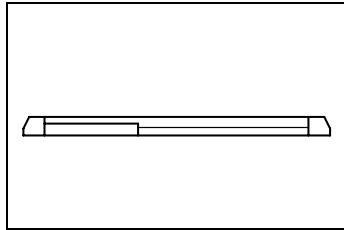

- Duplexing document feeder RADF-11 (optional)
Automatically feeds and scans one document sheet at a time, and automatically turns over double-sided documents and scans them

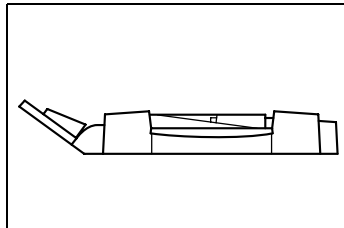

- 10-Mailbin sorter AS-M4110 (optional)
Automatically sorts or groups pages and feeds them into the mailbin specified at the computer

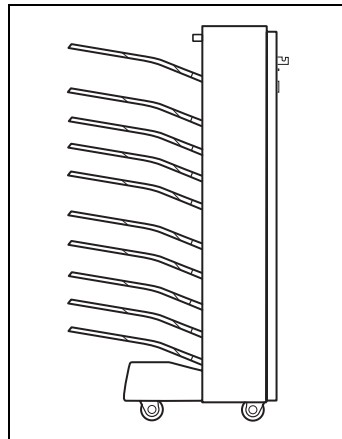

- Finisher F-8110/F-8430 (optional)
When printing from the computer, finishes pages according to the mode (sorting, grouping, stapling or hole-punching) selected at the computer, then feeds out the pages

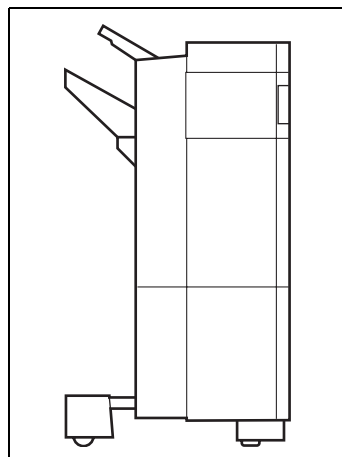

- Duplex unit AD-35 (optional)
Automatically turns over copies, allowing double-sided copies to be made

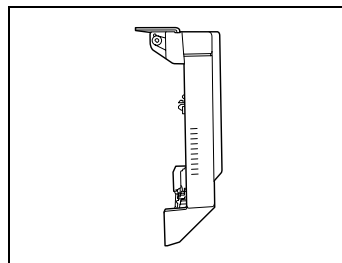

- Paper feed unit ST-530 (optional)
Can supply 500 sheets of paper; up to two paper feed units can be installed

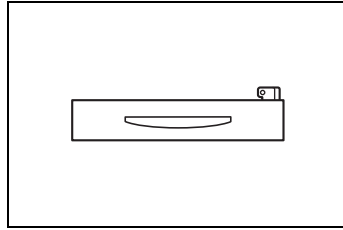

- Large-capacity cabinet ST-2500 (optional)
Can supply 2,500 sheets of paper

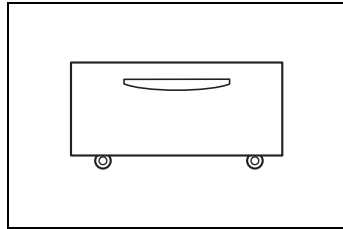

- Scanner rack (optional)
Decreases the equipment area by installing the scanner above the copier

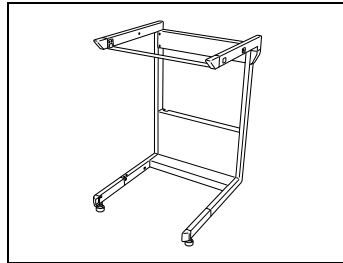

- Copy desk (optional)
Used when the optional 10-mailbin sorter (AS-M4110) or an optional finisher (F-8110/F-8430) is installed without an optional paper feed unit

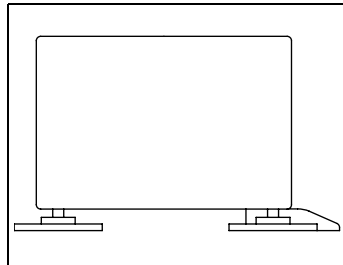

- Copy table (optional)
Used when the optional 10-mailbin sorter (AS-M4110) or an optional finisher (F-8110/F-8430) is installed with two optional paper feed units installed

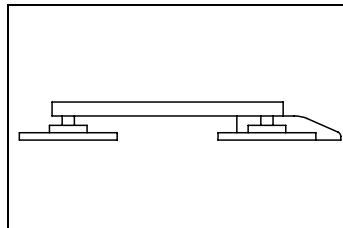

- Printer controller FIERY X3e (optional)
Internal printer controller that allows the copier to be used as both a color printer and a color scanner on a network
- Memory (256 MB: 128 MB × 2)
(recommended with KM-C1530)
Increases the memory of the copier, allowing functions such as double-sided and 2in1 copying to be performed

2.3 Parts Names and Their Functions

Outside of Copier

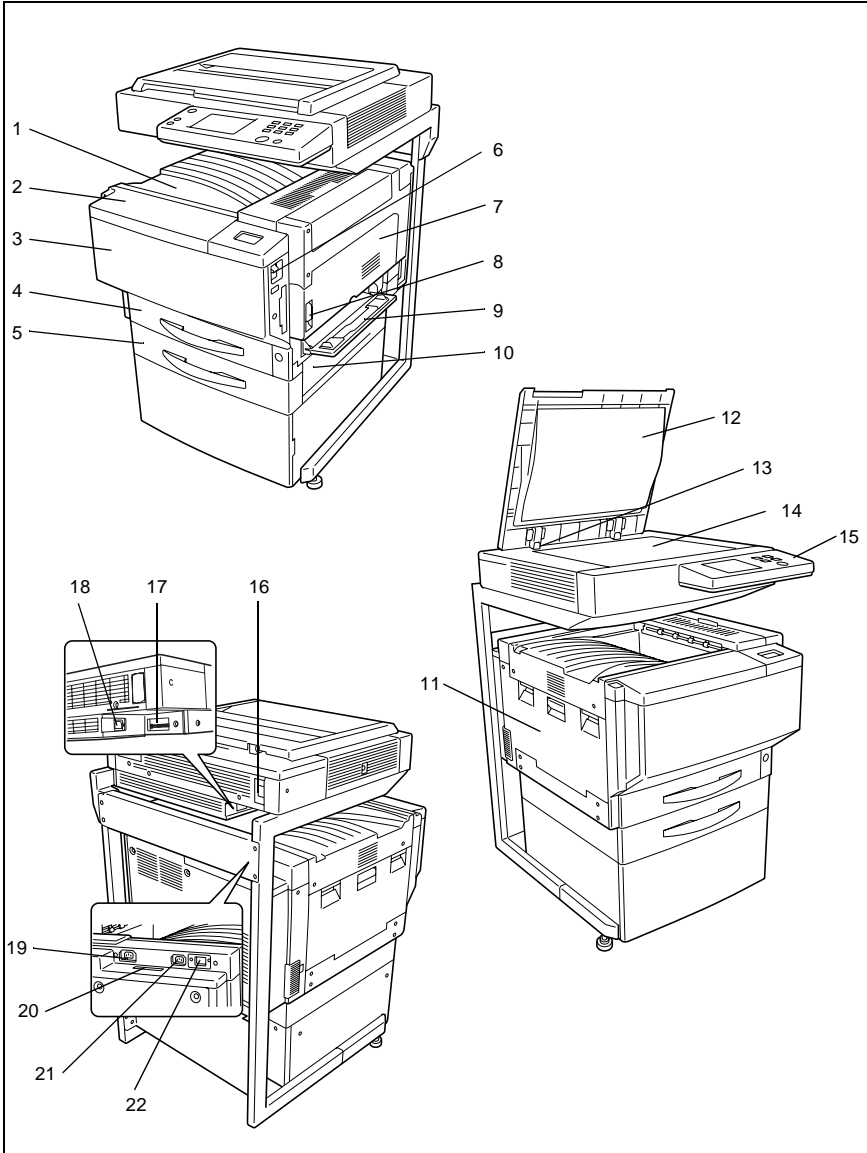

* The original cover, scanner rack, and copy desk shown installed in the illustration are optional.

No.	Part Name	Description
1	Copy output tray	Holds copies fed out of the copier
2	Toner supply door	Opened when adding toner
3	Front door	Opened when replacing the imaging unit See p. 9-43.
4	1st drawer	Holds 250 sheets of paper The paper size can be adjusted freely. Special paper can be used. See p. 3-7.
5	2nd drawer	Holds 500 sheets of paper The paper size can be adjusted freely. See p. 3-13.
6	Power switch	Used to turn the copier on and off See p. 2-29.
7	Right-side door	Opened when servicing the copier and clearing misfeeds
8	Right-side door release lever	Used to open and close the right-side door
9	Manual bypass tray	Used for manual feeding of paper The paper is fed one sheet at a time. Special paper can be used. See p. 3-17.
10	Lower right-side door	Opened when clearing misfeeds
11	Left-side door	Opened when servicing the copier
12	Original cover (optional)	Presses the document against the original glass
13	Document scale	Used to align the document See p. 4-11.
14	Original glass	When manually feeding the document, place it on the glass so the document can be scanned. Place the document face down on the glass. See p. 4-10.
15	Control panel	Used to start copying or to make settings See p. 2-20.
16	Duplexing document feeder connector	Used for connecting the duplexing document feeder hookup cord
17	Scanner connector	Used for connecting the scanner hookup cord
18	Scanner power cord socket (inlet)	Used for connecting the scanner's power cord
19	Scanner power cord socket (outlet)	Used for connecting the scanner's power cord
20	Scanner connector	Used for connecting the scanner hookup cord
21	Printer power cord socket	Used for connecting the printer's power cord
22	Sorter/finisher connector	Used for connecting the sorter or finisher hookup cord

Inside of Copier

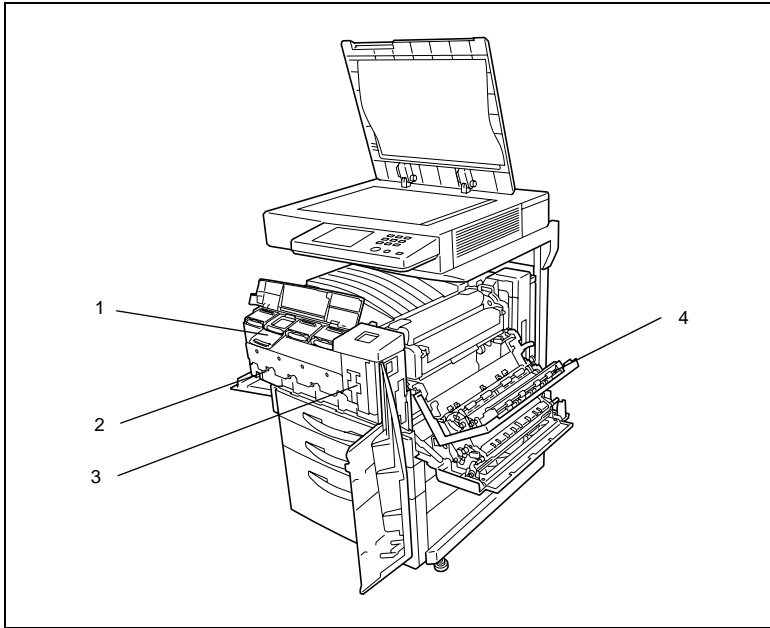

No.	Part Name	Description
1	Toner hopper lid	Opened when adding toner
2	Imaging unit release lever	Used to install and replace the imaging unit
3	Imaging unit removing bracket	Used to remove the imaging unit
4	Upper right-side door	Opened when replacing the fusing unit or clearing misfeeds

Supplies and Parts

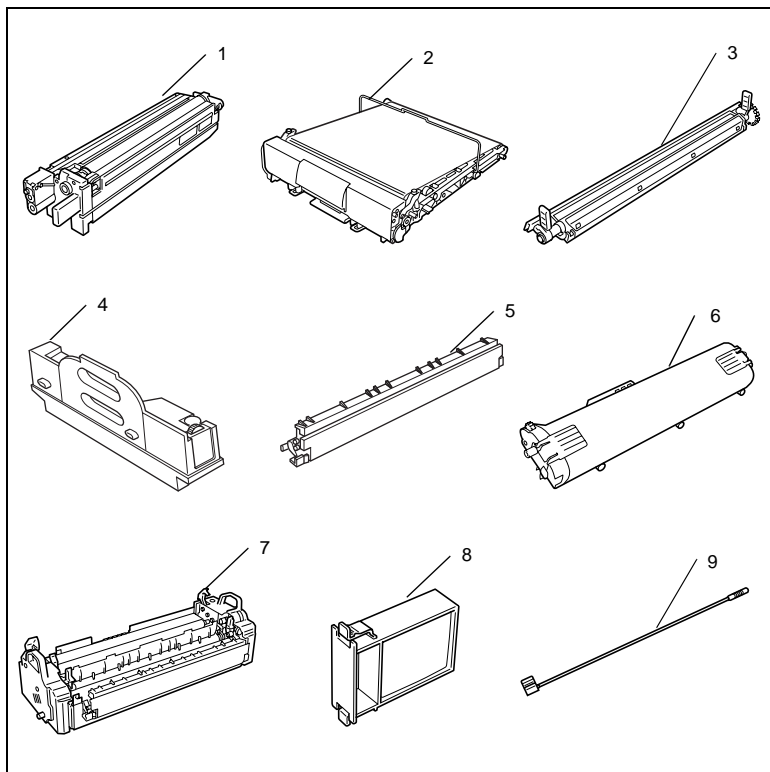

No.	Part Name	Description
1	Imaging unit	Generates the copied image
2	Image transfer belt unit	Layers onto the image transfer belt each of the single colors of the image generated by the imaging unit in order to create a full-color image
3	Image transfer roller unit	Transfers onto the paper a full-color image generated by the image transfer belt unit
4	Waste toner bottle	Collects waste toner
5	Oil-coating unit	Supplies oil to the fusing roller
6	Fusing web unit	Supplies oil to the fusing belt
7	Fusing unit	Fuses the transferred toner to the paper
8	Ozone filter	Collects the ozone generated in the copier
9	LED cleaning tool	Used to clean the surface of the LED unit, for example when replacing the image transfer belt unit Store in a safe place for later use.

Duplexing Document Feeder (Optional)

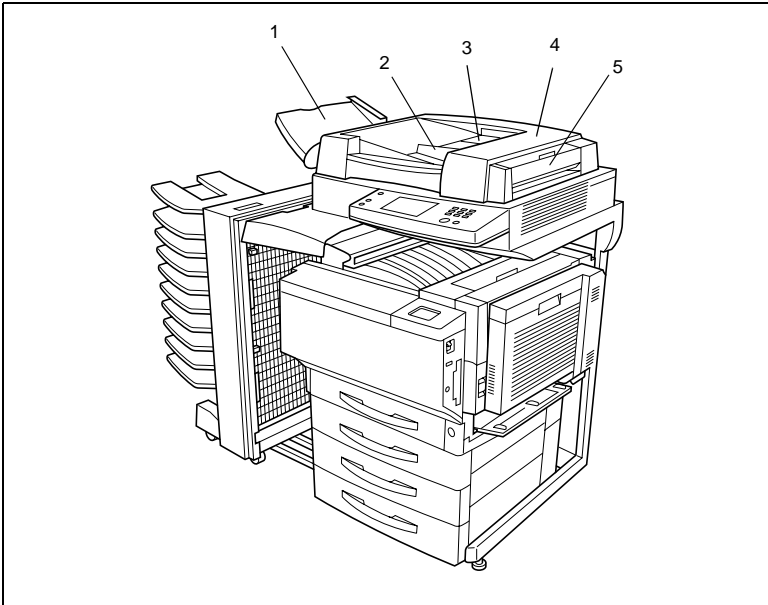

No.	Part Name	Description
1	Document output tray	Collects documents that have been copied
2	Document guide	Align one side of the document along the fixed document guide, and then adjust the other guide to the width of the document. See p. 4-4.
3	Document feed tray	Load the documents to be copied face up. See p. 4-4.
4	Misfeed clearing cover F1/F2	Opened when clearing a misfed document
5	Single-sheet feed tray	Open to feed one sheet of the document at a time

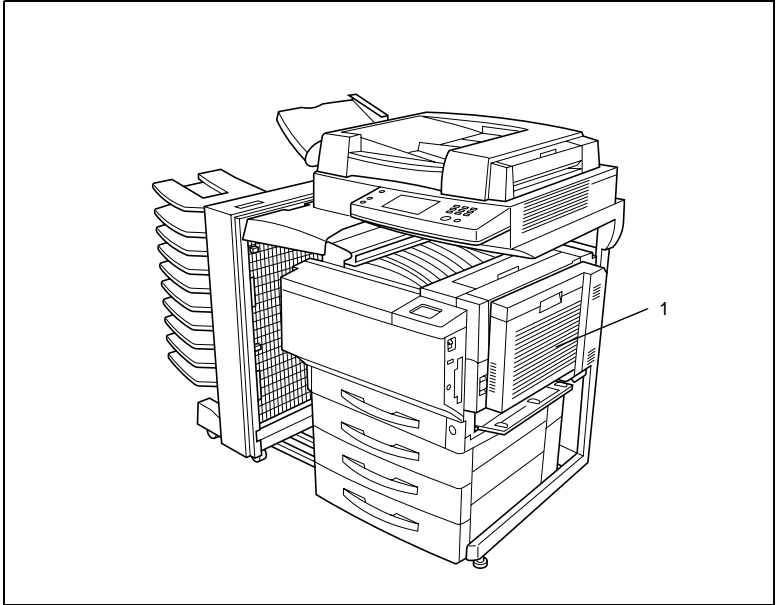
Duplex Unit (Optional)

No.	Part Name	Description
1	Duplex unit door	Opened when clearing paper misfed within the duplex unit

10-Mailbin Sorter (Optional)

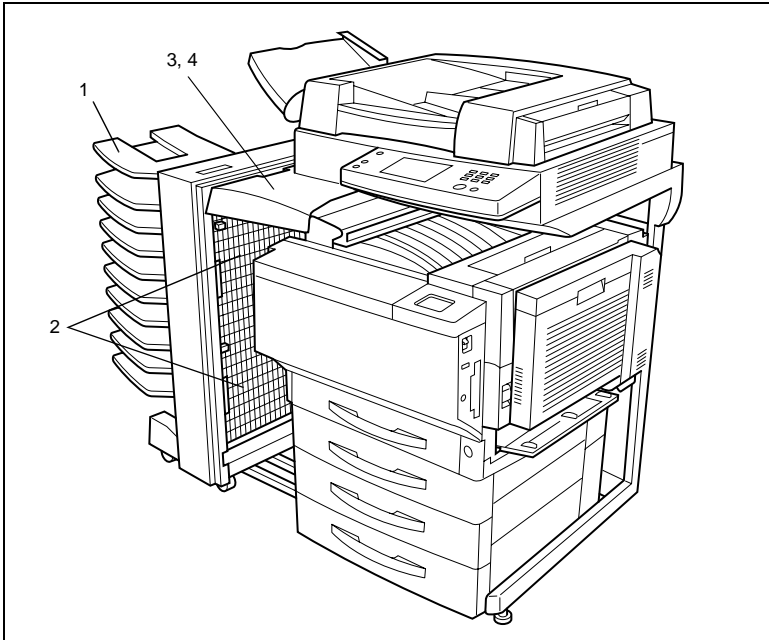

No.	Part Name	Description
1	Mailbins	Collects copies that are sorted
2	Upper door/Lower door	Opened when clearing paper misfed within the sorter
3	Horizontal transport unit	Transports copies to the sorter or finisher
4	Horizontal transport unit cover	Opened when clearing paper misfed within the horizontal transport unit

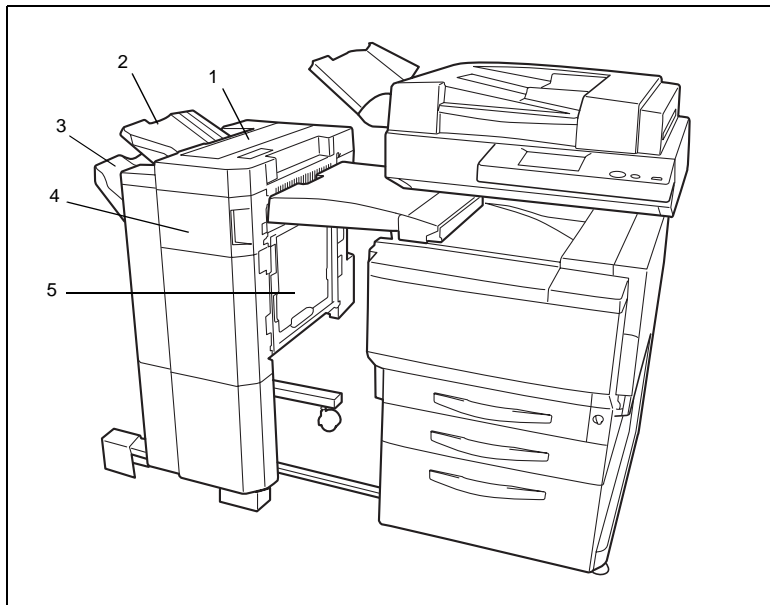
Finisher (Optional)

No.	Part Name	Description
1	Upper cover	Opened when clearing paper misfed within the finisher
2	Upper paper output tray	Collects copies that are not sorted (made with the "Non-Sort" setting)
3	Lower paper output tray	Collects copies that are sorted
4	Front door	Opened when clearing paper misfed within the finisher
5	Right-side door (Finisher F-8430 only)	Opened when replacing the staple cartridge or clearing paper misfeeds

Paper Feed Unit (Optional)

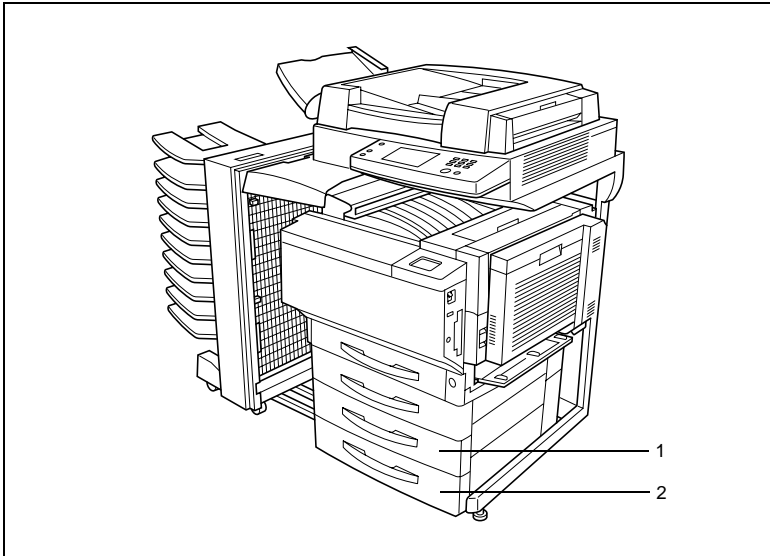

No.	Part Name	Description
1	3rd drawer	Holds 500 sheets of paper The paper size can be adjusted freely. As many as two units can be installed. See p. 3-13.
2	4th drawer	

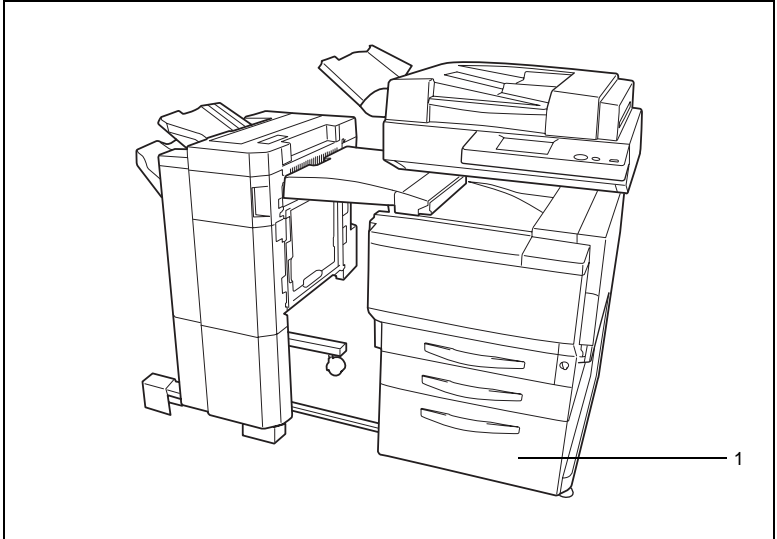
Large-Capacity Cabinet (Optional)

No.	Part Name	Description
1	3rd drawer	Holds 2,500 sheets of paper See p. 3-15.

Printer Controller FIERY X3e

For more details, refer to the manual of the printer controller.

2.4 Names of Control Panel Parts and Their Functions

Names of Control Panel Parts and Their Functions

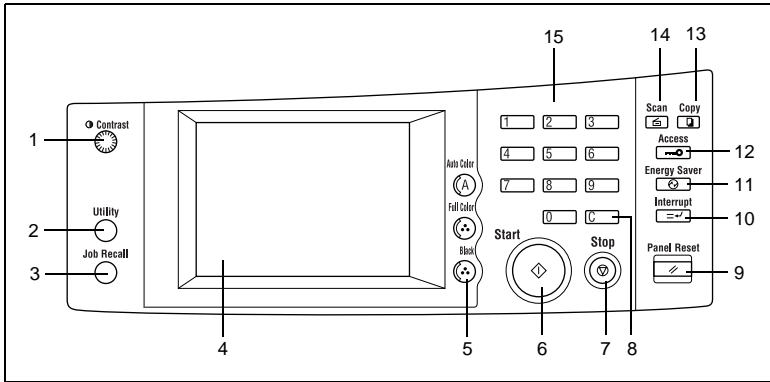

No.	Part Name	Description
1	Touch panel contrast-adjusting dial	<ul style="list-style-type: none"> Adjusts the contrast of the touch panel
2	Utility key	<ul style="list-style-type: none"> Press to display the Utility screen, which allows you to select the following functions: Default Settings Meter Count Job Memory Input User's Choice Administrator Mode Scanner Addr. Input Refer to "7 Utility Mode Operations" and "8 Administrator Mode Operations".
3	Job Recall key	<ul style="list-style-type: none"> Press to display the Job Recall screen, which allows you to recall and check stored copy jobs. Refer to "To recall a stored job" on page 7-6.
4	Touch panel	<ul style="list-style-type: none"> Displays various screens and messages Refer to "Using the Touch Panel" on page 2-22.
5	Auto Color, Full Color, and Black keys	<ul style="list-style-type: none"> Auto Color: The copier automatically determines whether the document is in color or in black and white, and then makes a full-color or black-and-white copy depending on the color of the document. Full Color: The copier makes a full-color copy of the document. Black: The copier makes a black-and-white copy regardless of the color of the document.

No.	Part Name	Description
6	Start key	<ul style="list-style-type: none"> Press to start the copy operation. If this key is pressed while the copier is warming up, the copy job is delayed until the copier is finished warming up. See p. 2-26. The [Start] key indicator lights up in green to indicate that the copier can begin copying. The [Start] key indicator lights up in orange to indicate that the copier cannot make copies.
7	Stop key	<ul style="list-style-type: none"> Press to stop a continuous copy operation.
8	C (clear) key	<ul style="list-style-type: none"> Press to reset the number of copies to "1". Press to erase a setting, such as the zoom ratio or size, selected using the keypad.
9	Panel Reset key	<ul style="list-style-type: none"> Press to reset all copy functions and settings to their defaults. (All selected settings are cancelled.) See p. 2-25. * Stored zoom ratios, stored job settings, and interrupted or delayed copy jobs are not cancelled.
10	Interrupt key	<ul style="list-style-type: none"> Press to interrupt a copy job. (The [Interrupt] key indicator lights up in green to indicate that the copier is in Interrupt mode.) Press again to cancel Interrupt mode or to return the copier to the mode before it entered Interrupt mode. See p. 2-27.
11	Energy Saver key	<ul style="list-style-type: none"> Press to enter Energy Saver mode. See p. 2-26.
12	Access key	<ul style="list-style-type: none"> Press when making copies using an access code. See p. 2-28.
13	Copy key	<ul style="list-style-type: none"> Press to enter Copy mode and use the copier as a copier. The [Copy] key indicator lights up in green to indicate that the copier is in Copy mode.
14	Scan key	<ul style="list-style-type: none"> Press to enter Scanner mode and use the copier as a color scanner. The [Scan] key indicator lights up in green to indicate that the copier is in Scanner mode.
15	Keypad	<ul style="list-style-type: none"> Use to type in the number of copies to be made. Use to type in the zoom ratio. Use to type in the various settings.

2.5 Using the Touch Panel

Description of Touch Panel

When the copier is turned on (I), the Basic screen appears in the touch panel. It shows, with messages and graphics, the currently selected settings, the settings that are available, and the copier status.





Note

The screen illustrations in this manual may be slightly different from the screens that appear on your copier's touch panel.

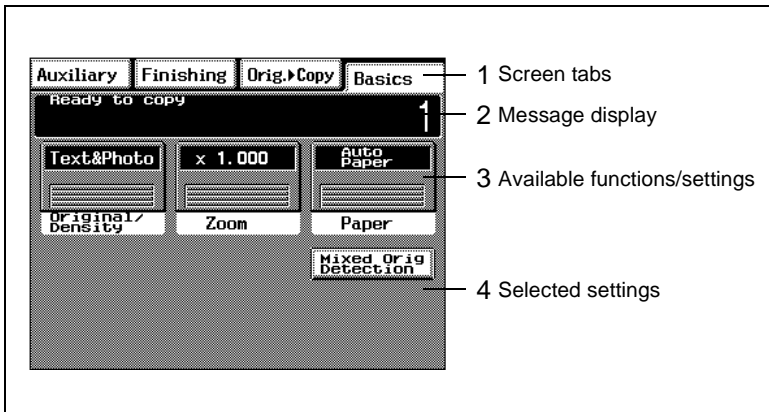
Organization of Screens

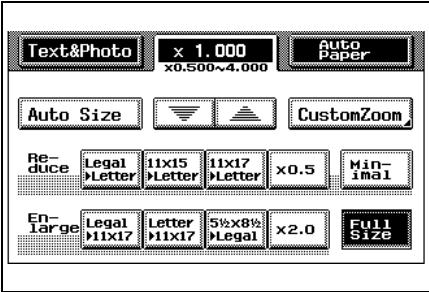
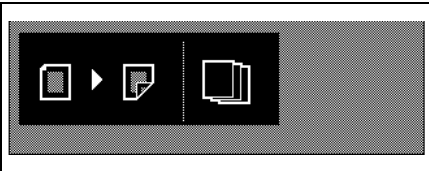

No.	Part Name	Description
1	Screen tabs	<p>These are the tabs for the Basic, Orig. ► Copy, Finishing, and Auxiliary screens. Touch a tab to display the corresponding screen.</p>  <p>Example) The Auxiliary screen is selected above. * Touch "Basic" to display the Basic screen (the default screen).</p>
2	Message display	<p>The current copier status, operating instructions, warnings/precautions, and other data including the number of copies selected are displayed here.</p>  <p>Example) The message "Add paper." appears in the message display of the screen shown above.</p>
3	Available functions/settings	<p>Selecting a function displays a screen that allows you to select the desired setting. Select a different function to display the corresponding screen.</p>  <p>Example) The available zoom ratio settings are shown above. * The currently selected setting appears in the tab.</p>
4	Selected settings	<p>The current settings are shown by messages and graphics.</p> 

Operating the Touch Panel

To activate a function or to select a setting, lightly touch the desired function or setting shown on the touch panel.

 **CAUTION**

Be careful not to damage the touch panel.

→ Never push on the touch panel, and never push on it using a hard or pointed object.

2.6 Useful Operations

Canceling Settings

Press the [Panel Reset] key to cancel all modes and functions (zoom ratio, number of copies, etc.) and reset them to their defaults. (All selected settings are cancelled.)

If the duplexing document feeder is being used and a document has been fed onto the original glass, the document will automatically be fed out.



Tip

Pressing the [Panel Reset] key is the easiest way to cancel all selected settings at one time.

In order to avoid accidentally using settings from a previous copy job, press the [Panel Reset] key to return all functions and settings to their defaults, and then select the desired settings.

Auto Panel Reset

Without pressing the [Panel Reset] key, the copier automatically resets all functions and settings to their defaults one minute after copying is finished or after a key or the touch panel is pressed.



Tip

The length of time until the copier automatically resets itself can be set between 1 and 9 minutes. The "Auto Panel Reset" parameter can even be turned off.

For more details, refer to "Specifying Default Settings ("User's Choice" Function)" on page 7-8 and page 7-15.

Energy Saver Mode

Instead of turning off the copier, it can be put into a standby mode (Energy Saver mode).

Turn the Energy Saver mode on by pressing the [Energy Saver] key. In addition, if the copier is not used for a set length of time, it automatically enters Energy Saver mode. The default length of time is 15 minutes.

To cancel Energy Saver mode, press any key in the control panel.



Note

If the copier enters Sleep mode while it is in Energy Saver mode, the copier will automatically turn itself off.



Tip

The length of time until the copier enters Energy Saver mode can be set between 1 and 240 minutes.

For more details, refer to "Specifying Default Settings ("User's Choice" Function)" on page 7-8 and page 7-16.

Delayed Copy Jobs

If a document is loaded and the [Start] key is pressed during the period after the copier is turned on but before it is ready to begin copying, the copier will automatically begin copying after it has finished warming up.

Sleep Mode

When the printer controller is not installed:

If the copier is not used for a set length of time, it can automatically turn itself off in order to save energy. The default length of time is 30 minutes.

When the printer controller is installed:

If the copier is not used for a set length of time, it will automatically enter a standby mode (Energy Saver mode) in order to save energy. The default length of time is 30 minutes. To cancel this mode, press any key in the control panel.



Tip

The length of time until the copier enters Sleep mode can be set between 15 and 240 minutes. The "Sleep Mode" parameter can even be turned off.

For more details, refer to "Specifying Default Settings ("User's Choice"

Function)" on page 7-8 and page 7-17.

Interrupting Copy Jobs

During long continuous copy operations or print jobs, the copier may be needed to quickly copy a different document.

To interrupt a copy job

- Press the [Interrupt] key to temporarily stop the current copy operation.

Press the [Interrupt] key again to continue the previously stopped copy operation.



Note

The Interrupt mode is also cancelled when the copier automatically resets itself 1 minute after the last key is pressed ("Auto Panel Reset" parameter). However, the Interrupt mode is not cancelled if a copy job is still interrupted.

The length of time until the copier automatically resets itself can be set between 1 and 9 minutes. The "Auto Panel Reset" parameter can even be turned off. By turning off the "Auto Panel Reset" parameter, the Interrupt mode will not be cancelled automatically. For more details, refer to "Specifying Default Settings ("User's Choice" Function)" on page 7-8 and page 7-15.

Some functions cannot be interrupted. In addition, some settings are not available while a copy job is interrupted. For more details, refer to the the "Function Combination Table" on page 11-10.



Tip

Pressing the [Interrupt] key resets all functions and settings to their defaults and selects the "Non-Sort" setting on the Finishing screen. For more details, refer to "Resetting the Copier ("Default Settings" Function)" on page 7-1.

Settings cannot be stored during Interrupt mode. In addition, the "OHP Interleaving" and "Job Recall" functions are not available.

Auto Paper Source Change Feature

If the tray or drawer runs out of paper while copying, the copier will automatically switch to a different paper source and continue copying provided that the new tray or drawer contains paper of the same type and size in the same orientation. If the large-capacity cabinet (ST-2500) is also installed, up to 3,250 sheets of "LetterC" paper can be fed continuously.

Access Codes

If access codes have been specified, use of the copier can be limited to certain people or to a specified number of copies for each account.



Note

If access codes have been specified, the copier cannot be used unless the access code/account number is entered first.

<Access # Input screen>

The access codes can be specified using the "Copy Track" function of the Administrator mode. (Refer to page 8-1.)



To enter an access code

- 1 Using the keypad, enter the four-digit access code, and then press the [Access] key.

? *Do you wish to correct the entered access code?*

- Press the [C] (clear) key to erase the entered access code, and then enter the correct access code.



- 2 The Basic screen appears and printing can begin. Select the desired settings.
- 3 After you are finished making your copies, press the [Access] key.

Printing From the Computer

If the optional printer controller is installed, the copier can be used as an 11 × 17 in. full-color printer configured into a computer network.

For operating details, refer to the manual for the printer controller.

Scanning From the Computer

If the optional printer controller is installed, the copier can be used as an 11 × 17 in. full-color scanner configured into a computer network.

For operating details, refer to the manual for the printer controller.

2.7 Power Switch and Default Settings

Turning the copier on and off

To turn the copier on

- Set the power switch to “I”.

To turn the copier off

- Set the power switch to “O”.

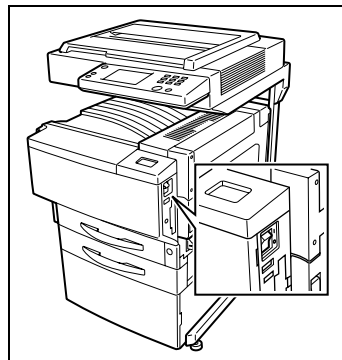

Note

Do not turn off the copier while it is making copies, otherwise a paper misfeed may occur. Make sure that all copy operations are finished before turning off the copier.

When the copier is turned off, all settings except the stored zoom ratios and other stored settings in addition to the Utility mode settings are reset to their defaults.



Note

If the copier is not used for 15 minutes, it automatically enters Energy Saver mode. In addition, after the copier is not used for 30 minutes, it automatically turns itself off (Sleep mode).

The length of time until the copier enters Energy Saver mode or Sleep mode can be set using the “User’s Choice” function. For more details, refer to “Specifying Default Settings (“User’s Choice” Function)” on page 7-8, page 7-16, and page 7-17.

CAUTION

If the copier will not be used for a short period of time (overnight, etc.), turn the main switch OFF (O). If it will not be used for an extended period of time (vacations, etc.), remove the power plug from the outlet for safety purposes during the time the copier is not in use.

Turning On the Copier

A few seconds after the copier is turned on, the indicator on the [Start] key lights up in green and the message “Warming up. Pre-program a job.” appears on the touch panel.

At this time, a delayed copy job can be specified. (For more details, refer to page 2-26.)

However, even though the [Start] key is pressed, the copy operation is not performed until the copier has finished warming up (after about 5 minutes at normal room temperature (68°F/20°C)).

Default Settings

The Basic screen, which appears on the touch panel when the copier is turned on, displays the default settings. The Basic screen serves as a reference for all settings that are to be made.

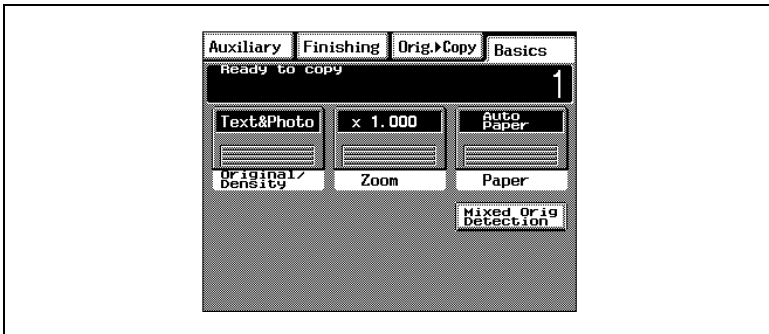

Default settings

- Number of copies: 1
- Original Image Type: Text&Photo
- Zoom: Full Size (x1.000)
- Paper: Auto Paper
- Orig. ► Copy: Single-Sided ► Single-Sided
- Finishing: Non-Sort



Tip

The default settings can be customized using the “User’s Choice” function. (Refer to page 7-1.)

3 Copy Paper

3.1 Paper Specifications

Use paper that meets the following specifications.

Paper Types

Paper Types	Standard Paper	Special Paper			
		Thick Paper1	Thick Paper2	Overhead Projector Transparencies	Postcards
Weight (lbs.)	16 lbs. to 24 lbs.	24-1/4 lbs. to 43-1/4 lbs.	43-1/2 lbs. to 55-1/2 lbs.		
Weight (g/m ²)	(64 g/m ² to 90 g/m ²)	(91 g/m ² to 163 g/m ²)	(164 g/m ² to 209 g/m ²)		
Manual Bypass Tray	○	○	○	○	○
1st Drawer	○	○	—	○	○
2nd Drawer	○	—	—	—	—
Paper Feed Unit ¹	○	—	—	—	—
Large-Capacity Cabinet ¹	○	—	—	—	—
Double-Sided Copies ²	○	—	—	—	—
Finished Copies ³	○	—	—	—	—

* 1: The paper feed unit and large-capacity cabinet are optional.

2: If the optional duplex unit is used to make double-sided copies, only certain types of paper can be used.

3: If the optional 10-mailbin sorter is used to sort or group copies, only certain types of paper can be used.

Paper Sizes

Non-standard paper:

Paper Source	Paper Width	Paper Length
Manual Bypass Tray	3-9/16 in. to 12-1/4 in. (90 mm to 311 mm)	5-1/2 in. to 18 in. (140 mm to 457 mm)
1st Drawer		
2nd Drawer	—	—
Paper Feed Unit ^{*1}		
Large-Capacity Cabinet ^{*1}	—	—

* 1: The paper feed unit and large-capacity cabinet are optional.

Standard paper:

Paper Size Paper Source, Etc.	LetterL	LetterC	LegalL	Executi veL	Executi veC	12-1/4 x 18L	11 x 17 L
Manual Bypass Tray	○	○	○	○	○	○	○
1st Drawer	○	○	○	○	○	○	○
2nd Drawer	○	○	○	—	—	—	○
Paper Feed Unit ^{*1}	○	○	○	—	—	—	—
Large-Capacity Cabinet ^{*1}	—	○	—	—	—	—	—
Double-Sided Copies ^{*2}	○	○	○	○	○	○	○
Finished Copies ^{*3}	○	○	○	○	○	○	○

Paper Size Paper Source, Etc.	11 x 14 L	8-1/4 x 13L	8 x 13L	8-1/2 x 13L	8-3/4 x 13L	8 x 10- 1/2L	8 x 10L
Manual Bypass Tray	○	○	○	○	○	○	○
1st Drawer	○	○	○	○	○	○ ^{*4}	○
2nd Drawer	○	○ ^{*5}	○ ^{*5}	○ ^{*5}	○ ^{*5}	—	—
Paper Feed Unit ^{*1}	○	○ ^{*5}	○ ^{*5}	○ ^{*5}	○ ^{*5}	—	—
Large-Capacity Cabinet ^{*1}	—	—	—	—	—	—	—
Double-Sided Copies ^{*2}	○	○	○	○	○	○	○
Finished Copies ^{*3}	○	○	○	○	○	○	○

Paper Size Paper Source, Etc.	5-1/2 x 8-1/2L	10-1/2 x 8C	10 x 8C	8-1/2 x 5-1/2C	4 x 6L
Manual Bypass Tray	○	○	○	○	○
1st Drawer	○	○ ^{*4}	○	○	○
2nd Drawer	—	○	—	—	—
Paper Feed Unit ^{*1}	—	○	—	—	—
Large-Capacity Cabinet ^{*1}	—	—	—	—	—
Double-Sided Copies ^{*2}	○	○	○	—	—
Finished Copies ^{*3}	○	○	○	○	—

* 1: The paper feed unit and large-capacity cabinet are optional.

2: If the optional duplex unit is used to make double-sided copies, only certain types of paper can be used.

3: If the optional 10-mailbin sorter is used to sort or group copies, only certain types of paper can be used.

4: The size should be entered using the "User's Choice" function.

5: The paper size should be changed by your service representative.

Paper capacity:

Paper Type Paper Source, Etc.	Standard Paper	Special Paper			
		Thick Paper1	Thick Paper2	Overhead Projector Transparencies	Postcards
Manual Bypass Tray	1 sheet	1 sheet	1 sheet	1 sheet	1 sheet
1st Drawer	250 sheets	20 sheets	—	20 sheets	20 sheets
2nd Drawer	500 sheets	—	—	—	—
Paper Feed Unit ^{*1}	500 sheets	—	—	—	—
Large-Capacity Cabinet ^{*1}	2,500 sheets	—	—	—	—

* 1: The paper feed unit and large-capacity cabinet are optional.

Recommended paper:

Paper Type		Recommended Paper
Standard Paper	For full-color copies	Hammermill Laser Print New Radiant White 24 lbs.
	For black-and-white copies	Hammermill tidal DP
Thick Paper 1		NS 700
Thick Paper 2		NS 1000C
Overhead Projector Transparencies	For full-color copies	V558
	For black-and-white copies	JE001

Paper Types To Be Avoided

The following types of paper should not be used, otherwise decreased print quality, paper misfeeds or damage to the copier may occur.

- Overhead transparencies that have already been fed through the copier (even if the transparency is still blank)
- Paper that has been printed on by a heat-transfer printer or an inkjet printer
- Paper that is either extremely thick or extremely thin
- Folded, rolled, wrinkled, or torn paper
- Perforated paper or paper with holes punched in it
- Extremely smooth or extremely rough paper, or paper with an uneven surface
- Paper that has been treated, such as carbon-backed paper, or heat-sensitive or pressure-sensitive paper
- Paper that has been decorated with foil or embossing
- Paper of various sizes
- Paper of a non-standard shape (not rectangular)
- Paper that is bound with glue, staples, or clips
- Paper with labels attached
- Paper with ribbons, hooks, buttons, etc. attached

3.2 Print Area

Any part of the image within the area shown below is not copied.

- A margin 0.2 in. (5 mm) from the leading edge of the paper (A)
- A margin 0.12 in. (3 mm) from the trailing edge of the paper (B)
- A margin 0.12 in. (3 mm) on both sides of the paper (C)

When using the printer controller to print from a computer, the image cannot be printed within the area 0.2 in. (5 mm) from all edges of the paper.

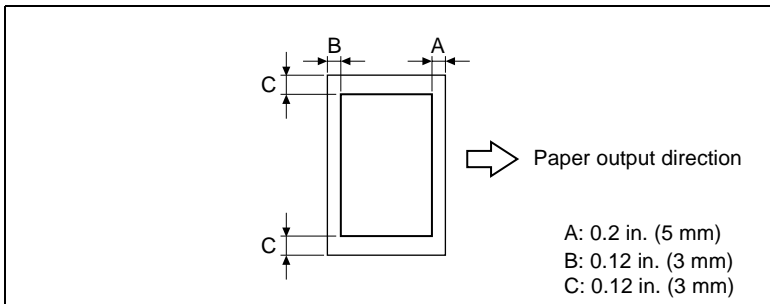

3.3 Paper Storage

Observe the following precautions when storing the paper.

- ✦ Store the paper in a location that meets the following requirements.
 - Not exposed to direct sunlight
 - Not exposed to fire
 - Not exposed to high humidity
 - Not extremely dusty
- ✦ Unwrapped paper should be stored in a plastic bag in a cool, dry location.
- Keep paper out of the reach of children.

3.4 Loading Paper

To load paper into the 1st drawer (250-sheet multipurpose tray)

- 1 Pull out the paper drawer for the 1st drawer.

? *Has the paper take-up roller been touched?*

- Be careful not to touch the surface of the paper take-up roller with your hands. If the roller has been touched, wipe it with a dry cloth.

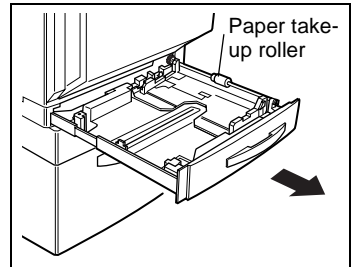

- 2 Press down on the paper-lifting plate until it locks into place.

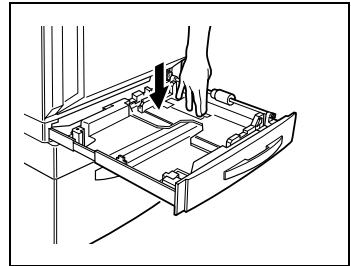

- 3 Slide the lateral guides to fit the size of paper to be loaded.

- For paper of a non-standard size, first load the paper, and then adjust the lateral guides to the size of the loaded paper.

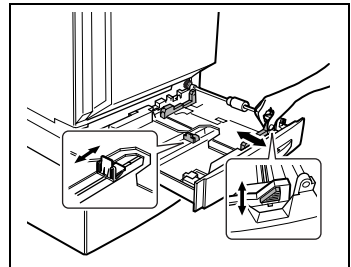

- For “12-1/4 × 18” paper, adjust the trailing-edge guides as shown in the illustration.

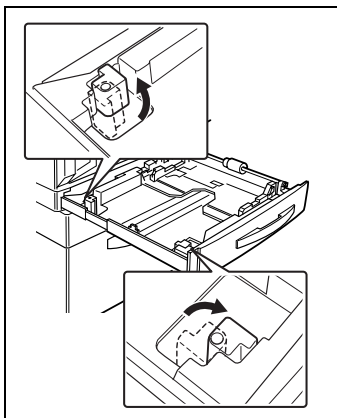

- 4 Load the paper into the drawer so that the front side of the paper (the side facing up when the package was unwrapped) faces up.

? *Has the paper been loaded correctly?*

If the paper is not loaded correctly, a paper misfeed may occur.

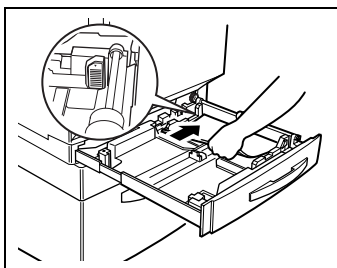

- Do not load so much paper that the top of the stack is higher than the ▼ mark.
- Do not load more than 20 sheets of thick paper 1, overhead projector transparencies, or postcards.
- Do not load thick paper 2 into the 1st drawer. If you wish to make copies onto thick paper 2, feed it through the manual bypass tray.
- When loading additional paper, remove any paper remaining in the drawer, place it on the new paper, and then align the paper in the stack well before loading it into the drawer.
- We recommend replenishing the paper only after all of the paper in the drawer has been used.

? *Are postcards loaded?*

→ When loading postcards, load them as shown.

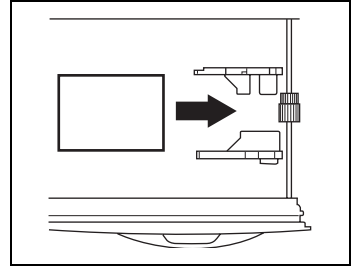

→ Do not load postcards cross-wise, as shown.

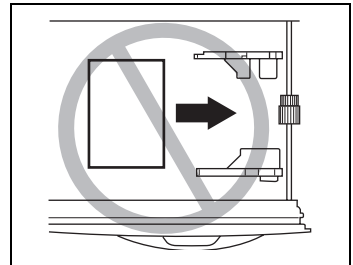

? *Are the recommended overhead projector transparencies loaded?*

→ When loading the recommended overhead projector transparencies, load them as shown in the illustration.

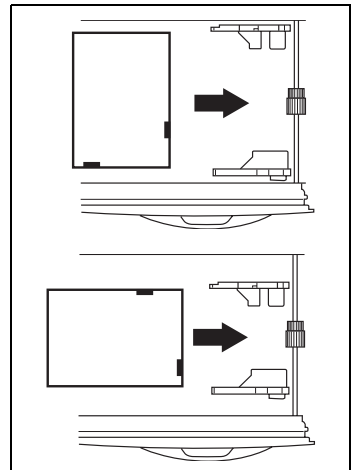

- 5 Slide the lateral guides against the edges of the paper.

- Make sure that the paper is not curled when it is loaded. Check that the lateral guides are pushed up against the edges of the paper.

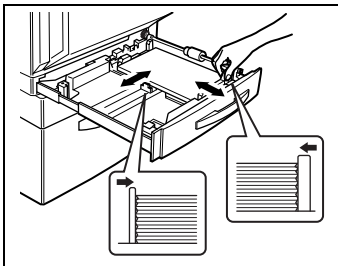

- 6 Close the paper drawer.

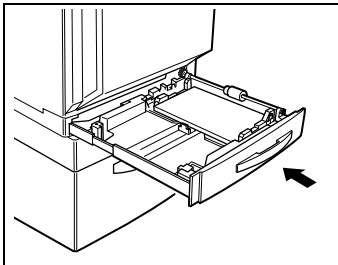

- 7 Turn the media type selection dial on the drawer to the setting for the type of paper loaded.

? *Are postcards loaded into the 1st drawer?*

- If postcards are loaded into the 1st drawer, set the paper type dial to "Thick 1".

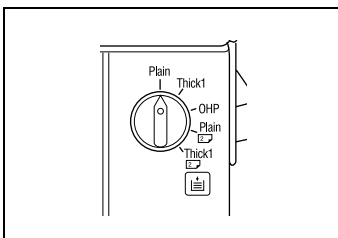

Setting the Paper Size

The default setting for the paper size of the 1st drawer is "Auto Detect". For postcards, non-standard or metric paper sizes, change the paper size according to the procedure in the following section.

To set the paper size for the 1st drawer

- 1 Press the [Utility] key to enter Utility mode.

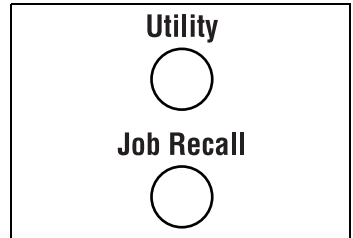

- 2 Touch [User's Choice].

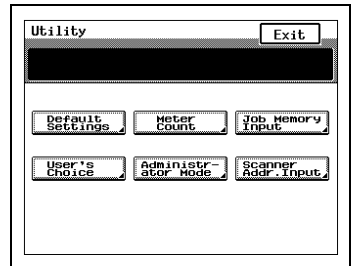

- 3 Touch [2/2] to view the next page.

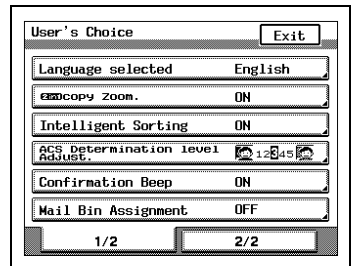

- 4 Touch [1st Drawer Paper Select].

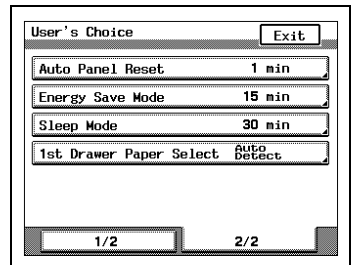

5 Touch [Input Size].

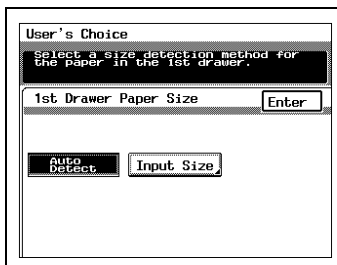

6 Select the desired paper size, and then touch [Enter].

? Will postcards be loaded into the 1st drawer?

→ If postcards are to be loaded into the 1st drawer, select [4 x 6].

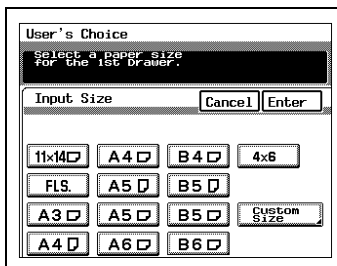

7 To specify a paper size other than those listed, touch [Custom Size], touch [X ⇄], [Y ⇄], [▼], and [▲], and to specify the desired size, and then touch [Enter].

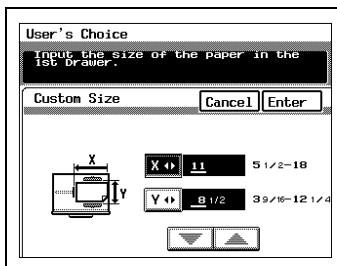

8 In the Input Size screen, touch [Enter].

9 In the 1st Drawer Paper Size screen, touch [Enter].

10 In the User's Choice screen, touch [Exit].

To load paper into the 2nd drawer or the 500-sheet paper feed unit

- 1 Pull out the paper drawer.

? *Has the paper take-up roller been touched?*

- Be careful not to touch the surface of the paper take-up roller with your hands. If the roller has been touched, wipe it with a dry cloth.

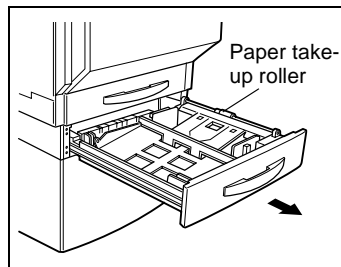

- 2 Press down on the paper-lifting plate until it locks into place.

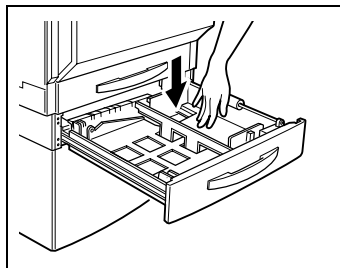

- 3 Remove the trailing-edge guide, and then re-install it for the size of paper to be loaded.

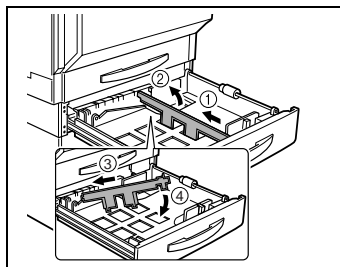

- 4 Slide the lateral guides to fit the size of paper to be loaded.

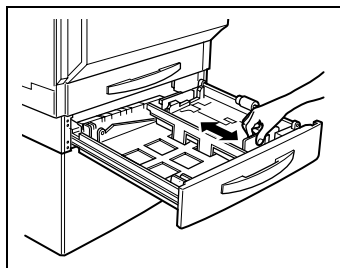

- 5 Load the paper into the drawer so that the front side of the paper (the side facing up when the package was unwrapped) faces up.

? *Has the paper been loaded correctly?*

If the paper is not loaded correctly, a paper misfeed may occur.

- Do not load so much paper that the top of the stack is higher than the ▼mark.
- Special paper cannot be fed from the 2nd drawer or optional paper feed units. If you wish to make copies onto special paper, feed it through the manual bypass tray or the 1st drawer.
- When loading additional paper, remove any paper remaining in the drawer, place it on the new paper, and then align the paper in the stack well before loading it into the drawer.
- We recommend replenishing the paper only after all of the paper in the drawer has been used.

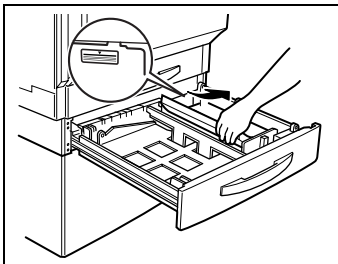

- 6 Slide the lateral guides against the edges of the paper.

- Make sure that the paper is not curled when it is loaded. Check that the lateral guides are pushed up against the edges of the paper.

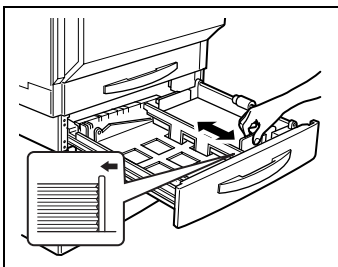

- 7 Close the paper drawer.

To load paper into the large-capacity cabinet

- 1 Pull out the paper drawer.

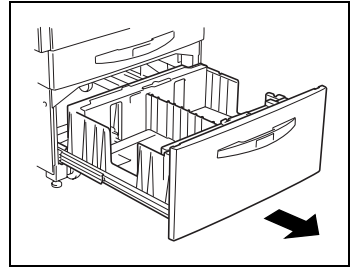

- 2 Load paper into the right side of the drawer so that the front side of the paper (the side facing up when the package was unwrapped) faces up.

? *Has the paper been loaded correctly?*

If the paper is not loaded correctly, a paper misfeed may occur.

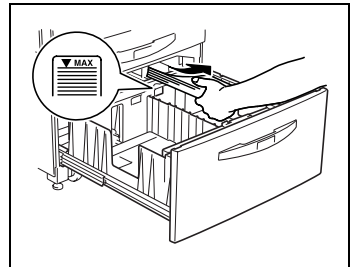

- Make sure that the paper is not curled when it is loaded.
- Do not load so much paper that the top of the stack is higher than the ▼mark.
- Special paper cannot be fed from the 2nd drawer or optional paper feed units. If you wish to make copies onto special paper, feed it through the manual bypass tray or the 1st drawer.
- When loading additional paper, remove any paper remaining in the drawer, place it on the new paper, and then align the paper in the stack well before loading it into the drawer.
- We recommend replenishing the paper only after all of the paper in the drawer has been used.

- 3 Load paper into the left side of the drawer so that the front side of the paper (the side facing up when the package was unwrapped) faces up.

? *Has the paper been loaded correctly?*

If the paper is not loaded correctly, a paper misfeed may occur.

- Make sure that the paper is not curled when it is loaded.
- Do not load so much paper that the top of the stack is higher than the ▼mark.
- Special paper cannot be fed from the 2nd drawer or optional paper feed units. If you wish to make copies onto special paper, feed it through the manual bypass tray or the 1st drawer.
- When loading additional paper, remove any paper remaining in the drawer, place it on the new paper, and then align the paper in the stack well before loading it into the drawer.
- We recommend replenishing the paper only after all of the paper in the drawer has been used.

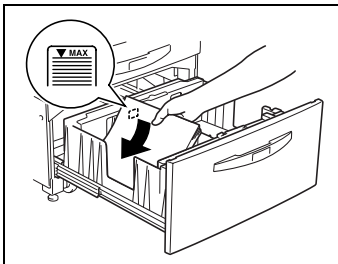

- 4 Close the paper drawer.

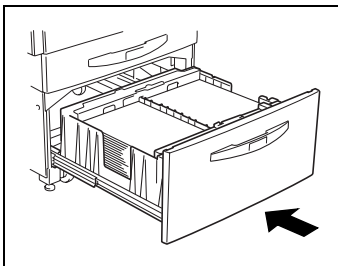

To load paper into the manual bypass tray

Paper can be fed manually through the manual bypass tray if you wish to copy onto paper that is not loaded into a drawer or if you wish to copy onto special paper, such as overhead transparencies, postcards, or thick paper 1 or 2.

- 1 Open the manual bypass tray.

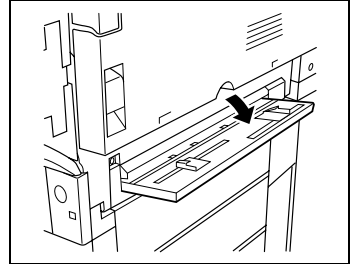

- 2 Adjust the paper guides to the size of the paper, and then load the paper so that the front side of the paper (the side facing up when the package was unwrapped) faces down. Lightly slide the paper into the feed slot as much as possible so that it is ready to be fed into the copier.

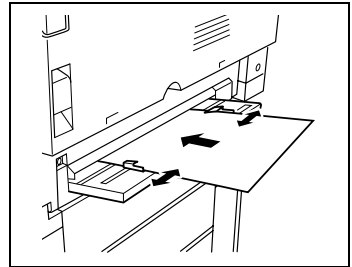

? *Do you need more information on feeding paper through the manual bypass tray?*

- Feed only one sheet of paper at a time.
- Copies will be made on the surface of the paper facing down when it is loaded into the manual bypass tray.

? *Is a postcard loaded?*

- When loading a postcard, load it as shown.

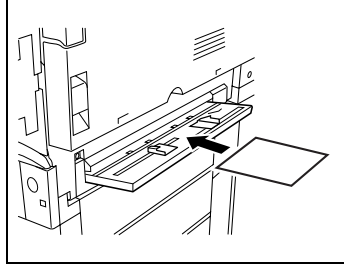

- Do not load the postcard crosswise, as shown.

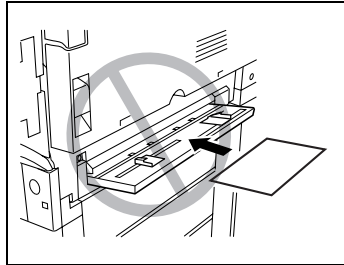

? *Is the recommended overhead projector transparency loaded?*

- When loading the recommended overhead projector transparency, load it as shown in the illustration.

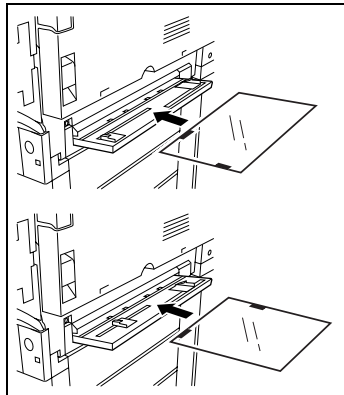

- 3 Make sure that the screen that allows you to select the manual bypass tray paper size is displayed, and then select the desired paper size.

or

For a paper size preceded by “A” or “B”, touch [Metric] to display a screen containing metric paper size settings.

or

For a paper size other than the standard sizes listed on the screen, touch [Custom Size] to display a screen that allows you specify a size.

? Do you wish to return to the screen displaying paper sizes in inches?

→ Touch [Inch] to display the inch paper size settings.

? Do you wish to specify a non-standard paper size?

→ Touch $X \leftrightarrow$, $Y \leftrightarrow$, and ∇ , \blacktriangle to select the desired size, and then touch [Enter].

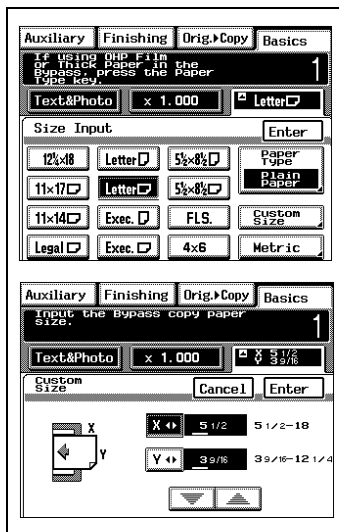

- 4 Touch [Paper Type], select the setting for the type of paper loaded, and then touch [Enter].

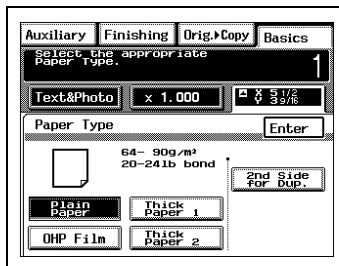

4 Original Documents

4.1 Feeding the Document

The document can be fed in three different ways. Depending on the type of document being fed, position the document correctly so that it is fed using the appropriate feed method.

Document Feed Method	Features
Multi-sheet feeding	Using the duplexing document feeder, a multi-page document can be fed automatically. This feed method can also be used with double-sided documents, and is best with multi-page double-sided documents. See p. 4-4, p. 4-5, p. 6-17.
Single-sheet feeding	Using the duplexing document feeder, the document is fed one page at a time. This feed method cannot be used with double-sided documents (however, they can be scanned one side at a time). This feed method is best with a document consisting of a few single-sided pages. In addition, thick paper and thin paper can be scanned using this feed method. See p. 4-7, p. 4-9.
Manual feeding	The document is placed directly on the original glass, then scanned. Each document must be positioned manually (the previous one must be removed and the next one placed on the original glass). This method is best with books and other documents that cannot be fed through the duplexing document feeder. See p. 4-11, p. 4-12, p. 4-13, p. 4-14.

Document Paper Types



Note

Be sure to use the document paper type appropriate for the feed method being used.

If the correct paper type is not used, a paper misfeed or damage to the document may occur.

Document Feed Method	Document Paper Type	Document Paper Size
Multi-sheet feeding	Sheet documents <ul style="list-style-type: none"> • Capacity of single-sided documents: 13-1/4 lbs. to 29-1/4 lbs. • Capacity of double-sided documents: 16 lbs. to 24 lbs. • Capacity of documents of mixed sizes: 16 lbs. to 24 lbs. 	Document width: 5-1/2 in. to 11-3/4 in. Document length: 8-1/4 in. to 17 in.
Single-sheet feeding	Sheet documents <ul style="list-style-type: none"> • Capacity of single-sided documents: 9-1/4 lbs. to 53-1/4 lbs. 	Document width: 5-1/2 in. to 11-3/4 in. Document length: 8-1/4 in. to 17 in.
Manual feeding	Documents, books, large objects up to a weight of 4-1/2 lbs.	Document width: Less than 11-3/4 in. Document length: Less than 17 in.

Precautions for Multi-Sheet Feeding and Single-Sheet Feeding

The following types of documents should not be used for multi-sheet feeding or single-sheet feeding, otherwise paper misfeeds or damage to the document may occur. Instead, these types of documents should be fed manually.

- Thin documents such as typewriter paper or paraffin paper
- Thick documents
- Standard size documents larger than 11 × 17L or smaller than 5-1/2 × 8-1/2
- Documents that are transparent or translucent, such as overhead transparencies or diazo photosensitive paper
- Wrinkled, folded, rolled, or torn documents
- Documents bound with clips or staples
- Coated documents such as carbon-backed paper

Precautions for Manual Feeding

The following precautions should be observed when manually feeding the types of documents listed.

- For non-standard sized documents:
The document size cannot be detected automatically, therefore, the Paper setting “Auto Paper” and the Zoom setting “Auto Size” cannot be used together. Select a different Paper setting by touching “Paper” on the Basic screen, then selecting the paper size of the document, or select a different Zoom setting by touching [Zoom] on the Basic screen, then selecting a zoom ratio. (Refer to page 5-14 for more details.)
- For documents that are transparent or translucent, such as overhead transparencies or diazo photosensitive paper:
Place a blank sheet of paper of the same size as the document over the document. (Refer to page 4-12 for more details.)
- For thick objects, such as books:
Scan without closing the original cover or duplexing document feeder. In addition, do not press down extremely hard on the document, otherwise the copier may be damaged. (The original glass can only resist a weight of up to 4-1/2 lbs.)

4.2 Feeding the Document Through the Duplexing Document Feeder

The duplexing document feeder feeds in, scans, then automatically feeds out each page in a multi-page document, one page at a time. The correct types of documents must be loaded in order for the duplexing document feeder to function properly.



CAUTION

DO NOT leave the document feeder open as there is a danger of personal injury.

Multi-Sheet Feeding (Sheet Documents)

A stack of documents of different sizes can be copied as a set using the duplexing document feeder. (Refer to “Feeding Documents of Different Sizes (“Mixed Orig Detection” Function)” on page 6-17.)

To make copies using multi-sheet feeding (sheet documents)

A maximum of 50 document pages can be loaded.

When loading the documents:

- ✓ Be sure to adjust the paper guide to the size of the document, otherwise the documents may not be fed in straight.

- 1 Slide the adjustable document guide to fit the size of the documents.

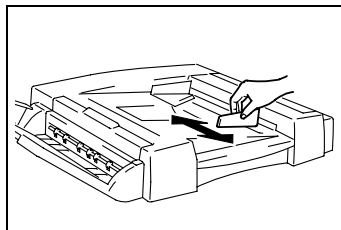

- 2 Load the documents face up into the document feed tray.

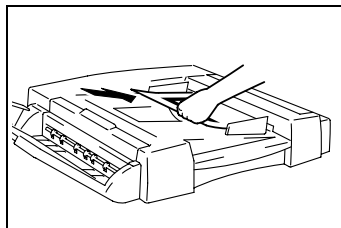

- 3 Press the [Start] key to start feeding and copying the documents from the top page.

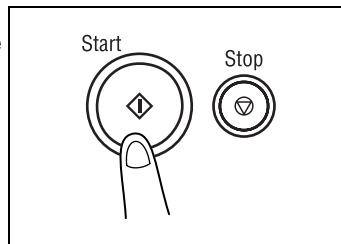

Multi-Sheet Feeding (Documents of Mixed Sizes)

With this feature, a stack of documents of different sizes can be copied as a set using the duplexing document feeder. (For more details, refer to “Feeding Documents of Different Sizes (“Mixed Orig Detection” Function)” on page 6-17.)

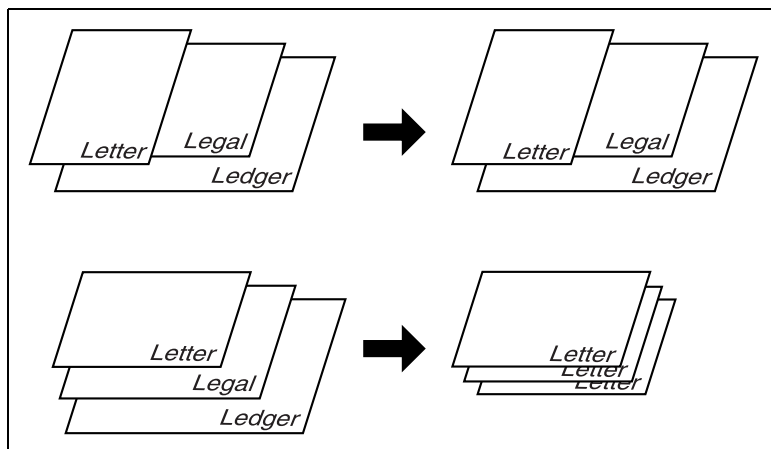

To make copies using multi-sheet feeding (documents of mixed sizes)

A maximum of 50 document pages can be loaded.

When loading the documents:

- ✓ Be sure to adjust the paper guide to the size of the document, otherwise the documents may not be fed in straight.

- 1 Slide the adjustable document guide to fit the size of the documents.

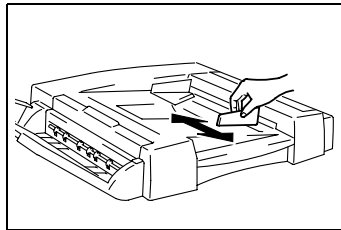

- 2 Load the documents face up into the document feed tray, making sure that one side of all loaded documents are aligned along the fixed document guide.

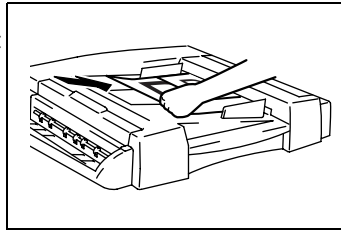

- 3 Slide the adjustable document guide to the edge of the largest document.

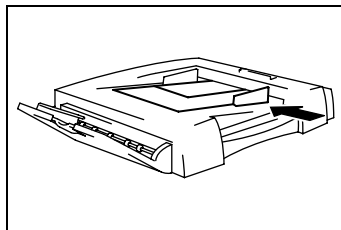

- 4 Press the [Start] key to start feeding and copying the documents from the top page.

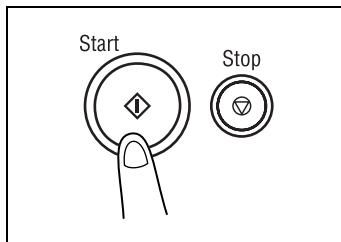

Single-Sheet Feeding (Standard Paper/Thick Paper)

With single-sheet feeding, the following are not available:

“Double-Sided” setting, “2in1” setting, “Book” setting, “Sort” setting, “OHP Interleaving” function, manual feeding

To make copies using single-sheet feeding

When loading the documents:

- ✓ Be sure to load the documents one sheet at a time.
- ✓ Be sure the documents are not folded or curled when they are fed.

- 1 Specify the settings that can be used with single-sheet feeding (for example, the Zoom setting and the number of copies).

? *Do you need more information about the settings?*

→ Refer to “5 Basic Operations” and “6 Advanced Operations”.

- 2 Open the single-sheet feed tray, and then slide the adjustable document guide to fit the size of the document.

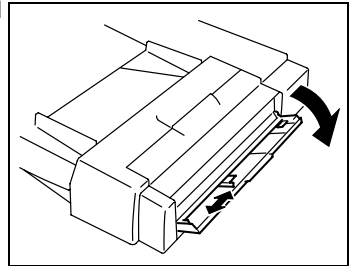

- 3 When the indicator on the [Start] key lights up in green, insert one page of the document face down into the single-sheet feed tray.

The indicator on the [Start] key lights up in orange and the document is fed and copied.

? *Is the document inserted correctly?*

- Insert the document pages one at a time.
- Be sure the documents are not folded or curled when they are fed.

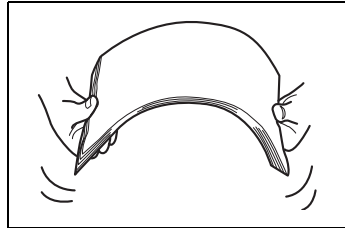
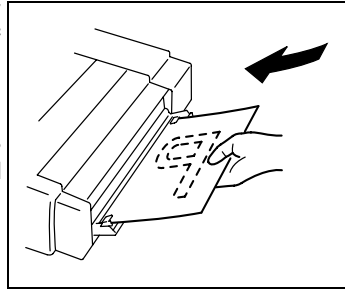

- 4 Make sure the indicator on the [Start] key lights up in green before feeding the next page of the document.

Single-Sheet Feeding (Thin Paper)

With single-sheet feeding, the following are not available:

“Double-Sided” setting, “2in1” setting, “Book” setting, “Sort” setting, “OHP” Interleaving function, manual feeding

Before loading documents printed on thin paper (thickness: 9-1/4 to 13-1/4 lbs.), set the “Thin Orig.” parameter of the Expert User’s mode to “ON”. For more details, refer to the section “To set the “Thin Orig.” parameter” of “Specifying the Expert Settings (“Expert User’s Mode” Function)” on page 8-33.

To make copies using single-sheet feeding

When loading the documents:

- ✓ Be sure to load the documents one sheet at a time.
- ✓ Be sure the documents are not folded or curled when they are fed.

1 Touch [Orig. ► Copy].

2 Touch [Thin Orig.]

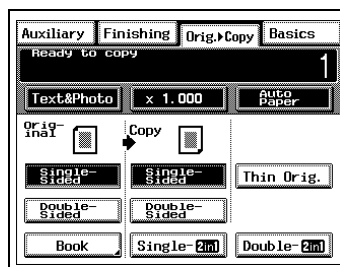

- 3 Select the desired settings for functions that can be used with single-sheet feeding (such as the zoom ratio and the number of copies). For more details, refer to “5 Basic Operations” and “6 Advanced Operations”.
- 4 Continue with steps 2 through 4 of “Single-Sheet Feeding (Standard Paper/Thick Paper)” on page 4-7.

4.3 Positioning the Document on the Original Glass

The method for positioning the document differs depending on the type of document being copied, therefore be sure the document is positioned correctly. For information on using the duplexing document feeder, refer to page 4-4.

**Note**

Lift open the original cover, or the duplexing document feeder if it is installed, 15° or more, otherwise the document size will not be detected and the correct paper size or zoom ratio may not be selected automatically.

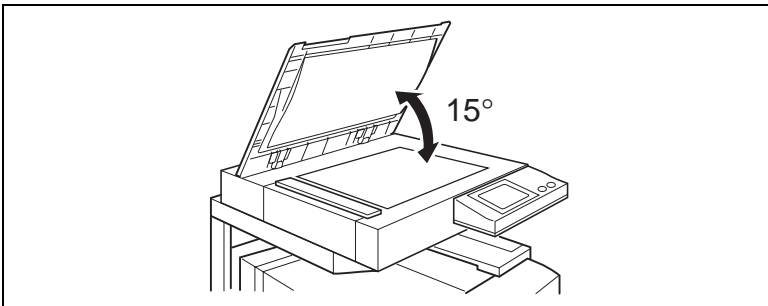
**CAUTION**

DO NOT leave the document feeder open as there is a danger of personal injury.

Manual Feeding (Sheet Documents)

To make copies using manual feeding (sheet documents)

- 1 Lift open the original cover, or the duplexing document feeder if it is installed.

- 2 Position the document face down onto the original glass.

? *Does the object that is placed on the original glass exceed the maximum weight allowable?*

- Do not place a document heavier than 4-1/2 lbs. on the original glass.

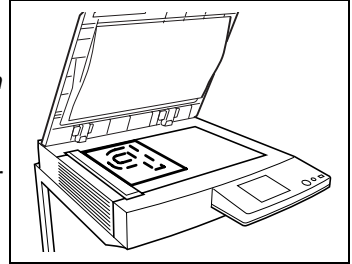

- 3 Align the corner of the document with the arrow marks on the document scales above and to the left of the original glass.

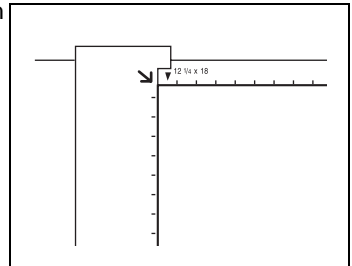

- 4 Close the original cover, or the duplexing document feeder if it is installed.

- 5 Select the desired settings.

? *Do you need more information about the settings?*

- Refer to "5 Basic Operations" and "6 Advanced Operations".

- 6 Press the [Start] key to copy the document.

Manual Feeding (Transparent or Translucent Documents)

To make copies using manual feeding (transparent or translucent documents)

When copying a transparent or translucent document, such as overhead transparencies, tracing paper or diazo photosensitive paper, position it as described below.

- 1 Lift open the original cover, or the duplexing document feeder if it is installed.
- 2 Position the document face down onto the original glass.

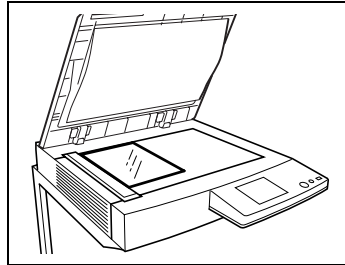

- 3 Align the corner of the document with the arrow marks on the document scales above and to the left of the original glass.

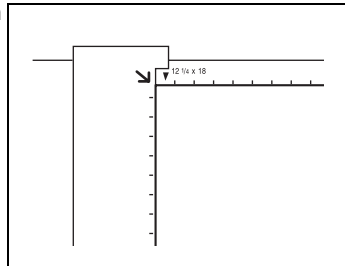

- 4 Place a blank sheet of paper of the same size as the document over the document.

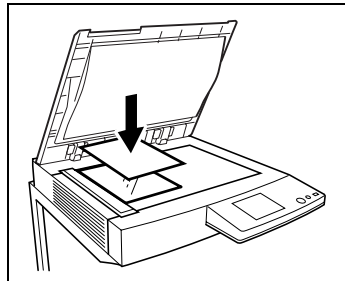

- 5 Close the original cover, or the duplexing document feeder if it is installed.

- 6 Select the desired settings.

? *Do you need more information about the settings?*

→ Refer to “5 Basic Operations” and “6 Advanced Operations”.

- 7 Press the [Start] key to copy the document.

Manual Feeding (Books)



Note

Do not place objects weighing more than 4-1/2 lbs. on the original glass. In addition, do not press down extremely hard on the document.

Applying a strong force to the original glass may damage it.

To make copies using manual feeding (books)

When copying a document spread over two facing pages, such as in a book or magazine, position it as described below.

- 1 Lift open the original cover, or the duplexing document feeder if it is installed.

- 2 Position the book face down onto the original glass, with the top of the book toward the rear of the copier and with the center of the book aligned with the book mark () on the document scale.

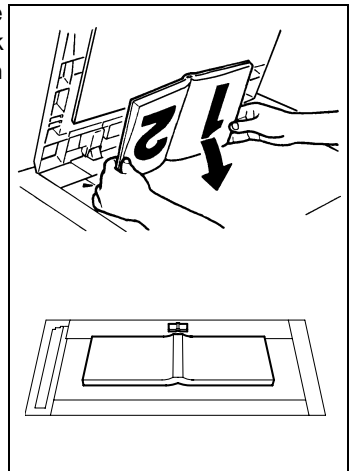

- 3 Close the original cover, or the duplexing document feeder if it is installed.

? *Is a thick book or object being copied?*

→ Make the copy without closing the original cover or duplexing document feeder.

? *Is the document being scanned without closing the original cover or duplexing document feeder?*

→ Do not look directly at the bright light that may shine through the original glass. Although the light that shines through the glass is bright, it is not a laser beam and, therefore, is not as dangerous.

4 Select the desired settings.

? *Do you need more information about the settings?*

→ Refer to “5 Basic Operations” and “6 Advanced Operations”.

5 Press the [Start] key to copy the document.

Manual Feeding (“12-1/4 × 18” Paper)



Note

Do not place objects weighing more than 4-1/2 lbs. on the original glass. In addition, do not press down extremely hard on the document. Applying a strong force to the original glass may damage it.

To make copies using manual feeding (“12-1/4 × 18” paper)

When copying 11 × 17-size documents onto “12-1/4 × 18” paper, position the document as described below.

- 1 Lift open the original cover, or the duplexing document feeder if it is installed.
- 2 Position the document face down onto the original glass, aligning it with the “12-1/4 × 18” mark on the top document width scale as shown in the illustration.

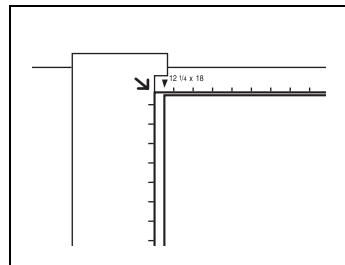

- 3 Close the original cover, or the duplexing document feeder if it is installed.

- 4 Select the desired settings.
 - ? *Do you need more information about the settings?*
 - Refer to “5 Basic Operations” and “6 Advanced Operations”.
- 5 Press the [Start] key to copy the document.

5 Basic Operations

5.1 Making Copies

The following procedure describes how to insert the document and make a basic copy of it.

To copy a document (To make a basic copy)

The default settings (specified during manufacturing of the copier) of the Basic screen are: the “Full Color” copy mode selected, Original Image Type set to “Text&Photo”, Zoom set to “x1.000”, Paper set to “Auto Paper”, and the number of copies set to “1”.

- 1 Press the [Copy] key to enter Copy mode.

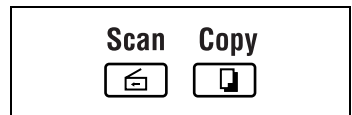

- 2 Position the document(s) to be copied. (Refer to page 4-1 for more details.)

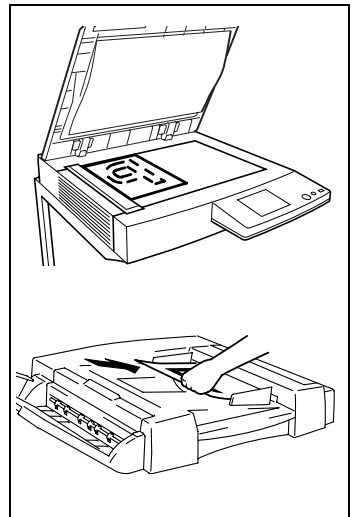

- 3 Select the desired color mode (Auto Color, Full Color, or Black). (Refer to page 2-20 for more details.)

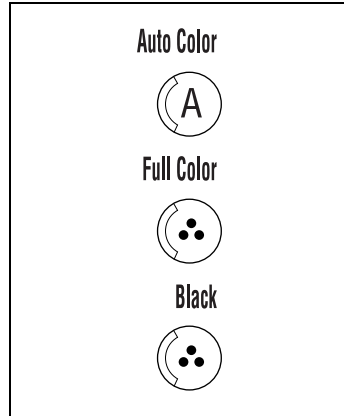

- 4 Make sure that the Basic screen is displayed.

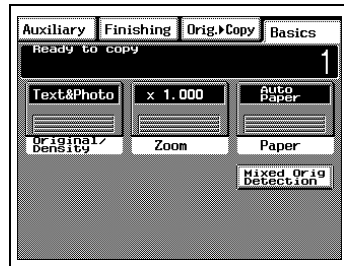

- 5 Specify any other necessary settings.

- Paper (Refer to page 5-4 for more details.)
- Zoom (Refer to page 5-14 for more details.)
- Original Image Type (Refer to page 5-18 for more details.)
- Density (Refer to page 5-20 for more details.)

- 6 Using the keypad, enter the number of copies you wish to make.

? *Does the wrong number of copies appear?*

- Press the [C] (clear) key, and then enter the correct number of copies.
- The number of copies can only be set to a number between 1 and 100.

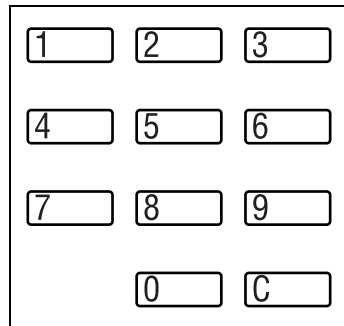

- 7 Press the [Start] key.
The set number of copies are made.

? *Do you wish to stop copying
before the set number of copies
are made?*

→ Press the [Stop] key.

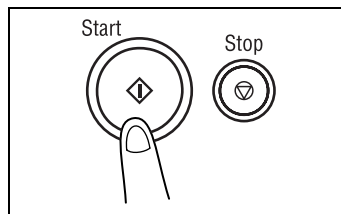

5.2 Selecting the Paper Source

Before making a copy, the tray or drawer containing the paper that will be used must be selected.

Either the paper source is selected automatically when the size of the document is detected, or the desired paper source can be selected manually.

- Auto Paper:

If "Auto Paper" is selected, the tray or drawer containing the most suitable size of paper is selected based on the size of the document and the specified Zoom setting.
- Manual paper selection:

The tray or drawer containing the paper that you wish to use can be selected.

To select the paper source before copying

- 1 Position the document(s) to be copied. (Refer to page 4-1 for more details.)
- 2 Select the desired color mode. (Refer to page 2-20 for more details.)
- 3 Make sure that the Basic screen is displayed, and then touch [Paper].

A screen that allows you to select the paper source appears.

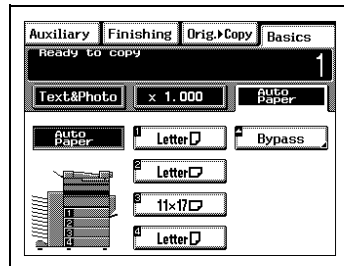

- 4 Select the tray or drawer containing the paper that you wish to use.
- 5 Specify any other necessary settings.
 - Zoom (Refer to page 5-14 for more details.)
 - Original Image Type (Refer to page page 5-18 for more details.)
 - Density (Refer to page 5-20 for more details.)
- 6 Using the keypad, enter the number of copies you wish to make, and then press the [Start] key.

5.3 Making Copies on Paper Loaded into the 1st Drawer (Multipurpose Paper Drawer)

When making continuous copies onto special paper, such as overhead projector transparencies, postcards or thick paper, whether a standard or non-standard size, load the paper into the 1st drawer (the multipurpose paper drawer).

Sizes and types of paper that can be used:

- Automatically detected paper sizes:
5-1/2 × 8-1/2L, 5-1/2 × 8-1/2C, ExecutiveL, ExecutiveC, LetterL, LetterC, LegalL, 11 × 17L, 12-1/4 × 18L
- Manually set paper sizes:
A6L, B6L, A5L, A5C, B5L, B5C, A4L, A4C, B4L, A3L, 11 × 14L, FLS L, 4 × 6
Refer to the section “To set the “1st Drawer Paper Select” parameter” on page 7-18 for more details.
- Selectable paper sizes
Width: 3-9/16 to 12-1/4 in. (90 to 311 mm)
Length: 5-1/2 to 18 in. (140 to 457 mm)
Refer to the section “To set the “1st Drawer Paper Select” parameter” on page 7-18 for more details.
- Paper types:
Standard paper (thickness: 17 to 24 lbs.)
Thick paper 1 (thickness: 24-1/4 to 43-1/4 lbs.)
Overhead projector transparencies
Second side of a double-sided copy on standard paper
Second side of a double-sided copy on thick paper 1

To copy a document

- 1 Position the document(s) to be copied. (Refer to page 4-1 for more details.)

- 2 Turn the paper type dial on the 1st drawer to the setting for the type of paper loaded. (Refer to page 3-7 for more details.)

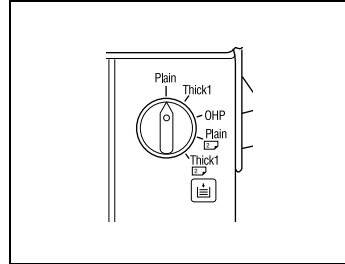

- 3 Select the desired color mode. (Refer to page 2-20 for more details.)

- 4 Make sure that the Basic screen is displayed, and then touch [Paper]. A screen that allows you to select the paper source appears.

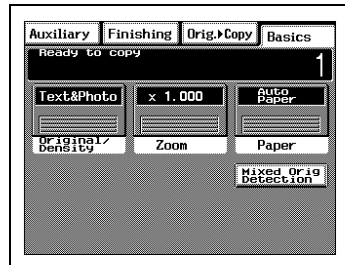

- 5 Select the 1st drawer. (In the example screen shown at the right, overhead projector transparencies have been loaded into the 1st drawer.)

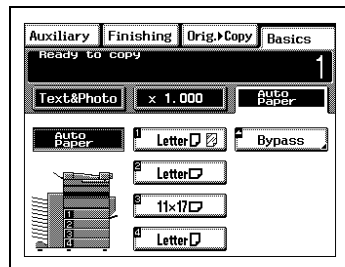

- 6 Specify any other necessary settings.

- Zoom (Refer to page 5-14 for more details.)
- Original Image Type (Refer to page 5-18 for more details.)
- Density (Refer to page 5-20 for more details.)

- 7 Using the keypad, enter the number of copies you wish to make, and then press the [Start] key.

5.4 Feeding Paper Manually

Paper can be fed manually through the manual bypass tray if you wish to copy onto paper that is not loaded into a drawer, or if you wish to copy onto special paper, such as overhead transparencies, postcards or thick paper.

Types of paper that can be fed through the manual bypass tray:

- Normal paper with a thickness between 17 and 24 lbs. ("Plain Paper" setting)
- Thick paper with a thickness between 24-1/4 and 43-1/4 lbs. ("Thick Paper 1" setting)
- Thick paper with a thickness between 43-1/2 and 55-1/2 lbs. ("Thick Paper 2" setting)
- Overhead projector transparencies ("OHP Film" setting)
- Postcards.

Size of paper that can be fed through the manual bypass tray:

- Maximum size: 12-1/4 x 18 in. (311 x 457 mm)
- Minimum size: 3-9/16 x 5-1/2 in. (90 x 140 mm)

To feed the paper manually

- 1 Position the document(s) to be copied. (Refer to page 4-1 for more details.)
- 2 Select the desired color mode. (Refer to page 2-20 for more details.)
- 3 Open the manual bypass tray.

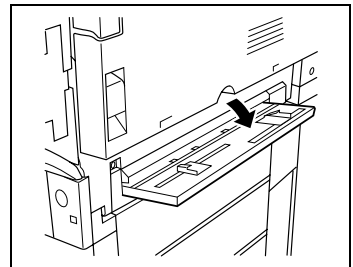

- 4 Adjust the paper guides to the size of the paper, and then load the paper so that the front side of the paper (the side facing up when the package was unwrapped) faces down. Lightly slide the paper into the feed slot as much as possible so that it is ready to be fed into the copier.

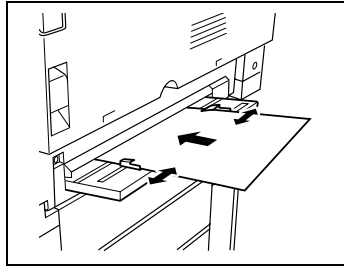

? *Do you wish to use the manual bypass tray to feed paper manually?*

- Feed only one sheet of paper at a time.
- Copies will be made on the surface of the paper facing down when it is loaded into the manual bypass tray.

- 5 Make sure that the screen that allows you to select the manual bypass tray paper size is displayed, and then select the desired paper size.

- For paper sizes in metric measurements, touch [Metric] to display a screen that allows you to select metric paper sizes.
- To specify a paper size other than the standard sizes listed on the screen, touch [Custom Size]. Touch [X], [Y], [Down Arrow], and [Up Arrow] to select the desired size, and then touch [Enter].

? *Do you wish to set the fractional units?*

- Touch [X] or [Y] until the cursor moves below the fraction that you wish to change.

? *Has paper not been loaded into the manual bypass tray yet?*

- Copies can also be made by loading paper into the manual bypass tray after selecting the paper size by touching [Paper] in the Basic screen, then touching [Bypass].

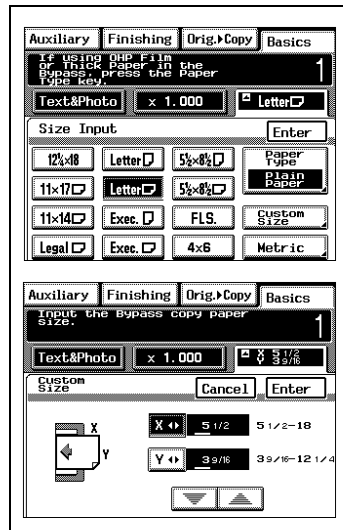

- 6 Touch [Paper Type], select the type of paper that will be loaded, and then touch [Enter].

? *Do you wish to continue copying on the back of a manually fed copy?*

- For best results when copying onto the back of a manually fed copy, touch [2nd Side for Dup.].

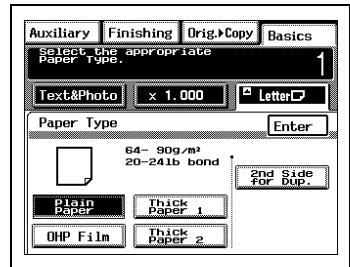

- 7 Specify any other necessary settings.

- Zoom (Refer to page 5-14 for more details.)
- Original Image Type (Refer to page 5-18 for more details.)
- Density (Refer to page 5-20 for more details.)

- 8 Press the [Start] key.

? *Do you wish to continue copying using the same settings?*

- To copy more pages after the second page with the same settings, feed paper into the manual bypass tray to begin making copies automatically.

To make copies onto overhead projector transparencies

Overhead transparencies have a top and bottom side.

- ✓ In order to make crisp copies, be sure to insert the overhead transparencies correctly into the tray.
- ✓ When using overhead transparencies with a white frame printed on them, load them so that the top surface faces down.

- 1 Position the document(s) to be copied. (Refer to page 4-1 for more details.)
- 2 Select the desired color mode. (Refer to page 2-20 for more details.)
- 3 Open the manual bypass tray.

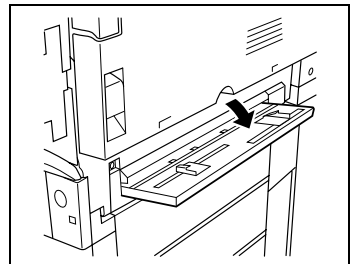

- 4 Adjust the paper guides to the size of the paper, and then load the paper so that the front side of the paper faces down. Lightly slide the paper into the feed slot as much as possible so that it is ready to be fed into the copier.

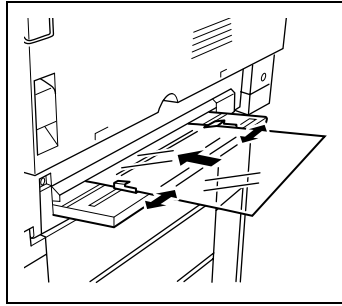

? Are the recommended overhead projector transparencies being used?

- When using the recommended overhead projector transparencies, load them as described on page 3-17.

- 5 Make sure that the screen that allows you to select the manual bypass tray paper size is displayed, check that the desired paper size is selected, and then touch [Paper Type].

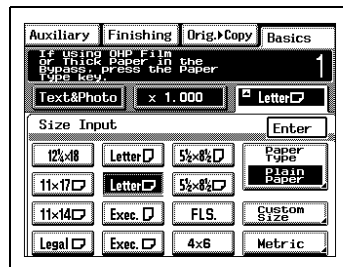

- 6 Touch [OHP Film], and then touch [Enter].

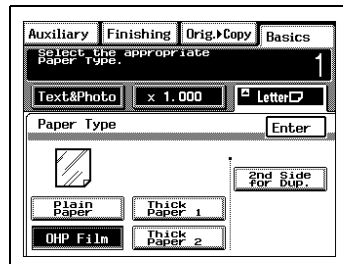

- 7 Specify any other necessary settings.
- Zoom (Refer to page 5-14 for more details.)
 - Original Image Type (Refer to page 5-18 for more details.)
 - Density (Refer to page 5-20 for more details.)
- 8 Press the [Start] key.

To make copies onto postcards

- 1 Position the document(s) to be copied. (Refer to page 4-1 for more details.)
- 2 Select the desired color mode. (Refer to page 2-20 for more details.)
- 3 Open the manual bypass tray.

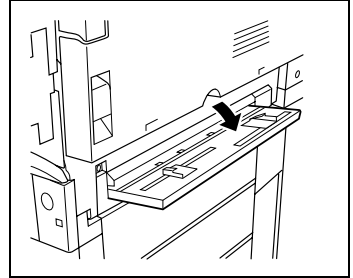

- 4 Adjust the paper guides to the size of the paper, and then load the paper so that the front side of the paper faces down. Lightly slide the paper into the feed slot as much as possible so that it is ready to be fed into the copier.
 - Load postcards widthwise into the manual bypass tray with the surface to be copied onto facing down.

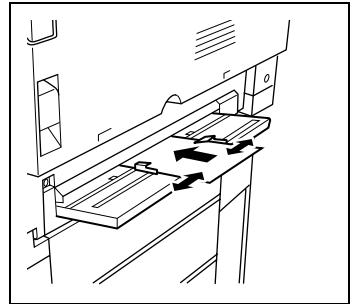

- 5 Make sure that the screen allowing you to select the manual bypass tray paper size is displayed, and then touch [4 x 6].

The "Paper Type" setting automatically changes to "Thick Paper 2".

(* Setting the paper size for the manual bypass tray to "4 x 6" automatically changes the "Paper Type" setting to "Thick Paper 2".)

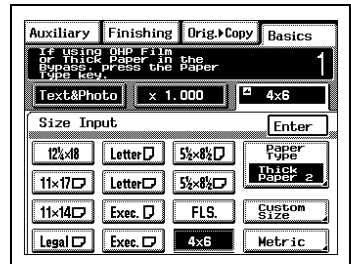

- 6 Specify any other necessary settings.
 - Zoom (Refer to page 5-14 for more details.)
 - Original Image Type (Refer to page 5-18 for more details.)
 - Density (Refer to page 5-20 for more details.)
- 7 Press the [Start] key.

To make copies onto thick paper

- 1 Position the document(s) to be copied. (Refer to page 4-1 for more details.)
- 2 Select the desired color mode. (Refer to page 2-20 for more details.)
- 3 Open the manual bypass tray.

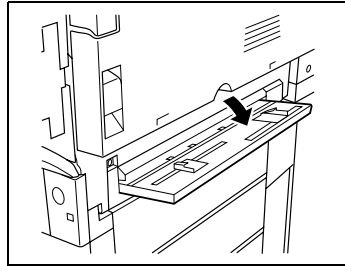

- 4 Adjust the paper guides to the size of the paper, and then load the paper so that the front side of the paper faces down. Lightly slide the paper into the feed slot as much as possible so that it is ready to be fed into the copier.

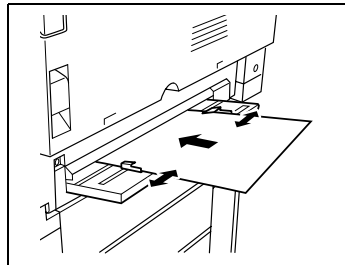

- Load paper into the manual bypass tray with the surface to be copied onto facing down.

- 5 Make sure that the screen that allows you to select the manual bypass tray paper size is displayed, check that the desired paper size is selected, and then touch [Paper Type].

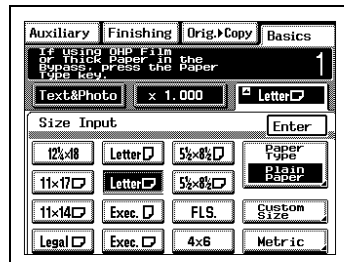

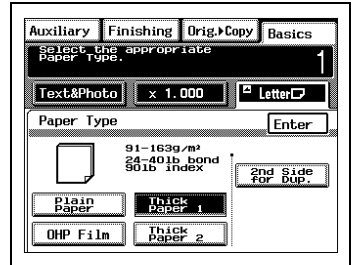

- 6 Touch [Thick Paper 1] (for a paper thickness of 24-1/4 to 43-1/4 lbs.) or touch [Thick Paper 2] (for a paper thickness of 43-1/2 to 55-1/2 lbs.), and then touch [Enter].



- 7 Specify any other necessary settings.
 - Zoom (Refer to page 5-14 for more details.)
 - Original Image Type (Refer to page 5-18 for more details.)
 - Density (Refer to page 5-20 for more details.)
- 8 Press the [Start] key.

5.5 Specifying a Zoom Setting



By specifying a zoom ratio, the copy can be enlarged or reduced.

Zoom settings	
Auto Size:	This setting automatically selects the most appropriate zoom ratio based on the size of the document loaded and the specified paper size.
Preset sizes:	<p>The following common Zoom settings for copying from various standard document sizes to standard paper sizes are available.</p> <ul style="list-style-type: none"> • × 0.500 • × 0.647 (11 × 15 ► Letter) • × 0.733 (11 × 17 ► Letter) • × 0.785 (Legal ► Letter) • × 1.214 (Legal ► 11 × 17) • × 1.294 (Letter ► 11 × 17) • × 1.545 (5 1/2 × 8 1/2 ► Legal) • × 2.000
Minimal:	<p>This setting slightly reduces the copy, ensuring that an original image positioned at the edge of the page will not be cut off in the copy.</p> <p>* The zoom ratio of the "Minimal" setting can be set between × 0.900 and × 0.999. See p. 5-16.</p>
 and  :	Touch the up or down arrows to increase or decrease the zoom ratio in 0.001 increments. Keep touching the arrow to change the zoom ratio more quickly.
Full Size:	This setting makes a copy the same size as the document (×1.000).
CustomZoom:	With this setting, the keypad can be used to enter a zoom ratio.

To specify the zoom ratio before copying

- 1 Position the document(s) to be copied. (Refer to page 4-1 for more details.)
- 2 Select the desired color mode. (Refer to page 2-20 for more details.)
- 3 Make sure that the Basic screen is displayed, and then touch [Zoom]. A screen that allows you to select the zoom ratio appears.



- 4 Specify the desired zoom ratio.
 - Touch  and  to select the desired zoom ratio. The desired zoom ratio can also be entered by touching [CustomZoom], then using the keypad to type in the desired zoom ratio. Touch [OK] in the CustomZoom screen to set the zoom ratio.

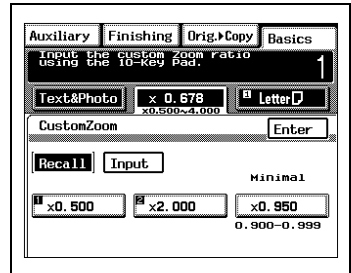

- 5 Specify any other necessary settings.
 - Paper (Refer to page 5-4 for more details.)
 - Original Image Type (Refer to page 5-18 for more details.)
 - Density (Refer to page 5-20 for more details.)
- 6 Using the keypad, enter the number of copies you wish to make, and then press the [Start] key.

To record a zoom ratio

Frequently used zoom ratios can be recorded, so that they can be used again later.

- 1 In the screen that allows you to select the zoom ratio, touch [CustomZoom].



- 2 Touch [Input], and then use the keypad to enter the zoom ratio that you wish to record.

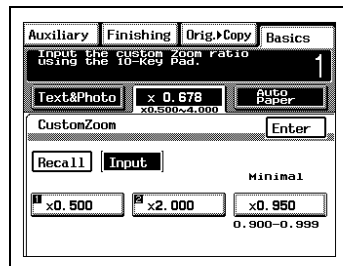

- 3 Touch the record ("1", "2" or "Minimal") where you wish to store the new zoom ratio.

The new zoom ratio is recorded and appears within the box where it is stored.

? Do you wish to overwrite a previously recorded zoom ratio?

- When a new zoom ratio is recorded, the previous one is replaced with the old one. If you wish to continue using the previously recorded zoom ratio, select a different record for storing the new one.

? Do you know what is the range for the "Minimal" zoom ratio?

- The zoom ratio of the "Minimal" setting can be set between $\times 0.900$ and $\times 0.999$.

- 4 Touch [Enter].

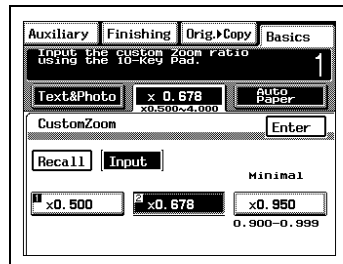

To recall a recorded zoom ratio

The recorded zoom ratios can be recalled whenever they are needed.

- 1 In the screen that allows you to select the zoom ratio, touch [CustomZoom].



- 2 Touch the zoom ratio that you wish to recall ("1", "2" or "Minimal").

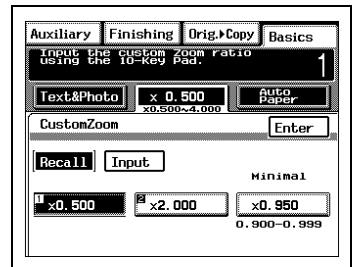

- 3 Touch [Enter].

5.6 Selecting the Original Image Type

By selecting the document type that describes your document, a more faithful copy can be made.

Original Image Type settings and Screen Pattern settings

- Original Image Type settings
 - Text&Photo:
With this setting, a document containing both text and photos is scanned with a medium gradation, enabling both the text and photos to be reproduced faithfully.
 - Photo Image:
With this setting, a document containing photos printed on photographic paper is scanned with a high gradation, enabling the photos to be reproduced faithfully.
 - Printed Image:
Select this setting when copying a document containing printed photos.
 - Text:
With this setting, a clear copy of a document containing only text can be made by emphasizing the contours.
 - Map:
Select this setting when copying a document containing detailed diagrams and text.
- Screen Pattern settings
If moiré effects should occur in copies containing lines or shading, reduce their effects by selecting the appropriate setting. “Gradation” is the default setting; however, “Resolution” is also available. These settings are only available if “Text&Photo”, “Photo Image” or “Printed Image” are selected.

To select the document type before copying

- 1 Position the document(s) to be copied. (Refer to page 4-1 for more details.)
- 2 Select the desired color mode. (Refer to page 2-20 for more details.)
- 3 Make sure that the Basic screen is displayed, and then touch [Original/Density].

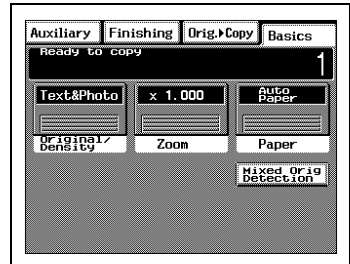

- 4 Select the Original Image Type that best describes your document.



- 5 Specify any other necessary settings.
 - Paper (Refer to page 5-4 for more details.)
 - Zoom (Refer to page 5-14 for more details.)
 - Density (Refer to page 5-20 for more details.)
- 6 Using the keypad, enter the number of copies you wish to make, and then press the [Start] key.

5.7 Specifying the Copy Density

Density settings

- Background:

This density can be set to adjust itself automatically or it can be manually set to one of eight levels.

 - If the background density is set to “Auto”, the background of the copy is automatically adjusted according to the background of the original document.
 - To prevent the image on the back of newspaper or magazine articles from being copied, select a setting toward “Lighter”. To copy pale colors in a bright area of the image, select a setting toward “Darker”. Since selecting a setting too much toward “Darker” may print the image on the back of the document or selecting a setting too much toward “Lighter” may produce a very faint copy, select the appropriate level depending on the document.
- Density:

This density can be set to one of eight different levels.

 - Fine adjustments can be made to the copy density using the “Density” parameter of the “Color Adjustment” function on the Auxiliary screen. For more details, refer to the section “To adjust the density” on page 6-29.

To specify the copy density before copying

- 1 Position the document(s) to be copied. (Refer to page 4-1 for more details.)
- 2 Select the desired color mode. (Refer to page 2-20 for more details.)
- 3 Make sure that the Basic screen is displayed, and then touch [Original/Density].

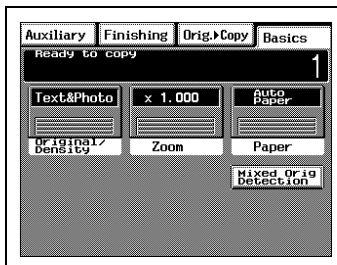

4 Touch [Density].

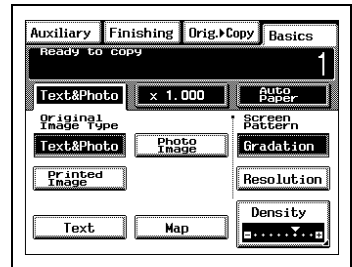

5 Specify the desired Density settings, and then touch [Enter].

- If Background is set to “Auto”, the density of the copy is automatically adjusted to the density of the document.

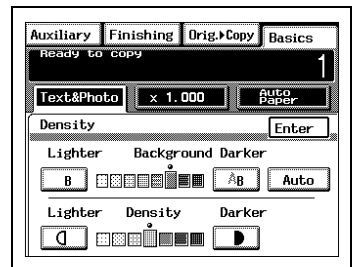

6 Specify any other necessary settings.

- Paper (Refer to page 5-4 for more details.)
- Zoom (Refer to page 5-14 for more details.)
- Original Image Type (Refer to page 5-18 for more details.)

7 Using the keypad, enter the number of copies you wish to make, and then press the [Start] key.

5.8 Interrupting a Copy Job

A long continuous copy operation or print job from the computer can be quickly paused in order to copy a different document.



Note

Some functions cannot be interrupted. In addition, some settings may not be available while a copy job is interrupted. For more details, refer to the "Function Combination Table" on page 11-10.

To interrupt a copy job

- 1 Press the [Interrupt] key.

The indicator on the [Interrupt] key lights up and the copy operation is paused.



- 2 Remove the document for the interrupted copy job, and then load the other document that you wish to copy.

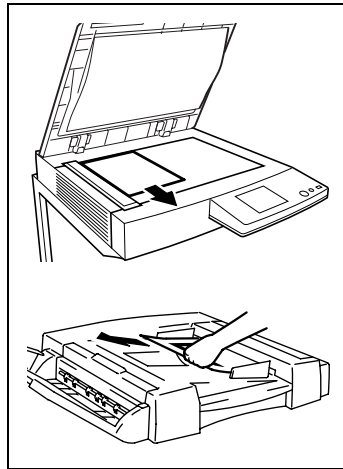

- 3 Specify any necessary settings.

? *Do you know what settings are selected when the [Interrupt] key is pressed?*

→ When the [Interrupt] key is pressed, all functions and settings are reset to their defaults.

- 4 Using the keypad, enter the number of copies you wish to make, and then press the [Start] key to copy the other document.

- 5 After the other document is copied, press the [Interrupt] key.
The indicator on the [Interrupt] key goes off.
- 6 Reposition the document for the interrupted copy job that was removed in step 2.
- 7 Press the [Start] key.
The interrupted copy job continues.

6 Advanced Operations

6.1 Making Single-Sided/Double-Sided Copies

The setting combinations of the various document and copy types and the procedure for selecting the appropriate settings is described below. Touching [Orig. ▶ Copy] displays a screen that allows you to specify the type of the original document and the type of copy you wish to make.

Single-Sided ▶ Single-Sided:

- This setting makes a single-sided copy from a single-sided document.

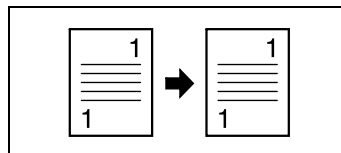

Single-Sided ▶ Double-Sided:

Important)

- ✓ This setting is only available if both the duplex unit (AD-35) and the memory (128MB × 2) are installed.
- This setting makes a double-sided copy from two single-sided documents

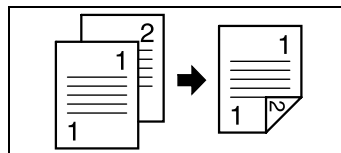

Single-Sided ▶ Single-2in1:

Important)

- ✓ This setting is only available if both the duplexing document feeder (RADF-11) and the memory (128MB × 2) are installed.
- This setting makes a single-sided copy of two pages side-by-side from two single-sided documents.

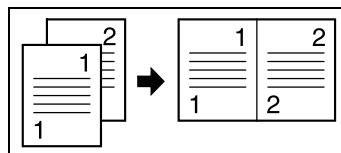

Single-Sided ► Double-2in1:

Important)

- ✓ This setting is only available if the duplex unit (AD-35), the duplexing document feeder (RADF-11) and the memory (128MB × 2) are all installed.
- This setting makes a double-sided copy of two pages side-by-side from four single-sided documents.

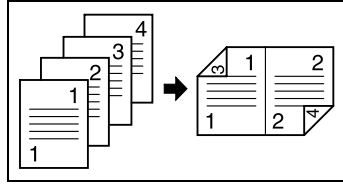
**Double-Sided ► Single-Sided:**

Important)

- ✓ This setting is only available if the duplexing document feeder (RADF-11) is installed.
- This setting makes two single-sided copies from a double-sided document.

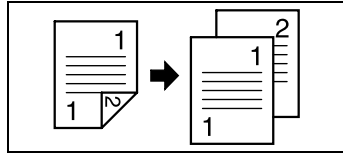
**Double-Sided ► Double-Sided:**

Important)

- ✓ This setting is only available if the duplex unit (AD-35), the duplexing document feeder (RADF-11) and the memory (128MB × 2) are all installed.
- This setting makes a double-sided copy from a double-sided document.

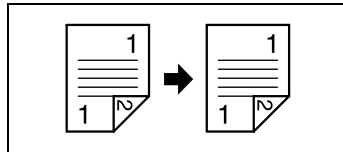
**Book (Separation) ► Single-Sided:**

- This setting makes a single-sided copy of each of the two pages of an open book.

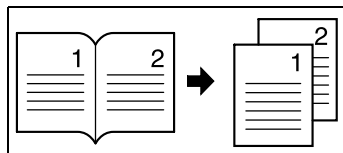

Book (Spread) ► Single-Sided:

- This setting makes a single-sided copy of two pages side-by-side from the two pages of an open book.

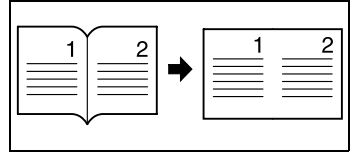
**Book (either Standard Book or RightBound) ► Book Erase:**

- This setting erases the area around the text (frame erase) or the binding of the book (center erase) so that it does not appear in the copy.

To make settings for single- or double-sided documents and copies

- 1 Position the document(s) to be copied. (Refer to page 4-1 for more details.)
- 2 Select the desired color mode. (Refer to page 2-20 for more details.)
- 3 Touch [Orig. ► Copy].

The Orig. ► Copy screen appears.

- 4 Select the type of document that is to be copied and the desired type of copy.

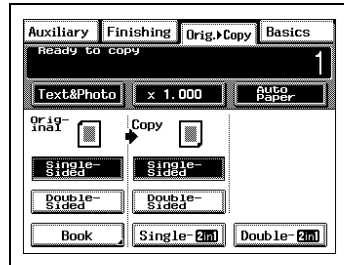

- If the recommended memory (128MB x 2) is not installed, the screen shown at the right appears. Select the type of document that is to be copied.

? *When is [Compress Mode] touched?*

- If [Compress Mode] is touched, [Color] (image quality priority) is set as the default. If the memory is not installed, touch [Compress] to prevent errors. (Refer to page 9-45.) Since copy quality will decrease when Compress Mode is changed, the setting should normally not be changed.

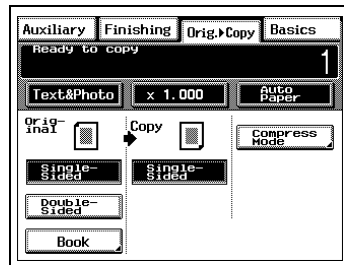

- 5 Specify any other necessary settings.
- 6 Using the keypad, enter the number of copies you wish to make, and then press the [Start] key.

To make settings for copying a book

- 1 Position the document(s) to be copied. (Refer to page 4-1 for more details.)
- 2 Select the desired color mode. (Refer to page 2-20 for more details.)
- 3 Touch [Orig. ► Copy].

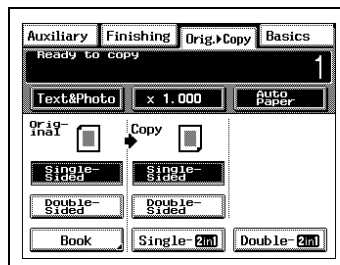

- 4 Touch [Book].

The Book screen appears.

? *Is the "Book" setting not available?*

If the "Frame Erase" or "Mirror Image" functions are selected, the "Book" setting cannot be selected.

- Cancel the "Frame Erase" and "Mirror Image" functions before selecting the "Book" setting.

- 5 Select the type of document that is to be copied and the desired type of copy.

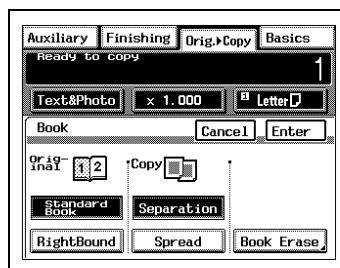



- 6 To erase the area around the text (frame erase) or the binding of the book (center erase) so that it does not appear in the copy, touch [Book Erase].

The Book Erase screen appears.

? *Is frame erasing and center erasing unnecessary?*

- If frame erasing and center erasing are unnecessary, skip to step 12.

- 7 On the left side of the screen, select the pattern of the area that you wish to be erased.

- To erase an area all along the outer edge of the book, touch  (frame erase).
- To erase an area just along the center binding of the book, touch  (center erase).
- To erase an area both along the outer edge and along the center binding of the book, touch  (frame and center erase).

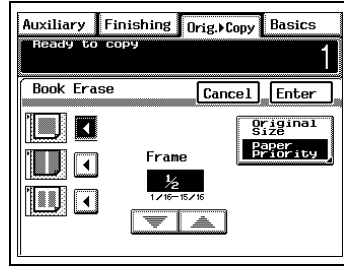

- 8 Touch  and  to specify the width that is to be erased.

- The width of the frame that is erased can be set between 1/16 and 15/16 in. (in units of 1/16 in.). The default setting is "1/2".
- The specified width of the area to be erased is the width before copying. Therefore, be careful when selecting this setting while making enlarged or reduced copies.

Example) When using an erase setting while copying an A3-size document with a zoom ratio of "x 0.500"

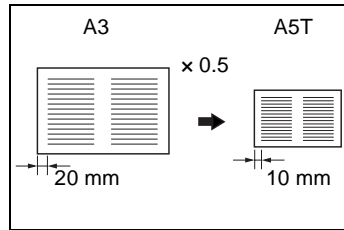



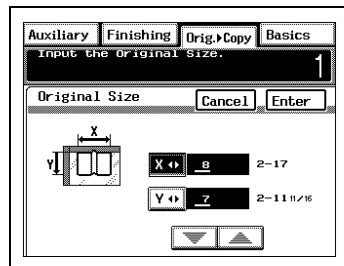

- 9 Normally, the document size is automatically detected. However, when copying a document of a non-standard size, touch [Original Size].

? *Is it unnecessary to specify the size of the document?*

- If the size of the document is not to be specified, skip to step 12.



- 10 In the Original Size screen, touch , , , and  to specify the desired size, and then touch [Enter].

The Book Erase screen reappears.

11 In the Book Erase screen, touch [Enter].

? *Has the document size already been specified using a setting on another screen?*

- Even if the document size has already been specified using a setting on another screen, the size set here determines the document size setting.

12 In the Book screen, touch [Enter].

13 Specify any other necessary settings.

14 Using the keypad, enter the number of copies you wish to make, and then press the [Start] key.

6.2 Finishing (“Sort” and “Group” settings)

When copying or printing two or more copies of the document, the copies can be divided either by sets containing a copy of each page (sorted) or by pages (grouped).

For more details on the paper sizes and types that can be used with these finishing settings, refer to page 11-5, page 11-6, and page 11-7.

Non-Sort:

- The copies are stacked on top of each other as they are made.

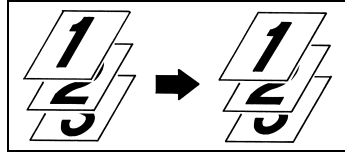

Sort:

Important)

- ✓ When used as a copier, the 10-mailbin sorter (AS-M4110) must be installed.
- The copies are automatically divided into sets with each set containing a copy of each page.

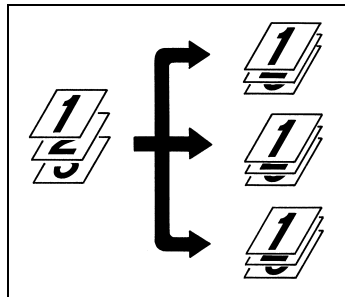

Group:

Important)

- ✓ When used as a copier, the 10-mailbin sorter (AS-M4110) must be installed.
- The copies are automatically divided into stacks containing copies of the same page.

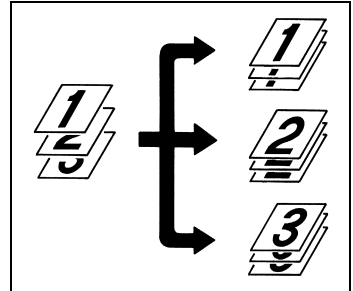
**Note**

The orientation in which the copies are fed out depends on the selected settings.

Sorting/Grouping



Note

How pages are fed depends on whether the following options are installed and on whether the pages are being copied or printed.

- 10-Mailbin sorter (AS-M4110) and a printer controller
- Finisher (F-8430 or F-8110) and a printer controller

Setting	Options Installed	Operation
Non-Sort	10-Mailbin Sorter (AS-M4110)	For a copy job or for a print job* where a mailbin is not specified, the output is fed into mailbin 1. When the bin reaches its maximum capacity, the output is fed into the next mailbin. For a print job where a mailbin is specified, the output is fed into the specified mailbin.
	Finisher (F-8430 or F-8110) and a printer controller	For a copy job, the output is fed into the upper paper output tray. For a print job*, the output is fed into the lower paper output tray. While printing, printouts of paper sizes and types not compatible with the lower paper output tray are fed into the upper paper output tray. For more details, refer to page 11-6 and page 11-7 of "11 Appendix".
Sort	10-Mailbin Sorter (AS-M4110)	For a copy job, the output is fed into mailbin 1. The number of mailbins that can be used to receive the output can be set between a maximum of 10 and a minimum of 2, according to the "Mail Bin Assignment" parameter setting. For more details, refer to the section "To set the "Mail Bin Assignment" parameter" on page 7-14. For a print job* where a mailbin is not specified, the output is sorted and fed into mailbin 1. For a print job* where a mailbin is specified, the output is sorted and fed into the specified mailbin.
	Finisher (F-8110 or F-8430) and a printer controller	For a print job*, the printed sets of pages are sorted and fed out into the lower paper output tray shifted to opposite sides so that they are separated from each other.
	None	For a print job*, the printouts are sorted and fed out into the normal copy output tray.

Setting	Options Installed	Operation
Group	10-Mailbin Sorter (AS-M4110)	For a copy job, the output is fed into mailbin 1. The number of mailbins that can be used to receive the output can be set between a maximum of 10 and a minimum of 2, according to the "Mail Bin Assignment" parameter setting. For more details, refer to the section "To set the "Mail Bin Assignment" parameter" on page 7-14.

* A print job is a print command sent from a computer to the optional printer controller, then printed by this machine.

To select the finishing settings

- 1 Position the document(s) to be copied. (Refer to page 4-1 for more details.)
- 2 Select the desired color mode. (Refer to page 2-20 for more details.)
- 3 Touch [Finishing].
- 4 Select the desired finishing settings. The screen shown at the right appears when the 10-mailbin sorter (AS-M4110) is installed. If the finisher is installed, [Sort] and [Group] do not appear.

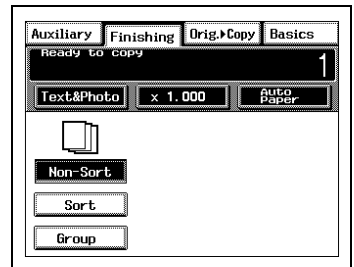

- 5 Specify any other necessary settings.
- 6 Using the keypad, enter the number of copies you wish to make, and then press the [Start] key.

6.3 Staple Binding

If an optional finisher (F-8110 or F-8430) and a printer controller are installed, grouped or sorted printouts from a computer can be stapled together. The type of stapling depends on the model of the finisher installed.



Note

If finisher F-8110 is installed, the pages can only be stapled in the corner.

Types of stapling

The pages are bound either with one staple in the corner (parallel or diagonally) or with two staples.

Whether the staple in the corner is positioned parallel or diagonally depends on the orientation of the print image and the feeding direction of the paper.

- **Corner stapling (Parallel):**
The printed pages are bound with one staple parallel to the edge of the paper.
- **Corner stapling (Diagonal):**
The printed pages are bound with one staple diagonally in the corner of the pages.
- **2-Point stapling (only with finisher F-8430 installed):**
The printed pages, positioned according to the specified paper orientation, are bound with two staples at the center, parallel to the edge of the pages.

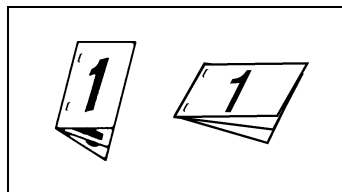
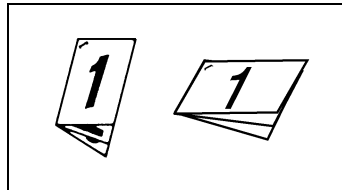
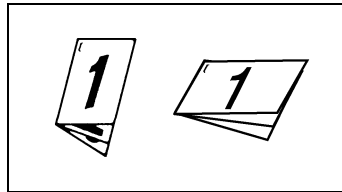

Staple position

The position of the staple differs according to the orientation of the print image and the feeding direction of the paper.

Corner stapling:

- Printed image: Portrait;
Paper orientation: Crosswise
Possible paper sizes: LetterC,
ExecutiveC
Possible paper types: Standard
paper (F-8110: 17 to 21-1/4 lbs., F-
8430: 17 to 24 lbs.)

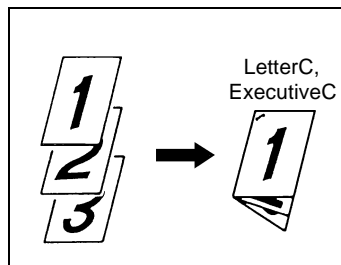

- Printed image: Landscape;
Paper orientation: Lengthwise
Possible paper sizes: LetterL,
LegalL, ExecutiveL, 11 x 14L, 11 x
17L
Possible paper types: Standard
paper (F-8430: 17 to 24 lbs., F-
8110: 17 to 21-1/4 lbs.)

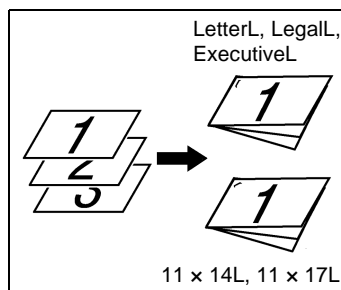

- Printed image: Portrait;
Paper orientation: Lengthwise
Possible paper sizes: LetterL,
LegalL, ExecutiveL, 11 x 14L, 11 x
17L
Possible paper types: Standard
paper (F-8430: 17 to 24 lbs.)
*Only with finisher F-8430 installed

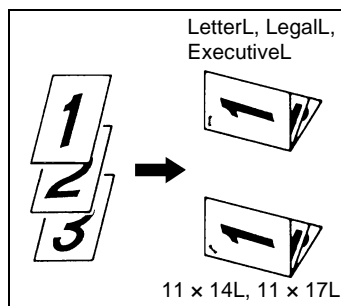

- Printed image: Landscape;
Paper orientation: Crosswise
Possible paper sizes: LetterC,
ExecutiveC
Possible paper types: Standard
paper (F-8430: 17 to 24 lbs.)
*Only with finisher F-8430 installed

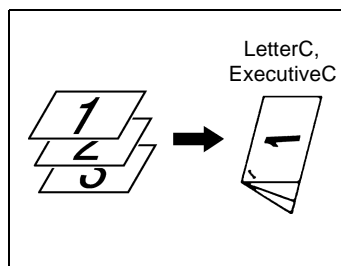

2-Point stapling (only with finisher F-8430 installed):

- Printed image: Portrait;
Paper orientation: Lengthwise,
Crosswise
Possible paper sizes: LetterC,
ExecutiveC, 11 × 14L, 11 × 17L
Possible paper types: Standard
paper (17 to 24 lbs.)

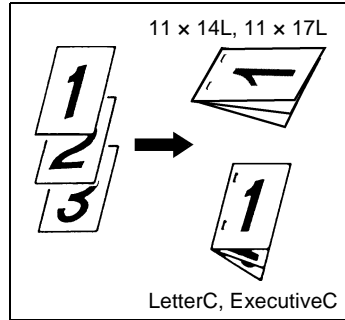

- Printed image: Landscape;
Paper orientation: Lengthwise,
Crosswise
Possible paper sizes: LetterC,
ExecutiveC, 11 × 14L, 11 × 17L
Possible paper types: Standard
paper (17 to 24 lbs.)

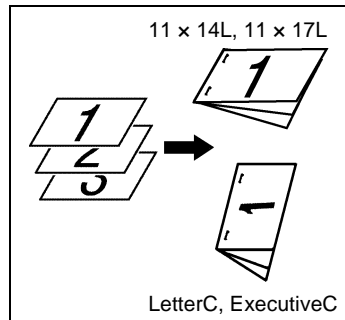

For more details on selecting the stapling settings, refer to the manual for the printer controller.

6.4 Hole Punching (“Hole-Punch” Setting)

If an optional finisher (F-8430) and a printer controller are installed, holes for filing the pages in binders can be punched in printouts sent from a computer.

Types of hole punching

The number of holes punched (either two or three) is automatically selected according to the paper size and the paper feed method.

- Number of holes punched: 2
Possible paper sizes: LetterL,
Legall
Possible paper types: Standard
paper (17 to 24 lbs.)
- Number of holes punched: 3
Possible paper sizes: LetterC,
11 × 17L
Possible paper types: Standard
paper (17 to 24 lbs.)

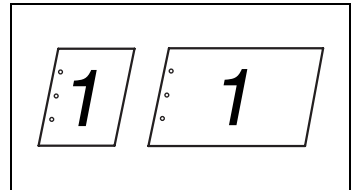
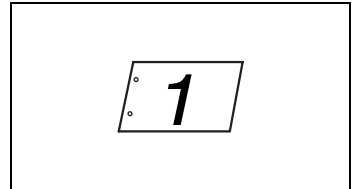

Punched hole position:

The position of the punched hole differs according to the printed image and paper orientation.

- Possible paper sizes: LetterL, LetterC, Legall, 11 × 17L

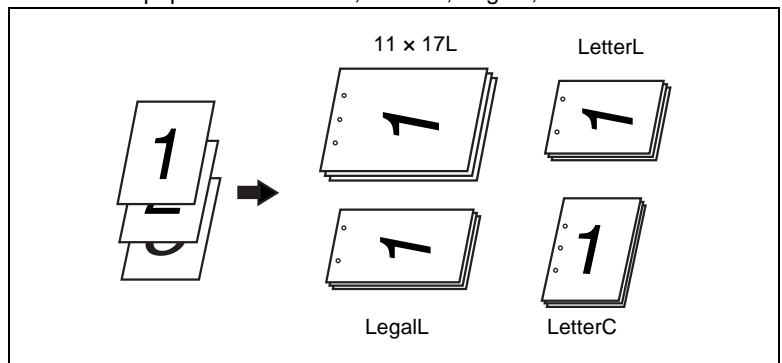

- Possible paper sizes: LetterL, LetterC, LegalL, 11 × 14L, 11 × 17L

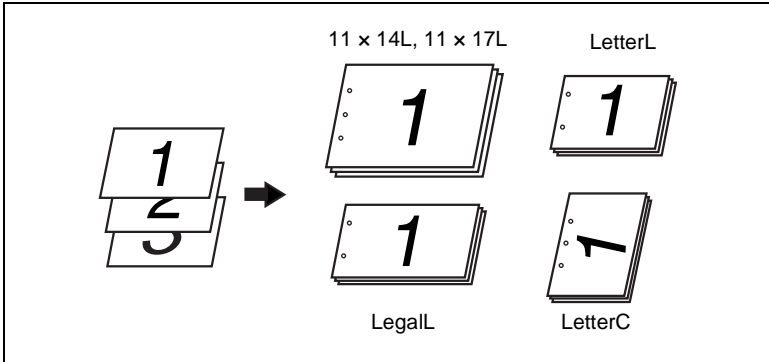

For more details on selecting the “Hole-Punch” setting, refer to the manual for the printer controller.

6.5 Feeding Documents of Different Sizes (“Mixed Orig Detection” Function)

If the duplexing document feeder is installed, a stack of documents of different sizes can be copied as a set.

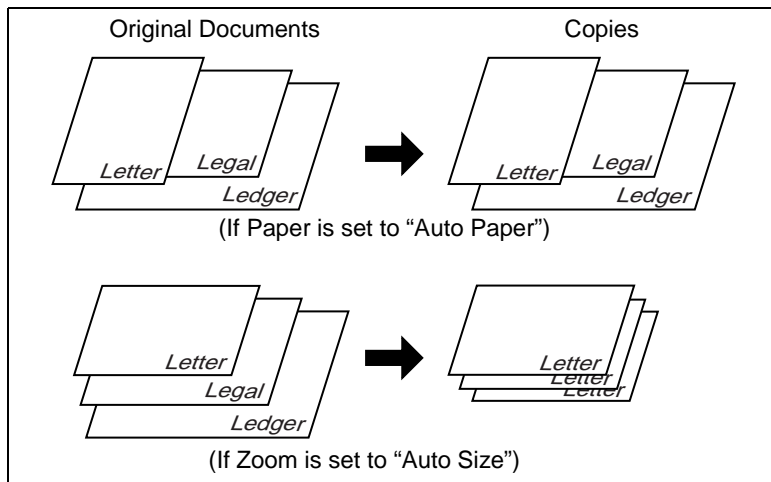

To set the “Mixed Orig Detection” function

A set of documents containing up to 50 sheets of various sizes can be copied at a time.

- 1 Load the documents into the document feed tray, with one side of the documents against the fixed document guide, and then slide the adjustable document guide to the other side of the documents.

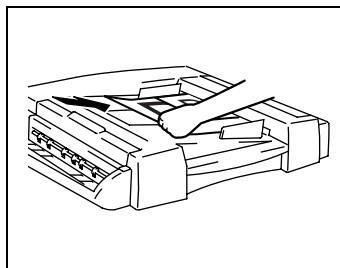

- 2 Select the desired color mode. (Refer to page 2-20 for more detail.)

3 Touch [Mixed Orig Detection].

The background of “Mixed Orig Detection” changes to black.

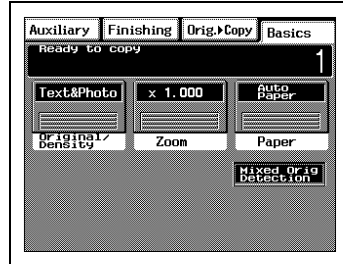

4 On the Basic screen, specify the desired Paper and Zoom settings.

? *Do you wish to copy the documents at their original sizes onto paper of the same sizes as the originals?*

→ Specify the “x 1.000” Zoom setting and the “Auto Paper” Paper setting.

? *Do you wish to copy documents of different sizes onto paper of one size?*

→ Select the “Auto Size” Zoom setting and specify the tray or drawer containing the paper size that you wish to use.

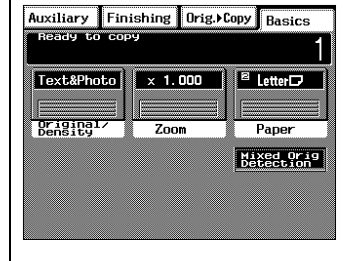
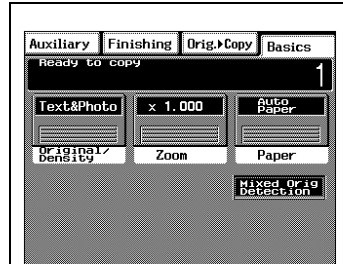

5 Specify any other necessary settings.

6 Using the keypad, enter the number of copies you wish to make, and then press the [Start] key.



6.6 Erasing Edges (“Frame Erase” Function)

Frames can be erased around copies that you make.

To set the “Frame Erase” function

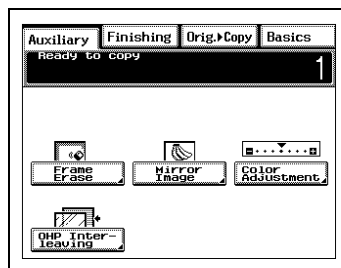
- 1 Position the document(s) to be copied. (Refer to page 4-1 for more detail.)
- 2 Select the desired color mode. (Refer to page 2-20 for more detail.)
- 3 Touch [Auxiliary].
The Auxiliary screen appears.
- 4 Touch [Frame Erase].



- 5 Touch  and  to specify the width that is to be erased.

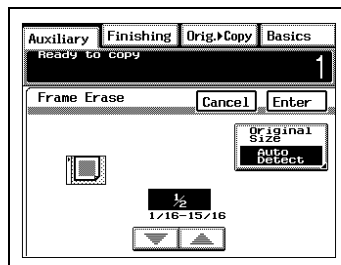



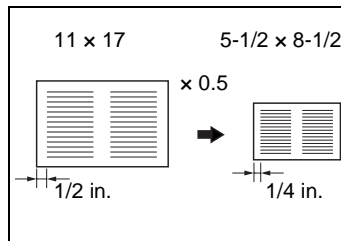

? *Is an enlarged or reduced copy being made?*

- The specified width of the area to be erased is the width before copying. Therefore, be careful when selecting this setting while making enlarged or reduced copies.

Example) When using the “Frame Erase” function while copying an 11 × 17-size document with a zoom ratio of “× 0.500”



- 6 Although the document size is automatically detected, do the following if you wish to specify the document size:
- Touch [Original Size] to display the Original Size screen, touch , , , and  to specify the desired size, and then touch [Enter].

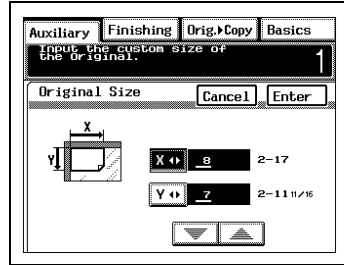

- 7 In the Frame Erase screen, touch [Enter].
- 8 Specify any other necessary settings.
- 9 Using the keypad, enter the number of copies you wish to make, and then press the [Start] key.

6.7 Creating Mirror Image Copy (“Mirror Image” Function)

With this function, a mirror image of the original document can be copied.



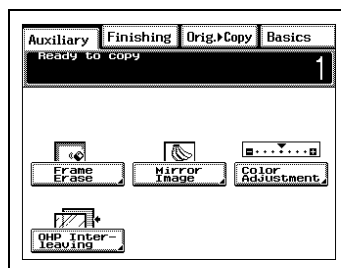

To set the “Mirror Image” function

- 1 Position the document(s) to be copied. (Refer to page 4-1 for more detail.)
- 2 Select the desired color mode. (Refer to page 2-20 for more detail.)
- 3 Touch [Auxiliary].
The Auxiliary screen appears.
- 4 Touch [Mirror Image].

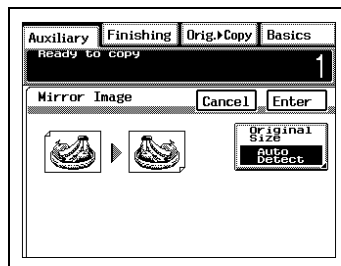

- 5 Although the document size is automatically detected, do the following if you wish to change the document size (otherwise, skip to step 8):
To specify the document size, touch [Original Size].



- 6 In the Original Size screen, touch , , , and  to specify the desired size, and then touch [Enter].

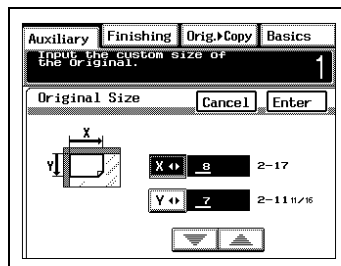

- 7 In the Mirror Image screen, touch [Enter].
- 8 Specify any other necessary settings.
- 9 Using the keypad, enter the number of copies you wish to make, and then press the [Start] key.

6.8 Improving Copy Quality (“Color Adjustment” Function)

By making various color adjustments, you can adjust the color of the copies as desired.

To make color adjustments

- 1 Position the document(s) to be copied. (Refer to page 4-1 for more detail.)
- 2 Select the desired color mode. (Refer to page 2-20 for more detail.)
- 3 Touch [Auxiliary].
The Auxiliary screen appears.
- 4 Touch [Color Adjustment].

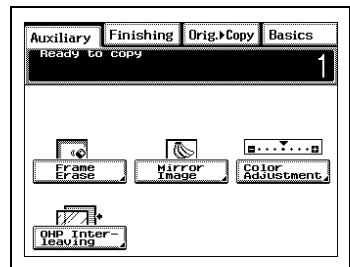

- 5 Touch the parameter that you wish to change.

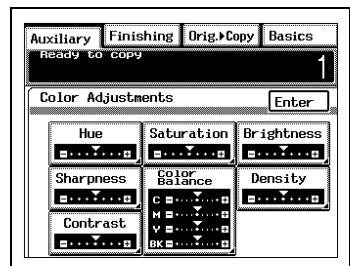

- 6 Touch the arrows to select the desired setting, and then touch [Enter].
(Ex: Hue adjustment)

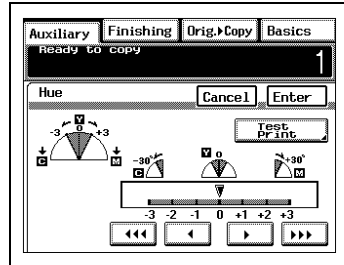

- 7 In the Color Adjustments screen, touch [Enter].
- 8 Specify any other necessary settings.
- 9 Press the [Start] key.

To make test prints

You can make test prints of your document to see how it would appear at each of the settings for the current parameter combined with the other currently specified color adjustment settings. Follow the procedure below to make a test print.

- 1 Touch [Test Print].

The Test Print screen appears.

- 2 Position the part of the document that you wish to make a test print of within the test area of the original glass.

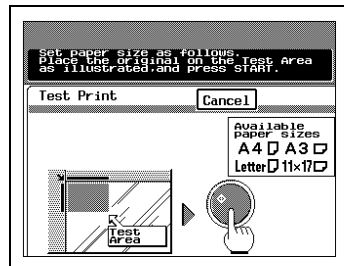

- 3 Press the [Start] key to copy the document at seven levels (-3, -2, -1, 0, +1, +2 and +3) of the current color adjustment parameter.
The paper for the test print is automatically selected in the following order: A4C, LetterC, A3L, 11 x17L.
- 4 While referring to the test prints, touch the arrows to select the desired setting for the current parameter, and then touch [Enter].
- 5 Correctly position the document for normal printing.

To adjust the hue

The hue is divided into magenta, yellow and cyan. By adjusting the hue, the image can be made either more reddish or more bluish.

- 1 In the Color Adjustments screen, touch [Hue].

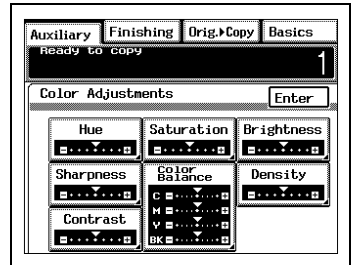

- 2 Touch the arrows to select the desired setting, and then touch [Enter].

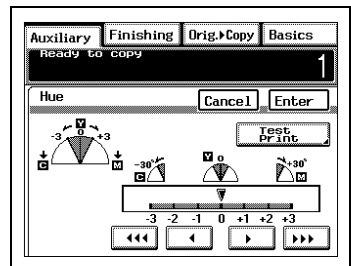

To adjust the saturation

This parameter can be used to adjust the vividness of the colors.

- 1 In the Color Adjustments screen, touch [Saturation].

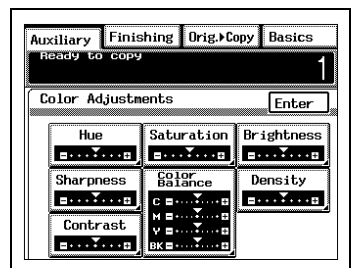

- 2 Touch the arrows to select the desired setting, and then touch [Enter].

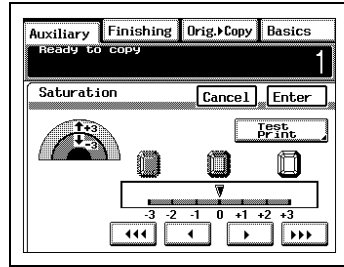

To adjust the brightness

This parameter can be used to adjust the brightness of the image.

- 1 In the Color Adjustments screen, touch [Brightness].

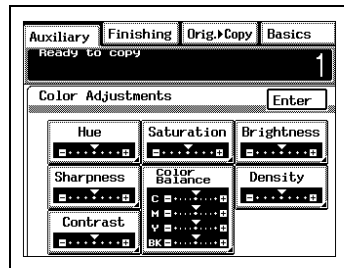

- 2 Touch the arrows to select the desired setting, and then touch [Enter].

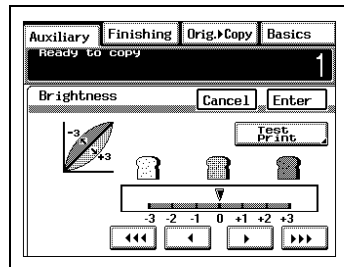

To adjust the sharpness

This parameter can be used to make an overly sharp image softer or a blurry image clearer.

- 1 In the Color Adjustments screen, touch [Sharpness].

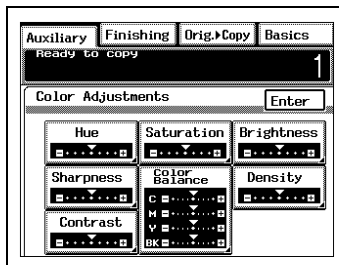

- 2 Touch the arrows to select the desired setting, and then touch [Enter].

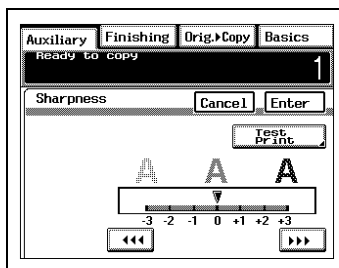

To adjust the contrast

This parameter can be used to make an image either lighter or darker.

- 1 In the Color Adjustments screen, touch [Contrast].

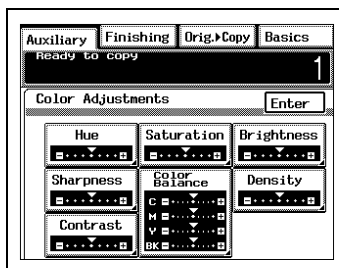

- 2 Touch the arrows to select the desired setting, and then touch [Enter].

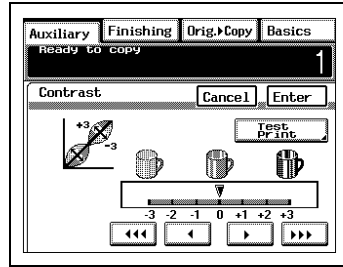



To adjust the color balance

Change the color balance of the image by adjusting the concentration of each color (cyan, magenta, yellow and black).

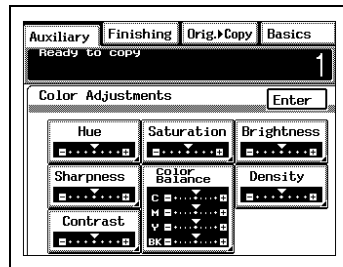
- 1 In the Color Adjustments screen, touch [Color Balance].



- 2 Select the color that you wish to adjust, touch  and  to specify the desired setting, and then touch [Enter].

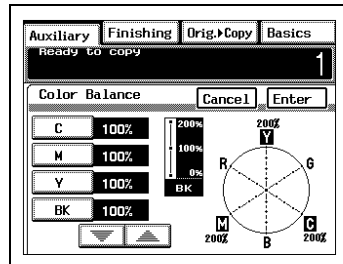

To adjust the density

This parameter can be used to make an image either more rich or more pale.

- 1 In the Color Adjustments screen, touch [Density].

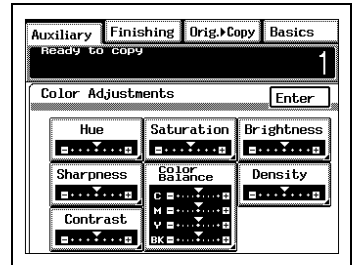

- 2 Touch the arrows to select the desired setting, and then touch [Enter].

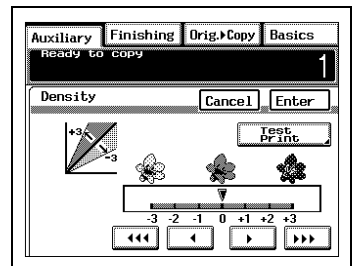

6.9 Inserting Pages Between Copies of Overhead Transparencies (“OHP Interleaving” Function)

After each overhead transparency is copied, a page from a different paper source can be added to the stack of transparencies as an overleaf. In order to use this function, the overhead transparencies should be loaded into the multipurpose paper drawer (1st drawer).



Note

We recommend that interleaf paper (inserted paper) with the same size as the overhead transparencies first be loaded into any drawer other than the multipurpose paper drawer (1st drawer) with the same orientation as the overhead transparencies.

To set the “OHP Interleaving” function

- 1 Position the document(s) to be copied. (Refer to page 4-1 for more detail.)
- 2 Load the overhead transparencies into the 1st drawer, and then set the media type selection dial on the drawer to “OHP”.
- 3 Select the desired color mode. (Refer to page 2-20 for more detail.)
- 4 Touch [Auxiliary].
The Auxiliary screen appears.
- 5 Touch [OHP Interleaving].

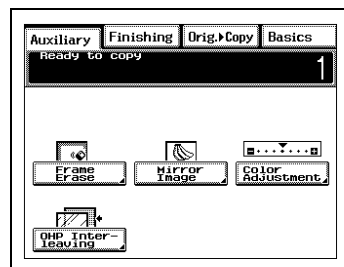

- 6 Select the drawer loaded with the interleaves, and then touch [Enter].

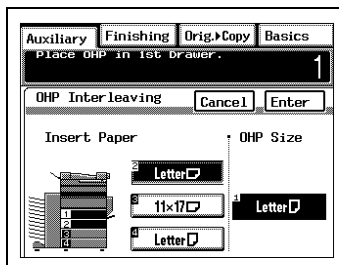

- 7 Specify any other necessary settings.
- 8 Press the [Start] key.

6.10 Specifying Different Vertical and Horizontal Scaling Proportions (“X/Y Zoom” Function)

Copies can be made by specifying different scaling proportions for the vertical and the horizontal directions of the document. The zoom ratio can be between $\times 0.500$ and $\times 4.000$ (in 0.001 increments).

To specify the vertical and horizontal scaling proportions

- 1 Position the document(s) to be copied. (Refer to page 4-1 for more details.)
- 2 Select the desired color mode. (Refer to page 2-20 for more details.)
- 3 Touch [Auxiliary].
The Auxiliary screen appears.
- 4 Touch [X/Y Zoom].

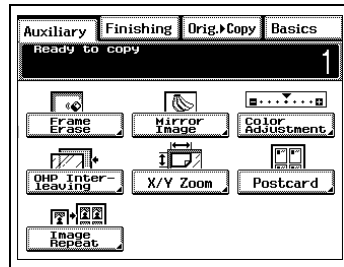

- 5 Touch [X] or [Y], and use the keypad to enter the desired zoom ratio, and then touch [Enter].

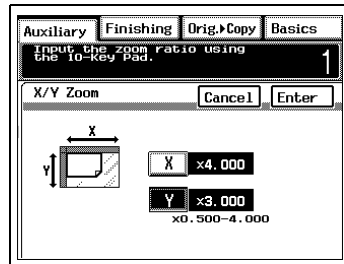

- 6 Specify any other necessary settings.
- 7 Using the keypad, enter the number of copies you wish to make, and then press the [Start] key.

6.11 Reducing the Document to Postcard Size and Printing Multiple Copies on One Page (“Postcard” Function)

The document can be reduced to the size of a postcard, and up to four copies can be printed on one sheet of Letter-size postcard paper.

Document sizes that can be selected

- Preset sizes
5 1/2 × 8 1/2 in., 3 × 5L in., 4 × 6L in., 2 1/4 × 3 1/4L in., A5L, A6L, B5L, B6L
- Custom sizes
X: 2 to 9 7/8 in.
Y: 2 to 8 1/4 in.

To set the “Postcard” function

- 1 Position the document(s) to be copied. (Refer to page 4-1 for more details.)
- 2 Select the desired color mode. (Refer to page 2-20 for more details.)
- 3 Touch [Auxiliary].
The Auxiliary screen appears.
- 4 Touch [Postcard].

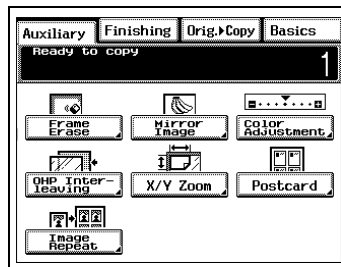

- 5 Touch [Original Size].

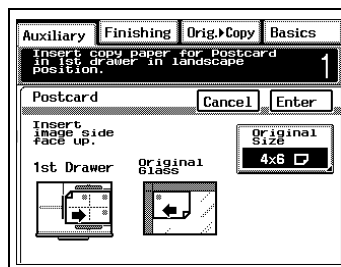

- 6 Select the document size, and then touch [Enter].

- For metric document sizes, touch [Metric] to display a screen containing metric paper size settings.

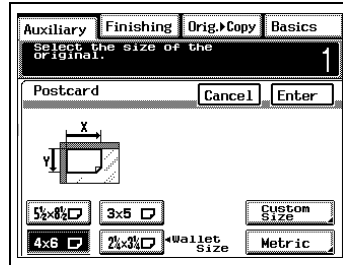

- For a paper size other than the standard sizes listed on the screen, touch [Custom Size]. Touch [X], [Y], [Down Arrow], and [Up Arrow] to specify the size of the original, and then touch [Enter].

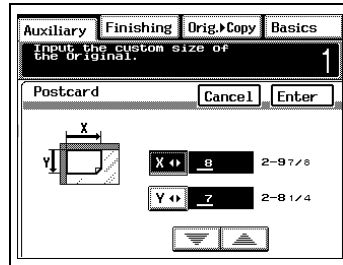

- 7 Load Letter-size postcard paper lengthwise into the multipurpose paper drawer (1st drawer) with the front side of the paper facing up.

- Set the media type selection dial to "Thick1".
- After specifying the settings, touch [Enter].
- If the document is positioned as shown on the screen, it will be copied onto the paper as shown on the screen.

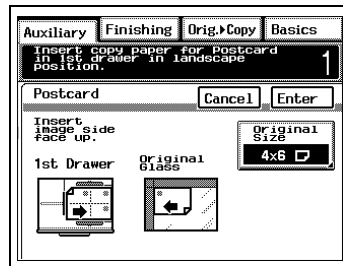

- 8 Using the keypad, enter the number of copies you wish to make, and then press the [Start] key.



Note

To purchase postcard paper, contact the sales representative for this copier.

6.12 Tiling Copies (“Image Repeat” Function)

Multiple copies of the original can be printed at the desired zoom ratio to fill the page. The zoom ratio can be set between $\times 0.500$ and $\times 4.000$ (in 0.001 increments). In addition, the number of times the original is to be printed can be set between 1 and 100.

To set the “Image Repeat” function

- 1 Position the document(s) to be copied. (Refer to page 4-1 for more details.)
- 2 Select the desired color mode. (Refer to page 2-20 for more details.)
- 3 Touch [Auxiliary].
The Auxiliary screen appears.
- 4 Touch [Image Repeat].

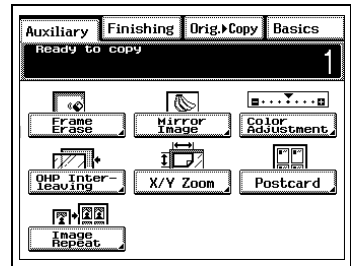

- 5 Make sure that [Zoom] is selected, and then use the keypad to enter the desired zoom ratio.

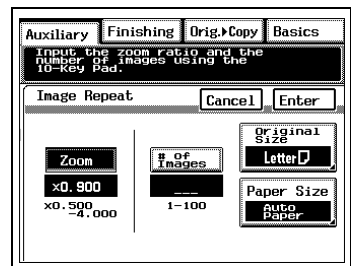

- 6 Touch [# of Images], and then use the keypad to enter the desired number of times that you wish to print the original.

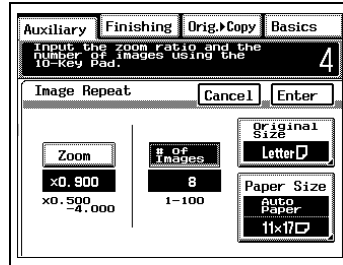

- 7 Touch [Original Size], select the document size, and then touch [Enter].

- For metric document sizes, touch [Metric] to display a screen containing metric paper size settings.

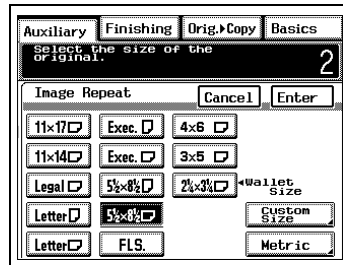

- For a paper size other than the standard sizes listed on the screen, touch [Custom Size]. Touch [X <>], [Y <>], [▼], and [▲] to specify the size of the original, and then touch [Enter].

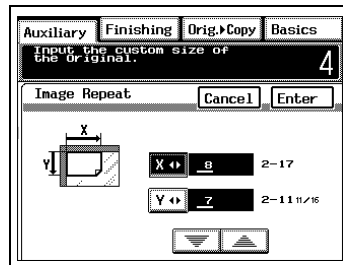

- 8 The appropriate size of loaded paper for the set zoom ratio, number of copies, and document size is selected. Check the selected paper size, and then touch [Enter].

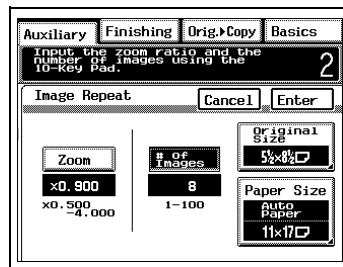

- To manually select the paper source, touch [Paper Size]. Select the tray or drawer containing the paper that you wish to use, and then touch [Enter].

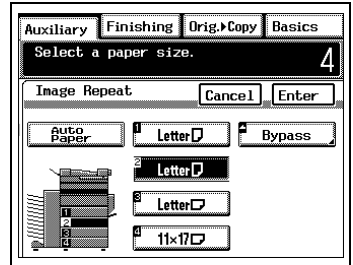

- 9 Press the [Start] key.

7 Utility Mode Operations

7.1 Resetting the Copier (“Default Settings” Function)

This function allows you to specify which settings would to be used as the default settings when the copier is reset by turning it on or pressing the [Panel Reset] key. The default setting is “Factory Settings”.

To specify the default settings

- 1 Press the [Utility] key to enter Utility mode.

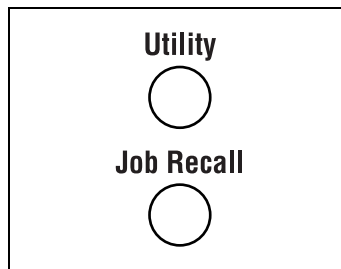

- 2 Touch [Default Settings].

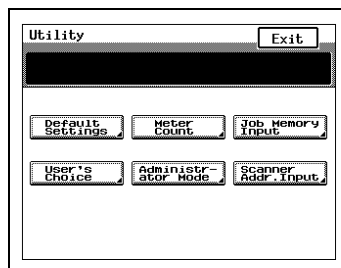

- 3 Select the desired setting, and then touch [Enter].

? *Do you wish to record the current settings as the default settings?*

- Touch [Current Settings].

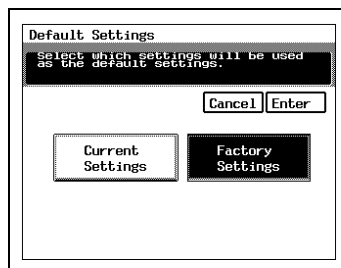

- 4 In the Utility screen, touch [Exit].

7.2 Viewing Counters (“Meter Count” Function)

The meters count the total number of copies that have been made since the copier was installed.

Meter counts that can be viewed:

- Full Color:
Number of copies or printouts made using the “Full Color” color mode
- Black:
Number of copies or printouts made using the “Black” color mode
- Copy:
Number of copies made
- Print:
Number of pages printed from the computer through the printer controller
- Large:
Number of copies/printouts made on paper registered as large-size paper
- Duplex Copy:
Number of double-sided copies made using the duplex unit
- Duplex Print:
Number of double-sided computer printouts made using the duplex unit
- G. Total (C+P):
Total number of all pages copied or printed

To view the meter counts

- 1 Press the [Utility] key to enter Utility mode.

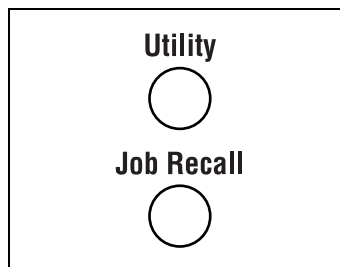

- 2 Touch [Meter Count].

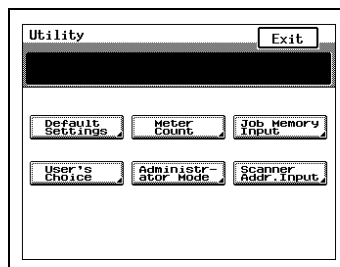

- 3 The number of copies and printouts made using the "Full Color" and "Black" color modes and the number of double-sided copies and printouts printed are displayed.

? *Do you wish to print out the meter counts?*

- As described by the instructions that are displayed, load paper (Letter) into the first paper drawer, and then press the [Start] key.

	Full Color	Black	Duplex Copy
Copy	200	50	0
Large	0	0	
Print	0	0	Duplex Print
Large	0	0	0
6. Total (C+P)		250	

- 4 When you are finished viewing the meter counts, touch [Exit].

7.3 Storing and Recalling Jobs (“Job Memory Input” Function)

Store up to 10 frequently used copy jobs, which can be recalled for immediate use at any time they are needed.

To store a job

- 1 First, specify the copy settings that you will store as a job.
- 2 Press the [Utility] key to enter Utility mode.

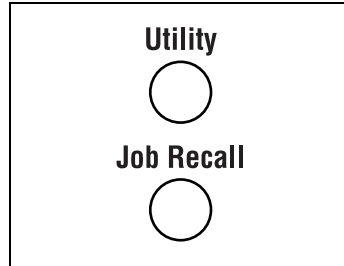

- 3 Touch [Job Memory Input].

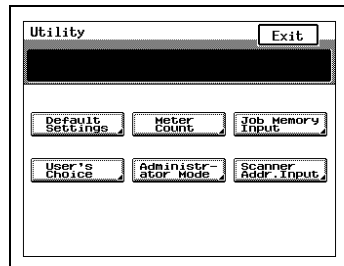

- 4 Touch [Input], and then touch the number where you wish to store the job.

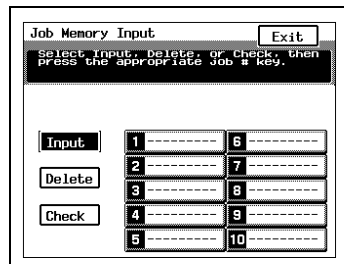

- 5 Touch the letters and numbers to enter a name for the copy job, and then touch [Enter].

? Do you wish to correct the job name?

- Touch [Del.] to delete the last character typed. Continue touching [Del.] until the character you wish to change is deleted, and then type the correct name for the job.

- 6 Check that the name for the selected job is typed correctly, and then touch [Exit].

To delete a job

- 1 Press the [Utility] key to enter Utility mode.

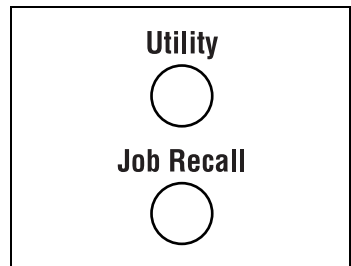

- 2 Touch [Job Memory Input].

- 3 Touch [Delete], and then touch the number of the job that you wish to delete.

? *Do you wish to check the specified settings for a job?*

- Touch [Check], and then touch a job number to view that job's settings.

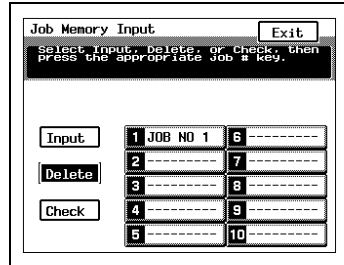

- 4 After the entered job name is erased to indicate that the job was deleted, touch [Exit].

To recall a stored job

- 1 Press the [Copy] key to enter Copy mode.
2 Press the [Job Recall] key.

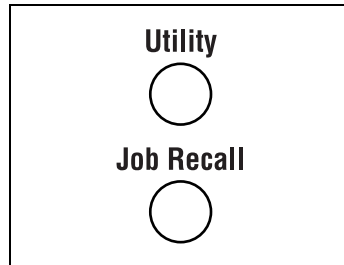

- 3 Touch the number of the job that you wish to recall.

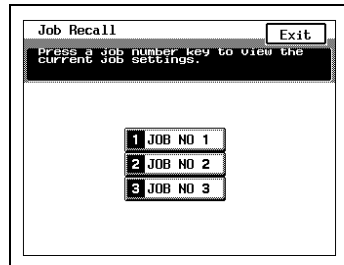

- 4 Check that the job settings that appear are the ones that you wish to use, and then touch [Exit].

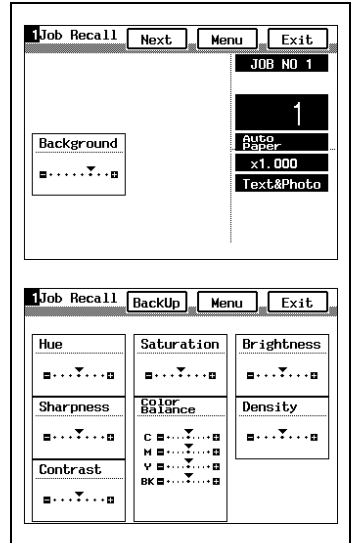

? Do you wish to select a different job instead?

→ Touch [Next].

- 5 Position the document(s) to be copied.

? Do you need more information on feeding the document?

→ Refer to "4 Original Documents" on page 4-1 for more details.

- 6 Press the [Start] key.

7.4 Specifying Default Settings (“User’s Choice” Function)

With the “User’s Choice” function, the default settings can be customized according to how the copier is to be used. Selecting the desired default settings with the “User’s Choice” function eliminates the need to re-select certain settings each time the copier is turned on or the [Panel Reset] key is pressed.

To change the User’s Choice settings

- 1 Press the [Utility] key to enter Utility mode.

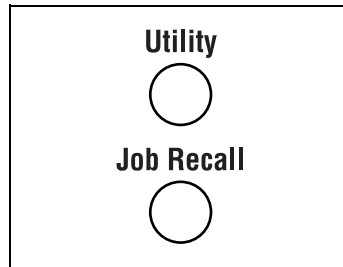

- 2 Touch [User’s Choice].

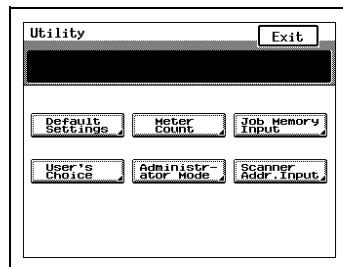

- 3 Touch the parameter that you wish to change

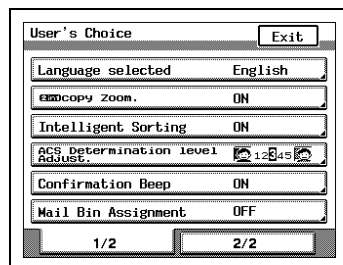

- Touch [2/2] to view the next page.

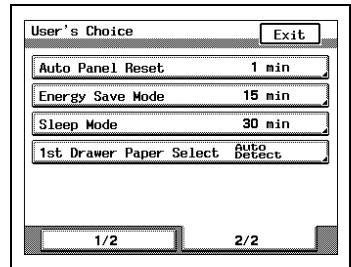

- 4 After specifying the desired setting, touch [Exit] in the User's Choice screen.

The Utility screen appears.

- 5 In the Utility screen, touch [Exit].

To set the "Language selected" parameter

This parameter can be used to change the language of the touch panel. The default setting is "English".

- 1 In the User's Choice screen, touch [Language selected].

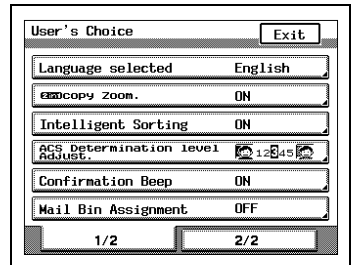

- 2 Select the desired language, and then touch [Enter].

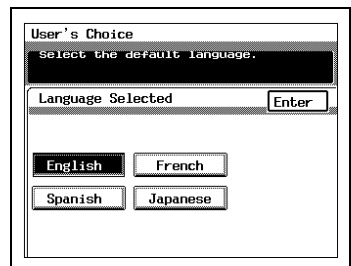

- 3 In the User's Choice screen, touch [Exit].

To set the “2in1copy zoom” parameter

This parameter can be used to select whether or not the default zoom is specified when 2in1 copying is selected. This parameter can be used to select whether or not the recommended zoom ratio (“x 0.647” for a letter-size page) is selected when a 2in1 copy mode is chosen. The default setting is “ON”.

- 1 In the User’s Choice screen, touch [2in1copy zoom].

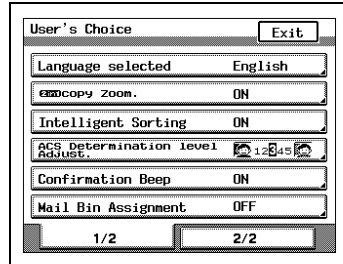

- 2 Select whether the recommended zoom ratio will be used (“ON”) or not (“OFF”), and then touch [Enter].

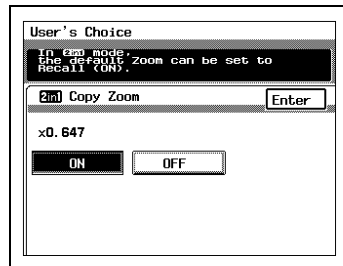

- 3 In the User’s Choice screen, touch [Exit].

To set the “Intelligent Sorting” parameter

By setting this parameter to “ON”, the “Non-Sort” setting will automatically be selected if a document consisting of only one page is placed in the automatic document feeder, and the “Sort” setting will automatically be selected if a document consisting of two or more pages is placed in the automatic document feeder and the number of copies is set to 2 or more. The default setting is “ON”.

Important)

- ✓ The “Sort” setting is only available if the optional 10-mailbin sorter (AS-M4110) is installed.

- 1 In the User’s Choice screen, touch [Intelligent Sorting].

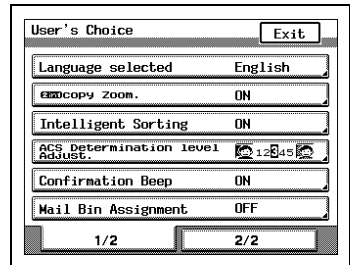

- 2 Select whether intelligent sorting will be used (“ON”) or not (“OFF”), and then touch [Enter].

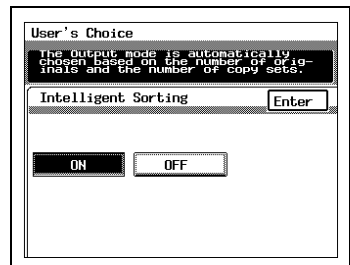

- 3 In the User’s Choice screen, touch [Exit].

To set the “ACS Determination level Adjust.” parameter

This parameter can be used to adjust the level for the “Auto Color” color mode to detect whether a document will be copied in color or in black and white. Adjusting this setting more towards “Black” makes it easier for a black-and-white document to be detected, as opposed to when the standard setting is selected. The default setting is “3 (Std.)”.

- 1 In the User's Choice screen, touch [ACS Determination level Adjust.].

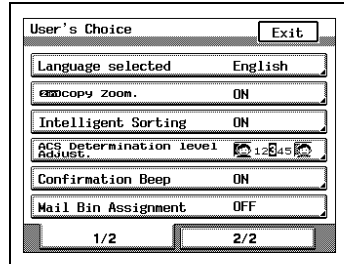

- 2 Touch [Black] or [Full Color] to specify the standard detection level, and then touch [Enter].

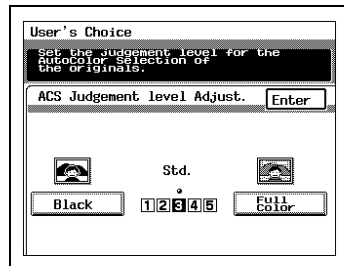

- 3 In the User's Choice screen, touch [Exit].

To set the “Confirmation Beep” parameter

This parameter specifies whether or not a confirmation beep is sounded each time a key in the operation panel is pressed. The default setting is “ON”.

- 1 In the User’s Choice screen, touch [Confirmation Beep].

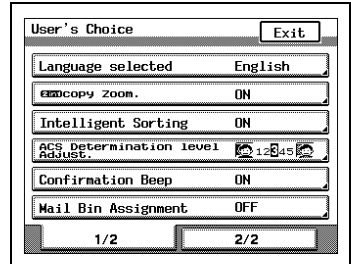

- 2 Select whether the confirmation beep is sounded (“ON”) or not (“OFF”), and then touch [Enter].

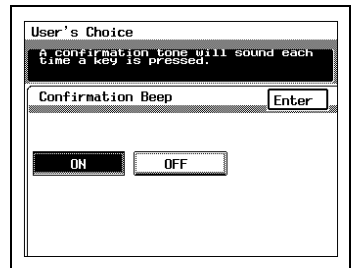

- 3 In the User’s Choice screen, touch [Exit].

To set the “Mail Bin Assignment” parameter

This parameter allows you to set whether or not mailbins are allocated to receive printouts from computers when the 10-mailbin sorter (AS-M4110) and the printer controller are installed on the copier. Bins 2 through 10 of the 10-mailbin sorter can be used to receive printouts. The default setting is “OFF”.

- 1 In the User’s Choice screen, touch [Mail Bin Assignment].

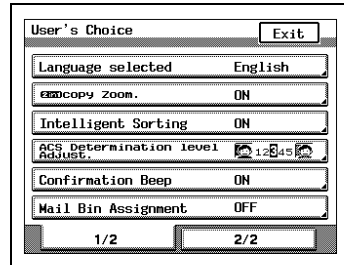

- 2 Using the keypad, enter the number for the bins, until bin 10, that will be used as mailbins, and then touch [Enter]. (The screen at the right shows that bins 5 through 10 have been specified as mailbins.)

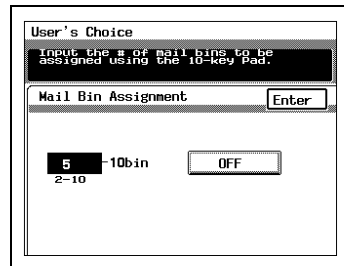

? Do you wish to change the bin number entered?

- Press the [C] (clear) key to erase the entered number, and then use the keypad to enter the correct bin number.

? When setting the bins to be used as mailbins, how many bins can be selected?

- Bins specified as mailbins cannot be used for sorting when making copies. For the example mentioned above, bins 1 through 4 can be used for sorting while making copies.

To set the “Auto Panel Reset” parameter

This parameter can be used to turn off (“OFF”) the panel reset, or to specify the length of time (between 1 and 9 minutes) after the last operation until the touch panel automatically returns to its default settings. The default setting is “1 min.”

- 1 In the User’s Choice screen, touch [Auto Panel Reset].

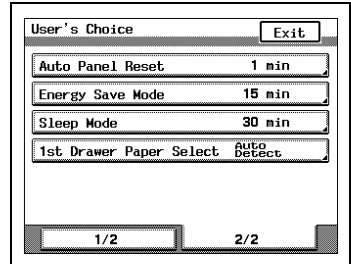

- 2 Using the keypad, enter the desired number of minutes, and then touch [Enter].

? *Do you wish to change the number of minutes entered?*

- Press the [C] (clear) key to erase the entered number, and then use the keypad to enter the correct number of minutes.

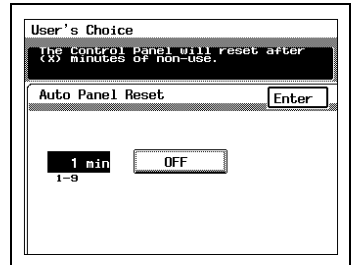

- 3 In the User’s Choice screen, touch [Exit].

To set the “Energy Save Mode” parameter

This parameter can be used to specify the length of time (between 1 and 240 minutes) after the last operation until the copier automatically enters Energy Saver mode. The default setting is “15 min.”

- 1 In the User's Choice screen, touch [Energy Save Mode].

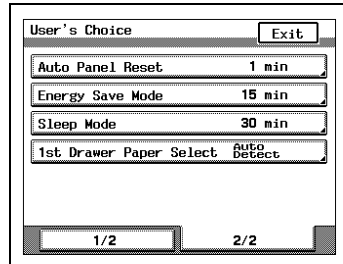

- 2 Using the keypad, enter the desired number of minutes, and then touch [Enter].

? *Do you wish to change the number of minutes entered?*

- Press the [C] (clear) key to erase the entered number, and then use the keypad to enter the correct number of minutes.

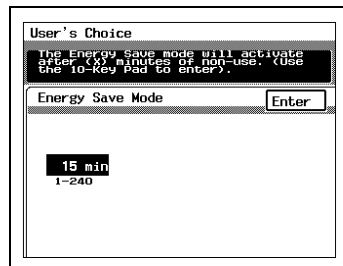

- 3 In the User's Choice screen, touch [Exit].

To set the “Sleep Mode” parameter

If the printer controller is not installed, this parameter can be used to specify the length of time after the last operation until the copier automatically turns off.

If the printer controller is installed, this parameter can be used to specify the length of time after the last operation until the copier automatically enters a standby mode (Energy Saver mode).

The default setting in either case is “30 min.”

The Sleep mode can even be turned off. For more details, refer to “Turning off the Sleep function (“Disable Sleep Mode” Function)” on page 8-15.

- 1 In the User’s Choice screen, touch [Sleep Mode].

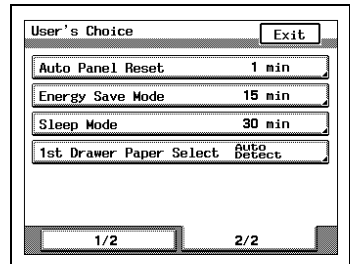

- 2 Using the keypad, enter the desired number of minutes, and then touch [Enter].

? *Do you wish to change the number of minutes entered?*

- Press the [C] (clear) key to erase the entered number, and then use the keypad to enter the correct number of minutes.

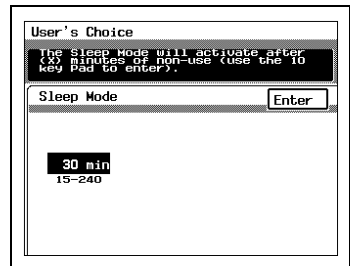

- 3 In the User’s Choice screen, touch [Exit].

To set the “1st Drawer Paper Select” parameter

Use this parameter to specify the size of paper loaded into the 1st drawer. The default setting is “Auto Detect”.

- 1 In the User's Choice screen, touch [1st Drawer Paper Select].

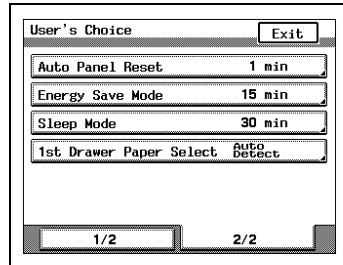

- 2 Select how the size of paper loaded into the 1st drawer is detected.

? *Is the loaded paper a metric or non-standard size?*

- Touch [Input Size], and then specify the desired paper size. Refer to “Paper Specifications” on page 3-1 for more details.

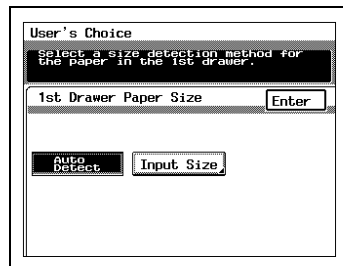

- 3 To select the paper size manually, touch [Input Size], select the desired paper size, and then touch [Enter].

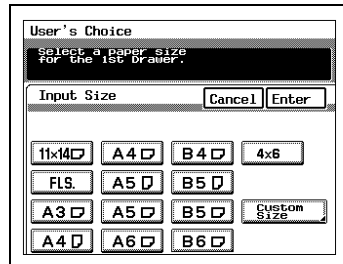

- 4 To specify a paper size other than those listed, touch [Custom Size], touch [X], [Y], and [] to specify the desired size, and then touch [Enter].

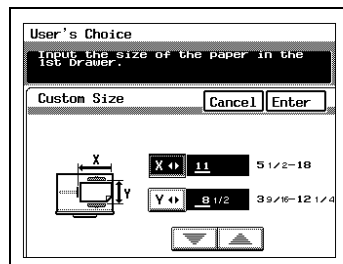

- 5 In the Input Size screen, touch [Enter].
- 6 In the 1st Drawer Paper Size screen, touch [Enter].
- 7 In the User's Choice screen, touch [Exit].

8 Administrator Mode Operations

8.1 Supervising Copier Use (“Copy Track” Function)

The Administrator mode allows the use of the copier to be controlled. With this mode, up to 99 access codes can be specified and the number of copies possible for each account can be restricted.

Note

- + The administrator access code is specified when this copier is installed. Be sure to write down this number and store it in a safe place.
- + If the administrator access code has been change, be sure to notify the appropriate service representative.

To change the Administrator Mode settings

- 1 Press the [Utility] key to enter Utility mode.

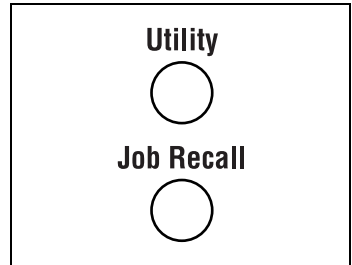

- 2 Touch [Administrator Mode].

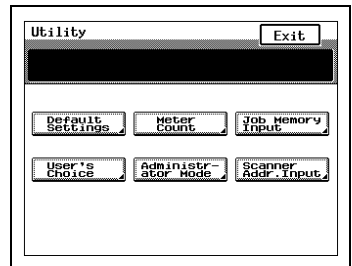

- 3 Using the keypad, enter the four-digit administrator access code.

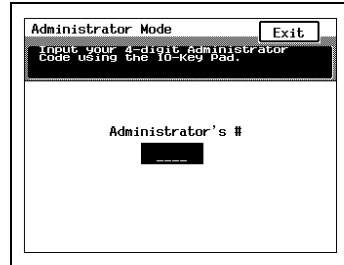

- 4 Touch [Copy Track].
The Copy Track screen appears.

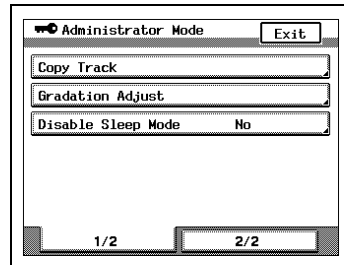

- 5 Touch [ON], and then touch the parameter that you wish to change.





To register access codes

- 1 In the Copy Track screen, touch [ON], and then touch [Access # Input].

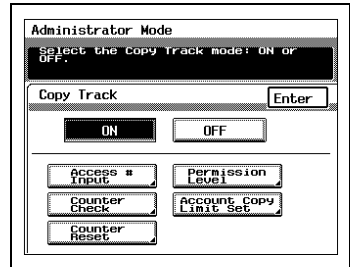
The Access # Input screen appears.



- 2 Touch [Account #], and then touch  and  to select the desired account number.

- Registering a new access code with an account number already registered with an access code changes the access code to the new one.
- Although account numbers 1 through 99 are already registered as a default, they can be changed. For more details, refer to “To change the account numbers registered” on page 8-4.
- To specify a new account number, erase a previously registered account number.

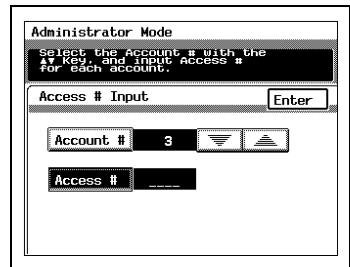

- 3 Using the keypad, enter the four-digit access code that you wish to register. To register other access codes, repeat steps 2 and 3 until the desired access codes are registered.

? *Do you wish to change the access code of an account number?*

→ Press the [C] (clear) key to erase the entered access code.

? *Has registration of the entered access code been cancelled?*

→ If the entered access code is the same as one that has already been registered, registration is cancelled. Try again using a different access code.

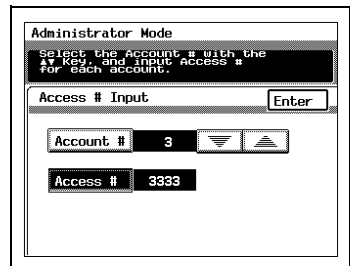

- 4 After all access codes have been registered, touch [Enter] in the Access # Input screen, and then touch [Enter] in the Copy Track screen.

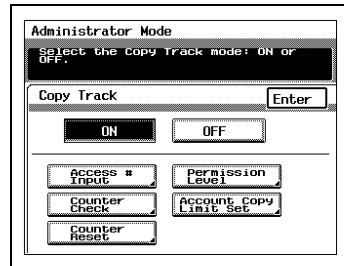

- 5 In the Administrator Mode screen, touch [Exit].
- 6 In the Utility screen, touch [Exit].



Note

If an access code has been specified, a screen appears so that access code can be entered. Use the keypad to enter the access code, and then press the [Access] key to display the Basic screen and make copies. For more details, refer to "Access Codes" on page 2-28.

To change the account numbers registered

Although account numbers 1 through 99 are already registered as a default, they can be changed. Account numbers between 1 and 998 can be registered.



Important)

- ✓ A maximum of 99 account numbers can be registered at one time. Additional accounts cannot be added.

- 1 In the Copy Track screen, touch [ON], and then touch [Access # Input].

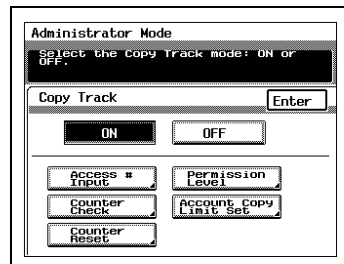
The Access # Input screen appears.



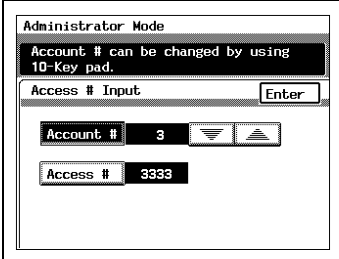

- 2 Touch [Account #], and then touch  and  to select the desired account number.



Administrator Mode

Account # can be changed by using 10-Key pad.

Access # Input

Account # 3  

Access # 3333

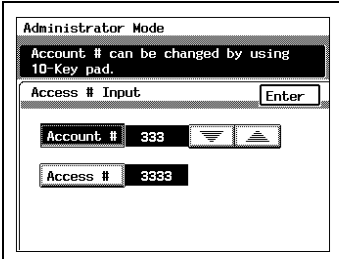

- 3 Press the [C] (clear) key to delete the account number. Use the keypad to enter a new account number between 1 and 998, and then touch [Enter] to register the current access code with the new account number.



Administrator Mode

Account # can be changed by using 10-Key pad.

Access # Input

Account # 333  

Access # 3333

? *Is the account number entered correctly?*

- The same account number cannot be registered more than once.
- If a previously registered account number is registered again, the previous one is deleted.

- 4 Touch [Enter] in the Copy Track screen.

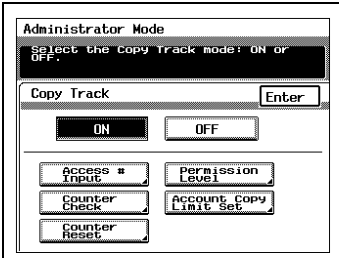

Administrator Mode

Select the Copy Track mode: ON or OFF.

Copy Track

Access # Input

Counter Check

Counter Reset

- 5 In the Administrator Mode screen, touch [Exit].
- 6 In the Utility screen, touch [Exit].

To reset Copy Track mode

- 1 In the Copy Track screen, touch [OFF].

The All Accounts Data Reset screen appears.

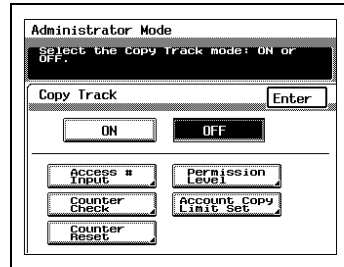

- 2 Touch [Yes], and then touch [Enter] to reset the data for all accounts.

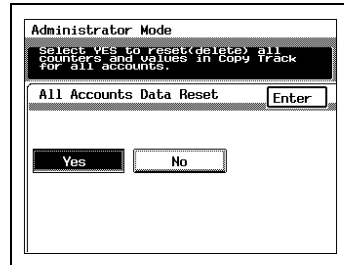



- 3 In the Administrator Mode screen, touch [Exit].
- 4 In the Utility screen, touch [Exit].

To check the number of copies made by each account

- 1 In the Copy Track screen, touch [ON], and then touch [Counter Check].

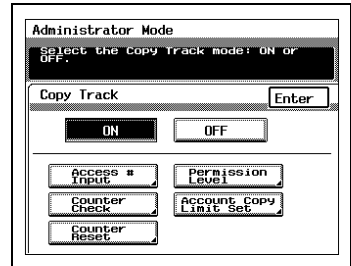
The Counter Status screen appears.



- 2 Touch  and  to select the account number that you wish to check.

- To view the total number of copies made by all accounts registered, touch [All Accts.]
- If LetterL-size paper is loaded into the multipurpose paper drawer (1st drawer) and the [Start] key is pressed, the counter table can be printed. Load the paper indicated on the screen, and then press the [Start] key again to print the counter table.

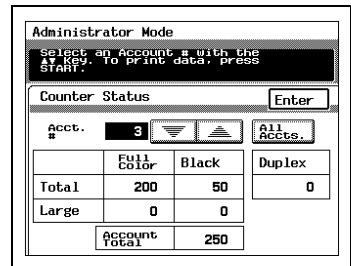

- 3 In the Counter Status screen, touch [Enter].

- 4 In the Copy Track screen, touch [Enter].



- 5 In the Administrator Mode screen, touch [Exit].

- 6 In the Utility screen, touch [Exit].

To reset the counters for each account

- 1 In the Copy Track screen, check that [ON] is selected, and then touch [Counter Reset].

The Counter Reset screen appears.

Administrator Mode

Select the Copy Track mode: ON or OFF.

Copy Track Enter

ON OFF

Access # Permission Level

Counter Check Account Copy Limit Set

Counter Reset

- 2 Touch and to select the account number for the counters that you wish to reset, and then touch [Cancel].

? *Do you wish to reset the counters for all accounts registered?*

→ Touch [All Accts.].

Administrator Mode

Select an Account # with the key. To erase data, press CANCEL.

Counter Reset Enter

Acct. # **1** All Accts.

	Full Color	Black	Duplex
Total	270	4600	60
Large	20	50	
Account Total	4870		Cancel

- 3 Touch [Yes], and then touch [Enter]. To reset the counters for other accounts, repeat steps 2 and 3.

Administrator Mode

Select YES to reset the counter of the previously selected account.

Reset Selected Account Counter Enter

Acct. # **1**

Yes **No**

- 4 In the Counter Reset screen, touch [Enter].

Administrator Mode

Select an Account # with the key. To erase data, press CANCEL.

Counter Reset Enter

Acct. # **1** All Accts.

	Full Color	Black	Duplex
Total	270	4600	60
Large	20	50	
Account Total	4870		Cancel

- 5 In the Copy Track screen, touch [Enter].

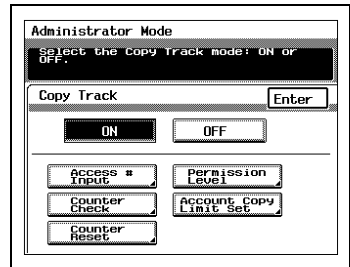

- 6 In the Administrator Mode screen, touch [Exit].
- 7 In the Utility screen, touch [Exit].

To limit the type of copies for an account

- 1 In the Copy Track screen, check that [ON] is selected, and then touch [Permission Level].

The Permission Level screen appears.

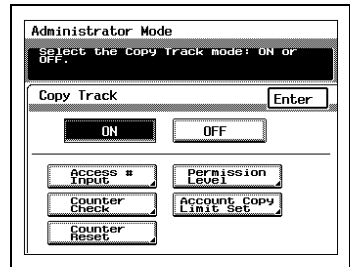

- 2 Touch [Down Arrow] and [Up Arrow] to select the account whose copies you wish to limit.

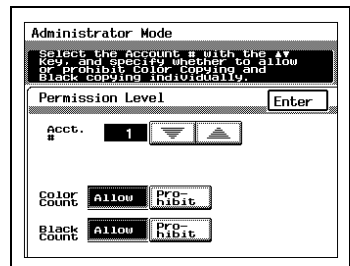

- 3 Select whether color copying and black-and-white copying are allowed ("Allow") or not ("Prohibit"). To limit the copies for other accounts, repeat steps 2 and 3.

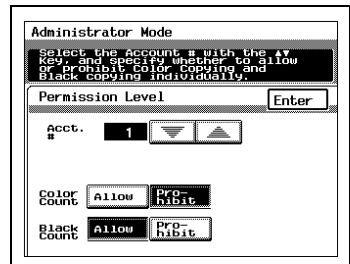

- 4 In the Permission Level screen, touch [Enter].
- 5 In the Copy Track screen, touch [Enter].

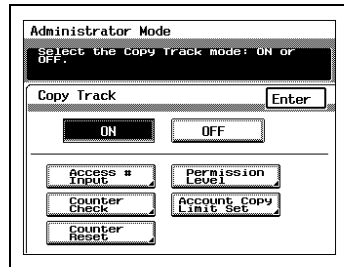

- 6 In the Administrator Mode screen, touch [Exit].
- 7 In the Utility screen, touch [Exit].



To limit the number of copies for an account

The number of copies possible for an account can be limited to a number between 1 and 99,999.

- 1 In the Copy Track screen, check that [ON] is selected, and then touch [Account Copy Limit Set].

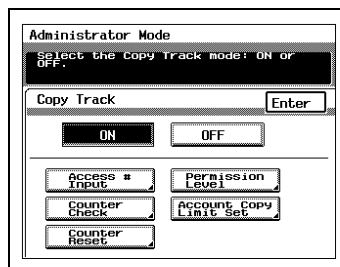
The Account Copy Limitations screen appears.



- 2 Touch  and  to select the account whose copies you wish to limit.

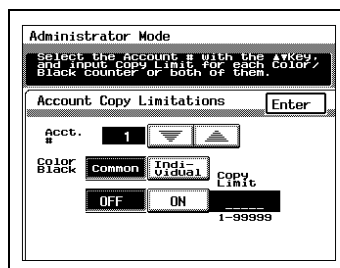

- 3 Select whether you wish to limit the number of copies for both color and black-and-white copies ("Common") or for each type separately ("Individual"), and then touch [ON].

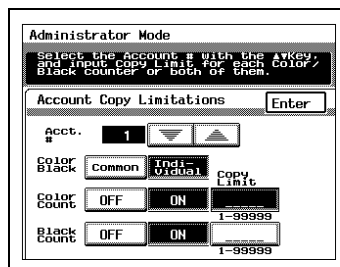

- 4 Using the keypad, enter the number of copies that you wish to limit the account to. To limit the number of copies for other accounts, repeat steps 2 through 4.

? *Do you wish to change the number entered?*

- Press the [C] (clear) key to erase the entered number, and then use the keypad to enter the correct number.

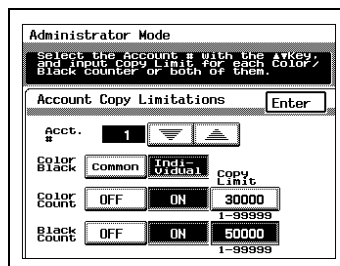

- 5 In the Account Copy Limitations screen, touch [Enter].
- 6 In the Copy Track screen, touch [Enter].

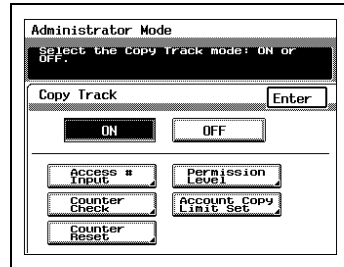

- 7 In the Administrator Mode screen, touch [Exit].
- 8 In the Utility screen, touch [Exit].

8.2 Adjusting the Gradation Levels (“Gradation Adjust” Function)

If the color gradation levels for color printing are incorrect, they can be adjusted automatically.



Note

If the gradation levels are adjusted, the “Card and Transparency Image Density” parameter of the Expert User’s Mode must be reset.

To adjust the gradation levels

- 1 Press the [Utility] key to enter Utility mode.

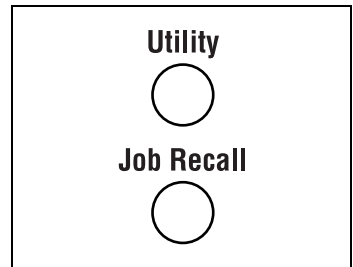

- 2 Touch [Administrator Mode].

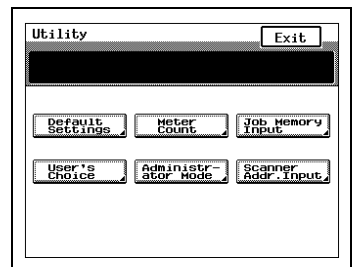

- 3 Using the keypad, enter the four-digit administrator access code.



4 Touch [Gradation Adjust].

The Gradation Adjust screen appears.

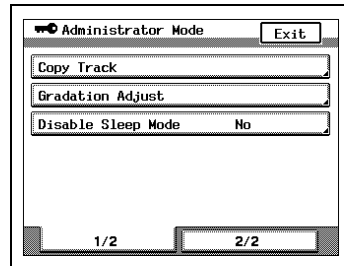

5 Load paper (11 × 17L) into any paper drawer, and then press the [Start] key to print out the gradation adjustment test pattern.

? *Are more than one of the indicated paper sizes already loaded into paper drawers?*

- The paper size for printing the test pattern will be chosen according to the following order: A3L, 11 × 17L, A4C, LetterC

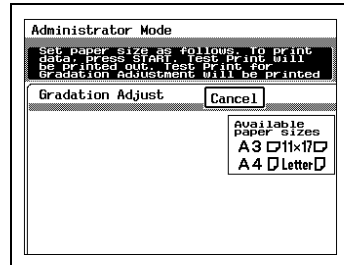

6 Place the printed test pattern on top of the original glass, and then place five more sheets of blank paper on top of the printed test pattern page.

? *Is the correct type of paper for printing the test pattern loaded?*

- Be sure that standard paper (17 to 24 lbs.) is loaded.

? *Was the test pattern not printed?*

- It takes some time for the test pattern to be printed. Please wait a little while.

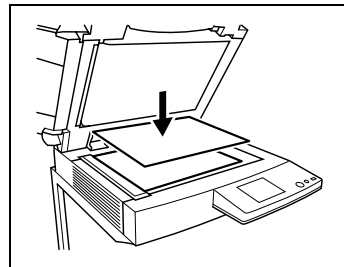

7 Close the original cover, and then press the [Start] key to begin adjusting the gradation. When the color gradation has been adjusted, the Administrator Mode screen appears.

8 Repeat steps 5 through 8 three times.

9 In the Administrator Mode screen, touch [Exit].

10 In the Utility screen, touch [Exit].

8.3 Turning off the Sleep function (“Disable Sleep Mode” Function)

Setting this function to “Yes” turns off the Sleep function. The default setting is “No”.

To turn off the Sleep function

- 1 Press the [Utility] key to enter Utility mode.

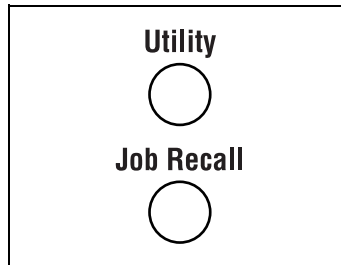

- 2 Touch [Administrator Mode].

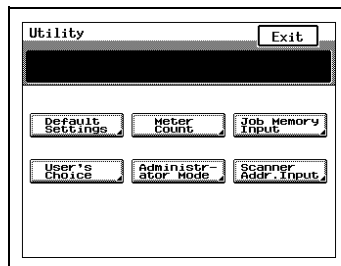

- 3 Using the keypad, enter the four-digit administrator access code.



4 Touch [Disable Sleep Mode].

The Disable Sleep Mode screen appears.

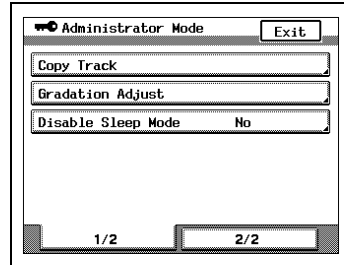

5 Touch [Yes], and then touch [Enter].

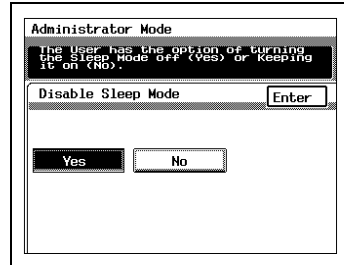

6 In the Administrator Mode screen, touch [Exit].

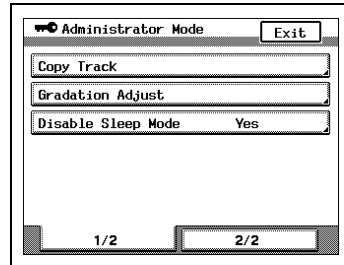

7 In the Utility screen, touch [User's Choice].

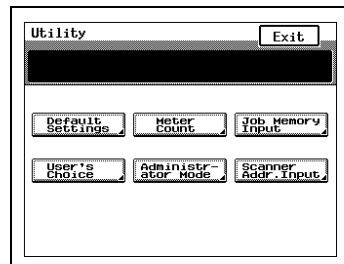

- 8 Touch [2/2], and then touch [Sleep Mode].

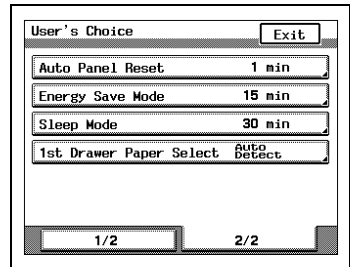

- 9 Touch [OFF], and then touch [Enter].

? Does "OFF" not appear in the Sleep Mode screen?

- If "No" is selected in the Disable Sleep Mode screen of the Administrator Mode (displayed by pressing the [Utility] key, touching [Administrator Mode], entering the administrator access code, then touching [Disable Sleep Mode]), "OFF" will not appear in the Sleep Mode screen of User's Choice.

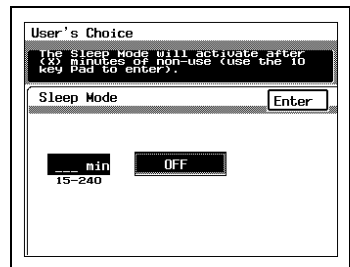

- 10 In the User's Choice screen, touch [Exit].

- 11 In the Utility screen, touch [Exit].

The Sleep function is now disabled.



Tip

If the time in the Sleep Mode screen (displayed by pressing the [Utility] key, touching [User's Choice], then touching [Sleep Mode]) is set, the Sleep function will again be enabled.

For more details, refer to "To set the "Sleep Mode" parameter" on page 7-17.

8.4 Erasing Copy Edges (“Erase” Function)

This function can be used to set the width of loss at the edge of the copy to either 5 mm (0.2 in.) or 7 mm (0.3 in.), as needed. The default setting is 5 mm (0.2 in.).

To set the “Erase” function

Note)

- ✓ Discuss any changes to this function with your service representative.

- 1 Press the [Utility] key to enter Utility mode.

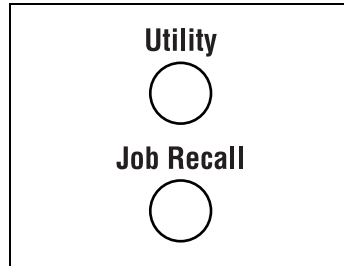

- 2 Touch [Administrator Mode].

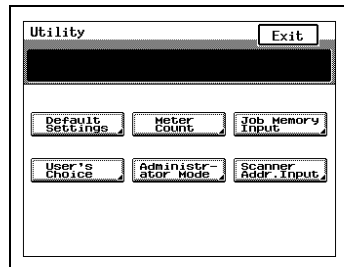

- 3 Using the keypad, enter the four-digit administrator access code.



- 4 Touch [2/2], and then touch [Erase].

The Tip Erase screen appears.

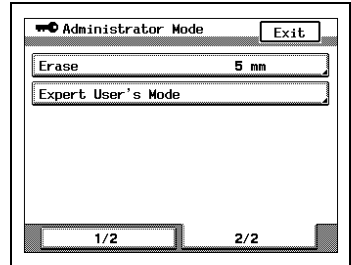

- 5 Select the desired setting, and then touch [Enter].

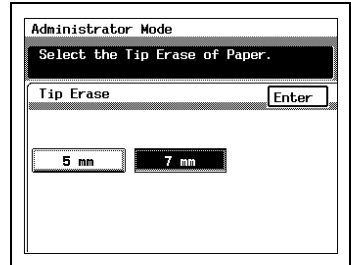

- 6 In the Administrator Mode screen, touch [Exit].
- 7 In the Utility screen, touch [Exit].

8.5 Specifying the Expert Settings (“Expert User’s Mode” Function)

In the Expert User’s mode, you can make various expert adjustments, such as color shift corrections and print area adjustments.



Note

Discuss any changes to the Expert User’s Mode settings with your technical representative.

To change the Expert User’s Mode settings

Note)

- ✓ Discuss any changes to this function with your service representative.

- 1 Press the [Utility] key to enter Utility mode.

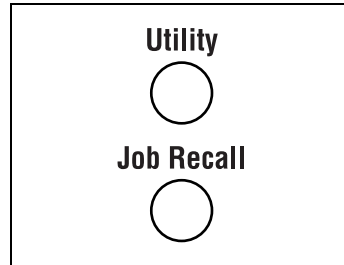

- 2 Touch [Administrator Mode].

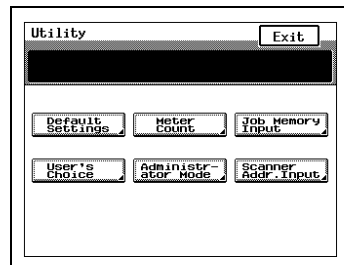

- 3 Using the keypad, enter the four-digit administrator access code.



- 4 Touch [2/2], and then touch [Expert User's Mode].

The Expert User's Mode screen appears.

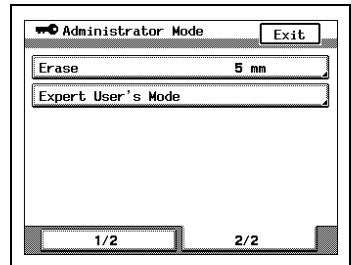

- 5 Touch the parameter that you wish to change.

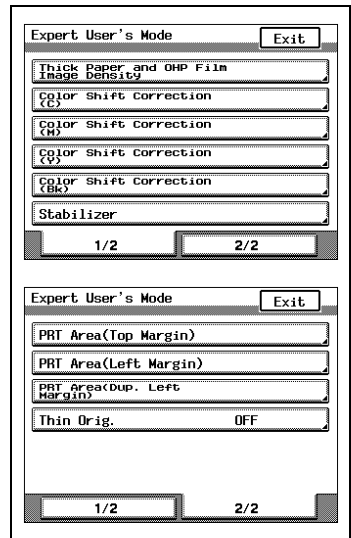



To set the “Thick Paper and OHP Film Image Density” parameter

If a difference can be seen in the image printed on thick paper as compared to normal paper, the density of the image printed on thick paper can be made darker or lighter. The density for each color (cyan, magenta, yellow and black) can be adjusted to one of five levels.

- 1 In the Expert User's Mode screen, touch [Thick Paper and OHP Film Image Density].

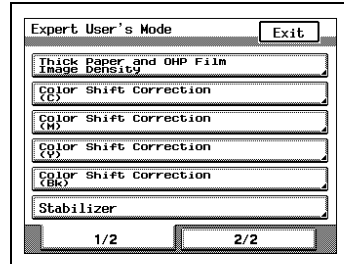
The Thick and OHP Image Density screen appears.



- 2 Touch  and  to select the desired density for each color (cyan, magenta, yellow and black), and then touch [Enter].

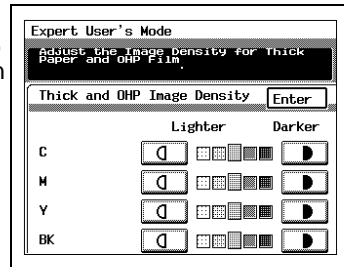

- 3 In the Expert User's Mode screen, touch [Exit].
- 4 In the Administrator Mode screen, touch [Exit].
- 5 In the Utility screen, touch [Exit].

To set the “Color Shift Correction” parameters

If a difference can be seen between the original document and the copy, fine adjustments in the color shift can be made.

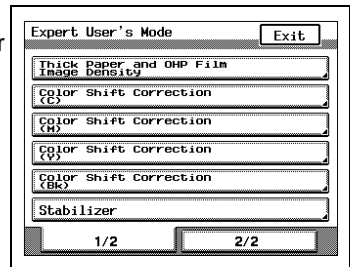

- 1 In the Expert User's Mode screen, touch [Color Shift Correction (Bk)] for the color that you wish to adjust.

The corresponding Color Shift Correction screen appears.

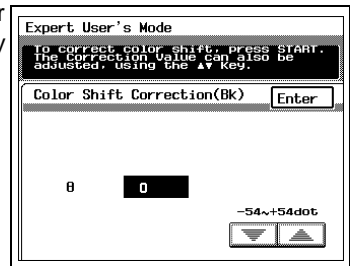

- 2 Load paper (11 × 17L) into any paper drawer, and then press the [Start] key to print out the test pattern.



- 3 Fold the printed test pattern perpendicularly to the paper feed direction, check that there is no shift in the up-and-down direction of the black reference line, and then touch [Enter].
If there is a shift, touch  and  to specify the desired adjustment for “0”, and then repeat steps 2 and 3 until there no longer is a shift.

When the necessary adjustments are finished, touch [Enter].

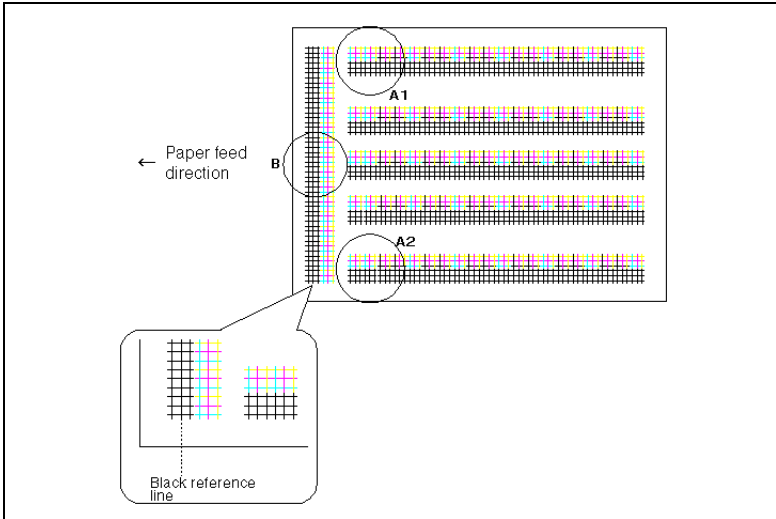

4 Using the black grids as references, check for shifts in cyan, magenta and yellow.

5 In the Expert User's Mode screen, touch [Color Shift Correction] for the color that you wish to adjust. Touch [X], [Y] or [θ] for the adjustment that you wish to make, and then touch and to specify the desired adjustment value.

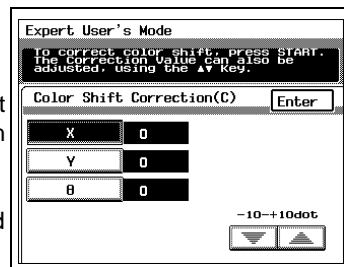

Continue printing the test pattern and making adjustments until there no longer is a color shift. When the necessary adjustments are finished, touch [Enter].

The example below shows the adjustment for cyan; however, the other colors should be adjusted in the same way.

- If the lines are shifted in the X-direction:
Touch [X], and then align on the black grid.

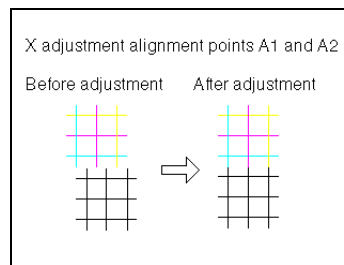

- If the lines are shifted in the Y-direction:
Touch [Y], and then align on the black grid.

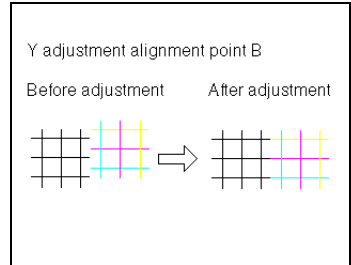

- If the lines are shifted in the θ -direction:
Touch [θ], and then align the A2 shift on the A1 shift. If necessary, touch [X], and then make the necessary adjustment.

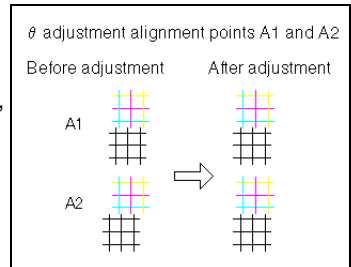

- 6 In the Expert User's Mode screen, touch [Exit].
- 7 In the Administrator Mode screen, touch [Exit].
- 8 In the Utility screen, touch [Exit].

To set the “Stabilizer” parameter

If the image is incorrect, even after the gradation levels have been adjusted, set the “Stabilizer” parameter. The default setting is “Stabilizer Mode”. The Stabilizer mode performs an image stabilization of the previous data (background) to its original state.

- 1 In the Expert User's Mode screen, touch [Stabilizer].

The Stabilizer screen appears.

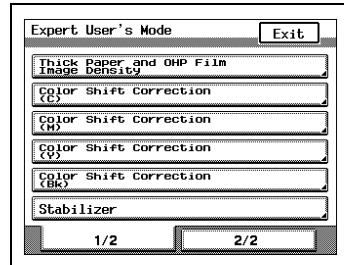

- 2 Select the desired mode, and then press the [Start] key to adjust the stabilizer automatically. After the stabilizer is correctly adjusted, the Expert User's Mode screen appears.
 - First select “Stabilizer Mode”. If the image is not corrected, select “Reset And Stabilizer Mode”.

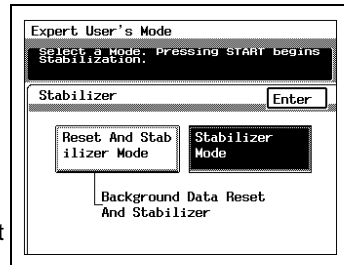

- 3 In the Expert User's Mode screen, touch [Exit].
- 4 In the Administrator Mode screen, touch [Exit].
- 5 In the Utility screen, touch [Exit].
- 6 Copy a document, and then compare the copy to the original document. Check that the copy is correct.

To set the “PRT Area (Top Margin)” parameter

This parameter can be used to adjust the paper feed position in the secondary scanning direction when making single-sided copies. In addition, this can be adjusted for each paper type. This parameter can be set between -2.0 mm and $+2.0$ mm, in increments of 0.2 mm.

Note)

- ✓ This adjustment affects paper loaded into the standard paper drawer, the manual bypass tray, the optional 500-sheet paper feed unit, and the optional large-capacity cabinet.
- ✓ The multipurpose paper drawer (1st drawer) is the tray that is checked and adjusted.
- ✓ The top margin of the print area is adjusted during manufacturing of the copier. Normally, the top margin will not need to be adjusted.

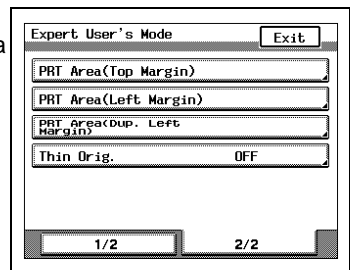

- 1 In the Expert User's Mode screen, touch [2/2], and then touch [PRT Area (Top Margin)].

The Top Margin screen appears.

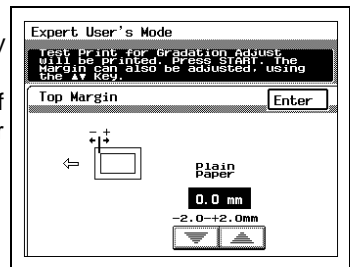

- 2 Load paper (11 × 17L) into the 1st drawer, and then press the [Start] key to print out the test pattern. The screen at the right is displayed if the paper type dial on the 1st drawer is set for normal paper.



- Check that the top margin of the printed test pattern is 5.0 mm.
- If the top margin is not as specified, touch  and  to adjust it, and then touch [Enter]. Setting a higher positive number makes the margin wider; setting a higher negative number makes the margin narrower.
- Repeat step 2 until the top margin meets its specification.

? *Do you wish to make this adjustment for other types of paper?*

- Load the appropriate paper into the multipurpose paper drawer (1st drawer), change the paper type dial to the appropriate paper setting, and then perform step 2.

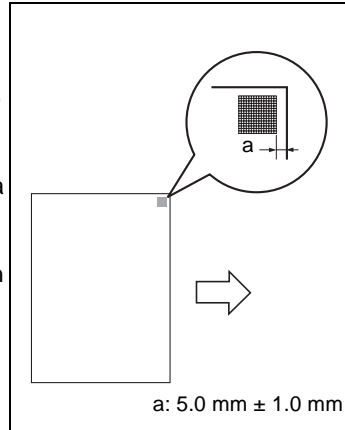

- 3 In the Expert User's Mode screen, touch [Exit].
- 4 In the Administrator Mode screen, touch [Exit].
- 5 In the Utility screen, touch [Exit].

To set the “PRT Area (Left Margin)” parameter

This parameter can be used to adjust the printing position in the secondary scanning direction when making single-sided copies. This parameter can be set between -3.0 mm and $+3.0$ mm, in increments of 0.2 mm.

The left margin of the print area for the first and second paper drawers is adjusted during manufacturing of the copier. Normally, the left margin will not need to be adjusted.

As an example, the following procedure describes how to adjust the left margin for the third paper drawer.

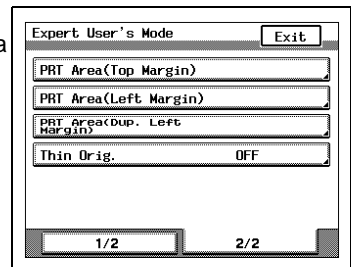

- 1 Load paper (11 × 17L) into the third paper drawer.
- 2 In the Expert User's Mode screen, touch [2/2], and then touch [PRT Area (Left Margin)].

The Left Margin screen appears.

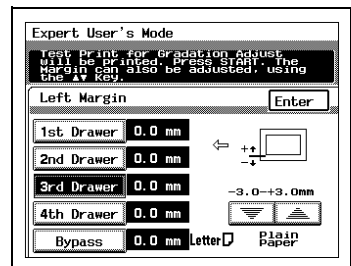

- 3 Touch [3rd Drawer], and then press the [Start] key to print out the test pattern.



- Check that the left margin of the printed test pattern is 3.0 mm.
- If the left margin is not as specified, touch  and  to adjust it, and then touch [Enter]. Setting a higher positive number makes the margin wider; setting a higher negative number makes the margin narrower.
- Repeat step 3 until the left margin meets its specification.

? *What is the standard setting?*

- Before adjusting the third or fourth paper drawer, enter the same adjustment value for the first or second paper drawer and check the test pattern.

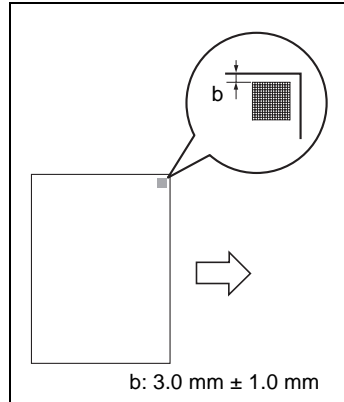

- 4 In the Expert User's Mode screen, touch [Exit].
- 5 In the Administrator Mode screen, touch [Exit].
- 6 In the Utility screen, touch [Exit].

To set the “PRT Area (Dup. Left Margin)” parameter

This parameter can be used to adjust the printing position in the secondary scanning direction when making double-sided copies. This parameter can be set between -3.0 mm and $+3.0$ mm, in increments of 0.2 mm.

This adjustment affects the main unit and any optional paper drawers.

The left margin of the print area for the first and second paper drawers is adjusted during manufacturing of the copier. Normally, the left margin will not need to be adjusted.

As an example, the following procedure describes how to adjust the left margin for the fourth paper drawer.

Note)

- ✓ In order to print a test pattern on paper loaded into the paper drawer that you wish to check and adjust, the appropriate paper drawer must be specified in advance. Refer to “Selecting the Paper Source” on page 5-4.

1 Load paper (11 × 17L) into the fourth paper drawer.

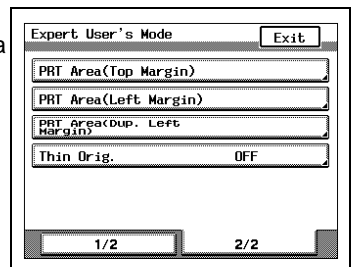

2 In the Expert User's Mode screen, touch [2/2], and then touch [PRT Area (Dup. Left Margin)].

The Dup. Left Margin screen appears.

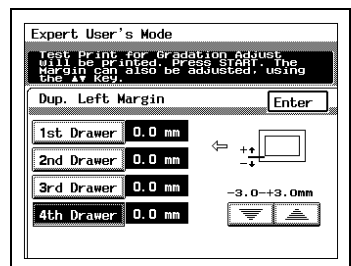

3 Touch [4th Drawer], and then press the [Start] key to print out the test pattern.



- Fold the printed page in half, and then check that the test patterns are aligned. Check that the widths of both margins are the same.
- If the margin widths of the test patterns are not the same, touch  and  to adjust it, and then touch [Enter].
Setting a higher positive number makes the margin wider; setting a higher negative number makes the margin narrower.
- Repeat step 3 until the widths of both margins are the same.
- ? *What is the standard setting?*
- Before adjusting the third or fourth paper drawer, enter the same adjustment value for the first or second paper drawer and check the test pattern.

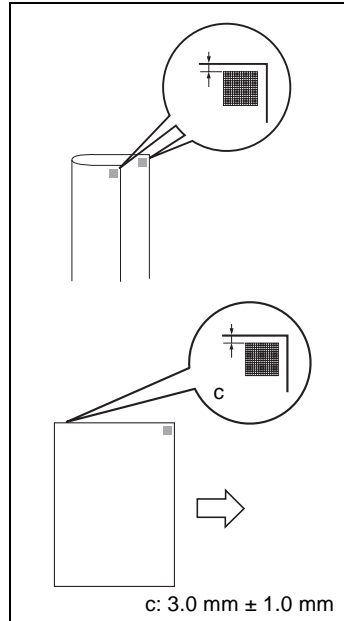

- 4 In the Expert User's Mode screen, touch [Exit].
- 5 In the Administrator Mode screen, touch [Exit].
- 6 In the Utility screen, touch [Exit].

To set the “Thin Orig.” parameter

This parameter allows you to select a setting for copying documents 10-3/4 to 13-1/4 lbs. thin.

- 1 In the Expert User's Mode screen, touch [2/2], and then touch [Thin Orig.].

The Thin Orig. screen appears.

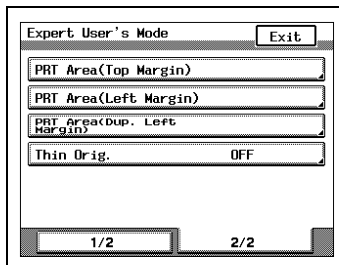

- 2 Touch [ON], and then touch [Enter].

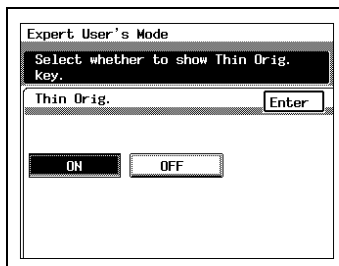

- 3 In the Expert User's Mode screen, touch [Exit].
- 4 In the Administrator Mode screen, touch [Exit].
- 5 In the Utility screen, touch [Exit].
- 6 Touch [Orig. ► Copy].

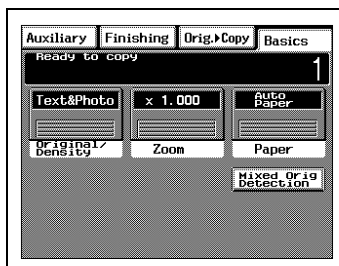

7 Touch [Thin Orig.].

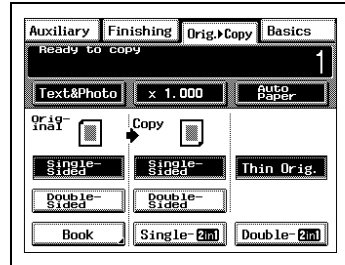

8 Specify any other necessary settings.

8.6 Registering Scan Save Locations (“Scanner Addr. Input” Function)

This function can be used when the printer controller is connected. For more details, refer to the manual for the printer controller.

9 Touch Panel Messages

9.1 When the Message “Replenish paper.” Appears

When the currently selected paper cassette runs out of paper, the message shown below appears.

Follow the procedure below to load more paper.

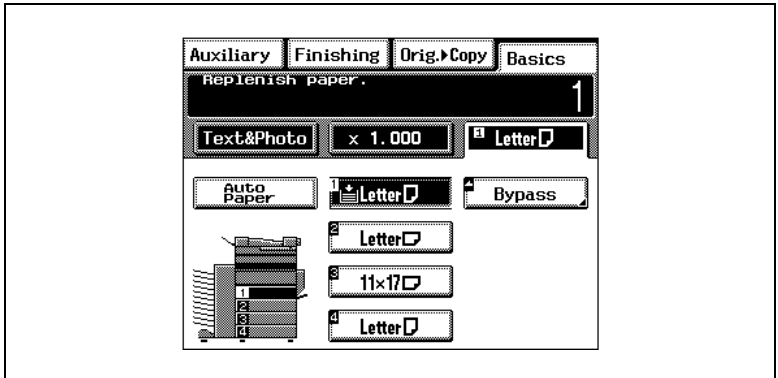

Loading paper

- into the 1st drawer (250-sheet multipurpose paper drawer) --> page 9-2
- into the 500-sheet paper feed unit --> page 9-3
- into the large-capacity cabinet --> page 9-5

To load paper into the 1st drawer (250-sheet multipurpose paper drawer)

- 1 Pull out the paper drawer.

? *Has the paper take-up roller been touched?*

- Be careful not to touch the surface of the paper take-up roller with your hands. If the roller has been touched, wipe it with a dry cloth.

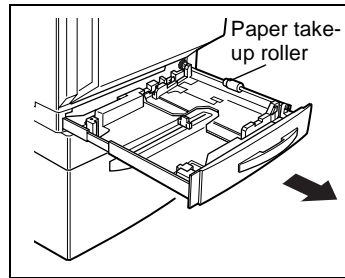

- 2 Press down on the paper-lifting plate until it locks into place.

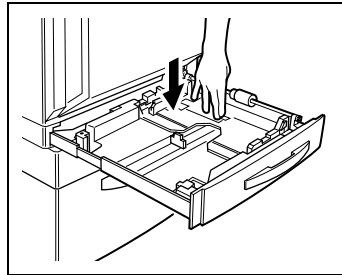

- 3 Load the paper into the drawer so that the front side of the paper (the side facing up when the package was unwrapped) faces up.

? *Have you loaded too much paper into the drawer?*

- Do not load so much paper that the top of the stack is higher than the ▼ mark.

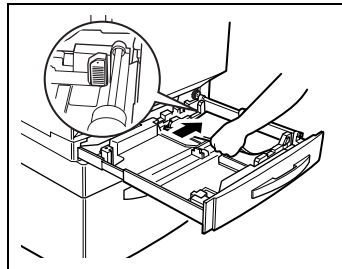

? *Has the paper been loaded correctly?*

- Make sure to align the stack of paper.
→ Make sure that the paper is not curled when it is loaded.

? *Do you wish to load a paper size or type different from that previously loaded?*

- For more details on changing the paper size and type, refer to "Loading Paper" on page 3-7.

- 4 Slide the lateral guides against the edges of the paper.

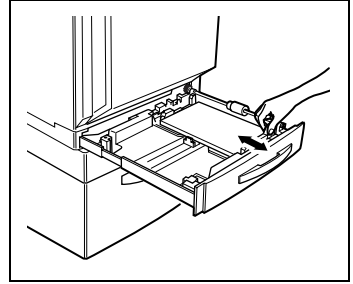

- 5 Close the paper drawer.

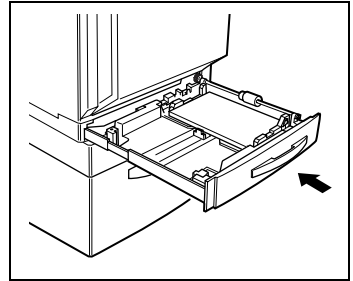

To load paper into the 500-sheet paper feed unit

- 1 Pull out the paper drawer.

? *Has the paper take-up roller been touched?*

- Be careful not to touch the surface of the paper take-up roller with your hands. If the roller has been touched, wipe it with a dry cloth.

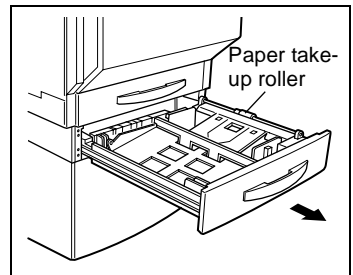

- 2 Press down on the paper-lifting plate until it locks into place.

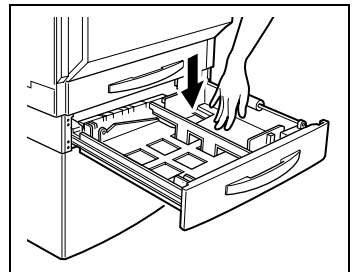

- 3 Load the paper into the drawer so that the front side of the paper (the side facing up when the package was unwrapped) faces up.

? *Have you loaded too much paper into the drawer?*

- Do not load so much paper that the top of the stack is higher than the ▼ mark.

? *Has the paper been loaded correctly?*

- Make sure to align the stack of paper.

? *Do you wish to load a paper size or type different from that previously loaded?*

- For more details on changing the paper size and type, refer to "Loading Paper" on page 3-7.

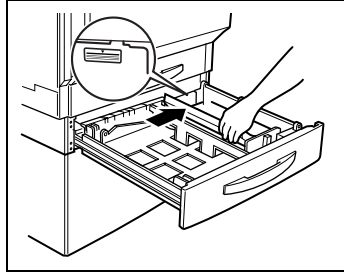

- 4 Slide the lateral guides against the edges of the paper.

- Make sure that the paper is not curled when it is loaded. Check that the lateral guides are pushed up against the edges of the paper.

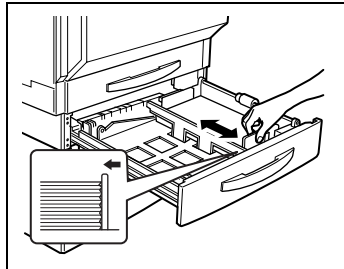

- 5 Close the paper drawer.

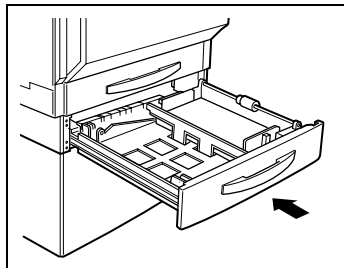

To load paper into the large-capacity cabinet

- 1 Pull out the paper drawer.

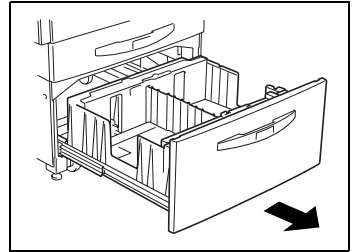

- 2 Load paper into the right side of the drawer so that the front side of the paper (the side facing up when the package was unwrapped) faces up.

? *Have you loaded too much paper into the drawer?*

- Do not load so much paper that the top of the stack is higher than the ▼ mark.

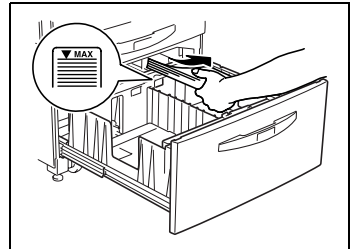

- 3 Load paper into the left side of the drawer so that the front side of the paper (the side facing up when the package was unwrapped) faces up.

? *Have you loaded too much paper into the drawer?*

- Do not load so much paper that the top of the stack is higher than the ▼ mark.

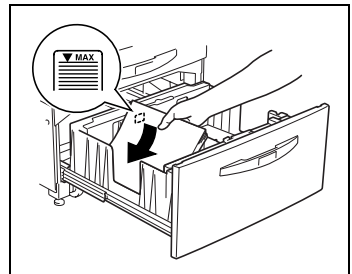

- 4 Close the paper drawer.

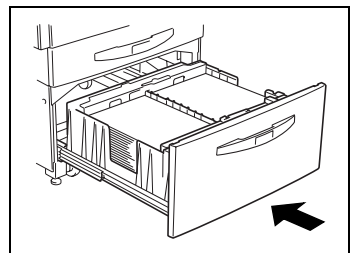

9.2 When the Message “Please add Toner.” Appears

When toner is about to run out, the advance warning message shown below appears. When the message appears, refill the toner according to your maintenance agreement.

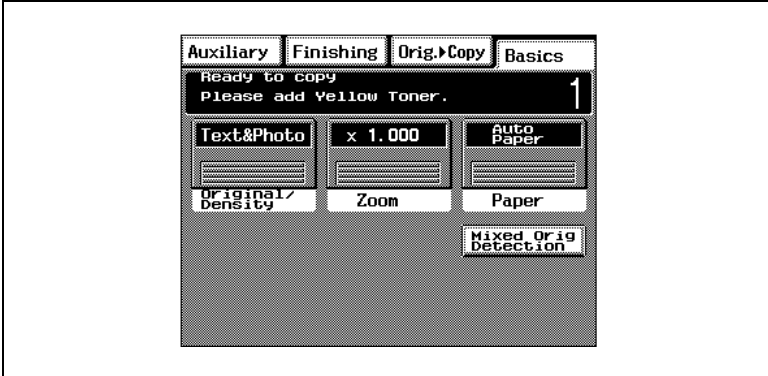

When the toner is empty, a warning message appears and copies can no longer be made. For details on refilling the toner, refer to page 9-8.

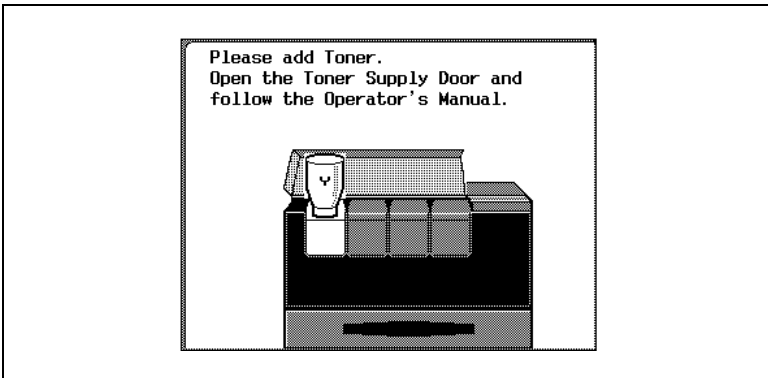

Note

Do not refill the toner until the message indicating that the toner be refilled appears on the touch panel. In addition, do not refill the toner of any color other than the one indicated in the message on the touch panel.

 CAUTION

Be careful not to spill toner inside the copier or get toner on your clothes or hands.

- If toner gets on your hands, wash them using water and a neutral soap.
- If toner gets in your eyes, immediately rinse them, and then consult a medical professional.

 CAUTION

Precaution for the disposal of the used toner bottle:

- Do not throw away the used toner bottle; instead, keep it to be collected by your technical representative.

 WARNING

Do not incinerate toner and toner containers. Dangerous sparks may cause burns.

To add toner

- 1 Open the toner supply door, and then open the toner hopper lid for the toner that you wish to refill.
 - For example: If the yellow toner is empty, open the leftmost toner hopper lid.

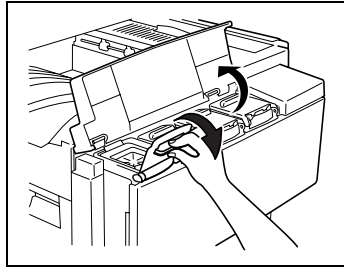

- 2 With the opening of the new toner bottle pointing up, hit the bottom of the bottle against a strong surface, such as a desk or table, four or five times from a height of about 4 in. (10 cm). (Since the toner within the bottle may have become compacted, be sure to break it up by performing this step.)

? *Is the toner bottle being held correctly?*

- When hitting the toner bottle against a surface, be sure to hold the bottle so that the opening of the bottle is pointing up.

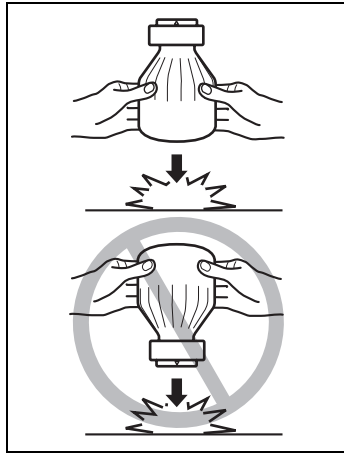

- 3 While firmly grasping the new toner bottle, shake it well.

? *Is the toner within the bottle hard?*

- The toner within the bottle may become compacted. If it does, be sure to shake the bottle until the toner is mostly broken up before adding it to the hopper.

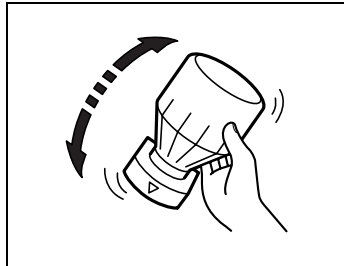

- 4 With the rounded side (marked with "▼") of the bottle mouth facing towards you, place the toner bottle on top of the hopper, and then press down on the bottle until it snaps into place.

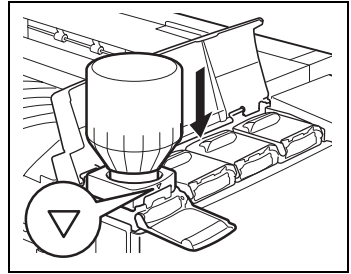

- 5 Fully pull the toner hopper shutter out toward you.

Pulling out the toner hopper shutter allows the toner to fill the toner hopper.

Check that all of the toner has emptied out of the toner bottle and into the hopper, which may take a while.

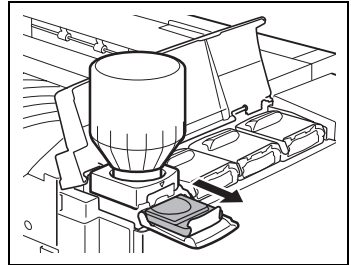

? *Do you know what precautions should be taken when refilling the toner?*

- Do not tap on the toner bottle while refilling the hopper; otherwise, the toner may spurt out.

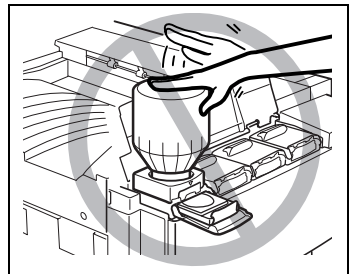

- 6 Push the toner hopper shutter closed.

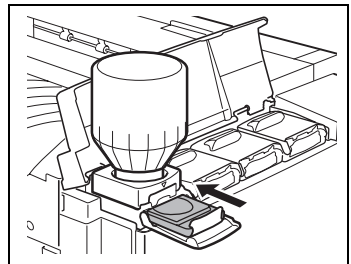

- 7 Tilt the toner bottle backward, and then pull the opening of the bottle up and toward you to remove it.

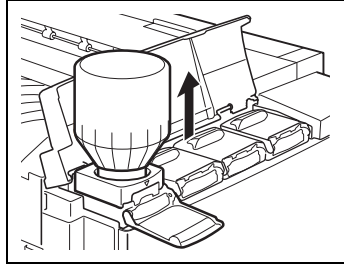

- 8 Close the toner hopper lid, and then close the toner supply door.

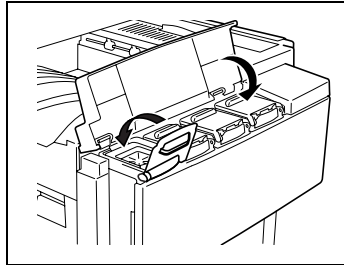

9.3 When the Message “Replace Staple Cartridge X.” Appears

When finisher F-8110 or F-8430 is installed and is about to run out of staples, the message shown below appears.

Follow the procedure below to replace the staple cartridge.

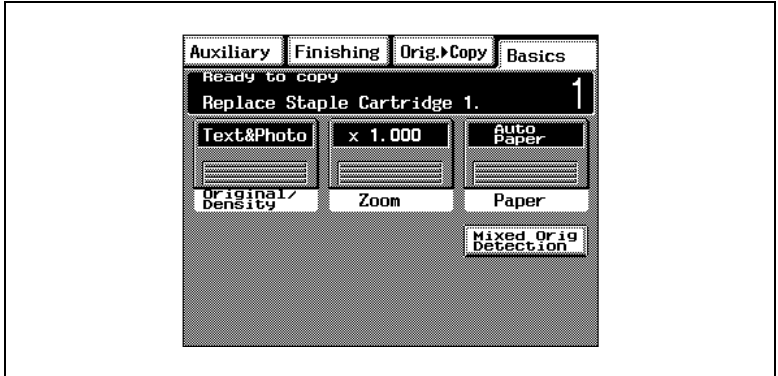

To replace the staple cartridge

- 1 Slide the finisher away from the copier.

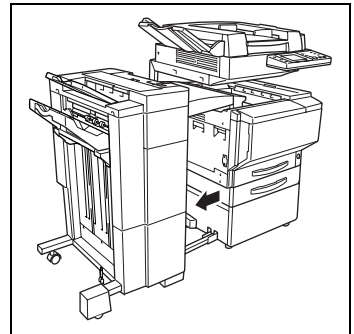

- 2 If finisher F-8430 is installed, open right-side door FN7.

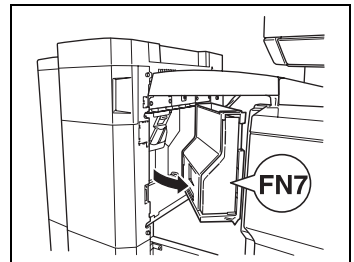

- 3 Turn the dial to the left in order to position the stapler at the center.

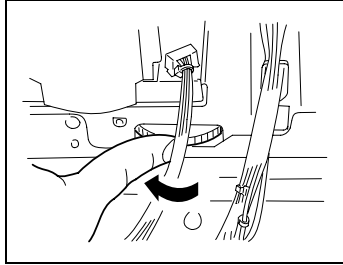

- 4 Pull the staple holder out toward you.

- Finisher F-8430

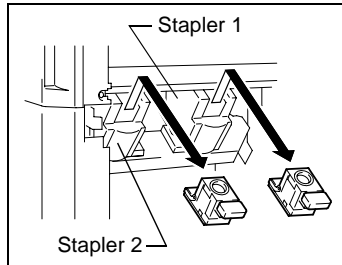

- Finisher F-8110

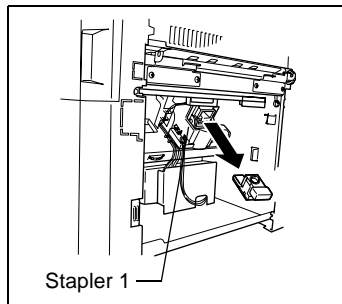

? *Since finisher F-8430 is equipped with two staple holders, which staple holder should be pulled out?*

- The message on the touch panel indicates which staple holder should be pulled out.

- 5 (Finisher F-8430)
Remove the empty staple cartridge from the staple holder.

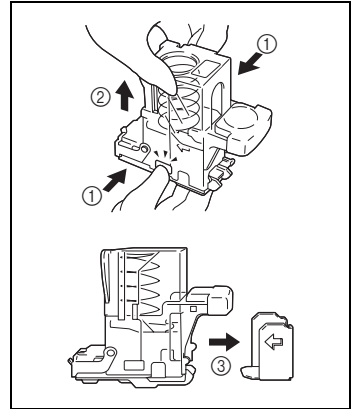

- 6 (Finisher F-8430)
Insert the new staple cartridge into the staple holder, and then carefully remove the stopper.

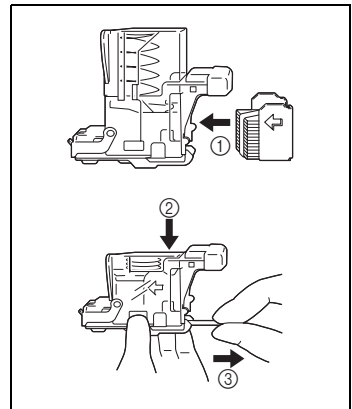

- 7 (Finisher F-8110)
Remove the empty staple cartridge from the staple holder.

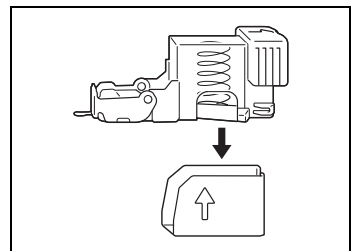

- 8 (Finisher F-8110)
Insert the new staple cartridge into the staple holder, and then carefully remove the stopper.

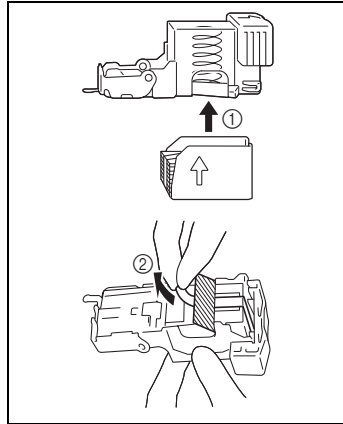

- 9 Insert the refilled staple holder until it locks into place.

- Finisher F-8430

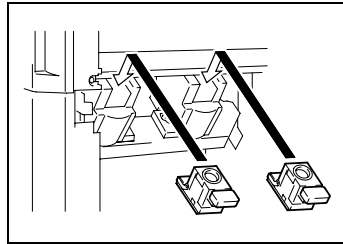

- Finisher F-8110

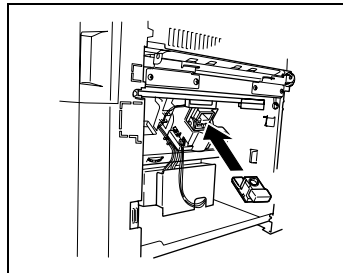

- 10 If finisher F-8430 is installed, close right-side door FN7.

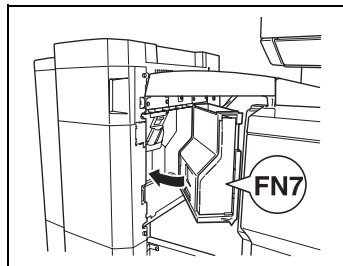

- 11 Slide the finisher back against the copier.

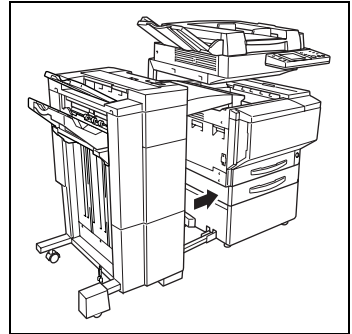
**Note**

Be sure to replace the staple cartridge only after this message appears. Injuries may occur if the staple cartridge is removed before the message appears.

9.4 When the Message “Misfeed detected.” Appears

If a paper misfeed occurs during copying, the message shown below appears.

Follow the procedure below to clear the misfed paper.

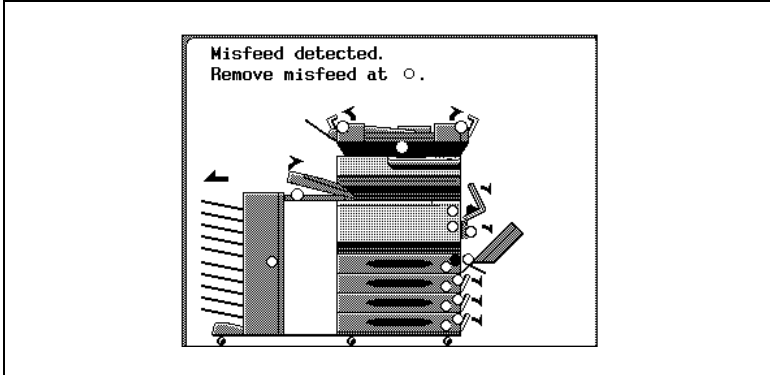

Locations of Paper Misfeeds

- ✦ The procedure for clearing misfed paper differs depending on where the misfeed occurs. Determine the misfeed location by looking at the illustration displayed with the error message, and then clear the misfeed according to the appropriate procedure.
- ✦ A flashing “2” indicates the location of the paper misfeed. In addition, a lit “2” indicates areas where paper may have been misfed and that should be checked.

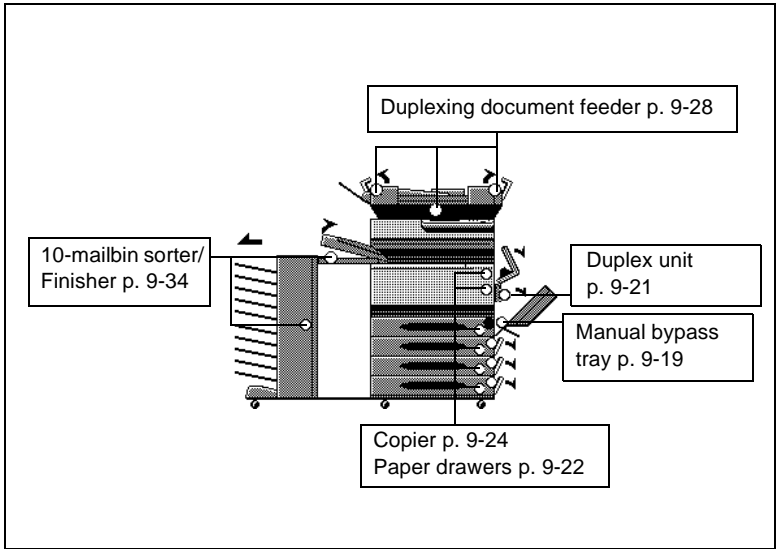

Copier p. 9-24

Paper feed unit p. 9-22

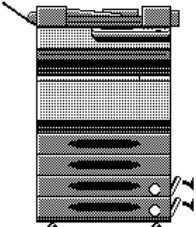
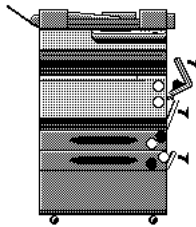

Duplex unit p. 9-21

Manual bypass tray p. 9-19

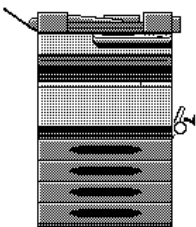
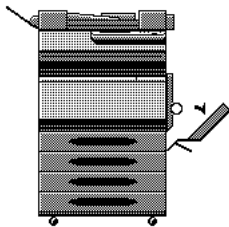

Duplexing document feeder p. 9-28

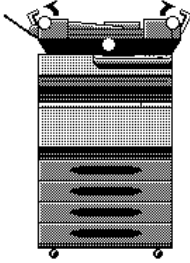

Finisher F-8110/F-8430 p. 9-30

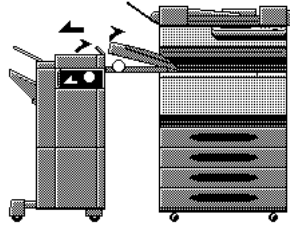

10-mailbin sorter p. 9-34

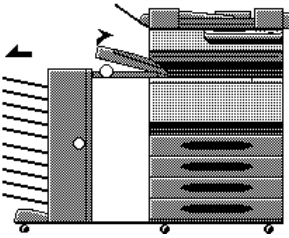

Paper Misfeed in the Manual Bypass Tray

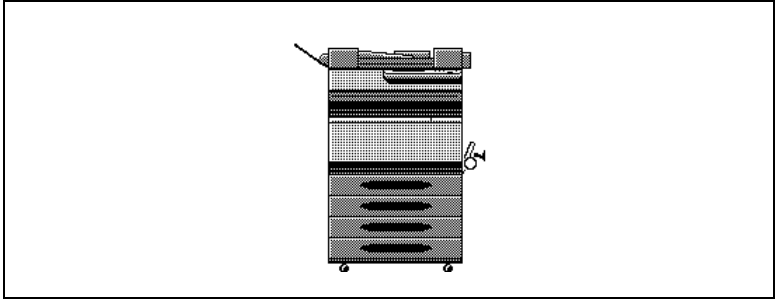

To clear a paper misfeed in the manual bypass tray

CAUTION

Decreased copy quality may result if the surface of the image transfer belt at the bottom of the copier's fusing unit is touched.

- Be careful not to touch the surface of the image transfer belt at the bottom of the copier's fusing unit.

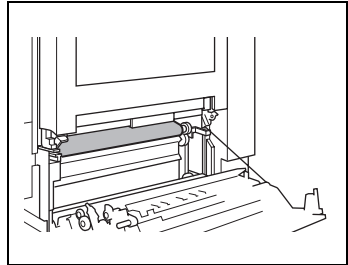

CAUTION

The copier's fixing unit is extremely hot. Take sufficient care when working in this area, as there is a danger of getting burned.

- 1 Pull up the lock release lever to open the right-side door.

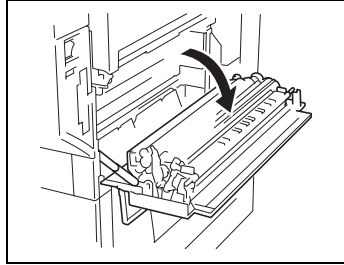

- 2 Carefully pull out the paper.

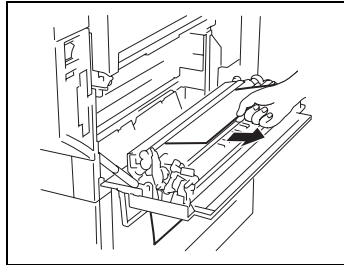

- 3 Close the right-side door.

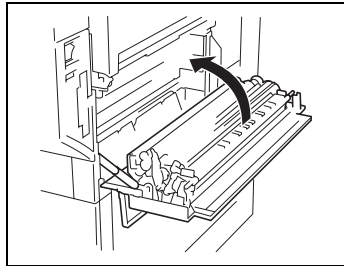

Paper Misfeed in the Duplex Unit

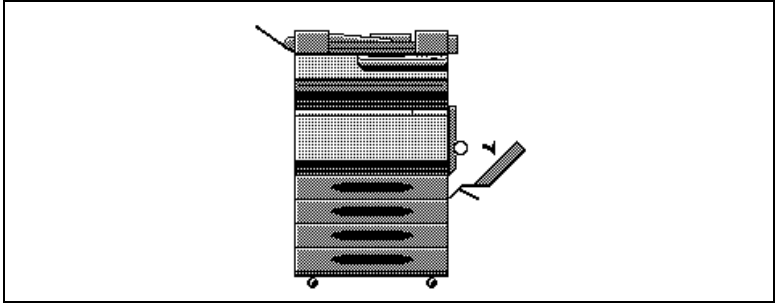

To clear a paper misfeed in the duplex unit

- 1 Open the duplex unit door.

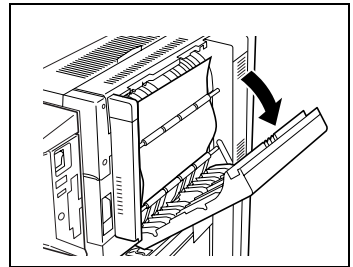

- 2 Carefully pull out the paper.

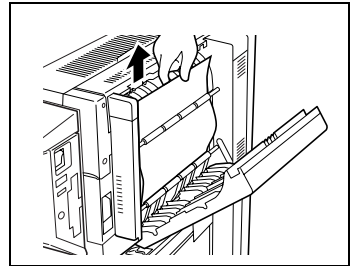

- 3 Close the duplex unit door.

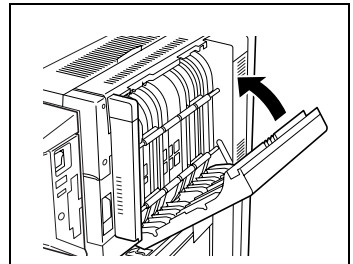

Paper Misfeed in the Paper Feed Unit

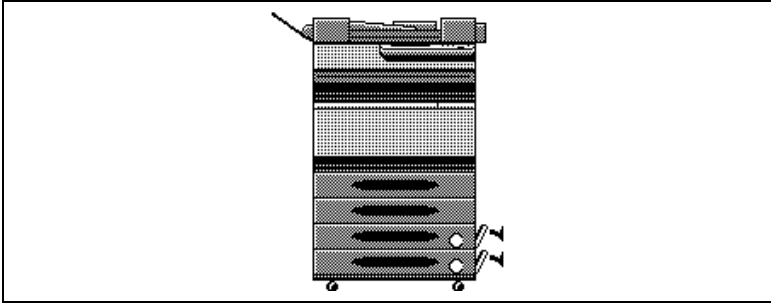

To clear a paper misfeed in the paper feed unit

- 1 Open the lower right-side door.

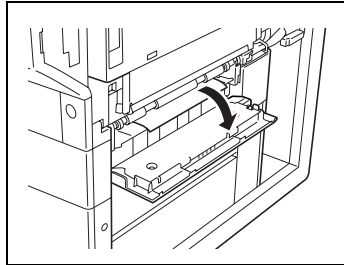

- 2 Turn the green wheels to feed the paper so that it can be easily removed.

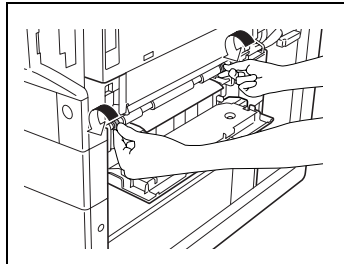

- 3 Carefully pull out the paper.

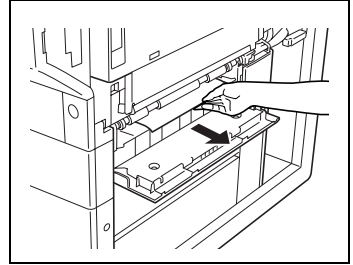

? *Is the large-capacity cabinet installed?*

- While turning the green dial in the direction of the arrow, carefully pull out the paper.

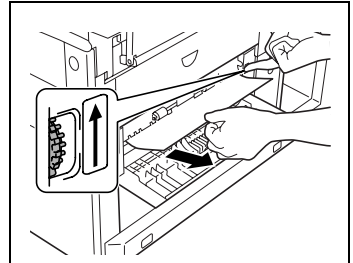

- 4 Close the lower right-side door.

- 5 Pull out the paper drawer being used, and then remove any paper remaining in the drawer.

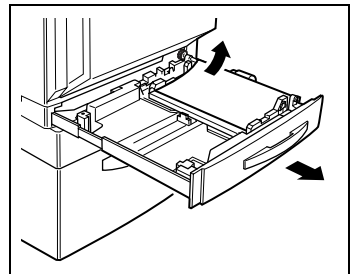

- 6 Load the paper in the drawer again, and then close the drawer.

? *Has the paper take-up roller been touched?*

- Be careful not to touch the surface of the paper take-up roller with your hands. If the roller has been touched, wipe it with a dry cloth.

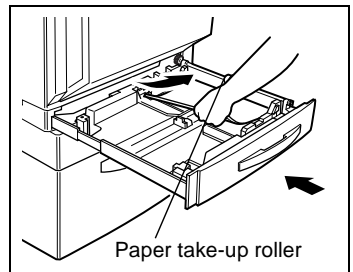

Paper Misfeed in the Copier

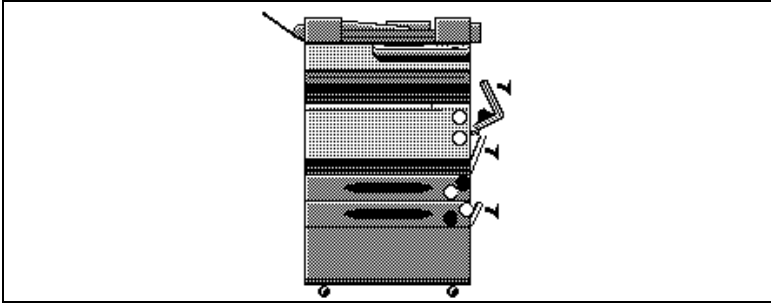

To clear a paper misfeed in the copier

⚠ CAUTION

Decreased copy quality may result if the surface of the image transfer belt at the bottom of the copier's fusing unit is touched.

- Be careful not to touch the surface of the image transfer belt at the bottom of the copier's fusing unit.

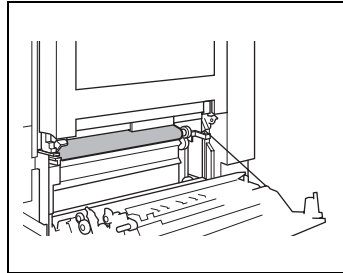

⚠ CAUTION

The copier's fixing unit is extremely hot. Take sufficient care when working in this area, as there is a danger of getting burned.

- 1 Pull up the lock release lever to open the right-side door.

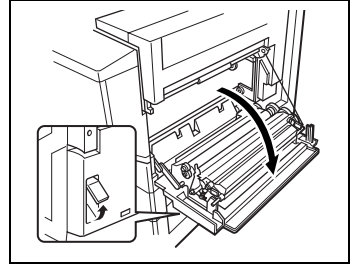

- 2 Grasp the upper right-side door as shown, and then carefully open the door completely while making sure to support it.

? *Is the upper right-side door being opened correctly?*

- Be sure to support the door while carefully opening it; otherwise, it may be damaged.

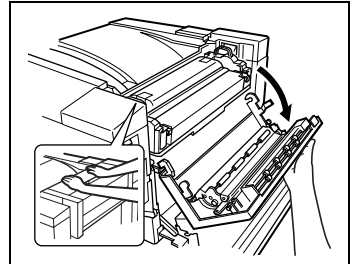

- 3 While moving the green lever on the inside of the upper right-side door in the direction of the arrow, carefully pull out the paper.



- 4 Carefully pull out the paper.

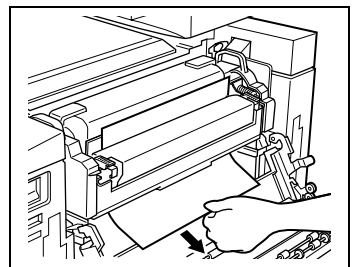

- 5 Move the two lock release levers for the oil-coating unit in the direction of the arrows.

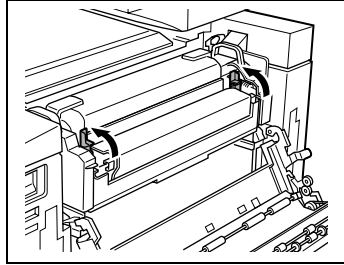

- 6 Move the levers (one on each end of the oil-coating unit) in the direction of the arrows and carefully pull out the paper.

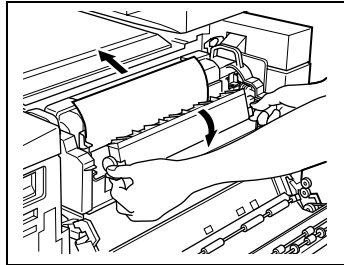

- 7 While holding the levers on the ends of the oil-coating unit, move the unit back to its original position.

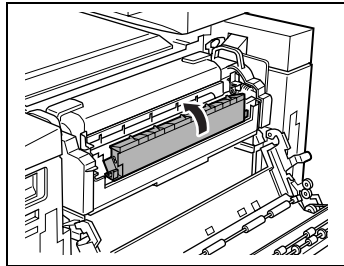

- 8 Fully move the two lock release levers for the oil-coating unit in the direction of the arrows.

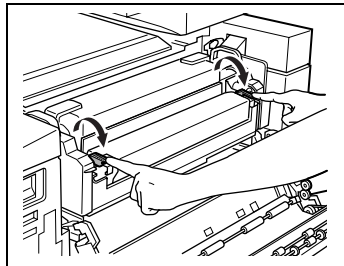

9 Close the upper right-side door.

10 Close the right-side door.



CAUTION

The copier's fixing unit is extremely hot. Take sufficient care when working in this area, as there is a danger of getting burned.

Paper Misfeed in the Duplexing Document Feeder

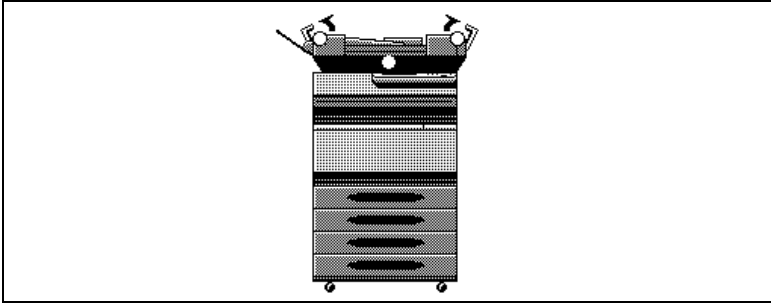

To clear a paper misfeed in the duplexing document feeder

- 1 Open misfeed clearing cover F1.

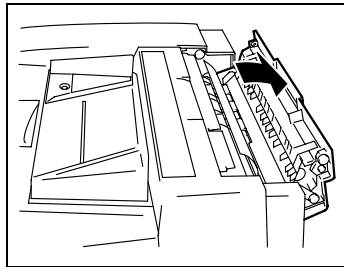

- 2 Remove all documents from the document feed tray, and then carefully pull out any other documents.

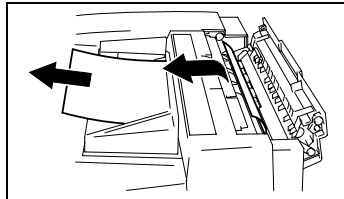

- 3 Open misfeed clearing cover F2, and then carefully pull out any documents.

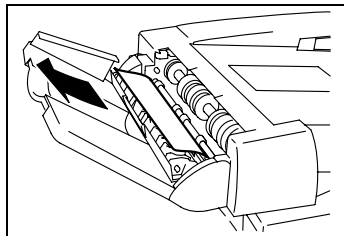

- 4 Open the duplexing document feeder, and then carefully pull out any documents.

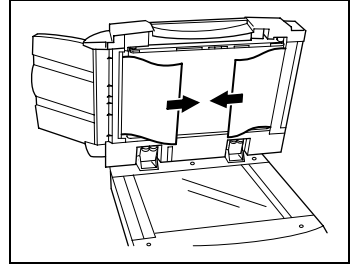

- 5 Remove any documents on the original glass, and then close the duplexing document feeder.

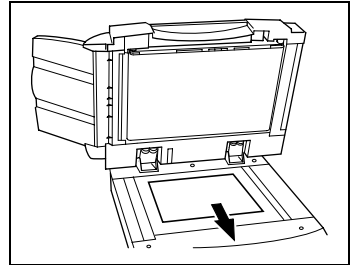

- 6 Close misfeed clearing covers F1 and F2.

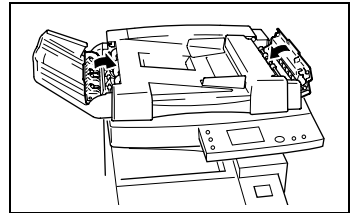

- 7 Reload the documents according to the instructions that appear on the touch panel.

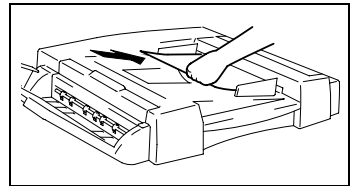

Paper Misfeed in Finisher F-8110/F-8430

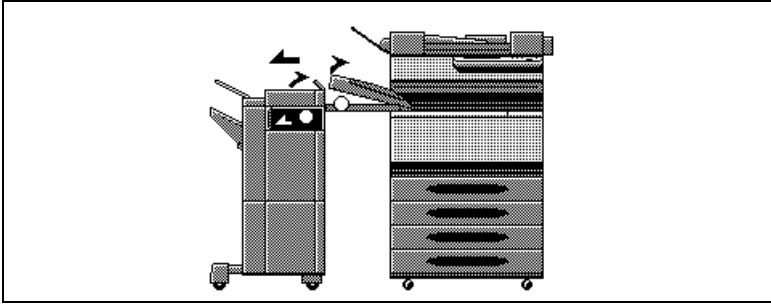

CAUTION

**Metallic parts inside Misfeed Clearing Guide [FN1] are very hot.
(Part indicated in Step 10.)**

→ Do not touch anything but the paper to prevent you from getting burned.



Note

Be careful about a protrusion on the backside of the horizontal transport unit cover.

It can hurt you! (Part indicated is Step 3.)

To clear a paper misfeed in finisher F-8110/F-8430

- 1 Slide the finisher away from the copier.

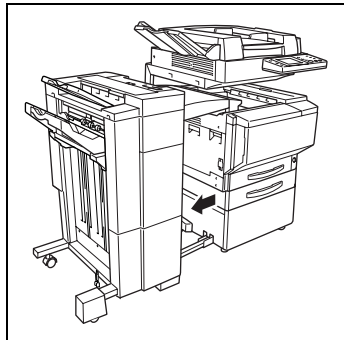

- 2 Open the cover of the horizontal transport unit.

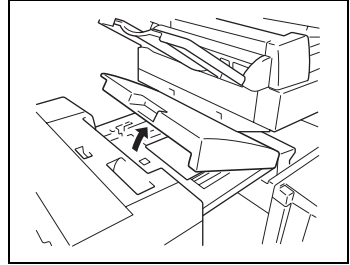

- 3 Remove any paper, and then close the cover of the horizontal transport unit.

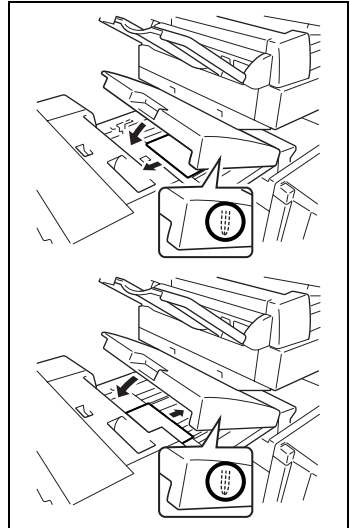

- 4 If finisher F-8430 is installed, open right-side door FN7.

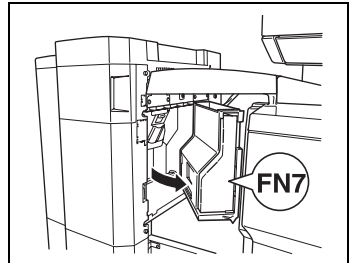

- 5 While holding open misfeed clearing guide FN8 (for finisher F-8430) or FN7 (for finisher F-8110), remove any paper.

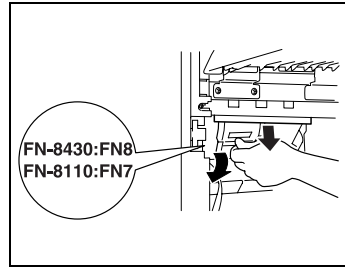

- 6 If finisher F-8430 is installed, close right-side door FN7.
- 7 Open front door FN4.

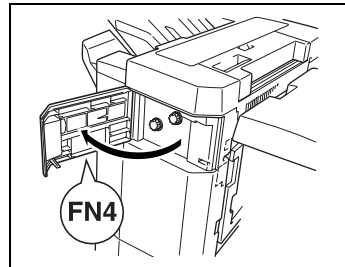

- 8 Turn knobs FN5 at the same time to feed out any paper.

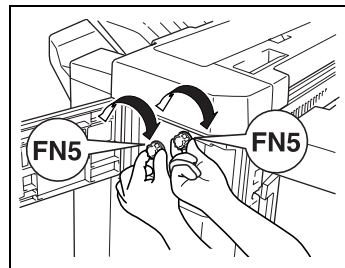

- 9 Close front door FN4.
- 10 Open upper cover FN1.

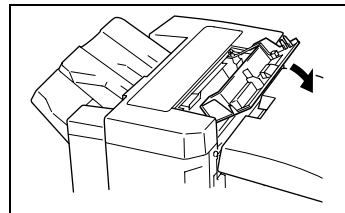

- 11 While holding misfeed clearing guide FN2 open, remove any paper

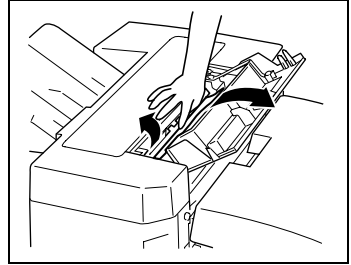

- 12 While holding misfeed clearing guide FN3 open, remove any paper.

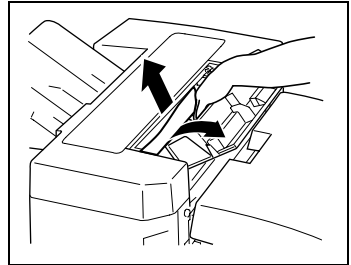

- 13 Close upper cover FN1.

- 14 While holding misfeed clearing guide FN6 open, remove any paper.

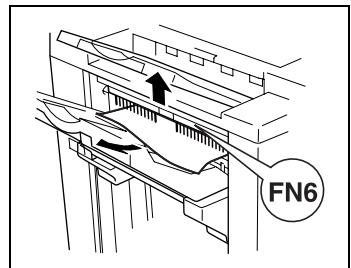

- 15 Slide the finisher back against the copier.

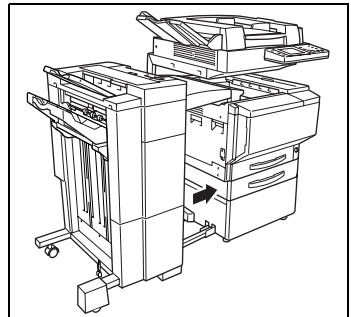

Paper Misfeed in the 10-Mailbin Sorter

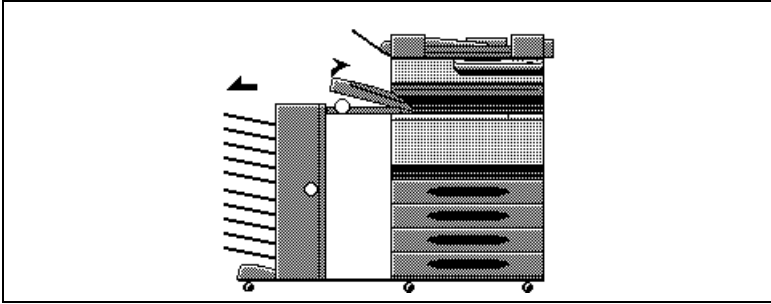

CAUTION

Be careful about a protrusion on the backside of the horizontal transport unit cover. It can hurt you! (Part indicated in Step 4.)

To clear a paper misfeed in the 10-mailbin sorter

- 1 Slide the 10-mailbin sorter away from the copier.

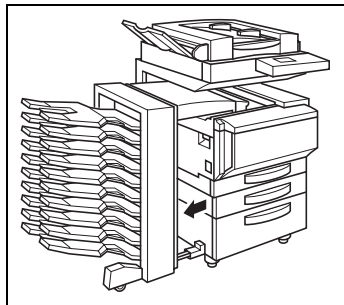

- 2 Remove any paper from the mailbins.

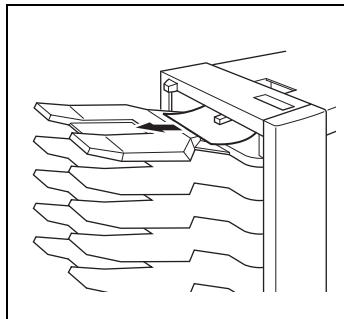

- 3 Open the cover of the horizontal transport unit.

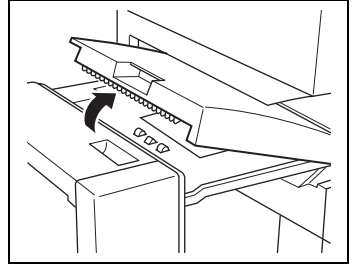

- 4 Remove any paper, and then close the cover of the horizontal transport unit.

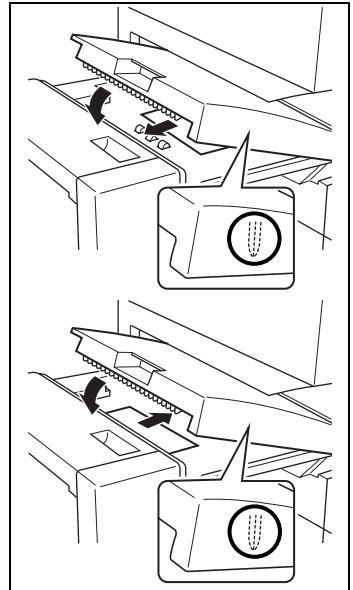

- 5 Open the upper door and the lower door.

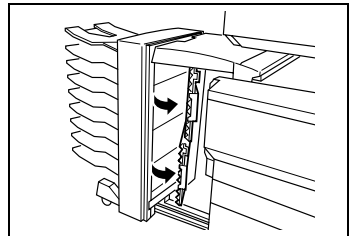

- 6 Remove any paper.

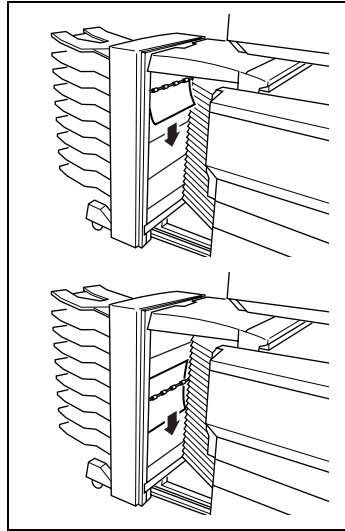

- 7 Close the upper door and the lower door.

- 8 Slide the 10-mailbin sorter back against the copier.

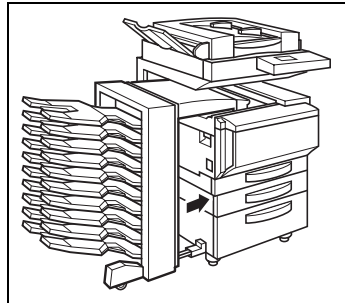

9.5 When the Message “Cannot staple.” Appears

When finisher F-8110 or F-8430 is installed and the staples are jammed, the message shown below appears.

Follow the procedure below to clear the jammed staples

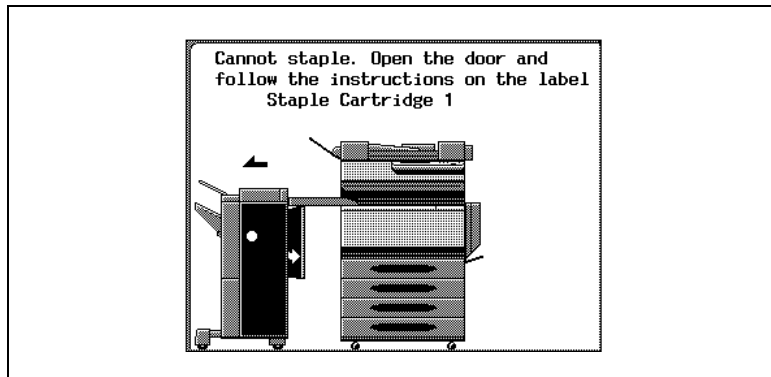

To clear jammed staples

- 1 Slide the finisher away from the copier.

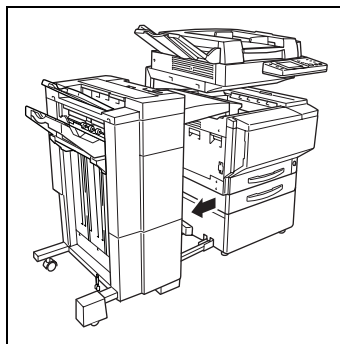

- 2 If finisher F-8430 is installed, open right-side door FN7.

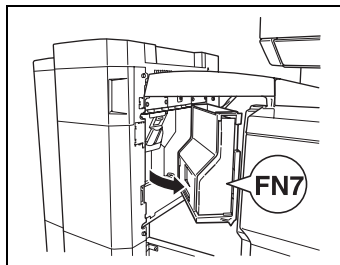

- 3 Turn the dial to the left in order to position the stapler at the center.

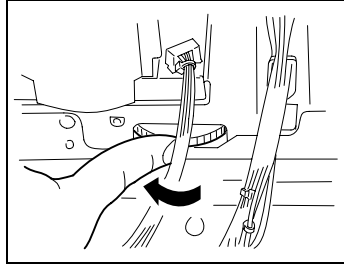

- 4 Pull the staple holder out toward you.

- Finisher F-8430

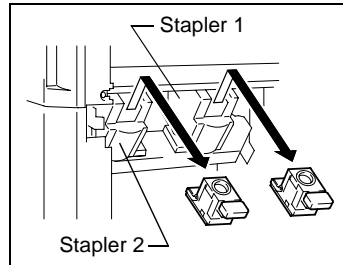

- Finisher F-8110

? *Since finisher F-8430 is equipped with two staple holders, which staple holder should be pulled out?*

→ The message on the touch panel indicates which staple holder should be pulled out.

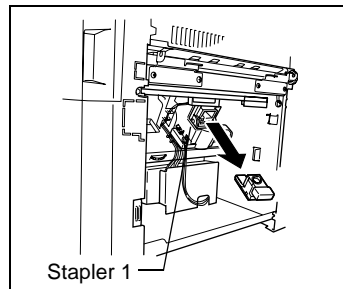

- 5 Push the staple holder guide up, and then pull out one sheet of staples.

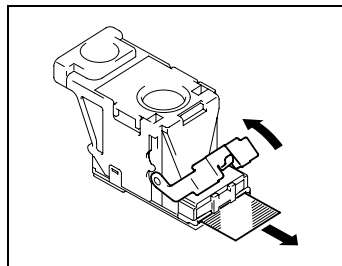

- 6 Move the guide back to its original position.

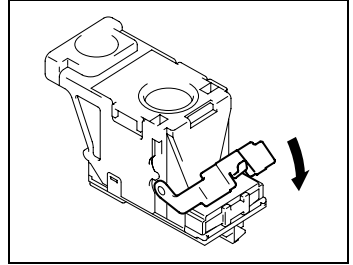

- 7 Insert the staple holder until it locks into place.

- Finisher F-8430

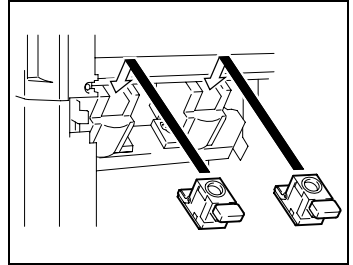

- Finisher F-8110

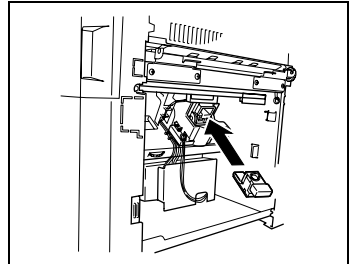

- 8 If finisher F-8430 is installed, close right-side door FN7.

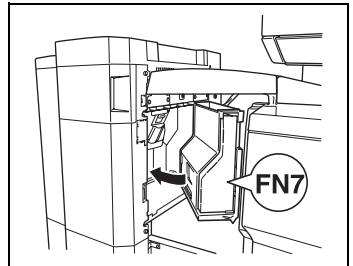

- 9 Slide the finisher back against the copier.
- ? *Are the staples still jammed, even after performing the above procedure?*
- Contact a qualified technical representative.

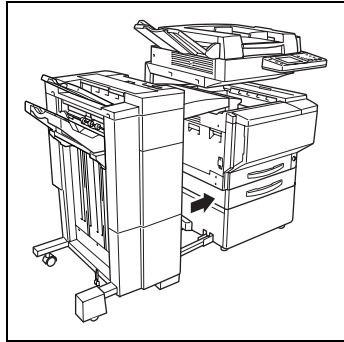

9.6 When the Inspection Mark “” Appears

When the inspection mark () in the lower-left corner of the touch panel appears, the image stabilization, printing and scanning functions of the copier have become unstable.

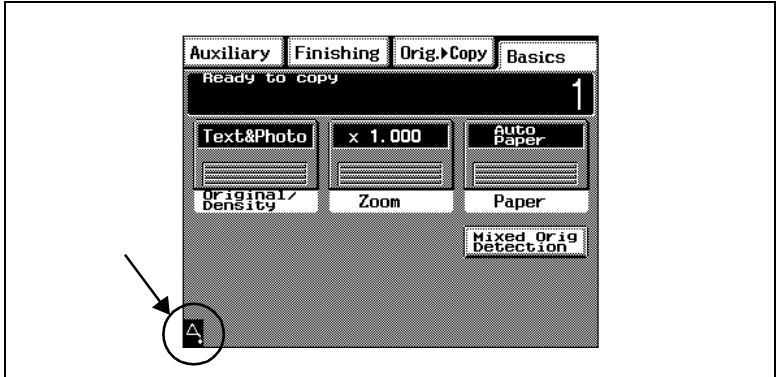

Note

Touching the inspection mark () that appears in the touch panel displays a screen like that shown below.

When contacting the technical representative, inform them of the numbers ("P-7" in the example below) listed in the screen that appears.

Touching [Exit] in the top-right corner displays the Basic screen.

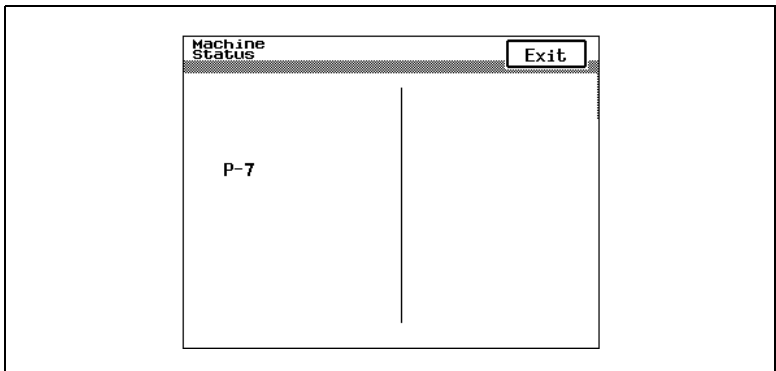

9.7 When the Message “Malfunction detected.” Appears

When the message shown below appears in the touch panel, a malfunction has occurred within this copier. If this message appears, contact your technical representative.

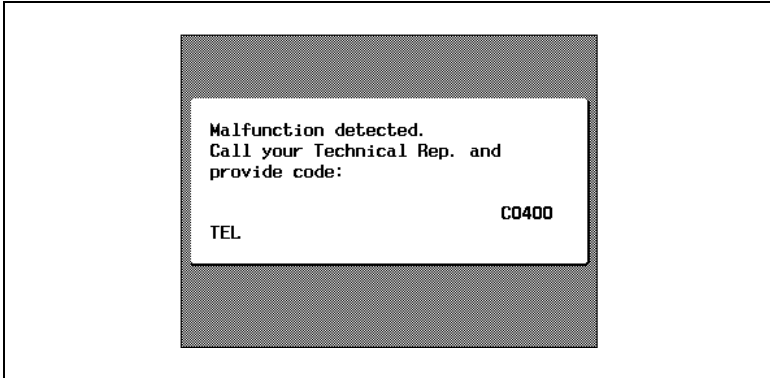

Note

When contacting the technical representative, inform them of the code (“C0400” in the example above) in the screen that appears.

9.8 When the Message “Need to Replace XXXXX.” Appears

When it is almost time to replace a unit within this copier, a message like the one shown below appears in the touch panel.

When the message appears, replace the unit according to your maintenance agreement.

In the example screen shown below, the imaging unit should be replaced soon.

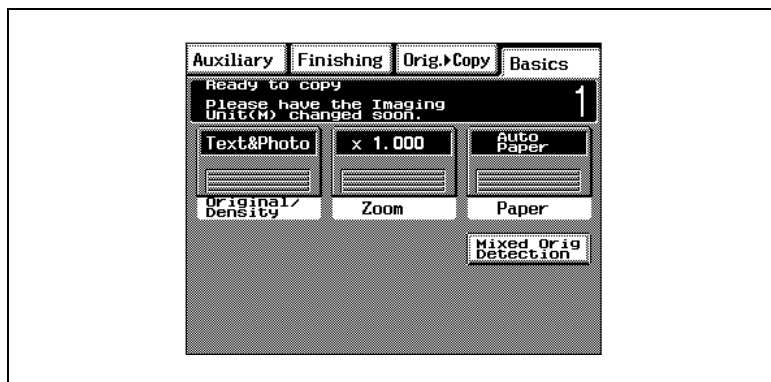

Displayed Messages

- Advance warning message
When it is almost time to replace a unit, the message “Please have the XXXXX changed soon.” appears in the touch panel. Prepare the new unit and replace it as soon as possible.
- Replacement warning message
After the advance warning message has appeared, about 1,000 copies can be made before the copier stops operating. (The number of copies depends on the selected copy settings and the unit.) In addition, the message “Need to Replace XXXXX.” appears in the touch panel followed by instructions for replacing the unit. Replace the unit according to the instructions that appear.



...

Disposing of Used Parts

Dispose of used units according to your local regulations, or contact your technical representative.

9.9 Other Messages

Message	Cause	Remedy
Malfunction detected. Call your Technical Rep. and provide code:	The copier malfunctioned and is unable to make copies.	Inform your technical representative of the code displayed on the touch panel.
Please input your 4-digit Access# and press the Access key.	Access codes have been specified. Copies cannot be made unless a specified access code is entered.	Enter your access code. p. 2-28
Replenish paper.	The indicated drawer has ran out of paper.	Load paper into the indicated drawer. p. 9-1
Please add Toner. Open the Toner Supply Door and follow the Operator's Manual.	Since the toner for the indicated color has run out, the copier is unable to make copies.	Refill the toner. p. 9-6
Please add XXXX Toner.	The toner for the indicated color is about to run out.	Refill the toner. p. 9-6
Please install the correct Imaging Unit correctly, and close all doors.	The indicated imaging unit is not installed correctly.	Correctly install the imaging unit. Otherwise, contact your technical representative.
Please insert the Image Transfer Belt Unit and close all doors.	The image transfer belt unit is not installed correctly.	Contact your technical representative.
Please insert Waste Toner Bottle and close all doors.	The waste toner bottle is not installed correctly.	Correctly install the waste toner bottle. Otherwise, contact your technical representative.
Please insert the Fusing Unit and Fusing Web Unit and Oil Coating Unit and close all doors.	The fusing unit, fusing web unit, and oil-coating unit are not installed correctly.	Correctly install the fusing unit, fusing web unit, and oil-coating unit. Otherwise, contact your technical representative.
Close → Section properly.	Since a copier door or cover is open or an option is not installed correctly, the copier is unable to make copies.	Make sure that all doors and covers are closed and that all options are installed correctly.
Replace Staple Cartridge X.	The staples have run out.	Replace the staple cartridge. p. 9-11
Misfeed detected. Remove misfeed at O.	Since a paper misfeed occurred, the copier is unable to make copies.	Clear the paper misfeed. p. 9-16
The Exit Tray has reached its capacity. Please remove all pages from -> section tray.	Since the maximum amount of copies for the indicated finisher tray has been exceeded, the copier is unable to make copies.	Remove all copies from the indicated tray.

Message	Cause	Remedy
Sorter has reached its capacity. Remove all pages from bins before proceeding. X- X bin	The indicated bin of the 10-mailbin sorter has reached its maximum capacity, so the copy operation cannot continue.	Remove all copies from the indicated bin.
Original's size cannot be detected. Reselect the paper size.	<ul style="list-style-type: none"> The document is not positioned correctly. A document with an unspecified size or with a size too small to be detected is loaded. 	<ul style="list-style-type: none"> Position the document correctly. Select the correct paper size.
The following Max.# of sets for sorting. 10	When copying while sorting, a number of 11 or higher was specified for the number of copies.	When copying while sorting, specify a number of 10 or less for the number of copies.
Matching paper size is not available. Reselect paper size.	Paper of a suitable size is not loaded in a paper drawer.	Either select a different copy size or manually feed paper of a suitable size.
Re-insert the following # of originals:	After clearing a paper misfeed, it is necessary to reload the documents that have already been fed through the document feeder.	Load the indicated document pages into the document feeder.
Original left on the Glass.	The document was left on the original glass.	Remove the document from the original glass.
This mode cannot be selected with the XXXXXX.	Functions that cannot be used together are selected.	Make copies using only one of the functions.
Image data caused a memory overflow. Your job has been canceled. A new memory set up is recommended. Please Select a Compress in Compress Mode.	There is not enough memory to scan.	On the [Orig. ►Copy] screen, touch [Compress Mode], and then touch [Compress] to turn it on before trying to make copies. p. 6-4 If the same message appears again, install the optional memory.
Your account has reached its maximum allowance.	The limit on the number of copies that can be made has been reached.	Contact your administrator. p. 8-11

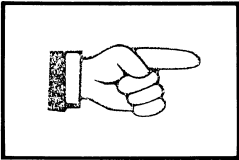
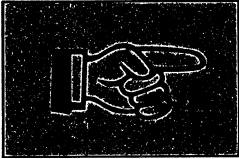
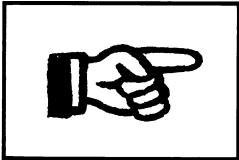
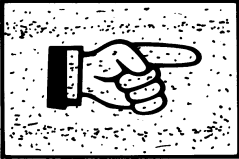

10 Troubleshooting

10.1 When Incorrect Copies are Produced

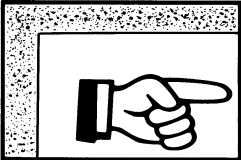
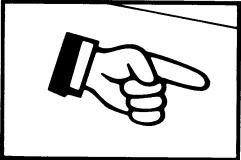
Symptom	Possible Cause	Remedy
<p>The image is too light.</p> 	<p>The copy density is set too light.</p> <p>The paper is damp.</p>	<p>Select a darker copy density setting. Refer to p. 5-20.</p> <p>Replace the paper. Refer to p. 9-1.</p>
<p>The image is too dark.</p> 	<p>The copy density is set too dark.</p> <p>The document is not pressed tight enough against the original glass.</p>	<p>Select a lighter copy density setting. Refer to p. 5-20.</p> <p>Position the document so that it is pressed tightly against the original glass. Refer to p. 4-10.</p>
<p>The copy is blurry.</p> 	<p>The paper is damp.</p> <p>The document is not flat against the original glass.</p>	<p>Replace the paper. Refer to p. 9-1.</p> <p>Position the document flat against the original glass. Refer to p. 4-10.</p>
<p>There are dark specks or spots throughout the entire copy.</p> 	<p>The original glass is dirty.</p> <p>Either the document pad or the document transfer belt is dirty.</p> <p>The original is very thin or highly transparent.</p> <p>If a thin double-sided document is being copied, the information on the back side may be reproduced in the copy.</p>	<p>Wipe the glass with a soft dry cloth. Refer to p. 11-8.</p> <p>Clean the document pad or the document transfer belt with a soft cloth dampened with mild detergent. Refer to p. 11-9.</p> <p>Place a blank sheet of paper over the document. Refer to p. 4-12.</p> <p>Select a darker setting for the background copy density. Refer to p. 5-20.</p>

Symptom	Possible Cause	Remedy
<p>The edge of the copy is dirty.</p> 	Either the document pad or the document transfer belt is dirty.	Clean the document pad or the document transfer belt with a soft cloth dampened with mild detergent. Refer to p. 11-9.
	The selected copy paper size is larger than the document (with Zoom set to "x 1.000").	Select a copy paper size that is the same as the size of the document. Refer to p. 5-4. Otherwise, set Zoom to "Auto Size" to enlarge the copy to the selected paper size. Refer to p. 5-14.
	The orientation of the document is different from the orientation of the copy (with Zoom set to "x 1.000").	Select a copy paper size that is the same as the size of the document. Otherwise, select a copy orientation that is the same as the orientation of the document.
	The copy was reduced to a size smaller than the copy paper (a Custom Zoom setting was selected).	Select a zoom ratio that adjusts the document size to the selected paper size. Refer to p. 5-15. Otherwise, set Zoom to "Auto Size" to reduce the copy to the selected paper size. Refer to p. 5-14.
<p>The image is not aligned properly on the paper.</p> 	The document is not positioned correctly.	Correctly position the document against the document width scale. Refer to p. 4-11. Correctly load the document into the duplexing document feeder, and then slide the document guides against it. Refer to p. 4-4.
	The document is not positioned correctly in the duplexing document feeder.	Open the duplexing document feeder, and correctly position the document against the document width scale. Refer to p. 4-11.
	The original glass is dirty (while using the duplexing document feeder).	Wipe the glass with a soft dry cloth. Refer to p. 11-8.
	The document guides are not positioned along the edges of the paper.	Slide the document guides against the edges of the paper.
	Curled paper was loaded into the paper drawer.	Flatten the paper before loading it.

10.2 When the Copier Is Not Operating Correctly

Symptom	Cause	Remedy
Nothing appears on the touch panel.	If only the indicator on the Start key is lit, the copier is in Energy Save mode.	Press any key to cancel Energy Saver mode. Refer to p. 2-26.
	The contrast control knob for the touch panel has been set either too light or too dark.	While looking at the touch panel, adjust its contrast control knob. Refer to p. 2-20.
	The scanner power cord or the interface cable are disconnected.	Re-connect the scanner power cord and the interface cable.
The indicator on the Start key does not light up in green.	An access code has not been entered. 	Enter your access code according to the instructions in "To enter an access code". Refer to p. 2-28.
Even though the Start Key is pressed, no copies are made	The copier is malfunctioning	Follow any messages that appear on the touch panel.
	The copier is still warming up after just being turned on.	The copier takes about 5 minutes to warm up after it is turned on.
Keys on the control panel do not respond.	If the indicator on the Interrupt key is lit, the copier is in Interrupt mode. 	Press the Interrupt key to cancel the mode. Refer to p. 2-27.
The copier cannot be turned on.	The power supply cord may have been unplugged from the electrical outlet.	Plug the power supply cord into an electrical outlet.
	The room's circuit breaker is tripped.	Close the room's circuit breaker.

11 Appendix

11.1 Specifications

Copier KM-C1530

Specification	KM-C1530
Type	Desktop
Platen	Stationary
Photo conductor	OPC
Copying system	Digital Full-Color Copying
Developing system	2- component system
Fusing system	Belt-fixing
Resolution	Scanning: 600 dpi; Printing: 600 dpi x 1800 dpi/256 variations
Document	<ul style="list-style-type: none"> Types: Sheets, books, and other three-dimensional objects Size: Maximum 11 x 17 in. Weight: 4.4 lbs.
Paper types	Standard paper (17 to 24 lbs.), thick paper 1 ^{*1} (24-1/4 to 43-1/4 lbs.), thick paper 2 ^{*2} (43-1/2 to 55-1/2 lbs.), overhead projector transparencies ^{*1} , postcards ^{*1} ^{*1} : Can only be fed through the 1st drawer or the manual bypass tray. ^{*2} : Can only be fed through the manual bypass tray.
Paper sizes	<ul style="list-style-type: none"> 1st drawer 12-1/4 x 18L to 5-1/2 x 8-1/2L (Width: 3-9/16 to 12-1/4 in., Length: 5-1/2 to 18 in.) 2nd drawer 11 x 14L, 11 x 17L, LegalL, LetterC, LetterL, 8 x 13L, 8-1/4 x 13L, 8-1/2 x 13L, 8-3/4 x 13L, 10-1/2 x 8C Manual bypass tray (Width: 3-9/16 to 12-1/4 in., Length: 5-1/2 to 18 in.)
Paper sizes	<ul style="list-style-type: none"> 1st drawer 250 sheets (when using 21-1/4 lbs. standard paper) 2nd drawer 500 sheets (when using 21-1/4 lbs. standard paper) Manual bypass tray 1 sheet (standard paper, thick paper 1, thick paper 2, overhead projector transparency, or postcard)
Warm-up time	Less than 5 minutes at room temperature (68°F/20°C)
Lost image	Leading edge: 1/4 in. (5 mm) Trailing edge: 1/8 in. (3 mm) Rear edge: 1/8 in. (3 mm) Font edge: 1/8 in. (3 mm)

Specification	KM-C1530
First copy	Full color: Less than 15 seconds Black: Less than 12 seconds (in full-size mode using the 1st drawer)
Copy speed	Full color/Black: LetterL: 14 sheets/min. LetterC: 15 sheets/min. 11 × 17L: 10 sheets/min. InvoiceL: 15 sheets/min. InvoiceC: 15 sheets/min.
Magnification ratios	<ul style="list-style-type: none"> • Full size: ×1.000 • Enlargement ratios: × 1.214, × 1.294, × 1.545, × 2.000 • Reduction ratios: × 0.785, × 0.733, × 0.647, × 0.500, minimal (× 0.950) • Zoom ratios: × 0.500 to × 4.000 (0.001 increments), and 3 memory zoom ratios
Multiple copies	1–100 sheets
Density control	Automatic and manual
Memory	128MB × 2 (recommended)
Power Requirements	110/120/127 V; 15 A, 60 Hz,
Power consumption	Less than 1.5 kW
Dimensions	Scanner: 24-1/2 in. (width) × 27-3/4 in. (depth) × 6 in. (height) Printer: 23-1/2 in. (width) × 28-3/4 in. (depth) × 20-1/2 in. (height)
Space requirements	25-1/4 in. (width) × 31 in. (depth) (with the scanner rack installed)
Weight	Scanner: 57-1/4 lbs. Printer: 187-1/2 lbs. (with all four imaging units installed)

Duplexing Document Feeder RADF-11

Specification	
Document feed methods	<ul style="list-style-type: none"> • Standard paper: Single-sided and double-sided documents • "Mixed Orig Detection" function: Various sizes of single-sided and double-sided documents • Single-sheet feeding: Single-sided documents
Paper types	Single-sided: 13-1/4 to 29-1/4 lbs. Double-sided, Mixed Orig Detection: 16 to 24 lbs. Single-sheet feeding: 9-1/4 to 53-1/4 lbs.
Document sizes	Single-sided/double-sided documents: 11 x 17L to Invoice Mixed document sizes: 11 x 17L to 8-1/2 x 11
Capacity of document feeder	Single-sided/double-sided documents: Less than 50 sheets (21-1/4 lbs.) Mixed document sizes: Less than 50 sheets (21-1/4 lbs.)
Copy productivity (with 1-to-1 copying)	Full color: 14 (LetterC) sheets/min. When optional memory is installed Full color: 15 (LetterC) sheets/min. Black: 15 (LetterC) sheets/min.
Power source	Supplied from copier
Power consumption	Less than 60 W
Dimensions	23-3/4 in. (width) x 19-3/4 in. (depth) x 4-1/4 in. (height) (not including the document output tray)
Weight	Less than 26-1/2 lbs.

500-sheet Paper Feed Unit ST-530

Specification	
Paper types	Standard paper (17 to 24 lbs.)
Paper sizes	11 x 14L, 11 x 17L, LegalL, LetterC, LetterL, 8 x 13L, 8-1/4 x 13L, 8-1/2 x 13L, 8-3/4 x 13L, 10-1/2 x 8C
Capacity	500 sheets (21-1/4 lbs.)
Power source	Supplied from copier
Power consumption	Less than 9 W
Dimensions	21 in. (width) x 22-1/4 in. (depth) x 5-1/2 in. (height)
Weight	About 18-3/4 lbs.

Large-capacity Cabinet ST-2500

Specification	
Paper types	Standard paper (17 to 24 lbs.)
Paper sizes	LetterC
Capacity	2500 sheets (21-1/4 lbs.)
Power source	Supplied from copier
Power consumption	Less than 45 W
Dimensions	21 in. (width) × 22-1/4 in. (depth) × 11-1/4 in. (height)
Weight	About 36-3/4 lbs.

Duplex Unit AD-35

Specification	
Paper types	Standard paper (17 to 24 lbs.)
Paper sizes	11 × 17L to 5-1/2 × 8-1/2L
Power source	Supplied from copier
Power consumption	Less than 17 W
Dimensions	5-1/2 in. (width) × 17-1/4 in. (depth) × 14-1/4 in. (height)
Weight	About 6-3/4 lbs.

10-Mailbin Sorter AS-M4110

Specification	
No. of bins	10
Settings	Non-sort, Sort, Group
Paper types	<ul style="list-style-type: none"> • “Non-sort” setting: Standard paper (17 to 24 lbs.), thick paper (24-1/4 to 55-1/2 lbs.), overhead projector transparencies, postcards • “Sort/Group” setting: Standard paper (17 to 24 lbs.)
Paper sizes	<ul style="list-style-type: none"> • “Non-sort” setting: 12-1/4 x 18L to 5-1/2 x 8-1/2L • “Sort/Group” setting: 11 x 17L to 5-1/2 x 8-1/2
Capacity of bins	<ul style="list-style-type: none"> • “Non-sort” setting: Standard paper (21-1/4 lbs.): Maximum 200 sheets Thick paper (24-1/4 to 55-1/2 lbs.): Maximum 20 sheets Overhead projector transparencies: Maximum 1 sheets Postcards: Maximum 20 sheets • “Sort/Group” setting: Standard paper (21-1/4 lbs.): Maximum 200 sheets/bin Total: 2,000 sheets
Power source	Supplied from copier
Power consumption	Less than 32 W
Dimensions	21-3/4 in. (width) x 20-1/4 in. (depth) x 34-1/2 in. (height)
Weight	<ul style="list-style-type: none"> • Main unit: about 64 lbs. • Horizontal transport unit: 8-3/4 lbs.

Finisher F-8430

Specification	
No. of bins	Upper paper output tray, Lower paper output tray
Settings	<ul style="list-style-type: none"> • When copying: Non-sort • When printing from the computer: Non-sort, Sort, Group, Staple, Punch
Paper types	<ul style="list-style-type: none"> • Upper paper output tray “Non-sort” setting: Standard paper (17 to 24 lbs.), thick paper (24-1/4 to 55-1/2 lbs.), overhead projector transparencies, postcards “Punch” setting: Standard paper (17 to 24 lbs.) • Lower paper output tray “Sort”/“Group”/“Staple”/“Punch” settings: Standard paper (17 to 24 lbs.)
Paper sizes	<ul style="list-style-type: none"> • Upper paper output tray 12-1/4 x 18L to 5-1/2 x 8-1/2L • Lower paper output tray 11 x 17L to Letter
Capacity of bins	<ul style="list-style-type: none"> • Upper paper output tray Standard paper (21-1/4 lbs.): Maximum 250 sheets (12-1/4 x 18L to 5-1/2 x 8-1/2) Thick paper (21-1/4 to 55-1/2 lbs.): Maximum 20 sheets Overhead projector transparencies: Maximum 1 sheets Postcards: Maximum 20 sheets • Lower paper output tray Standard paper (21-1/4 lbs.): LetterL or smaller maximum 3,000 sheets; LegalL or larger maximum 1,500 sheets
“Staple” setting	Paper size: 11 x 17L to Letter Binding: 2 to 50 sheets (2 to 20 sheets of densely printed paper)
“Punch” setting	Paper size: 11 x 17L to Letter Holes punching: 2 or 3 holes
Power source	Supplied from copier
Power consumption	Less than 63 W
Dimensions	21-1/4 in. (width) x 24-3/4 in. (depth) x 38-1/2 in. (height)
Weight	About 86-1/2 lbs.
Accessories	2 staple cartridges (5,000 staples)

Finisher F-8110

Specification	
No. of bins	Upper paper output tray, Lower paper output tray
Settings	<ul style="list-style-type: none"> When copying: Non-sort When printing from the computer: Non-sort, Sort, Group, Staple
Paper types	<ul style="list-style-type: none"> Upper paper output tray "Non-sort" setting: Standard paper (17 to 24 lbs.), thick paper (24-1/4 to 55-1/2), overhead projector transparencies, postcards Lower paper output tray "Sort"/"Group" settings: Standard paper (17 to 24 lbs.) "Staple" setting: Standard paper (17 to 21-1/4 lbs.)
Paper sizes	<ul style="list-style-type: none"> Upper paper output tray 12-1/4 x 18L to 5-1/2 x 8-1/2L Lower paper output tray 11 x 17L to Letter
Capacity of bins	<ul style="list-style-type: none"> Upper paper output tray Standard paper (21-1/4 lbs.): Maximum 250 sheets (12-1/4 x 18L to 5-1/2 x 8-1/2L) Thick paper: Maximum 20 sheets Overhead projector transparencies: Maximum 1 sheets Postcards: Maximum 20 sheets Lower paper output tray Standard paper (21-1/4 lbs.): LetterL or smaller maximum 1,000 sheets; LegalL or larger maximum 500 sheets
"Staple" setting	<p>Paper size: 11 x 17L to Letter</p> <p>Binding: 2 to 30 sheets</p> <ul style="list-style-type: none"> 2 to 20 sheets when using Hammermill Laser Print New Radiant White 90 paper 2 to 20 sheets of densely printed paper
Power source	Supplied from copier
Power consumption	Less than 63 W
Dimensions	21-1/4 in. (width) x 24-3/4 in. (depth) x 38-1/2 in. (height)
Weight	About 78-1/4 lbs.
Accessories	1 staple cartridge (3,000 staples)

11.2 Care of the Copier

Cleaning



WARNING

For safety purposes, **ALWAYS** remove the power plug from the outlet when performing cleaning operations.

Housing cover

- Clean the surface of the housing cover by wiping it with a soft cloth dampened with a mild household detergent.

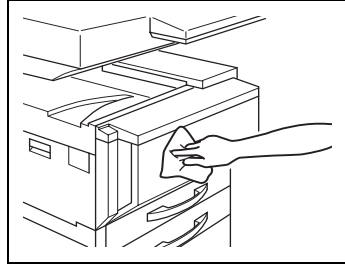

Original glass

- Clean the original glass by wiping it with a soft, dry cloth.

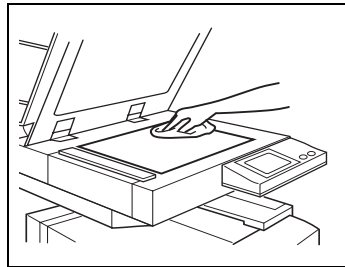

Operation panel

- Clean the operation panel by wiping it with a soft, dry cloth.

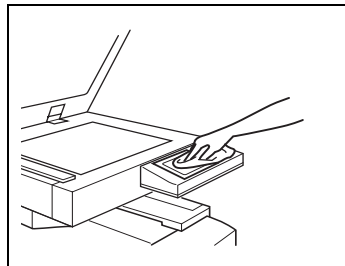

⚠ WARNING

Incorrectly cleaning the operation panel or the touch panel may damage them.

- Never use mild household detergent or glass cleaner to clean the operation panel or touch panel.

Document transfer belt

- 1 Clean the document transfer belt by wiping it with a soft cloth dampened with a mild household detergent.

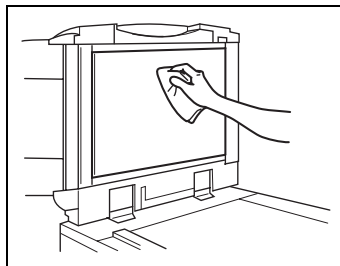

- 2 Carefully slide the belt to the left to expose a hidden area of the belt.

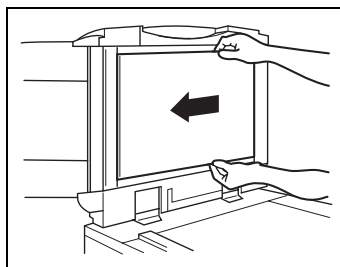

- 3 Clean the newly exposed surface of the belt by wiping it with a soft cloth dampened with a mild household detergent (as in step 1).
- 4 Repeat the above steps until the entire surface of the document transfer belt has been wiped clean.

Function combination code keys

Code	Explanation
○	The functions can be combined.
●	The functions cannot be combined. (The function set first takes precedence.)
×	The functions cannot be combined. (The function set last takes precedence.)
A	A warning appears if manual feeding was set by touching [Paper] in the Basic screen, then touching [Bypass]. If paper was inserted into the manual bypass tray, the function set first is cancelled.
B	These settings cannot be selected at the same time if overhead projector transparencies, thick paper or postcards are set as the paper type. The setting selected first takes precedence.
C	The "Mixed Orig Detection" function, "Auto Paper" Paper setting, and "Hole-Punch" setting cannot all be set at the same time. The first two settings selected take precedence.
D	If paper is loaded into the manual bypass tray, the "OHP Interleaving" function is cancelled. If there is no paper in the manual bypass tray, manual feeding of the paper through the manual bypass tray cannot be set.
E	If paper is loaded into the manual bypass tray, the "OHP Interleaving" function cannot be set. If there is no paper in the manual bypass tray, manual feeding of paper through the manual bypass tray is cancelled.
F	The "Sort" setting is automatically changed.
G	When making "Single-sided ►Double-sided" copies while manually placing the documents on the original glass, the copy job cannot be interrupted by pressing the [Interrupt] key.

* 1: The "Staple" and "Hole-Punch" settings are only available if both the finisher and printer controller are installed.

11.4 Paper Size and Zoom Ratio Tables

Paper sizes

Paper format	Metric size	English size
A3Wide	311 mm × 457 mm	12-1/4 in. × 18 in.
A3	297 mm × 420 mm	11-3/4 in. × 16-1/2 in.
A4	210 mm × 297 mm	8-1/4 in. × 11-3/4 in.
A5	148 mm × 210 mm	5-3/4 in. × 8-1/4 in.
A6	105 mm × 148 mm	4-1/4 in. × 5-3/4 in.
B4	257 mm × 364 mm	10 in. × 14-1/4 in.
B5	182 mm × 257 mm	7-1/4 in. × 10 in.
B6	128 mm × 182 mm	5 in. × 7-1/4 in.
Postcard	100 mm × 148 mm	4 in. × 5-3/4 in.

Paper format		English size	Metric size
Ledger		11 in. × 17 in.	279 mm × 432 mm
11 in. × 14 in.		11 in. × 14 in.	279 mm × 356 mm
Computer		10-1/8 in. × 14 in.	257 mm × 356 mm
10 in. × 14 in.		10 in. × 14 in.	254 mm × 356 mm
9-1/4 in. × 14 in.		9-1/4 in. × 14 in.	236 mm × 356 mm
Legal		8-1/2 in. × 14 in.	216 mm × 356 mm
Foolscap	Government Legal	8-1/2 in. × 13 in.	216 mm × 330 mm
Foolscap		8 in. × 13 in.	203 mm × 330 mm
Foolscap		8-2/3 in. × 13 in.	220 mm × 330 mm
Foolscap	Folio	8-1/4 in. × 13 in.	210 mm × 330 mm
8-1/4 in. × 11-3/4 in.		8-1/4 in. × 11-3/4 in.	210 mm × 301 mm
Letter		8-1/2 in. × 11 in.	216 mm × 279 mm
Government Letter		8 in. × 10-1/2 in.	203 mm × 267 mm
Quarto		8 in. × 10 in.	203 mm × 254 mm
Statement	Invoice	5-1/2 in. × 8-1/2 in.	140 mm × 216 mm

Zoom ratios

Metric sizes		
Document size	Desired paper size	Zoom ratio
A3 297mm x 420mm 11-3/4 in. x 16-1/2 in.	A4	x 0.707
	A5	x 0.500
	B4	x 0.866
	B5	x 0.610
A4 210mm x 297mm 8-1/4 in. x 11-3/4 in.	A5	x 0.707
	A6	x 0.500
	B5	x 0.866
	B6	x 0.610
	A3	x 1.414
A5 148mm x 210mm 5-3/4 in. x 8-1/4 in.	B4	x 1.224
	A6	x 0.707
	B6	x 0.866
	A4	x 1.414
	A3	x 2.000
A6 105mm x 148mm 4-1/4 in. x 5-3/4 in.	B4	x 1.733
	B5	x 1.224
	A4	x 2.000
	A5	x 1.414
	B5	x 1.733
B4 257mm x 364mm 10 in. x 14-1/4 in.	B6	x 1.224
	A4	x 0.816
	A5	x 0.577
	B5	x 0.707
	B6	x 0.500
	A3	x 1.154

Metric sizes		
Document size	Desired paper size	Zoom ratio
B5 182mm x 257mm 7-1/4 in. x 10 in.	A5	x 0.816
	A6	x 0.577
	B6	x 0.707
	A3	x 1.640
	A4	x 1.154
	B4	x 1.414
B6 128mm x 182mm 5 in. x 7-1/4 in.	A6	x 0.816
	A4	x 1.640
	A5	x 1.154
	B4	x 2.000
	B5	x 1.414

English sizes		
Document size	Desired paper size	Zoom ratio
11 in. x 17 in. 279.4 mm x 431.8 mm	11 in. x 14 in.	x 0.823
	Legal	x 0.722
	Foolscap	x 0.764
	Letter	x 0.647
	Invoice	x 0.500
11 in. x 15 in. 279.4 mm x 381 mm	11 in. x 14 in.	x 0.933
	Legal	x 0.772
	Foolscap	x 0.772
	Letter	x 0.733
	Invoice	x 0.500
11 in. x 14 in. 279.4 mm x 355.6 mm	Legal	x 0.772
	Foolscap	x 0.772
	Letter	x 0.772
	Invoice	x 0.500
Legal 11 in. x 17 in. 215.9 mm x 355.6 mm	Foolscap	x 0.928
	Letter	x 0.785
	Invoice	x 0.607
	11 in. x 17 in.	x 1.214

English sizes		
Document size	Desired paper size	Zoom ratio
Foolscap 8-1/2 in. x 13 in. 215.9 mm x 330.2 mm	Letter	x 0.846
	Invoice	x 0.647
	11 in. x 17 in.	x 1.294
	11 in. x 14 in.	x 1.076
Letter 8-1/2 in. x 11 in. 215.9 mm x 279.4 mm	Invoice	x 0.647
	11 in. x 17 in.	x 1.294
	11 in. x 14 in.	x 1.272
Invoice 5-1/2 in. x 8-1/2 in. 139.7 mm x 215.9 mm	11 in. x 17 in.	x 2.000
	11 in. x 14 in.	x 1.647
	Legal	x 1.545
	Foolscap	x 1.529
	Letter	x 1.294

- * Zoom ratio = Copy paper size / Document size
 1 in. (Inch) = 25.4 mm
 1 mm = 0.0394 in. (inch)

Numerics

10-Mailbin sorter	2-7, 2-16, 11-5
12-1/4 x 18-size paper	4-14
1st drawer	2-11, 5-5
2in1 copying	6-4
2nd drawer	2-11

A

Access codes	2-28
Registering	8-3
Accounts	
Changing numbers registered	8-4
Limiting number of copies	8-11
Limiting type of copies	8-9
Resetting counters for all	8-6
Resetting counters for one	8-8
Viewing counters	8-7
Administrator Mode	8-1
Auto panel reset	2-25
Auto paper source change feature	2-27
“Auto Size” zoom setting	5-14

B

Background	5-20
Basic operations	5-1
“Book Erase” function	6-5
Books	
Copying	6-5
Positioning	4-13

C

Cancelling settings	2-21, 2-25
Care of the copier	11-8
“Color Adjustment” function	6-23
Brightness	6-26
Color balance	6-28
Contrast	6-27
Density	6-29

Hue	6-25
Saturation	6-25
Sharpness	6-27
Control panel	2-11
Access key	2-21, 2-28
Auto Color, Full Color, and Black keys	2-20
C (clear) key	2-21
Copy key	2-21
Energy Saver key	2-21
Interrupt key	2-21, 2-27
Job Recall key	2-20
Keypad	2-21
Panel Reset key	2-21, 2-25
Scan key	2-21
Start key	2-21
Stop key	2-21
Touch panel	2-20, 2-22
Touch panel contrast-adjusting dial	2-20
Utility key	2-20
Copier	11-1
Copy desk	2-8
Copy output tray	2-11
Copy table	2-8
“Copy Track” function	8-1
Copying	
Books	6-5
Counters	
Viewing for the copier	7-2
Viewing the meter counts	7-3
Custom zoom setting	5-14

D

Default settings	
Changing	7-1
List of	2-30
Delayed copy jobs	2-26
Deleting a stored copy job	7-5
Density	5-20
“Disable Sleep Mode” function	8-15
Document scale	2-11
Document type	5-19
Documents of mixed sizes	4-5, 6-17

Double-sided documents and copies	6-4
Duplex unit	2-7, 2-15, 11-4
Duplexing document feeder	2-6, 2-14, 4-4, 11-3

E

Energy Saver mode	2-26
“Erase” function	8-18
“Expert User’s Mode” function	8-20
“Color Shift Correction” parameter	8-23
“PRT Area (Dup. Left Margin)” parameter	8-31
“PRT Area (Left Margin)” parameter	8-29
“PRT Area (Top Margin)” parameter	8-27
“Stabilizer” parameter	8-26
“Thick Paper and OHP Film Image Density” parameter	8-22
“Thin Orig.” parameter	8-33

F

Finisher	2-7, 2-17, 11-6, 11-7
Finishing	6-8
“Group” setting	6-11
“Non-Sort” setting	6-10
Selecting	6-11
“Sort” setting	6-10
“Frame Erase” function	6-19
Front door	2-11
“Full size” zoom setting	5-14
Function combination	11-10
Fusing unit	2-13
Fusing web unit	2-13

G

“Gradation Adjust” function	8-13
-----------------------------------	------

H

Hole punching	6-15
Punched hole position	6-15
Types of hole punching	6-15

I

“Image Repeat” function	6-35
Image transfer belt unit	2-13
Image transfer roller unit	2-13
Imaging unit	2-13
Interrupting a copy job	2-21, 2-27, 5-22

J

“Job Memory Input” function	7-4
-----------------------------------	-----

L

Large-capacity cabinet	2-8, 2-19, 11-4
LED cleaning tool	2-13
Left-side door	2-11
Loading paper	
1st drawer	3-7
2nd drawer	3-13
Large-capacity cabinet	3-15
Manual bypass tray	3-17
Lower right-side door	2-11

M

Making copies	6-1
Onto paper from the 1st drawer	5-5
Manual bypass tray	2-11
Manual feeding	5-7
Documents	4-1, 4-11, 4-12, 4-13, 4-14
Overhead projector transparencies	5-9
Paper	5-7
Postcards	5-11
Thick paper	5-12
Memory	2-9
Messages	9-44
“Multifunction detected.”	9-42
“Need to Replace XXXXX.”	9-43
“Meter Count” function	7-2
“Minimal” zoom setting	5-14
“Mirror Image” function	6-21

“Mixed Orig Detection” function	6-17
Multipurpose paper drawer	5-5
Multi-sheet feeding	4-1, 4-4, 4-5

O

OHP film	3-4, 4-12
“OHP Interleaving” function	6-30
Oil-coating unit	2-13
Options	
10-Mailbin sorter	2-7, 2-16
Duplex unit	2-7, 2-15
Duplexing document feeder	2-6, 2-14
Finisher	2-7, 2-17
Large-capacity cabinet	2-8, 2-19
Paper feed unit	2-8, 2-18
Printer controller Fiery X3e	2-9
Original cover (optional)	2-6, 2-11
Original glass	2-11, 4-10
Original Image Type setting	5-18
Overhead projector transparencies	3-4, 4-12
Ozone filter	2-13

P

Paper feed unit	2-8, 2-18, 11-3
Paper feeding path	1-11
Paper misfeed clearing	9-16
10-Mailbin sorter	9-34
Copier	9-24
Duplex unit	9-21
Duplexing document feeder	9-28
Finisher	9-30
Manual bypass tray	9-19
Paper feed unit	9-22
Paper orientation	1-12
Paper replenishing	9-1
Paper sizes	3-2, 11-13
Paper source	5-4
Paper type dial	5-6
Paper types	3-1
“Postcard” function	6-33

Power switch	2-11, 2-29
Preset zoom ratios	5-14
Printer	2-6
Printer controller Fiery X3e	2-9, 2-19
Printing	2-28

R

Recalling a stored copy job	7-6
Resetting the copier	7-1
Right-side door	2-11
Right-side door release lever	2-11

S

Scanner	2-6
“Scanner Addr. Input” function	8-34
Scanner rack (optional)	2-8, 11-2
Scanning	2-28
Single- or double-sided documents and copies	6-4
Single-sheet feeding	4-1, 4-7, 4-9
Sleep mode	2-26
Disabling	8-15
Specifications	11-1
Staple binding	6-12
Staple position	6-13
Types of stapling	6-12
Staple cartridge replacement	9-11
Staple jam clearing	9-37
Storing a copy job	7-4
Supervising copier use	8-1

T

Thin paper	4-9
Toner hopper lid	2-12
Toner refilling	9-6
Toner supply door	2-11
Troubleshooting	10-1
Turning the copier on and off	2-29

U

Upper right-side door	2-12
“User’s Choice” function	7-8
“1st Drawer Paper Select” parameter	7-18
“2in1 copy zoom” parameter	7-10
“ACS Determination level Adjust.” parameter	7-12
“Auto Panel Reset” parameter	7-15
“Confirmation Beep” parameter	7-13
“Energy Save Mode” parameter	7-16
“Intelligent Sorting” parameter	7-11
“Language selected” parameter	7-9
“Mail Bin Assignment” parameter	7-14
“Sleep Mode” parameter	7-17
Utility mode	7-1

W

Waste toner bottle	2-13
--------------------------	------

X

“X/Y Zoom” function	6-32
---------------------------	------

Z

Zoom ratio	
Recalling a recorded zoom ratio	5-17
Recording a zoom ratio	5-16
Zoom ratio settings	5-14, 11-13

*** For best copy results and machine performance, we recommend that you use only KYOCERA MITA original supplies for your KYOCERA MITA copier.**

KYOCERA MITA AMERICA, INC.

Headquarters:

225 Sand Road, P.O. Box 40008
Fairfield, New Jersey 07004-0008
TEL : (973) 808-8444
FAX : (973) 882-6000

New York Show Room:

149 West 51 st street,
New York, NY 10019
TEL : (212) 554-2679
FAX : (212) 554-2625

Northeastern Region:

225 Sand Road, P.O. Box 40008
Fairfield, New Jersey 07004-0008
TEL : (973) 808-8444
FAX : (973) 882-4401

Midwestern Region:

201 Hansen Court Suite 119
Wood Dale, Illinois 60191
TEL : (630) 238-9982
FAX : (630) 238-9487

Western Region:

14101 Alton Parkway, P.O.Box 57006,
Irvine, California 92618-7006
TEL : (949) 457-9000
FAX : (949) 457-9119

Southeastern Region:

1500 Oakbrook Drive, Norcross,
Georgia 30093
TEL : (770) 729-9786
FAX : (770) 729-9873

Southwestern Region:

2825 West Story Road, Irving,
Texas 75038-5299
TEL : (972) 550-8987
FAX : (972) 570-4704

Dallas Parts Distribution Center & National Training Center:

2825 West Story Road, Irving,
Texas 75038-5299
TEL : (972) 659-0055
FAX : (972) 570-5816

KYOCERA MITA CANADA, LTD.

6120 Kestrel Road,
Mississauga, Ontario L5T 1S8
TEL : (905) 670-4425
FAX : (905) 670-8116

KYOCERA MITA MEXICO, S.A. DE C.V.

Av. 16 de Septiembre #407
Col. Santa Inés, Delegación Azcapotzalco
México, D.F. C.P. 02130
TEL : 3-83-27-41
FAX : 3-83-78-04



KYOCERA is a trademark of Kyocera Corporation

mita is registered trademark of KYOCERA MITA CORPORATION

Download from www.Somanuals.com. All Manuals Search And Download.

2001.4
5F980011B

Free Manuals Download Website

<http://myh66.com>

<http://usermanuals.us>

<http://www.somanuals.com>

<http://www.4manuals.cc>

<http://www.manual-lib.com>

<http://www.404manual.com>

<http://www.luxmanual.com>

<http://aubethermostatmanual.com>

Golf course search by state

<http://golfingnear.com>

Email search by domain

<http://emailbydomain.com>

Auto manuals search

<http://auto.somanuals.com>

TV manuals search

<http://tv.somanuals.com>