

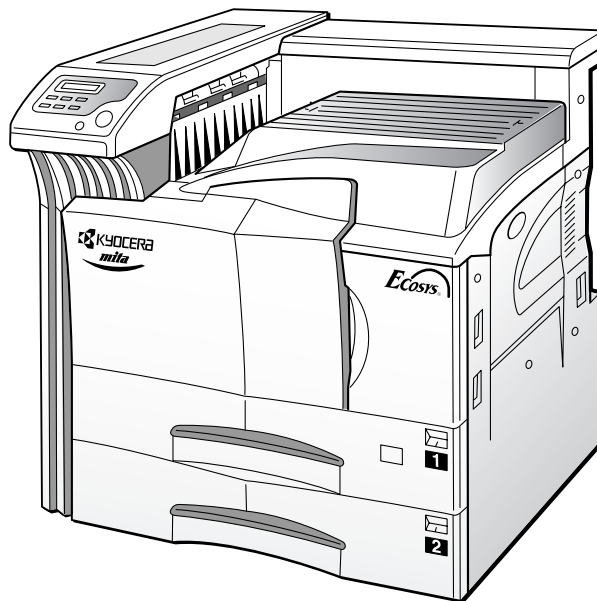

# FS-9100DN FS-9500DN

## Operation Guide



Please read this Operation Guide before using the printer.  
Keep it close to the printer for easy reference.



**Please read the Operation Guide before using the printer.  
Keep it close to the printer for easy reference.**

The sections of this guide and parts of the printer marked with symbols are safety warnings meant to protect the user, other individuals and surrounding objects, and ensure correct and safe usage of the printer. The symbols and their meanings are indicated below.

**⚠ WARNING:** Indicates that serious injury or even death may result from insufficient attention to or incorrect compliance with the related points.

**⚠ CAUTION:** Indicates that personal injury or mechanical damage may result from insufficient attention to or incorrect compliance with the related points.

### Symbols

The  $\triangle$  symbol indicates that the related section includes safety warnings. Specific points of attention are indicated inside the symbol.



..... [General warning]



..... [Warning of danger of electrical shock]



..... [Warning of high temperature]

The  $\circ$  symbol indicates that the related section includes information on prohibited actions. Specifics of the prohibited action are indicated inside the symbol.



..... [Warning of prohibited action]



..... [Disassembly prohibited]

The  $\bullet$  symbol indicates that the related section includes information on actions which must be performed. Specifics of the required action are indicated inside the symbol.



..... [Alert of required action]



..... [Remove the power plug from the outlet]



..... [Always connect the printer to an outlet with a ground connection]

Please contact your service representative to order a replacement if the safety warnings in the guide are illegible or if the guide itself is missing. (fee required)

### Caution

NO LIABILITY IS ASSUMED FOR ANY DAMAGE CAUSED BY IMPROPER INSTALLATION.

### Notice on Software

SOFTWARE USED WITH THIS PRINTER MUST SUPPORT THE PRINTER'S EMULATION MODE. The printer is factory-set to emulate the PCL. The emulation mode can be changed by following the procedures described in [Chapter 3](#).

### Notice

The information in this guide is subject to change without notification. Additional pages may be inserted in future editions. The user is asked to excuse any technical inaccuracies or typographical errors in the present edition.

No responsibility is assumed if accidents occur while the user is following the instructions in this guide. No responsibility is assumed for defects in the printer's firmware (contents of its read-only memory).

This guide, any copyrightable subject matter sold or provided with or in connection with the sale of the page printer, are protected by copyright. All rights are reserved. Copying or other reproduction of all or part of this guide, any copyrightable subject matter without the prior written consent of Kyocera Corporation is prohibited. Any copies made of all or part of this guide, any copyrightable subject must contain the same copyright notice as the material from which the copying is done.

### Regarding Tradenames

PRESCRIBE is a registered trademark of Kyocera Corporation. KPDL and KIR (Kyocera Image Refinement) are trademarks of Kyocera Corporation.

Diablo 630 is a product of Xerox Corporation. IBM Proprinter X24E is a product of International Business Machines Corporation. Epson LQ-850 is a product of Seiko Epson Corporation.

Hewlett-Packard, PCL, and PJI are registered trademarks of Hewlett-Packard Company. Centronics is a trade name of Centronics Data Computer Inc. PostScript is a registered trademark of Adobe Systems Incorporated. Macintosh is a registered trademark of Apple computer, Inc. Microsoft, Windows, and Windows NT are registered trademarks of Microsoft Corporation. PowerPC is trademark of International Business Machines Corporation. CompactFlash is a trademark of SanDisk Corporation. ENERGY STAR is a U.S. registered mark. All other brand and product names are registered trademarks or trademarks of their respective companies.

This Kyocera Mita page printer uses PeerlessPrintXL to provide the HP LaserJet compatible PCL 6 language emulation. PeerlessPrintXL is a trademark of The Peerless Group, Redondo Beach, CA 90278, U.S.A.

This product was developed using the Tornado™ Real Time Operating System and Tools from Wind River Systems.

**AGFA**  This printer contains UFST™ and MicroType® from Agfa Corporation.

## IBM PROGRAM LICENSE AGREEMENT

THE DEVICE YOU HAVE PURCHASED CONTAINS ONE OR MORE SOFTWARE PROGRAMS ("PROGRAMS") WHICH BELONG TO INTERNATIONAL BUSINESS MACHINES CORPORATION ("IBM"). THIS DOCUMENT DEFINES THE TERMS AND CONDITIONS UNDER WHICH THE SOFTWARE IS BEING LICENSED TO YOU BY IBM. IF YOU DO NOT AGREE WITH THE TERMS AND CONDITIONS OF THIS LICENSE, THEN WITHIN 14 DAYS AFTER YOUR ACQUISITION OF THE DEVICE YOU MAY RETURN THE DEVICE FOR A FULL REFUND. IF YOU DO NOT SO RETURN THE DEVICE WITHIN THE 14 DAYS, THEN YOU WILL BE ASSUMED TO HAVE AGREED TO THESE TERMS AND CONDITIONS.

The Programs are licensed not sold. IBM, or the applicable IBM country organization, grants you a license for the Programs only in the country where you acquired the Programs. You obtain no rights other than those granted you under this license.

The term "Programs" means the original and all whole or partial copies of it, including modified copies or portions merged into other programs. IBM retains title to the Programs. IBM owns, or has licensed from the owner, copyrights in the Programs.

### 1. License

Under this license, you may use the Programs only with the device on which they are installed and transfer possession of the Programs and the device to another party.

If you transfer the Programs, you must transfer a copy of this license and any other documentation to the other party. Your license is then terminated. The other party agrees to these terms and conditions by its first use of the Program.

You may not:

- 1) use, copy, modify, merge, or transfer copies of the Program except as provided in this license;
- 2) reverse assemble or reverse compile the Program; or
- 3) sublicense, rent, lease, or assign the Program.

### 2. Limited Warranty

The Programs are provided "AS IS."

THERE ARE NO OTHER WARRANTIES COVERING THE PROGRAMS (OR CONDITIONS), EXPRESS OR IMPLIED, INCLUDING, BUT NOT LIMITED TO, THE IMPLIED WARRANTIES OF MERCHANTABILITY AND FITNESS FOR A PARTICULAR PURPOSE.

Some jurisdictions do not allow the exclusion of implied warranties, so the above exclusion may not apply to you.

### 3. Limitation of Remedies

IBM's entire liability under this license is the following;

- 1) For any claim (including fundamental breach), in any form, related in any way to this license, IBM's liability will be for actual damages only and will be limited to the greater of:
  - a) the equivalent of U.S.\$25,000 in your local currency; or
  - b) IBM's then generally available license fee for the Program

This limitation will not apply to claims for bodily injury or damages to real or tangible personal property for which IBM is legally liable.

IBM will not be liable for any lost profits, lost savings, or any incidental damages or other economic consequential damages, even if IBM, or its authorized supplier, has been advised of the possibility of such damages. IBM will not be liable for any damages claimed by you based on any third party claim. This limitation of remedies also applies to any developer of Programs supplied to IBM. IBM's and the developer's limitations of remedies are not cumulative. Such a developer is an intended beneficiary of this Section. Some jurisdictions do not allow these limitations or exclusions, so they may not apply to you.

## 4. General

You may terminate your license at any time. IBM may terminate your license if you fail to comply with the terms and conditions of this license. In either event, you must destroy all your copies of the Program. You are responsible for payment of any taxes, including personal property taxes, resulting from this license. Neither party may bring an action, regardless of form, more than two years after the cause of action arose. If you acquired the Program in the United States, this license is governed by the laws of the State of New York. If you acquired the Program in Canada, this license is governed by the laws of the Province of Ontario. Otherwise, this license is governed by the laws of the country in which you acquired the Program.

### Typeface Trademark Acknowledgement

All resident fonts in this printer are licensed from Agfa Corporation.

Helvetica, Palatino and Times are registered trademarks of Linotype-Hell AG.

ITC Avant Garde Gothic, ITC Bookman, ITC ZapfChancery and ITC Zapf Dingbats are registered trademarks of International Typeface Corporation.

### Agfa Japan License Agreement

1. "Software" shall mean the digitally encoded, machine readable, scalable outline data as encoded in a special format as well as the UFST Software.
2. You agree to accept a non-exclusive license to use the Software to reproduce and display weights, styles and versions of letters, numerals, characters and symbols ("Typefaces") solely for your own customary business or personal purposes at the address stated on the registration card you return to Agfa Japan. Under the terms of this License Agreement, you have the right to use the Fonts on up to three printers. If you need to have access to the fonts on more than three printers, you need to acquire a multi-user license agreement which can be obtained from Agfa Japan. Agfa Japan retains all rights, title and interest to the Software and Typefaces and no rights are granted to you other than a License to use the Software on the terms expressly set forth in this Agreement.
3. To protect proprietary rights of Agfa Japan, you agree to maintain the Software and other proprietary information concerning the Typefaces in strict confidence and to establish reasonable procedures regulating access to and use of the Software and Typefaces.

4. You agree not to duplicate or copy the Software or Typefaces, except that you may make one backup copy. You agree that any such copy shall contain the same proprietary notices as those appearing on the original.
5. This License shall continue until the last use of the Software and Typefaces, unless sooner terminated. This License may be terminated by Agfa Japan if you fail to comply with the terms of this License and such failure is not remedied within thirty (30) days after notice from Agfa Japan. When this License expires or is terminated, you shall either return to Agfa Japan or destroy all copies of the Software and Typefaces and documentation as requested.
6. You agree that you will not modify, alter, disassemble, decrypt, reverse engineer or decompile the Software.
7. Agfa Japan warrants that for ninety (90) days after delivery, the Software will perform in accordance with Agfa Japan-published specifications, and the diskette will be free from defects in material and workmanship. Agfa Japan does not warrant that the Software is free from all bugs, errors and omissions.

THE PARTIES AGREE THAT ALL OTHER WARRANTIES, EXPRESSED OR IMPLIED, INCLUDING WARRANTIES OF FITNESS FOR A PARTICULAR PURPOSE AND MERCHANTABILITY, ARE EXCLUDED.

8. Your exclusive remedy and the sole liability of Agfa Japan in connection with the Software and Typefaces is repair or replacement of defective parts, upon their return to Agfa Japan.

IN NO EVENT WILL AGFA JAPAN BE LIABLE FOR LOST PROFITS, LOST DATA, OR ANY OTHER INCIDENTAL OR CONSEQUENTIAL DAMAGES, OR ANY DAMAGES CAUSED BY ABUSE OR MISAPPLICATION OF THE SOFTWARE AND TYPEFACES.

9. New York, U.S.A. law governs this Agreement.
10. You shall not sublicense, sell, lease, or otherwise transfer the Software and/or Typefaces without the prior written consent of Agfa Japan.
11. Use, duplication or disclosure by the Government is subject to restrictions as set forth in the Rights in Technical Data and Computer Software clause at FAR 252-227-7013, subdivision (b)(3)(ii) or subparagraph (c)(1)(ii), as appropriate. Further use, duplication or disclosure is subject to restrictions applicable to restricted rights software as set forth in FAR 52.227-19 (c)(2).
12. YOU ACKNOWLEDGE THAT YOU HAVE READ THIS AGREEMENT, UNDERSTAND IT, AND AGREE TO BE BOUND BY ITS TERMS AND CONDITIONS. NEITHER PARTY SHALL BE BOUND BY ANY STATEMENT OR REPRESENTATION NOT CONTAINED IN THIS AGREEMENT. NO CHANGE IN THIS AGREEMENT IS EFFECTIVE UNLESS WRITTEN AND SIGNED BY PROPERLY AUTHORIZED REPRESENTATIVES OF EACH PARTY. BY OPENING THIS DISKETTE PACKAGE, YOU AGREE TO ACCEPT THE TERMS AND CONDITIONS OF THIS AGREEMENT.

# Contents

<b>Contents .....</b>	<b>4</b>
-----------------------	----------

<b>Introduction .....</b>	<b>6</b>
---------------------------	----------

1 For More Information.....	6
2 Guide to the Operation Guide .....	6

<b>IMPORTANT! PLEASE READ FIRST .....</b>	<b>7</b>
---	----------

<b>Chapter 1 Names of Parts .....</b>	<b>1-1</b>
---------------------------------------	------------

<b>Chapter 2 How to Load Paper.....</b>	<b>2-1</b>
---	------------

1 How to Load Paper.....	2-1
1.1 Loading Paper into the Paper Cassette .....	2-1
1.2 Loading Paper into the MP (Multi-Purpose) Tray ...	2-2
1.3 Setting Envelopes .....	2-3

<b>Chapter 3 Using the Operator Panel .....</b>	<b>3-1</b>
---	------------

1 Understanding the Operator Panel.....	3-1
1.1 Operation Indicators .....	3-2
1.2 Message Display .....	3-2
1.3 Interface Indicator .....	3-2
1.4 Paper Size Indicator .....	3-3
1.5 Paper Type Indicator.....	3-3
1.6 Keys .....	3-3
2 Using the Operator Panel.....	3-4
2.1 Menu Selection System .....	3-4
2.2 Using the Menu Selection System .....	3-10
2.2.1 Printing the Menu Map .....	3-10
2.2.2 Printing Status Page .....	3-10
2.2.3 e-MPS .....	3-11
2.2.4 Changing the Interface Parameters .....	3-18
2.2.5 Changing the Emulation .....	3-22
2.2.6 Setting the Default Font .....	3-24
2.2.7 Using Page Set Menus .....	3-26
2.2.8 Setting the Print Quality .....	3-30
2.2.9 Operating an Option Hard Disk.....	3-31
2.2.10 Operating a RAM Disk .....	3-34
2.2.11 Operating a Memory Card.....	3-36
2.2.12 Paper Handling .....	3-40
2.2.13 Other Modes .....	3-47

<b>Chapter 4 Troubleshooting.....</b>	<b>4-1</b>
---------------------------------------	------------

1 General Guide.....	4-1
2 Print Quality Problems .....	4-2
3 Indicators and Messages .....	4-4
3.1 Indicators .....	4-4
3.2 Maintenance Messages .....	4-4
3.3 Error Messages.....	4-6
4 Correcting a Paper Jam .....	4-8
4.1 Jam in Paper Cassette.....	4-9
4.2 Jam at the MP Tray.....	4-9
4.3 Jam in Left Cover 1.....	4-10
4.4 Jam in Left Cover 2.....	4-11
4.5 Paper Jam at the Option Document Finisher.....	4-11

<b>Chapter 5 Paper Selection .....</b>	<b>5-1</b>
--	------------

1 General Guidelines .....	5-1
1.1 Paper Availability .....	5-1
1.2 Paper Specifications .....	5-1
1.3 Selecting the Right Paper .....	5-1
2 Special Paper.....	5-3
2.1 Transparency (Overhead Projection Film).....	5-3
2.2 Adhesive-Backed Labels .....	5-4
3 Paper Type.....	5-5

<b>Chapter 6 Maintenance .....</b>	<b>6-1</b>
------------------------------------	------------

1 Toner Container Replacement.....	6-1
1.1 Toner Container Replacement Interval.....	6-1
1.2 Replenishing Toner.....	6-1

<b>Appendix A Fonts.....</b>	<b>A-1</b>
------------------------------	------------

<b>Appendix B Expansion Memory.....</b>	<b>B-1</b>
---	------------

1 Removing the Main Circuit Board .....	B-1
1.1 Notes on Handling the Main Circuit Board and DIMM .....	B-1
1.2 Removing the Main Circuit Board from the Printer ..	B-1
2 Installing DIMMs.....	B-2
2.1 Removing DIMM .....	B-2
2.2 Testing the Expansion Memory .....	B-2

**Appendix C Host Computer Interface..... C-1**

1 Parallel Interface.....	C-1
1.1 Parallel Interface Communication Modes.....	C-1
1.2 Interface Signals.....	C-1
2 Serial Interface .....	C-2
2.1 Interface Signals.....	C-2
3 RS-232C Protocol.....	C-3
4 RS-232C Cable Connection .....	C-4
4.1 Preparing an RS-232C Cable.....	C-4
4.2 Connecting the RS-232C Cable .....	C-4
4.3 Setting the RS-232C Parameters.....	C-4

**Appendix D Option Units ..... D-1**

1 Available Options.....	D-1
2 Installing Option Units.....	D-3
2.1 PF-70/75 Paper Feeders .....	D-3
2.2 DF-70/71/75 Document Finishers .....	D-3
2.3 Network Interface .....	D-3
2.4 Hard Disk.....	D-4
2.5 Memory Card.....	D-4

**Appendix E Specifications .....E-1****Glossary ..... 1-1****Index ..... 1-1**

# Introduction

The Kyocera Mita page printer has many desirable features, such as the EcoPrint function that reduces the power consumption and the Auto Media Type Selection function that selects the media automatically before printing. If you install the option document finisher to the printer, you can also make stitching.

This section explains the following topics:

- For More Information...
- Guide to the Operation Guide

## 1. For More Information...

Item	Description
Installation Guide (paper manual)	Describes procedures from the printer setup to printing a test page.
Operation Guide (this manual)	Guides you through topics concerning the operations and maintenance of the printer.
Printer Driver Guide	Describes how to install and set the printer driver. This guide is contained in the latter half of this guide.
PRESCRIBE Programming Manual	Describes how to use the PRESCRIBE commands and their parameters in detail for experienced users. This manual is contained in the CD-ROM supplied with the printer.
PDF417 Two-Dimensional Bar Code Implementation Manual	Includes a PDF417 overview and explains PRESCRIBE commands for use with two-dimensional barcodes. This manual is contained in the CD-ROM supplied with the printer.

## 2. Guide to the Operation Guide

This Operation Guide has the following chapters:

### **Chapter 1 Names of Parts**

This chapter explains the name and function of each part of the printer.

### **Chapter 2 How to Load Paper**

This chapter explains how to load paper into the paper cassette and MP tray.

### **Chapter 3 Using the Operator Panel**

This chapter explains the message display, indicators and keys on the operator panel, and how to make various settings from the operator panel.

### **Chapter 4 Troubleshooting**

This chapter explains how to handle printer problems that may occur, such as paper jams.

### **Chapter 5 Paper Selection**

This chapter explains the types of paper that can be used with the printer.

### **Chapter 6 Maintenance**

This chapter explains how to replace the toner container, waste toner box, and how to care for your printer.

### **Appendix A Fonts**

This appendix explains about fonts and lists the printer's internal fonts.

### **Appendix B Expansion Memory**

This appendix explains how to expand the printer's memory.

### **Appendix C Host Computer Interface**

This appendix explains the pin assignment and specifications for the printer's parallel interface and serial interface.

### **Appendix D Option Units**

This appendix introduces the available options for use with the printer.

### **Appendix E Specifications**

This appendix lists the printer's specifications.

### **Glossary**

This glossary explains the terminology used in this manual.

# IMPORTANT! PLEASE READ FIRST

## Caution Labels

Caution labels have been attached to the printer at the following locations for safety purposes. BE SUFFICIENTLY CAREFUL to avoid fire or electric shock when removing a paper jam or when replacing toner.

Label 2

High temperature inside. Do not touch parts in this area, because there is a danger of getting burned. ....

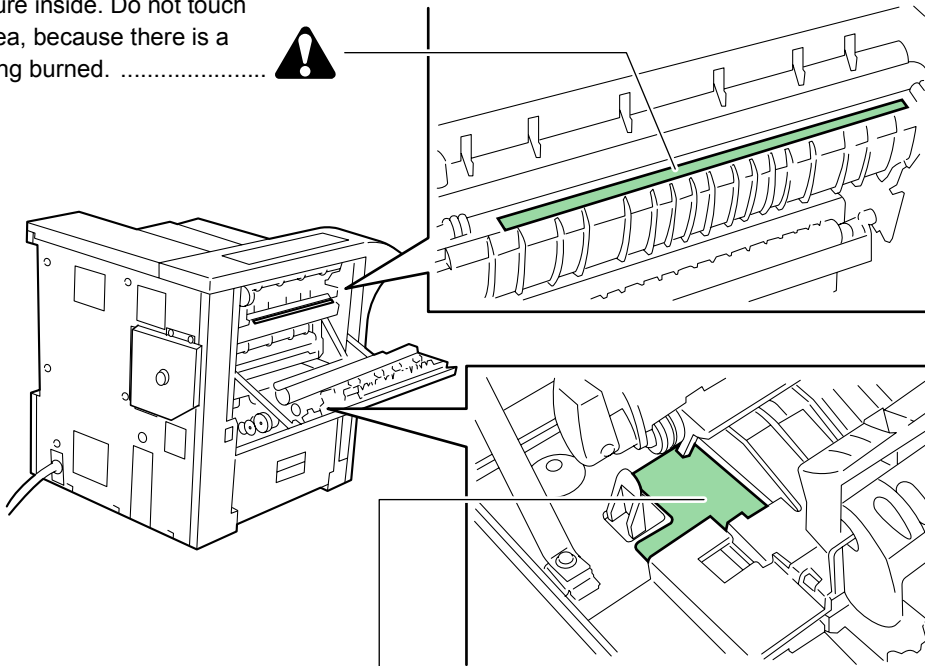

Label 1

High voltage inside. NEVER touch parts in this area, because there is a danger of electric shock. ....



Label 3

Do not incinerate toner and waste toner box. Dangerous sparks may cause burn. ....

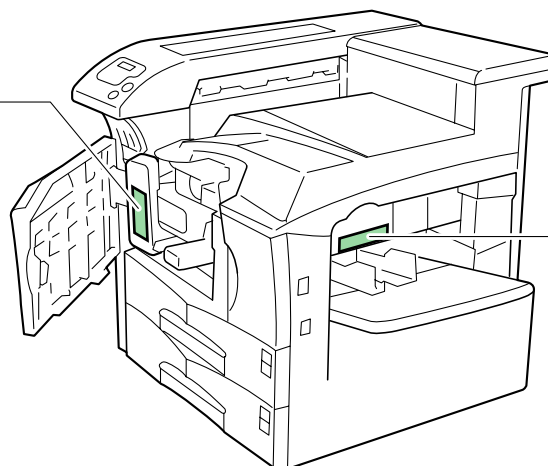

Label 4

Moving parts inside. May cause personal injury. Do not touch moving parts. ....





# ⚠ Installation Precautions

## ■ Environment

### ⚠ CAUTION

- Avoid placing the printer on or in locations which are unstable or not level. Such locations may cause the printer to fall down or fall over. This type of situation presents a danger of personal injury or damage to the printer. ⚡
- Avoid locations with humidity or dust and dirt. If dust or dirt becomes attached to the power plug, clean the plug to avoid the danger of fire or electrical shock. ⚡
- Avoid locations near radiators, heaters, or other heat sources, or locations near flammable items, to avoid the danger of fire. ⚡
- To keep the printer cool and facilitate changing of parts and maintenance, allow access space as shown below. Leave adequate space, especially around the left cover, to allow air to be properly ventilated out of the printer. ⚠

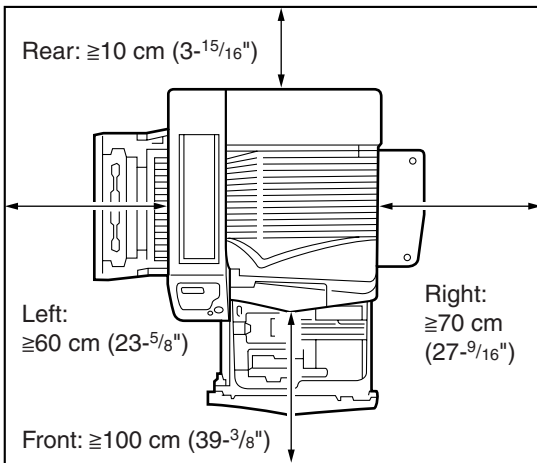

- Always use the caster stoppers to stabilize the printer once it is in place to keep it from moving and/or falling over and causing injury. ⚠

### Other Precautions

- Adverse environmental conditions may affect the safe operation and performance of the printer. Install in an air-conditioned room (recommended room temperature: around 20 °C, humidity: around 65 % RH) and avoid the following locations when selecting a site for the printer.
  - Avoid locations near a window or with exposure to direct sunlight.
  - Avoid locations with vibrations.
  - Avoid locations with drastic temperature fluctuations.
  - Avoid locations with direct exposure to hot or cold air.
  - Avoid poorly ventilated locations.
- If the floor is delicate against casters, when this product is moved after installation, the floor material may be damaged.

## ■ Power Supply/Grounding the Printer

### ⚠ WARNING

- DO NOT use a power supply with a voltage other than that specified. Avoid multiple connections in the same outlet. These types of situations present a danger of fire or electrical shock. ⚡
- Plug the power cord securely into the outlet. If metallic objects come in contact with the prongs on the plug, it may cause a fire or electric shock. ⚠
- Always connect the printer to an outlet with a ground connection to avoid the danger of fire or electrical shock in case of an electric short. If an earth connection is not possible, contact your service representative. ⚡

### Other Precautions

- Connect the power plug to the closest outlet possible to the printer.

## ■ Handling of Plastic Bags



### ⚠ WARNING







- Keep the plastic bags that are used with the printer away from children. The plastic may cling to their nose and mouth causing suffocation. ⚡

# Precautions for Use





## ■ Cautions when Using the Printer

### WARNING



- DO NOT place metallic objects or containers with water (flower vases, flower pots, cups, etc.) on or near the printer. This type of situation presents a danger of fire or electrical shock should they fall inside. 
- DO NOT remove any of the covers from the printer as there is a danger of electrical shock from high voltage parts inside the printer. 
- DO NOT damage, break or attempt to repair the power cord. DO NOT place heavy objects on the cord, pull it, bend it unnecessarily or cause any other type of damage. 

These types of situations present a danger of fire or electrical shock. 
- NEVER attempt to repair or disassemble the printer or its parts as there is a danger of fire, electrical shock or damage to the laser. If the laser beam escapes, there is a danger of it causing blindness. 
- If the printer becomes excessively hot, smoke appears from the printer, there is an odd smell, or any other abnormal situation occurs, there is a danger of fire or electrical shock. Turn the power switch OFF (O) immediately, remove the power plug from the outlet and contact your service representative. 
- If anything harmful (paper clips, water, other fluids, etc.) falls into the printer, turn the power switch OFF (O) immediately. Next, remove the power plug from the outlet to avoid the danger of fire or electrical shock. Then contact your service representative. 
- DO NOT remove or connect the power plug with wet hands, as there is a danger of electrical shock. 
- ALWAYS contact your service representative for maintenance or repair of internal parts. 

### CAUTION

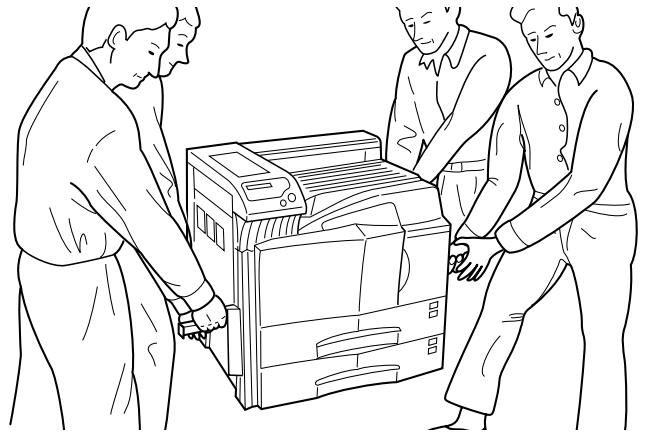
- DO NOT pull the power cord when removing it from the outlet. If the power cord is pulled, the wires may become broken and there is a danger of fire or electrical shock. (ALWAYS grasp the power plug when removing the power cord from the outlet.) 
- ALWAYS remove the power plug from the outlet when moving the printer. If the power cord is damaged, there is a danger of fire or electrical shock. 
- If the printer will not be used for a short period of time (overnight, etc.), turn the power switch OFF (O). If it will not be used for an extended period of time (vacations, etc.), remove the power plug from the outlet for safety purposes during the time the printer is not in use. 
- When lifting or moving the printer, pull up the 4 handles on both sides of the printer, then ALWAYS carry the printer by the designated 4 handles with at least 4 people, one person to a handle. 







- For safety purposes. ALWAYS remove the power plug from the outlet when performing cleaning operations. 
- If dust accumulates within the printer, there is a danger of fire or other trouble. It is therefore recommended that you consult with your service representative in regard to the cleaning of internal parts. This is particularly effective if accomplished prior to seasons of high humidity. Consult with your service representative in regard to the cost of cleaning the internal parts of the printer. 

### Other Precautions

- DO NOT place heavy objects on the printer or cause other damage to the printer.
- DO NOT open the front cover, turn off the main switch, or pull out the power plug during printing.
- During printing, some ozone is released, but the amount does not cause any ill effect to one's health. If, however, the printer is used over a long period of time in a poorly ventilated room or when printing an extremely large number of copies, the smell may become unpleasant. To maintain the appropriate environment for print work, it is suggested that the room be properly ventilated.
- DO NOT touch electrical parts, such as connectors or printed circuit boards. They could be damaged by static electricity.
- DO NOT attempt to perform any operations not explained in this handbook.
- CAUTION: Use of controls or adjustments or performance of procedures other than those specified herein may result in hazardous radiation exposure.

## ■ Cautions for Toner Handling

### ▲ CAUTION

- Do not incinerate toner and toner containers. Dangerous sparks may cause burn. .... 
- Never open the toner container or waste toner box. .... 
- Make sure not to inhale the toner, and not to rub your eyes or touch your mouth with the hands stained with the toner. And make sure not to stick to your skin. .... 
- For the disposal of old toner container and waste toner box, consult your dealer. Or dispose of the toner or toner containers in accordance with Federal, state and Local rules and regulations. .... 
- Keep the toner container and the waste toner box away from children. .... 

### Other Precautions

- If the printer will not be used for an extended period of time, remove the paper from the cassette, return it to its original package and reseal it.

# Chapter 1

# Names of Parts

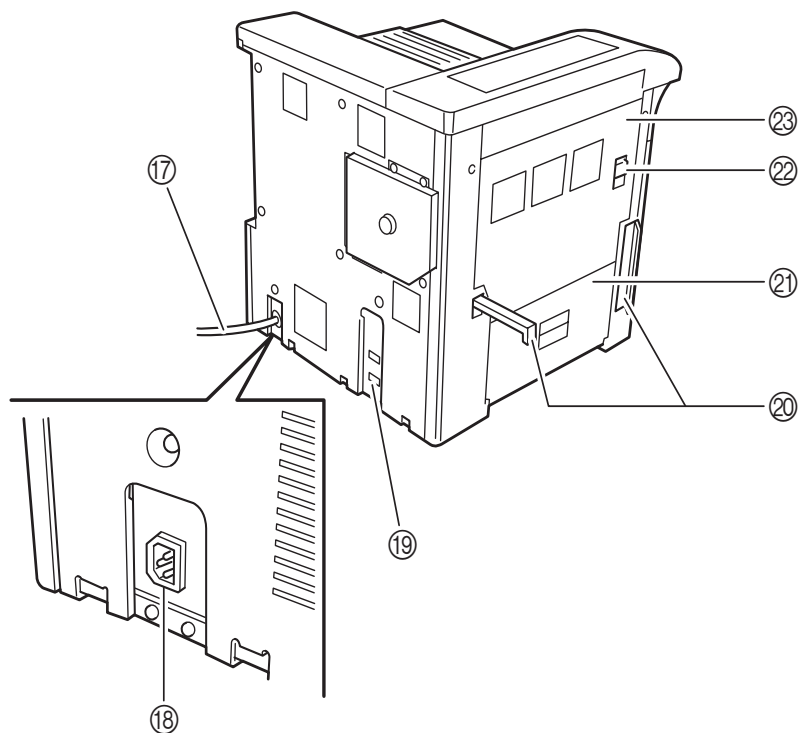
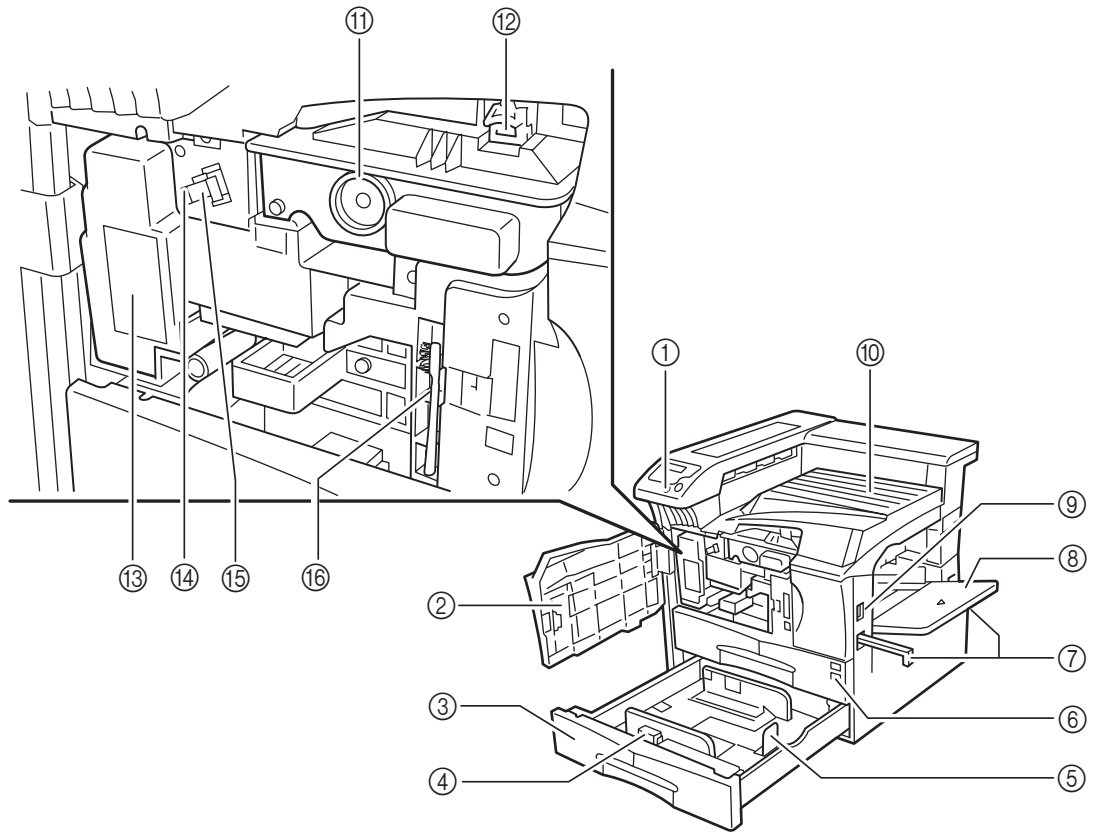

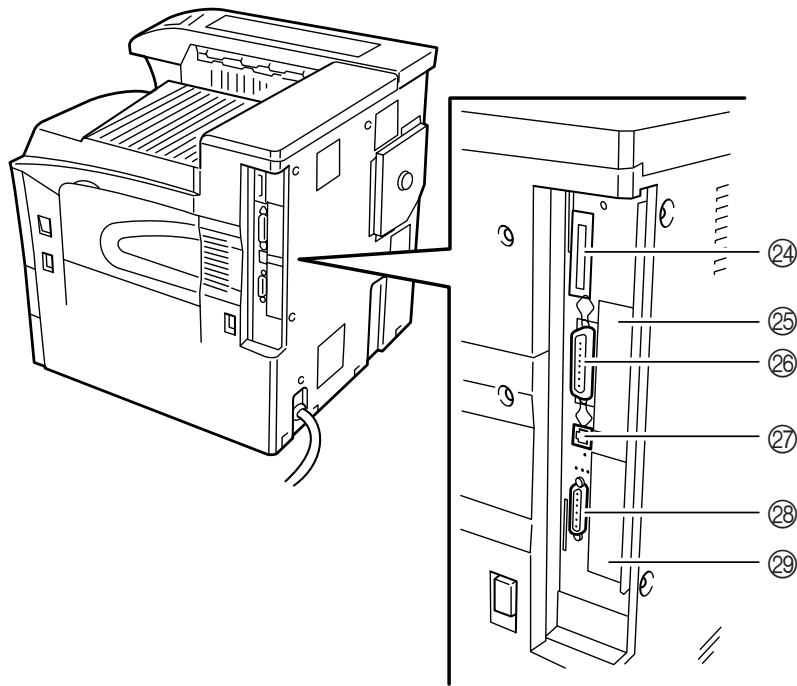

- ① **Operator panel**  
Contains the keys and indicators for operating the printer.
- ② **Front cover**  
Open to replace the toner container or waste toner box.
- ③ **Paper cassette 2**  
Second cassette that holds up to about 500 sheets of standard paper.
- ④ **Paper guide**  
Adjust to the length of the paper to be set in the paper cassette.
- ⑤ **Paper stopper**  
Hold the lever and adjust the paper guide to the width of the paper to be set in the paper cassette.
- ⑥ **Paper cassette 1**  
First cassette that holds up to about 500 sheets of standard paper.
- ⑦ **Handles for transport**  
These handles must be held by at least 4 persons when lifting or moving the printer.
- ⑧ **MP (Multi-Purpose) tray**  
Load paper here when printing onto small-size or special paper.
- ⑨ **Main switch**  
Turn ON (I) before starting to print.
- ⑩ **Face-down tray**  
Printed paper is stored here.
- ⑪ **Toner container**
- ⑫ **Toner container release lever**  
Operate to replace the toner container.
- ⑬ **Waste toner box**  
Waste toner is collected.
- ⑭ **Cleaning knob**  
Pull and push back in after toner container replacement or when print images become soiled with toner.
- ⑮ **Main charger unit**  
When replacing the toner container, install the grid cleaner to clean the grid.
- ⑯ **Cleaning brush**  
Used to clean the internal part of the printer.
- ⑰ **Power cord**
- ⑱ **Power cord connector**  
220 to 240 V-models only.
- ⑲ **Option unit connector**  
When using the option device, connect its cable to this connector.
- ⑳ **Handles for transport**  
These handles must be held by at least 4 persons when lifting or moving the printer.
- ㉑ **Left cover 2**  
Open when a paper jam occurs inside the left cover 2.
- ㉒ **Lock lever**  
Pull up to open the left cover 1.
- ㉓ **Left cover 1**  
Open when a paper jam occurs.
- ㉔ **Memory card slot**
- ㉕ **Optional network interface card slot (OPT2)**  
For optional network interface card.
- ㉖ **Parallel cable connector**  
Connect the parallel cable to this connector in the parallel printing.
- ㉗ **Network cable connector**  
Connect the network cable to this connector in the network printing.
- ㉘ **Serial cable connector**  
Connect the serial cable to this connector in the serial printing.
- ㉙ **Optional hard disk unit slot (OPT1/HDD)**  
For optional hard disk unit.

# Chapter 2

# How to Load Paper

## 1. How to Load Paper

Paper can be loaded into the two paper cassettes and the MP tray.

### 1.1 Loading Paper into the Paper Cassette

Up to about 500 sheets of standard paper (80 g/m<sup>2</sup>) can be loaded into the each paper cassette.

#### Inch specifications

Each paper cassette can be set to hold paper of any desired size from 11 × 17 to 5-1/2 × 8-1/2".

#### Metric specifications

Each paper cassette can be set to hold paper of any desired size from A3 to A5R.

- 1 Pull the paper cassette out toward you as far as it will go. Do not pull more than one paper cassette out at a time.

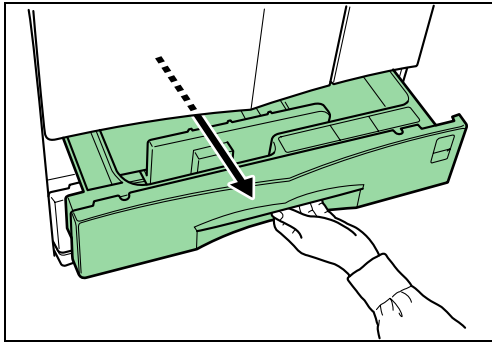

- 2 Hold the paper guide and move it to align the paper guide with the required paper width. Paper sizes are marked inside the paper cassette.

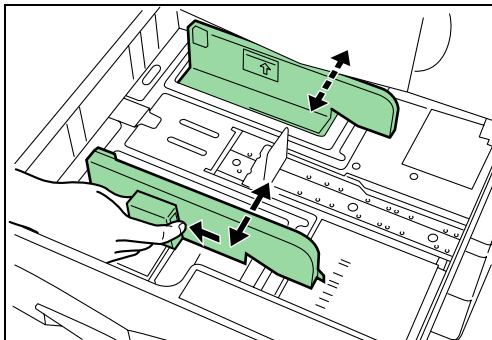

- 3 Hold the paper stopper and move it to align with the required paper length.

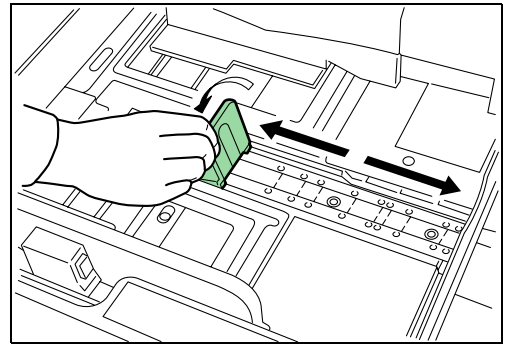

- 4 Set the paper flush against the left-hand wall of the paper cassette.

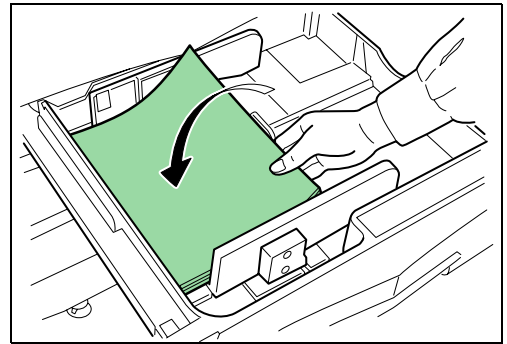

### IMPORTANT

- There is a sticker (↑ in the illustration) indicating paper capacity attached to the inside of the paper cassette. Do not load paper above this limit.
- When loading paper into the paper cassette, make sure that the print side is facing upward. (The print side is the side facing upward when the package is opened.)
- Check that the paper guide makes secure contact with the paper. If there is a gap, adjust the position of the paper guide.
- If small-size paper jams occur frequently under high temperature and high humidity conditions, reduce the number of sheets to the level line indicated on the sticker ↑.

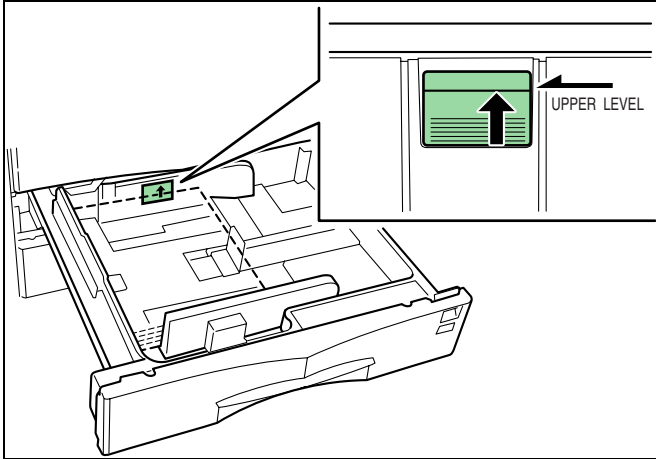

### 1.2 Loading Paper into the MP (Multi-Purpose) Tray

Special paper as well as standard paper can be loaded into the MP tray. When printing onto transparencies or thick paper, be sure to use the MP tray.

### NOTE

- The number of sheets of standard paper that can be loaded in the MP tray at a time is approximately 200.
- When using transparencies, load a single sheet at a time.

### IMPORTANT

When setting special paper, such as transparencies and thick paper, into the M tray, select the type of paper by referring to [3.Paper Type on page 5-5](#).

- 1 Open the MP tray.

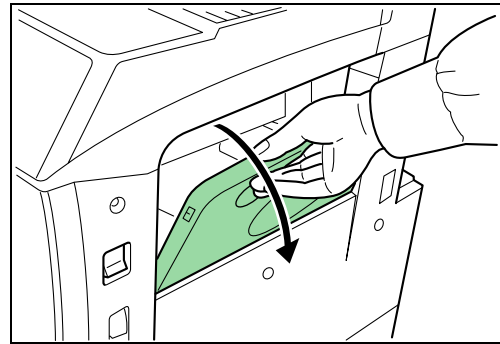

- 2 Adjust the insert guides to the size of the paper to be loaded.

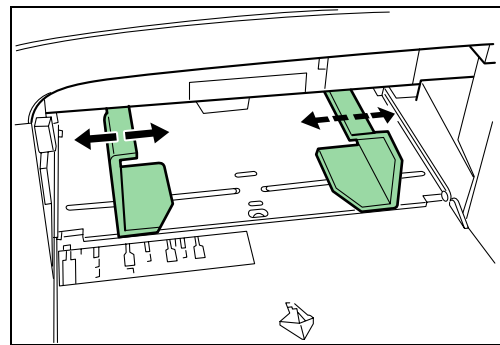

- 5 Set the supplied paper size plate so that the size of the paper loaded can be checked by looking at the front of the paper cassette.

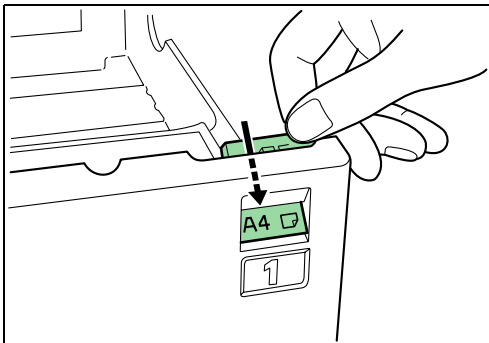

- 6 Gently push the paper cassette back in.

### NOTE

Before leaving the printer in disuse for a prolonged period of time, remove the paper from the paper cassette(s) and seal it in its original packaging to protect from moisture. Also, when storing paper in a high temperature and high humidity environment, seal it in a moisture-proof bag.

- 3 Insert the paper along the guides as far as it will go.

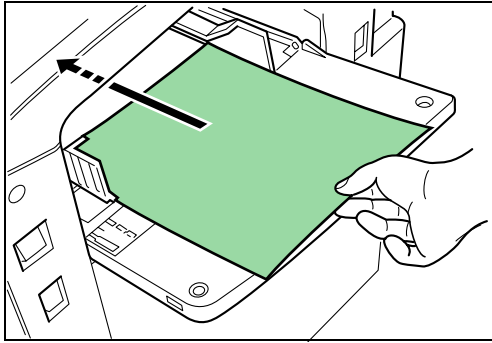

**IMPORTANT**

When loading paper into the MP tray, make sure that the print side is facing upward. (The print side is the side facing upward when the package is opened.) If the leading edge of the paper is curled, straighten it out before loading the paper in the MP tray.

**1.3 Setting Envelopes**

When using the optional printer function, envelopes can be set in the MP tray.

- 1 Open the MP tray.

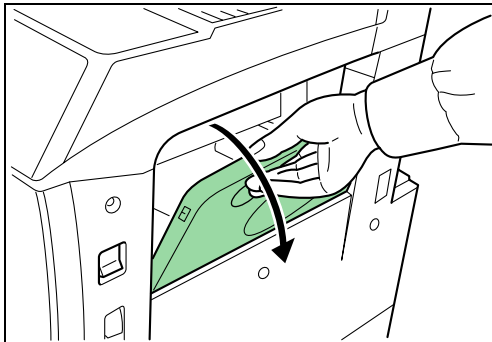

- 2 Align the insert guides with the envelope size.

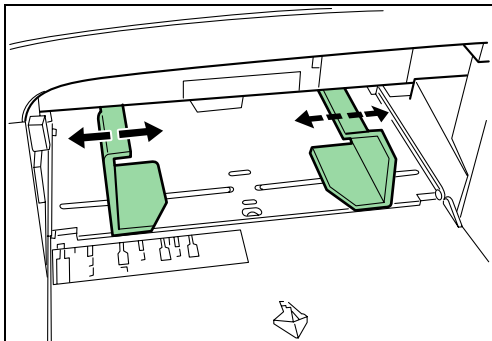

- 3 Open the flap of the envelope and set it with the copy side facing upward. With the flap facing the outside, insert the envelope into the slot along the insert guides as far as it will go.

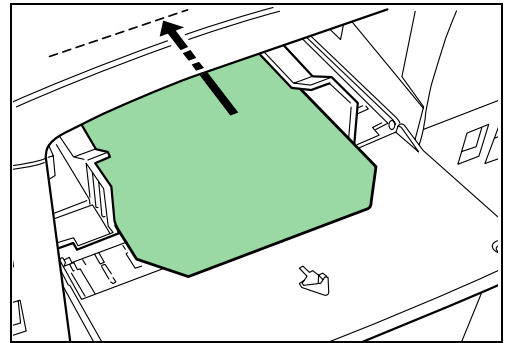

**NOTE**

Incorrectly loading envelopes can result in printing in the wrong orientation or on the wrong side.



# Chapter 3

# Using the Operator Panel

This chapter explains the following topics:

- Understanding the Operator Panel
- Using the Operator Panel



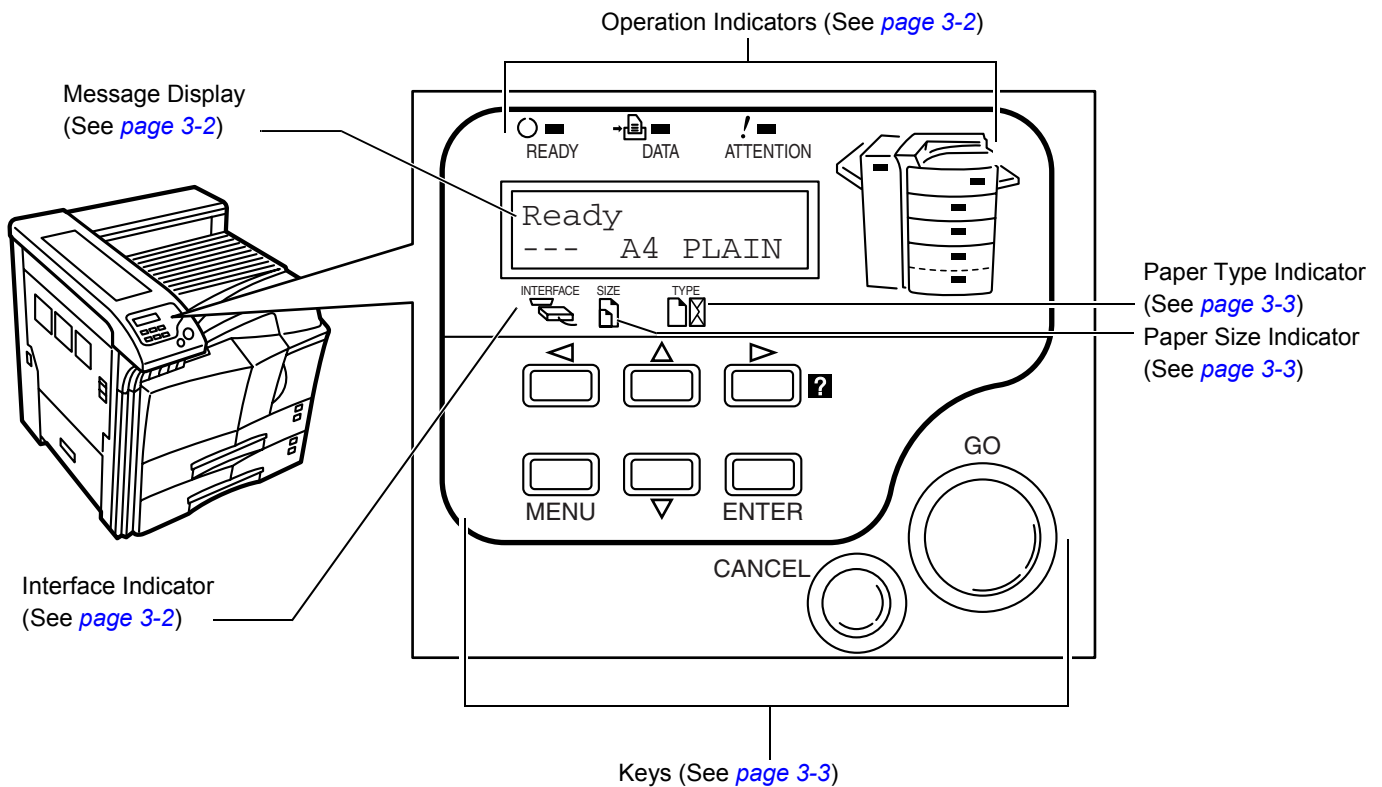

## 1. Understanding the Operator Panel

The operator panel has an LCD message display, indicators, and eight keys.



### 1.1 Operation Indicators

The following indicators light up during normal operation and when the printer needs attention.

Indicator	Description
 READY	<p><b>Flashing:</b> Indicates when an error occurs that you can clear by yourself.</p> <p><b>Lit:</b> Indicates that the printer is on-line. The printer prints received data.</p> <p><b>Off:</b> Indicates that the printer is off-line. Data can be received but will not be printed. Also indicates when printing is automatically stopped due to occurrence of an error.</p>
 DATA	<p><b>Flashing:</b> Indicates data transfer is taking place.</p> <p><b>Lit:</b> Indicates either that data is being processed, or that data is being written to the memory card.</p>
 ATTENTION	<p><b>Flashing:</b> Indicates when the printer needs maintenance attention or the printer is warming up (<i>Please wait</i>).</p> <p><b>Lit:</b> Indicates when a problem or an error occurs that you can clear by yourself. (For example, paper jam occurs.)</p>
	<p>① <b>Flashing:</b> Indicates when no paper is detected.</p> <p><b>Fast-Flashing:</b> Indicates that a paper jam is occurring.</p> <p><b>Lit:</b> Indicates that the MP tray is selected.</p>
	<p>② <b>Flashing:</b> Indicates when the cassette or paper is not detected, or when the paper is loading.</p> <p><b>Fast-Flashing:</b> Indicates that a paper jam is occurring.</p> <p><b>Lit:</b> Indicates that the cassette is selected.</p>
	<p>③ <b>Flashing:</b> Indicates that there is paper jam in the optional finisher.</p> <p><b>Lit:</b> Indicates that the document finisher is being selected.</p>

### 1.2 Message Display

The message display gives information in the form of short messages. The eight messages listed below are displayed during normal warm-up and printing.

Other messages that may appear when the printer needs the operator's attention are explained [on page 4-4](#).

Message	Meaning
Self test	The printer is self-testing after power-up.
Please wait	The printer is warming up and is not ready. When the printer is switched on for the first time after the toner container is installed, ( <i>Adding toner</i> ) also appears.
Ready	The printer is ready to print.
Processing	The printer is receiving data, generating graphics, reading a memory card/hard disk, or printing.
Sleeping	The printer is in Sleep mode. The printer wakes from Sleep mode whenever a key on the operator panel is pressed, the cover is opened or closed, or data is received. The printer then warms up and goes online. The time that the printer takes to enter Sleep mode depends on the Sleep Timer setting.
Cancelling data	Jobs inside the printer are being canceled. To cancel a job, see the table <a href="#">on page 3-3</a> .
Waiting	The printer is waiting for the end-of-job command before printing the last page. Pressing the <b>GO</b> key allows you to obtain the last page immediately.
FormFeed TimeOut	The printer is printing the last page after a waiting period.

### 1.3 Interface Indicator

The interface Indicator shows the interface that is currently used. It uses the following abbreviations:

- PAR** Standard bi-directional parallel interface
- SER** Serial interface (RS-232C)
- NET** Network interface
- OPT** Option network interface card
- No interface is active.

Each interface has a timeout time of 30 seconds during which the other interface should wait to receive a print job. Even if a print job has been completed on the interface, you should wait for this period until the other interface begins printing the job.



# 2. Using the Operator Panel

This section explains how to use the menu selection system. The **MENU** key on the operator panel allows you to use the menu to set or change the printer environment such as the number of copies to print, emulation, etc., to your specific needs. Settings can be made when *Ready* is indicated on the printer message display.

The printer obeys the most recently received printer settings sent from the application software, or from the printer driver, which take priority over operator panel settings.

## 2.1 Menu Selection System

The following is the hierarchy diagram of the menu selection system of the printer. The vertical transition is made with the  $\Delta$  and  $\nabla$  keys and horizontal transition is made with the  $\triangleright$  and  $\triangleleft$  keys. To change or finalize configuration on an item, use the **ENTER** key.

 These items will not appear unless the printer is installed with the applicable option.

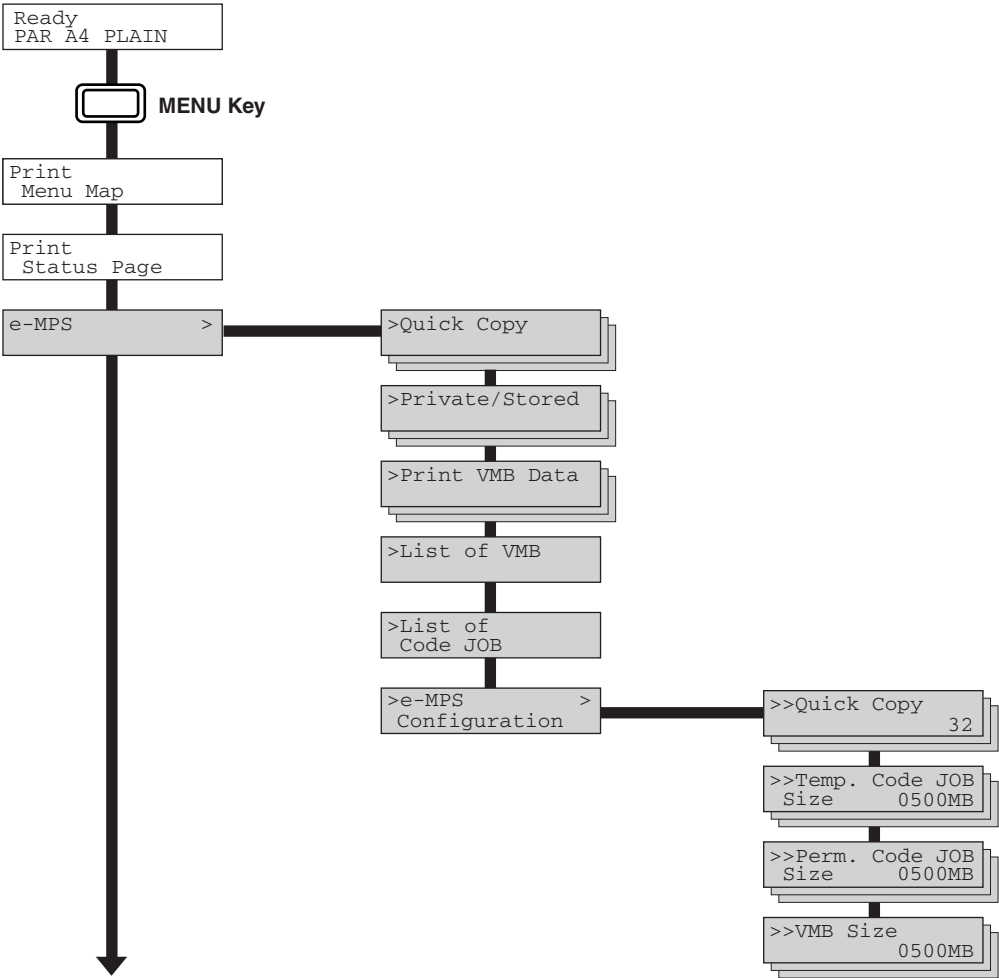

Continued on the next page

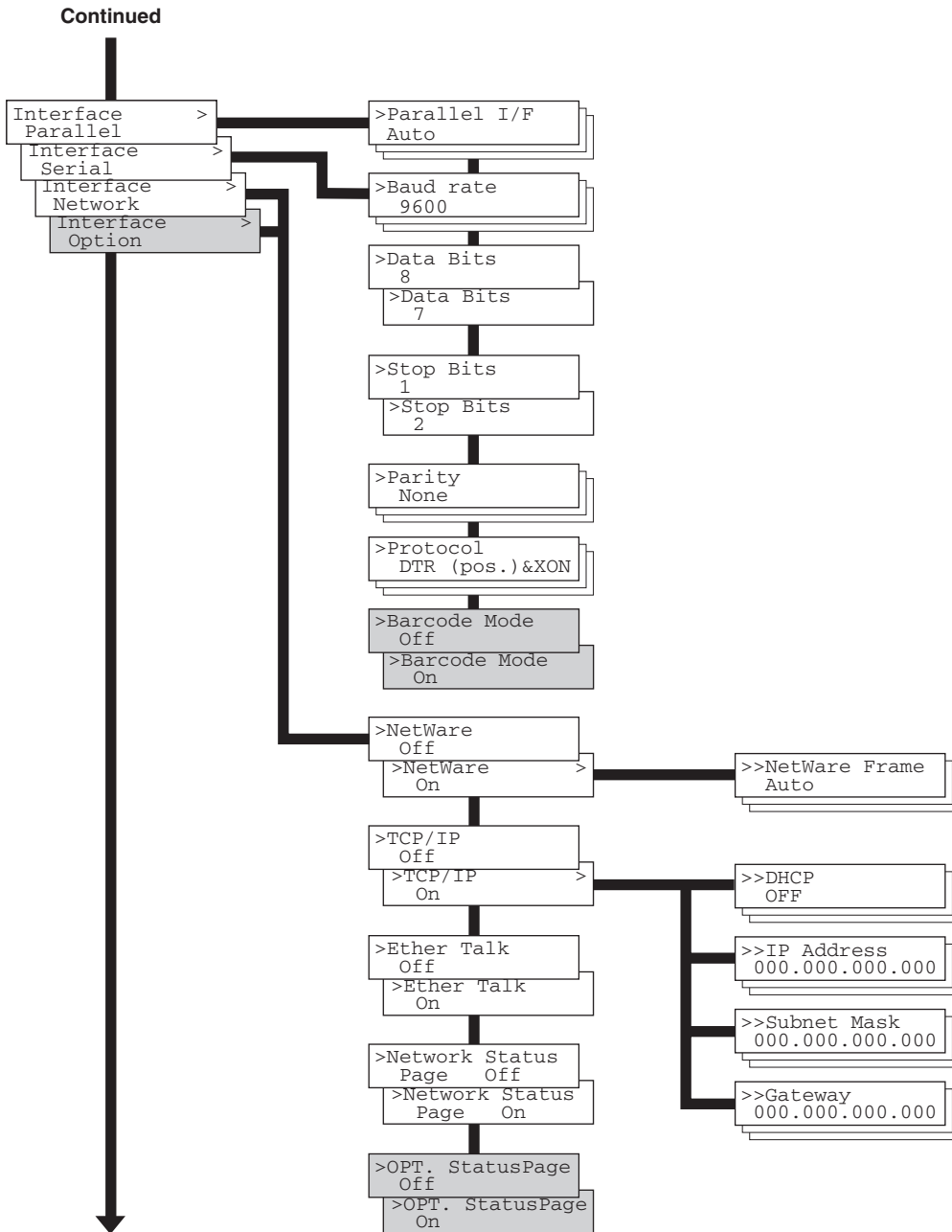

Continued on the next page

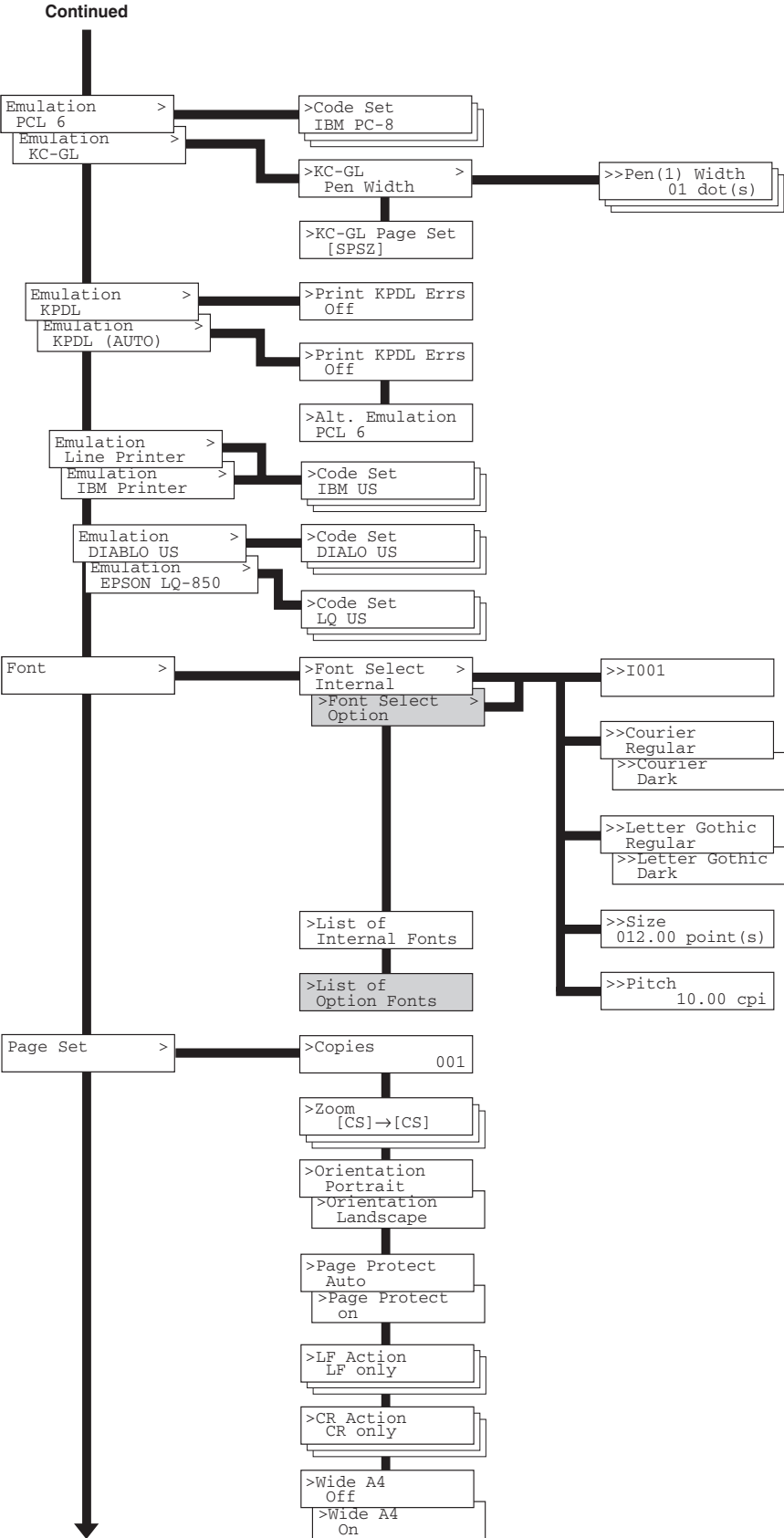

Continued on the next page

Continued

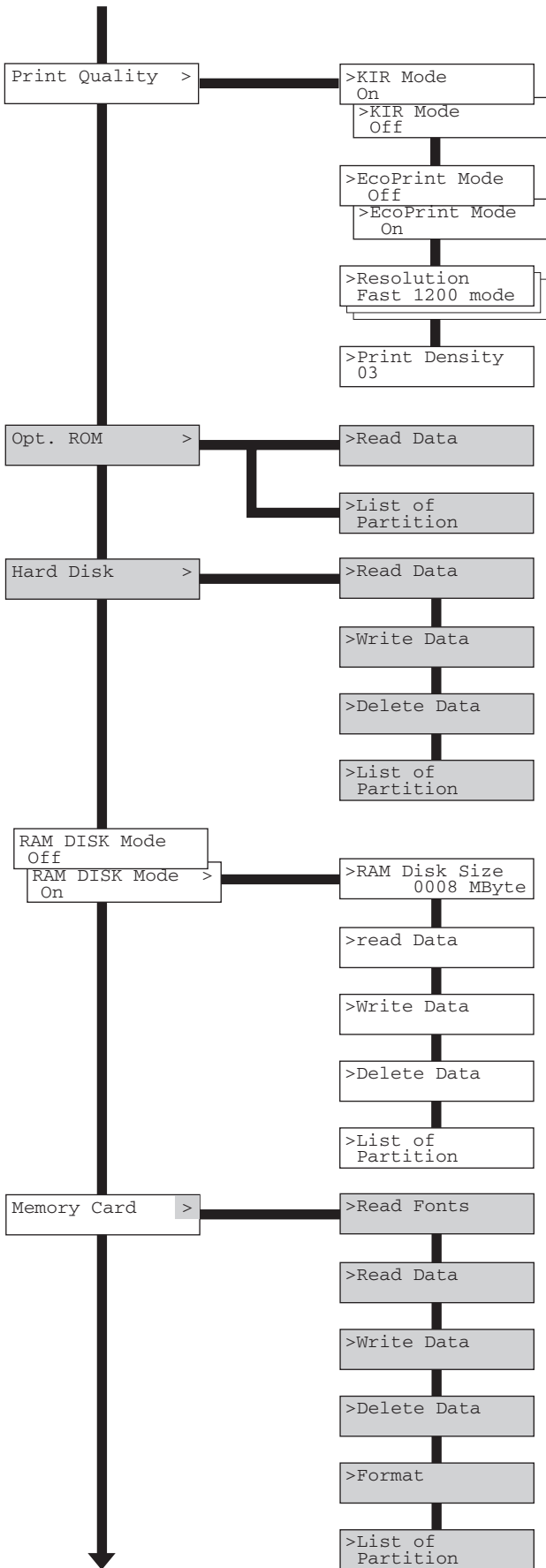

Continued on the next page

Continued

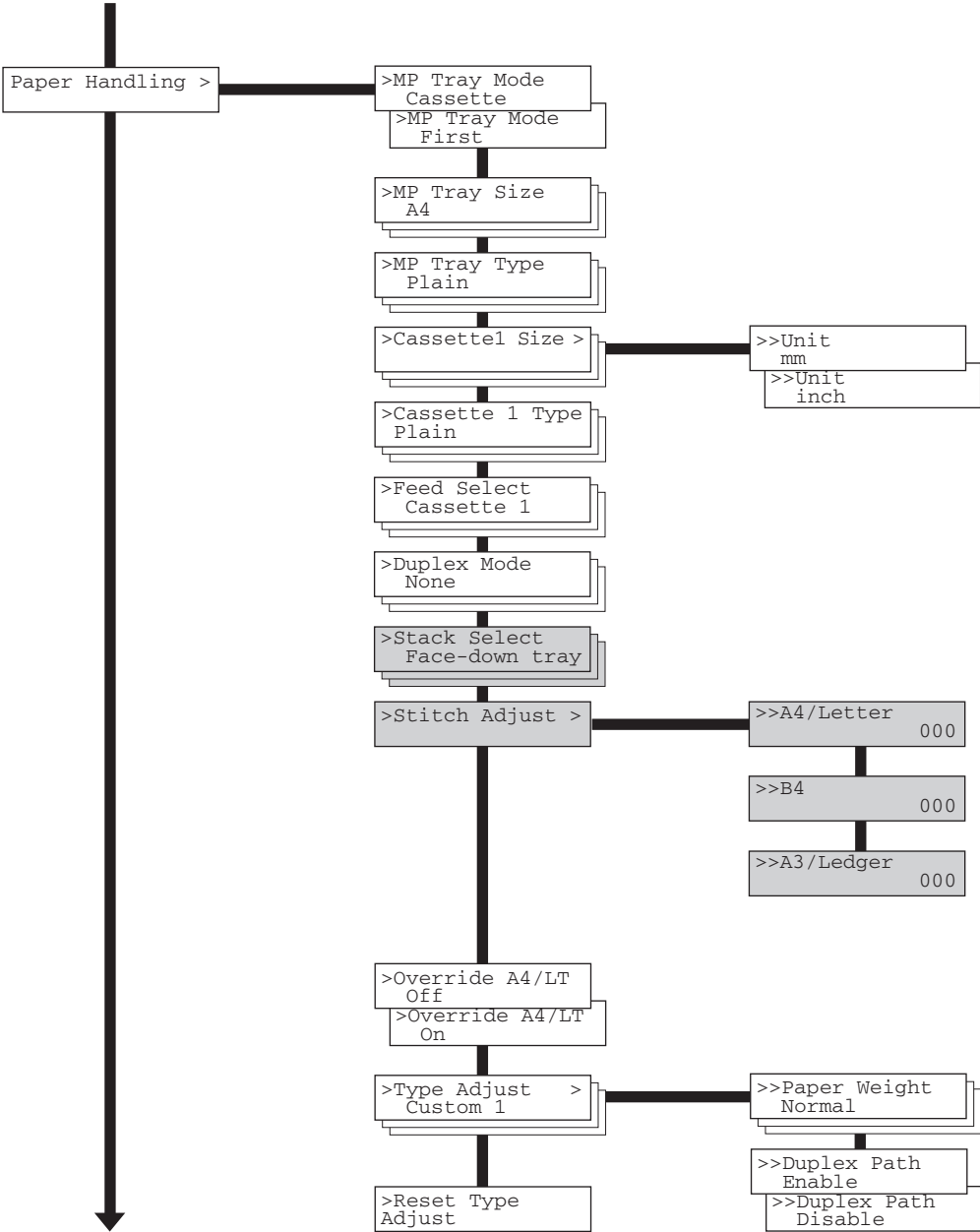

Continued on the next page



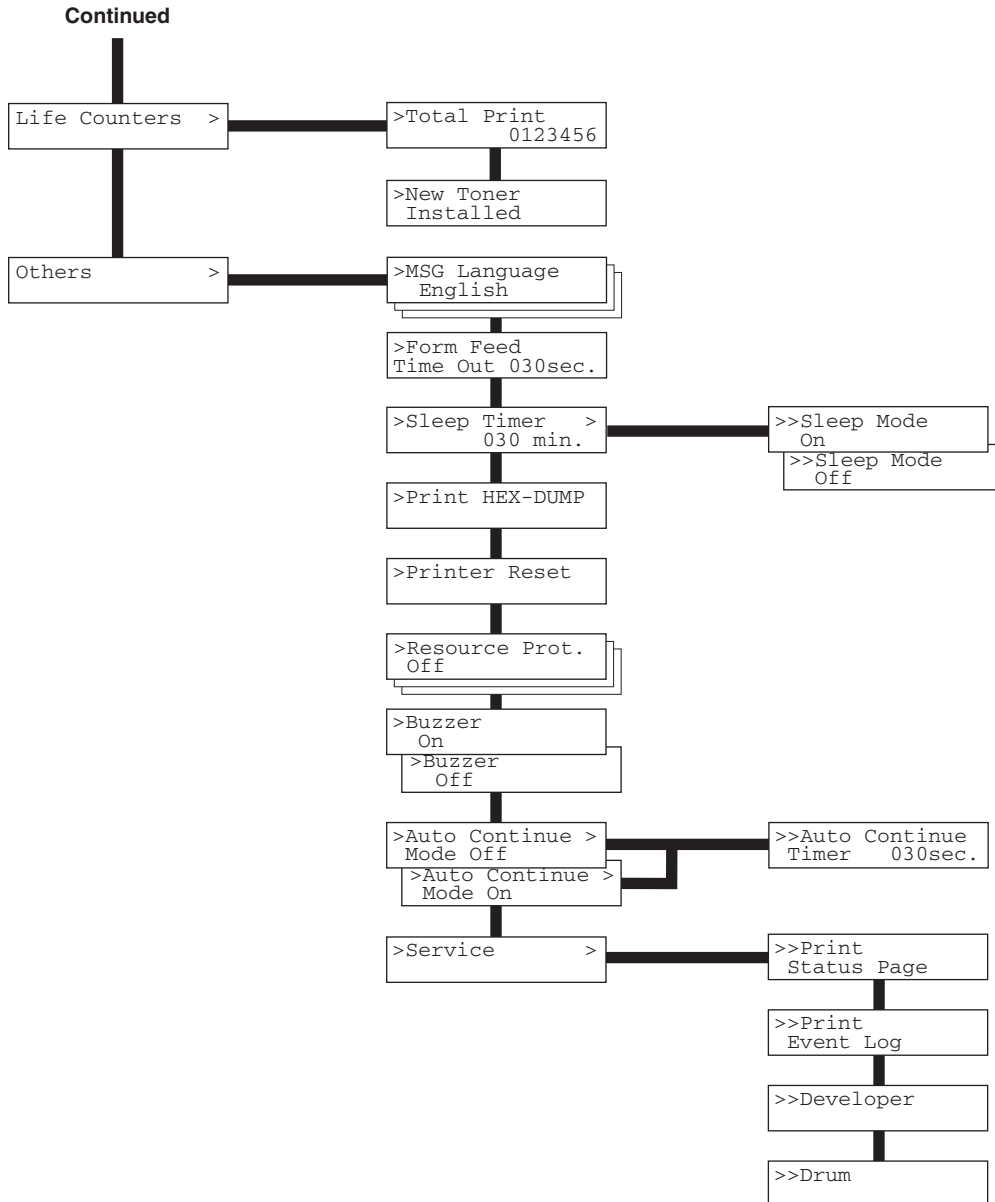



### NOTE

Items and values on the status page may vary depending on the printer's firmware version.

#### ① Software Version

This information shows the firmware version and date of issue of the printer.

#### ② Hardware Information

This information shows various printer settings, such as the size and type of the paper in the paper cassettes.

#### ③ Memory

This shows the amount of total memory installed in the printer, the amount of currently available memory, and the current status of the RAM disk. See [Setting RAM Disk Size on page 3-34](#).

#### ④ Page Information

This shows the print resolution, number of copies, and the total page count.

#### ⑤ Installed Options

This shows the option(s) installed in the printer.

#### ⑥ Network Status

This shows the IP address, Subnet Mask address, and Default Gateway address for the network interface.

#### ⑦ Emulation

This shows all available emulations of the printer. The printer is shipped from the factory with PCL 6 emulation selected as the default.

#### ⑧ Error Log

This shows the last three instances of the following four types of errors, listing them in the order of their occurrence: KPDL Error Press GO; Memory overflow Press GO; Print overrun Press GO; File not found Press GO. The most recent error is displayed on the top line of the Error Log. For error remedies, see [Maintenance Messages on page 4-4](#). Error information is cleared when the printer's power is turned off.

#### ⑨ Toner Gauge

This shows the approximate level of remaining toner. When the value is 100, the toner container is full.

#### ⑩ Interface Information

This information shows the default font and the default emulation for all interfaces installed in the printer.

#### ⑪ KIR Test Pattern

KIR is the Kyocera's original smoothing function. This test pattern shows the effect of the KIR (Kyocera Image Refinement) system.

### 2.2.3 e-MPS

e-MPS is an abbreviation for 'enhanced-Multiple Printing System' which implements the following functions that are available from the printer driver:

- Job Retention
- Job Storage

In either job mode, when printing a document, the print data is transferred from the computer to the printer then stored on the printer's hard disk. Since copies of the document are printed using the stored data, printing is performed faster with less computer spooling time and less network traffic.

### NOTE

To use the e-MPS system, an optional hard disk must be installed in the printer. For details, see [Appendix D Option Units](#).

#### ■ Job Retention

Job Retention has four modes as summarized below. These modes are selected when you choose on the printer driver through the application software:

	Quick Copy	Proof-and-Hold
Primary function	To later print additional copies	To proof the first copy before printing multiple copies
Storing started	Printer driver	Printer driver
Retrieved by	Operator panel	Operator panel
Default number of copies printed at retrieval	Same as storing	One less
Maximum number of jobs stored*	32,expandable to 50	32,expandable to 50
PIN security	No	No
Data after printing	Retained	Retained
Data when power off	Deleted	Deleted

	Private Print	Stored Job
Primary function	To hold the document in printer to prevent unauthorized access	To electronically store documents such as fax cover pages
Storing started	Printer driver	Printer driver
Retrieved by	Operator panel	Operator panel
Default number of copies printed at retrieval	Same as storing	One
Maximum number of jobs stored*	Private jobs are deleted automatically once it is retrieved.	Depends on the hard disk capacity
PIN security	Yes	Yes (Option)
Data after printing	Deleted	Retained
Data when power off	Deleted	Retained

\*Jobs in excess will cause the earlier ones to be deleted.

### ■ Job Storage

Job storage stores print jobs either temporarily or permanently, or in virtual mailboxes, as you click an appropriate radio button on the printer driver when printing from a computer. If you select Temporary or Permanent job storage, you can choose to have a unique number and barcode automatically assigned to each job as it is stored in the printer. This barcode appears on the printed document. The barcode reader can be used to reprint the document by reading the barcode from the original document or from a List of Code Jobs. For details on this list, see [Printing a List of Code Jobs on page 3-15](#).

Job storage requires a hard disk installed in the printer. However, printing barcoded job IDs on documents is possible using the RAM disk feature of the printer. On how to use the RAM disk, see [Operating a RAM Disk on page 3-34](#).

### ■ Virtual Mailbox

Virtual mailbox is part of Job Storage, which stores print jobs on the hard disk without printing. It enables you to retrieve jobs later from the operator panel, the Print Disk Manager utility (in the CD-ROM), or the barcode reader.

Each mailbox may be used by an individual who desires to share the printer in this mode. By default, each mailbox is numbered from 'Tray 001,' 'Tray 002,' ... etc. To 'post' a job in one of these mailboxes, you assign a numbered or named mailbox on the printer driver when printing.

To retrieve the stored job for printing, see [Retrieving Jobs from Virtual Mailbox \(VMB\) on page 3-15](#).

#### NOTE

The virtual mailbox can be used in PCL 6 emulation only.

### Using Quick Copy

This mode enables you to print the requested number of copies of a job, simultaneously storing the job on the hard disk. When additional copies are required, you can reprint the required number of copies from the printer operator panel. To print a job as a quick copy job, see [Printer Driver Guide](#).

The default number of print jobs that can be stored on the hard disk is 32. This value can be increased to up to 50 from the e-MPS Configuration menu. For details, see [Changing e-MPS Configuration on page 3-16](#). When the number of jobs reaches the limit, the oldest job will be overwritten by the new one.

When the printer is turned off, all stored jobs will be deleted.

### ■ Printing Additional Copies using Quick Copy

To print additional copies of a job stored in the printer:

**1** Press the **MENU** key.

**2** Press the  $\Delta$  or  $\nabla$  key repeatedly until e-MPS > appears.

```
e-MPS >
```

**3** Press the  $\triangleright$  key.

**4** Press the  $\Delta$  or  $\nabla$  key repeatedly until >Quick Copy appears followed by the user name (Harold, in this example). The user name is assigned at printing using the printer driver.

```
>Quick Copy
Harold
```

**5** Press the **ENTER** key. A blinking question mark (?) appears before the user name.

```
>Quick Copy
?Harold
```

**6** Press the  $\Delta$  or  $\nabla$  key to display the desired user name, Arlen, in this example.

```
>Quick Copy
?Arlen
```

**7** Press the **ENTER** key. The job name entered in the printer driver (Report, in this example) appear with a blinking question mark (?) before the letters.

```
>Arlen
?Report
```

**8** Press the  $\Delta$  or  $\nabla$  key to scroll to the desired job title.

**9** Press the **ENTER** key. The number of copies to be printed can be set. To increase the copy count, press the  $\Delta$  key; to decrease the copy count, press the  $\nabla$  key.

```
>Report
Copies 001
```

**10** Press the **ENTER** key to finalize the copy count. The printer prints the specified number of copies for the job.

### ■ Deleting a Quick Copy Job

All quick copy jobs are automatically deleted when the printer is turned off. If you desire to explicitly delete a stored quick copy job, proceed as follows:

**1** Follow steps 1 through 8 in the above section to display the title of the job to be deleted.

**2** When the title of the job to be deleted is displayed, e.g. Report, below, press the **ENTER** key. The cursor below the copy count starts to blink.

```
>Report
Copies 001
```

## Chapter 3 Using the Operator Panel

- Press the  $\nabla$  key repeatedly until `Delete` appears below the title.

```
>Report
Delete
```



- Press the **ENTER** key. The stored quick copy job is deleted.

### Using Proof-and-Hold

When you print multiple copies, this mode first prints one copy so that you can proof it before continuing to print the remaining copies. Since you can proof the printouts before printing the remaining copies, wastage of paper can be reduced.

The printer prints one copy and, at the same time, saves the print job on the hard disk. You can also change the number of copies when resuming printing from the operator panel.

When the printer is turned off, all stored jobs will be deleted.

### ■ Printing Remaining Copies of a Proof and Hold Job

Printing a Proof-and-Hold job on the operator panel is similar to printing a quick copy job. To print remaining copies of a job held in the printer:

- Press the **MENU** key.
- Press the  $\Delta$  or  $\nabla$  key repeatedly until `e-MPS >` appears.

```
e-MPS >
```

- Press the  $\triangleright$  key.
- Press the  $\Delta$  or  $\nabla$  key repeatedly until `>Quick Copy` appears followed by the user name (`Harold`, in this example). The user name is assigned at printing using the printer driver.

```
>Quick Copy
Harold
```

- Press the **ENTER** key. A blinking question mark (?) appears before the user name.

```
>Quick Copy
?Harold
```



- Press the  $\Delta$  or  $\nabla$  key to display the desired user name, `Arlen`, in this example.

```
>Quick Copy
?Arlen
```

- Press the **ENTER** key. The job name entered in the printer driver (`Report`, in this example) appears with a blinking question mark (?) before the letters.

```
>Arlen
?Report
```



- Press the  $\Delta$  or  $\nabla$  key to scroll to the desired job title.

- Press the **ENTER** key. The number of copies to be printed can be set. To increase the copy count, press the  $\Delta$  key; to decrease the copy count, press the  $\nabla$  key.

```
>Report
Copies 001
```



- Press the **ENTER** key to finalize the copy count. The printer prints the specified number of copies for the job.

### Printing a Private Job

In private printing, you can specify that a job is not printed until you release the job from the operator panel. At sending the job from the application software, you can specify a 4-digit access code in the printer driver. The job is released for printing by entering the access code on the operator panel. Thus, this function ensures confidentiality of the print job.

When the printer is turned off, all the print jobs will be deleted.

### ■ Releasing a Private Job

- Press the **MENU** key.
- Press the  $\Delta$  or  $\nabla$  key repeatedly until `e-MPS >` appears.
- Press the  $\triangleright$  key.
- Press the  $\Delta$  or  $\nabla$  key repeatedly until `>Private/ Stored` appears. The name entered in the printer driver (`Harold`, in this example) also appears.

```
e-MPS >
```

```
>Private/ Stored
```

```
>Private/ Stored
Harold
```

- Press the **ENTER** key. A blinking question mark (?) appears before the user name.

```
>Private/ Stored
?Harold
```



- 6** Press the  $\Delta$  or  $\nabla$  key to display the desired user name (Arlen, in this example).

```
>Private/Stored
?Arlen
```

- 7** Press the **ENTER** key. The user name and the job name (Agenda, in this example) entered in the printer driver appear with a blinking question mark (?).

```
>Arlen
?Agenda
```

- 8** Press the  $\Delta$  or  $\nabla$  key to display the desired job title.

- 9** Press the **ENTER** key. The ID input line appears. Enter the four-digit access code entered in the printer driver and press the **ENTER** key. To enter the ID, Press the  $\triangleleft$  or  $\triangleright$  key to move the cursor to the number to be changed and then enter the correct number by pressing the  $\Delta$  or  $\nabla$  key.

```
>Agenda
ID      0000
```

- 10** You can set the number of copies to be printed. To increase the copy count, press the  $\Delta$  key; to decrease the copy count, press the  $\nabla$  key.

```
>Agenda
Copies  001
```

- 11** Press the **ENTER** key to finalize the copy count. The printer prints the specified number of copies for the job.

■ **Deleting a Private Job**

- 1** Follow steps 1 through 8 in the above section.

- 2** When the title of the job to be printed is displayed (Agenda, in this example), press the **ENTER** key. Enter the four-digit access code entered in the printer driver and press the **ENTER** key.

```
>Agenda
Copies  001
```

- 3** Press the  $\nabla$  key repeatedly until **Delete** appears for the number of copies.

```
>Agenda
Delete
```

- 4** Press the **ENTER** key. The private job is deleted from the hard disk.

■ **Storing a Print Job**

You can download a job to the hard disk without printing it. This allows you to store print jobs that are frequently needed such as fax cover pages, check lists, and order forms, for printing at any later time using the operator panel.

The print jobs are not deleted even when the printer is turned off.

■ **Releasing a Stored Job**

To print a stored job through the operator panel:

- 1** Press the **MENU** key.

- 2** Press the  $\Delta$  or  $\nabla$  key repeatedly until **e-MPS** > appears.

```
e-MPS >
```

- 3** Press the  $\triangleright$  key.

- 4** Press the  $\Delta$  or  $\nabla$  key repeatedly until **>Private/Stored** appears. The name entered for User Name in the printer driver (Harold, in this example) also appears.

```
>Private/Stored
Harold
```

- 5** Press the **ENTER** key. A blinking question mark (?) before a user name appears.

```
>Private/Stored
?Harold
```

- 6** Press the  $\Delta$  or  $\nabla$  key to display the desired user name (Arlen, in this example).

```
>Private/Stored
?Arlen
```

- 7** Press the **ENTER** key. The user name and the job name entered in the printer driver (Agenda, in this example) appear with a blinking question mark (?) before the letter.

```
>Arlen
?Agenda
```

- 8** Press the  $\Delta$  or  $\nabla$  key to display the desired job title.

## Chapter 3 Using the Operator Panel

- 9 Press the **ENTER** key. If you entered an access code for the printer driver, the ID input line appears. Enter the four-digit access code entered in the printer driver.

To enter the ID, Press the  $\triangleleft$  or  $\triangleright$  key to move the cursor to the number to be changed and then enter the correct number by pressing the  $\triangle$  or  $\nabla$  key.

```
>Agenda
ID      0000
```

- 10 Press the **ENTER** key. You can specify the number of copies to print. To increase the copy count, press the  $\triangle$  key; to decrease the  $\nabla$  key.

```
>Agenda
Copies  001
```

- 11 Press the **ENTER** key to finalize the copy count. The printer prints the specified number of copies for the job.

```
>Agenda
?Copies 001
```

### ■ Deleting a Stored Job

- 1 Follow steps 1 through 8 in the above section.
- 2 When the title of the job to be printed is displayed (Agenda, in this example), press the **ENTER** key.

```
>Agenda
Copies  001
```

- 3 Press the  $\nabla$  key repeatedly until **Delete** appears for the number of copies.

```
>Agenda
Delete
```

- 4 Press the **ENTER** key. The stored job is deleted from the hard disk.

### Printing a List of Code Jobs

If you select Permanent Job Storage on the printer driver, you can have a List of Code Job printed using the operator panel. The List of Code Job may be used to read the barcode ID for the stored job you want to reprint by using a barcode reader. See [Appendix D Option Units](#).

A sample Code Job List is shown [on page 3-15](#).

- 1 Press the **MENU** key.

- 2 Press the  $\triangle$  or  $\nabla$  key repeatedly until **e-MPS >** appears.

```
e-MPS >
```

- 3 Press the  $\triangleright$  key.

- 4 Press the  $\triangle$  or  $\nabla$  key repeatedly until **>List of Code JOB** appears.

```
>List of
Code JOB
```

- 5 Press the **ENTER** key. A question mark (?) appears.

```
>List of
Code JOB ?
```

- 6 Press the **ENTER** key again. The printer prints a Code Job list as shown below.

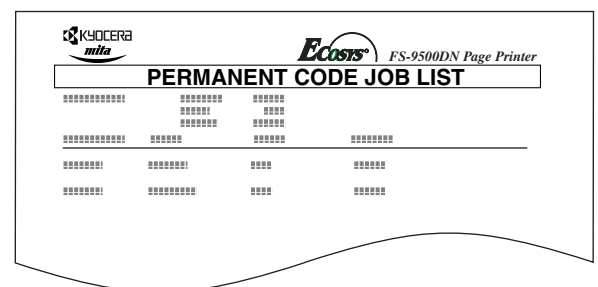

### Retrieving Jobs from Virtual Mailbox (VMB)

To retrieve the jobs posted in the virtual mailbox, proceed as follows.

- 1 Press the **MENU** key.

- 2 Press the  $\triangle$  or  $\nabla$  key repeatedly until **e-MPS >** appears.

```
e-MPS >
```

- 3 Press the  $\triangleright$  key.

- 4 Press the  $\triangle$  or  $\nabla$  key repeatedly until **>Print VMB Data** appears. The virtual mailbox number will also appear.

```
>Print VMB Data
Tray001:
```

If you have named the virtual mailbox with an alias on the printer driver, the alias (Richard, in this example) will follow the number:

```
>Print VMB Data
Tray001:Richard
```

**5** Press the **ENTER** key. A blinking question mark (?) appears.

```
>Print VMB Data
Tray001?
```

**6** Press the **ENTER** key. The document in the mailbox is printed and automatically deleted from the mailbox.

**■ Printing a List of VMB**

A Virtual Mailbox list includes the jobs currently stored in the mailboxes.

**1** Press the **MENU** key.

**2** Press the  $\Delta$  or  $\nabla$  key repeatedly until e-MPS > appears.

```
e-MPS >
```

**3** Press the  $\triangleright$  key.

**4** Press the  $\Delta$  or  $\nabla$  key repeatedly until >List of VMB appears.

```
>List of VMB
```

**5** Press the **ENTER** key. A question mark (?) appears.

```
>List of VMB ?
```

**6** Press the **ENTER** key again. The printer prints a list of jobs currently posted in the virtual mailboxes as shown below.

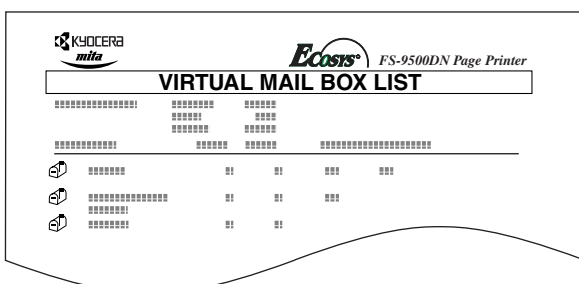

**Changing e-MPS Configuration**

You can change the following parameters for e-MPS operation:

- Maximum number of Quick Copy/Proof-and-Hold jobs
- Maximum space assigned to temporary code jobs
- Maximum space assigned to permanent code jobs
- Maximum space assigned to virtual mailboxes

**NOTE**  
The total amount of storage area specified must not exceed the total size of the hard disk. Otherwise, you may only be able to accommodate a smaller number of print jobs than specified.

**■ Changing the Maximum Number of Quick Copy/Proof-and-Hold Jobs**

This changes maximum number of Quick Copy/Proof-and-Hold jobs from 0 to 50. The default is 32.

**1** Press the **MENU** key.

**2** Press the  $\Delta$  or  $\nabla$  key repeatedly until e-MPS > appears.

```
e-MPS >
```

**3** Press the  $\triangleright$  key.

**4** Press the  $\Delta$  or  $\nabla$  key repeatedly until >e-MPS Configuration > appears.

```
>e-MPS >
Configuration
```

**5** Press the  $\triangleright$  key.

**6** Press the  $\Delta$  or  $\nabla$  key repeatedly until >>Quick Copy appears.

```
>>Quick Copy
32
```

**7** Press the **ENTER** key. A blinking cursor ( ) appears.

```
>>Quick Copy
32
```

**8** Press the  $\Delta$  or  $\nabla$  key to increase or decrease the value at the blinking cursor. The value can be set between 0 and 50. Use the  $\triangleright$  and  $\triangleleft$  keys to move the cursor right and left.



**9** When the desired maximum number of jobs is set, press the **ENTER** key.

**10** Press the **MENU** key. The display returns to *Ready*.

### ■ Maximum Space Assigned to Temporary Code Jobs

This changes the hard disk space that holds temporary code jobs. You can change the maximum space from 0 to 9999 (megabytes). The actual maximum size depends on the size of free hard disk space, however. The default size is 1/6 of the total hard disk space, rounded off in units of 50 MB. For example, if the total hard disk space is 3.2 GB, the default size is 500 MB.

**1** Press the **MENU** key.

**2** Press the  $\Delta$  or  $\nabla$  key repeatedly until *e-MPS >* appears.

```
e-MPS >
```

**3** Press the  $\triangleright$  key.

**4** Press the  $\Delta$  or  $\nabla$  key repeatedly until *>e-MPS Configuration >* appears.

```
>e-MPS >  
Configuration
```

**5** Press the  $\triangleright$  key.

**6** Press the  $\Delta$  or  $\nabla$  key repeatedly until *>>Temp. Code JOB Size* appears.

```
>>Temp. Code JOB  
Size 0500MB
```

**7** To change the maximum disk space, press the **ENTER** key. A blinking cursor (  ) appears.

```
>>Temp. Code JOB  
Size 0500MB
```

**8** Press the  $\Delta$  or  $\nabla$  key to increase or decrease, respectively, the value at the blinking cursor. Use the  $\triangleright$  and  $\triangleleft$  keys to move the cursor right and left.

**9** When the desired size is displayed, press the **ENTER** key.

**10** Press the **MENU** key. The display returns to *Ready*.

### ■ Maximum Space Assigned to Permanent Code Jobs

This changes the hard disk space that holds permanent code jobs. You can change the maximum space from 0 to 9999 (megabytes). The actual maximum size depends on the size of free hard disk space, however. The default size is 1/6 of the total hard disk space, rounded off in units of 50 MB. For example, if the total hard disk space is 3.2 GB, the default size is 500 MB.

**1** Press the **MENU** key.

**2** Press the  $\Delta$  or  $\nabla$  key and select *e-MPS >*.

```
e-MPS >
```

**3** Press the  $\triangleright$  key.

**4** Press the  $\Delta$  or  $\nabla$  key repeatedly until *>e-MPS Configuration >* appears.

```
>e-MPS >  
Configuration
```

**5** Press the  $\triangleright$  key.

**6** Press the  $\Delta$  or  $\nabla$  key and select *>>Perm. Code JOB Size*.

```
>>Perm. Code JOB  
Size 0500MB
```

**7** Press the **ENTER** key, the message display shows a blinking cursor (  ).

```
>>Perm. Code JOB  
Size 0500MB
```

**8** Press the  $\Delta$  or  $\nabla$  key to increase or decrease, respectively, the value at the blinking cursor. Use the  $\triangleright$  and  $\triangleleft$  keys to move the cursor right and left.

**9** When the desired size is displayed, press the **ENTER** key.

**10** Press the **MENU** key and the message display returns to *Ready*.

### ■ Maximum Space Assigned to Virtual Mailboxes (VMB)

This changes the hard disk space for virtual mailboxes. You can change the maximum space from 0 to 9999 (megabytes). The actual maximum size depends on the size of free hard disk space, however. The default size is 1/6 of the total hard disk space, rounded off in unit of 50 MB. For example, if the total hard disk space is 3.2 GB, the default size is 500 MB.

**1** Press the **MENU** key.

**2** Press the  $\Delta$  or  $\nabla$  key until `e-MPS >` appears.

```
e-MPS >
```

**3** Press the  $\triangleright$  key.

**4** Press the  $\Delta$  or  $\nabla$  key and select `>e-MPS Configuration >`.

```
>e-MPS >
Configuration
```

**5** Press the  $\triangleright$  key.

**6** Press the  $\Delta$  or  $\nabla$  key and select `>>VMB Size`.

```
>>VMB Size
0500MB
```

**7** To change the maximum size, press the **ENTER** key. The message display shows a blinking cursor (`_`).

```
>>VMB Size
0500MB
  ^
```

**8** Press the  $\Delta$  or  $\nabla$  key to increase or decrease, respectively, the value at the blinking cursor. Use the  $\triangleright$  and  $\triangleleft$  keys to move the cursor right and left.

**9** When the desired size is displayed, press the **ENTER** key.

**10** Press the **MENU** key to exit the menu selection.

### 2.2.4 Changing the Interface Parameters

The printer is equipped with both a parallel and serial interface or a network interface. Various printing environment parameters such as the default emulation can be changed independently on different interfaces by using the printer's menu selection system. Select the interface to apply the changes in the procedure described below.

#### NOTE

This interface selection described below does not select which interface data will be received from. The printer automatically selects an interface.

#### ■ Changing Parallel Interface Modes

The parallel interface mode of this printer supports a bi-directional/high-speed mode. Normally, this interface is used under the default setting Nibble (high). For details, see [Appendix C Host Computer Interface](#). After setting the interface, be sure to reset the printer or turn the power off at least once. The new setting will be enabled thereafter.

**1** Press the **MENU** key.

**2** Press the  $\Delta$  or  $\nabla$  key repeatedly until `Interface >` appears. One of the interface names shown below appears, indicating the current interface.

```
Parallel (default)
Serial
Network
Option (only when an optional network interface
card is installed)
```

**3** Press the **ENTER** key. A blinking question mark (?) appears.

```
Interface >
?Parallel
```

If `Parallel` is not displayed, press the  $\Delta$  or  $\nabla$  key repeatedly until `Parallel` appears.

**4** Press the **ENTER** key again.

**5** Press the  $\triangleright$  key. The message display changes to the communication mode menu.

**6** Press the **ENTER** key. A blinking question mark (?) appears.

```
>Parallel I/F
?Nibble (high)
```

- 7** Press the  $\Delta$  or  $\nabla$  key to display the desired mode. The display changes as shown below. Press the **ENTER** key.

```
Nibble (high) (default)
AUTO
Normal
High speed
```

- 8** Press the **MENU** key. The message display returns to Ready.

### ■ Changing Serial Interface Modes

You can set the baud rate, data bits, stop bits, parity, and protocol for the serial interface.

- 1** Press the **MENU** key.

- 2** Press the  $\Delta$  or  $\nabla$  key repeatedly until `Interface >` appears. One of the interface names shown below appears, indicating the current interface.

```
Parallel (default)
Serial
Network
Option (only when an optional network interface
card is installed)
```

- 3** Press the **ENTER** key. A blinking question mark (?) appears.

```
Interface
?Parallel
```

- 4** Press the  $\Delta$  or  $\nabla$  key repeatedly until `Serial` appears.

```
Interface
?Serial
```

- 5** Press the **ENTER** key again.

- 6** Press the  $\triangleright$  key. Each time the  $\Delta$  or  $\nabla$  key is pressed, the setting item and current setting change as shown below.

```
>Baud Rate
9600
```

Definable baud rates:  
1200, 2400, 4800, 9600  
(default), 19200,  
38400, 57600, 115200



```
>Data Bits
8
```

Definable stop bits: 7, 8  
(default)



```
>Stop Bits
1
```

Definable data bits: 1 (de-  
fault), 2



```
>Parity
None
```

Definable parity: None  
(default), Odd, Even, Ig-  
nore



```
>Protocol
DTR (pos.) & XON
```

Definable protocol: DTR  
(pos.) & XON (default),  
DTP (positive), DTR (neg-  
ative), XON/XOFF, ETX/  
ACK



```
>Barcode Mode
Off
```

If set to On when the option  
barcode reader is installed,  
the mode of the serial inter-  
face will be the barcode  
mode.

- 7** Display the setting item to be changed and press the **ENTER** key. A question mark (?) appears.

The following example explains how to change the baud rate. The settings for other items can be changed in a similar manner.

```
>Baud Rate
? 9600
```

- 8** Press the  $\Delta$  or  $\nabla$  key to display the desired setting. The baud rate can be selected from 1200, 2400, 4800, 9600 (default), 19200, 38400, 57600, and 115200.

### NOTE

Some computers may not be compatible with a baud rate of 115200 bps. If you set the baud rate to 115200 and communication problems occur, lower the baud rate.

**9** Display the desired baud rate and press the **ENTER** key.

**10** Press the **MENU** key. The message display returns to Ready.

**Changing Network Interface Parameters**

This printer is equipped with the network interface.

For details on networking, refer to the "Quick Configuration Guide".

**1** Press the **MENU** key.

**2** Press the  $\Delta$  or  $\nabla$  key repeatedly until `Interface >` appears. One of the interface names shown below appears, indicating the current interface.

```
Parallel (default)
Serial
Network
Option (only when an optional network interface
card is installed)
```

**3** Press the **ENTER** key. A blinking question mark (?) appears.

```
Interface
?Parallel
```

**4** Press the  $\Delta$  or  $\nabla$  key repeatedly until `Network` appears.

```
Interface
?Network
```

**5** Press the **ENTER** key again.

**6** Press the  $\triangleright$  key. Each time the  $\Delta$  or  $\nabla$  key is pressed, the display changes as shown below.

```
>NetWare
  On
```



```
>TCP/IP
  On
```



```
>EtherTalk
  Off
```



```
>Network Status
  Page On
```



```
>Opt. StatusPage
  On
```

If turns ON, print the standard Network Interface Status Page after the Printer Status Page. See [page 3-10](#).

If turns ON, print the optional Network Interface Status Page after the Printer Status Page. See [page 3-10](#).

**7** The following example explains how to activate TCP/IP protocol to connect the printer in the network. You can select Netware or EtherTalk in a similar manner.

```
>TCP/IP >
  On
```

If TCP/IP is currently displays `Off`, select `On` using the  $\Delta$  or  $\nabla$  key. Press the **ENTER** key again.

```
>TCP/IP
? Off
```



```
>TCP/IP >
  On
```

- 8** Press the  $\triangleright$  key. Each time the  $\triangle$  or  $\nabla$  key is pressed, the item changes as shown below.

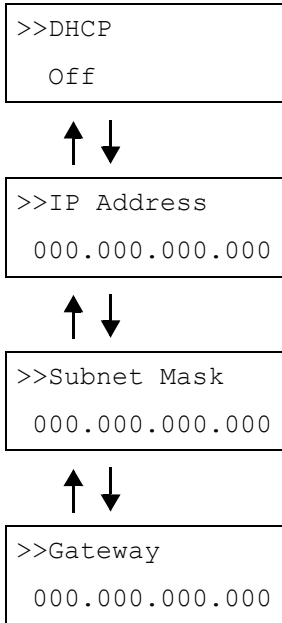

- 9** Display the item to be set and press the **ENTER** key. For DHCP, a question mark (?) appears. For IP Address, Subnet Mask, and Gateway addresses, the cursor ( `_` ) blinks.

- 10** For DHCP, select `On` or `Off` using the  $\triangle$  or  $\nabla$  key. For IP Address, Subnet Mask, and Gateway addresses, press the  $\triangle$  or  $\nabla$  key to change the number (000 to 255) where the cursor is blinking. You can use the  $\triangleleft$  and  $\triangleright$  key to move the cursor right and left.

To obtain these addresses, consult your network administrator.

- 11** Press the **ENTER** key.

- 12** Press the **MENU** key. The message display returns to `Ready`.

### ■ Printing a Network Interface Status Page

You can print out a status page for the network interface. The network interface status page shows the firmware version, the network addresses, and other information under various network protocols about the network interface. The default setting is `On` (print). The network interface status page will be printed out after the printer status page.

#### NOTE

Printing out a network interface status page may not be possible with some optional network interface cards. For details, see the manual for the network interface.

- 1** Press the **MENU** key.

- 2** Press the  $\triangle$  or  $\nabla$  key repeatedly until `Interface >` appears.

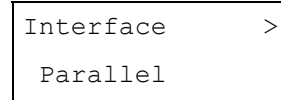

- 3** Press the **ENTER** key. A blinking question mark (?) appears.

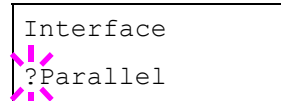

- 4** Press the  $\triangle$  or  $\nabla$  key repeatedly until `Network` appears.

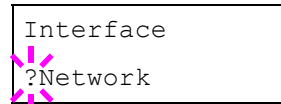

- 5** Press the **ENTER** key again. The question mark (?) disappears

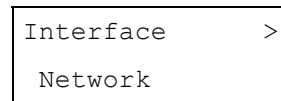

- 6** Press the  $\triangleright$  key and then press the  $\triangle$  or  $\nabla$  key repeatedly until the message display indicates `>Network Status Page`.

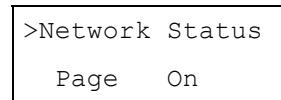

- 7** The default setting is `On`. If it is set to `Off`, change it as follows. Press the **ENTER** key. A blinking question mark (?) appears.

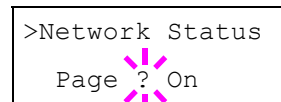

- 8** Select `On` using the  $\triangle$  or  $\nabla$  key.

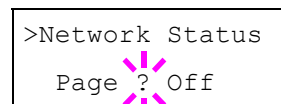

- 9** Press the **ENTER** key again.

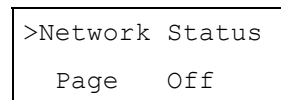

- 10 Press the **MENU** key. The message display returns to Ready.

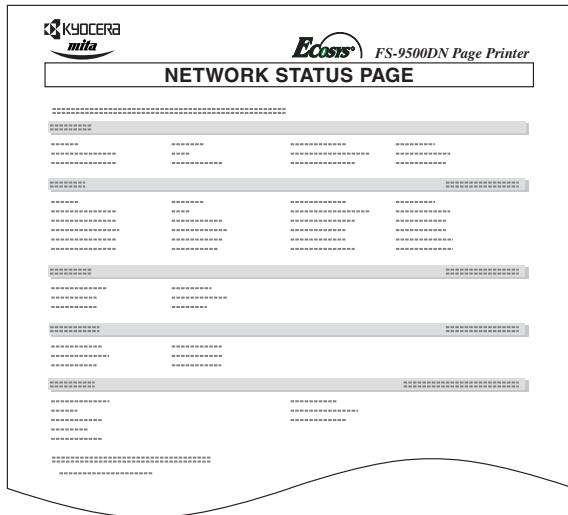

Network Status Page

### 2.2.5 Changing the Emulation

The emulation mode for the current interface can be changed.

- 1 Press the **MENU** key.
- 2 Press the  $\Delta$  or  $\nabla$  key repeatedly until `Emulation` appears. One of the emulation names shown below appears, indicating the current emulation.
  - PCL 6 (default)
  - KC-GL
  - KPDL
  - KPDL (AUTO)
  - Line Printer
  - IBM Proprinter
  - DIABLO 630
  - EPSON LQ-850

- 3 Press the **ENTER** key. A blinking question mark (?) appears.

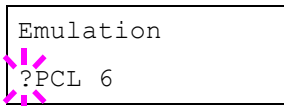

- 4 Press the  $\Delta$  or  $\nabla$  key repeatedly until the desired emulation mode appears.

- 5 Press the **ENTER** key. The  $\triangleright$  key allows access to sub item `>Code set`.

- 6 Press the **MENU** key. The message display returns to Ready.

After changing the emulation, you have the option to change the character code set. Available character code sets vary depending on the current emulation.

#### KPDL (AUTO) Emulation

KPDL is the Kyocera's implementation of the PostScript language. The KPDL (AUTO) emulation enables the printer to automatically change the emulation mode according to the data received when printing.

In addition to KPDL (AUTO) emulation, you can use the operator panel to set another emulation mode that is used very often. The default setting is PCL 6.

- 1 Press the **MENU** key.
- 2 Press the  $\Delta$  or  $\nabla$  key repeatedly until `Emulation >` appears.

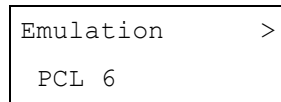

- 3 Press the **ENTER** key. A blinking question mark (?) appears.

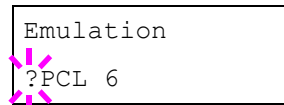

- 4 Press the  $\Delta$  or  $\nabla$  key repeatedly until `KPDL (AUTO)` appears.

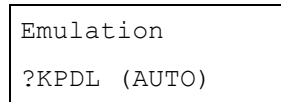

- 5 Press the **ENTER** key.

- 6 Press the  $\triangleright$  key. When `> Alt. Emulation` is displayed, press the  $\Delta$  or  $\nabla$  key. The names of alternative emulations appear.

- PCL 6 (default)
- KC-GL
- Line Printer
- IBM Proprinter
- DIABLO 630
- EPSON LQ-850

- 7 Press the **ENTER** key. A blinking question mark (?) appears.

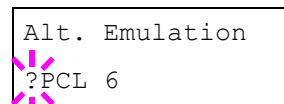

**8** Press the  $\Delta$  or  $\nabla$  key repeatedly until the desired alternative emulation appears.

**9** Press the **ENTER** key.

**10** Press the **MENU** key. The message display returns to Ready.

### Auto Printing of KPDL Error

The printer can be set to print error data during KPDL emulation. If this is set to **On**, error data will be printed only when trouble occurs during printing. The factory default setting is **Off**.

**1** Press the **MENU** key.

**2** Press the  $\Delta$  or  $\nabla$  key repeatedly until **Emulation >** appears.

```
Emulation >
PCL 6
```

**3** Press the **ENTER** key. A blinking question mark (?) appears.

```
Emulation
?PCL 6
```

**4** Select **KPDL** or **KPDL (AUTO)** using the  $\Delta$  or  $\nabla$  key.

```
Emulation
?KPDL
```

**5** Press the **ENTER** key.

**6** Press the  $\triangleright$  key. The message display changes to that shown below. If **>Print KPDL Errs** is displayed when the **KPDL (AUTO)** emulation is selected, press the  $\Delta$  or  $\nabla$  key to change it.

```
>Print KPDL Errs
Off
```

**7** Press the **ENTER** key. A blinking question mark (?) appears.

```
>Print KPDL Errs
?Off
```

**8** Select **On** using the  $\Delta$  or  $\nabla$  key.

```
>Print KPDL Errs
?On
```

**9** Press the **ENTER** key.

**10** Press the **MENU** key. The message display returns to Ready.

### KC-GL Pen Width

The KC-GL emulation mode enables you to set the pen widths in dots, for pen numbers 1 to 8, and the KC-GL page size.

**1** Press the **MENU** key.

**2** Press the  $\Delta$  or  $\nabla$  key repeatedly until **Emulation** appears on the message display.

```
Emulation >
PCL 6
```

**3** If the current emulation is other than **KC-GL**, press the **ENTER** key. A blinking question mark (?) appears.

```
Emulation
?PCL 6
```

**4** Press the  $\Delta$  or  $\nabla$  key repeatedly until **KC-GL** appears.

```
Emulation
?KC-GL
```

**5** Press the **ENTER** key.

```
Emulation >
KC-GL
```

**6** Press the  $\triangleright$  key to move to the **>KC-GL Pen Width** submenu.

```
>KC-GL >
Pen Width
```

**7** Press the  $\triangleright$  key.

```
>>Pen (1) Width
01 dot (s)
```

**8** Press the  $\Delta$  or  $\nabla$  key repeatedly until the desired pen number of 1 to 8 appears.

**9** When the desired pen number is displayed, press the **ENTER** key.

- 10** To change the pen width, press the  $\triangleright$  key, then press the **ENTER** key. A blinking cursor appears at the width value.

```
>>Pen(1) Width
      02 dot(s)
```

Press the  $\triangle$  or  $\nabla$  key repeatedly until the desired pen width in dots (00 to 99) appears. When the desired pen width is displayed, press the **ENTER** key.

- 11** To set the KC-GL page size, press the  $\triangleleft$  key, then press the  $\triangle$  or  $\nabla$  key until  $>KC-GL$  Page Set is displayed.

- 12** To change the page size, press the **ENTER** key. A blinking question mark (?) appears.

```
>KC-GL Page Set
? [SPSZ]
```

Press the 3 or 4 key repeatedly until the desired page size (A2, A1, A0, B3, B2, B1, B0, and SPSZ) appears. When selecting SPSZ, printing will be done with the paper size specified by the PRESCRIBE SPSZ command. For details, see *Programming Manual* in the CD-ROM.

- 13** Press the **ENTER** key to set the page set you just selected.

- 14** Press the **MENU** key. The display returns to Ready.

### 2.2.6 Setting the Default Font

You can select the default font for the current interface. In addition to the internal fonts, all fonts that are downloaded to the printer memory, or fonts stored on a memory card, hard disk, or option ROM, can be selected as the default font.

In this menu, you can also set the type and pitch for Courier and Letter Gothic; as well as print a font list.

#### Selecting the Default Font

- 1** Press the **MENU** key.
- 2** Press the  $\triangle$  or  $\nabla$  key repeatedly until `Font >` appears.

```
Font >
```

- 3** Press the  $\triangleright$  key to select an internal font, press the  $\triangle$  or  $\nabla$  key repeatedly until `Internal` appears.

```
>Font Select >
  Internal
```

To select an option font, press the **ENTER** key while `>Font Select >` is displayed. Press the  $\triangle$  or  $\nabla$  key repeatedly until the message display indicates `Option`. This operation is possible only when option fonts are installed in the printer.

- 4** Press the  $\triangleright$  key.

```
>> I000
```

The letter before the number indicates the type of font as follows:

Letter	Description
I	Internal fonts
S	Soft (down load) fonts
M	Fonts in an option memory card
H	Fonts in a RAM disk or hard disk
O	Fonts in an option ROM

- 5** Press the **ENTER** key. A blinking question mark (?) appears.

```
>>?I000
```

- 6** Press the  $\triangle$  or  $\nabla$  key repeatedly until the desired font number appears. For font numbers of the internal fonts, see *List of Fonts on page A-1*.

```
>Font Select >
  Internal
```

- 7** When the desired font is displayed, press the **ENTER** key.

- 8** Press the **MENU** key. The message display returns to Ready.



## Chapter 3 Using the Operator Panel

### ■ Changing Type for Courier/Letter Gothic

Courier or Letter Gothic font type can be selected as Regular or Dark. For example, to change the type of Courier, proceed as follows:

**1** Press the **MENU** key.

**2** Press the  $\Delta$  or  $\nabla$  key repeatedly until `Font >` appears.

```
Font >
```

**3** Press the  $\triangleright$  key.

**4** Check that `Internal` is displayed and press the  $\triangleright$  key.

```
>Font Select >
Internal
```

**5** Press the  $\Delta$  or  $\nabla$  key repeatedly until `>Courier` appears.

```
>>Courier
Regular
```

**6** Press the **ENTER** key. A blinking question mark (?) appears.

```
>>Courier
? Regular
```

**7** Select `Regular` or `Dark` using the  $\Delta$  or  $\nabla$  key.

**8** Press the **ENTER** key.

**9** Press the **MENU** key and the message display returns to `Ready`.

### ■ Changing the Font Size

You can change the size of the default font. If the default font is a fixed-pitch font such as Courier or Letter Gothic, the character pitch can be changed instead of the font size.

**1** Press the **MENU** key.

**2** Press the  $\Delta$  or  $\nabla$  key repeatedly until `Font >` appears.

```
Font >
```

**3** Press the  $\triangleright$  key.

**4** Check that `Internal` is displayed and press the  $\triangleright$  key.

```
>Font Select >
Internal
```

**5** Press the  $\Delta$  or  $\nabla$  key repeatedly until `>Size` appears.

```
>Size
012.00 point(s)
```

**6** Press the **ENTER** key. A blinking cursor ( `_` ) appears.

```
>Size
012.00 point(s)
```

**7** Press the  $\Delta$  or  $\nabla$  key to increase or decrease the value of the figure where the cursor is blinking. The font size can be set between 4 and 999.75 points, in 0.25-point increments. You can use the  $\triangleright$  and  $\triangleleft$  key to move the cursor right and left.

**8** When the desired size is displayed, press the **ENTER** key.

**9** Press the **MENU** key. The message display returns to `Ready`.

### ■ Setting the Character Pitch for Courier/Letter Gothic

You can set the character pitch for fixed-pitch fonts when the default font is Courier or Letter Gothic.

**1** Press the **MENU** key.

**2** Press the  $\Delta$  or  $\nabla$  key repeatedly until `Font >` appears.

```
Font >
```

**3** Press the  $\triangleright$  key.

**4** Check that `Internal` is displayed and press the  $\triangleright$  key.

```
>Font Select >
Internal
```

- 5 Press the  $\Delta$  or  $\nabla$  key repeatedly until `>Pitch` appears.

```
>Pitch
    10.00 cpi
```

- 6 Press the **ENTER** key. A blinking cursor (`_`) appears.

```
>Pitch
    10.00 cpi
      ^
```

- 7 Press the  $\Delta$  or  $\nabla$  key to increase or decrease the value of the figure where the cursor is blinking. The character pitch can be set between 0.44 and 99.99 characters per inch, in 0.01 character-per-inch increments. You can use the  $\triangleright$  and  $\triangleleft$  keys to move the cursor right and left.

- 8 When the desired size is displayed, press the **ENTER** key.

- 9 Press the **MENU** key. The message display returns to `Ready`.

### Printing a List of Fonts

To help in selecting fonts, you can print a list of the fonts including option fonts.

- 1 Press the **MENU** key.

- 2 Press the  $\Delta$  or  $\nabla$  key repeatedly until `Font >` appears.

```
Font >
```

- 3 Press the  $\triangleright$  key.

- 4 Press the  $\Delta$  or  $\nabla$  key repeatedly until `List of Internal Fonts` appears. `List of Option Fonts` appears.

(Internal Fonts)

```
>List of
    Internal Fonts
```

(Optional Fonts)

```
>List of
    Option Fonts
```

- 5 Press the **ENTER** key. A question mark (?) appears.

(Internal Fonts)

```
>List of
    Internal Fonts?
```

(Optional Fonts)

```
>List of
    Option Fonts ?
```

- 6 Press the **ENTER** key again. Processing appears, then `Ready`. The printer prints a list of fonts with a short sample and font ID (number) for each font.

List of Fonts

### 2.2.7 Using Page Set Menus

In Page Set menus, you can set the number of copies, the page orientation, and other settings regarding pagination.

#### Setting the Number of Copies

You can set the number of copies of each page to be printed for the current interface. The number of copies can be set between 1 and 999. The number of copies can be set whenever the message display indicates `Ready`.

- 1 Press the **MENU** key.

## Chapter 3 Using the Operator Panel

- 2** Press the  $\Delta$  or  $\nabla$  key repeatedly until `Page set >` appears.

```
Page Set >
```

- 3** Press the  $\triangleright$  key.

- 4** Press the  $\Delta$  or  $\nabla$  key repeatedly until `>Copies` appears.

```
>Copies
001
```

- 5** Press the **ENTER** key. A blinking cursor ( `_` ) appears.

```
>Copies
001_
```

- 6** Press the  $\Delta$  or  $\nabla$  key to increase or decrease the value of the figure where the cursor is blinking. It can be set between 1 and 999. You can use the  $\triangleright$  and  $\triangleleft$  keys to move the cursor right and left.

- 7** When the desired size is displayed, press the **ENTER** key.

- 8** Press the **MENU** key. The message display returns to `Ready`.

### Selecting the Reduced Print

You can print with the reduced size. This menu is used to set the source paper size and the paper size to use after reduction.

#### NOTE

Printed results when making reductions differ from equivalent size printing. Sometimes the line width of characters may not be consistent or lines may appear in figures or image patterns.

Bring up the `Zoom` menu. The following display will appear.

```
>Zoom
[CS] → [CS]
```

Target size indicator  
Source size indicator

**Source size indicator**...This is the paper size before reduction. This must be the same as the paper size set for print data from the computer.

**Target size indicator**...This is the paper size after reduction. This must be the same as the paper size set for the paper cassette.

The message display will show the messages given in the following table.

Source size indicator	Target size indicator
[CS] Current cassette size	[CS] [CS] 98%
[LG] Legal size (8-1/2 × 14 inches)	[LG] [LG] 98%
[LT] Letter size (8-1/2 × 11 inches)	[LT] [A4] [LT] 98%
[LD] Ledger size (12 × 15-1/2 inches)	[LD] [LD] 98%
[ST]	[ST]
[O2]	[O2]
[FO]	[FO]
[A5] (14.8 × 21 cm)	[A5] [A5] 98%
[B5] (18.2 × 25.7 cm)	[B5] [A5] [B5] 98%
[A4] (21 × 29.7 cm)	[A4] [LT] [B5] [A5] [A4] 98%
[B4] (25.7 × 36.4 cm)	[B4] [B5] [A4] [B4] 98%
[A3] (29.7 × 42cm)	[A3] [A4] [B4] [A3] 98%

- 1** Press the **MENU** key.

- 2** Press the  $\Delta$  or  $\nabla$  key repeatedly until `Page Set >` appears.

```
Page Set >
```

- 3** Press the  $\triangleright$  key.

- 4** Press the  $\Delta$  or  $\nabla$  key repeatedly until `>Zoom` appears.

```
>Zoom
[CS] → [CS]
```

- 5 Press the **ENTER** key. A blinking cursor ( `_` ) appears under the paper size.

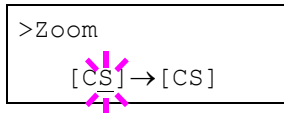

- 6 Press the  $\Delta$  or  $\nabla$  key to select source size. Both sizes change will simultaneously.

- 7 Press the  $\triangleright$  key to move the cursor to the target size.

- 8 To make a reduced print, press the  $\Delta$  or  $\nabla$  key to select the target size.

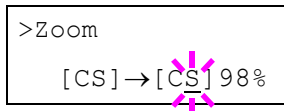

- 9 Press the **ENTER** key.

- 10 Press the **MENU** key. The message display returns to Ready.

**Selecting the Printing Orientation**

You can select the portrait or landscape page orientation. The page orientation can be set whenever the message display indicates Ready.



Portrait



Landscape

- 1 Press the **MENU** key.

- 2 Press the  $\Delta$  or  $\nabla$  key repeatedly until `Page Set >` appears.

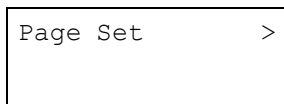

- 3 Press the  $\triangleright$  key.

- 4 Press the  $\Delta$  or  $\nabla$  key repeatedly until `>Orientation` appears.

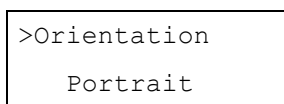

- 5 Press the **ENTER** key. A blinking question mark ( `?` ) appears.

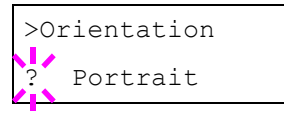

- 6 Select `Portrait` or `Landscape` using the  $\Delta$  or  $\nabla$  key.

- 7 Press the **ENTER** key.

- 8 Press the **MENU** key. The message display returns to Ready.

**Page Protect Mode**

Although Auto is the default setting and this menu does not usually appear, Page Protect will be forcibly set to On if a `Print overrun Press GO` error occurs due to insufficient printer memory. Be sure to return this setting to Auto in order to maintain high printer memory efficiency. This can be done as follows.

- 1 Press the **MENU** key.

- 2 Press the  $\Delta$  or  $\nabla$  key repeatedly until `Page Set >` appears.

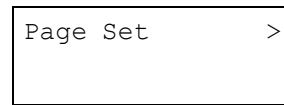

- 3 Press the  $\triangleright$  key.

- 4 Press the  $\Delta$  or  $\nabla$  key repeatedly until `>Page Protect` appears.

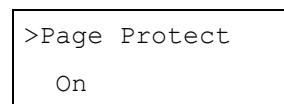

- 5 Press the **ENTER** key. A blinking question mark ( `?` ) appears.

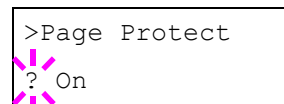

- 6 Press the  $\Delta$  or  $\nabla$  key repeatedly until `Auto` appears.

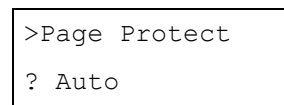

- 7 Press the **ENTER** key.

- 8 Press the **MENU** key. The message display returns to Ready.

## Chapter 3 Using the Operator Panel

### Linefeed (LF) Action

This procedure instructs the printer what to do when it receives a linefeed code (character code 0AH).

**1** Press the **MENU** key.

**2** Press the  $\Delta$  or  $\nabla$  key repeatedly until `Page Set >` appears.

```
Page Set >
```

**3** Press the  $\triangleright$  key.

**4** Press the  $\Delta$  or  $\nabla$  key repeatedly until `>LF Action` appears.

```
>LF Action
LF only
```

**5** Press the **ENTER** key. A blinking question mark (?) appears.

```
>LF Action
? LF only
```

**6** Press the  $\Delta$  or  $\nabla$  key repeatedly until desired linefeed action appears.

LF only	A linefeed is performed. (default)
CR and LF	A linefeed and carriage return are performed.
Ignore LF	The linefeed is ignored.

**7** When the desired action is displayed, press the **ENTER** key.

**8** Press the **MENU** key. The message display returns to Ready.

### Carriage-Return (CR) Action

This procedure instructs the printer what to do when it receives a carriage-return code (character code 0DH).

**1** Press the **MENU** key.

**2** Press the  $\Delta$  or  $\nabla$  key repeatedly until `Page Set >` appears.

```
Page Set >
```

**3** Press the  $\triangleright$  key.

**4** Press the  $\Delta$  or  $\nabla$  key repeatedly until `>CR Action` appears.

```
>CR Action
CR only
```

**5** Press the **ENTER** key. A blinking question mark (?) appears.

```
>CR Action
? CR only
```

**6** Press the  $\Delta$  or  $\nabla$  key repeatedly until desired carriage-return action appears.

CR only	A carriage-return is performed. (Default)
CR and LF	A carriage-return and linefeed are performed.
Ignore CR	The carriage-return code is ignored.

**7** When the desired action is displayed, press the **ENTER** key.

**8** Press the **MENU** key. The message display returns to Ready.

### Wide A4

Turn this **On** to increase the maximum number of characters that can be printed in a line for A4 page (78 characters at 10 pitch) and Letter size page (80 characters at 10 pitch). This setting is effective only in PCL 6 emulation.

**1** Press the **MENU** key.

**2** Press the  $\Delta$  or  $\nabla$  key repeatedly until `Page Set >` appears.

```
Page Set >
```

**3** Press the  $\triangleright$  key.

**4** Press the  $\Delta$  or  $\nabla$  key repeatedly until `>Wide A4` appears.

```
>Wide A4
Off
```

**5** Press the **ENTER** key. A blinking question mark (?) appears.

```
>Wide A4
? Off
```

**6** Select *On* or *Off* using the  $\Delta$  or  $\nabla$  key.

**7** Press the **ENTER** key.

**8** Press the **MENU** key. The message display returns to *Ready*.

### 2.2.8 Setting the Print Quality

You can make the following settings to enhance the print quality: Kyocera Image Refinement (KIR), a software algorithm for increasing printout quality; EcoPrint, a printing mode that reduces toner consumption during printing; printing resolution; and Adjustment of the Print Density.

#### KIR (Kyocera Image Refinement)

This printer incorporates the KIR (Kyocera Image Refinement) smoothing function. At a resolution of 600 dpi this function provides high print quality by providing the software enhancement of print resolution.

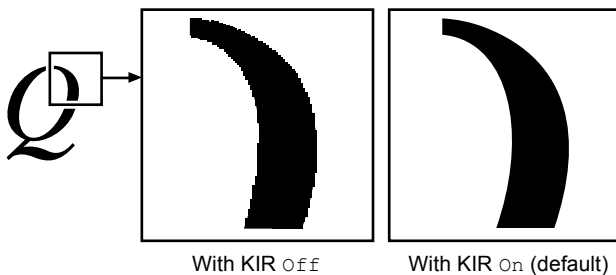

#### NOTE

Set the print density to 3 when setting the KIR mode. For details on print density, see [page 3-31](#). You can monitor the KIR test pattern, the last line on a status page, to make the optimum KIR mode setting.

**1** Press the **MENU** key.

**2** Press the  $\Delta$  or  $\nabla$  key repeatedly until *Print Quality >* appears.

```
Print Quality >
```

**3** Press the  $\triangleright$  key.

**4** Press the  $\Delta$  or  $\nabla$  key repeatedly until *>KIR Mode* appears.

```
>KIR Mode
On
```

**5** Press the **ENTER** key. A blinking question mark (?) appears.

```
>KIR Mode
? On
```

**6** Select *On* or *Off* using the  $\Delta$  or  $\nabla$  key.

**7** Press the **ENTER** key.

**8** Press the **MENU** key. The message display returns to *Ready*.

#### EcoPrint

The EcoPrint enables you to reduce the amount of toner consumed on the page so as to save your printing costs. You can set EcoPrint mode *On*, as follows. (The factory default setting is *Off*.) The EcoPrint mode setting is *On* when the printing image becomes lighter, yet very readable.

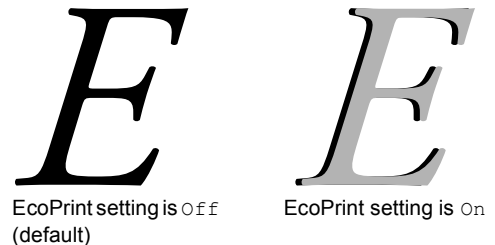

#### NOTE

The EcoPrint setting has no effect on the print speed.

**1** Press the **MENU** key.

**2** Press the  $\Delta$  or  $\nabla$  key repeatedly until *Print Quality >* appears.

```
Print Quality >
```

**3** Press the  $\triangleright$  key.

**4** Press the  $\Delta$  or  $\nabla$  key repeatedly until *>EcoPrint Mode* appears.

```
>EcoPrint Mode
Off
```

## Chapter 3 Using the Operator Panel

- 5 Press the **ENTER** key. A blinking question mark (?) appears.

```
>EcoPrint Mode
? Off
```

- 6 Select **On** or **Off** using the  $\Delta$  or  $\nabla$  key.

- 7 Press the **ENTER** key.

- 8 Press the **MENU** key. The message display returns to **Ready**.

### Resolution

You can set the default print resolution in three ways: 300 dpi, 600 dpi and Fast 1200 mode. The clarity of printed characters and graphics becomes sharper in this order. (The factory setting is Fast 1200 mode.)

- 1 Press the **MENU** key.

- 2 Press the  $\Delta$  or  $\nabla$  key repeatedly until **Print Quality >** appears.

```
Print Quality >
```

- 3 Press the  $\triangleright$  key.

- 4 Press the  $\Delta$  or  $\nabla$  key repeatedly until **>Resolution** appears.

```
>Resolution
Fast 1200 mode
```

- 5 Press the **ENTER** key. A blinking question mark (?) appears.

```
>Resolution
? Fast 1200 mode
```

- 6 Select **Fast 1200 mode** or **300 dpi, 600 dpi** using the  $\Delta$  or  $\nabla$  key.

- 7 Press the **ENTER** key.

- 8 Press the **MENU** key. The message display returns to **Ready**.

### Adjusting the Print Density

The print density can be adjusted in five steps: from **01** (light) to **05** (dark). The factory setting is **03**.

- 1 Press the **MENU** key.

- 2 Press the  $\Delta$  or  $\nabla$  key repeatedly until **Print Quality >** appears.

```
Print Quality >
```

- 3 Press the  $\triangleright$  key.

- 4 Press the  $\Delta$  or  $\nabla$  key repeatedly until **>Print Density** appears.

```
>Print Density
03
```

- 5 Press the **ENTER** key. A blinking question mark (?) appears.

```
>Print Density
? 03
```

- 6 Select the print density from five steps from **01** (light) to **05** (dark) using the  $\Delta$  or  $\nabla$  key.

- 7 Press the **ENTER** key.

- 8 Press the **MENU** key. The message display returns to **Ready**.

### 2.2.9 Operating an Option Hard Disk

By installing the option hard disk into the printer, the **e-MPS** function can be used. The printer's menu selection system allows you to perform the following operations on the hard disk.

If the option hard disk is not formatted, the **>Format** menu will automatically appear on the message display.

- Reading data
- Writing data
- Deleting data
- Printing of list of partitions

#### Reading Data

Data stored on a hard disk can be read. To read data on a hard disk, proceed as follows.

- 1 Press the **MENU** key.

- 2** Press the  $\Delta$  or  $\nabla$  key repeatedly until `Hard Disk >` appears.

```
Hard Disk >
```

- 3** Press the  $\triangleright$  key.

- 4** Press the  $\Delta$  or  $\nabla$  key repeatedly until `>Read Data` appears. The data name also appears.

```
>Read Data
DataH001
```

- 5** Press the **ENTER** key. A blinking question mark (?) appears before the data name.

```
>Read Data
?DataH001
```

- 6** Press the  $\Delta$  or  $\nabla$  key to display the desired data name.

- 7** Press the **ENTER** key. `Processing` appears and the reading of data from the hard disk starts.

**Writing Data**

When writing to a hard disk, a name is assigned to the file automatically. You can use the procedure explained later in this section to print a list of data names for confirmation. To write data onto a hard disk, proceed as follows.

First check that the hard disk is properly formatted. Otherwise, the `>Write Data` message to be explained below will not be shown on the message display.

- 1** Press the **MENU** key.

- 2** Press the  $\Delta$  or  $\nabla$  key repeatedly until `Hard Disk >` appears.

```
Hard Disk >
```

- 3** Press the  $\triangleright$  key.

- 4** Press the  $\Delta$  or  $\nabla$  key repeatedly until `>Write Data` appears.

```
>Write Data
```

- 5** Press the **ENTER** key. A question mark (?) appears.

```
>Write Data ?
```

- 6** Press the **ENTER** key. `Processing` appears, then `Waiting`.

- 7** In this state, send the file from the computer to the printer.

The file is written onto the hard disk and given a destination name (also referred to as a partition name) which the printer automatically assigns one after another as follows:

- DataH001 (first data),
- DataH002 (second data),
- DataH003 (third data)...

In the example above, if the file TEST.TXT is the first data to be written onto the hard disk, the destination name will be DataH001.

As the printer receives data, the message display changes to `Processing`, then when the end of the data is received, the message display changes to `Waiting`.

- 8** Check that the message display has changed to `Waiting`, then press the **GO** key. This writes file to the hard disk and instructs the printer to automatically print out a hard disk write information page as shown below.

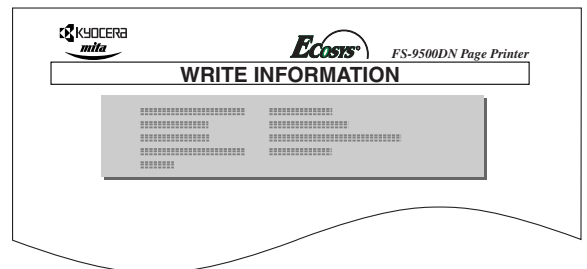

Partition Type:	Type of data written (currently only type 2 is supported).
Partition Name:	The destination name of data written to the hard disk.
Write Partition Length:	The size of the written data on the memory hard disk.
Others:	Error information.

When the hard disk write information page is printed, the message display returns to `Ready`.

If the writing was not completed successfully, an error code appears on the message display. For details, see [Error Messages on page 4-6](#). If this happens, press the **GO** key. The message display returns to `Ready`.



- Repeat above steps until you have transferred all data (files) that you want to write to the hard disk. Each time you finish writing data, a hard disk write information page is printed from the printer showing the information explained in step 8 above, but pertaining only to the data just written. To see all data contained in the hard disk at once, print a list of data names as explained. See [Printing a List of Data Names on page 3-33](#).

### Deleting Data

It is possible to use the printer to delete data from a hard disk one by one. To delete data from a hard disk, proceed as follows.

Check that the hard disk contains data. Otherwise, the `>Delete Data` menu will not appear on the message display.

- Press the **MENU** key.
- Press the  $\Delta$  or  $\nabla$  key repeatedly until `Hard Disk >` appears.

```
Hard Disk >
```

- Press the  $\triangleright$  key.
- Press the  $\Delta$  or  $\nabla$  key repeatedly until `>Delete Data` appears. The data name also appears.

```
>Delete Data
DataH001
```

- Press the **ENTER** key. A blinking question mark (?) appears before the data name.

```
>Delete Data
?DataH001
```

- Press the  $\Delta$  or  $\nabla$  key to display the desired data name.
- Press the **ENTER** key. `Processing` appears and the data is deleted from the hard disk. The message display returns to `Ready`.

### Printing a List of Data Names

The printer prints a list of all data names (referred to as partitions) stored in a hard disk for reference. To print a list of data names for the hard disk, proceed as follows.

- Press the **MENU** key.

- Press the  $\Delta$  or  $\nabla$  key repeatedly until `Hard Disk >` appears.

```
Hard Disk >
```

- Press the  $\triangleright$  key.

- Press the  $\Delta$  or  $\nabla$  key repeatedly until `>List of Partitions` appears.

```
>List of
Partitions
```

- Press the **ENTER** key. A question mark (?) appears.

```
>List of
Partitions ?
```

- Press the **ENTER** key. `Processing` appears and the printing of the list starts.

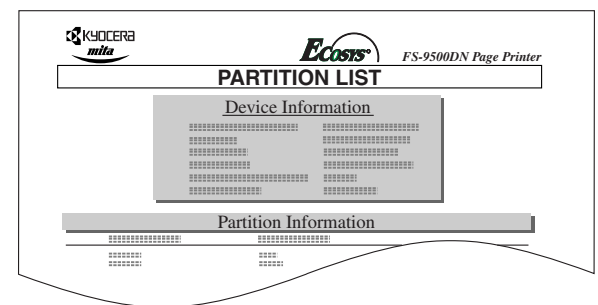

The printout (example above) includes the following information;

- Device Name/Number: HARD DISK/0 is indicated for the hard disk.
- Capacity: The total capacity of the hard disk in bytes.
- Used Space: The total size of the data stored in the hard disk in bytes.
- Free Space: The size of the capacity remaining in the hard disk for storing further data, including the amount of memory that the printer uses for its system.
- Partition Name: The name of the written data assigned automatically by the printer.
- Partition Size: The size of the written data in bytes.
- Partition Type: The type of the written data i.e., whether it is host data (Data) or font data (Font).

When the list of file names (partition list) for the hard disk is printed, the message display returns to `Ready`.

It also prints out the Directory Status List to confirm the directory or data that is written in PDL or KPDL (PostScript).

### 2.2.10 Operating a RAM Disk

The RAM disk is a memory space shared within the printer memory that can temporarily store print jobs. The RAM disk can be used only for electronic sorting. The stored print job can then be used to print multiple copies of the job reducing the total amount of time required to print the whole job. It acts similarly to the hard disk except that the data is effective only when the printer is powered up.

To set up the RAM disk, the option hard disk must not be installed.

To use the RAM disk, activate and enter the desired size of the RAM disk in the manner described below. The maximum RAM disk size can be calculated as follows:

Maximum RAM size = Total printer memory minus 24 MB

For example, if the total memory installed in your printer is 32 MB (Default), you can set 8 MB of RAM disk. If you attempt to set the RAM disk size beyond this restriction, the printer automatically rounds it down so that the size is always 24 MB less than the total printer memory. Once the RAM disk size is set, the printer must be reset.

To activate RAM disk in the printer's memory, first you must use the printer's menu selection system. The printer's menu selection system allows you to perform the following operations on the RAM disk.

- Setting RAM disk size
- Reading data
- Writing data
- Deleting data
- Printing of list of partitions

By default, the RAM disk is not activated (Off). To confirm the RAM disk size or activate the RAM disk, proceed as follows:

#### Setting RAM Disk Size

**1** Press the **MENU** key.

**2** Press the  $\Delta$  or  $\nabla$  key repeatedly until `RAM Disk Mode` > appears.

```
RAM Disk Mode
  Off
```

**3** Press the **ENTER** key. A blinking question mark (?) appears.

```
RAM Disk Mode
? Off
```

**4** Press the  $\Delta$  or  $\nabla$  key to select `On`.

```
>RAM Disk Mode
? On
```

**5** Press the **ENTER** key. A blinking question mark (?) disappears and > appears on the right side.

```
RAM Disk Mode >
  On
```

**6** Press the  $\triangleright$  key.

**7** Press the  $\Delta$  or  $\nabla$  key repeatedly until `>RAM Disk Size` appears. The data size also appears.

```
>RAM Disk Size
  0008 MByte
```

**8** Press the **ENTER** key. A blinking cursor (   ) appears.

```
>RAM Disk Size
  0008 MByte
```

**9** Press the  $\Delta$  or  $\nabla$  key to display the desired size. Definable RAM disk size: 0001 to 1024 (display of size varies depending on the installed RAM size.)

**10** Press the **ENTER** key. The selected RAM disk size is activated.

**11** Press the **MENU** key. The message display returns to `Ready`.

## Chapter 3 Using the Operator Panel

### Reading Data

Data stored on a RAM disk can be read. To read data on a RAM disk, proceed as follows.

**1** Press the **MENU** key.

**2** Press the  $\Delta$  or  $\nabla$  key repeatedly until **RAM Disk Mode >** appears.

```
RAM Disk Mode >
On
```

**3** Press the  $\triangleright$  key.

**4** Press the  $\Delta$  or  $\nabla$  key repeatedly until **>Read Data** appears. The data name also appears.

```
>Read Data
DataH001
```

**5** Press the **ENTER** key. A blinking question mark (?) appears before the data name.

```
>Read Data
? DataH001
```

**6** Press the  $\Delta$  or  $\nabla$  key to display the desired data name.

**7** Press the **ENTER** key. **Processing** appears and the reading of data from the RAM disk starts.

### Writing Data

When writing onto a RAM disk, a name is assigned to the file automatically. You can use the procedure explained later in this section to print a list of data names for confirmation.

**1** Press the **MENU** key.

**2** Press the  $\Delta$  or  $\nabla$  key repeatedly until **RAM Disk Mode >** appears.

```
RAM Disk Mode >
On
```

**3** Press the  $\triangleright$  key.

**4** Press the  $\Delta$  or  $\nabla$  key repeatedly until **>Write Data** appears.

```
>Write Data
```

**5** Press the **ENTER** key. A question mark (?) appears.

```
>Write Data ?
```

**6** Press the **ENTER** key. **Processing** appears, then **Waiting**.

**7** In this state, send the file from the computer to the printer.

The file is written onto the RAM disk given a destination name (also referred to as a partition name) which the printer automatically assigns one after another as follows:

DataH001 (first data)  
DataH002 (second data)  
DataH003 (third data)...

In the example above, if the file **TEST.TXT** is the first data to be written onto the RAM disk, the destination name will be **DataH001**.

As the printer receives data, the message display changes to **Processing**, then when the end of the data is received, the message display changes to **Waiting**.

**8** Check that the message display has changed to **Waiting**, then press the **GO** key. This writes the file to the RAM disk and instructs the printer to automatically print out a RAM disk write information page as shown below.

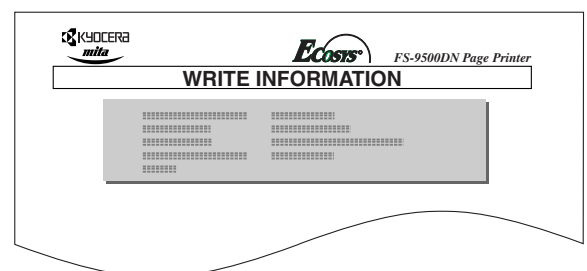

**Partition Type:** Type of data written (currently only type 2 is supported).  
**Partition Name:** The destination name of data written to the card.  
**Write Partition Length:** The size of the written data on the memory card.  
**Others:** Error information.

When the RAM disk write information page is printed, the message display returns to **Ready**.

If the writing was not completed successfully, an error code appears on the message display. For details, see [Error Messages on page 4-6](#). If this happens, press the **GO** key. The message display returns to **Ready**.

- 9** Repeat above steps until you have transferred all data (files) that you want to write to the RAM disk. Each time you finish writing data, a RAM disk write information page is printed from the printer showing the information explained in step 8 above, but pertaining only to the data just written. To see all data contained in the RAM disk at once, print a list of data names as explained. See [Printing a List of Data Names on page 3-33](#).

### Deleting Data

It is possible to use the printer to delete data from a RAM disk one by one. To delete data from a RAM disk, proceed as follows.

Check that the RAM disk contains data. Otherwise, the >Delete Data will not appear on the message display.

- 1** Press the **MENU** key.
- 2** Press the  $\Delta$  or  $\nabla$  key repeatedly until RAM Disk Mode > appears.

```
RAM Disk Mode >
On
```

- 3** Press the  $\triangleright$  key.
- 4** Press the  $\Delta$  or  $\nabla$  key repeatedly until >Delete Data appears. The data name also appears.

```
>Delete Data
DataH001
```

- 5** Press the **ENTER** key. A blinking question mark (?) appears before the data name.

```
>Delete Data
?DataH001
```

- 6** Press the  $\Delta$  or  $\nabla$  key to display the desired data name.
- 7** Press the **ENTER** key. Processing appears and the data is deleted from the RAM disk. The message display returns to Ready.

### Printing a List of Data Names

The printer prints a list of all data names (referred to as partitions) stored in a RAM disk for reference. (Printing a list is also available for a font card.) To print a list of data names for the RAM disk, proceed as follows.

- 1** Press the **MENU** key.
- 2** Press the  $\Delta$  or  $\nabla$  key repeatedly until RAM Disk Mode > appears.
- 3** Press the  $\triangleright$  key.
- 4** Press the  $\Delta$  or  $\nabla$  key repeatedly until >List of Partitions appears.

```
RAM Disk Mode >
On
```

```
>List of
Partitions
```

- 5** Press the **ENTER** key. A question mark (?) appears.
- 6** Press the **ENTER** key. Processing appears and the printing of the list starts.

```
>List of
Partitions ?
```

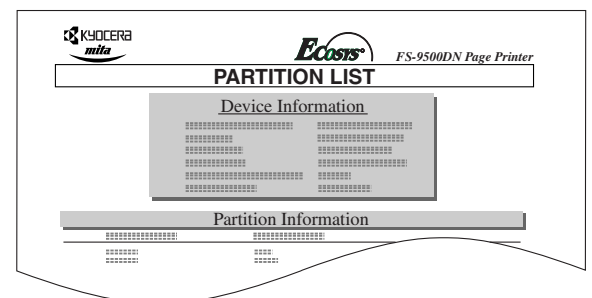

See [Printing a List of Data Names on page 3-33](#) for details on device information.

### 2.2.11 Operating a Memory Card

The printer is equipped with a slot for a memory card. By inserting a memory card into the printer, the following operations become available. For details about the handling of the memory card, see [Appendix D Option Units](#).

- Reading font data
- Reading data
- Writing data
- Deleting data
- Formatting memory card
- Printing of list of partitions

## Chapter 3 Using the Operator Panel

### Reading Font Data

If a memory card with the font data is already inserted into the slot when the printer is turned on, the fonts are automatically read into the printer. To re-read fonts into the printer from a memory card, proceed as follows.

**1** Press the **MENU** key.

**2** Press the  $\Delta$  or  $\nabla$  key repeatedly until `Memory Card >` appears.

```
Memory Card >
```

**3** Press the  $\triangleright$  key.

**4** Press the  $\Delta$  or  $\nabla$  key repeatedly until `>Read Fonts` appears.

```
>Read Fonts
```

**5** Press the **ENTER** key. A question mark (?) appears.

```
>Read Fonts ?
```

**6** Press the **ENTER** key. `Processing` appears and the reading of data from the memory card starts.

```
>Read Fonts  
Processing
```

**7** Press the **MENU** key to return to `Ready`.

### Reading Data

Data stored on a memory card can be read. To read data on a memory card, proceed as follows.

**1** Press the **MENU** key.

**2** Press the  $\Delta$  or  $\nabla$  key repeatedly until `Memory Card >` appears.

```
Memory Card >
```

**3** Press the  $\triangleright$  key.

**4** Press the  $\Delta$  or  $\nabla$  key repeatedly until `>Read Data` appears. The data name also appears.

```
>Read Data  
DataS001
```

**5** Press the **ENTER** key. A blinking question mark (?) appears before the data name.

```
>Read Data  
?DataS001
```

**6** Press the  $\Delta$  or  $\nabla$  key to display the desired data name.

**7** Press the **ENTER** key. `Processing` appears and the reading of data from the memory card starts.

### Writing Data

Data can be written to a memory card until no space is left for storing. When writing to a memory card, a name is assigned to the file automatically. You can use the procedure explained later in this section to print a list of data names for confirmation.

To write data to a memory card, proceed as follows.

First check that the memory card is properly formatted. Otherwise, the `>Write Data` message to be explained below will not be shown on the message display.

If the memory card inserted in the memory card slot is not formatted, the `>Format` will automatically appear on the display. See [Formatting on page 3-38](#).

**1** Press the **MENU** key.

**2** Press the  $\Delta$  or  $\nabla$  key repeatedly until `Memory Card >` appears.

```
Memory Card >
```

**3** Press the  $\triangleright$  key.

**4** Press the  $\Delta$  or  $\nabla$  key repeatedly until `>Write Data` appears.

```
>Write Data
```

**5** Press the **ENTER** key. A question mark (?) appears.

```
>Write Data ?
```

**6** Press the **ENTER** key. *Processing* appears, then *Waiting*.

**7** In this state, send the file from the computer to the printer.

The file is written onto the memory card given a destination name (also referred to as a partition name) which the printer automatically assigns one after another as follows:

```
DataS001 (first data),
DataS002 (second data),
DataS003 (third data)...
```

In the example above, if the file TEST.TXT is the first data to be written onto the memory card, the destination name will be DataS001.

As the printer receives data, the message display changes to *Processing*, then when the end of the data is received, the message display changes to *Waiting*.

**8** Check that the message display has changed to *Waiting*, then press the **GO** key. This writes the file to the memory card and instructs the printer to automatically print out a memory card write information page as shown below.

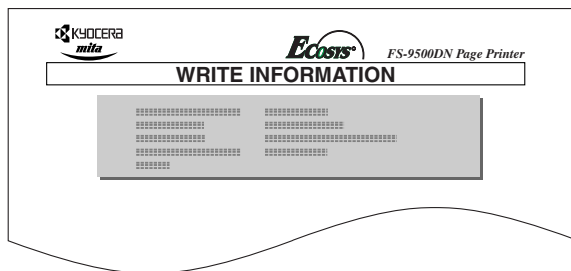

Partition Type:	Type of data written (currently only type 2 is supported).
Partition Name:	The destination name of data written to the card.
Write Partition Length:	The size of the written data on the memory card.
Others:	Error information.

When the memory card write information page is printed, the message display returns to *Ready*.

If the writing is not completed successfully, an error code appears on the message display. For details, see [Error Messages on page 4-6](#). If this happens, press the **GO** key. The message display returns to *Ready*.

**9** Repeat above steps until you have transferred all data (files) that you want to write to the memory card. Each time you finish writing data, a memory card write information page is printed from the printer showing the information explained in step 8 above, but pertaining only to the data just written. To see all data contained in the memory card at once, print a list of data names as explained. See [Printing a List of Data Names on page 3-39](#).

### Deleting Data

It is possible to use the printer to delete data from a memory card one by one.

To delete data from a memory card, proceed as follows. Check that the memory card contains data. Otherwise, the `>Delete Data` menu will not appear on the message display.

**1** Press the **MENU** key.

**2** Press the  $\Delta$  or  $\nabla$  key repeatedly until `Memory Card >` appears.

```
Memory Card >
```

**3** Press the  $\triangleright$  key.

**4** Press the  $\Delta$  or  $\nabla$  key repeatedly until `>Delete Data` appears. The data name also appears.

```
>Delete Data
DataS001
```

**5** Press the **ENTER** key. A blinking question mark (?) appears before the data name.

```
>Delete Data
?DataS001
```

**6** Press the  $\Delta$  or  $\nabla$  key to display the desired data name.

**7** Press the **ENTER** key. *Processing* appears and the data is deleted from the memory card. The display returns to *Ready*.

### Formatting

Formatting allows data to be written to the card. A new memory card must be formatted before it can be used in the printer. Formatting deletes any existing data on the memory card.

To format a memory card, proceed as follows.

**1** Press the **MENU** key.

## Chapter 3 Using the Operator Panel

- 2** Press the  $\Delta$  or  $\nabla$  key repeatedly until `Memory Card >` appears.

```
Memory Card >
```

- 3** Press the  $\triangleright$  key.

- 4** Press the  $\Delta$  or  $\nabla$  key repeatedly until `>Format` appears.

```
>Format
```

- 5** Press the **ENTER** key. A question mark (?) appears.

```
>Format ?
```

- 6** Press the **ENTER** key. *Processing* appears and formatting of the memory card starts.

When the formatting is successfully completed, the printer automatically prints out a format information page.

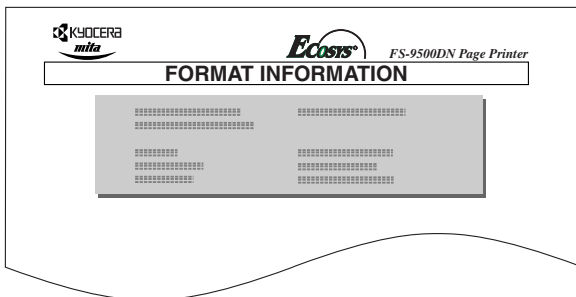

The format information page includes the following items;

- Capacity: The total size of the memory card.
- Used Space: The space the printer uses for its system.
- Free Space: The space remaining in the memory card for storing data.

When the memory card format information is printed, the message display returns to *Ready*.

### Printing a List of Data Names

The printer prints a list of all data names (referred to as partitions) stored in a memory card for reference. (Printing a list is also available for a font card.) To print a list of data names for the memory card, proceed as follows.

- 1** Press the **MENU** key.

- 2** Press the  $\Delta$  or  $\nabla$  key repeatedly until `Memory Card >` appears.

```
Memory Card >
```

- 3** Press the  $\triangleright$  key.

- 4** Press the  $\Delta$  or  $\nabla$  key repeatedly until `>List of Partitions` appears.

```
>List of
Partitions
```

- 5** Press the **ENTER** key. A question mark (?) appears.

```
>List of
Partitions ?
```

- 6** Press the **ENTER** key. *Processing* appears and the printing of the list starts.

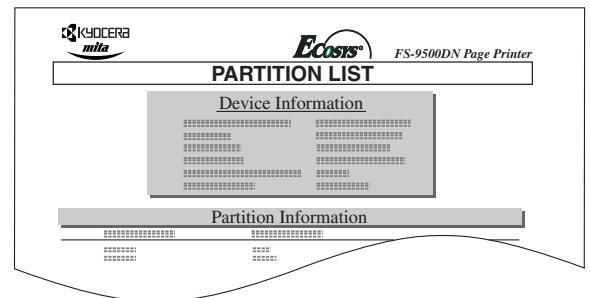

The printout (example above) includes the following information.

Device Name/Number: CARD/A is indicated for the memory card.

Capacity: The total capacity of the memory card in bytes.

Used Space: The total size of the data stored in the memory card in bytes.

Free Space: The size of the capacity remaining in the memory card for storing further data, including the amount of memory that the printer uses for its system.

Partition Name: The name of the written data assigned automatically by the printer.

Partition Size: The size of the written data in bytes.

Partition Type: The type of the written data i.e., whether it is host data (Data) or font data (Font).

When the list of file names (partition list) for the memory card is printed, the message display returns to *Ready*.



## 2.2.12 Paper Handling

You can change the MP tray mode, the paper size and type for each paper source, the sorter mode, the paper source, and paper destinations.

### MP Tray Mode

The MP tray can be used in one of two modes: cassette mode or first mode. The MP tray can hold approximately 200 sheets of paper (A4 size, 0.11 mm thickness).

#### ■ Cassette Mode

The cassette mode provides faster printing speed than the first mode. Approximately 200 sheets of paper can be continuously fed in this mode. (This is the factory setting.)

#### ■ First Mode (Automatic Manual Feeding)

The printer automatically feeds any paper placed on the MP tray even if another paper source is selected. After all paper in the MP tray is printed, paper will be fed from the paper source originally selected.

**1** Press the **MENU** key.

**2** Press the  $\Delta$  or  $\nabla$  key repeatedly until `Paper Handling >` appears.

```
Paper Handling >
```

**3** Press the  $\triangleright$  key.

**4** Press the  $\Delta$  or  $\nabla$  key repeatedly until `>MP Tray Mode` appears.

```
>MP Tray Mode
Cassette
```

**5** Press the **ENTER** key. A blinking question mark (?) appears.

```
>MP Tray Mode
? Cassette
```

**6** Select `First` or `Cassette` using the  $\Delta$  or  $\nabla$  key.

**7** Press the **ENTER** key.

**8** Press the **MENU** key. The message display returns to `Ready`.

### Setting the MP Tray Size

When using the MP tray in the cassette mode, you should set the MP tray size to the paper size that is used to format the job to print. If they do not match, printing will not be made on the correct size paper when automatic paper size selection is made by the application (printer driver). The factory setting is A4 or Letter size.

For more details about the paper sizes that can be fed from the MP tray, see [Chapter 5 Paper Selection](#).

**1** Press the **MENU** key.

**2** Press the  $\Delta$  or  $\nabla$  key repeatedly until `Paper Handling >` appears.

```
Paper Handling >
```

**3** Press the  $\triangleright$  key.

**4** Press the  $\Delta$  or  $\nabla$  key repeatedly until `>MP Tray Size` appears.

```
>MP Tray Size
A4
```

**5** Press the **ENTER** key. A blinking question mark (?) appears.

```
>MP Tray Size
? A4
```



- 6 Press the  $\Delta$  or  $\nabla$  key to display the desired MP tray size. The display changes as shown below.

```
A4
Executive
Letter-R
Letter
Legal
Ledger
A3
B4
Custom
C4
Oficio II
Statement
Folio
Youkei 2
Youkei 4
Hagaki
OufukuHagaki
Monarch
Business
Comm.#9
Comm.#6 3/4
DL
C5
A6
B6
A5
B5
B5-R
ISO B5
A4-R
```

- 7 Press the **ENTER** key.

- 8 Press the **MENU** key. The message display returns to Ready.

### Setting the MP Tray Type

You can automatically select the paper cassette according to the selection made by the application (printer driver). The factory default setting is `Plain`.

For more details about the paper types that can be fed from the MP tray, see [Paper Size Unit Selection on page 3-42](#).

- 1 Press the **MENU** key.

- 2 Press the  $\Delta$  or  $\nabla$  key repeatedly until `Paper Handling >` appears.

```
Paper Handling >
```

- 3 Press the  $\triangleright$  key.

- 4 Press the  $\Delta$  or  $\nabla$  key repeatedly until `>MP Tray Type` appears.

```
>MP Tray Type
Plain
```

- 5 Press the **ENTER** key. A blinking question mark (?) appears.

```
>MP Tray Type
? Plain
```

- 6 Press the  $\Delta$  or  $\nabla$  key to display the desired MP tray type. The display changes as shown below.

```
Plain
Transparency
Preprinted
Labels
Bond
Recycled
Vellum
Rough
Letterhead
Color
Prepunched
Envelope
Cardstock
Custom (1 to 8)
```

- 7 When the desired MP tray type is displayed, press the **ENTER** key.

- 8 Press the **MENU** key and the message display returns to Ready.

### Cassette Paper Size Display

The paper loaded in the cassette will be automatically detected and its size can be displayed in the LCD. To display the correct size, the paper must be properly loaded in the cassette. (For details of loading paper, see [Chapter 2 How to Load Paper](#).)

- 1 Press the **MENU** key.

- 2 Press the  $\Delta$  or  $\nabla$  key repeatedly until `Paper Handling >` appears.

```
Paper Handling >
```

- 3 Press the  $\triangleright$  key.

- Press the  $\Delta$  or  $\nabla$  key repeatedly until `>Cassette Size` appears. The paper size is also displayed.

```
>Cassette1 size
A4
```

**NOTE**

- `Cassette3 Size >` or `Cassette4 Size >` appears when an option paper feeder (PF-70) is installed.
- `Cassette3 Size >` appears when an option paper feeder (PF-75) is installed.

If option paper feeders are added, `Cassette1 Size` and `Cassette2 Size` will appear for the standard paper cassette and `Cassette3 Size`, and `Cassette4 Size` will appear for the option paper feeders.

- Press the **MENU** key. The message display returns to `Ready`.

**Paper Size Unit Selection**

The paper size unit (metric or inch system) used in the LCD can be selected beforehand. At the time of `Ready` or when selecting the size display, the unit for some paper may be replaced with the counterpart as shown in the following table.

metric	Inch
A3	Ledger (LD)
B4	Legal (LG)
A4	Letter (LT)
A4-R (A4)	Letter-R (LT)
B5	Letter-R (LT)
B5-R (B5)	Statement (ST)
A5	Statement (ST)
Folio	Legal (LG)

( ) abbreviated display

For example, when placing the letter size paper in the cassette while “mm” unit is selected. “A4” will be displayed in the LCD. To correct the display, use the following procedures.

**NOTE**

You can set the option paper feeder PF-70 using the same procedures, but when using the paper feeder PF-75, you cannot select the paper size and unit.

- Press the **MENU** key.
- Press the  $\Delta$  or  $\nabla$  key repeatedly until `Paper Handling` appears.

```
Paper Handling >
```

- Press the  $\triangleright$  key.

- Press the  $\Delta$  or  $\nabla$  key repeatedly until `>Cassette1 size` appears.

```
>Cassette1 size
```

- Press the  $\triangleright$  key. `>>Unit` appears.

```
>>Unit
mm
```

- Press the **ENTER** key. A blinking question mark (?) appears.

```
>>Unit
? mm
```

- Press the  $\Delta$  or  $\nabla$  key to select `mm` or `inch`.

- Select `mm` or `inch`, and then, press the **ENTER** key.

- Press the **MENU** key. The message display returns to `Ready`.

**Setting the Cassette Paper Type**

Make this setting to match the paper type fed from the paper cassette of the printer. If the paper type is set correctly, you can perform printing using the media type selection function from the application (printer driver). The factory default setting is `Plain`. For more details about the paper types that can be fed from the paper cassette, see [Paper Type on page 5-5](#).

- Press the **MENU** key.
- Press the  $\Delta$  or  $\nabla$  key repeatedly until `Paper Handling >` appears.
- Press the  $\triangleright$  key.
- Press the  $\Delta$  or  $\nabla$  key repeatedly until `>Cassette 1 Type` appears. The paper type also displayed.

```
Paper Handling >
```

```
>Cassette 1 Type
Plain
```

**NOTE**

- >Cassette 3 Type or >Cassette 4 Type appears when an option paper feeder (PF-70) is installed.
- >Cassette 3 Type appears when an option paper feeder (PF-75) is installed.

**5** Press the **ENTER** key. A blinking question mark (?) appears.

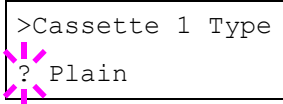

**6** Press the  $\Delta$  or  $\nabla$  key to display the desired cassette type. The display changes as shown below.

- Plain
- Preprinted
- Bond
- Recycled
- Rough
- Letterhead
- Color
- Prepunched
- Custom(1 to 8)

**7** When the desired cassette type is displayed, press the **ENTER** key.

**8** Press the **MENU** key. The message display returns to Ready.

**Selecting the Paper Source**

You can select from which paper source printing will be performed. If no option units are installed, the only selections are the paper cassette and MP tray of the printer. If option paper feeders are installed, they can also be selected.

**1** Press the **MENU** key.

**2** Press the  $\Delta$  or  $\nabla$  key repeatedly until Paper Handling > appears.

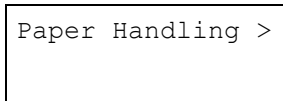

**3** Press the  $\triangleright$  key.

**4** Press the  $\Delta$  or  $\nabla$  key repeatedly until >Feed Select appears.

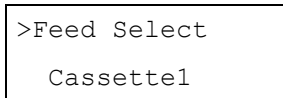

**5** Press the **ENTER** key. A blinking question mark (?) appears.

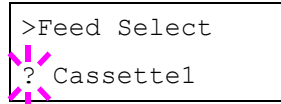

**6** Press the  $\Delta$  or  $\nabla$  key to display the desired paper source. The display changes as shown below according to the installed option units.

- Cassette1 (Printer's standard upper cassette when option paper feeders are installed)
- Cassette2 (Printer's standard lower paper cassette)
- MP tray (printer's MP tray)
- Cassette3 (Option upper paper feeder)
- Cassette4 (Option lower paper feeder)

**7** When the desired paper source displayed, press the **ENTER** key.

**8** Press the **MENU** key. The message display returns to Ready.

**Setting Duplex Printing**

Using the duplex unit, you can automatically print on both sides of the paper. The duplex unit is installed underneath the printer.

**■ Binding Setups**

The term binding refers to the manner in which printed pages of paper are joined together (by gluing, stitching, etc.) in book form. The two possible types of binding are long-edge binding, in which pages are joined together along their long edge; and short-edge binding, in which they are joined together along their short edge. In selecting a binding type, you must also consider the orientation of the printed page. You can use long-edge or short-edge binding with either landscape or portrait printing.

Depending on the binding type and print orientation, the duplex unit provides four types of binding setups. These are: (1) portrait, long-edge, (2) portrait, short edge, (3) landscape, long-edge, and (4) landscape, short-edge. The figure below shows these binding setups.

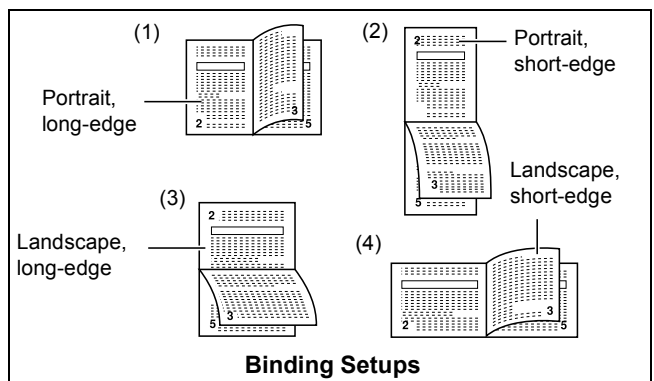

To select duplex printing and binding setup from the operator panel, proceed as follows.

**1** Press the **MENU** key.

**2** Press the  $\Delta$  or  $\nabla$  key repeatedly until Paper Handling > appears.

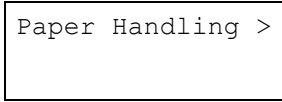

**3** Press the  $\triangleright$  key.

**4** Press the  $\Delta$  or  $\nabla$  key repeatedly until >Duplex Mode appears.

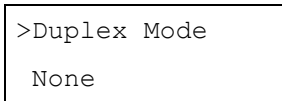

**5** Press the **ENTER** key. A blinking question mark (?) appears.

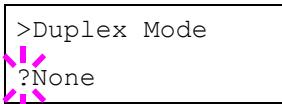

**6** Press the  $\Delta$  or  $\nabla$  key to display the desired duplex mode. The display changes as shown below.

None (default)  
Short edge bind  
Long edge bind

**7** When the desired duplex mode is displayed, press the **ENTER** key.

**8** Press the **MENU** key. The message display returns to Ready.

**Selecting the Output Device**

You can select whether printouts will be received by the printer's face-down output tray or to the optional document finisher's output tray.

**1** Press the **MENU** key.

**2** Press the  $\Delta$  or  $\nabla$  key repeatedly until Paper Handling > appears.

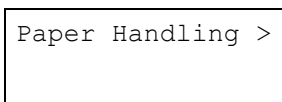

**3** Press the  $\triangleright$  key.

**4** Press the  $\Delta$  or  $\nabla$  key repeatedly until >Stack Select appears.

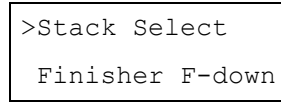

**5** Press the **ENTER** key. A blinking question mark (?) appears. The selected output device will be displayed.

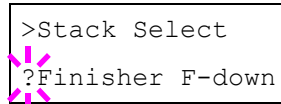

**6** Press the  $\Delta$  or  $\nabla$  key to display the desired destination. The output tray changes as shown below.

Face-down tray  
Finisher F-up  
Finisher F-down

**7** When the desired paper source displayed, press the **ENTER** key.

**8** Press the **MENU** key. The message display returns to Ready.

**Adjusting the Stitch Positions**

When installing the option document finisher DF-75, adjust the stitch positions using the following procedures. In the default settings, the stitch position is set in the center of the paper. Depending on the paper, a certain amount of deviation will occur. In this case, also use this menu to adjust the stitch position.

The adjustment can be done by moving the stitch position adjustment gear in the document finisher.

For example, select the range from -57 to +57 (1 = approximately 0.14 mm) to move the stitch position approximately 8 mm as shown in the following figure. The default setting is 000 (center of the paper.)

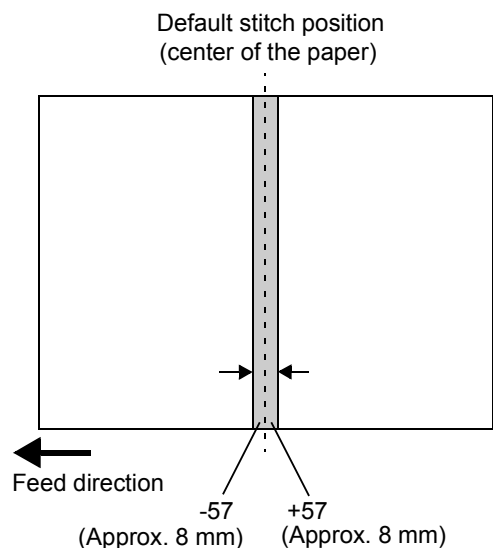

**1** Press the **MENU** key.

**2** Press the  $\Delta$  or  $\nabla$  key repeatedly until `Paper Handling >` appears.

```
Paper Handling >
```

**3** Press the  $\triangleright$  key. `>Stitch Adjust >` appears.

```
>Stitch Adjust >
```

**4** Press the  $\triangleright$  key. `>>A4/Letter` appears.

```
>>A4/Letter  
000
```

**5** Press the  $\Delta$  or  $\nabla$  key to select `A4/Letter`, `B4` or `A3/Ledger`.

**6** When the desired paper size is displayed, press the **ENTER** key. A blinking cursor (`_`) appears under the value.

```
>>A4/Letter  
000_
```

**7** Press the  $\Delta$  or  $\nabla$  key to increase or decrease, respectively, the value at the blinking cursor. Use the  $\triangleright$  and  $\triangleleft$  keys to move the cursor right and left.  
Definable value: -057 to 057

**8** When the desired value is displayed, press the **ENTER** key.

**9** Press the **MENU** key. The message display returns to `Ready`.

### Overriding A4 and Letter Size Difference

This selects whether to enable or disable the difference between A4 size and Letter size. Under the default setting of `Off`, the paper size of the paper source is matched to the paper size formatting the jobs. If these differ, a corresponding error message is displayed. When this is set to `On`, printing is performed even if the actual paper size differs from the paper size formatting the jobs.

**1** Press the **MENU** key.

**2** Press the  $\Delta$  or  $\nabla$  key repeatedly until `Paper Handling >` appears.

```
Paper Handling >
```

**3** Press the  $\triangleright$  key.

**4** Press the  $\Delta$  or  $\nabla$  key repeatedly until `>Override A4/LT` appears.

```
>Override A4/LT  
Off
```

**5** Press the **ENTER** key. A blinking question mark (?) appears.

```
>Override A4/LT  
? Off
```

**6** Select `On` or `Off` using the  $\Delta$  or  $\nabla$  key.

**7** Press the **ENTER** key.

**8** Press the **MENU** key. The message display returns to `Ready`.

### Customizing Paper Type

The following describes the procedure used to set a user-defined paper type for the printer. Eight custom user settings may be registered. After having been set, any of these may be called up when setting the paper type for a paper source.

The paper weight and duplex path can be set (see [Setting the Paper Weight on page 3-46](#), and [Setting the Duplex Path on page 3-46](#)) after selecting the paper type to be customized as follows. For how to reset the customized settings, see [Resetting the Type Adjust on page 3-46](#).

**1** Press the **MENU** key.

**2** Press the  $\Delta$  or  $\nabla$  key repeatedly until `Paper Handling >` appears.

```
Paper Handling >
```

**3** Press the  $\triangleright$  key.

**4** Press the  $\Delta$  or  $\nabla$  key repeatedly until `>Type Adjust >` appears.

```
>Type Adjust >  
Custom 1
```

- 5 Press the **ENTER** key. A blinking question mark (?) appears.

```
>Type Adjust >
? Custom 1
```

- 6 Press the  $\Delta$  or  $\nabla$  key to display the desired paper type. The display changes as shown below.

```
Custom (1 to 8)
Plain
Transparency
Preprinted
Labels
Bond
Recycled
Vellum
Rough
Letterhead
Color
Prepunched
Envelope
Cardstock
```

- 7 When the paper type to be customized is displayed, press the **ENTER** key.

- 8 Press the  $\triangleright$  key and proceed to [Setting the Paper Weight](#) on the following page.

**Setting the Paper Weight**

You can set the paper thickness for your custom paper type to be customized.

- 1 Display the custom paper type (see [Customizing Paper Type on page 3-45](#)) and press the  $\triangleright$  key.

- 2 Press the  $\Delta$  or  $\nabla$  key repeatedly until  $\gg$ Paper Weight appears.

```
\ggPaper Weight
Normal
```

- 3 Press the **ENTER** key. A blinking question mark (?) appears.

```
\ggPaper Weight
? Normal
```

- 4 Press the  $\Delta$  or  $\nabla$  key to display the desired paper thickness. The display changes as shown below. For details of the default setting for each paper type, see [Paper Type on page 5-5](#).

```
Normal
Heavy (Thick)
Extra Heavy
Light (Thin)
```

- 5 When the desired paper thickness displayed, press the **ENTER** key.

- 6 Press the **MENU** Key. The message display returns to Ready.

**Setting the Duplex Path**

If the paper type is set to Custom, you can set whether or not to enable duplex printing as follows. The default setting is Enable.

- 1 Display the custom paper type (see [Customizing Paper Type on page 3-45](#)) and press the  $\triangleright$  key.

- 2 Press the  $\Delta$  or  $\nabla$  key repeatedly until  $\gg$ Duplex Path appears.

```
\ggDuplex Path
Enable
```

- 3 Press the **ENTER** key. A blinking question mark (?) appears.

```
\ggDuplex Path
? Enable
```

- 4 Select **Enable** or **Disable** using the  $\Delta$  or  $\nabla$  key. For details of the default setting for each paper type, see [Paper Type on page 5-5](#).

- 5 Press the **ENTER** key.

- 6 Press the **MENU** key. The message display returns to Ready.

**Resetting the Type Adjust**

Resets the custom setting that are set in [Customizing Paper Type on page 3-45](#).

- 1 Press the **MENU** key.

- 2 Press the  $\Delta$  or  $\nabla$  key repeatedly until Paper handling > appears.

```
Paper Handling >
```

- 3 Press the  $\triangleright$  key.

- 4 Press the  $\Delta$  or  $\nabla$  key repeatedly until  $\gt$ Reset Type Adjust appears.

```
\gtReset Type
Adjust
```

- 1 Press the **ENTER** key. A question mark (?) appears.

```
>Reset Type
Adjust ?
```

- 2 Press the **ENTER** key. All the customized paper weight and duplex path settings will be reset to the default. The message display returns to *Ready*.

### ■ Verifying the Total Printed Pages and Resetting the Toner Counter

You can display the total number of pages printed by your printer for confirmation whenever necessary. The total number of printed pages can also be checked on the status page. Moreover, for proper maintenance scheduling, it will be necessary to reset the toner counter using this menu each time a new toner container is installed.

### ■ Verifying the Total Printed Pages

This procedure only displays the total number of printed pages. The number cannot be changed.

- 1 Press the **MENU** key.

- 2 Press the  $\Delta$  or  $\nabla$  key repeatedly until *Life Counters >* appears.

```
Life Counters >
```

- 3 Press the  $\triangleright$  key.

- 4 Press the  $\Delta$  or  $\nabla$  key until *>Total Print* appears.

```
>Total Print
0123456
```

- 5 Press the **MENU** key. The message display returns to *Ready*.

### ■ Resetting the Remaining Toner Counter

When the toner container is replaced, reset the toner counter as follows so that an accurate toner gauge measurement is indicated on the status page. Note that if this operation is performed when the toner container is not replaced, the toner gauge measurement will not be indicated correctly. Also refer to the *Installation Guide* supplied with the toner kit when replacing the toner container.

- 1 Press the **MENU** key.

- 2 Press the  $\Delta$  or  $\nabla$  key repeatedly until *Life Counters >* appears.

```
Life Counters >
```

- 3 Press the  $\triangleright$  key.

- 4 Press the  $\Delta$  or  $\nabla$  key repeatedly until *>New Toner Installed* appears.

```
>New Toner
Installed
```

- 5 Press the **ENTER** key. A question mark (?) appears.

```
>New Toner
Installed ?
```

- 6 Press the **ENTER** key. The toner counter is reset.

- 7 Press the **MENU** key. The message display returns to *Ready*.

### 2.2.13 Other Modes

The modes described in the following pages can be accessed in the *Others* submenu. To enter the *Others* submenu, press the  $\triangleright$  key while *Others >* is displayed.

The following submenus can be displayed by pressing the  $\triangleright$  key and then the  $\Delta$  or  $\nabla$  key.

- Message Language Selecting
- Automatic Form Feed Timeout Setting
- Sleep Timer Setting
- Received Data Dumping
- Printer Resetting
- Resource Setting
- Alarm (Buzzer) Setting
- Auto Continue Setting
- Service Menu (for service personnel)

### Message Language Selecting

You can select the language of the messages on the message display by following the procedure given below.

- 1 Press the **MENU** key.

- Press the  $\Delta$  or  $\nabla$  key repeatedly until `Others >` appears.

```
Others >
```

- Press the  $\triangleright$  key.

- Press the  $\Delta$  or  $\nabla$  key repeatedly until `>MSG Language` appears. The default message language is English.

```
>MSG Language
English
```

- To change the language, press the **ENTER** key. A blinking question mark (?) appears.

```
>MSG Language
? English
```

- Press the  $\Delta$  key. The display cycles through the available selections in the following order (The  $\nabla$  key cycles in the reverse order):

```
English
Francais
Deutsch
Italiano
Nederlands
```

- Press the **ENTER** key.

- Press the **MENU** key. The message display returns to `Ready`.

### Automatic Form Feed Timeout Setting

When the printer receives no data for a certain time, it times out and releases the current interface: it prints whatever data it has in its buffer and feeds out the page. You can adjust the time-out time as follows:

- Press the **MENU** key.

- Press the  $\Delta$  or  $\nabla$  key repeatedly until `Others >` appears.

```
Others >
```

- Press the  $\triangleright$  key.

- Press the  $\Delta$  or  $\nabla$  key repeatedly until `>Form Feed Time Out` appears. The default setting is 30 seconds.

```
>Form Feed
Time Out 030sec.
```

- Press the **ENTER** key. A blinking cursor ( `_` ) appears.

```
>Form Feed
Time Out 030_sec.
```

- Press the  $\Delta$  or  $\nabla$  key to increase or decrease the value of the figure where the cursor is blinking and set the desired time. The time can be set between 0 and 495 seconds, in 5-second increments. (The printer does not timeout with the value set to 0.) You can use the  $\triangleright$  and  $\triangleleft$  keys to move the cursor right and left.

- Display the desired time and press the **ENTER** key.

- Press the **MENU** key. The message display returns to `Ready`.

### Sleep Timer Setting

The printer has a sleep timer to conserve power when the printer is not printing, processing, or receiving data. You can adjust the timer value, the length of time the printer waits before entering sleeping mode in the absence of data.

- Press the **MENU** key.

- Press the  $\Delta$  or  $\nabla$  key repeatedly until `Others >` appears.

```
Others >
```

- Press the  $\triangleright$  key.

- Press the  $\Delta$  or  $\nabla$  key repeatedly until `>Sleep Timer >` appears. The default setting is 030 min.

```
>Sleep timer >
030 min.
```

- Press the **ENTER** key. A blinking cursor ( `_` ) appears.

```
>Sleep timer >
030_min.
```



**6** Press the  $\Delta$  or  $\nabla$  key to increase or decrease the value of the figure where the cursor is blinking and set the desired time. The timer can be set between 5 and 240 min, in 5-minute increments. You can use the  $\triangleright$  and  $\triangleleft$  keys to move the cursor right and left.

**7** Press the **ENTER** key.

**8** Press the **MENU** key. The message display returns to Ready.

### ■ Turning Off the Sleep Timer

You can turn off the sleep timer function by following the procedure given below.

**1** Press the **MENU** key.

**2** Press the  $\Delta$  or  $\nabla$  key repeatedly until Others > appears.

```
Others >
```

**3** Press the  $\triangleright$  key.

**4** Press the  $\Delta$  or  $\nabla$  key repeatedly until >Sleep Timer > appears.

```
>Sleep timer >
      030 min.
```

**5** Press the  $\triangleright$  key and display >>Sleep Mode.

```
>>Sleep Mode
      On
```

**6** Press the **ENTER** key. A blinking question mark (?) appears.

```
>>Sleep Mode
? On
```

**7** Select Off using the  $\Delta$  or  $\nabla$  key.

```
>>Sleep Mode
? Off
```

**8** Press the **ENTER** key.

**9** Press the **MENU** key. The message display returns to Ready.

### Received Data Dumping

It is possible to print data received by the printer as hexadecimal code for the purposes of debugging programs and files.

**1** Press the **MENU** key.

**2** Press the  $\Delta$  or  $\nabla$  key repeatedly until Others > appears.

```
Others >
```

**3** Press the  $\triangleright$  key.

**4** Press the  $\Delta$  or  $\nabla$  key repeatedly until >Print HEX-DUMP appears.

```
>Print HEX-DUMP
```

**5** Press the **ENTER** key. A question mark (?) appears.

```
>Print HEX-DUMP?
```

**6** Press the **ENTER** key again. Processing appears for a second, and then Waiting appears.

```
Processing
```



```
Waiting
```

**7** Send data to be dumped to the printer. The message Processing will be displayed while receiving the data.

Once the dumped data you require has been printed, it is possible to cancel the printing of any further dumped data by taking the printer offline by pressing the **GO** key and then pressing the **CANCEL** key.

**8** Once all data has been received, the message Waiting will appear. Press the **GO** key to finish printing.

### Printer Resetting

The procedure described below resets the printer's temporary conditions, such as the current unit of measurement, page orientation, font, character code set, margins, etc., set by commands to their default values.

**1** Press the **MENU** key.

**2** Press the  $\Delta$  or  $\nabla$  key repeatedly until `Others >` appears.

```
Others >
```

**3** Press the  $\triangleright$  key.

**4** Press the  $\Delta$  or  $\nabla$  key repeatedly until `>Printer Reset` appears.

```
>Printer Reset
```

**5** Press the **ENTER** key. A question mark (?) appears.

```
>Printer Reset ?
```

**6** Press the **ENTER** key again. `Self test` appears while the printer is resetting itself, then `Please wait` followed by `Ready`.

```
Self test
```



```
Please wait
```



```
Ready
```

**Resource Protection**

When you switch from the PCL 6 emulation to another, all downloaded fonts and macros are lost. Resource protection preserves these PCL resources in memory so that they are intact when you change the emulation back to PCL 6.

**1** Press the **MENU** key.

**2** Press the  $\Delta$  or  $\nabla$  key repeatedly until `Others >` appears.

```
Others >
```

**3** Press the  $\triangleright$  key.

**4** Press the  $\Delta$  or  $\nabla$  key repeatedly until `>Resource Prot.` appears.

```
>Resource Prot.
Off
```

**5** Press the **ENTER** key. A blinking question mark (?) appears.

```
>Resource Prot.
? Off
```

**6** Press the  $\Delta$  or  $\nabla$  key to display the desired mode. The display changes as shown below.

```
Off (default)
Permanent
Perm / Temp
```

**7** When the desired mode is displayed, press the **ENTER** key.

**8** Press the **MENU** key. The message display returns to `Ready`.

**Alarm (Buzzer) Setting**

In addition to the message displayed when the paper supply is exhausted, or when paper jamming occurs, an audio warning is made to sound. This is useful, for example, when the printer is in a location some distance from the user.

The audio alarm is set to `On` when leaving the factory. If the alarm is set to `Off`, it is made not to sound.

**1** Press the **MENU** key.

**2** Press the  $\Delta$  or  $\nabla$  key repeatedly until `Others >` appears.

```
Others >
```

**3** Press the  $\triangleright$  key.

**4** Press the  $\Delta$  or  $\nabla$  key repeatedly until `> Buzzer` appears.

```
>Buzzer
On
```

- 5 Press the **ENTER** key. A blinking question mark (?) appears.

```
>Buzzer
? On
```

- 6 Select **On** or **Off** using the  $\Delta$  or  $\nabla$  key.

- 7 Press the **ENTER** key.

- 8 Press the **MENU** key. The message display returns to **Ready**.

### Auto Continue Setting

If an error that still allows you to continue printing occurs (Memory overflow Press GO, Print overrun Press GO, KPDL error Press GO, and File not found Press GO), the next received data is automatically printed after a set period of time elapses. For example, if the printer is shared over a network as a network printer and one person causes one of the above errors, after the set period of time elapses, the data sent from the next person is printed. The factory setting is off.

For setting the auto continue recovery time, see the next section.

- 1 Press the **MENU** key.

- 2 Press the  $\Delta$  or  $\nabla$  key repeatedly until **Others >** appears.

```
Others >
```

- 3 Press the  $\triangleright$  key.

- 4 Press the  $\Delta$  or  $\nabla$  key repeatedly until **Auto Continue >** appears.

```
>Auto Continue >
Mode Off
```

- 5 Press the **ENTER** key. A blinking question mark (?) appears.

```
>Auto Continue
Mode ? Off
```

- 6 Select **On** or **Off** using the  $\Delta$  or  $\nabla$  key.

- 7 Press the **ENTER** key.

- 8 Press the **MENU** key. The message display returns to **Ready**.

### Setting the Auto Continue Recovery Time

Follow the procedure given below to change the recovery time for **Auto Continue**.

- 1 Press the **MENU** key.

- 2 Press the  $\Delta$  or  $\nabla$  key repeatedly until **Others >** appears.

```
Others >
```

- 3 Press the  $\triangleright$  key.

- 4 Press the  $\Delta$  or  $\nabla$  key repeatedly until **Auto Continue Mode >** appears.

```
>Auto Continue >
Mode On
```

- 5 Press the  $\triangleright$  key and display **>>Auto Continue Timer**.

- 6 Press the **ENTER** key. A blinking cursor (   ) appears.

```
>>Auto Continue
Timer 030Sec.
```

- 7 Press the  $\Delta$  or  $\nabla$  key to increase or decrease the value of the figure where the cursor is blinking and set the desired time. The time must be set between 000 and 495 seconds, in 5-second increments. If set to 000, printing will be continued immediately without allowing any time interval. You can use the  $\triangleright$  and  $\triangleleft$  keys to move the cursor right and left.

- 8 Display the desired time and press the **ENTER** key.

- 9 Press the **MENU** key. The message display returns to **Ready**.

### Service Menu

The service menu contains maintenance operations to be performed by service personnel. The **Print Status Page**, **Developer**, and **Drum** menus appear; however, in general, you will only need to use the **Print Status Page** menus.

**■ Printing the Service Status Page**

The service status page contains printer settings information that is more detailed than the standard status page and is therefore for mostly service purposes. To print a service status page, proceed as follows;

**1** Press the **MENU** key.

**2** Press the  $\Delta$  or  $\nabla$  key repeatedly until `Others >` appears.

```
Others >
```

**3** Press the  $\triangleright$  key.

**4** Press the  $\Delta$  or  $\nabla$  key repeatedly until `>Service >` appears.

```
>Service >
```

**5** Press the  $\triangleright$  key.

**6** Press the  $\Delta$  or  $\nabla$  key repeatedly until `>>Print Status Page` appears.

```
>>Print
Status Page
```

**7** Press the **ENTER** key. A question mark (?) appears.

```
>>Print
Status Page ?
```

**8** Press the **ENTER** key. The message display indicates Processing and printing starts.

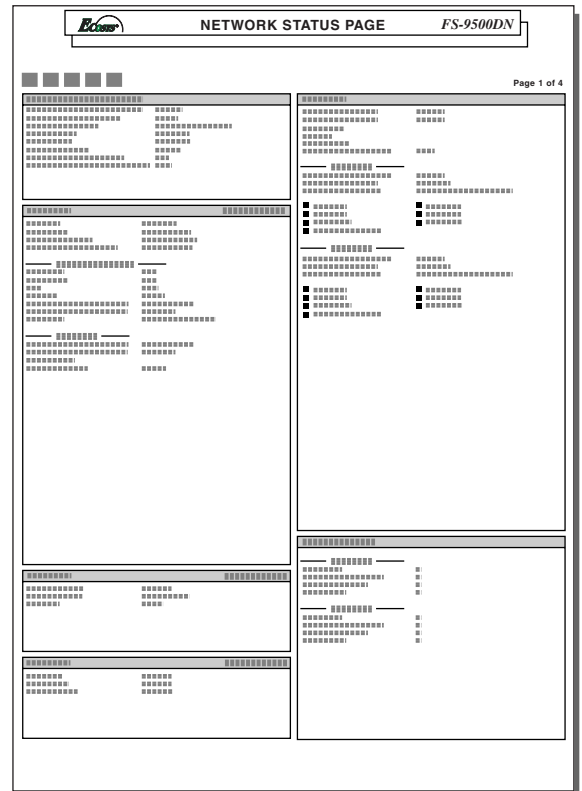

**NOTE**

The network interface status page will be printed after the printer service status page.

# Chapter 4 Troubleshooting

This chapter explains how to handle printer problems that may occur. If a problem cannot be corrected, contact your Kyocera Mita dealer.

This chapter explains the following topics:

- General Guide
- Print Quality Problems
- Indicators and Messages
- Correcting a Paper Jam

## 1. General Guide

If some kind of problem should occur, check the following before concluding the printer is broken;

Symptom	Check Items	Corrective Action	
The printer will not print from the computer.	Check the  <b>READY</b> indicator.	Off	Look through the items below and check anything that seems appropriate.
		Flashing	An error has occurred. Check the message display, and then take measures seeing <a href="#">Indicators and Messages on page 4-4</a> .
		Lit	See the appropriate item below.
	Check the <b>! ATTENTION</b> indicator.	Flashing	See <a href="#">Indicators on page 4-4</a> .
		Lit	
A maintenance message appears in the message display.		See <a href="#">Maintenance Messages on page 4-4</a> .	
Print quality is not good.		See <a href="#">Print Quality Problems on page 4-2</a> .	
Paper is jammed.		See <a href="#">Correcting a Paper Jam on page 4-8</a> .	
Nothing lights on the operator panel even when power is turned on and the fan makes no noise.	Check that the power cord is properly plugged into the power outlet.	Turn off the printer's power, plug in the power cord securely, and try turning on the printer's power again.	
	Check that the main switch is really in the ON ( I ) position.		
The printer prints a status page, but data from the computer is not being printed normally.	Check the interface cable.	Connect both ends of the interface cable securely. Try replacing the printer cable. For details on the parallel interface for this printer, see <a href="#">Appendix C Host Computer Interface</a> .	
	Check program files and application software.	Try printing another file or using another print command. If the problem occurs only with a specific file or application, check the printer settings for that application.	

If you still cannot correct a printer problem even after checking the above, please contact your Kyocera Mita dealer.

## 2. Print Quality Problems

As the following table shows, there are many possible causes of print quality problems, such as blank output. The troubleshooting procedure for each type of problem is explained below. If you still cannot solve the problem, contact your Kyocera Mita dealer.

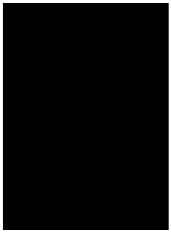
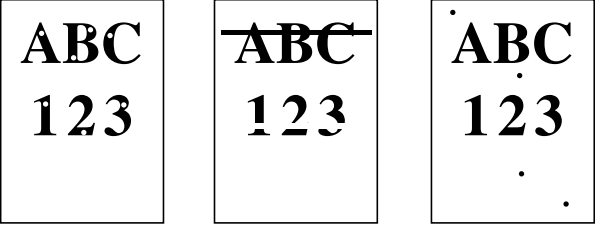
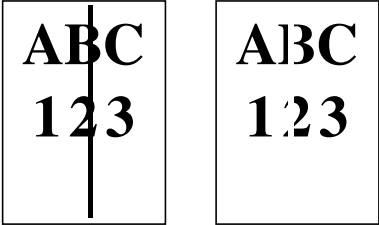
Printed Results	Corrective Action
<p>Completely blank printout</p> 	<p><b>Check the toner container.</b> Open the printer front cover and check that the toner container is correctly installed in the printer. See <a href="#">Toner Container Replacement on page 6-1</a>.</p>
<p>All-black printout</p> 	<p><b>Check the main charger unit.</b> Open the printer front cover and check that the main charger unit is correctly installed.</p>
<p>Dropouts, horizontal streaks, stray dots</p> 	<p><b>Clean the charger wire.</b> Open the printer front cover. Pull the cleaning knob slowly in and out a few times. See <a href="#">Toner Container Replacement on page 6-1</a>.</p> <hr/> <p><b>Refresh drum.</b> See the following procedures in the operator panel and try cleaning the drum surface using the printer's built-in cleaning system.</p> <ol style="list-style-type: none"> <li>1. Press the <b>MENU</b> key, and then press the <math>\Delta</math> or <math>\nabla</math> key to display &gt;Others.</li> <li>2. Press the <math>\triangleright</math> key, and then press the <math>\Delta</math> or <math>\nabla</math> key to display &gt;Service &gt;.</li> <li>3. Press the <math>\triangleright</math> key, and then press the <math>\Delta</math> or <math>\nabla</math> key to display &gt;&gt;Drum. And then press the <b>ENTER</b> key twice.</li> <li>4. The message display shows <i>Please wait</i>, and then the drum starts turning and stops after approx.3 minutes. The printer reverts to <i>Ready</i>.</li> </ol>
<p>Black or white vertical streaks</p> 	<p><b>Check the operator panel.</b> If the <i>Toner low TK-70</i> message is displayed and the <b>! ATTENTION</b> indicator is flashing, install a new toner kit. See <a href="#">Toner Container Replacement on page 6-1</a>.</p> <hr/> <p><b>Clean the charger wire.</b> Open the printer front cover. Pull the cleaning knob slowly in and out a few times. See <a href="#">Toner Container Replacement on page 6-1</a>.</p>

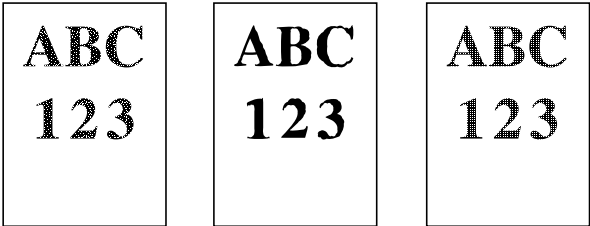
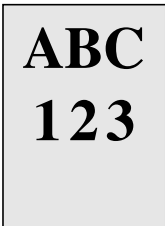
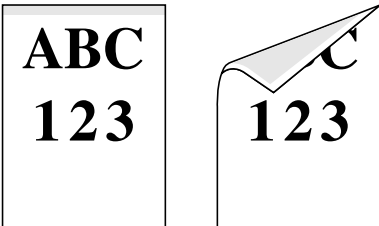
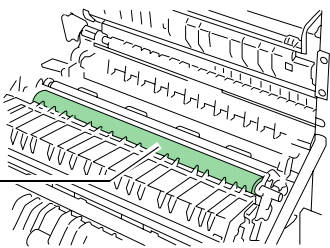
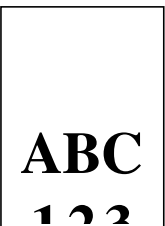

(Continued on next page)

Printed Results	Corrective Action
<p>Faint or blurred printing</p> 	<p><b>Check the EcoPrint setting.</b> When this setting is <b>On</b>, switch it to <b>Off</b> on the operator panel. (See <a href="#">Setting the Print Quality on page 3-30.</a>)</p> <hr/> <p><b>Check the operator panel.</b></p> <ul style="list-style-type: none"> <li>• If the <b>Toner low TK-70</b> message is displayed and the <b>! ATTENTION</b> indicator is flashing, install a new toner kit. See <a href="#">Toner Container Replacement on page 6-1.</a></li> <li>• Set the print density from the operator panel to a higher level than the current setting. See <a href="#">Adjusting the Print Density on page 3-31.</a></li> <li>• Make sure the paper type setting is correct. See <a href="#">Paper Type on page 5-5.</a></li> </ul> <hr/> <p><b>Clean the charger wire.</b> Open the printer front cover. Pull the cleaning knob slowly in and out a few times. See <a href="#">Toner Container Replacement on page 6-1.</a></p>
<p>Grey background.</p> 	<p><b>Refresh drum.</b> See the following procedures in the operator panel and try cleaning the drum surface using the printer's built-in cleaning system.</p> <ol style="list-style-type: none"> <li>1. Press the <b>MENU</b> key, and then press the <b>Δ</b> or <b>∇</b> key to display <b>&gt;Others.</b></li> <li>2. Press the <b>▷</b> key, and then press the <b>Δ</b> or <b>∇</b> key to display <b>&gt;Service &gt;.</b></li> <li>3. Press the <b>▷</b> key, and then press the <b>Δ</b> or <b>∇</b> key to display <b>&gt;&gt;Drum.</b> And then press the <b>ENTER</b> key twice.</li> <li>4. The message display shows <b>Please wait</b>, and then the drum starts turning and stops after approx.3 minutes. The printer reverts to <b>Ready.</b></li> </ol> <hr/> <p><b>Check the operator panel.</b> If the <b>Toner low TK-70</b> message is displayed and the <b>ATTENTION</b> indicator is flashing, install a new toner kit. See <a href="#">Toner Container Replacement on page 6-1.</a></p> <hr/> <p><b>Check the print density.</b> Display the print density menu from the operator panel and select a lighter density setting. See <a href="#">Adjusting the Print Density on page 3-31.</a></p> <hr/> <p><b>Clean the charger wire.</b> Open the printer front cover. Pull the cleaning knob slowly in and out a few times. See <a href="#">Toner Container Replacement on page 6-1.</a></p> <hr/> <p><b>Check the charger unit installation.</b> Open the printer front cover and check that the main charger unit is correctly installed and seated as far as it will go. See <a href="#">Toner Container Replacement on page 6-1.</a></p>
<p>Dirt on the top edge or back of the paper</p> 	<p><b>Check the paper chute and the ramp.</b> Open the printer left cover and check for toner on the paper ramp. Clean the paper ramp using a soft, dry, lint-free cloth. See <a href="#">Toner Container Replacement on page 6-1.</a></p> <hr/> <p><b>Check the transfer roller.</b> Open the printer left cover 1 and check the transfer roller. If the transfer roller is dirty with toner, try printing several pages.</p> 
<p>Characters out of position.</p> 	<p><b>Check the file or program.</b> Check whether the problem is being caused by a <b>PRESCRIBE</b> command error. If the problem occurs only with a specific file or program, the most likely cause is an error in a parameter to a command or command syntax.</p>

## 3. Indicators and Messages

The tables on the following pages indicate how to respond to problems indicated by the operator panel indicators and messages.

### 3.1 Indicators

Indicator	Condition	Description
 READY	Flashing	An error occurs that you can clear by yourself.
	Lit	The printer is on-line. The printer is ready to print.
	Off	The printer is off-line. The printer stores but does not print received data. Also indicates when printing is automatically stopped due to occurrence of an error.
 DATA	Flashing	Data transfer is taking place.
	Lit	Either data is being processed, or data is being written onto the option memory card or hard disk.
 ATTENTION	Flashing	The printer needs maintenance attention or the printer is warming up (Please wait).
	Lit	A problem or an error occurs that you can clear by yourself. (For example, a paper jam occurs.)
	Off	Operations are normal.





### 3.2 Maintenance Messages

The following table lists maintenance messages that you can deal with by yourself. If `Call service person` appears, turn off the printer, disconnect the power cord, and contact your Kyocera Mita dealer.

Message	Corrective Action
Add paper (paper source)	The paper has run out. Supply paper according to the paper source displayed (paper cassette, MP tray, or optional paper feeder).  Messages indicating the printer status (Ready, Please wait, Processing*, Waiting, and FormFeed Time Out*) are displayed alternately. * These messages will not appear when the number of copies is set to 2 or more.
Add staples	No staples are installed in the stapler. Set it in the stapler.
Call service ####:0123456	#### represents a mechanical error (#=0, 1, 2, ...). Call for service. The printer does not operate when this message is displayed. The total number of pages printed is also indicated, e.g. 0123456.
Call service F###:	F### represents a controller error (#=0, 1, 2, ...). Call for service. The printer does not operate when this message is displayed.
Call service person F0	This message means an error in data communications between the printer controller and the operator panel. Call for service. The printer does not operate when this message is displayed.
Chad box full	The punch unit chad box of the option document finisher is full. Discard the chads.
Check chad box Press GO	The punch unit waste box of the DF-70 document finisher is full or is not installed correctly. Check if the box is properly installed, and then discard the chads if the box is full. Press the <b>GO</b> key to resume printing.
Clean printer Press GO	Clean the inside of the printer. See <a href="#">Toner Container Replacement on page 6-1</a> . This message will be displayed when replacing the toner container after the message <code>Replace toner Clean printer</code> is displayed. After cleaning the inside of the printer, press the <b>GO</b> key and the printer will be ready for printing.
Close finisher cover	Close the option document finisher cover.



## Chapter 4 Troubleshooting

Message	Corrective Action
Close front cover	Close the printer front cover.
Close left cover 1 (-3)	Close the printer left cover. If left cover of the option paper feeder is open, 2 or 3 is displayed.
Close reverse adapter	Close the reverse adapter cover of the option document finisher.
Face-down tray paper full 	The face-down tray has become full (approx. 500 pages). You must remove all printed pages from the face-down tray. When the printer senses that the face-down tray is empty again, it will continue printing into the face-down tray.
Finisher tray 1(2) paper full	The finisher tray is full. When removing the paper, printing will be resumed, "1" indicates the upper tray, while "2" indicates the lower tray.
Finisher path error	The option document finisher is not installed correctly. Install it correctly.
Install MK	The maintenance kit (MK-700 for FS-9100DN/MK-701 for FS-9500DN) needs to be replaced.  Replace the maintenance kit since the total number of printed pages has reached 500,000. Call for service. The maintenance kit includes a drum unit, developer unit and so on.
Load Cassette 1(to4) (paper size)/(paper type)*  *(paper size) and (paper type) are displayed flashing alternately. 	There is data for printing that matches with a paper cassette setting (paper size, paper type), but there is no paper in the paper cassette.  Set paper into the paper source as displayed on the operator panel, and press the <b>GO</b> key to restart printing. However, the paper source numbers (3 to 4) are only displayed when there is an option paper feeder installed.  Or, if you want to print from a different paper source press the $\Delta$ or $\nabla$ key to display <i>Use alternative?</i> and you can change the source for paper feeding.  After selecting a paper source and pressing the <b>MENU</b> key, <i>Paper Handling &gt;</i> appears. By pressing the $\triangleright$ key, the paper type settings menu appears. After setting the correct paper type, press the <b>ENTER</b> key and printing starts.
Load MP tray (paper size)/(paper type)  *(paper size) and (paper type) are displayed flashing alternately. 	There is no paper cassette set (paper size, paper type) that matches with the data for printing, so printing is done from the MP tray. Set paper into the MP tray that matches the paper size and type shown on the display and press the <b>GO</b> key to restart printing.  Or, if you want to print from a different paper source press the $\Delta$ or $\nabla$ key to display <i>Use alternative?</i> and you can change the source for paper feeding.  After selecting a paper source and pressing the <b>MENU</b> key, <i>Paper Handling &gt;</i> appears. By pressing the $\Delta$ key, the paper type settings menu appears. After setting the correct paper type, press the <b>ENTER</b> key and printing starts.
Missing chad box	The punch unit chad box of the DF-70 is not installed correctly. Install it correctly.
Missing toner container	Install the toner container. See <a href="#">Toner Container Replacement on page 6-1</a> . The printer does not operate when this message is displayed.
Missing stapler unit	The stapler unit is not installed correctly in the document finisher. Install it correctly.
Missing waste toner box	Install the waste toner box. See <a href="#">Toner Container Replacement on page 6-1</a> . The printer does not operate when this message is displayed.
Option interface Error ##	A failure has occurred with the option network interface card. Check the option network interface card installed in the printer.
Paper jam ##### 	Open the front cover or left cover and correct the paper jam (or paper mis-feeding in the paper cassette). The location of the paper jam is also indicated in place of the #'s. Online help messages which are useful for correcting the paper jam will be displayed by pressing the <b>?</b> key. (See <a href="#">Correcting a Paper Jam on page 4-8</a> .)



 :Alarm buzzer sounds when an error occurs. Press the **CANCEL** key to stop the alarm buzzer.

(Continued on next page)

Message	Corrective Action
Replace toner Clean printer 	Replace the toner container using a new toner kit. The printer does not operate when this message is displayed. See <a href="#">Toner Container Replacement on page 6-1</a> .
Replace waste toner box	Replace the old waste toner box with the new one which is included in the TK-70 toner kit. The message will also be shown if the waste toner box has become full. The waste toner box should be replaced when the message display eventually shows <code>Toner low TK-70</code> . See <a href="#">Toner Container Replacement on page 6-1</a> .
Toner low TK-70	Replace the toner container using a new toner kit. See <a href="#">Toner Container Replacement on page 6-1</a> .
Warning image adapt	Printing job cannot be done in current resolution because there is not enough internal memory. Try adding more memory or changing resolution. See <a href="#">Appendix B Expansion Memory</a> .
Warning Low memory	The printer's internal memory is running low due to the number of fonts and macros downloaded. Print a status page to see how much user memory is left, and try deleting unnecessary fonts and macros.

### 3.3 Error Messages

The following table lists error messages that can be dealt with by the user.

Message	Corrective Action
File not found Press GO 	VMB: A VMB tray that was specified for output does not contain any jobs, or the VMB tray is not being used. Confirm the VMB tray.  If Auto Continue is set to <code>On</code> , printing will be automatically resumed after a preset period of time. See <a href="#">Auto Continue Setting on page 3-51</a> .
Format error Memory card	This message appears when the printer is in the ready state and the memory card is not formatted, and therefore cannot be read or written.
Format error Hard disk	Initialization (formatting) of the hard disk is required. Initialize the hard disk.
Hard disk err ## Press GO 	Look at the error code given in place of ## and refer to the corresponding description given below. 01: hard disk format error. If this error recurs even if the power has been turned off and then on, reformat the hard disk. 02: The disk system is not installed. Recheck the requirements for using the system and the devices. 04: There is no available hard disk space. Delete unnecessary files, etc., to free up space. 05: The specified file does not exist in the hard disk. 06: There is no memory available to the hard disk system. Increase the available memory. 10: Formatting is not possible because host data is being spooled on the hard disk. Wait until the hard disk is ready, and then format. 20: The hard disk was installed in the incorrect slot (OPT2). Reinstall the hard disk in a different slot (OPT1/HDD). 85: VMB; Alias error (the alias setting was lost, or the VMB tray corresponding to the alias does not exist). Set the alias again. 97: Code job; The number of permanent code jobs reached the limit value, and no more can be saved. Either delete some unnecessary jobs, etc., or increase the limit. 99: A print job for the specified ID does not exist in the hard disk.
I/F occupied	This message is displayed when you attempt to use the printer's operator panel to change the environmental settings on the interface from which data are presently being received.
ID error	The ID entered for a private job, or a stored job is not correct. Check the ID that is set using the printer driver.

 :Alarm buzzer sounds when an error occurs. Press the **CANCEL** key to stop the alarm buzzer.

(Continued on next page)

## Chapter 4 Troubleshooting

Message	Corrective Action
Insert the same memory card	You have inserted the wrong memory card when the <i>Insert again</i> message was displayed. Remove the wrong memory card from the printer's memory card slot and insert the correct memory card. The printer again reads it from the beginning of the data.
KPDL error ## Press GO	Current print processing cannot continue. To print out an error report, display > <i>Print KPDL errs</i> from the mode select menu, and select <i>On</i> . Press the <b>GO</b> key to resume printing. You can abandon printing by the <b>CANCEL</b> key.  If Auto Continue is set to <i>On</i> , printing will be automatically resumed after a preset period of time. See <a href="#">Auto Continue Setting on page 3-51</a> .
Memory card err Insert again	The memory card is accidentally removed from the printer's memory card slot during reading. If you continue reading the memory card, insert the same memory card into the slot again. The printer again reads it from the beginning of the data.  <b>Note: We recommend that you follow the reading procedure from the beginning to ensure correct reading of the memory card.</b>
Memory overflow Press GO	The total amount of data received by the printer exceeds the printer's internal memory. Try adding more memory (expansion DIMM). Press the <b>GO</b> key to resume printing. You can abandon printing by the <b>CANCEL</b> key.  If Auto Continue is set to <i>On</i> , printing will be automatically resumed after a preset period of time. See <a href="#">Auto Continue Setting on page 3-51</a> .
MemoryCard err## Press GO	This message appears when an error occurs during access to the memory card using the PRESCRIBE RWER command or from the printer's operator panel. Look at the error code given in place of ## and refer to the corresponding description given below. 01: The memory card does not meet specifications. This memory card cannot be used by this printer. Insert a memory card which can be used by this printer. (See <a href="#">Memory Card (CF) on page D-2</a> .) 02: The memory card is not installed. Recheck the requirements for using the memory card. 04: The capacity of the memory card is insufficient. Clean up files. 05: Specified file not on memory card. 06: No memory for use by memory card. Expand printer memory.
Print overrun Press GO	The data transferred to the printer was too complex to print on a page. Press the <b>GO</b> key to resume printing. (The page may break in some pages.) You can abandon printing by the <b>CANCEL</b> key.  <b>Note: After this message is displayed, page protect mode will be On. To maintain optimum use of memory during printing, display &gt;Page protect from the operator panel, and re-select Auto. See <a href="#">Page Protect Mode on page 3-28</a>.</b>  If Auto Continue is set to <i>On</i> , printing will be automatically resumed after a preset period of time. See <a href="#">Auto Continue Setting on page 3-51</a> .
RAM disk error ## Press GO	Look at the error code given in place of ## and refer to the corresponding description given below. 01: Format error. Try turning the power off and on again. 02: RAM disk mode is <i>Off</i> . Turn RAM disk mode <i>On</i> . 04: No disk space. Clean up files. 05: Specified file is not on disk. 06: No memory for use by disk system. Expand printer memory.
Virtual mailbox full	The storage area for the VMB is full. Print out accumulated VMB data.

 :Alarm buzzer sounds when an error occurs. Press the **CANCEL** key to stop the alarm buzzer.

## 4. Correcting a Paper Jam

The **Paper jam** message is displayed on the message display when paper becomes stuck in the paper transport system, the paper feed timing is incorrect, or paper fails to feed at all. The jam can be corrected by removing the paper.

The printer goes off-line when the **Paper jam** message is displayed.

When a paper jam occurs, a paper jam message and the paper jam location are indicated on the message display. Details of the messages and paper jam locations are as follows:

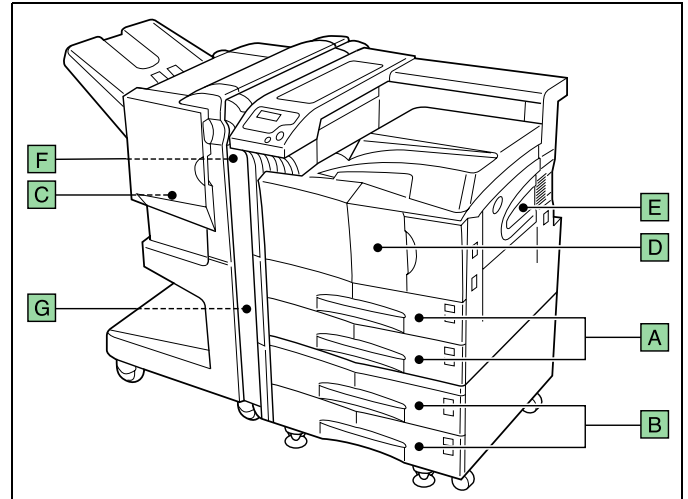

Paper jam message	Paper jam location	Description	Reference Page
Paper jam Cassette 1 (2)	A	Paper is jammed at the paper cassette or inside the printer. "1" appears with upper cassette, while "2" with lower cassette.	4-9
Paper jam Cassette 3 (4)	B	Paper is jammed at the option paper feeder cassette. When installing the paper feeder PF-70, "3" appears with upper cassette, while "4" with lower cassette.	4-9
Paper jam Finisher	C	Remove the paper jammed in the paper stacker. (For details, see the operation guide for document finisher)	See document finisher DF-75 Operation Guide
Paper jam MP Transport	D	Paper is jammed inside the MP transport.	4-9
Paper jam MP Tray	E	Paper is jammed at the MP tray.	4-9
Paper jam Reverse adapter	F	Paper is jammed at the reverse adapter of document finisher DF-75.	See document finisher DF-75 Operation Guide
Paper jam Left cover 1 (to 3)	G	Paper is jammed in the left cover section. "3" appears when jam occurs in the left cover section of the paper feeder.	4-10

When the jammed paper has been removed, open and close the printer's front cover. Then the printer automatically warms up, goes on-line, and continues printing. Depending on the point at which the jam occurred, the printer may or may not print the jammed page.

If paper jams occur frequently, try using a different type of paper, replace with paper from another ream, turn the stack of paper over, or turn the paper the other way around. Also, look for tiny pieces of paper that may have been torn off and overlooked when the jammed paper was removed.

If you cannot solve the problem by changing the paper, there may be a problem with the printer. Contact your service representative.

### NOTE

When pulling the paper, pull it gently so as not to tear it. Torn pieces of paper are difficult to remove and may be easily overlooked, deterring the jam recovery.

### Online help messages

With the online help message function, this printer can display the procedure to correct a paper jam on the message display. When a paper jam message is displayed, press the **?** key.

Pressing the **▽** key at the online help message display shows the next step; pressing the **△** key shows the previous step. To exit the online help message display, press the **■** key. The previously shown paper jam message appears.

### 4.1 Jam in Paper Cassette

The following procedure also applies to the optional paper feeder.

- 1 Pull out the paper cassette.

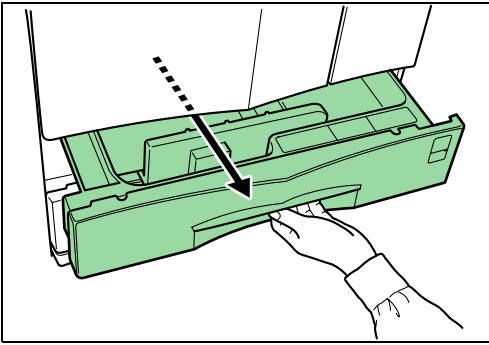

- 2 Remove the jammed paper while taking care not to tear it. If the paper has been torn, remove all the scraps from the inside the printer.

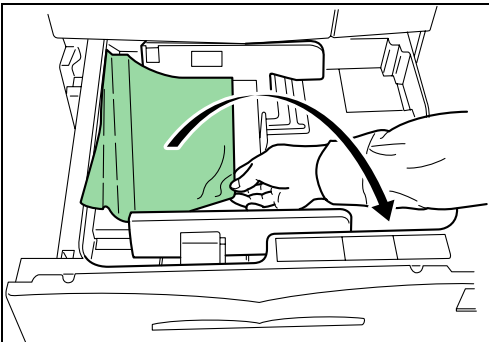

- 3 Close the paper cassette.

### 4.2 Jam at the MP Tray

Paper is jammed at the MP tray. Remove the jammed paper using the procedure given below.

- 1 Remove the paper jammed at the MP tray.

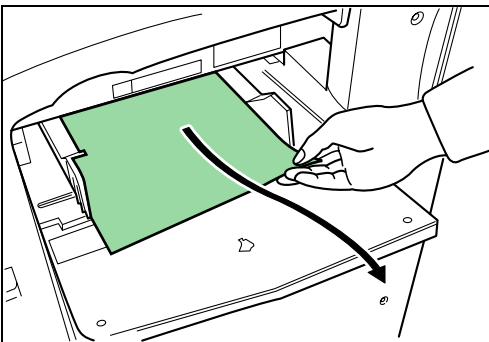

- 2 If the jammed paper remains at the MP tray, pull up the lever and remove the jammed paper.

\* If the mised paper cannot be removed, go to the next step.

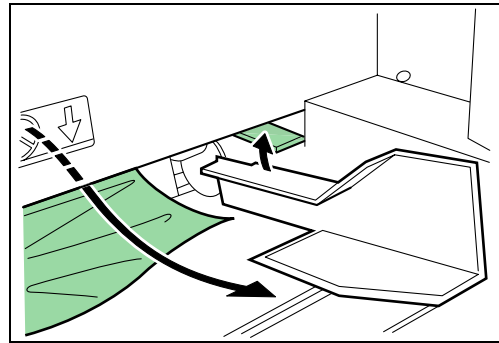

- 3 Pull up the lock lever and open left cover 1.

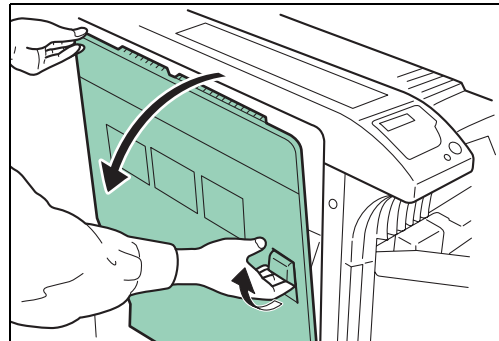

- 4 Remove the jammed paper.

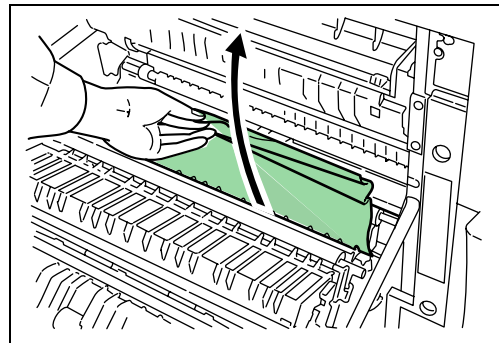

- 5 Push the lever (gray colored) to raise the duplex unit and remove the jammed paper.

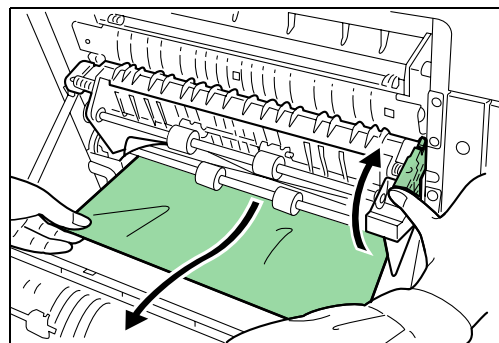

**6** Open the front cover.

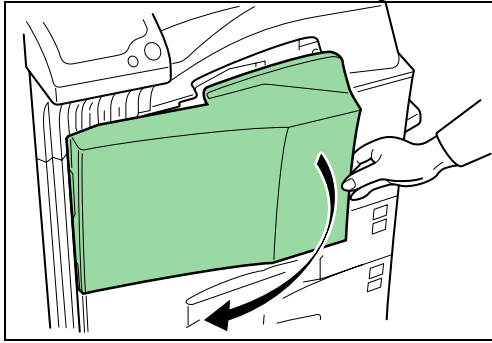

**11** Remove the jammed paper.

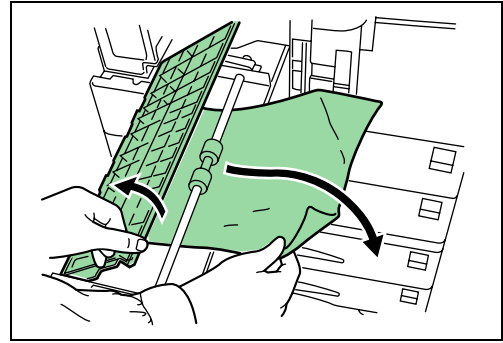

**7** Turn the knob clockwise to release the jammed paper from the MP transport tray section.

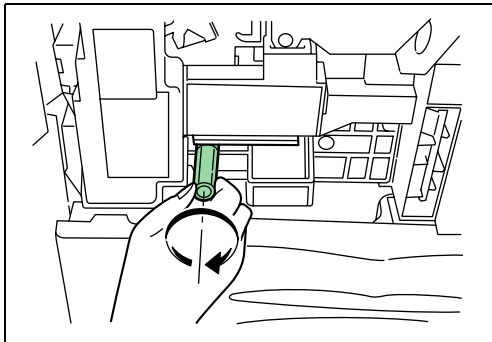

**12** If the paper has been torn, remove the MP transport tray.

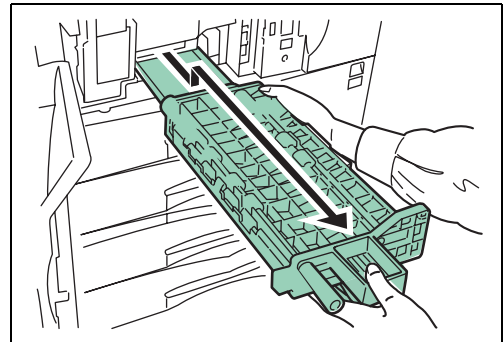

**8** Remove the jammed paper.

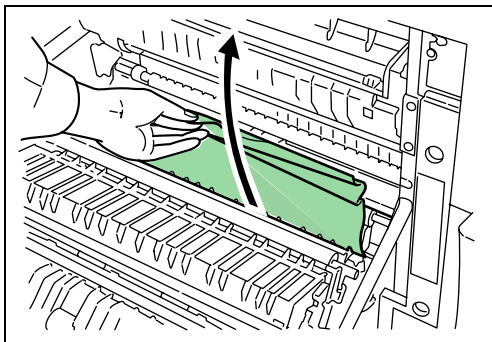

**13** Remove the jammed paper.

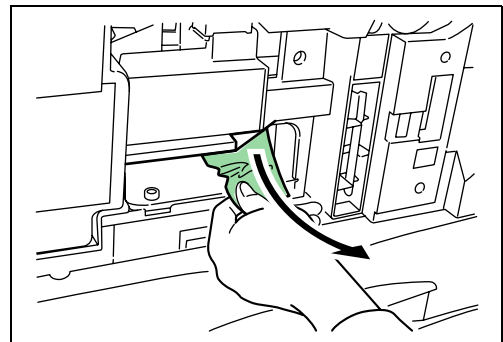

**9** Pull out the MP transport tray.

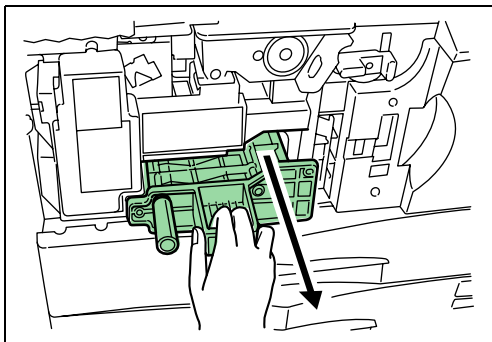

**14** Replace the MP transport tray in its original position.

**15** Close the front cover.

**10** Open the MP transport tray cover.

### 4.3 Jam in Left Cover 1

**CAUTION**

- Take care not to leave any small pieces of paper in the printer when removing paper jams as this may result in fire.
- The printer's fixing unit is extremely hot. Take sufficient care when working in this area, as there is a danger of getting burned.



## Chapter 4 Troubleshooting

- 1 Pull up the lock lever and open left cover 1.

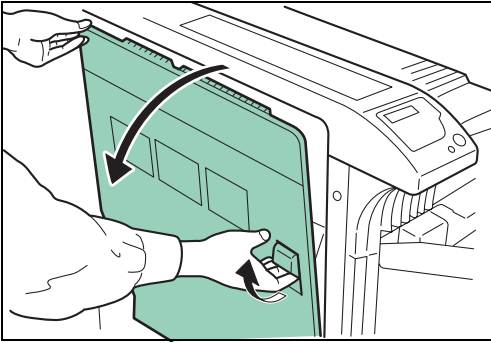

- 2 Remove the jammed paper.

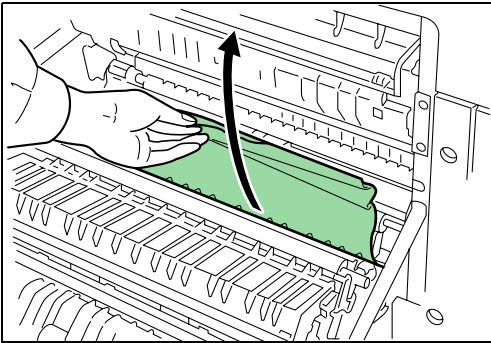

- 3 Push the lever (gray colored) to raise the duplex unit and remove the jammed paper.

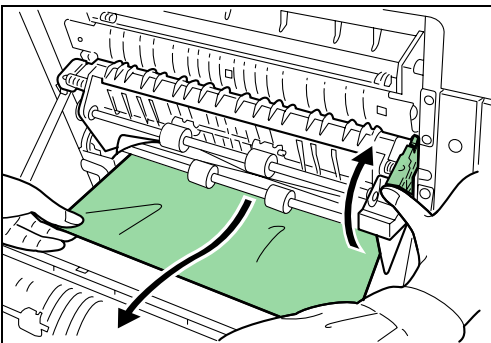

- 4 If there is jammed paper in the output section, remove it.

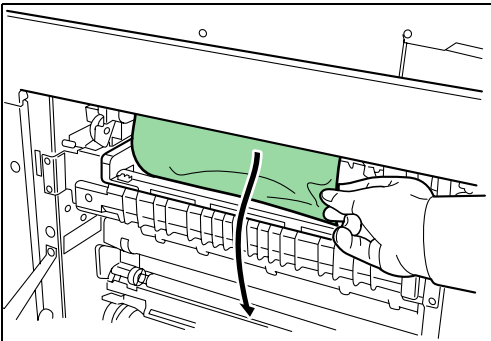

- 5 Close left cover 1.

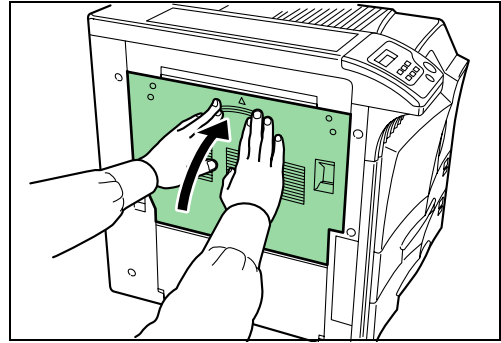

### 4.4 Jam in Left Cover 2

- 1 Open left cover 2.

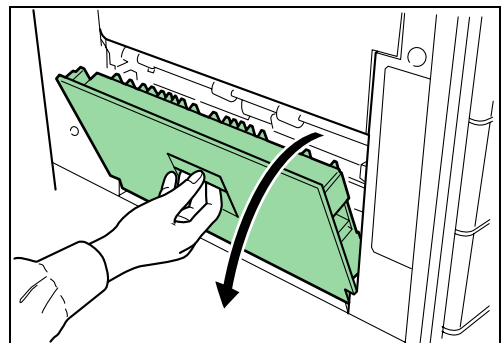

- 2 Remove the jammed paper.

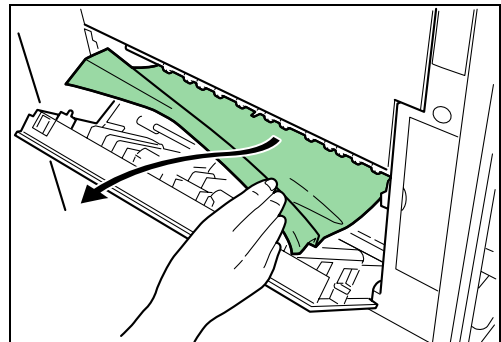

- 3 Close left cover 2.

### 4.5 Paper Jam at the Option Document Finisher

Paper is jammed at the option document finisher. Remove jammed paper referring to the Document Finisher Operation Guide.

# Chapter 5 Paper Selection

This chapter explains the following topics:

- General Guidelines
- Special Paper
- Paper Type

## 1. General Guidelines

The printer is designed to print on high-quality copier bond paper (the kind used in ordinary dry copier machines), but it can also accept a variety of other types of paper within the limits specified below.

### NOTE

The manufacturer assumes no liability for problems that occur when paper not satisfying these requirements is used.

Selection of the right paper is important. Using the wrong paper can result in paper jams, misfeeding, curling, poor print quality, and paper waste, and in extreme cases can damage the printer. The guidelines given below will increase the productivity of your office by ensuring efficient, trouble-free printing and reducing wear and tear on the printer.

## 1.1 Paper Availability

Most types of paper are compatible with a variety of machines. Paper intended for xerographic copiers can also be used with the printer.

There are three general grades of paper: economy, standard, and premium. The most significant difference between grades is the ease with which they pass through the printer. This is affected by the smoothness, size, and moisture content of the paper, and the way in which the paper is cut. The higher the grade of paper you use, the less risk there will be of paper jams and other problems, and the higher the level of quality your printed output will reflect.

Differences between paper from different suppliers can also affect the printer's performance. A high-quality printer cannot produce high-quality results when the wrong paper is used. Low-priced paper is not economical in the long run if it causes printing problems.

Paper in each grade is available in a range of basis weights (defined later). The traditional standard weights are 16, 20, and 28 pounds (60 to 105 g/m<sup>2</sup>).

## 1.2 Paper Specifications

The following table summarizes the basic paper specifications. Details are given on the following pages.

Item	Specification
Weight	Cassette: 60 to 105 g/m <sup>2</sup> (16 to 28 lb/ream) MP tray: 60 to 200 g/m <sup>2</sup> (16 to 53 lb/ream)
Thickness	0.086 to 0.110 mm (3.4 to 4.3 mils)
Dimensional accuracy	±0.7 mm (±0.0276 inches)
Squareness of corners	90° ±0.2°
Moisture content	4 to 6 %
Direction of grain	Long grain
Pulp content	80 % or more

## 1.3 Selecting the Right Paper

Laser printing is a process involving laser light, electrostatic discharge, toner, and heat. In addition, as the paper passes through the printer it undergoes considerable sliding, bending, and twisting motions. A high-quality printing paper matching the printer's requirements withstands all these stresses, enabling the printer to turn out clean, crisp printed copies consistently.

Remember that all paper is not the same. Some of the factors to consider when selecting paper for the printer are as follows:

### Condition of the Paper

Avoid using paper that is bent at the edges, curled, dirty, torn, embossed, or contaminated with lint, clay, or paper shreds.

Use of paper in these conditions can lead to illegible printing, misfeeding, and paper jams, and can shorten the life of the printer. In particular, avoid using paper with a surface coating or other surface treatment. The paper should have as smooth and even a surface as possible.



## Chapter 5 Paper Selection

MP tray	Size	Cassette or MP tray	Size
Monarch	3-7/8 × 7-1/2 inches	Ledger	11 × 17 inches
Business	4-1/8 × 9-1/2 inches	Legal	8-1/2 × 14 inches
Commercial 9	3-7/8 × 8-7/8 inches	Letter	8-1/2 × 11 inches
Commercial 6-3/4	3-5/8 × 6-1/2 inches	Statement	5-1/2 × 8-1/2 inches
International DL	11 × 22 cm	Folio	210 × 330 mm
International C5	16.2 × 22.9 cm	ISO A3	297 × 420 mm
ISO A6	105 × 148 mm	ISO A4	210 × 297 mm
JIS B6	128 × 182 mm	ISO A5	148 × 210 mm
International B5	17.6 × 25 cm	JIS B4	257 × 364 mm
Executive	7-1/4 × 10-1/2 inches	JIS B5	182 × 257 mm
International C4	229 × 324 mm	Paper with other sizes (custom sizes) can also be fed from the MP tray. The minimum size paper for manual feed is 88 × 148 mm (3-1/2 × 5-13/16 inches), fed lengthwise. The maximum size is 297 × 450 mm (11-11/16 × 17-3/4 inches).	
oficio II	8-1/2 × 13 inches		
Hagaki	100 × 148 mm		
Oufuku Hagaki	148 × 200 mm		
Youkei 2	114 × 162 mm		
Youkei 4	105 × 235 mm		

### Composition

Do not use paper that has been coated or surface-treated and contains plastic or carbon. The heat of fusing can cause such paper to give off harmful fumes.

Bond paper should contain at least 80 % pulp. Not more than 20 % of the total paper content should consist of cotton or other fibers.

### Paper Size

Cassettes and an MP tray are available for the paper sizes listed in the table above. The dimensional tolerances are ±0.7 mm (±0.0276 inches) for the length and width. The angle at the corners must be 90° ±0.2°.

### Smoothness

The paper should have a smooth, uncoated surface. Paper with a rough or sandy surface can cause voids in the printed output. Paper that is too smooth, however, can cause multiple feeding and fogging problems. (Fogging is a gray background effect.)

### Basis Weight

Basis weight is the weight of a standard quantity of paper. In the traditional system, the standard quantity is a ream consisting of 500 sheets measuring 17 × 22 inches each. In the metric system the standard quantity is 1 square meter.

Paper that is too light or too heavy can cause misfeeding, jams, and premature wear of the printer. Uneven paper weight can cause multiple feeds, print defects, poor toner fusing, blurring, and other print quality problems. The proper weight is 60 to 105 g/m<sup>2</sup> for the paper cassette, and 60 to 200 g/m<sup>2</sup> for the MP tray.

### Thickness (Caliper)

Thick paper is referred to as high-caliper paper and thin paper as low-caliper paper. The paper used with the printer should be neither extremely thick nor extremely thin. If you are having problems with paper jams, multiple feeds, and faint printing, the paper you are using may be too thin. If you are having problems with paper jams and blurred printing, the paper may be too thick. The proper thickness is 0.086 to 0.110 mm (3.4 to 4.3 mils).

### Moisture Content

Moisture content is defined as the percent ratio of moisture to the dry mass of the paper. Moisture can affect the paper's appearance, feedability, curl, electrostatic properties, and toner fusing characteristics.

The moisture content of the paper varies with the relative humidity in the room. When the relative humidity is high and the paper absorbs moisture, the paper edges expand, becoming wavy in appearance. When the relative humidity is low and the paper loses moisture, the edges shrink and tighten, and print contrast may suffer.

Wavy or tight edges can cause misfeeding and alignment anomalies. The moisture content of the paper should be 4 to 6%. To ensure the proper moisture content, it is important to store the paper in a controlled environment. Some tips on moisture control are:

- Store paper in a cool, dry location.
- Keep the paper in its wrapping as long as possible. Rewrap paper that is not in use.
- Store paper in its original carton. Place a pallet, etc., under the carton to separate it from the floor.
- After removing paper from storage, let it stand in the same room as the printer for 48 hours before use.
- Avoid leaving paper where it is exposed to heat, sunlight, or damp.

### Paper Grain

When paper is manufactured, it is cut into sheets with the grain running parallel to the length (long grain) or parallel to the width (short grain). Short grain paper can cause feeding problems in the printer. All paper used in the printer should be long grain.

### Other Paper Properties

**Porosity:** Refers to the density of the paper structure; that is, how openly or compactly the fibers are bonded.

**Stiffness:** Limp paper can buckle inside the printer, while paper that is too stiff may bind. Either way the result is a paper jam.

**Curl:** Most paper has a natural tendency to curl in one direction. The paper should be loaded so that the natural curl is downward, to counteract the upward curl imparted by the printer. Printed sheets will then come out flat. Most paper also has a top and bottom surface. Loading instructions are usually given on the paper package.

#### NOTE

If the paper is considerably curled in one direction, e.g. when the paper was used to print on one side, try to roll the paper in the opposite direction to counteract the curl. Printed sheets will then come out flat.

**Electrostatic properties:** During the printing process, the paper is electrostatically charged to attract the toner. The paper must be able to release this charge so that printed sheets do not cling together in the output tray.

**Whiteness:** The contrast of the printed page depends on the whiteness of the paper. Whiter paper provides a sharper, brighter appearance.

**Quality control:** Uneven sheet size, corners that are not square, ragged edges, welded (uncut) sheets, and crushed edges and corners can cause the printer to malfunction in various ways. A quality paper supplier should take considerable care to ensure that these problems do not occur.

**Packaging:** Paper should be packed in a sturdy carton to protect it from damage during transport. Quality paper obtained from a reputable supplier is usually properly packaged.

## 2. Special Paper

This section explains printing on special paper. The page printer can use the following types of special paper. In this case, set the media type according to the table below.

Paper type to be used	Media type to be selected
Colored paper	Color
Preprinted paper	Preprinted
Overhead projector transparencies	Transparency
Postcards	Cardstock
Envelopes	Envelope
Label	Labels

When using the above types of paper, be sure to use products that are specified for use with photocopiers and/or page printers. Feed paper other than colored paper or preprinted paper from the MP (multi-purpose) tray. Use paper that is sold specifically for use with copiers (heat-fusing type). Label paper and envelopes should not be placed in the cassette.

Since the composition and quality of special paper vary considerably, special paper is more likely than white bond paper to give trouble during printing. No liability will be assumed if moisture, etc., given off in printing on special paper causes harm to the machine or operator.

#### NOTE

Before purchasing any type of special paper, test a sample on the printer and check that print quality is satisfactory.

Specifications for each type of special paper are given below.

### 2.1 Transparency (Overhead Projection Film)

Transparency must be able to withstand the heat of fusing during the printing process. It should satisfy the conditions given in the table below.

Item	Specification
Tolerance of heat	Must tolerate at least 190 °C (374 °F)
Thickness	0.100 to 0.110 mm (3.9 to 4.3 mils)
Material	Polyester
Dimensional accuracy	±0.7 mm (±0.0276 inches.)
Squareness of corners	90° ± 0.2°

If transparency jams frequently, pull the top of the sheet very gently as it leaves the printer.

### 2.2 Adhesive-Backed Labels

The basic rule for printing on adhesive labels is that the adhesive must never come into contact with any part of the printer. Adhesive paper sticking to the drum or rollers will damage the printer. Label paper must be manually fed.

Label paper has a structure comprised of three layers, as shown in the figure below. The top sheet is printed on. The adhesive layer consists of pressure-sensitive adhesives. The carrier sheet (also called the linear or backing sheet) holds the labels until use. Due to the complexity of its composition, adhesive-backed label paper is particularly likely to give trouble in printing.

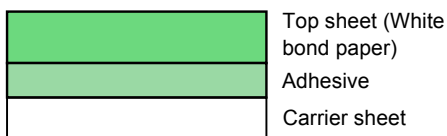

Adhesive label paper must be entirely covered by its top sheet, with no spaces between the individual labels. Labels with spaces in between are apt to peel off, causing serious paper jam problems.

Some label paper is manufactured with an extra margin of top sheet around the edge. Do not remove the extra top sheet from the carrier sheet until after printing is finished.

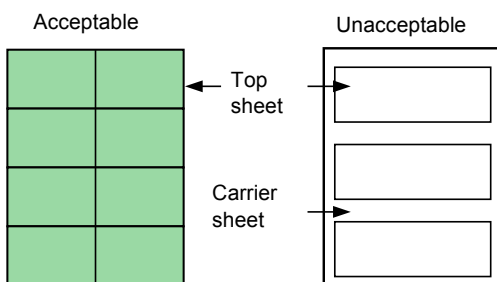

The table below lists the specifications for adhesive label paper.

Item	Specification
Weight of top sheet	44 to 74 g/m <sup>2</sup> (12 to 20 lb/ream)
Composite weight	104 to 151 g/m <sup>2</sup> (28 to 40 lb/ream)
Thickness of top sheet	0.086 to 0.107 mm (3.9 to 4.2 mils)
Composite thickness	0.115 to 0.145 mm (4.5 to 5.7 mils)
Moisture content	4 to 6 % (composite)

#### Envelopes

The printer can print on envelopes using paper with a basis weight of 60 to 79 g/m<sup>2</sup> (16 to 21 lb/ream). Envelopes must be manually fed.

An envelope is a more complex object than a single sheet of paper. For this reason, it may not be possible to obtain consistent print quality over the entire envelope surface.

Many envelopes have a diagonal grain orientation (See [Paper Grain on page 5-3](#)). This orientation is more likely to wrinkle and crease on its way through the printer. Before purchasing envelopes for use with the printer, test a sample to verify the envelope's suitability.

Do not use envelopes that have an encapsulated liquid adhesive.

Avoid long printing runs consisting of envelopes only. Extensive envelope printing can cause premature printer wear. To avoid jamming due to curled envelopes, do not leave more than approximately 10 printed envelopes stacked in the paper trays during multiple envelope printing.

#### Colored Paper

Colored paper should satisfy the same conditions as white bond paper, listed in [Paper Specifications on page 5-1](#). In addition, the pigments used in the paper must be able to withstand the heat of fusing during the printing process (up to 200 °C or 392 °F).

#### Preprinted Paper

Preprinted paper should have a bond paper base. The preprinted ink must be able to withstand the heat of fusing during the printing process, and must not be affected by silicone oil.

Do not use paper with any kind of surface treatment, such as the type of paper commonly used for calendars.

#### Recycled Paper

Select recycled paper that meets the same specifications as the white bond paper (see [Paper Specifications on page 5-1](#)) except whiteness.

#### NOTE

Before purchasing recycled paper, test a sample on the printer and check that the print quality is satisfactory.

### 3. Paper Type

The printer is capable of printing under the optimum setting for the type of paper being used.

Setting the paper type for the paper source from the printer's operator panel will cause the printer to automatically select the paper source and print in the mode best suited to that type of paper.

A different paper type setting can be made for each paper source including the MP tray. Not only can preset paper types be selected, but it is also possible for you to define and select customized paper types. See [Customizing Paper Type on page 3-45](#).

The following types of paper can be set.

<b>Media Type</b>	<b>Paper source</b>	<b>MP tray</b>	<b>Paper Cas- sette</b>	<b>Paper Weight</b>	<b>Duplex path (MP tray available only in Cassette mode)</b>
Plain		Yes	Yes	Normal	Yes
Transparency		Yes	No	Extra Heavy	No
Preprinted		Yes	Yes	Normal	Yes
Labels		Yes	No	Normal	No
Bond		Yes	Yes	Normal	Yes
Recycled		Yes	Yes	Normal	Yes
Vellum		Yes	No	Light (Thin)	No
Rough		Yes	Yes	Normal	Yes
Letterhead		Yes	Yes	Normal	Yes
Color		Yes	Yes	Normal	Yes
Prepunched		Yes	Yes	Normal	Yes
Envelope		Yes	No	Heavy (Thick)	No
Cardstock		Yes	No	Heavy (Thick)	No
Custom 1 (to 8) *		Yes	Yes	Normal	Yes

Yes: Can be stored No: Cannot be stored

\* This is a paper type defined and registered by the user. Up to eight types of user settings may be defined. For details on [Customizing Paper Type on page 3-45](#).

# Chapter 6 Maintenance

This chapter explains how to replace the toner container and the waste toner box and how to clean the internal parts of the printer. When you replace the toner container, make sure to clean the internal parts of the printer.

## 1. Toner Container Replacement

The toner container in the printer should be replaced as soon as the message display shows `Toner low TK-70` or soon after. If you continue to use the printer, eventually the toner supply will be exhausted at which point the printer will stop printing and the `Replace toner Clean printer` message will be shown instructing you to install a new toner kit.

### 1.1 Toner Container Replacement Interval

Assuming an average toner coverage of 5 % and Ecoprint mode turned off, the toner container will need replacing approximately once every 40,000 pages.\*

\* For a new printer with a toner kit installed for the first time, the number of copies that can be printed will be approximately 20,000.

#### Toner Kits to be Used

Name: TK-70 (40,000 pages)

Contents: Toner container

Waste toner box

Wiper cloth

Grid cleaner

2 plastic bags (for disposal of the old toner container and waste toner box)

Installation Guide

#### NOTE

- Be sure to distance items such as floppy disks during toner container replacement.
- Be sure to clean the inside of the printer when replacing the toner container.
- Use of original Kyocera Mita toner kits is highly recommended to prevent printer trouble and ensure the long life of the printer.

## 1.2 Replenishing Toner

Replace the toner container using the following procedures.

- 1 Open the printer front cover all the way.

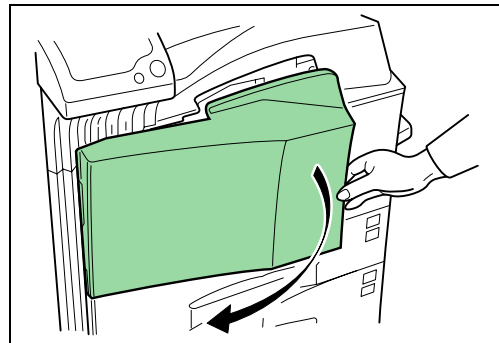

- 2 Push the lock lever (blue colored) up and gently remove the toner container until its handle appears.

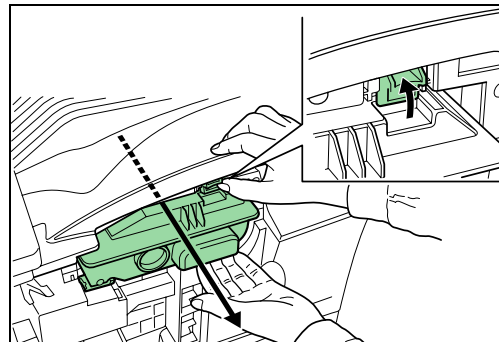

#### NOTE

Do not pull the toner container all the way as it can fall off and the toner spots the floor.

- 3** Grasp the handle on the toner container, push the lock lever up again and gently lift the toner container.

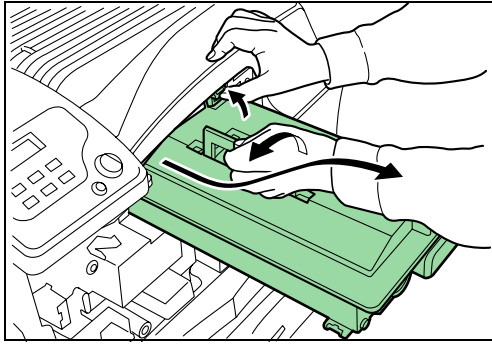

- 4** Seal up the old toner container with the supplied plastic bag and dispose of it.

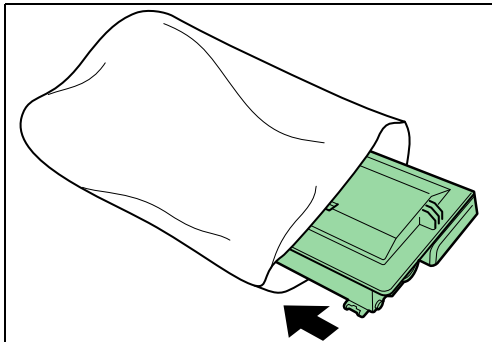

- 5** Lightly tap the new toner on the top 5 to 6 times.

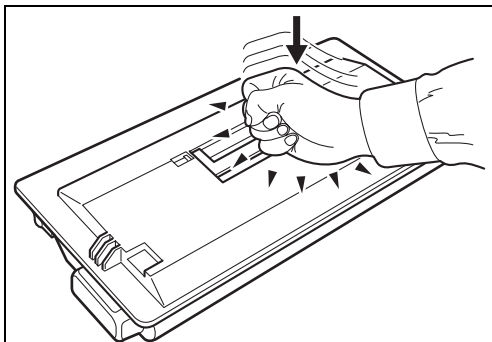

- 6** Thoroughly shake the toner container (in the direction of the arrow) ten times or more to loosen and mix the toner inside.

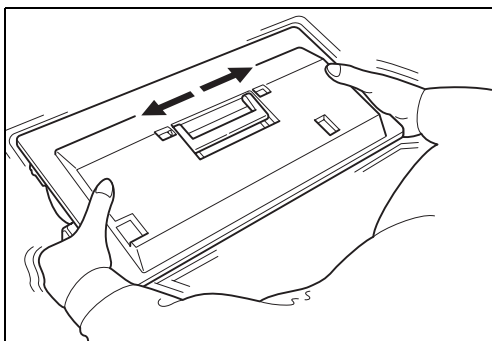

- 7** Grasp the handle on the toner container and insert the toner container along the rail of the printer.

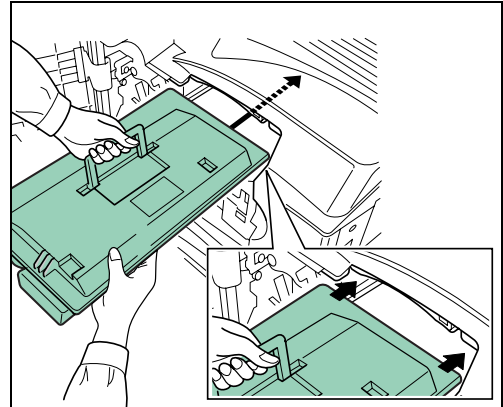

When inserting, be sure that the gear side of the toner container faces the printer. Leave the front cover open to allow insertion of the waste toner box.

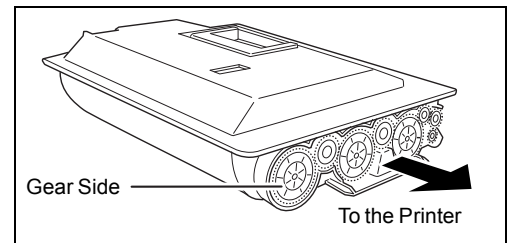

- 8** Hold the toner container by hands and fully insert it into the printer.

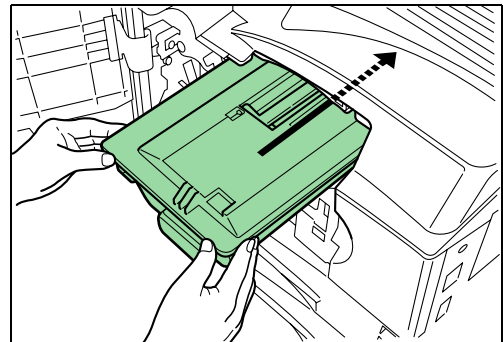

- 9** Remove the old waste toner box as shown in the figure.

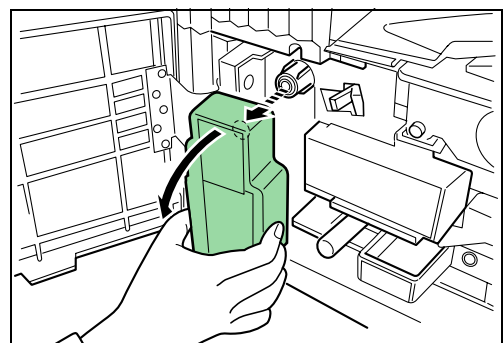

- 10** Remove the seal from the rear of the old waste toner box, and then close the opening of the box with the seal. Seal up the old waste toner box with the supplied plastic bag and dispose of it.

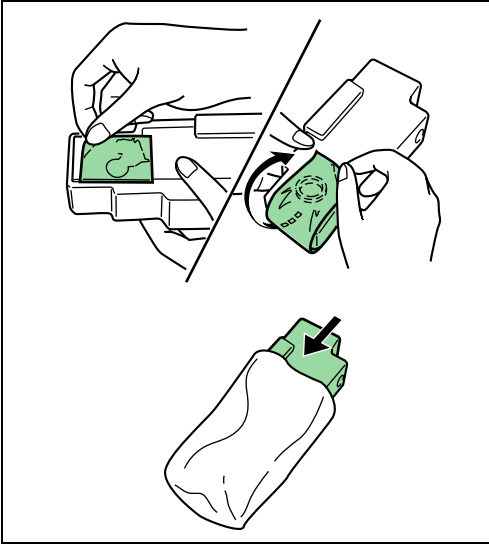

- 11** Gently pull the cleaning knob as far as it will go, push and pull it several times, and then push it back in.

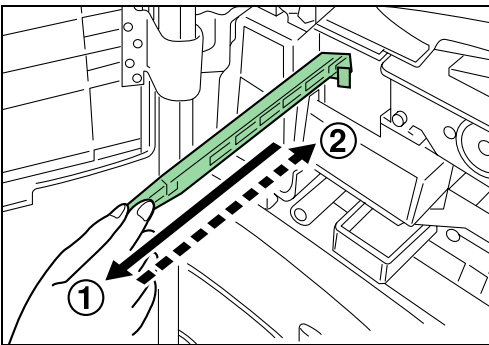

- 12** Take out the new grid cleaner from the protective bag, and then remove the cap from the grid cleaner.

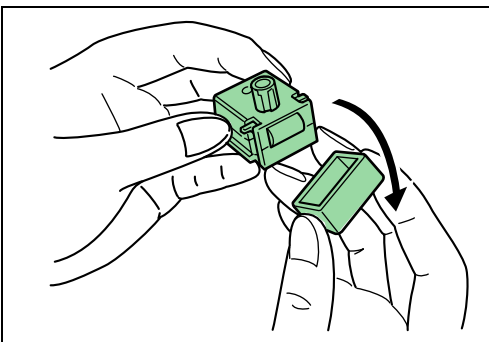

- 13** Pull the main charger approximately 5 cm (2 inches) out.

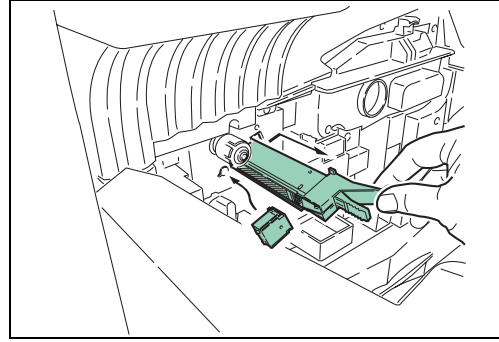

- 14** While avoiding the main charger roller (A) to be in contact with the grid cleaner pad, push and pull the main charger several times. (Do not push the main charger all the way in. Otherwise, water from the pad will cause the main charger unit to become wet and this may affect printing.)

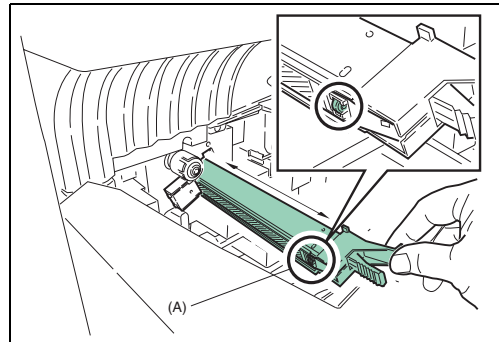

When the grid is clean, remove the grid cleaner from the printer and dispose of it. The grid cleaner is not re-usable.

- 15** Fit the new waste toner box to the printer.

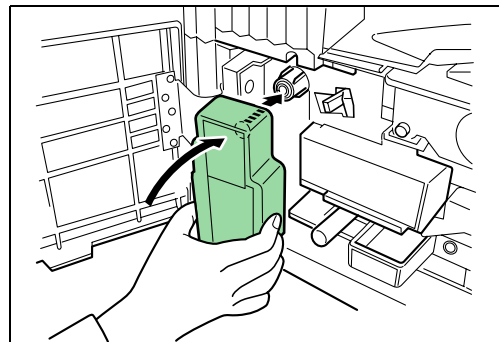

- 16** Remove the blue colored cleaning brush.

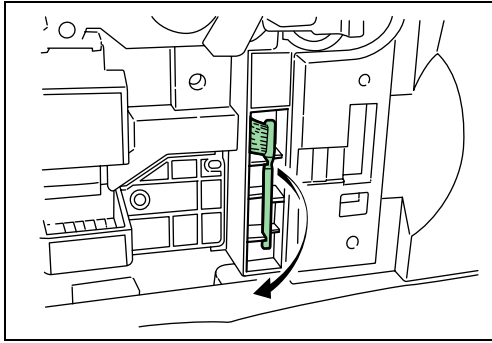

- 17** Pull up the lock lever on the left side of the printer, and open the left cover 1.

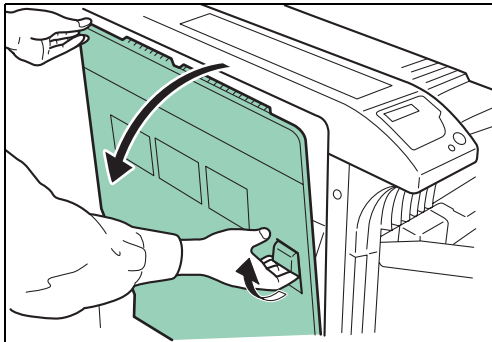

- 18** Clean the separator by moving the cleaning brush from left to right along with the separator.

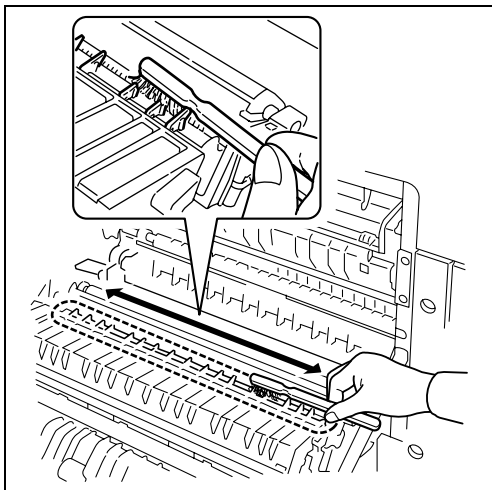

- 19** Replacing of toner and cleaning of the internal parts of the printer are completed. Close the front cover and the left cover 1.

Allow approximately five minutes before using the printer until the main charger unit has dried up.



# Appendix A    Fonts

---

This appendix explains the types of fonts you can use with the printer. A font is a set of characters of a particular design. The design is referred to as a typeface. Several characteristics identify a font. These include the code set (For details on the code sets, read the [Programming Manual](#) on the supplied Kyocera Mita Digital Library CD-ROM and Kyocera Mita Network Library CD-ROM), spacing, pitch, height, style, stroke weight, and typeface family.

## List of Fonts

---

This section contains a full list of the printer's internal fonts. The printer has 80 PCL fonts and 136 PostScript Level 3 compatible fonts. You can print the font list from the printer by using the printer's operator panel key. To print a list of fonts, refer to [Printing a List of Fonts on page 3-26](#). Font may be downloaded to the printer's memory from a option memory card or hard disk.

## ■ PCL (Scalable and Bitmap) Fonts

AlbertusMd  
**ABCDEabcde?\*‘012345’**  
 AlbertusExtBd  
**ABCDEabcde?\*‘012345’**  
 AntiqueOlive  
 ABCDEabcde?\*‘012345’  
 AntiqueOlive-Bd  
**ABCDEabcde?\*‘012345’**  
 AntiqueOlive-It  
 ABCDEabcde?\*‘012345’  
 Arial  
 ABCDEabcde?\*‘012345’  
 Arial-Bd  
**ABCDEabcde?\*‘012345’**  
 Arial-It  
 ABCDEabcde?\*‘012345’  
 Arial-BdIt  
**ABCDEabcde?\*‘012345’**  
 CGOmega  
 ABCDEabcde?\*‘012345’  
 CGOmega-Bd  
**ABCDEabcde?\*‘012345’**  
 CGOmega-It  
 ABCDEabcde?\*‘012345’  
 CGOmega-BdIt  
**ABCDEabcde?\*‘012345’**  
 CGTimes  
 ABCDEabcde?\*‘012345’  
 CGTimes-Bd  
**ABCDEabcde?\*‘012345’**  
 CGTimes-It  
 ABCDEabcde?\*‘012345’  
 CGTimes-BdIt  
**ABCDEabcde?\*‘012345’**  
 Clarendon-Cd  
**ABCDEabcde?\*‘012345’**  
 Courier  
 ABCDEabcde?\* ‘012345’  
 Courier-Bd  
**ABCDEabcde?\* ‘012345’**  
 Courier-It  
 ABCDEabcde?\* ‘012345’  
 Courier-BdIt  
**ABCDEabcde?\* ‘012345’**  
 CourierPS  
 ABCDEabcde?\* ‘012345’  
 CourierPS-Bd  
**ABCDEabcde?\* ‘012345’**  
 CourierPS-Ob  
 ABCDEabcde?\* ‘012345’  
 CourierPS-BdOb  
**ABCDEabcde?\* ‘012345’**  
 Coronet  
*ABCDEabcde?\*‘012345’*  
 GaramondAntiqua  
 ABCDEabcde?\*‘012345’  
 Garamond-Hlb  
**ABCDEabcde?\*‘012345’**  
 Garamond-Krsv  
 ABCDEabcde?\*‘012345’  
 Garamond-HlbKrsv  
**ABCDEabcde?\*‘012345’**  
 Helvetica  
 ABCDEabcde?\*‘012345’  
 Helvetica-Bd  
**ABCDEabcde?\*‘012345’**  
 Helvetica-Ob  
 ABCDEabcde?\*‘012345’  
 Helvetica-BdOb  
**ABCDEabcde?\*‘012345’**  
 Helvetica-Nr  
 ABCDEabcde?\*‘012345’  
 Helvetica-NrBd  
**ABCDEabcde?\*‘012345’**  
 Helvetica-NrOb  
 ABCDEabcde?\*‘012345’  
 Helvetica-NrBdOb  
**ABCDEabcde?\*‘012345’**  
 ITCAvantGardeGothic-Bk  
 ABCDEabcde?\*‘012345’  
 ITCAvantGardeGothic-Dm  
**ABCDEabcde?\*‘012345’**

ITCAvantGardeGothic-BkOb  
 ABCDEabcde?\*‘012345’  
 ITCAvantGardeGothic-DmOb  
**ABCDEabcde?\*‘012345’**  
 ITCBookman-Lt  
 ABCDEabcde?\*‘012345’  
 ITCBookman-Dm  
**ABCDEabcde?\*‘012345’**  
 ITCBookman-LtIt  
 ABCDEabcde?\*‘012345’  
 ITCBookman-DmIt  
**ABCDEabcde?\*‘012345’**  
 ITCZapfChancery-MdIt  
*ABCDEabcde?\*‘012345’*  
 ITCZapfDingbats  
 ✪✠✡✢✣✤✥✦✧✨✩✪✫✬✭✮✯✰✱✲✳✴✵✶✷✸✹✺✻✼✽✾✿  
 LetterGothic  
 ABCDE abcde?\*‘012345’  
 LetterGothic-Bd  
**ABCDE abcde?\*‘012345’**  
 LetterGothic-It  
*ABCDEabcde?\*‘012345’*  
 Marigold  
 ABCDEabcde?\*‘012345’  
 NewCenturySchoolbook-Rom  
 ABCDEabcde?\*‘012345’  
 NewCenturySchoolbook-Bd  
**ABCDEabcde?\*‘012345’**  
 NewCenturySchoolbook-It  
*ABCDEabcde?\*‘012345’*  
 NewCenturySchoolbook-BdIt  
**ABCDEabcde?\*‘012345’**  
 Palatino  
 ABCDEabcde?\*‘012345’  
 Palatino-Bd  
**ABCDEabcde?\*‘012345’**  
 Palatino-It  
 ABCDEabcde?\*‘012345’  
 Palatino-BdIt  
**ABCDEabcde?\*‘012345’**  
 Symbol  
 ABXΔEαβχδε?\*012345  
 SymbolPS  
 ABXΔEαβχδε?\*012345  
 TimesNewRoman  
 ABCDEabcde?\*‘012345’  
 TimesNewRoman-Bd  
**ABCDEabcde?\*‘012345’**  
 TimesNewRoman-It  
*ABCDEabcde?\*‘012345’*  
 TimesNewRoman-BdIt  
**ABCDEabcde?\*‘012345’**  
 Times-Rom  
 ABCDEabcde?\*‘012345’  
 Times-Bd  
**ABCDEabcde?\*‘012345’**  
 Times-It  
*ABCDEabcde?\*‘012345’*  
 Times-BdIt  
**ABCDEabcde?\*‘012345’**  
 Univers-Md  
 ABCDE abcde?\*‘012345’  
 Univers-Bd  
**ABCDEabcde?\*‘012345’**  
 Univers-MdIt  
*ABCDEabcde?\*‘012345’*  
 Univers-BdIt  
**ABCDEabcde?\*‘012345’**  
 Univers-MdCd  
 ABCDE abcde?\*‘012345’  
 Univers-BdCd  
**ABCDEabcde?\*‘012345’**  
 Univers-MdCdIt  
*ABCDEabcde?\*‘012345’*  
 Univers-BdCdIt  
**ABCDEabcde?\*‘012345’**  
 Windings  
 ①②③④⑤⑥⑦⑧⑨⑩⑪⑫⑬⑭⑮⑯⑰⑱⑲⑳㉑㉒㉓㉔㉕㉖㉗㉘㉙㉚㉛㉜㉝㉞㉟㊀㊁㊂㊃㊄㊅㊆㊇㊈㊉  
 LinePrinterBM8.5-Roman (Bitmap font)  
**ABCDEabcde?\*‘012345’**

# Appendix A Fonts

## ■ KPDL Fonts (1)

AlbertusMT  
**ABCDEabcde?\*‘012345’**

AlbertusMT-Italic  
*ABCDEabcde?\*‘012345’*

AlbertusMT-Light  
ABCDEabcde?\*‘012345’

AntiqueOlive-Bold  
**ABCDEabcde?\*‘012345’**

AntiqueOlive-Compact  
**ABCDEabcde?\*‘012345’**

AntiqueOlive-Italic  
*ABCDEabcde?\*‘012345’*

AntiqueOlive-Roman  
ABCDEabcde?\*‘012345’

Apple-Chancery  
*ABCDEabcde?\*‘012345’*

Arial-BoldItalicMT  
**ABCDEabcde?\*‘012345’**

Arial-BoldMT  
**ABCDEabcde?\*‘012345’**

Arial-ItalicMT  
*ABCDEabcde?\*‘012345’*

ArialMT  
ABCDEabcde?\*‘012345’

AvantGarde-Book  
ABCDEabcde?\*‘012345’

AvantGarde-BookOblique  
*ABCDEabcde?\*‘012345’*

AvantGarde-Demi  
**ABCDEabcde?\*‘012345’**

AvantGarde-DemiOblique  
*ABCDEabcde?\*‘012345’*

Bodoni  
ABCDEabcde?\*‘012345’

Bodoni-Bold  
**ABCDEabcde?\*‘012345’**

Bodoni-BoldItalic  
*ABCDEabcde?\*‘012345’*

Bodoni-Italic  
*ABCDEabcde?\*‘012345’*

Bodoni-Poster  
**ABCDEabcde?\*‘012345’**

Bodoni-PosterCompressed  
**ABCDEabcde?\*‘012345’**

Bookman-Demi  
**ABCDEabcde?\*‘012345’**

Bookman-Demilight  
*ABCDEabcde?\*‘012345’*

Bookman-Light  
ABCDEabcde?\*‘012345’

Bookman-LightItalic  
*ABCDEabcde?\*‘012345’*

Candide  
\*!@#%&\*‘012345’

Chicago  
**ABCDEabcde?\*‘012345’**

Clarendon  
**ABCDEabcde?\*‘012345’**

Clarendon-Bold  
**ABCDEabcde?\*‘012345’**

Clarendon-Light  
ABCDEabcde?\*‘012345’

CooperBlack  
**ABCDEabcde?\*‘012345’**

CooperBlack-Italic  
*ABCDEabcde?\*‘012345’*

Copperplate-ThirtyThreeBC  
**ABCDEABCDEF?\*‘012345’**

Copperplate-ThirtyTwoBC  
ABCDEABCDEF?\*‘012345’

Coronet-Regular  
*ABCDEabcde?\*‘012345’*

Courier  
ABCDEabcde?\*‘012345’

Courier-Bold  
**ABCDEabcde?\*‘012345’**

Courier-BoldOblique  
**ABCDEabcde?\*‘012345’**

Courier-Oblique  
*ABCDEabcde?\*‘012345’*

Eurostile  
ABCDEabcde?\*‘012345’

Eurostile-Bold  
**ABCDEabcde?\*‘012345’**

Eurostile-BoldExtendedTwo  
**ABCDabcde?\*‘0123’**

Eurostile-ExtendedTwo  
ABCDabcde?\*‘0123’

Geneva  
ABCDEabcde?\*‘012345’

GillSans  
ABCDEabcde?\*‘012345’

GillSans-Bold  
**ABCDEabcde?\*‘012345’**

GillSans-BoldCondensed  
**ABCDEabcde?\*‘012345’**

GillSans-BoldItalic  
*ABCDEabcde?\*‘012345’*

GillSans-Condensed  
ABCDEabcde?\*‘012345’

GillSans-ExtraBold  
**ABCDEabcde?\*‘012345’**

GillSans-Italic  
*ABCDEabcde?\*‘012345’*

GillSans-Light  
ABCDEabcde?\*‘012345’

GillSans-LightItalic  
*ABCDEabcde?\*‘012345’*

Goudy  
ABCDEabcde?\*‘012345’

Goudy-Bold  
**ABCDEabcde?\*‘012345’**

Goudy-BoldItalic  
*ABCDEabcde?\*‘012345’*

Goudy-ExtraBold  
**ABCDEabcde?\*‘012345’**

Goudy-Italic  
*ABCDEabcde?\*‘012345’*

Helvetica  
ABCDEabcde?\*‘012345’

Helvetica-Bold  
**ABCDEabcde?\*‘012345’**

Helvetica-BoldOblique  
*ABCDEabcde?\*‘012345’*

Helvetica-Condensed  
ABCDEabcde?\*‘012345’

Helvetica-Condensed-Bold  
**ABCDEabcde?\*‘012345’**

Helvetica-Condensed-BoldOblique  
*ABCDEabcde?\*‘012345’*

Helvetica-CondensedOblique  
*ABCDEabcde?\*‘012345’*

Helvetica-Narrow  
ABCDEabcde?\*‘012345’

Helvetica-Narrow-Bold  
**ABCDEabcde?\*‘012345’**

Helvetica-Narrow-BoldOblique  
*ABCDEabcde?\*‘012345’*

Helvetica-Narrow-Oblique  
*ABCDEabcde?\*‘012345’*

Helvetica-Oblique  
*ABCDEabcde?\*‘012345’*

HoeflerText-Black  
**ABCDEabcde?\*‘012345’**

HoeflerText-BlackItalic  
*ABCDEabcde?\*‘012345’*

HoeflerText-Italic  
*ABCDEabcde?\*‘012345’*

HoeflerText-Ornaments  

HoeflerText-Regular  
ABCDEabcde?\*‘012345’

## ■ KPDL Fonts (2)

JoannaMT  
 ABCDEabcde?\*‘012345’  
 JoannaMT-Bold  
**ABCDEabcde?\*‘012345’**  
 JoannaMT-BoldItalic  
**ABCDEabcde?\*‘012345’**  
 JoannaMT-Italic  
 ABCDEabcde?\*‘012345’  
 LetterGothic  
 ABCDE abcde?\*‘ 012345’  
 LetterGothic-Bold  
**ABCDE abcde?\*‘ 012345’**  
 LetterGothic-BoldSlanted  
**ABCDEabcde?\*‘ 012345’**  
 LetterGothic-Slanted  
**ABCDE abcde?\*‘ 012345’**  
 LubalinGraph-Book  
 ABCDEabcde?\*‘012345’  
 LubalinGraph-BookOblique  
**ABCDEabcde?\*‘012345’**  
 LubalinGraph-Demi  
**ABCDEabcde?\*‘012345’**  
 LubalinGraph-DemiOblique  
**ABCDEabcde?\*‘ 012345’**  
 Marigold  
 ABCDEabcde?\*‘012345’  
 MonaLisa-Recut  
 ABCDEabcde?\*‘012345’  
 Monaco  
 ABCDE abcde?\*‘ 012345’  
 NewCenturySchlbk-Bold  
**ABCDEabcde?\*‘012345’**  
 NewCenturySchlbk-BoldItalic  
**ABCDEabcde?\*‘012345’**  
 NewCenturySchlbk-Italic  
**ABCDEabcde?\*‘012345’**  
 NewCenturySchlbk-Roman  
 ABCDEabcde?\*‘012345’  
 New York  
 ABCDEabcde?\*‘012345’  
 Optima  
 ABCDE abcde?\*‘012345’  
 Optima-Bold  
**ABCDEabcde?\*‘012345’**  
 Optima-BoldItalic  
**ABCDEabcde?\*‘012345’**  
 Optima-Italic  
**ABCDEabcde?\*‘012345’**  
 Oxford  
 ABCDEabcde?\*‘012345’  
 Palatino-Bold  
**ABCDEabcde?\*‘012345’**  
 Palatino-BoldItalic  
**ABCDEabcde?\*‘012345’**  
 Palatino-Italic  
**ABCDEabcde?\*‘012345’**  
 Palatino-Roman  
 ABCDEabcde?\*‘012345’  
 StempelGaramond-Bold  
**ABCDEabcde?\*‘012345’**  
 StempelGaramond-BoldItalic  
**ABCDEabcde?\*‘012345’**  
 StempelGaramond-Italic  
**ABCDEabcde?\*‘012345’**  
 StempelGaramond-Roman  
 ABCDEabcde?\*‘012345’  
 Symbol  
 ABXΔEαβχδε?\*012345  
 Taffy  
 ABCDE abcde?\*‘012345’  
 Times-Bold  
**ABCDEabcde?\*‘012345’**  
 Times-BoldItalic  
**ABCDEabcde?\*‘012345’**  
 Times-Italic  
**ABCDEabcde?\*‘012345’**

Times-Roman  
 ABCDEabcde?\*‘012345’  
 TimesNewRomanPS-BoldItalicMT  
**ABCDEabcde?\*‘012345’**  
 TimesNewRomanPS-BoldMT  
**ABCDEabcde?\*‘012345’**  
 TimesNewRomanPS-ItalicMT  
**ABCDEabcde?\*‘012345’**  
 TimesNewRomanPSMT  
 ABCDEabcde?\*‘012345’  
 Univers  
 ABCDE abcde?\*‘012345’  
 Univers-Bold  
**ABCDEabcde?\*‘012345’**  
 Univers-BoldExt  
**ABCDE abcde?\*‘012345’**  
 Univers-BoldExtObl  
**ABCDEabcde?\*‘ 012345’**  
 Univers-BoldOblique  
**ABCDEabcde?\*‘012345’**  
 Univers-Condensed  
 ABCDE abcde?\*‘012345’  
 Univers-Condensed-Bold  
**ABCDE abcde?\*‘012345’**  
 Univers-CondensedBoldOblique  
**ABCDEabcde?\*‘012345’**  
 Univers-CondensedOblique  
**ABCDEabcde?\*‘012345’**  
 Univers-Extended  
 ABCDE abcde?\*‘012345’  
 Univers-ExtendedObl  
**ABCDEabcde?\* 012345’**  
 Univers-Light  
 ABCDE abcde?\*‘012345’  
 Univers-LightOblique  
**ABCDEabcde?\* 012345’**  
 Univers-Oblique  
**ABCDEabcde?\*‘012345’**  
 Wingdings-Regular  
 ☺☻☼☽☾☿ⓂⓃⓄⓅⓆⓇⓈⓉ  
 ZapfChancery-MediumItalic  
**ABCDEabcde?\*‘012345’**  
 ZapfDingbats  
 ✪✫✬✭✮✯✰✱✲✳✴✵✶✷✸✹✺✻✼✽✾✿

# Appendix B      Expansion Memory

This appendix first explains how to remove the main circuit board and then how to install a DIMM (Dual In-line Memory Module) on the main circuit board.

Expanded printer memory enables you to print more complex pages, download more fonts, and define more macros.

## 1. Removing the Main Circuit Board

The main circuit board of the printer is equipped with two sockets for memory expansion. Expansion memory is available in the form of DIMMs.

### NOTE

The expansion memory should be installed only by a Kyocera Mita authorized dealer or Kyocera Mita certified technician. Kyocera Mita shall not be liable for damage due to improper installation of the expansion memory.

The following instructions are intended for the technician only.

### 1.1 Notes on Handling the Main Circuit Board and DIMM

Protect the electronics by taking these precautions:

- Before touching the main circuit board and DIMM, touch a water pipe or other large metal object to discharge yourself of static electricity. While doing the work, it is recommended that you wear an antistatic wrist strap.
- Touch the main circuit board and DIMM only at the edges.



## 1.2 Removing the Main Circuit Board from the Printer

Remove the main circuit board completely from the printer as follows:

- 1 Turn off the printer and disconnect the power cord and printer cable.
- 2 Remove the two screws from the printer.

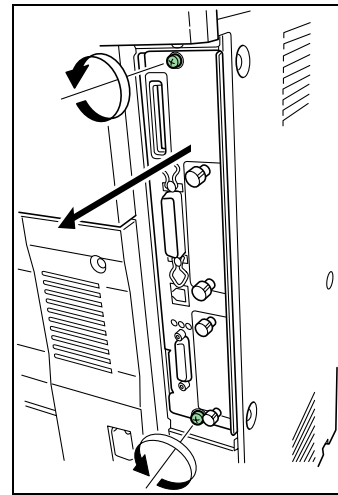

- 3 Pull the main circuit board all the way out of the printer.

### NOTE

Before pulling the main circuit board out, clear away the area, behind the printer. Foreign objects, accidentally sticking to the back of the main circuit board, can cause serious damage to the printer.

## 2. Installing DIMMs

### ■ DIMMs to be used

See your Kyocera Mita dealer for purchasing information of the DIMMs that are best suited for use with this printer. 16 MB, 32 MB, 64 MB, and 128 MB DIMMs can be used for memory expansion.

Insert the DIMM into the socket as shown below.

- 1** Remove the DIMM from its package.
- 2** Open the clips on both ends of the DIMM socket.
- 3** Insert the DIMM into the socket, so that the notches on the DIMM align with the corresponding protrusions in the socket.

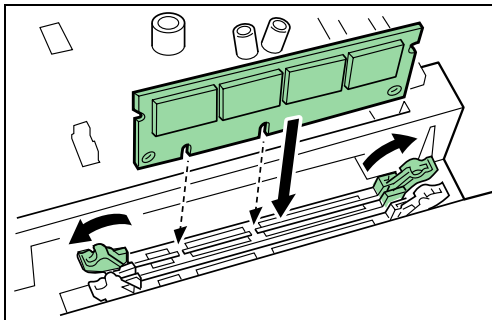

- 4** Close the clips of the DIMM socket to secure the DIMM.

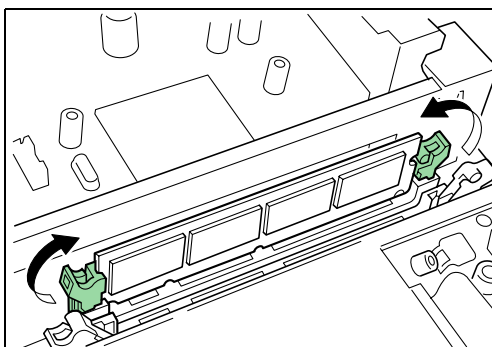

- 5** When you finish installing the DIMM, reinsert the main circuit board into the printer by reversing the removal procedure.

## 2.1 Removing DIMM

To remove a DIMM, carefully pull the end clips outwards, then pull the DIMM out of the socket.

Return the main circuit board to the printer by reversing the procedure explained in [Removing the Main Circuit Board from the Printer on page B-1](#).

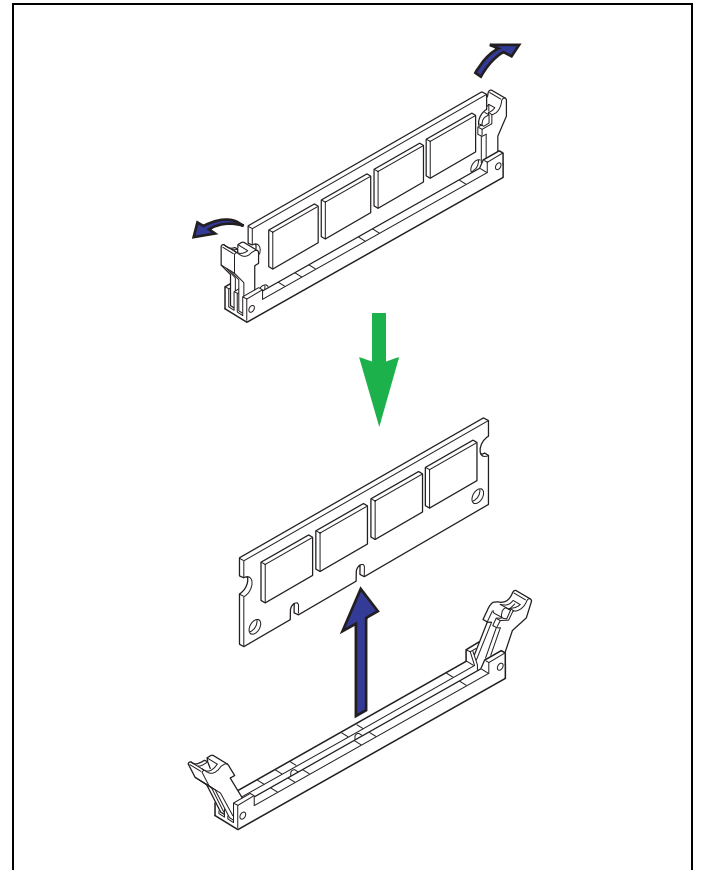

## 2.2 Testing the Expansion Memory

After you finish installing DIMMs in the printer, test the printer to see if the installation was successful. To test the expansion memory, proceed as follows:

- 1** Make sure the printer is turned off. Plug the power cord into the printer and turn the printer on.
- 2** Press the **MENU** key on the operator panel.
- 3** Press the  $\Delta$  or  $\nabla$  key repeatedly until `Print Status Page` appears.
- 4** Press the **ENTER** key twice.
- 5** If the installation was successful, the amount of memory shown on the status page will correspond with the amount of expanded memory. (The factory installed memory size is 32 MB.)



# Appendix C Host Computer Interface

This appendix explains the signals used in the printer's parallel and RS-232C interfaces. It also lists pin assignments, signal functions, timings, connector specifications, and voltage levels. The RS-232C protocols are also covered. Finally, it explains how to use the printer in a multi-computer environment.

This appendix explains the following topics:

- Parallel Interface
- Serial Interface
- RS-232C Protocol
- RS-232C Cable Connection

## 1. Parallel Interface

### 1.1 Parallel Interface Communication Modes

The printer features fast data transmission with the parallel interface. The parallel interface mode can be activated from the operator panel.

See [Changing Parallel Interface Modes on page 3-18](#).

#### NOTE

Use a parallel printer cable that complies with the IEEE1284 standard.

#### Nibble (high) [default]

High speed data communication is used in compliance with the IEEE1284 standard. Ordinarily, you should leave this setting unchanged.

#### Auto

The printer automatically changes its communication mode to the one the host computer is currently using.

#### Normal

The printer uses the standard communication method prescribed for Centronics interfaces.

#### High-speed

This mode enables faster data transmission between the printer and the host computer. (Select this mode if printing problems occur when the printer is connected to a workstation.)

### 1.2 Interface Signals

The pins of the parallel interface connector carry the signals listed in the table in [Parallel Connector Pin Assignment](#). Asterisks

in the table indicate signals that are low active. The table also indicates whether each signal is incoming or outgoing with respect to the printer.

#### Parallel Connector Pin Assignment

Pin	In/out	Description
1	In	Strobe* [nStrobe]
2	In/Out	Data 0 [Data 1]
3	In/Out	Data 1 [Data 2]
4	In/Out	Data 2 [Data 3]
5	In/Out	Data 3 [Data 4]
6	In/Out	Data 4 [Data 5]
7	In/Out	Data 5 [Data 6]
8	In/Out	Data 6 [Data 7]
9	In/Out	Data 7 [Data 8]
10	Out	Acknowledge* [nAck]
11	Out	Busy [Busy]
12	Out	Paper Empty [PError], returns paper empty status if FRPO O2=2
13	Out	Online (Select) [nSelect], returns off-line status if FRPO O2=2
14	In	Auto-feed [nAutoFd]
15	-	Not connected
16	-	0 V DC
17	-	Chassis GND
18	-	+5 V DC
19	-	Ground
20	-	Ground
21	-	Ground
22	-	Ground
23	-	Ground
24	-	Ground
25	-	Ground
26	-	Ground
27	-	Ground
28	-	Ground
29	-	Ground
30	-	Ground
31	In	Ignored [nInit]
32	Out	Error*, returns error status if FRPO O2=2 [nFault]
33	-	Not connected
34	-	Not connected
35	Out	Power Ready
36	In	Ignored [nSelectIn]

[ \* ]: Signal names in the Auto mode and Nibble (high) mode (IEEE1284). In the Auto mode and Nibble (high) mode, these signals are bi-directional.

Detailed descriptions of the signals follow.

**Strobe\* [nStrobe] (Pin 1)**

A negative-going Strobe\* pulse causes the printer to read and latch the data on the Data 0 [1] to Data 7 [8] signal lines.

**Data 0 [1] to Data 7 [8] (Pins 2 to 9)**

These eight signals form the data byte sent from the host computer to the printer. Data 7 [8] is the most significant bit.

**Acknowledge\* [nAck] (Pin 10)**

This negative-going pulse acknowledges the previous character received by the printer.

**Busy [Busy] (Pin 11)**

This signal is high when the printer is busy and low when it is able to accept more data.

**Paper Empty [PError] (Pin 12)**

This signal goes high when the printer has received a print job and run out of paper.

**Online [Select] (Pin 13)**

This signal is high when the printer is online and low when the printer is offline. It goes low when the **GO** key is pressed to set the printer offline.

**+5 V DC (Pin 18)**

This line is connected to the printer's +5 V DC line (+5 V ±0.5 V, maximum 400 mA [Serial and Parallel total], fused).

**Error\* [nFault] (Pin 32)**

When the high-speed parallel line control is on (FRPO O2=2), this line returns error status.

**Power Ready (Pin 35)**

This signal is high when the printer is turned on.

**NOTE**

The Paper Empty, Online, and Error signals are not used unless enabled by the FRPO command (O2 parameter).

**2. Serial Interface**

**2.1 Interface Signals**

The pins of the printer's RS-232C interface connector carry the signals listed in the table below. The table also indicates whether each signal is incoming or outgoing with respect to the printer.

**RS-232C Signal Pin Assignment**

Pin	In/out	Signal	Description
1	-	FG	Frame ground
2	Out	TXD	Transmit Data
3	In	RXD	Receive Data
4	Out	RTS	Request To Send
5	In	CTS	Clear To Send
6	In	DSR	Data Set Ready
7	-	SG	Signal Ground
11	-	+5 V DC	Reserved
20	Out	DTR	Data Terminal Ready

Brief descriptions of the signals follow.

**FG - Frame Ground - (Pin 1)**

This pin is connected directly to the printer frame.

**TXD - Transmit Data - (Pin 2)**

This output carries asynchronous data sent by the printer to the computer. It is used mainly in handshaking protocols.

**RXD - Receive Data - (Pin 3)**

This input carries serial asynchronous data sent by the computer to the printer.

**RTS - Request To Send - (Pin 4)**

This output is always held high (above 3 volts).

**CTS - Clear To Send - (Pin 5)**

**DSR - Data Set Ready - (Pin 6)**

Unused.

**SG - Signal Ground - (Pin 7)**

All signals can transmit between the printer and the host computer to send each signal with a signal ground.

**+5 V DC - (Pin 11)**

This line is connected to the printer's +5 V DC line (+5 V ±0.5 V, maximum 250 mA, fused).

**DTR - Data Terminal Ready - (Pin 20)**

This output is used as a buffer nearly-full handshake line. It is held high (above 3 volts) when the buffer can accept more data.

**■ RS-232C Interface Voltage Levels**

The voltage levels of the interface signals conform to EIA RS-232C specifications. SPACE is from 3 volts to 15 volts. MARK is from -3 volts to -15 volts. Voltages between -3 volts and 3 volts are undefined.

**■ SERIAL Connector**

The connector marked **IOIOI** (RS-232C) on the rear panel is a DB-25S connector. Use a DB-25P connector (or equivalent) for the connector on the cable.



### 3. RS-232C Protocol

A protocol is a set of rules the computer follows in sending data to the printer. They are indicated on the status page. Parameters can be changed from the operator panel. See *Changing Serial Interface Modes on page 3-19*. The parameters and their identification codes are given below.

**H1: Baud rate**

Parameter value	Baud rate
12	1200
24	2400
48	4800
96	9600
19	19200
38	38400
57	57600
11	115200

The factory default setting is 9600 baud.

**NOTE**

Some computers may not be compatible with a baud rate of 115200 bps. If you set the baud rate to 115200 and communication problems occur, lower the baud rate.

**H2: Data bits**

7 or 8; the factory default setting is 8.

**H3: Stop bits**

1 or 2; the factory default setting is 1.

**H4: Parity**

Parameter value	Meaning
0	None
1	Odd
2	Even
3	Ignore

The factory default setting is None (0 on the status printout).

**H5: Protocol logic**

Parameter value	Meaning
0	Combination of 1 and 3 below
1	DTR, positive logic
2	DTR, negative logic
3	XON/XOFF
4	ETX/ACK
5	XON/XOFF recognized only as protocol

The factory default setting is 0.

**H6: Buffer nearly-full threshold**

This is a percentage from 0 to 99. The factory default setting is 90.

**H7: Buffer nearly-empty threshold**

This is a percentage from 0 to 99. The factory setting is 70. The factory default settings of the buffer nearly-full and nearly-empty thresholds (H6 and H7) are subject to change without notification.

The gap between the nearly-full and nearly-empty thresholds allows the computer to send a fairly large amount of data in a continuous stream.

**H8: Received-data buffer size**

This is the size of the input buffer, specified in units of 10 Kbytes. The factory default setting is 6, meaning 60 Kbytes.

**PRESCRIBE FRPO D0 command**

The PRESCRIBE FRPO D0 command is provided to allow manipulating XON/XOFF when an error has occurred on the serial interface. The following table summarizes the error status corresponding to different D0 values.

Timing of XON transfer to host while Ready or Waiting	Serial interface error	
	Error not handled	Error handled
XON sent every 3 to 5 seconds	D0=0 (default)	D0=1
XON not sent	D0=10	D0=11

## 4. RS-232C Cable Connection

### 4.1 Preparing an RS-232C Cable

After obtaining an RS-232C cable, check that it is wired correctly, referring to the table in [RS-232C Signal Pin Assignment on page C-2](#). If you have an IBM communication adapter cable type 1502067, you will have to resolder the wiring at the printer end of the cable. The procedure is as follows.

- 1 Remove the plastic cover from the printer end of the cable.
- 2 Next to each of the wires inside the cable is a bare shield wire. Solder all these shield wires together into a single bundle.
- 3 Using a section of flat wire about 3 mm wide and 15 mm long, connect the bundle of shield wires to the metal facing of the connector. Check that the solder connections are secure.
- 4 Desolder wires 2 and 3, then resolder them in crossed configuration. Solder wire 2 to pin 3 and wire 3 to pin 2. Cover the solder joints with thermofit tube.
- 5 Cut wires 4, 5, 6, and 20.
- 6 Solder wires 5 and 6 together and connect them to pin 20. Cover the solder joints with a thermofit tube. Leave wire 4 unconnected.
- 7 Tape all remaining loose ends, or seal them with a thermofit tube.
- 8 Attach the plastic cover back on.

### 4.2 Connecting the RS-232C Cable

Check that the power of both the printer and the computer is switched off.

- 1 Discharge yourself of static electricity by touching a metal object such as a doorknob.
- 2 Plug the printer end of the RS-232C interface cable into the printer's RS-232C connector and attach it in place.
- 3 Plug the other end of the cable into the computer's RS-232C interface connector.
- 4 Turn on the printer.

- 5 The printer RS-232C parameters are factory-set to the following values:

Baud rate=9600 bps, data bits (character length)=8 bits, stop bits=1, parity=none

The two RS-232C protocols are XON/XOFF and DTR. The printer performs both of them simultaneously, using positive logic for DTR.

If you are uncertain as to the printer's current parameter settings, you can reset them to the values listed above by following the procedure explained in [Printer Resetting on page 3-49](#).

- 6 Set the computer to the same parameters as the printer. On many computers this can be done by setting DIP switches before the power is turned on. Another method is as follows:

### 4.3 Setting the RS-232C Parameters

#### ■ Windows 95/98/ME

- 1 Click on the **Start** button in the Windows 95/98/ME task bar and align the cursor with **Settings**, then click on **Control Panel** from among the items displayed.
- 2 The control panel folder opens. Double click on **System**.
- 3 **System Properties** opens. Click on the **Device Manager** tab, then click on the **COM** port to be used.

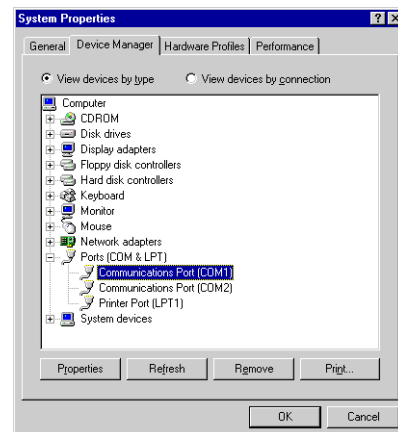

- 4 Click on the **Properties** button.

## Appendix C Host Computer Interface

---

- 5 The Properties sheet is displayed for the selected COM port. Click on the **Port Settings** tab and set the port properties.

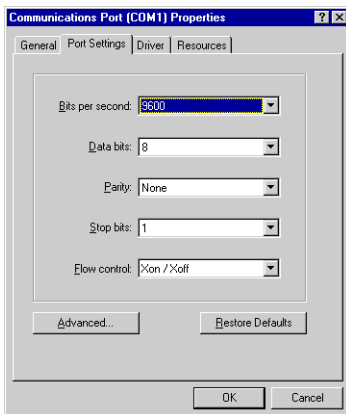

- 6 After setting the properties, click the **OK** button.

### ■ DOS

- 1 Enter the following commands:

```
C:\>MODE COM1:96,N,8,1,P  
C:\>MODE LPT1:=COM1
```

- 2 To test the interface, enter the following:

```
CTRL P  
C:\>DIR  
CTRL P
```

The software settings made using the above procedures are temporary. On most computers, permanent settings must be made with DIP switches.

If you want to use a different baud rate or change any of the other RS-232C parameters, this can be accomplished from the printer's operator panel. See [Changing the Interface Parameters on page 3-18](#).

# Appendix D Option Units

This appendix explains how to install each option unit. Also refer to the manuals of the respective option units.

## 1. Available Options

The printer has the following options available. For instructions on installing individual options, refer to the documentation included with the option.

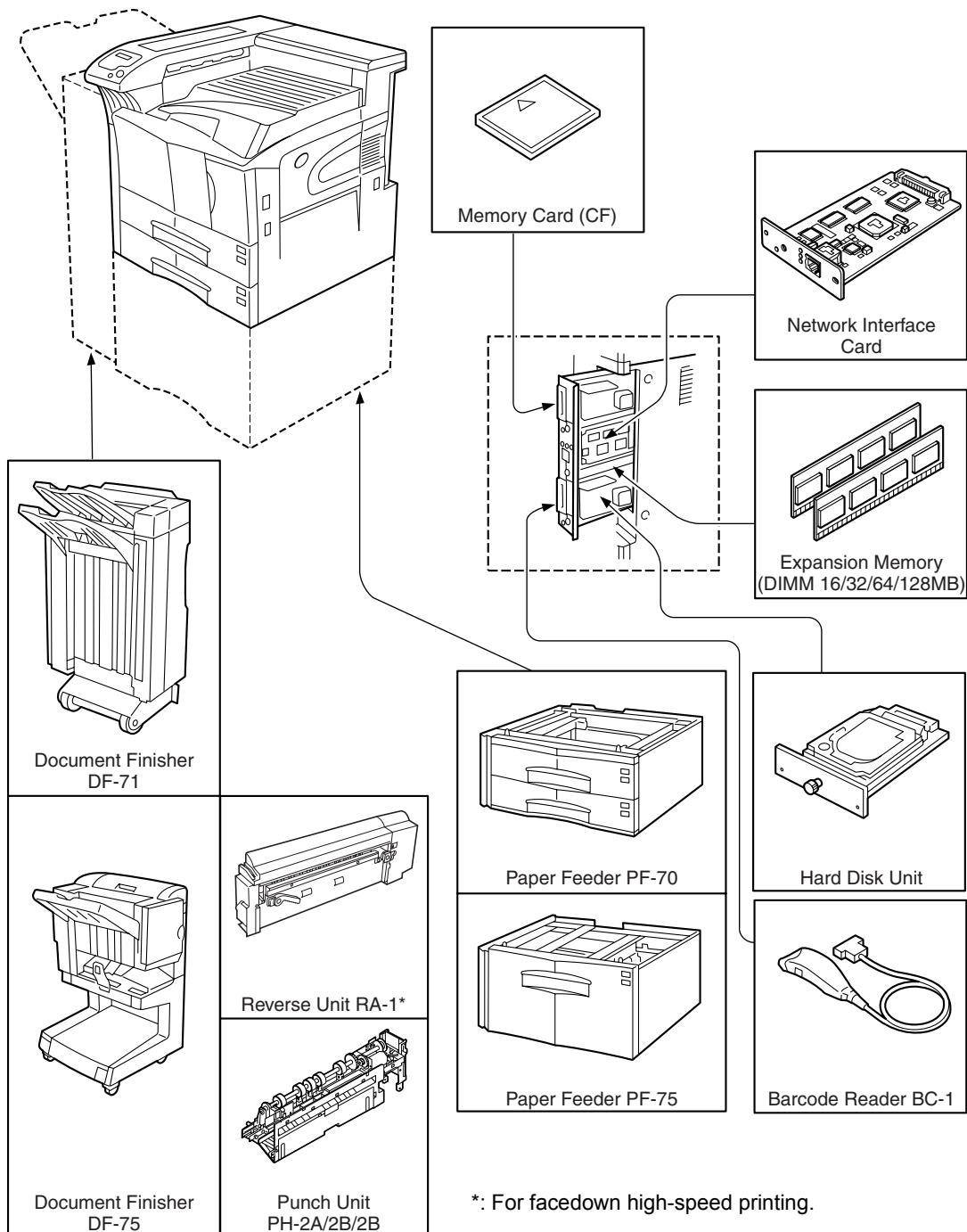

## Appendix D Option Units

---

### **PF-70 Paper Feeder**

Holds approximately 500 sheets of A5 to A3 (11 × 17" in Ledger) size paper. Only one paper feeder can be attached to the bottom of the printer.

### **PF-75 Paper Feeder**

Holds approximately 3000 sheets of A4, B5 or Letter size (8.5 × 11") paper. Only one paper feeder can be attached to the bottom of the printer.

### **Network Interface Card**

Is used to communicate using the network protocols such as NetWare, TCP/IP or EtherTalk.

### **DF-70/DF-71 Document Finishers**

Provide finishing with about 3,000 sheets at a time with high-speed and large-capacity processes. DF-71 also provides a punch function. They are installed at the left side of the printer.

### **DF-75 Document Finisher**

Provides the staple, punch (option), offset and stitch functions. It is installed at the left side of the printer.

### **BC-1 Barcode Reader**

Reads the barcode (ID code) printed on the paper when reprinting with the code job function. It is connected to the printer with the serial interface.

### **Other Options**

#### **• Hard Disk Unit**

Enables the electronic sorting and job retention functions. To be inserted into the slot OPT1/HDD designed for it on the main circuit board of the printer.

#### **• Memory Card (CF)**

This is a microchip card that may contain option fonts, macros, and forms. Insert the memory card into the memory card slot located on the right of the printer. See your dealer for purchasing information regarding the memory Cards that are best suited for use with this printer.

#### **• Memory DIMM**

See your dealer for purchasing information of the DIMM that are best suited for use with this printer. See [Appendix B Expansion Memory](#) for the installation procedure.

## 2. Installing Option Units

### 2.1 PF-70/75 Paper Feeders

PF-70 or PF-75 Paper Feeder can be installed below the printer.

PF-70 Paper Feeder holds approximately 500 sheets of A4 to A3 (11 × 17" in Ledger) size paper.



PF-75 Paper Feeder holds approximately 3000 sheets of A4, B5 or Letter size (8.5 × 11") paper.

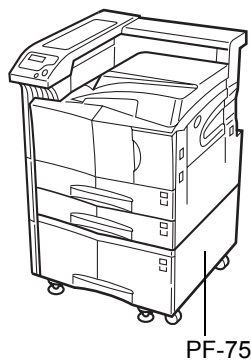

For details of installing the optional paper feeder in the printer, see the [PF-70/75 Installation Guide](#).

### 2.2 DF-70/71/75 Document Finishers

DF-70/71/75 Document Finisher can be installed to the printer.

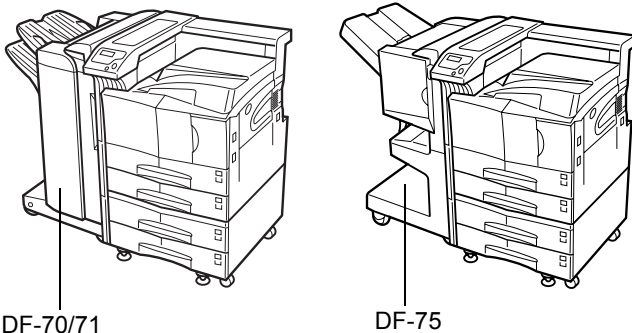

For details of installing the optional finisher in the printer, see the [DF-70/71/75 Installation Guide](#).

### 2.3 Network Interface

The FS-9100DN/FS-9500DN have the standard Network interface. This printer supports the TCP/IP, IPX/SPX, NetBEUI, and EtherTalk protocols, so the network printing under various platforms such as Windows, Macintosh, UNIX, and NetWare is available.

An option network interface card can be added by the following procedure.

- 1** Turn off the printer and disconnect the power cord and printer cable.
- 2** Remove the two screws from the option interface slot cover (OPT2).

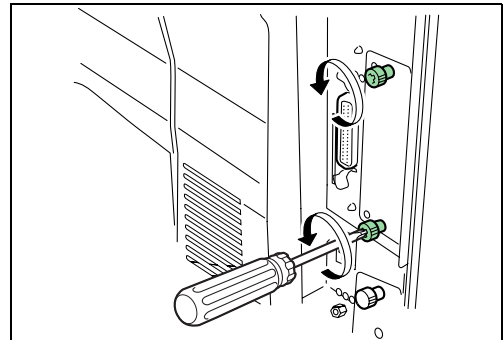

- 3** Insert the network interface card and secure it with the screws removed in step 2.

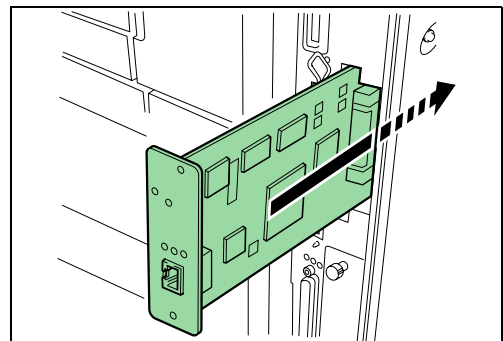

- 4** Connect the network cable.

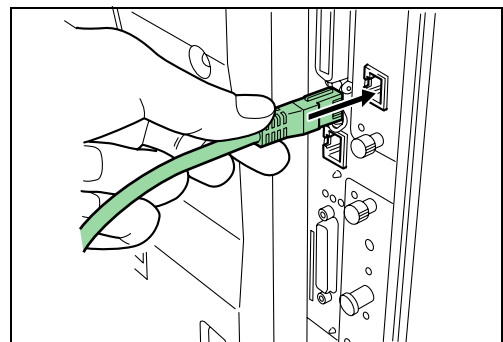

- 5** Set the network address from the printer operator panel (for details about the modes, see [Changing Network Interface Parameters on page 3-20](#)).

### 2.4 Hard Disk

Insert the hard disk into its slot on the main circuit board of the printer. If a hard disk unit is installed in the printer, received data can be rasterized and stored on this hard disk. This enables high-speed printing of multiple copies using an electric sort function. Also, you can use the e-MPS functions. For details, see [e-MPS on page 3-11](#).

For details of available hard disks, see your dealer.

**1** Turn off the printer and disconnect the power cord and printer cable.

**2** Remove the two screws and remove the slot cover (OPT1/HDD).



**3** Insert the optional hard disk unit into the slot.

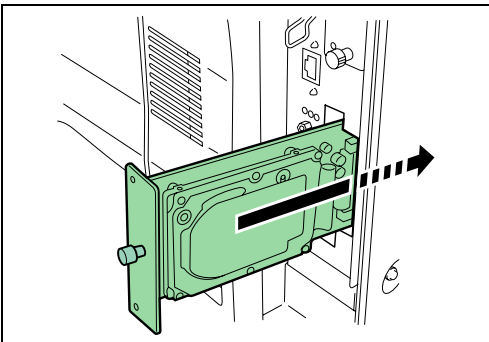

**4** Tighten the two screws to secure the hard disk unit to the main circuit board.

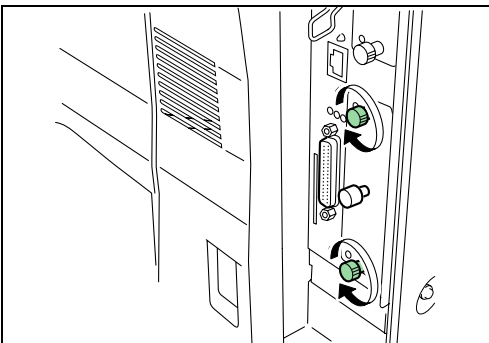

### 2.5 Memory Card

Insert the memory card into the memory card slot located the right side of the printer. A memory card is a microchip card that may contain option fonts, macros, forms, etc. The printer reads the contents of the card into its internal memory when printer is turned on.

For details of available memory cards, see your dealer.

**1** Turn off the printer.

#### NOTE

Do not insert or remove a memory card while the power is on. If the memory card is removed while the printer is on, damage could result in the printer's electronics or the memory card.

**2** Insert the memory card in the slot. Insert it with its label surface facing toward the outside, connector end first. Push it in all the way.

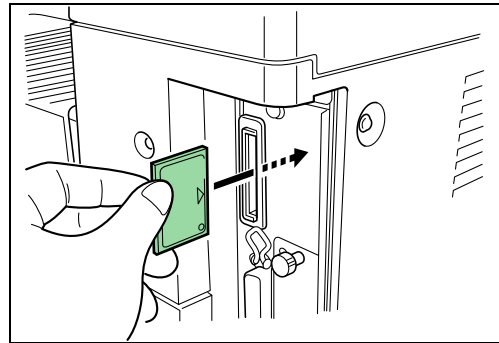

# Appendix E Specifications

## Specifications

### Specifications

Item	Description	
	FS-9100DN	FS-9500DN
Printing method	Electrophotography, laser scan	
Printing speed ( ): MP tray	A4/Letter : 36 (27) pages/minutes B4 : 20 (19) pages/minutes A3 : 19 (17) pages/minutes	A4/Letter : 50 (30) pages/minutes B4 : 26 (23) pages/minutes A3 : 26 (20) pages/minutes
Resolution	Fast 1200 mode 600 dpi with KIR (Kyocera Image Refinement) 300 dpi with KIR (Kyocera Image Refinement)	
First print (A4 or Letter size, depending on input data)	Approx. 7 seconds or less (During printing) Approx. 40 seconds (During low power mode) Approx. 67 seconds (During sleep mode)	Approx. 5 seconds or less (During printing) Approx. 95 seconds (During low power mode) Approx. 135 seconds (During sleep mode)
Warm-up time	Approx. 60 seconds or less (from power on/sleep mode) at 23 °C, 120 or 230 V	Approx. 130 seconds or less (from power on/sleep mode) at 23 °C, 120 or 230 V
Controller	PowerPC 750 CX (350 MHz)	PowerPC 750 CX (400 MHz)
Main memory	32 MB, expandable up to 288 MB	
Operating system	Windows 95/98/ME, Windows NT/2000, Macintosh, Linux	
Interfaces	Parallel 1, IEEE1284 Serial 1, RS-232C Network 1, Protocol support:IPX/SPX, TCP/IP, DLC Option 2, Network interface card and hard disk (KUIO-LV)	
Memory card slot	One Memory card (CF)	
Self test	Performed at power-up	
Maximum duty cycle	180,000 pages/month	300,000 pages/month
Drum	Amorphous silicon drum	
Developer	Mono-component dry developer	
Main charger	Positive scorotron charger	
Transferring	Negative charger roller	
Separation	DC brush separation	
Drum cleaning	Blade cleaner	
Drum discharging	Illumination by eraser LED array	
Fuser	Heat roller and pressure roller	
Toner saving	EcoPrint mode	
Paper	Plain paper (See <a href="#">Chapter 5 Paper Selection</a> )	



## Appendix E Specifications

Item	Description	
	FS-9100DN	FS-9500DN
Paper feed trays	Cassette : A5 to A3/Ledger size universal cassette. Holds 500 sheets of thickness 0.11 mm MP tray : 88 × 148 mm (3-1/2 × 5-13/16") to 297 × 450 mm (11-11/16 × 17-3/4") (See <a href="#">page 5-2</a> ). Holds 200 sheets of thickness 0.11 mm	
Capacity of output tray	Face-down tray – 500 sheets of thickness 0.11 mm	
Ambient conditions	Temperature : 10 to 32.5 °C (50 to 90.5 °F) Humidity : 20 to 80 % RM Optimum conditions : 23 °C (73.4 °F), 60 % RM Altitude : Max. 2,000 m (6500 feet) Illumination : Max. 1,500 lux	
Power requirements	120 V, 60 Hz, max. 10.8 A (U.S.A./Canada) 220-240 V, 50 Hz/60 Hz, max. 5.6 A (European countries) Max. allowable voltage fluctuation: ±10 % Max. allowable frequency fluctuation: ±2 %	120 V, 60 Hz, max. 10.9 A (U.S.A./Canada) 220-240 V, 50 Hz/60 Hz, max. 5.7 A (European countries) Max. allowable voltage fluctuation: ±10 % Max. allowable frequency fluctuation: ±2 %
Power consumption	Max.: 1,400 W During printing: 680 W During standby: 140 W During low power mode: 99 W During sleep mode: 16 W	Max.: 1,400 W During printing: 790 W During standby: 150 W During low power mode: 70 W During sleep mode: 16 W
Operating noise (in accordance with ISO 7779 [Bystander Position, sound pressure level at the front])	During printing: LpA=54 dB(A) During standby: LpA=31 dB(A) During sleep mode: Immeasurably low	During printing: LpA=55 dB During standby: LpA=31 dB During sleep mode: Immeasurably low
Dimensions	585 (23) wide × 615 (24-1/2) high × 639 mm (25-1/8") deep	
Weight	67 kg (148 lb), main unit only	

# Glossary

## **Cassette mode**

This is an operation mode for the MP tray. When this mode is used, approximately 200 sheets of plain paper can be fed continuously, the same as for the cassette. Cassette mode is specified as the factory setting, but you can change this setting from the printer's operator panel.

## **dpi (dots per inch)**

This indicates the number of dots printed per inch, and is the unit of printer resolution.

## **EcoPrint**

This is a printing mode that controls toner consumption. Pages printed in the Ecoprint mode are lighter than pages printed in the normal mode. The default setting is Off.

## **Emulation**

This refers to emulation of manufacturers' printers. The printer emulates the operation of the following printers: PCL 6, KC-GL, Line printer, IBM Proprinter, DIABLO 630, EPSON LQ-850, and KPD.L.

## **Expansion memory**

This option is used to increase printer memory. The printer has two expansion sockets, into both of which you can install a 16 MB, 32 MB, 64 MB, or 128 MB DIMM (Dual Inline Memory Module). See your Kyocera Mita dealer to purchase the DIMM that is best suited for use with this printer.

## **First mode**

This is an operation mode for the MP tray. If there is paper inserted in the MP tray, the first paper will always feed from there even if another paper source is selected.

## **IEEE1284**

This is a standard used when connecting a printer to a computer, and was established by the Institute of Electrical and Electronic Engineers in 1994.

## **KIR (Kyocera Image Refinement)**

This is Kyocera Mita's original smoothing function. It uses software to enhance the printer's resolution and produce high-quality printing. The default setting is On.

## **Kyocera Mita Digital Library**

This is contained on the CD-ROM supplied with the printer. The contents of the CD-ROM include manuals, printer drivers, and various utilities.

## **KM-NET VIEWER**

This is a network management tool that can be used with the Kyocera Mita FS series. You can view information for printers connected to the network using SNMP commands. KM-NET VIEWER is contained on the Kyocera Mita Digital Library CD-ROM supplied with the printer.

## **MB (mega byte)**

This unit is used to express data quantities and memory capacities. 1 MB is equivalent to 1024 kB, or 1,048,576 bytes.

## **MP tray**

This is an abbreviation for Multi-Purpose tray. The MP tray is used instead of the cassette when printing on envelopes, postcards, transparency sheets, and labels.

## **Offline**

The printer can receive data, but cannot print. Turn the printer online if you want to print.

## **Online**

The printer can output received data.

## **Operator panel**

This is located on the top of the printer. The panel consists of the message display, three indicators and eight keys. The message display shows the printer's status. Press the keys when you want to switch the printer between online and offline status, or to cancel printing.

## **Outline font**

With outline fonts, characters' outlines are represented by numerical expressions, and fonts can be enlarged, reduced, or painted in different ways by changing the numeric values of those expressions. Printing remains clear even if you enlarge fonts, since the letters are defined by an outline. You can specify font size in steps of 0.25 points up to 999.75 points.

## **Parallel Interface**

With this interface, data transfer between the printer and the computer takes place on 8-bit chunks. The printer can perform IEEE1284 compatible bi-directional communications.

## Glossary

---

### **Printer driver**

The printer driver makes it possible for you to print data created using application software. The printer driver for the printer is on the Kyocera Mita Digital Library CD-ROM supplied with the printer. Install the printer driver on the computer connected to the printer.

### **RAM disk**

This is a virtual disk drive that uses part of the printer's memory. With RAM disk you can set any memory size arbitrarily, and use electronic sorting (to reduce print time).

### **Simple Network Management Protocol (SNMP)**

This is a protocol for the management of networks that use TCP/IP (Transmission Control Protocol/Internet Protocol).

### **Sleep mode**

This mode is activated after a specified amount of time elapses. The printer goes into economy mode and a minimum amount of power is consumed. You can change the amount of time before the printer goes into sleep mode from the printer's operator panel. The default setting is 30 minutes.

### **Status page**

This lists printer conditions, such as the printer's memory, the total number of copies printed, and paper source settings.

# Index

- A**
  - Access code 3-13, 3-14
  - Adhesive label 5-4
  - Alarm (buzzer) setting 3-50
  - Amorphous silicon drum E-1
  - Auto continue 3-51
  - Automatic manual feeding 3-40
- B**
  - Barcode reader 3-19, D-1, D-2
  - Binding 3-43
- C**
  - Cassette paper size 3-41
  - Charger unit 1-2, 4-2, 6-3
  - Cleaning brush 1-2, 6-4
  - Cleaning knob 1-2, 6-3
  - Code job 3-12, 3-15
    - Permanent code jobs 3-17
    - Temporary code jobs 3-17
- D**
  - DIMM B-1
  - Document finisher 3-44, D-1, D-3
  - Drum 4-2, 4-3
    - Refresh drum 4-2, 4-3
  - Duplex 3-43, 3-46, 5-5
    - Binding 3-43
- E**
  - EcoPrint 3-30, 1-1
  - e-MPS 3-11, 3-16
    - Code jobs 3-15
    - Private job 3-13
    - Proof-and-hold 3-13
    - Quick copy 3-12
    - Stored job 3-14
    - Virtual mailbox 3-15
  - Emulation 3-22, 1-1
  - Envelopes 2-3, 5-4
  - Error messages 4-6
  - Expansion memory B-1, 1-1
- F**
  - Face-down tray 1-2, 3-44
  - Font 3-24, A-1
  - Font list 3-26, A-1
  - Front cover 1-2
- G**
  - Grid cleaner 6-1, 6-3
- H**
  - Handles for transport 1-2
  - Hard disk 3-31, D-4
- I**
  - Indicators 3-2, 3-3, 4-4
  - Interface 3-2, 3-18, C-1
  - Internal fonts 3-24, A-1
- J**
  - Job retention 3-11
  - Job storage 3-12
- K**
  - Keys 3-1, 3-3
  - KIR 3-30, 1-1
  - KM-NET VIEWER 1-1
  - KPDL 3-22, A-3
  - Kyocera Mita Digital Library 1-1
- L**
  - Left cover 1 1-2, 4-10
  - Lock lever 1-2, 4-11, 6-4
- M**
  - Main charger unit 1-2, 4-2
  - Main circuit board B-1, D-4
  - Main switch 1-2
  - Maintenance 6-1
    - Charger wire 4-2, 4-3
    - Grid cleaner 6-3
    - Separator 6-4
  - Maintenance messages 4-4

## Index

---

Memory card 3-36, D-4  
Memory expansion B-1  
Menu map 3-10  
Menu selection system 3-4, 3-10  
Message display 3-1, 3-2  
Message language 3-47  
MP (multi-purpose) tray 1-2, 2-2, 4-9, 5-2, 5-5  
    Cassette mode 3-40, 1-1  
    First mode 3-40, 1-1  
    Paper guide 2-1  
MP transport 4-8

## N

Network 3-11, D-3  
Network interface 1-2, 3-2, 3-20, D-3

## O

Online help messages 3-3, 4-5, 4-8  
Operator panel 1-2, 3-1, 3-4, 1-1  
Operator panel indicators 4-4  
Option units D-1, D-3  
Orientation 3-28, 3-43

## P

Paper cassette 1-2, 2-1, 4-9  
Paper feeder 4-8, D-2, D-3  
Paper grain 5-3  
Paper size 3-3, 3-41, 5-2  
Paper size indicator 3-1, 3-3  
Paper size plate 2-2  
Paper specifications 5-1  
Paper stopper 1-2, 2-1  
Paper type 3-3, 3-45, 5-5  
Paper type indicator 3-1, 3-3  
Paper weight 3-46, 5-2  
Parallel interface 3-18, C-1, 1-1  
Partition 3-32, 3-33, 3-35, 3-38, 3-39  
PCL fonts A-1  
Plastic bag 6-1, 6-2  
Preprinted paper 5-3, 5-4  
PRESCRIBE 4-3, C-3  
Print density 3-31, 4-3  
Print quality 3-30, 4-2  
Printer driver 3-11, 1-2  
Protocol 3-19, C-1, C-3  
Punch unit 4-4, D-1

## R

RAM disk 3-34, 4-7, 1-2  
Recycled paper 5-4

## Index-2

Reduced print 3-27  
Resolution 3-31, E-1  
Resource protection 3-50  
RS-232C 3-2, C-2, C-3, C-4  
RS-232C Cable C-4

## S

Separator 6-4  
Serial interface 3-2, 3-19, C-2  
Service status page 3-52  
Simple Network Management Protocol (SNMP)  
1-2  
Sleep mode 3-2, 3-49, 1-2  
Sleep timer 3-2, 3-48, 3-49  
Special paper 2-2, 5-3  
Specifications 5-1, E-1  
Status page 3-10, 3-21, 3-52, 1-2  
Stitch position 3-44

## T

TK-70 4-2, 4-3, 4-6, 6-1  
Toner container 1-2, 3-11, 6-1  
Toner kit 6-1  
Transfer roller 4-3  
Troubleshooting 4-1  
    Interface 4-1

## V

Virtual mailbox (VMB) 3-12, 3-15, 3-18

## W

Waste toner box 1-2, 6-1  
Wiper cloth 6-1

# **Kyocera Mita Corporation**

2-28, 1-Chome, Tamatsukuri, Chuo-ku  
Osaka 540-8585, Japan  
Phone: (06) 6764-3555



# Printer Driver Guide

for FS-9100DN

FS-9500DN

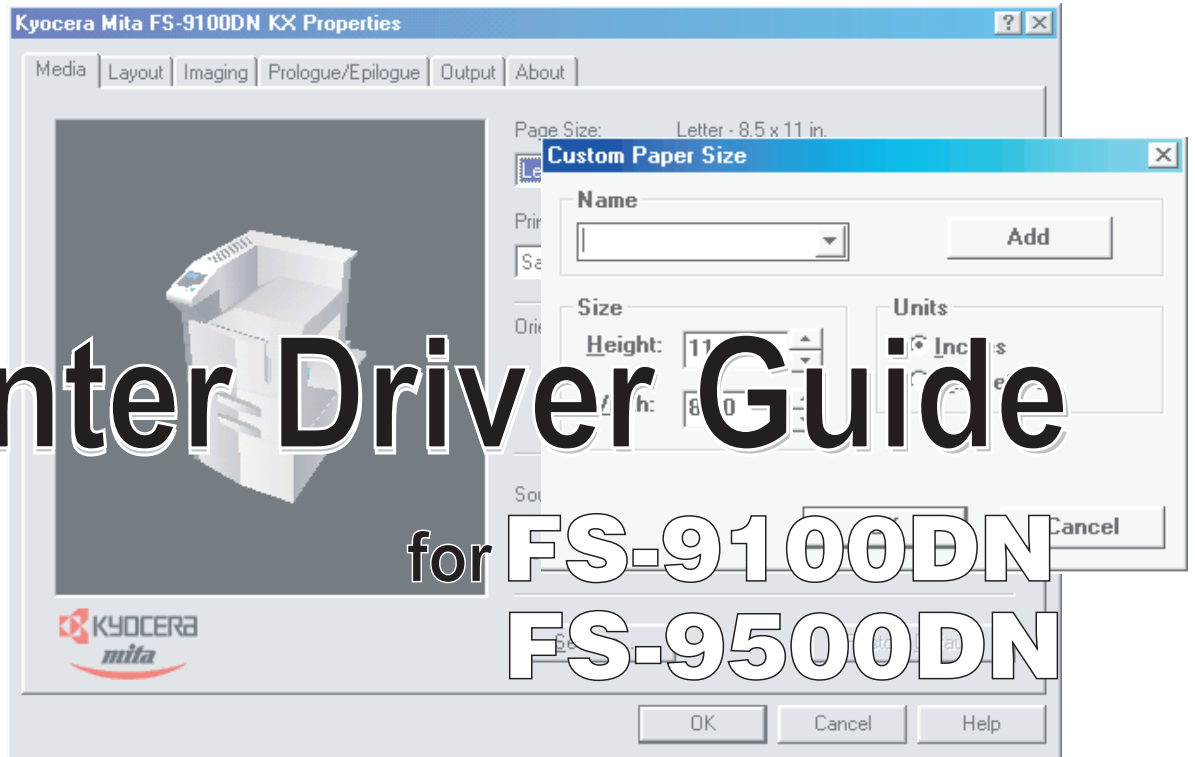

---

## Notice

---

The information in this guide is subject to change without notification. Additional pages may be inserted in future editions. The user is asked to excuse any technical inaccuracies or typographical errors in the present edition.

No responsibility is assumed if accidents occur while the user is following the instructions in this guide. No responsibility is assumed for defects in the printer's firmware (contents of its read-only memory).

This guide, any copyrightable subject matter sold or provided with or in connection with the sale of the page printer, are protected by copyright. All rights are reserved. Copying or other reproduction of all or part of this guide, any copyrightable subject matter without the prior written consent of Kyocera Corporation is prohibited. Any copies made of all or part of this guide, any copyrightable subject matter must contain the same copyright notice as the material from which the copying is done.

## Regarding Tradenames

---

PRESCRIBE is a registered trademark of Kyocera Corporation. Microsoft, and Windows are registered trademarks of Microsoft Corporation. PCL is a registered trademark of Hewlett-Packard Company. PostScript is a registered trademark of Adobe Systems Incorporated. CompactFlash is a trademark of SanDisk Corporation.

## Preface

This guide contains information on how to install, configure, and use the printer drivers for the Kyocera Mita FS-9100DN and FS-9500DN printers. The printer drivers and other utility software are supplied on the **Kyocera Mita Digital Library CD-ROM**, other additional CD-ROM, and from the Internet. The driver CD-ROM's is included with the printer.

The CD-ROM's supports different printer drivers for the following operating systems:

- Microsoft Windows 95, Windows 98, and Windows ME
- Microsoft Windows NT 4.0, and Windows 2000
- Apple Macintosh OS 7 or greater
- IBM OS/2 Version 2.0 or greater
- Linux

The guide focuses on using the printer driver on Windows 95 and Windows 98.

The latest Kyocera Mita printer drivers and utilities are readily available at the following web site:

<http://www.kyocera.com/w2k>.

---

## NOTE

For improvement purposes, the user interface design and functionalities of the printer driver may vary depending on the version. The diagrams used throughout this guide are only for examples.

---



---

# Contents

<b>Chapter 1 Installing the Printer Driver</b> .....	<b>1-1</b>
<b>Chapter 2 Setting the Defaults</b> .....	<b>2-1</b>
2.1 Adding Option Devices (Setup).....	2-1
2.1.1 Installing the Paper Feeder (PF-70) .....	2-1
2.1.2 Installing the Paper Feeder (PF-75) .....	2-2
2.1.3 Installing the Document Finisher (DF-70/DF-71) .....	2-3
2.1.4 Installing the Document Finisher (DF-75).....	2-4
2.1.5 Installing the Hard Disk.....	2-5
2.1.6 Using the RAM Disk.....	2-5
2.1.7 Selecting the User Name.....	2-6
2.1.8 Selecting the Printer Description Language .....	2-7
<b>Chapter 3 Printing Through Application Software</b> .....	<b>3-1</b>
3.1 Setting the Paper Size .....	3-1
3.1.1 Custom Size Settings .....	3-3
3.1.2 Advanced Media Settings .....	3-4
3.2 Setting the Duplex Printing .....	3-5
3.3 Using the Booklet Mode.....	3-6
3.4 Using the Document Finisher (DF-70/DF-71) .....	3-7
3.5 Using the Document Finisher (DF-75) .....	3-8
3.6 e-MPS .....	3-9
3.6.1 Using Job Retention .....	3-10
3.6.2 Using Virtual Mailbox Printing.....	3-15
3.6.3 Using Code Job .....	3-18

# Chapter 1 Installing the Printer Driver

Kyocera Mita Digital Library CD-ROM will automatically start to play its installation menu which guides you through the installation of the printer driver.

## NOTE

To make CD-ROMs play automatically when inserted in the CD-ROM drive, the Auto insert notification for the CD-ROM drive must be activated. This feature is activated by default for all Windows platforms. For details, refer to Windows Help.

To install, proceed as follows:

- 1 Set the Kyocera Mita Digital Library CD-ROM in your PC's CD-ROM drive. After awhile, the **Kyocera Mita Digital Library** splash screen appears.
- 2 Click **Install Drivers**. The **Kyocera Mita Setup Wizard** window begins.
- 3 Click **Next**.
- 4 In the **Select a device model** window, click **FS-9100DN** or **FS-9500DN**.

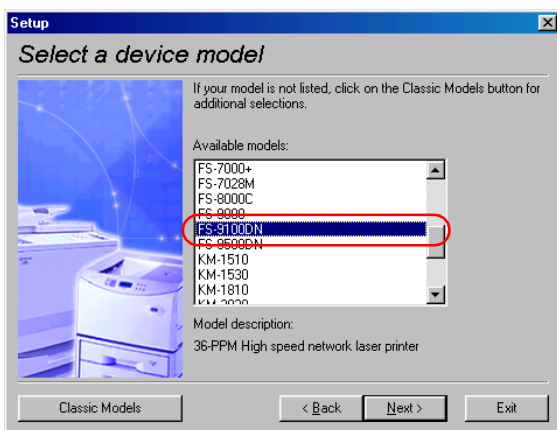

- 5 Click **Next**.

- 6 In the **Select a driver language** window, click on the desired language.



- 7 Click **Next**.

- 8 Check the contents, and then click **Next**.

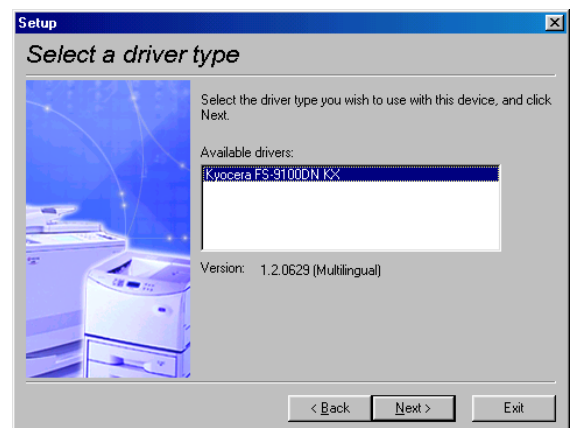

- 9 In the **End user license agreement** window, check the contents, and then click **Accept**.
- 10 In the **Select driver options** window, check the **True Type screen fonts**.  
To use Kyocera Mita printer command language PRE-SCRIBE as module, check the **Prologue/Epilogue Module** if you use it, and then click **Next**.

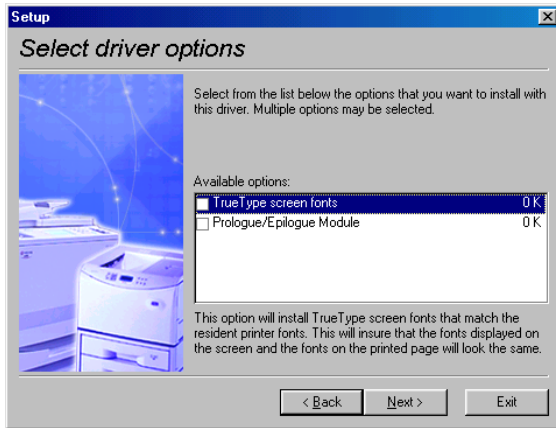

- 11 Continue to follow the rest of the wizard and complete the installation.

# Chapter 2      Setting the Defaults

This section explains how to set defaults on option devices installed on the printer. Settings made in this way will become effective for all application software. To temporarily change the settings, make printer settings from the application. See *Chapter 3 Printing Through Application Software*.

## 2.1 Adding Option Devices (Setup)

The **Device Settings** tab enables you to setup option devices such as the paper feeder so that the printer can recognize them. Each printer has a unique set of options that are listed in the **Device Settings** window. If you have attached one or more printer options, check that option.

### 2.1.1 Installing the Paper Feeder (PF-70)

Check that the option paper feeder (PF-70) is installed on the printer correctly.

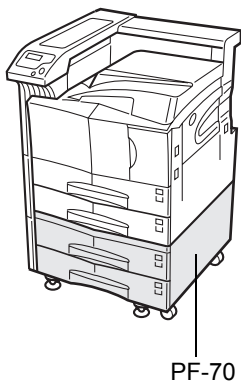

**1** Browse **Start > Settings > Printers**.

**2** Right click on the **Kyocera Mita FS-9100DN KX** or **Kyocera Mita FS-9500DN KX** icon and then click **Properties**.

The **Properties** dialog box is displayed.

**3** Click the **Device Settings** tab.

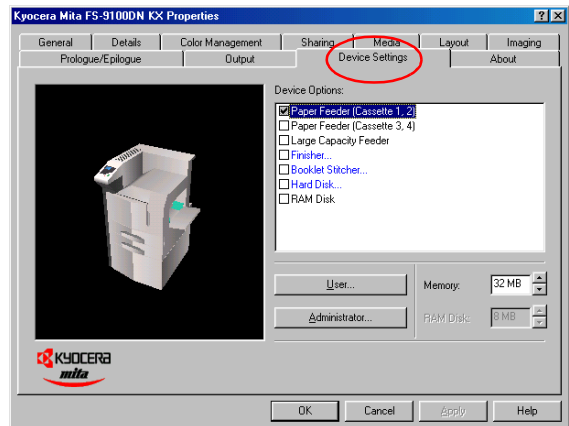

**4** Check **Paper Feeder (cassette 3, 4)** in the **Device Options** list box.

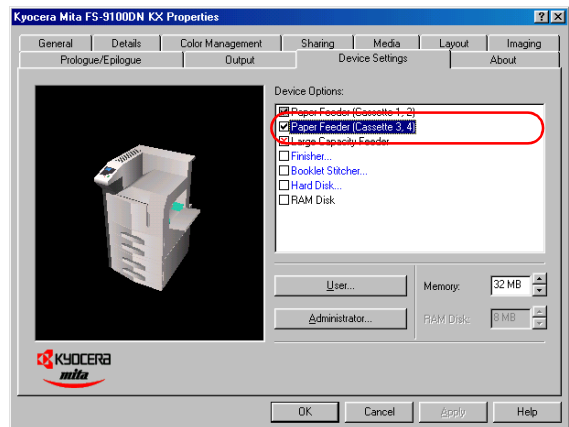

**5** Click the **OK** button.

### 2.1.2 Installing the Paper Feeder (PF-75)

Check that the optional paper feeder (PF-75) is installed on the printer correctly.

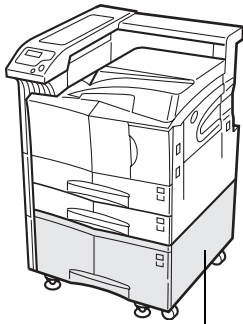

PF-75

- 1 Browse **Start > Settings > Printers**.
- 2 Right click on the **Kyocera Mita FS-9100DN KX** or **Kyocera Mita FS-9500DN KX** icon and then click **Properties**.

The **Properties** dialog box is displayed.

- 3 Click the **Device Settings** tab.

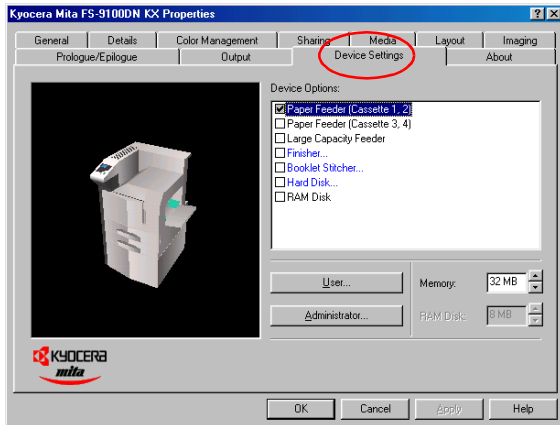

- 4 Check **Large Capacity Feeder** in the **Device Options** list box.

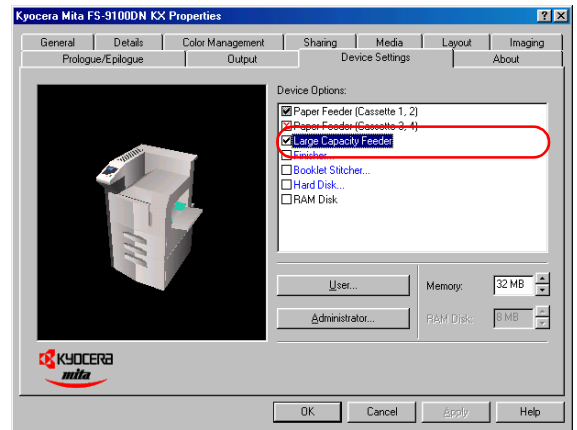

- 5 Click the **OK** button.

### 2.1.3 Installing the Document Finisher (DF-70/DF-71)

Check that the optional document finisher (DF-70/DF-71) is installed on the printer correctly.

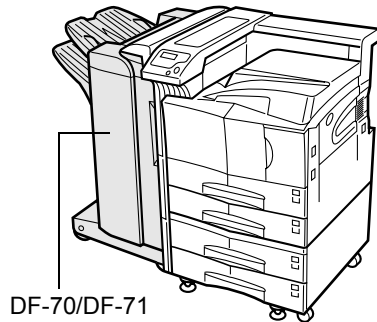

**4** Check **Finisher** in the **Device Options** list box.

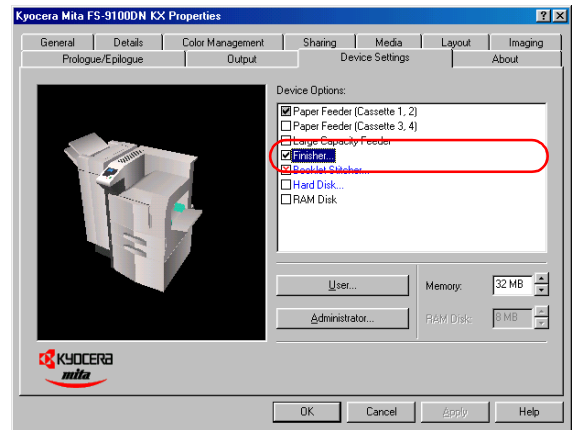

**5** Click the **OK** button.

**1** Browse **Start > Settings > Printers**.

**2** Right click on the **Kyocera Mita FS-9100DN KX** or **Kyocera Mita FS-9500DN KX** icon and then click **Properties**.

The **Properties** dialog box is displayed.

**3** Click the **Device Settings** tab.

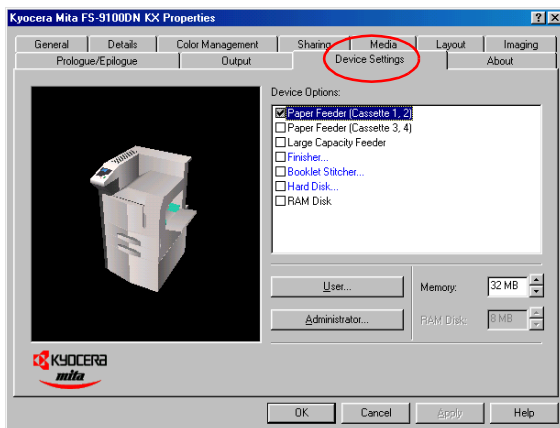

## 2.1.4 Installing the Document Finisher (DF-75)

Check that the optional document finisher (DF-75) is installed on the printer correctly.

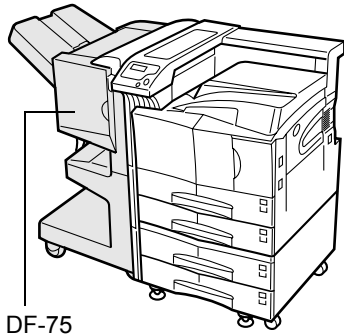

- 1 Browse **Start > Settings > Printers**.
- 2 Right click on the **Kyocera Mita FS-9100DN KX** or **Kyocera Mita FS-9500DN KX** icon and then click **Properties**.

The **Properties** dialog box is displayed.

- 3 Click the **Device Settings** tab.

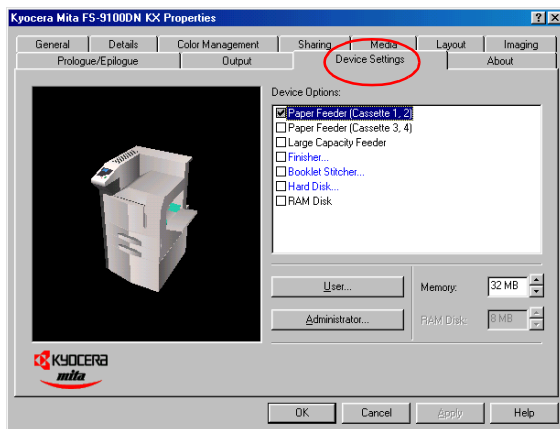

- 4 Check **Booklet Sticher** in the **Device Options** list box.

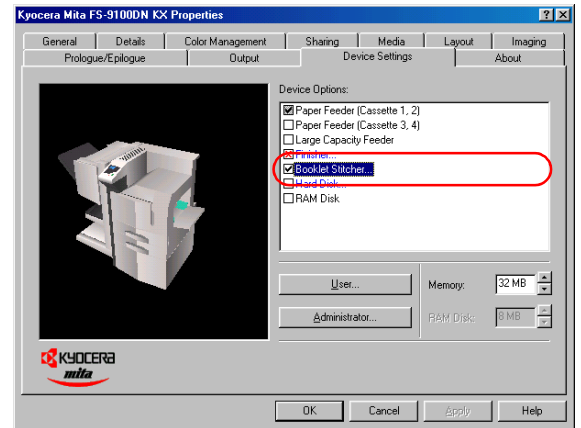

- 5 Click the **OK** button.

### 2.1.5 Installing the Hard Disk

Check that the optional hard disk is installed in the printer correctly.

- 1 Browse **Start > Settings > Printers**.
- 2 Right click on the **Kyocera Mita FS-9100DN KX** or **Kyocera Mita FS-9500DN KX** icon and then click **Properties**.

The **Properties** dialog box is displayed.

- 3 Click the **Device Settings** tab.

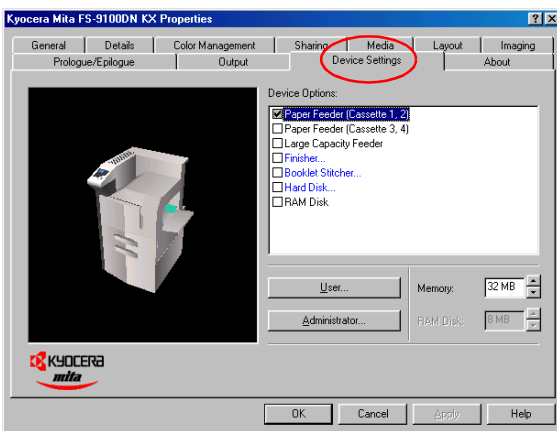

- 4 Check **Hard Disk** in the **Device Options** list box.

#### NOTE

When installing hard disk, make sure to remove the check mark of the **RAM Disk**.

### 2.1.6 Using the RAM Disk

Turn the RAM disk mode On and set its size using the printer's operator panel beforehand.

- 1 Browse **Start > Settings > Printers**.
- 2 Right click on the **Kyocera Mita FS-9100DN KX** or **Kyocera Mita FS-9500DN KX** icon and then click **Properties**.

The **Properties** dialog box is displayed.

- 3 Click the **Device Settings** tab.

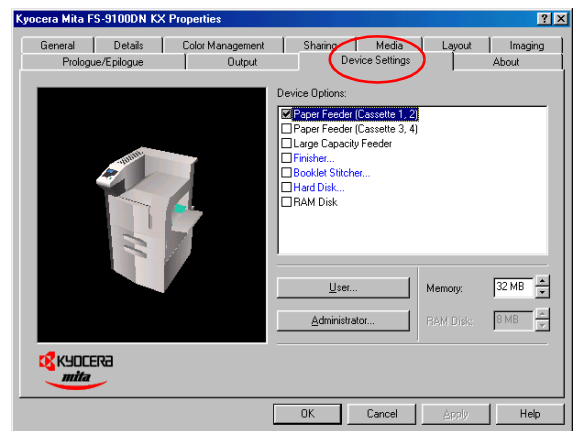

- 4 Check **RAM Disk** in the **Device Options** list box.

#### NOTE

When using RAM disk, make sure to remove the check mark of the **Hard Disk**.

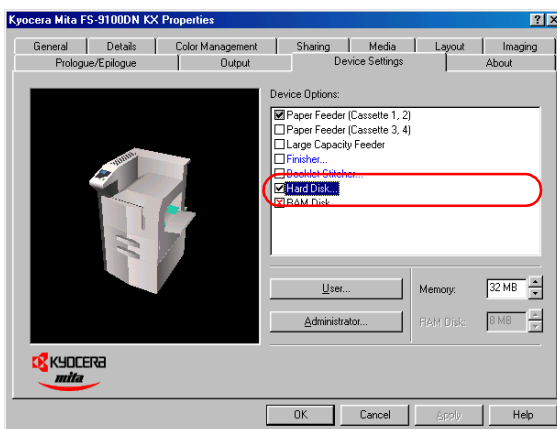

- 5 Click the **OK** button.

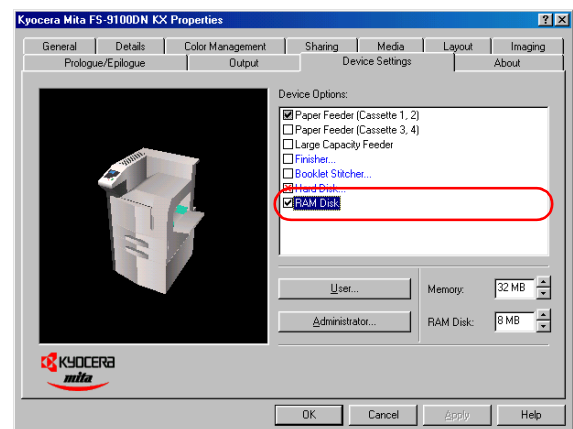



- 5** Set the same RAM disk size as the printer's operator panel.

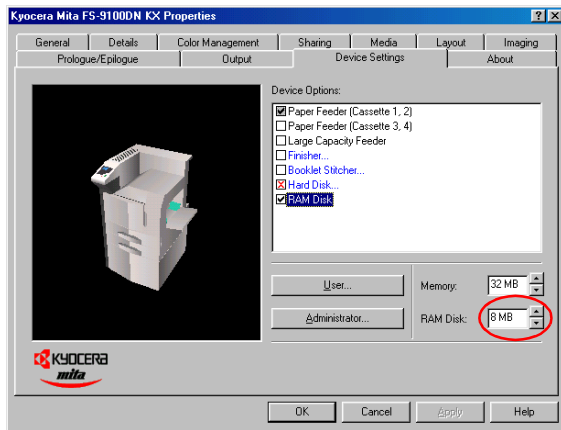

- 6** Click the **OK** button.

## 2.1.7 Selecting the User Name

You can register your name to the printer driver. After registration, you can select the name from the operator panel when printing using the e-MPS function.

- 1** Browse **Start > Settings > Printers**.

- 2** Right click on the **Kyocera Mita FS-9100DN KX** or **Kyocera Mita FS-9500DN KX** icon and then click **Properties**.

The **Properties** dialog box is displayed.

- 3** Click the **Device Settings** tab.

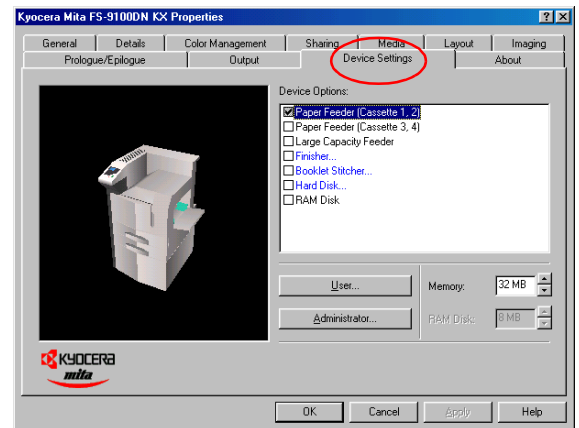

- 4** Click the **User** button. The **User Settings** dialog box is displayed.

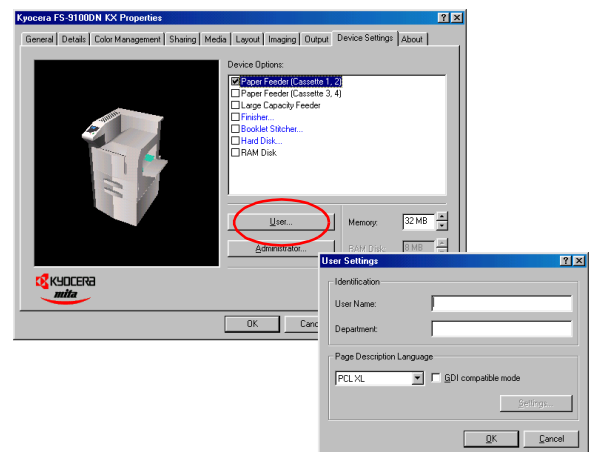

## Chapter 2 Setting the Defaults

- 5 Enter the **User Name** and **Department** name, and click the **OK** button.

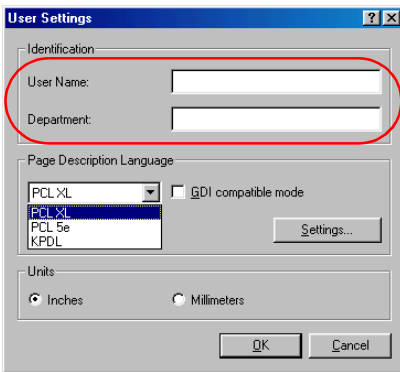

- 6 Click the **OK** button.

### 2.1.8 Selecting the Printer Description Language

Select the printer description language adequate for the data to be printed from among PCL XL, PCL 5e and KPDL (PostScript compatible). When using the virtual mailbox function, select PCL XL or PCL 5e. The default setting is PCL XL.

- 1 Browse **Start > Settings > Printers**.
- 2 Right click on the **Kyocera Mita FS-9100DN KX** or **Kyocera Mita FS-9500DN KX** icon and then click **Properties**.

The **Properties** dialog box is displayed.

- 3 Click the **Device Settings** tab.

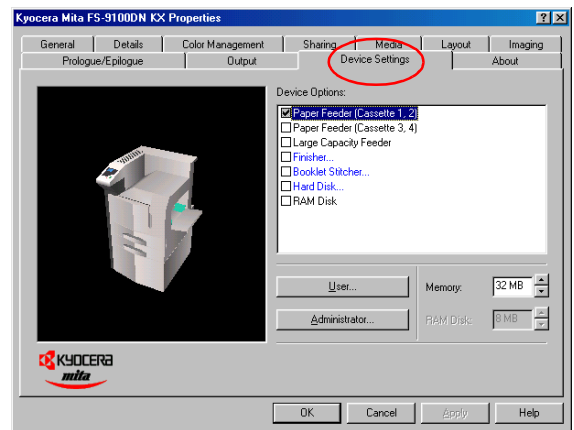

- 4 Click the **User** button. The **User Settings** dialog box is displayed.

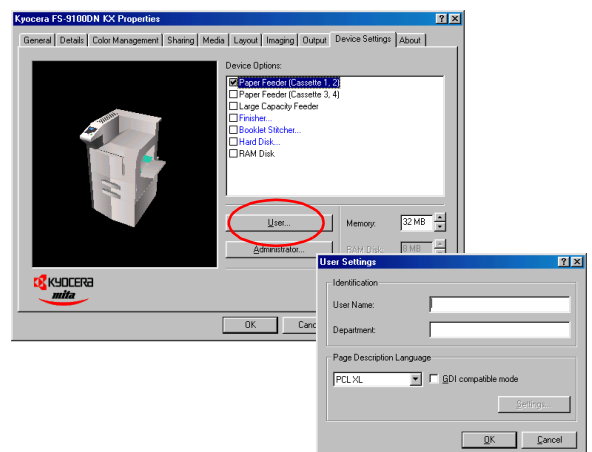

- 5 Select **PCL XL**, **PCL 5e**, or **KPDL** in the **Page Description Language** drop down list, and click the **OK** button.

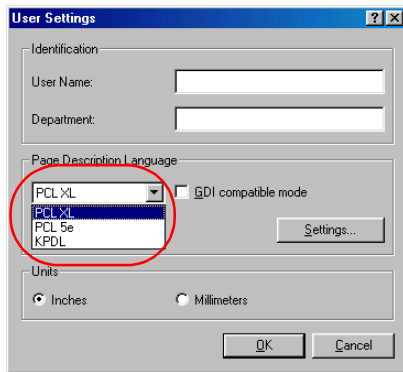

- 6 Click the **OK** button.

# Chapter 3

# Printing Through Application Software

This section uses a document created using Microsoft Word as an example of how to print from applications.

## 3.1 Setting the Paper Size

- 1 Set paper of the size specified for the document in the application into the printer's paper cassette. (For details on how to set paper sizes, refer to the [Installation Guide](#).)

Be sure that the document is correctly formatted with the paper size you intended to use. To do this, from the Word task bar, select **File, Page Setup, Paper Size** and select the **paper size**.

- 2 Browse **File > Print**. The **Print** dialog box will be displayed.

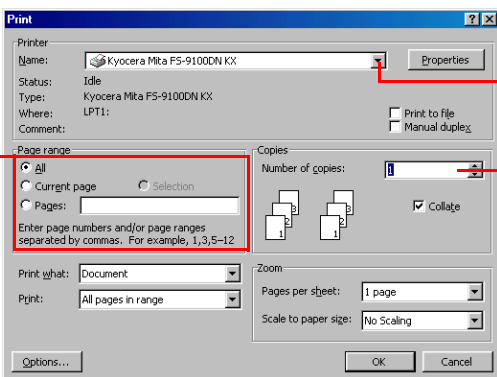

- 3 Click on the **Name** drop down list, all the printers installed under Windows are listed. Select **Kyocera Mita FS-9100DN KX** or **Kyocera Mita FS-9500DN KX**.

- 4 Select the range of the pages you want to print in the document, **All** or **Current page** in **Page range**. To print part of the document, check **Pages**, then enter page numbers separated by commas.

- 5 Specify the number of copies you want to print in the **Number of copies** combo box in **Copies**.

- 6 Click the **Properties** button in the **Print** dialog box. The **Properties** dialog box is displayed.

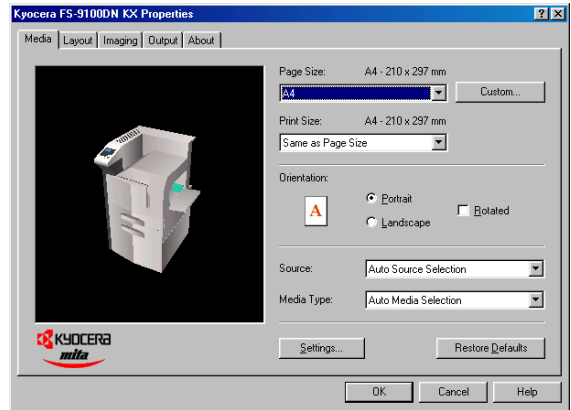

- 7 Click on the **Page Size** drop down list. Select the proper page size. A5 was selected for the following example.

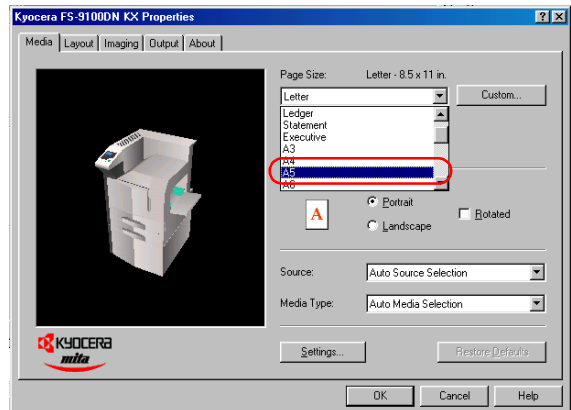

- 8** Select **Same as Page Size** in the **Print Size** drop down list, and then click the **OK** button.

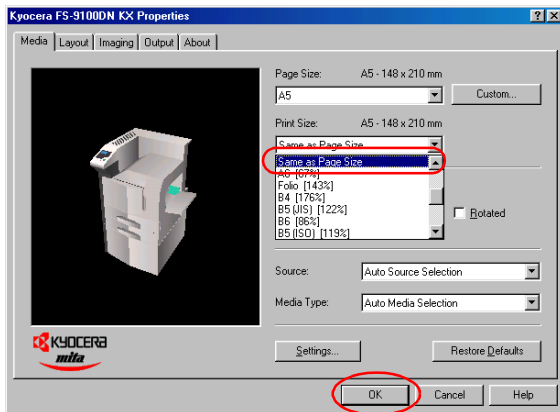

**NOTE**

When printing with the different print size from the page size, select the desired size in the **Print Size** drop down list.

When printing using non-standard size paper, see [Custom Size Settings on page 3-3](#).

- 9** Normally, select **Auto Source Selection**. Then, the paper will be fed from the paper feeder in which the paper with the selected **Paper Size** (step 7) is installed.

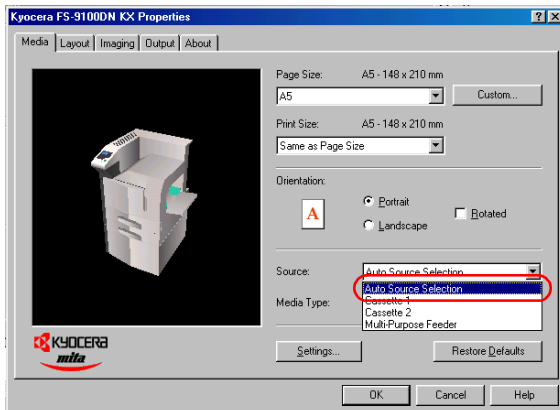

- 10** Select the desired media in the **Media Type** drop down list. Paper will be fed from the paper feeder to which the selected **Media Type** is set.

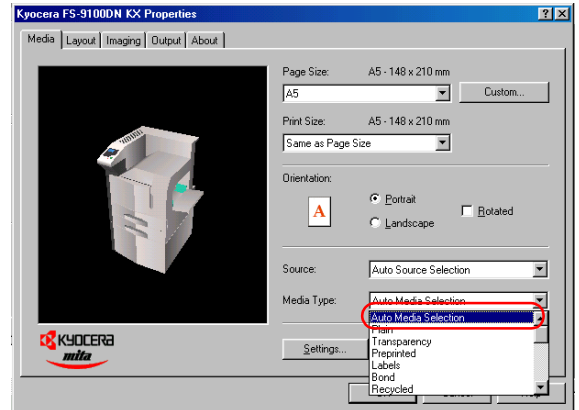

- 11** The **Print** dialog box is displayed again. Click the **OK** button to start printing.

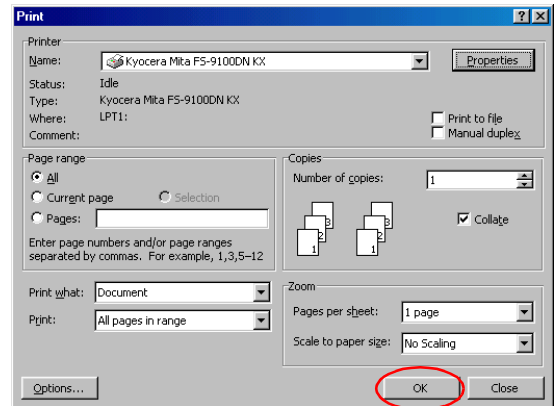

**NOTE**

Settings made from applications are not saved when the application is closed. The default settings are restored when the application is opened the next time. To change the printer driver default settings, make printer settings from Windows.

## 3.1.1 Custom Size Settings

The MP tray can feed non-standard paper sizes. It can accommodate sizes ranging from 88 to 297 mm in width and 148 to 450 mm in length. The procedure for setting custom sizes from the printer driver is explained below.

- 1 Display the printer driver's **Properties** dialog box from the application software, then click **Custom** button.

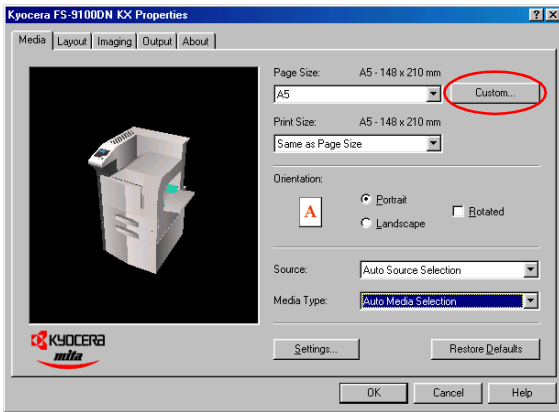

- 4 Select the unit of measurement, **Inches** or **Millimeters**.

- 5 Enter the height and width of the custom size in **Size**.

- 6 Click the **OK** button. The custom paper size is added to the **Customized Paper Sizes** list.

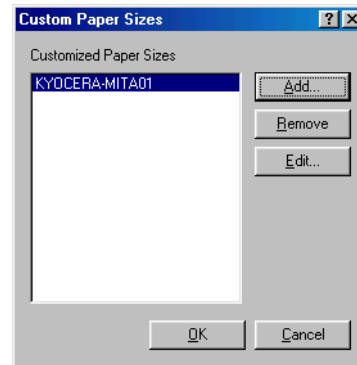

- 7 Click the **OK** button. The **Properties** dialog box is displayed again.

- 2 The **Custom Page Size** dialog box will appear, then click the **Add** button. The **Edit Paper Size** dialog box will appear.

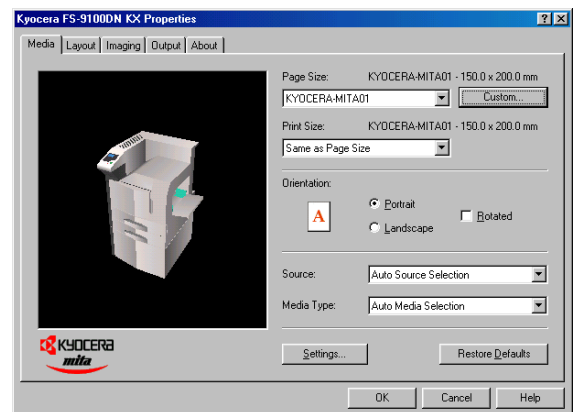
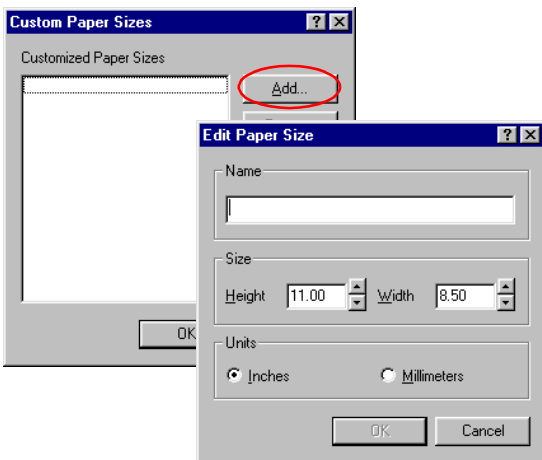

- 8 Select the **Custom Size** from the **Paper Size** drop down list.

- 9 In the printer's operator panel, press the **MENU** key and press the  $\Delta$  or  $\nabla$  key until **Paper Handling >** appears. Next, press the  $\triangleright$  key followed by the  $\Delta$  or  $\nabla$  key until **>MP Tray Size** appears. Then, get the MP tray size to **Custom**.

- 3 Enter a name for your custom size in **Name**.

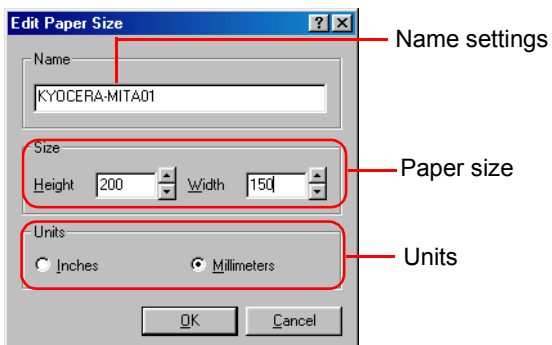

- 10 Set the selected size of papers in the MP tray. In the **Print** dialog box, click the **OK** button to start printing.

### 3.1.2 Advanced Media Settings

You can use the advanced media setting mode. There are three advanced media settings: Cover Mode, Page Insert, and Transparency Interleaving.

- 1 Display the printer driver's **Properties** dialog box from the application software, then click the **Settings** button.

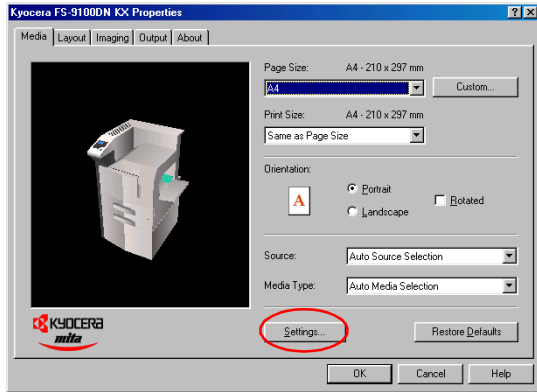

- 2 The **Advanced Media Settings** dialog will appear. Select **Cover Mode**, **Page Insert** or **Transparency Interleaving**.

#### Cover Mode:

Print the cover with another paper. You can also print on the back side of the cover. In the Source for Cover drop down list, select the paper cassette in which the paper for cover is installed.

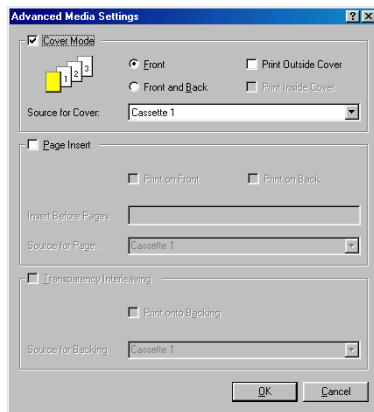

#### Page Insert:

Different type of paper can be inserted before the pages. You can also print on the inserted page. Enter the page to be inserted in the **Insert Before Pages** box, and then select the paper cassette in the **Source for Page** drop down list.

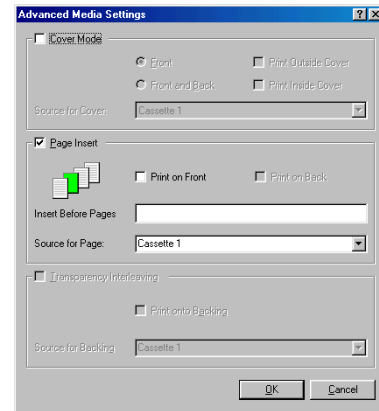

#### Transparency Interleaving:

Backing can be inserted into transparency from the designated paper feeder. You can also print on the inserted backing. In the **Source for Backing** drop down list, select the paper cassette in which the paper to be inserted is installed.

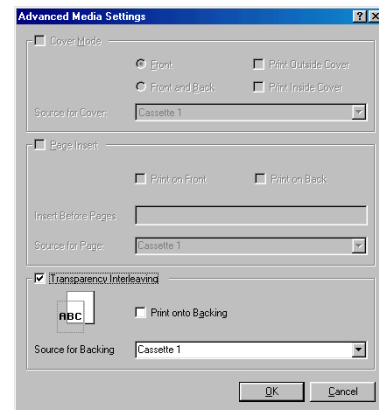

- 3 Click the **OK** button.

## 3.2 Setting the Duplex Printing

- 1 Browse **File > Print**. The **Print** dialog box will be displayed.

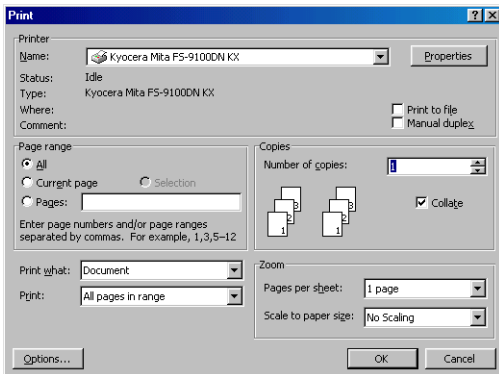

- 7 Click **Print on Both Sides (Duplex)** and then check the **Flip on Long Edge** or **Flip on Short Edge** radio button. The graphic icon will change to illustrate your selection.

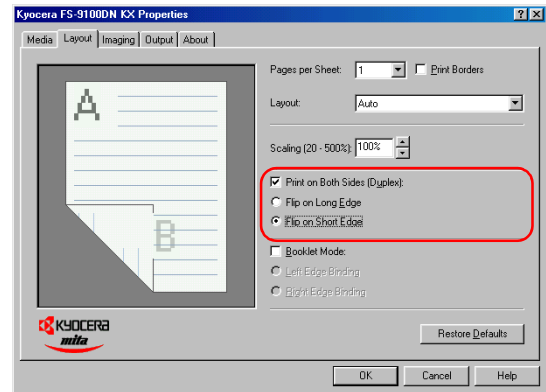

- 2 Click on the **Name** drop down list, all the printers installed under Windows are listed. Select **Kyocera Mita FS-9100DN KX** or **Kyocera Mita FS-9500DN KX**.

- 3 Select the range of the pages you want to print in the document, **All** or **Current page** in **Page range**. To print part of the document, Check **Pages**, then enter page numbers separated by commas.

- 4 Specify the number of copies you want to print in the **Number of copies** combo box in **Copies**.

- 5 Click the **Properties** button in the **Print** dialog box. The **Properties** dialog box is displayed.

- 6 Click the **Layout** tab.

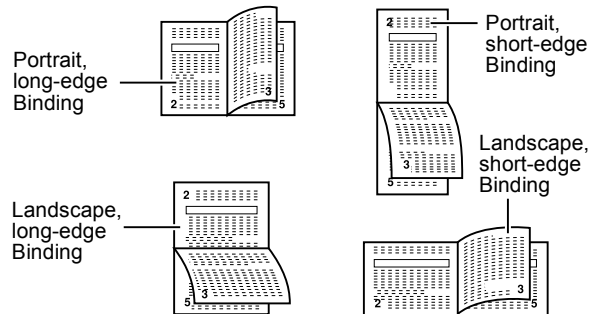

### NOTE

When you select **Booklet Mode**, double-sided pages will be printed as aligned in the stitching mode. See [Using the Booklet Mode on page 3-6](#).

- 8 Click the **OK** button.

To change the default setting to duplex printing, make this setting from Windows.

- 9 The **Print** dialog box is displayed again. Click the **OK** button to start printing.



## 3.3 Using the Booklet Mode

If you select **Booklet Mode**, double-sided pages with the stitching areas will be printed. When selecting **Booklet Mode** with the document finisher DF-75, double-sided stitching print will be done.

### NOTE

Stitching print supports the print sizes: A3, Ledger, B4, A4-R and Letter-R.

- 1 In the **Print** dialog, click the **Properties** button and then click the **Output** tab.
- 2 Select **Finisher [Face-down]** as **Output to**.
- 3 Click the **Layout** tab, and then check the **Booklet Mode** box, then select **Left Edge Binding** or **Right Edge Binding**.

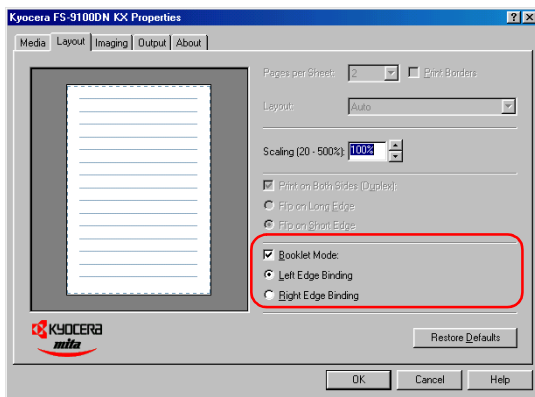

- 4 Click the **Output** tab, and then check the **Staple** box. **Booklet** is automatically selected.

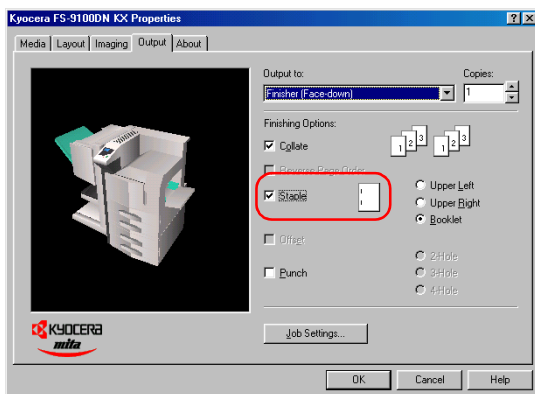

- 5 Click the **OK** button. The **Print** dialog box is displayed again.
- 6 Click the **OK** button to start printing.

### 3.4 Using the Document Finisher (DF-70/DF-71)

DF-70 provides the staple function, while DF-71 provides the punch function.

**1** Browse **File > Print**. The **Print** dialog box will be displayed.

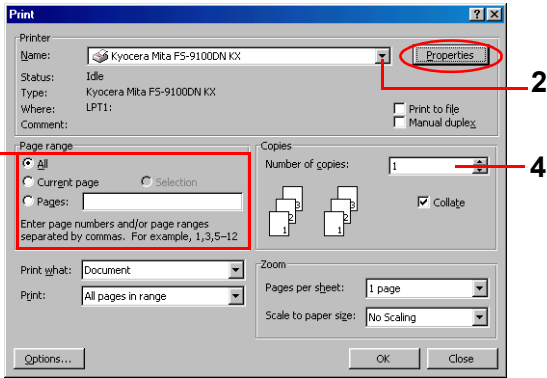

**2** Click on the **Name** drop down list, all the printers installed under Windows are listed. Select **Kyocera Mita FS-9100DN KX** or **Kyocera Mita FS-9500DN KX**.

**3** Select the range of the pages you want to print in the document, **All** or **Page range**. To print part of the document, check **Pages**, then enter page numbers separated by commas.

**4** Specify the number of copies you want to print in the **Number of copies** combo box in **Copies**.

**5** Click the **Properties** button in the **Print** dialog box. The **Properties** dialog box is displayed.

**6** Click the **Output** tab.

**7** Select **Finisher [Face-down]** or **Finisher [Face-up]** as **Output to** drop down list, and click the **OK** button.

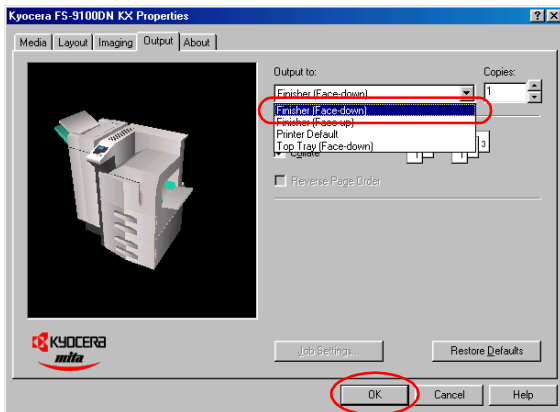

**8** If you want to collate the output pages, check the **Collate** box.

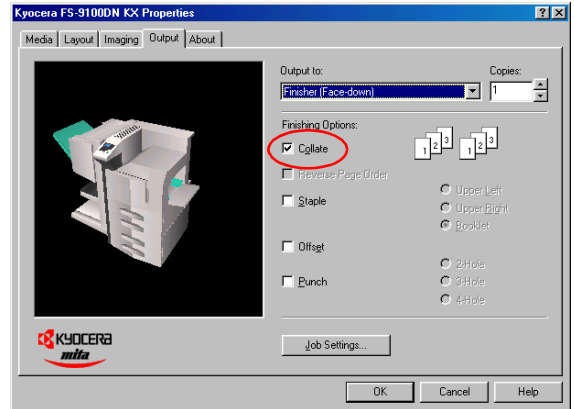

#### Finishing Options

**Collate:** sets whether the pages are collated or not.

**Reverse**

**Page Order:** prints in the reverse page order.

**Staple:** selects the staple position: Upper Left, Upper Right or Booklet (stitching position).

**Offset:** Outputs pages while shifting them alternately for each document.

**Punch:** selects the hole punch type: 2-Hole, 3-Hole or 4-Hole.

**9** Click the **OK** button in the **Properties** dialog box. The **Print** dialog box is displayed again.

**10** Click the **OK** button to start printing.

## 3.5 Using the Document Finisher (DF-75)

DF-75 provides the staple, punch and double-sided stitching print functions.

- 1 Browse **File > Print**. The **Print** dialog box will be displayed.

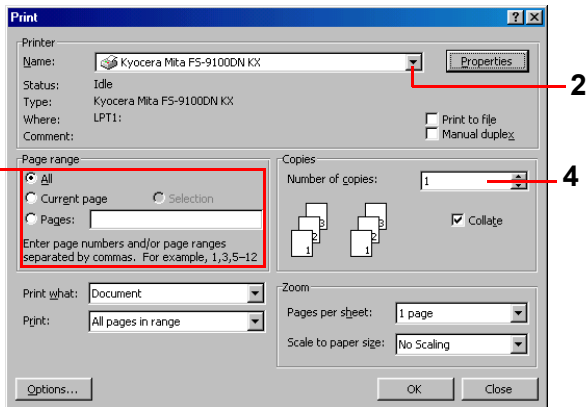

- 2 Click on the **Name** drop down list, all the printers installed under Windows are listed. Select **Kyocera Mita FS-9100DN KX** or **Kyocera Mita FS-9500DN KX**.

- 3 Select the range of the pages you want to print in the document, **All** or **Current page only** in **Page range**. To print part of the document, check **Pages**, then enter page numbers separated by commas.

- 4 Specify the number of copies you want to print in the **Number of copies** combo box in **Copies**.

- 5 Click the **Properties** button and then click the **Output** tab.

- 6 Click on the **Output** to drop down list. Select **Finisher [Face-down]** or **Finisher [Face-up]**. To use the staple or punch function, select **[Face-down]**.

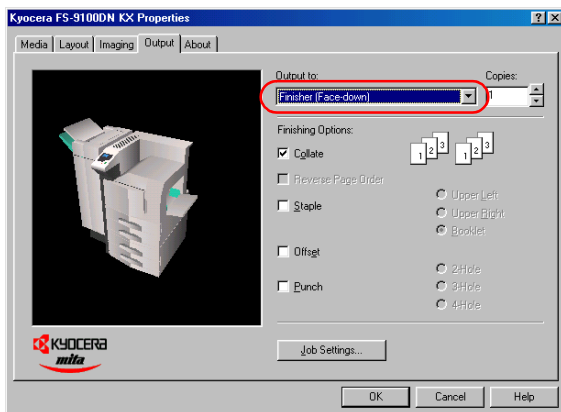

### Finishing Options

**Collate:** sets whether the pages are collated or not.

**Reverse**

**Page Order:** prints in the reverse page order.

**Staple:** selects the staple position: Upper Left, Upper Right or Booklet (stitching position).

**Offset:** outputs pages while shifting them alternately for each document.

**Punch:** selects the hole punch type: 2-Hole, 3-Hole or 4-Hole.

- 7 Click the **Layout** tab, check the **Booklet Mode** check-box, and then select **Left Edge Binding** or **Right Edge Binding**.

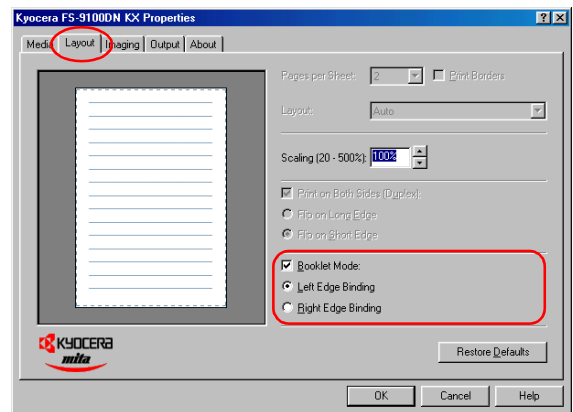

- 8 Click the **Media** tab, and then click on the **Page Size** drop down list. Select the proper page size. A5 was selected for the following example.

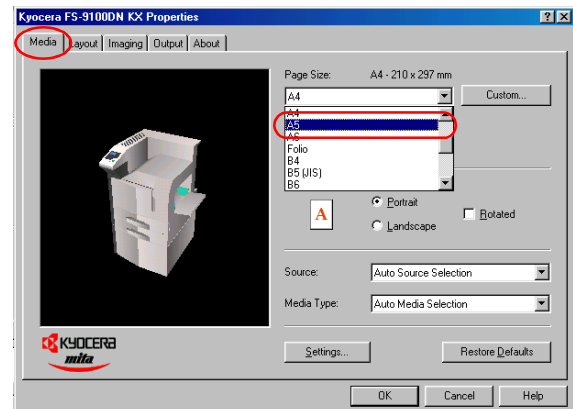

- 9 Select **Same as Page Size** in the **Print Size** list, and then click the **OK** button.

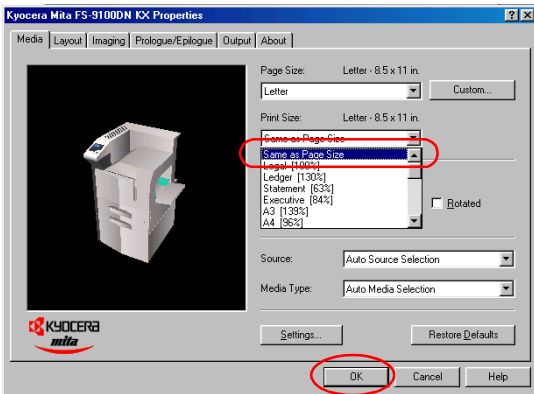

**NOTE**

When printing with the different print size from the page size, select the desired size in the **Print Size** drop down list.

When printing using non-standard size paper, See [Custom Size Settings on page 3-3](#).

- 10 Once you finish making paper size settings, the **Print** dialog box is displayed again. Click the **OK** button to start printing.

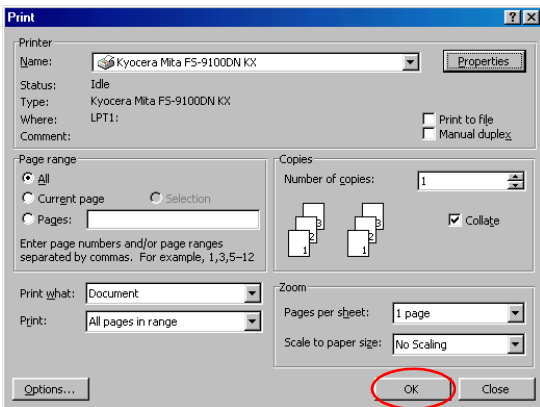

**NOTE**

Settings made from applications are not saved when the application is closed. The default settings are restored when the application is opened the next time. To change the printer driver default settings, make printer settings from Windows.

**3.6 e-MPS**

e-MPS provides the following three types of functions.

- Job Retention
- Virtual MailBox
- Code Job (Temporary and Permanent)

If you use any of the e-MPS functions, you can quickly multiple prints with one document data stored in the hard disk, saving you more times than performing the same printing several times.

**Job Retention**

This function allows you to save print jobs to the option hard disk and print them out as desired at the operator panel. When printing, select a Job Retention mode at the printer driver.

The following four modes are available:

- Quick Copy Printing See [page 3-10](#)
- Proof and Hold Printing See [page 3-11](#)
- Private Printing See [page 3-12](#)
- Job Storage Printing See [page 3-13](#)

**For how to make the settings, see the pages of the respective modes.**

Four Job Retention modes have the following benefits:

- **Quick Copy:** When you need another copy of a finished print job, you can print it out at the printer operator panel. There is no need to print from the computer again.
- **Proof and Hold:** When printing multiple copies, this mode first prints only one copy for proofing, allowing you to decide whether to continue printing the remaining copies or cancel printing at the operator panel. In this way, you can reduce the waste of paper.
- **Private Print:** Confidential print jobs can be printed out when you are at the printer. This mode saves print jobs in the printer without printing until you instruct the printer to do so at the operator panel. Printing using this mode requires the 4-digit access code you set using the printer driver.
- **Job Storage (Stored Job):** This mode allows you to store print jobs that are frequently needed, such as fax cover pages, checklists, and order forms, for printing later. Using the operator panel, you can then print them out as required at anytime and at any number of copies. You can set the 4-digit access code, if necessary.

**Virtual MailBox**

Virtual mailbox is the ability to store print jobs in the virtual mailboxes on the hard disk, enabling you to retrieve and print it later from the printer's operator panel or the option barcode reader (BC-1).

You can later print out only the jobs you desire using the operator panel on the printer.

When printing, make the settings at the printer driver. For how to make the settings, see [Using Virtual Mailbox Printing on page 3-15](#).

You can send a print job either to all the virtual mailbox trays at the same time or to the desired trays only.

Since you perform printing by selecting the desired trays using the operator panel, you can print out only the jobs you desire.

**Code Job (Temporary and Permanent)**

Code Job reduces the time to print multiple copies and enables the use of option barcode reader (BC-1) to print jobs stored on the hard disk.

When printing, select a type of code job at the printer driver. The following two types of code jobs are available:

- Permanent Code Job
- Temporary Code Job

For how to make the settings, see [Using Code Job on page 3-18](#).

You can print out frequently needed print jobs, such as fax cover pages, checklists, and order forms, using the option barcode reader.

If you store a print job and print it out with a barcode ID attached, you can print that job any time later by simply reading the barcode ID. You can print a list of code jobs at the operator panel. There are two types of code jobs: permanent code job and temporary code job. When the storage memory becomes insufficient, temporary code jobs will be automatically deleted in order from the oldest and permanent code jobs will not.

**3.6.1 Using Job Retention**

**Quick Copy Printing**

This allows you to print as many additional copies as you want until the printer is turned off, it is useful in cases such as when there are sudden increases in the required number of copies during a meeting.

To print, proceed as follows.

- 1 Browse **File > Print**. The **Print** dialog box will be displayed.

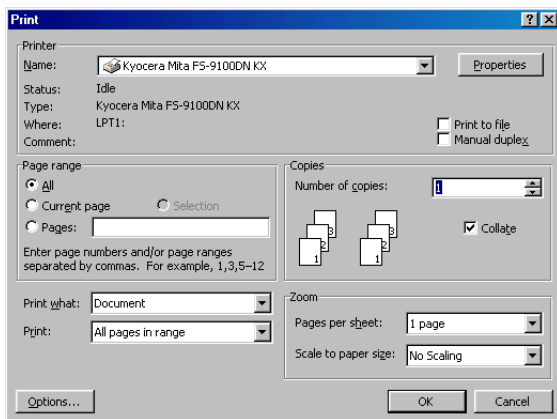

- 2 Click on the **Name** drop down list, all the printers installed under Windows are listed. Select **Kyocera Mita FS-9100DN KX** or **Kyocera Mita FS-9500DN KX**.

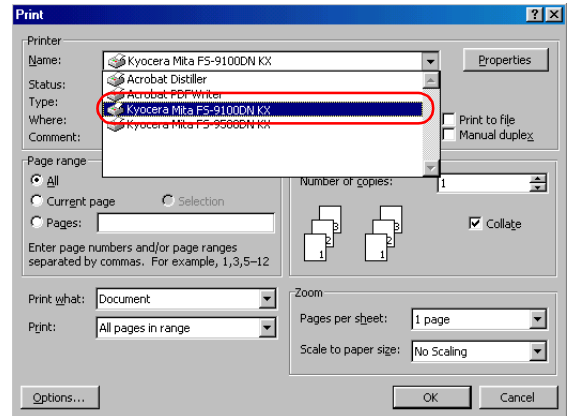

- 3 Select the range of the pages you want to print in the document, **All** or **Current page** in **Page range**. To print part of the document, check **Pages**, then enter page numbers separated by commas.

- 4 Specify the number of copies you want to print in the **Number of copies** combo box in **Copies**.

- 5 Click the **Properties** button. The **Properties** dialog box is displayed. Click the **Output** tab and then click the **Job Settings** button.

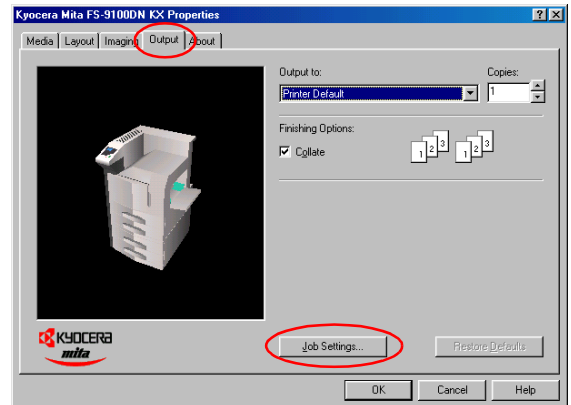

The **Job Settings** dialog box will appear.

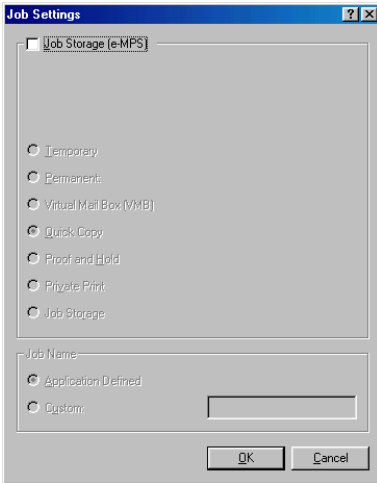

- 6** Check the **Job Storage** checkbox and then check the **Quick Copy**.

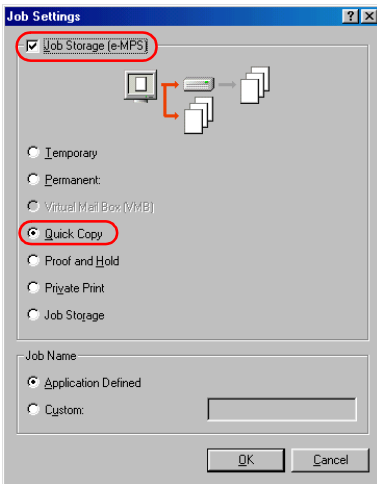

- 7** Click the **OK** button. The **Print** dialog box is displayed again. Click the **OK** button to start printing. The print job will be saved to the hard disk as it is printed.

If additional copies are required, print using the **Quick Copy** sub menu in the **e-MPS** menu at the printer operator panel. For details, see [Chapter 3 in the Operation Guide](#).

### Proof and Hold Printing

You can check the first copy before printing the remaining copies, paper wastage can be avoided. The print jobs will be deleted when the printer is turned off.

To print, proceed as follows.

- 1** Browse **File > Print**. The **Print** dialog box will be displayed.

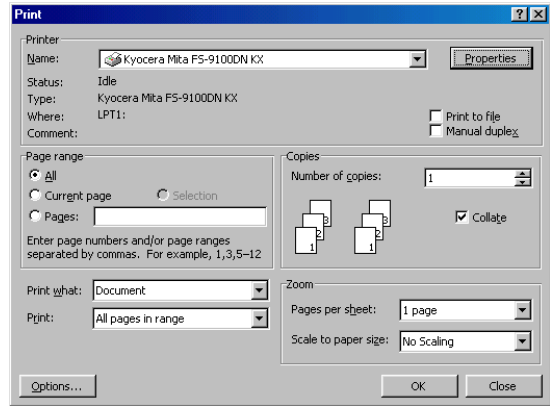

- 2** Click on the **Name** drop down list, all the printers installed under Windows are listed. Select **Kyocera Mita FS-9100DN KX** or **Kyocera Mita FS-9500DN KX**.

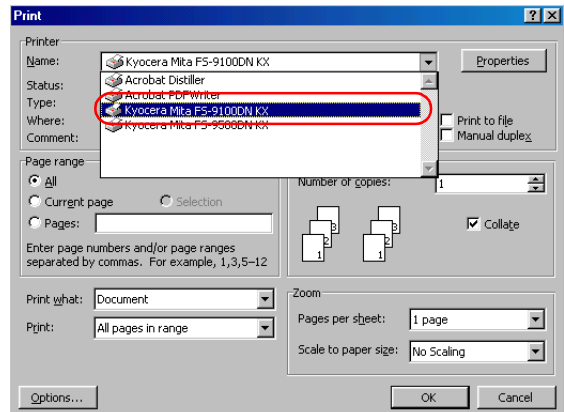

- 3** Select the range of the pages you want to print in the document, **All** or **Current page** in **Page range**. To print part of the document, check **Pages**, then enter page numbers separated by commas.

- 4** Specify the number of copies you want to print in the **Number of copies** combo box in **Copies**.

- Click the **Properties** button. The **Properties** dialog box is displayed. Click the **Output** tab and then click the **Job Settings** button.

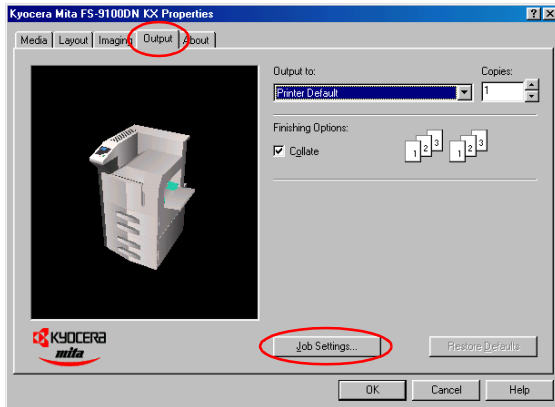

The **Job Settings** dialog box will appear.

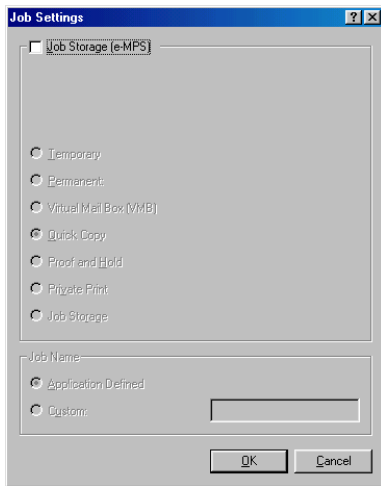

- Check the **Job Storage** checkbox, and then check the **Proof and Hold**.

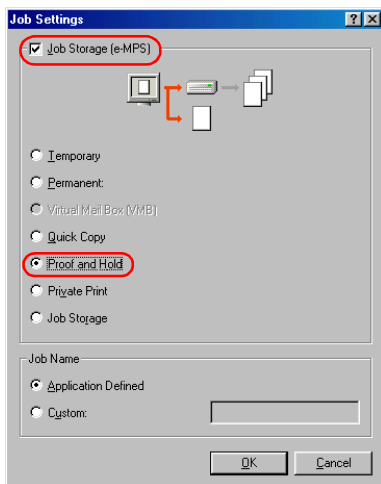

- Click the **OK** button. The **Print** dialog box is displayed again. Click the **OK** button to start printing. The print job will be stored to the hard disk as it is printed.

The printer will first print only one copy if you set to print multiple numbers of copies, allowing you to check the printouts. If there is no problem, resume printing the remaining copies using the **Quick Copy** sub menu in the **e-MPS** menu at the printer operator panel. For details, see *Chapter 3 in the Operation Guide*.

### Private Printing

You need to enter a password to retrieve the job, confidentiality is assured even if you share the printer with others. Print jobs will be deleted when they are printed or when the printer is turned off.

To print, proceed as follows.

- Browse **File > Print**. The **Print** dialog box will be displayed.

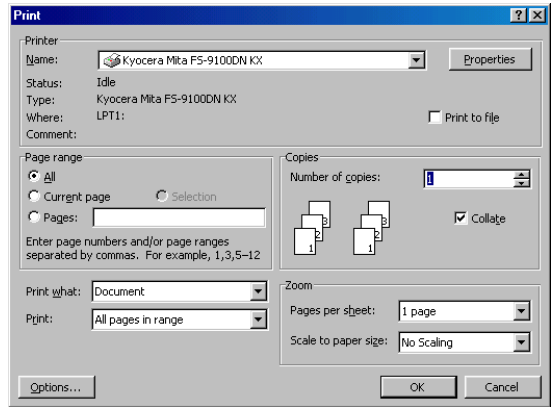

- Click on the **Name** drop down list, all the printers installed under Windows are listed. Select **Kyocera Mita FS-9100DN KX** or **Kyocera Mita FS-9500DN KX**.

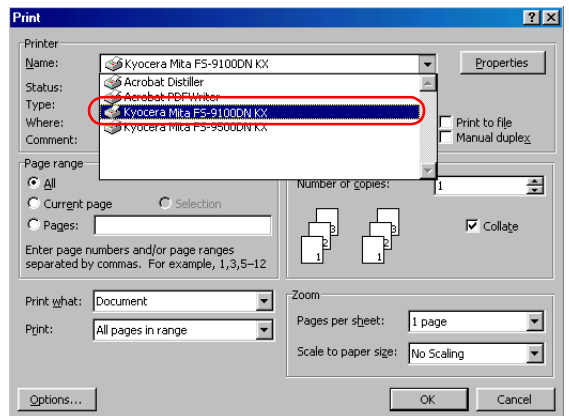

- Select the range of the pages you want to print in the document, **All** or **Current page** in **Page range**. To print part of the document, check **Pages**, then enter page numbers separated by commas.



## Chapter 3 Printing Through Application Software

- Specify the number of copies you want to print in the **Number of copies** combo box in **Copies**.
- Click the **Properties** button. The **Properties** dialog box is displayed. Click the **Output** tab and then click the **Job Settings** button.

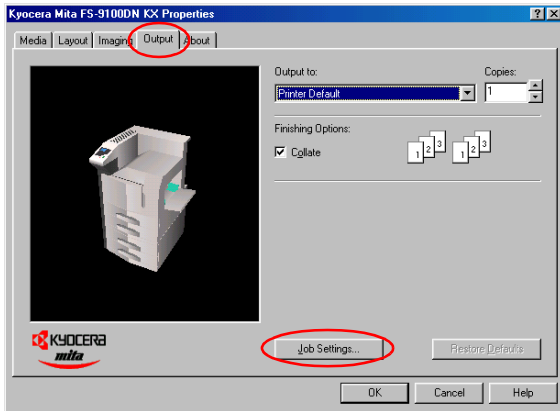

The **Job Settings** dialog box will appear.

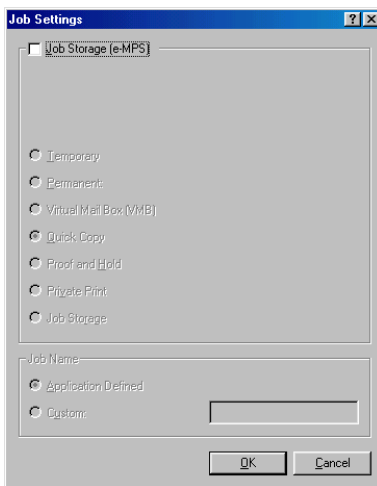

- Check the **Job Storage** checkbox, and then check the **Private Print**.

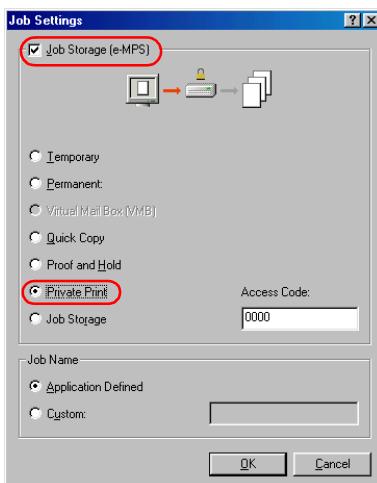

- Set the desired 4-digit access code using any numbers between 0 and 9. This number is synonymous with the user ID which is required to enter at the printer operator panel when retrieving.
- Click the **OK** button. The **Print** dialog box is displayed again. Click the **OK** button. The print job will be stored to the hard disk without printing.

To print, use the **Private/Stored** sub menu in the **e-MPS** menu at the printer operator panel. For details, see [Chapter 3 in the Operation Guide](#).

### Job Storage (Stored Job Printing)

Select this if you want to store frequently needed print jobs, such as forms, to print them later as required. The print jobs will not be deleted when the printer is turned off.

To print, proceed as follows.

- Browse **File > Print**. The **Print** dialog box will be displayed.

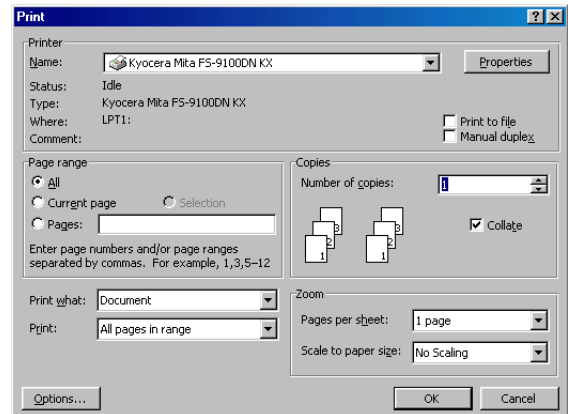

- Click on the **Name** drop down list, all the printers installed under Windows are listed. Select **Kyocera Mita FS-9100DN KX** or **Kyocera Mita FS-9500DN KX**.

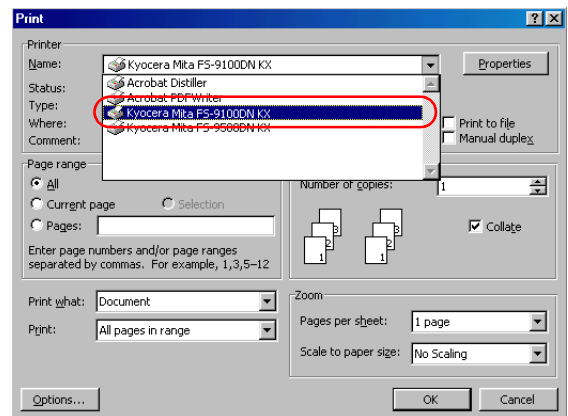

- Select the range of the pages you want to print in the document, **All** or **Current page** in **Page range**. To print part of the document, check **Pages**, then enter page numbers separated by commas.



**4** Specify the number of copies you want to print in the **Number of copies** combo box in **Copies**.

**5** Click the **Properties** button. The **Properties** dialog box is displayed. Click the **Output** tab and then click the **Job Settings** button.

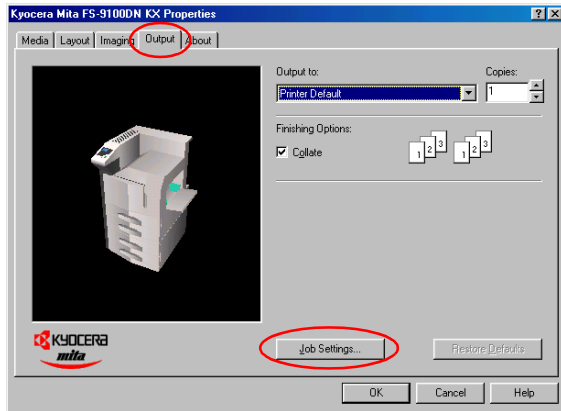

The **Job Settings** dialog box will appear.



**6** Check the **Job Storage** checkbox, and then check the **Job Storage**.

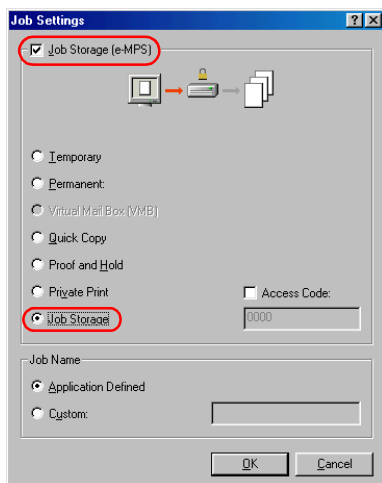

**7** You can add security to the print job. To do so, check the **Access Code** checkbox and enter the desired 4-digit access code using any numbers between 0 and 9. You must enter this number at the printer operator panel when printing.

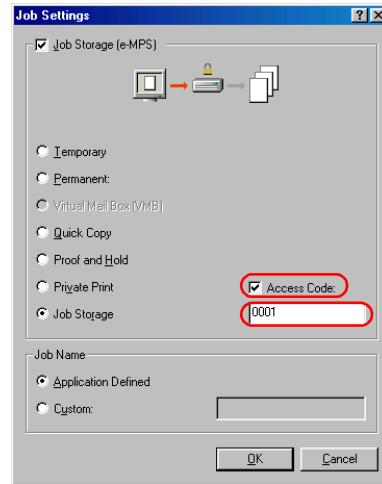

**8** Click the **OK** button. The **Print** dialog box is displayed again. Click the **OK** button. The print job will be stored to the hard disk without printing.

To print, use the **Private/Stored** sub menu in the **e-MPS** menu at the printer operator panel. For details, see [Chapter 3 in the Operation Guide](#).

### 3.6.2 Using Virtual Mailbox Printing

**NOTE**

The VMB function is available only when PCL 5e or PCL XL is selected as emulation.

Virtual mailbox is the ability to store print jobs in the virtual mailboxes on the hard disk, enabling you to retrieve and print it later from the printer's operator panel or the option barcode reader (BC-1). A maximum of 255 virtual mailboxes can be set up, making it possible to allocate documents not just for individual departments or groups, but even for individual people. The print jobs will not be deleted when the printer is turned off.

**Before Using VMB**

To use the VMB functions, select **PCL XL** or **PCL 5e** and then set the **Mailbox Name** and **Virtual Output Tray** beforehand. Follow these procedures.

**1** Browse **Start > Settings > Printers**.

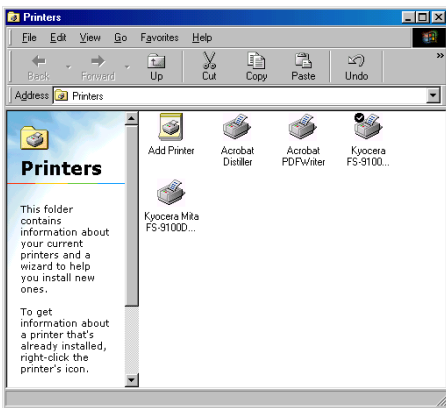

**2** Right-click on the **Kyocera FS-9100DN KX**, and then select **Properties**.

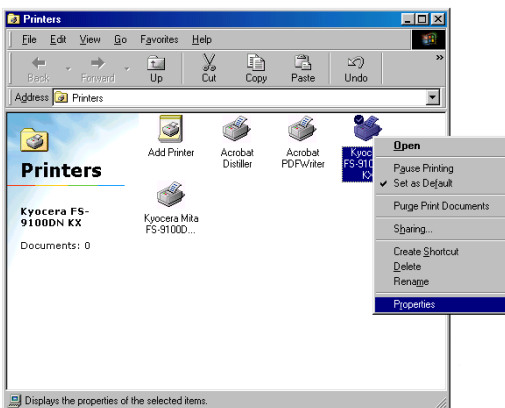

**3** Select the **Device Settings** tab.

**4** Click the **User** button. The **User Settings** dialog box is displayed.

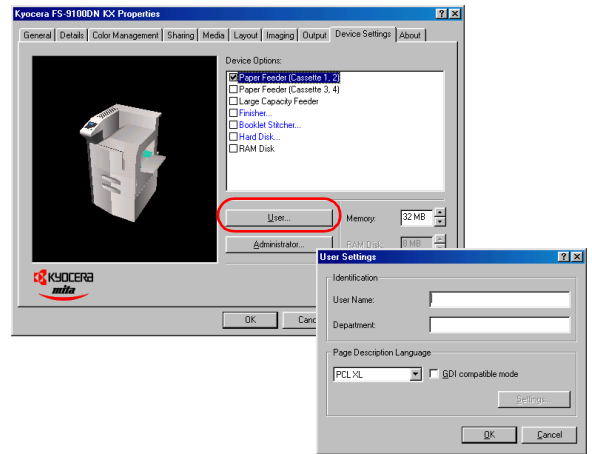

**5** Select **PCL XL** or **PCL 5e** in the **Page Description Language** drop down list.

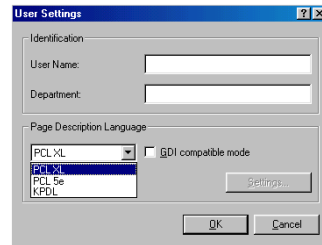

**6** Double-click **Hard Disk** in the **Device Options** list.

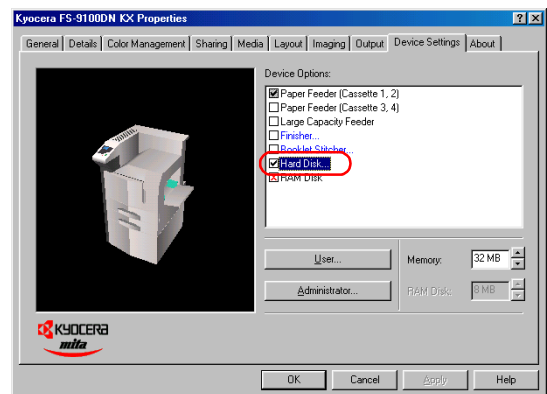

The **Hard Disk Settings** dialog box will be displayed.

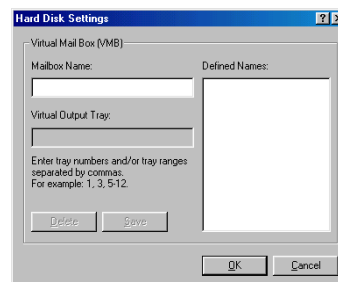

- Enter the mailbox name under **Mailbox Name**, and the tray number in the **Virtual Output Tray**, and then click the **Save** button.

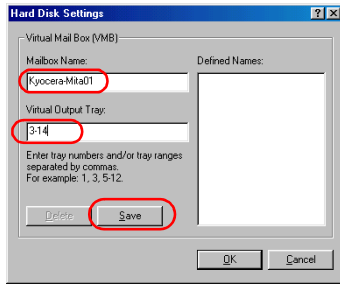

**NOTE**

The Multiple virtual mailbox tray number can be specified at a time using commas (,) and hyphen (-).

The Mailbox Name will be displayed in the **Defined Names** list box.

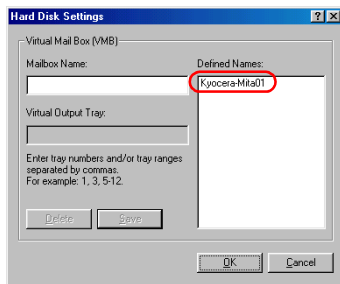

- Click the **OK** button to quit the **Hard Disk Settings** dialog box.
- In the **Kyocera FS-9100DN KX** Properties dialog box, click the **OK** button.
- Click the **X** button in the upper-right side of the dialog box.

To print, proceed as follows.

■ Using VMB Printing

- Browse **File > Print**. The **Print** dialog box will be displayed.

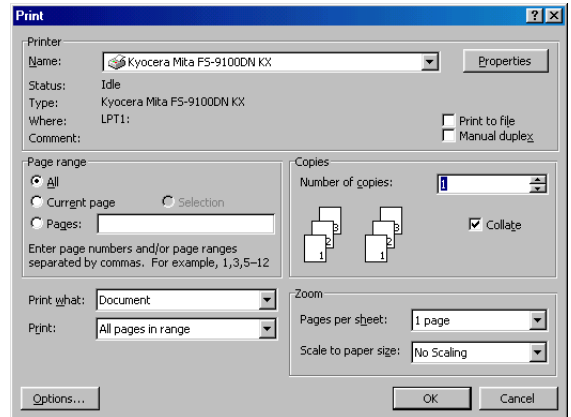

- Click on the **Name** drop down list, all the printers installed under Windows are listed. Select **Kyocera Mita FS-9100DN KX** or **Kyocera Mita FS-9500DN KX**.

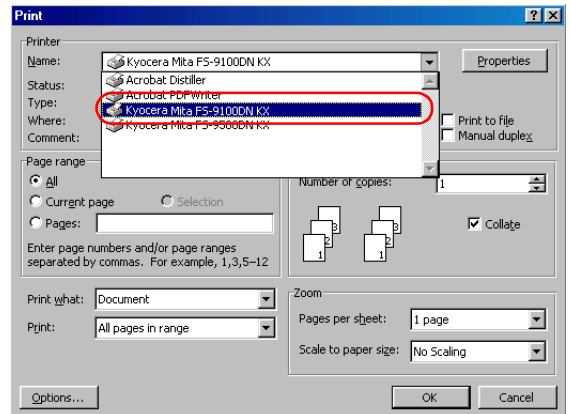

- Select the range of the pages you want to print in the document, **All** or **Current page** in **Page range**. To print part of the document, check **Pages**, then enter page numbers separated by commas.
- Specify the number of copies you want to print in the **Number of copies** combo box in **Copies**.

- Click the **Properties** button in the **Print** dialog box. The **Properties** dialog box is displayed. Click the **Output** tab and click the **Job Settings** button.

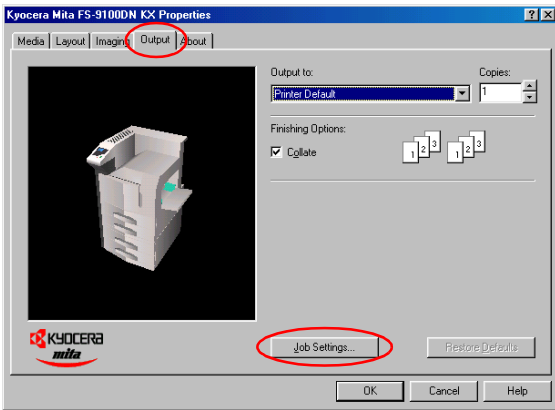

The **Job Settings** dialog box will appear.

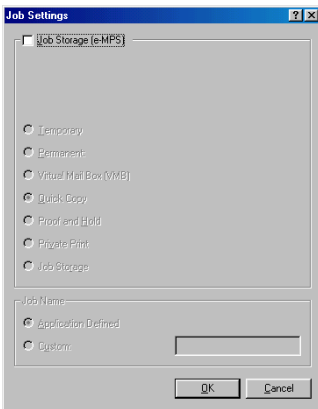

- Check the **Job Storage** checkbox, and then check the **Virtual Mail Box [VMB]**.

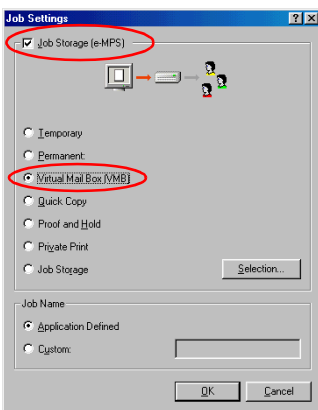

- Click the **Selection** button. The **Virtual Mailbox Selection** dialog box will appear. Select one or more mailboxes from the list of **Defined Names**.

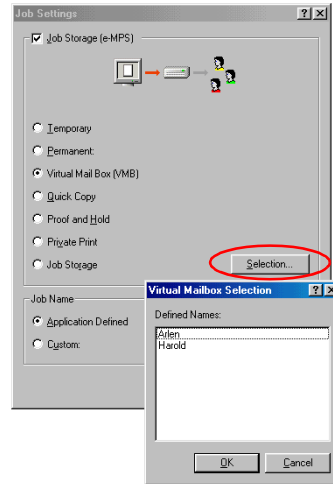

- Click the **OK** button. The **Print** dialog box is displayed again. Click the **OK** button. The print job will be stored to the hard disk without printing.

To print, use the **Print VMB Data** sub menu in the **e-MPS** menu at the printer operator panel and specify the virtual mailbox numbers. You can also print the list of virtual mailbox trays. For details, see [Chapter 3 in the Operation Guide](#).

### 3.6.3 Using Code Job

A unique number and barcode is automatically assigned to each job as it is stored on the printer. The number appears when jobs are listed in utilities such as **KM-NET Printer Disk Manager** or **KM-NET VIEWER**. The number is also printed, together with its barcode, on the code Job List. The code Job List can be printed using the **list** of **Code Job** menu of the printer. Barcode printing jobs will be displayed as code jobs on the printer operator panel.

The barcode and number can also be printed on the original document that is printed when the job is stored on the hard disk. This barcode can be printed on the first page as a code for the whole document, or on every page, so that each individual page of the document can be accessed with the barcode reader.

To print, proceed as follows.

- 1 Browse **File > Print**. The **Print** dialog box will be displayed.

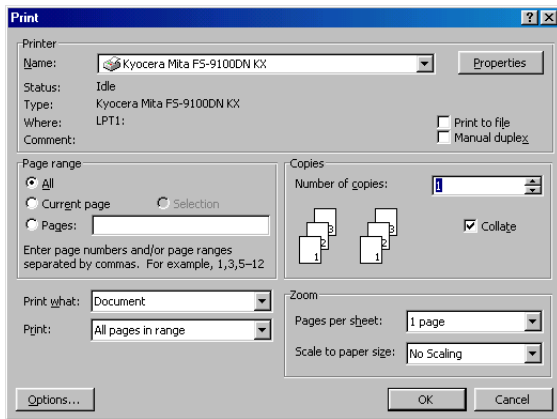

- 2 Click on the **Name** drop down list, all the printers installed under Windows are listed. Select **Kyocera Mita FS-9100DN KX** or **Kyocera Mita FS-9500DN KX**.

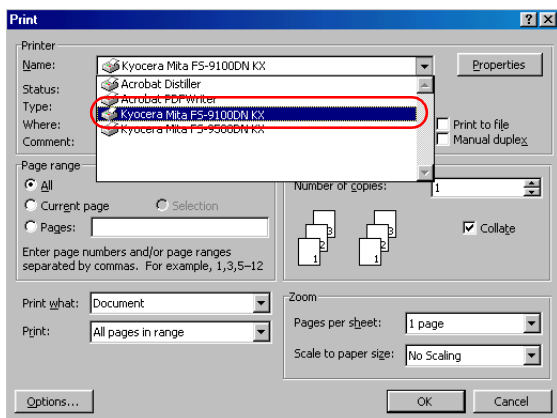

- 3 Select the range of the pages you want to print in the document, **All** or **Current page** in **Page range**. To print part of the document, check **Pages**, then enter page numbers separated by commas.
- 4 Specify the number of copies you want to print in the **Number of copies** combo box in **Copies**.

- 5 Click the **Properties** button. The **Properties** dialog box is displayed. Click the **Output** tab and click the **Job Settings** button.

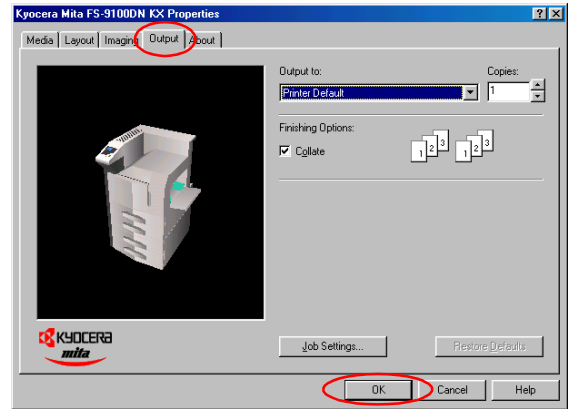

The **Job Settings** dialog box will appear.

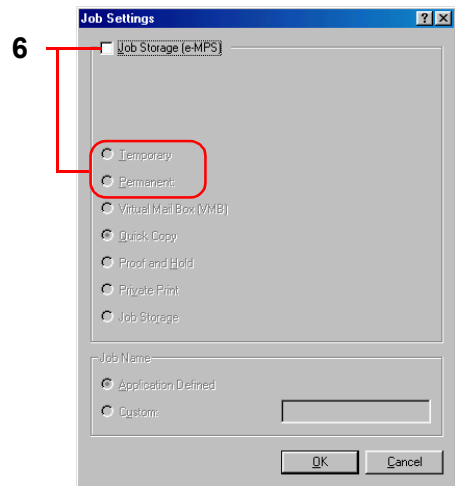

- 6 Check the **Job Storage** checkbox and then the **Temporary** or **Permanent** radio button.
- 7 When using the option barcode reader, click the **Option** button.

The **Job Storage Option** dialogbox will appear

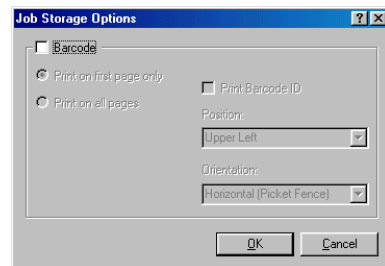

- 8 Check the **Barcode** checkbox, and then do the settings.

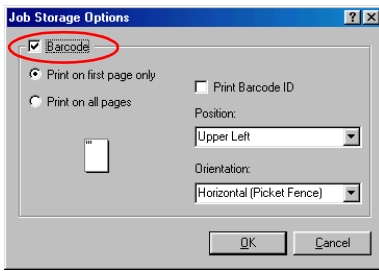

- 9 Set whether or not to print the barcode on the printouts. The barcode can also be printed in various positions on the page, with or without its code number as shown here by selecting its position in the printer driver.

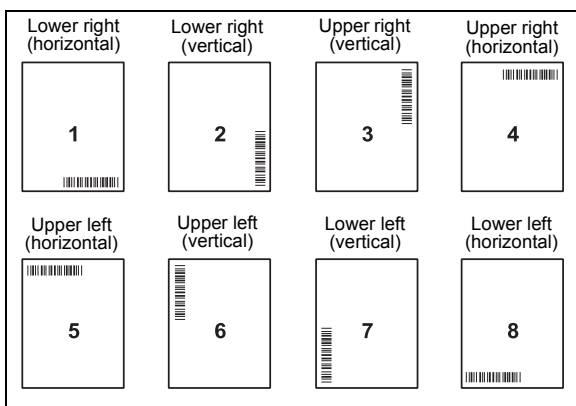

- 10 Click the **OK** button. The **Print** dialog box is displayed again. Click the **OK** button to start printing. The print job will be stored to the hard disk as it is printed.

The option barcode reader can be used to reprint the document by reading the barcode from the Job List or from the original document.

# **Kyocera Mita Corporation**

2-28, 1-Chome, Tamatsukuri, Chuo-ku  
Osaka 540-8585, Japan  
Phone: (06) 6764-3555

## Free Manuals Download Website

<http://myh66.com>

<http://usermanuals.us>

<http://www.somanuals.com>

<http://www.4manuals.cc>

<http://www.manual-lib.com>

<http://www.404manual.com>

<http://www.luxmanual.com>

<http://aubethermostatmanual.com>

Golf course search by state

<http://golfingnear.com>

Email search by domain

<http://emailbydomain.com>

Auto manuals search

<http://auto.somanuals.com>

TV manuals search

<http://tv.somanuals.com>