

SOLAR WATER PUMPING

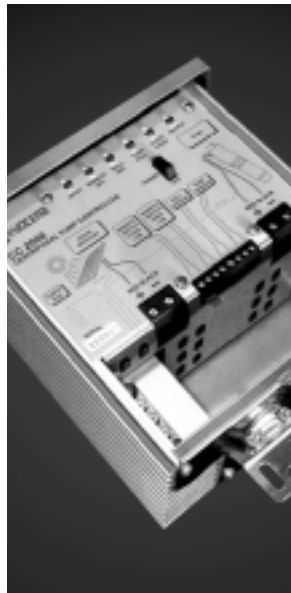

PRODUCTS CATALOG

THE NEW VALUE FRONTIER

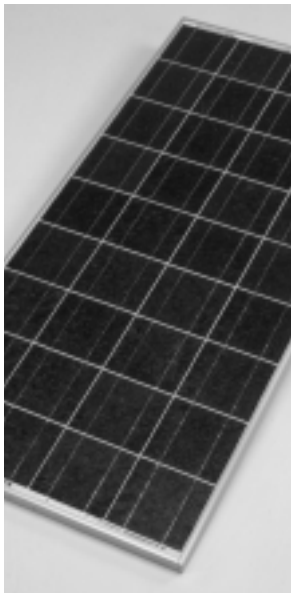

KYOCERA SOLAR, INC.

KYOCERA SOLAR PUMPS



SD 6-35 PUMP

Maximum Pump Voltage:

30 Volts

Maximum Total Dynamic Head:

35 Meters (115 Feet)

Flow at Full Depth:

6.0 lpm (1.6 gpm)



SD 3-70 PUMP

Maximum Pump Voltage:

30 Volts

Maximum Total Dynamic Head:

70 Meters (230 Feet)

Flow at Full Depth:

3.0 lpm (0.8 gpm)



SD 12-30 PUMP

Maximum Pump Voltage:

30 Volts

Maximum Total Dynamic Head:

30 Meters (100 Feet)

Flow at Full Depth:

12.0 lpm (3.15 gpm)



SC 500 SERIES

Flows Up To:

**73.8 lpm
(19.5 gpm)**

Depths Up To:

**90.0 meters
(295.0 feet)**



SC 1000 SERIES

Flows Up To:

**186.0 lpm
(49.0 gpm)**

Depths Up To:

**160.0 meters
(525.0 feet)**



CC 2000 CONTROLLER

Maximum Solar/Input Voltage:

300 Volts

Maximum Output Current:

14 Amps

Maximum Output Power:

2000 Watts



SS 100 WATER SENSOR

- Corrosion Proof
- Accurate sensing with Kyocera Controllers



CD 300 CONTROLLER

Maximum Solar/Input Voltage:

50 Volts

Maximum Output Current:

10 Amps

Maximum Output Power:

300 Watts

Greetings

Thank you for your interest in Kyocera solar electric water pumping systems and products. Water pumping and solar power are natural partners that create economic solutions for any remote water delivery application.

Kyocera Solar, Inc., with more than 18 years experience and thousands of pumps and controllers in service around the globe, is the premier solar pumping system manufacturer. Kyocera manufactures a full range of solar powered pumps and systems that are changing the way water is delivered to livestock and people when utility service is expensive, unreliable or non-existent.

At Kyocera, we take pride in being able to provide the highest quality pumping systems at the most affordable prices. This is possible because our technical breakthroughs have increased pump efficiency to record levels, decreasing the power (wattage of solar modules) necessary to deliver the required water, thereby lowering your total system cost.

Kyocera Solar supports a worldwide network of authorized dealers and distributors of solar pumping products. The company chooses the members of this network in order to achieve full customer satisfaction. These water delivery professionals can provide excellent site evaluation, system sizing and specification, installation and post-sales service.

Kyocera Solar, Inc. and its distributor network strive for superior customer service before and after the sale. Kyocera understands that trouble-free water delivery, especially in remote locations, is critical to the well being of all living things. Our job is to meet that critical need.

Visit our website for more information



Downloadable documents available at:
<http://www.kyocerasolar.com/products/waterpump.htm>

- KyoceraSDSizingUS.xls (~800k):
Sizing a domestic diaphragm pump system
- KyoceraSDSizingINT.xls (~800k):
Sizing an international diaphragm pump system
- KyoceraSCSizingUS.xls (~800k):
Sizing a domestic submersible centrifugal pump system
- KyoceraSCSizingINT.xls (~800k):
Sizing an international submersible centrifugal pump system
- KyoceraWaterPumpingCatalog.pdf (~1700k):
Current products and sizing information

For more information call
1-800-544-6466

Table of Contents

SD Diaphragm Pumps	2
CD 300 Diaphragm Pump Controller	3
SC Centrifugal Pumps	4
CC 2000 Centrifugal Pump Controller	5
Kyocera Solar Modules and Interconnects Multi-Contact (MC) Connectors	6
Balance of System	7
<i>Trackers</i>	
<i>Fixed Racks</i>	
<i>SS Series Water Sensor</i>	
<i>SS Series Splice Kit</i>	
<i>SS Series Cable</i>	
<i>SD Drop Kits</i>	
<i>Submersible Pump Cable</i>	
<i>Splice Kits</i>	
<i>SD Sand Shroud</i>	
<i>Repair Kits</i>	
<i>Float Switch</i>	
SD Pump Sizing (For approximation purposes only) ...	10
Warranty and Return Information	16

THE NEW VALUE FRONTIER



Copyright ©2003 Kyocera Solar, Inc. All Rights Reserved.

SD Series Submersible Water Pumps

- ▶ WATER DELIVERY UP TO 4.5 GPM / 17.0 LPM, PUMPING RANGE 0-230 FEET / 0-70 METERS
- ▶ HIGHEST QUALITY SUBMERSIBLE PUMP IN ITS CLASS
- ▶ FIELD SERVICEABLE WITH SIMPLE HAND TOOLS



The Kyocera SD Series of submersible solar pumps are highly efficient, low voltage, DC powered, diaphragm type positive displacement pumps designed specifically for water delivery in remote locations.

They operate on 12 to 30 volts of direct current that may be supplied from a variety of independent power sources including solar panels and/or batteries. Power requirements can be as little as 35 watts. Constructed of marine grade bronze and 304 stainless steel, these pumps are the highest quality submersible pumps in their class.

Kyocera's SD series pumps can be installed below water level in a pond, river or cistern, or installed by hand into a ground water well. They can be used to fill an open tank or in a pressurized water delivery system.

Simplicity is the key feature of the SD series pumps. They are easy to install, require very little maintenance and are completely field serviceable.

The SD series pumps are designed for use in **stand alone** water delivery systems. They are pollution-free, corrosion-resistant and quiet. It is the ideal way to provide water for livestock, remote homes, campsites, small farms or any other need beyond the commercial power grid.

Model SD 3-70 P/N 85221

Model SD 6-35 P/N 85222

Suitable for installation in 4.0 inch (100.0 mm) minimum inside diameter wells. The addition of a sand shroud requires installation in 5.0 inch (127.0 mm) minimum inside diameter wells. Flow rates up to 2.4 GPM (9.0 LPM) and heads up to 230 feet (70.0 meters).

Dimensions (Diameter, Length, Weight): 3.8 in. (96.0 mm), 10.75 in. (273.0 mm), 21.0 lbs. (9.5 kg)

Pump Outlet Connection Size: 1/2" NPT (SIDR 11.5, 125 psi, Polyethylene tube recommended)

Model SD 12-30 P/N 85220

Suitable for installation in 5.0 inch (127.0 mm) minimum inside diameter wells. The addition of a sand shroud requires installation in 6.0 inch (152.0 mm) minimum inside diameter wells. Flow rates up to 4.5 GPM (17.0 LPM) and heads up to 100 feet (30.0 meters).

Dimensions (Diameter, Length, Weight): 4.62 in. (117.35 mm), 10.75 in. (273.0 mm), 23.4 lbs. (10.6 kg)

Pump Outlet Connection Size: 3/4" NPT (SIDR 15, 100 psi, Polyethylene tube recommended)

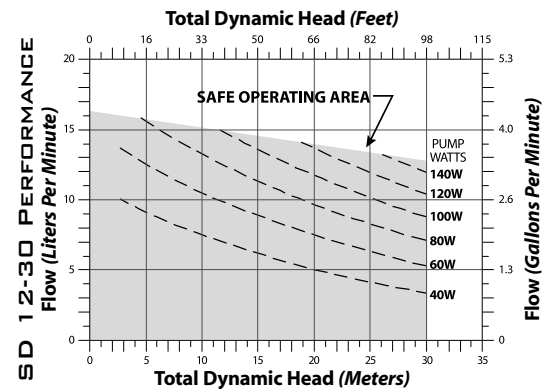
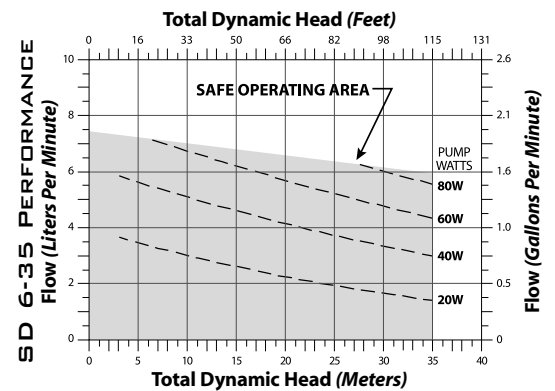
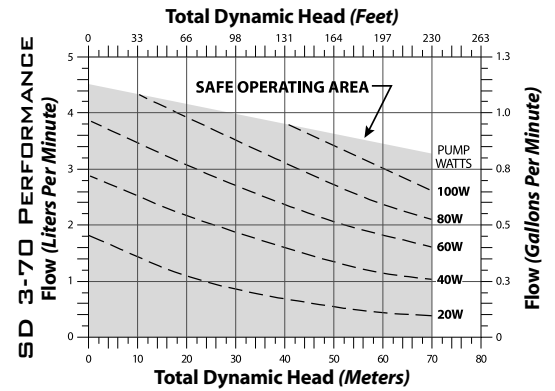



CD 300 Pump Controller

- ▶ FOR SD SERIES PUMPS
- ▶ ACCOMMODATES ARRAYS WITH ONE OR TWO 36-CELL MODULES IN SERIES; WILL OPERATE FROM 12 OR 24 VOLT BATTERY BANKS
- ▶ MAXIMUM POWER POINT TRACKING
- ▶ SELF PROGRAMMING OPERATION
- ▶ CURRENT OR VOLTAGE BOOSTING
- ▶ SELF DIAGNOSTIC
- ▶ SIMPLIFIED CONTROL AND TROUBLESHOOTING
- ▶ LED INDICATORS PROVIDE CONVENIENT INFORMATION ABOUT VOLTAGES, SWITCH AND SENSOR STATUS AND OVERLOAD CONDITIONS

The CD 300 pump controller is designed to connect solar modules to Kyocera Solar’s SD series submersible diaphragm pumps. The controller provides current or voltage boosting combined with true Maximum Power Point Tracking (MPPT) of the solar modules. The pump controller’s microprocessor, using true MPPT, constantly monitors the incoming solar power and boosts current or voltage to operate the solar modules at their peak power point and maximize pump output. The controller is entirely self configuring and requires no setup or adjustment by the user to ensure proper operation.

The CD 300 controller will accommodate one or two 36-cell modules in series. Other combinations of modules can be used as long as the total Open Circuit Voltage (VOC) does not exceed 50 Volts. Modules can be wired in parallel to maximize daily water production. Highest efficiencies (94-98%) will be attained when the solar modules are wired in series for operation between 30-42 Volts. However, single modules, such as a KC120, can also be used, maintaining controller efficiencies over 92%.

In addition to solar modules, the controller will also operate the pump using 12 or 24 Volt battery banks as a power source. The CD 300 controller will also work with any permanent magnet positive displacement pump rated for 30 Volts with 10 Amps maximum current draw.

The controller’s unique design simplifies control and troubleshooting of pumping. Inputs are provided for remote switches and Kyocera Solar’s unique water level sensor. Indicators provide convenient information about voltages, switch and sensor status, and overload conditions.

Kyocera Solar’s newly designed pump controller is user friendly. It is designed to provide maximum power under varying conditions and requires no programming by the user. We are proud to introduce the Kyocera Solar line of pump controllers and are confident you will be satisfied.

Model CD 300 **P/N 85223**
 Shipping Weight: 10.0 lbs.(4.54 kg)

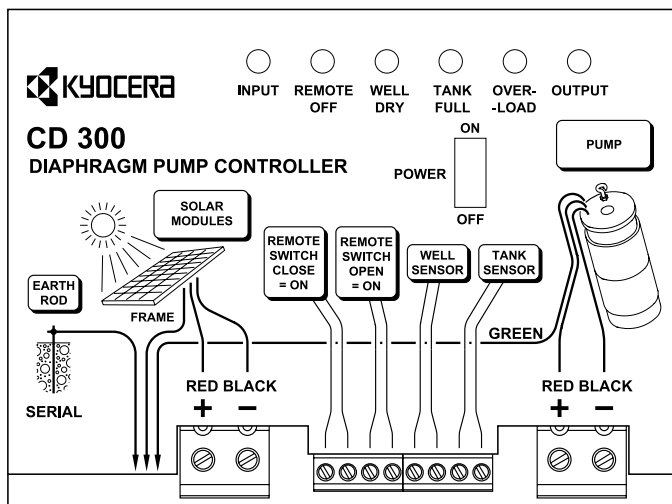

Description	Value
Maximum Ambient Temperature	50° C
Minimum Ambient Temperature	-20° C
Maximum Solar/Input Voltage (total VOC @ -20°C)	50 Volts
Max. Output Current - Current Boost Mode (input voltage greater than output voltage)	10 Amps
Max. Output Power - Current Boost Mode (input voltage greater than output voltage)	300 Watts
Max. Output Current - Voltage Boost Mode (input voltage greater than output voltage)	5 Amps
Max. Output Power - Voltage Boost Mode (input voltage greater than output voltage)	150 Watts
Input Current Limiting	12 Amps
High Temperature Protection (shutdown temperature at heatsink)	85° C
Solar and Pump Wire Sizes	0.5 - 16 mm ² (6 - 20 AWG)
Sensor and Remote Switch Wire Sizes	0.2 - 2.5 mm ² (14 - 24 AWG)

SC Series Submersible Water Pumps

- ▶ WATER DELIVERY UP TO 43 GPM / 162 LPM,
PUMPING RANGE 0-525 FEET / 0-160 METERS
- ▶ BRUSHLESS, PERMANENT MAGNET MOTOR
WITH MULTI-STAGE CENTRIFUGAL PUMP END
- ▶ CORROSION-RESISTANT, PERMANENTLY
LUBRICATED AND MAINTENANCE FREE

The Kyocera SC Series of submersible solar pumps are high quality, maintenance-free, DC powered pumps designed specifically for water delivery in remote locations.

They operate on 140 to 1000 watts of direct current at 60 to 120 volts. The power may be supplied from a variety of independent sources including solar modules and/or batteries.

The motors are state of the art, brushless DC, permanent magnet type constructed from marine grade bronze and 304 stainless steel. Designed with a pump motor face, they bolt directly to standard 4.0 inch diameter submersible pump ends. Internal pressure equalization allows motor submergence to any depth without damage to seals.

The pump ends are multi-stage centrifugal. They are manufactured by Goulds Pumps, Inc., constructed from 304 stainless steel and plastics. The impellers and diffusers are constructed from a rugged thermoplastic and are extremely resistant to mineral and algae deposits. Field replacement of the pump end is easily accomplished without the use of specialized tools.

The SC series pumps can be installed below the water level in a well, lake, river or cistern. They can be used to fill open tanks or used to pressurize water systems with heads up to 550 feet (167 meters). They are designed for use in **stand alone** water delivery systems. They are pollution-free, corrosion-resistant, permanently lubricated and quiet. There is no better way to provide water for livestock, remote homes, campsites, small farms or any other need beyond the commercial power grid.



Part Number	Model Number	Optimal Flow GPM (LPM)	Optimal Head Feet (Meters)	Power (Watts)	Diameter in (cm)	Total Length in (cm)	Total Weight lbs (kg)	Pump Outlet Connection Size
85750	SC 500 15-60	3.70 (14)	203.4 (62)	500	3.75 (9.53)	26.4 (67.1)	26.0 (11.8)	1-1/4" NPT
85751	SC 500 25-40	6.08 (23)	137.8 (42)	500	3.75 (9.53)	25.2 (64.0)	25.0 (11.4)	1-1/4" NPT
85752	SC 500 35-35	9.25 (35)	108.3 (33)	500	3.75 (9.53)	22.9 (58.2)	25.0 (11.4)	1-1/4" NPT
85753	SC 500 40-25	11.1 (42)	88.6 (27)	500	3.75 (9.53)	21.5 (54.6)	24.0 (10.9)	1-1/4" NPT
85754	SC 1000 15-105	4.49 (17)	374.0 (114)	1000	3.75 (9.53)	33.4 (84.7)	33.0 (14.8)	1-1/4" NPT
85755	SC 1000 25-85	6.34 (24)	315.0 (96)	1000	3.75 (9.53)	31.7 (80.4)	32.0 (14.3)	1-1/4" NPT
85756	SC 1000 35-70	8.98 (34)	236.2 (72)	1000	3.75 (9.53)	27.8 (70.5)	31.0 (13.9)	1-1/4" NPT
85757	SC 1000 45-60	11.62 (44)	193.6 (59)	1000	3.75 (9.53)	26.4 (70.0)	29.0 (13.0)	1-1/4" NPT
85758	SC 1000 60-45	16.11 (61)	147.6 (45)	1000	3.75 (9.53)	26.4 (70.0)	29.0 (13.0)	1-1/4" NPT
85759	SC 1000 105-30	22.45 (106)	98.4 (30)	1000	3.75 (9.53)	27.6 (70.1)	31.0 (13.9)	2" NPT



CC 2000 Pump Controller

- ▶ FOR SC SERIES PUMPS
- ▶ ACCOMMODATES ARRAYS WITH TWO TO TWELVE 36-CELL MODULES IN SERIES; WILL OPERATE FROM 24 TO 144 VOLT BATTERY BANKS
- ▶ MAXIMUM POWER POINT TRACKING
- ▶ SELF PROGRAMMING OPERATION
- ▶ CURRENT BOOSTING
- ▶ SELF DIAGNOSTIC
- ▶ SIMPLIFIED CONTROL AND TROUBLESHOOTING
- ▶ LED INDICATORS PROVIDE CONVENIENT INFORMATION ABOUT VOLTAGES, SWITCH AND SENSOR STATUS AND OVERLOAD CONDITIONS

The CC 2000 pump controller is designed to connect solar modules to Kyocera Solar’s SC series submersible motors and centrifugal pumps. The controller provides current boosting combined with true Maximum Power Point Tracking (MPPT) of the solar modules. The pump controller’s microprocessor constantly monitors the incoming solar power and boosts current to operate the solar modules at their peak power point and maximize pump output. The controller is entirely self-configuring and requires no setup or adjustment by the user to ensure proper operation.

The CC 2000 controller will accommodate two to twelve solar modules in series. Any combination of modules can be used as long as the total Open Circuit Voltage (VOC) does not exceed 300 Volts. Strings of modules can be wired in parallel to maximize daily water production.

In addition to solar modules, the controller will also operate from 24 to 144 Volt battery banks for use in a broad range of applications. The CC 2000 controller is only intended for use with Kyocera Solar’s SC series of motors.

The controller’s unique design simplifies control and troubleshooting of pumping systems. Inputs are provided for remote switches and Kyocera Solar’s unique water level sensor. Indicators provide convenient information about voltages, switch and sensor status, and overload conditions.

Kyocera Solar’s newly designed pump controller is user friendly. It is designed to provide maximum power under varying conditions and requires no programming by the user. We are proud to introduce the Kyocera Solar line of pump controllers and are confident you will be satisfied.

Model CC 2000 **P/N 85224**

Shipping Weight: 10.0 lbs.(4.54 kg)

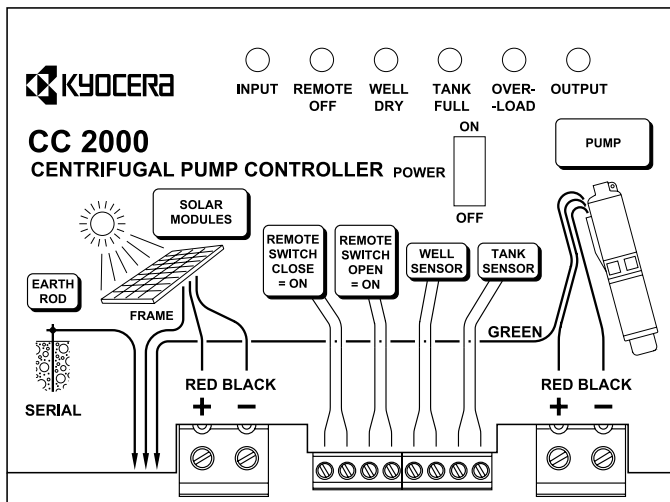

Description

Description	Value
Maximum Ambient Temperature	50° C
Minimum Ambient Temperature	-20° C
Maximum Solar/Input Voltage (total VOC @ -20°C)	300 Volts
Max. Output Current - Current Boost Mode (input voltage greater than output voltage)	14 Amps
Max. Output Power - Current Boost Mode (input voltage greater than output voltage)	2000 Watts
Input Current Limiting	15 Amps
High Temperature Protection (shutdown temperature at heatsink)	85° C
Solar and Pump Wire Sizes	0.5 - 16 mm ² (6 - 20 AWG)
Sensor and Remote Switch Wire Sizes	0.2 - 2.5 mm ² (14 - 24 AWG)

Kyocera Solar Modules

- ▶ HIGH EFFICIENCY MULTICRYSTAL MODULES
- ▶ CONSISTENT, RELIABLE TIME PROVEN PRODUCTS
- ▶ CELL EFFICIENCY OVER 14%
- ▶ UL LISTED
- ▶ 6 INCH CELL MODULES
- ▶ LOW IRON, TEMPERED GLASS, EVA ENCAPSULANT AND ANODIZED ALUMINUM FRAME CONSTRUCTION
- ▶ 25 YEAR OUTPUT WARRANTY

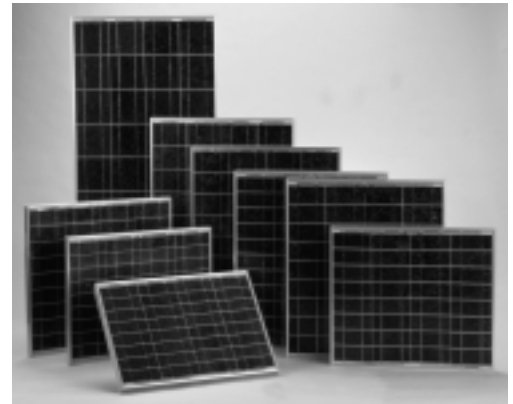

Model	KC125G	KC120	KC80	KC70	KC60	KC50	KC40
Rated Power (Watts)	125.0	120.0	80.0	70.0	60.0	50.0	40.0
Current at Max. Power (Amps)	7.2	7.1	4.73	4.14	3.55	3.00	2.34
Voltage at Max. Power (Volts)	17.4	16.9	16.9	16.9	16.9	16.7	16.9
Short Circuit Current (Amps)	8.0	7.45	4.97	4.35	3.73	3.1	2.48
Open Circuit Current (Volts)	21.7	21.5	21.5	21.5	21.5	21.5	21.5
Length (Inches)	56.0	56.0	38.4	34.1	29.6	25.2	20.7
Width (Inches)	25.7	25.7	25.7	25.7	25.7	25.7	25.7
Depth (Inches)	2.0	2.0	2.0	2.2	2.0	2.1	2.0
Shipping Weight (Lbs.)	30.0	30.0	25.0	19.0	20.0	16.0	16.0
Part Number (P/N)	15425	15484	15483	15474	15482	15473	15472

All Specification at 25°C. Wattage rating are + or - 5%.

Interconnects

- ▶ AN IMPORTANT PART OF SYSTEM WIRING IS PROPER MODULE CONNECTION THAT EXHIBITS THE HIGHEST DEGREE OF RELIABILITY AND PERFORMANCE IN SEVERE CLIMATES
- ▶ ALL ARE PRE-ASSEMBLED, FEATURING TIN-PLATED COPPER FORK TERMINALS FOR #10 STUD, CRIMPED AND SOLDERED TO #10 AWG STRANDED COPPER WIRE WITH ADHESIVE "MELT-WALL" SHRINK TUBING HEAT SEALED OVER THE CRIMP CONNECTION

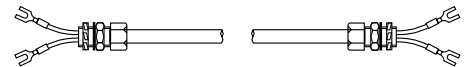

10-2 x 30 Inch Cable Assembly P/N 43605
 30.0 in. (76.2 cm)

- ▶ THE FOLLOWING WIRE HARNESSES ARE TERMINATED ON ONE OR BOTH ENDS WITH UL-LISTED MULTI-CONTACT (MC) CONNECTORS. CABLE ASSEMBLIES ARE MADE WITH UL-LISTED, 600 VOLT, MULTI-STRANDED, #10 AWG RHH/RHW/USE-2, OUTDOOR-RATED, SUNLIGHT-RESISTANT CABLE.

10-1 x 10 Foot MC Connector (One male end / one female end) P/N 98503
 120.0 in. (304.8 cm)

10-1 x 30 Foot MC Connector (One male end / one female end) P/N 98502
 360.0 in. (914.4 cm)

Trackers

- ▶ PASSIVE TRACKERS CAN INCREASE WATER DELIVERY BY 50% OR MORE
- ▶ ADJUSTABLE SINGLE-AXIS PASSIVE SOLAR TRACKER FOLLOWS THE SUN BY HEATED LIQUID FLOWING BETWEEN EAST AND WEST SEALED CANISTERS

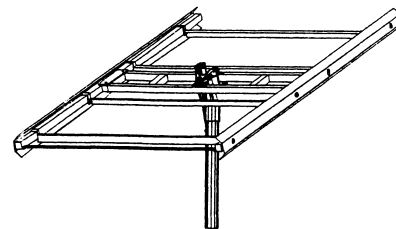

Unirac Tracker 200 - 2.5 in. pipe	P/N 24500
For any two KC modules.	
Zomeworks UTR020 - 2.5 in. pipe	P/N 20370
For any one or two KC modules.	
Zomeworks UTR040 - 3.0 in. pipe	P/N 20371
For any four KC modules.	
Zomeworks UTRF64 - 6.0 in. pipe	P/N 20382
For any eight KC modules, except KC120.	
Zomeworks UTRF90 - 6.0 in. pipe	P/N 20391
For eight KC120 modules.	
Zomeworks UTRF120 - 6.0 in. pipe	P/N 20392
For sixteen KC60, KC70 or KC80 modules.	

Note: Vertical pipe is not included.

Fixed Racks

- ▶ MOUNTS ARE STEEL CONSTRUCTION FOR POLE GIMBAL AND STRONG-BACK TUBING
- ▶ SOLAR MODULE ATTACHMENT RAILS ARE ALUMINUM ANGLE

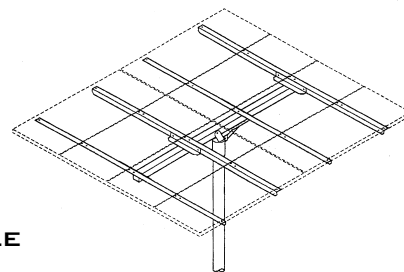

Unirac U-22/28M - 2.5 in. pipe	P/N 23299
For one KC60, KC70 or KC80 module.	
Unirac U-22/28XL - 2.5 in. pipe	P/N 24281
For one KC120 module.	
Unirac U-22/52M - 3.0 in. pipe	P/N 23297
For two KC60, KC70 or KC80 modules.	
Unirac U-22/52XL - 3.0 in. pipe	P/N 23301
For two KC120 modules.	
Unirac U-PT 52S - 4.0 in. pipe	P/N 23352
For four KC60, KC70 or KC80 modules.	
Unirac U-PT 52L - 4.0 in. pipe	P/N 24400
For four KC120 modules.	
Unirac U-PT 104S - 4.0 in. pipe	P/N 23359
For eight KC60, KC70 or KC80 modules.	
Unirac U-PT 104L - 6.0 in. pipe	P/N 23333
For eight KC120 modules.	

Note: Vertical pipe is not included.

SS Series Water Sensor

- ▶ NON-CORROSIVE, DRY RUN PRODUCTION SENSOR: GLASS AND PLASTIC CONSTRUCTION (SEE PAGE 10)
- ▶ COMPATIBLE WITH CD 300 AND CC 2000 CONTROLLERS ONLY
- ▶ ONE SENSOR REQUIRED PER WELL OR TANK APPLICATION
- ▶ SENSOR PROVIDED WITH THREE LENGTHS OF ATTACHED CABLE (75', 150', 250')

SS-75 Water Sensor	P/N 85229
SS-150 Water Sensor	P/N 85230
SS-250 Water Sensor	P/N 85231

SS Series Water Sensor Splice Kit

- ▶ USED FOR SPLICING SS SERIES WATER SENSOR CABLE (P/N 43397)
- ▶ 18 AWG - 22 AWG (0.50 MM² - 0.75 MM²)
- ▶ INCLUDES BUTT SPLICES AND ADHESIVE LINED SHRINK TUBE

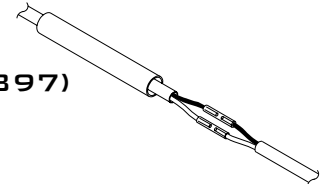

SS Series Water Sensor Splice Kit	P/N 85235
---	-----------

SS Series Water Sensor Cable

- ▶ USED WITH SS SERIES WATER SENSOR IN WELLS DEEPER THAN 250'
- ▶ SS SERIES SPLICE KIT REQUIRED (P/N 85235)
- ▶ #20 AWG - 2 CONDUCTOR WITH POLYPROPYLENE INSULATION
- ▶ SOLD IN 50' INCREMENTS (I.E.: 50', 100', 150')

SS Series Water Sensor Cable	P/N 43397
------------------------------------	-----------

SD 6-35/3-70 Drop Kit

- ▶ 1/2" POLYETHYLENE TUBE
- ▶ PUMP CABLE - RED, BLACK AND GREEN COLOR CODE
- ▶ SAFETY ROPE
- ▶ 1/2" NPT FITTING KIT (HOSE BARB, HOSE CLAMP, 90° ELBOW)

50' Tube, 75' 12-2 Cable	P/N 85254
100' Tube, 125' 12-2 Cable	P/N 85258
150' Tube, 175' 10-2 Cable	P/N 85262
200' Tube, 225' 10-2 Cable	P/N 85266
250' Tube, 275' 10-2 Cable	P/N 85268

SD 12-30 Drop Kit

- ▶ 3/4" POLYETHYLENE TUBE
- ▶ PUMP CABLE - RED, BLACK AND GREEN COLOR CODE
- ▶ SAFETY ROPE
- ▶ 3/4" NPT FITTING KIT (HOSE BARB, HOSE CLAMP, 90° ELBOW)

50' Tube, 75' 12-2 Cable	P/N 85272
100' Tube, 125' 10-2 Cable	P/N 85276

Submersible Pump Cable

- ▶ RED, BLACK AND GREEN COLOR CODE - IDEAL FOR DC PUMPS
- ▶ SOLD IN 50' INCREMENTS (I.E.: 50', 100', 150')

#12 AWG (4 mm ²)	P/N 43403
#10 AWG (6 mm ²)	P/N 43433
#8 AWG (10 mm ²)	P/N 43423
#6 AWG (16 mm ²)	P/N 43453

SD Series Splice Kit

- ▶ USED FOR SPLICING PUMP CABLE
- ▶ #10 AWG - 12 AWG (4.0 MM² - 6.0 MM²)
- ▶ INCLUDES BUTT SPLICES AND ADHESIVE LINED SHRINK TUBE

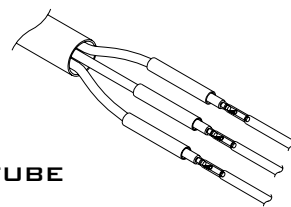

SD Series Splice Kit P/N 85946

SC Series Splice Kit

- ▶ USED FOR SPLICING PUMP CABLE
- ▶ #6 AWG - 12 AWG (4.0 MM² - 16.0 MM²)
- ▶ INCLUDES BUTT SPLICES AND ADHESIVE LINED SHRINK TUBE

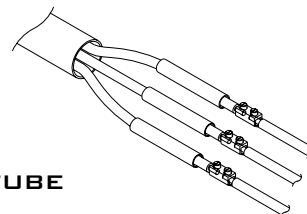

SC Series Splice Kit P/N 85902

SD 6-35/3-70 Sand Shroud

- ▶ ELIMINATES DESTRUCTIVE SAND INTRUSION
- ▶ EASY INSTALLATION INCLUDING RETROFIT
- ▶ CONSTRUCTED OF RUGGED PVC AND POLYETHYLENE
- ▶ REUSABLE NYLON COATED STAINLESS STEEL TIES INCLUDED
- ▶ DIMENSIONS: 4.5" OD X 30.0" (REQUIRES 5" WELL)
- ▶ COMPATIBLE WITH KYOCERA SD 6-35 AND SD 3-70 PUMPS ONLY



SD 6-35/3-70 Sand Shroud P/N 85226

SD 12-30 Sand Shroud

- ▶ ELIMINATES DESTRUCTIVE SAND INTRUSION
- ▶ EASY INSTALLATION INCLUDING RETROFIT
- ▶ CONSTRUCTED OF RUGGED PVC AND POLYETHYLENE
- ▶ REUSABLE NYLON COATED STAINLESS STEEL TIES INCLUDED
- ▶ DIMENSIONS: 5.6" OD X 30.0" (REQUIRES 6" WELL)
- ▶ COMPATIBLE WITH KYOCERA SD 12-30 PUMP ONLY

SD 12-30 Sand Shroud P/N 85225

SD Series Repair Kit

- ▶ MINOR REPAIR KITS CONTAIN ALL ITEMS NECESSARY FOR RECOMMENDED MAINTENANCE
- ▶ MAJOR REPAIR KITS CONTAIN ALL ITEMS NECESSARY TO COMPLETELY OVERHAUL THE PUMP

SD 12-30 Minor Repair Kit P/N 86100

SD 6-35 Minor Repair Kit P/N 86110

SD 3-70 Minor Repair Kit P/N 86120

SD 12-30 Major Repair Kit P/N 86105

SD 6-35 Major Repair Kit P/N 86115

SD 3-70 Major Repair Kit P/N 86125

Float Switch

- ▶ USED IN STORAGE TANKS TO SHUT DOWN THE PUMP WHEN THE TANK IS FULL

Close on rise P/N 85931

Open on rise P/N 85932

Designing a Solar Pumping System

There are many aspects of designing a solar pumping system. This guide provides the information to correctly select a pump, controller, sensors, solar array, wiring, and pipe. The process is broken down into the following steps:

STEP 1 - Estimate the amount of water needed per day (~GPM x 360).

STEP 2 - Calculate the TOTAL DYNAMIC HEAD (TDH).

STEP 3 - Determine the Solar Resource for your location. (See page 15)

STEP 4 - Select the pump, controller, mounting method and array.

STEP 5 - Select the correct pump cable.

STEP 6 - Select the appropriate accessories.

$$TDH = \text{Standing Water Level} + \text{Draw Down} + \text{Elevation} + 2.3 \times \text{Tank Pressure} + \text{Friction}$$

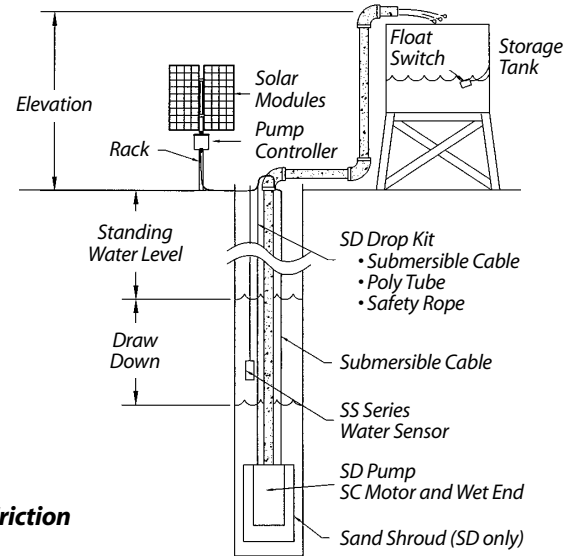

EXAMPLE

System Conditions

Desired TOTAL DAILY OUTPUT:	7000 liters per day (1847 gallons per day)
TOTAL DYNAMIC HEAD:	10 meters (33 feet)
Location Provides:	6-7 Sun Hours On Tilt (See page 15)
Well Diameter:	15.2 cm (6 inches)
Water Condition:	sandy

1. Select a pump that will provide the most water at the TOTAL DYNAMIC HEAD. The SD 12-30 will provide the most water.
2. Consider the sand shroud. This pump will require a sand shroud because the well is sandy.
3. Consider the diameters. The SD 12-30 with a sand shroud requires a well with a minimum diameter of 15.2 cm. The SD 12-30, with a sand shroud, will fit in this application.
4. Using the SD 12-30 PERFORMANCE GRAPH (marked "EXAMPLE"), locate the desired liters per day (TOTAL DAILY OUTPUT) on the lower left side of the graph, point A.
5. The system TDH equals 10 meters. Draw a line to the right until it crosses the "10 meter TOTAL DYNAMIC HEAD" line, point B.
6. The system SUN HOURS ON TILT equals 6-7. From point B, draw a vertical line upward until it crosses the "6-7 SUN HOURS ON TILT" line, point C.
7. Draw a horizontal line through point C. Point D shows the required array wattage and point E shows the quantity and model of Kyocera modules that will provide required amount of water. This system will provide the desired amount of water with two KC80 solar modules. If point E does not directly intersect an array configuration, the next largest array should be selected.

IMPORTANT NOTES:

1. The array wattage listed on the graph is the total of the nameplate wattage ratings of the solar modules at STC (STANDARD TEST CONDITIONS). The performance charts are corrected for operation in a hot climate, such as Phoenix, Arizona. In cooler climates actual performance will be better.
2. Under no circumstances should more than 2 modules be placed in any series string. The MAXIMUM INPUT VOLTAGE for the CD 300 Pump Controller is 50 Volts. Under certain conditions, a solar module can produce almost 25 Volts.

NOTE: The pump performance shown on the following charts represents actual system output in real applications. The performance has been de-rated for dirt and temperature losses on the solar modules, power losses in wiring, and other system losses. Other manufactures may not take these factors into consideration when advertising their pumps or systems. This makes comparison to other pumps difficult. These charts are provided so that you can design a system that performs up to the expectations of the customer. In most cases, the actual system will perform better than the charts suggest.

*For approximation purposes only. For more accurate sizing, see sizing software at www.kyocerasolar.com/products/waterpump.htm

SD 12-30 PERFORMANCE GRAPH

example

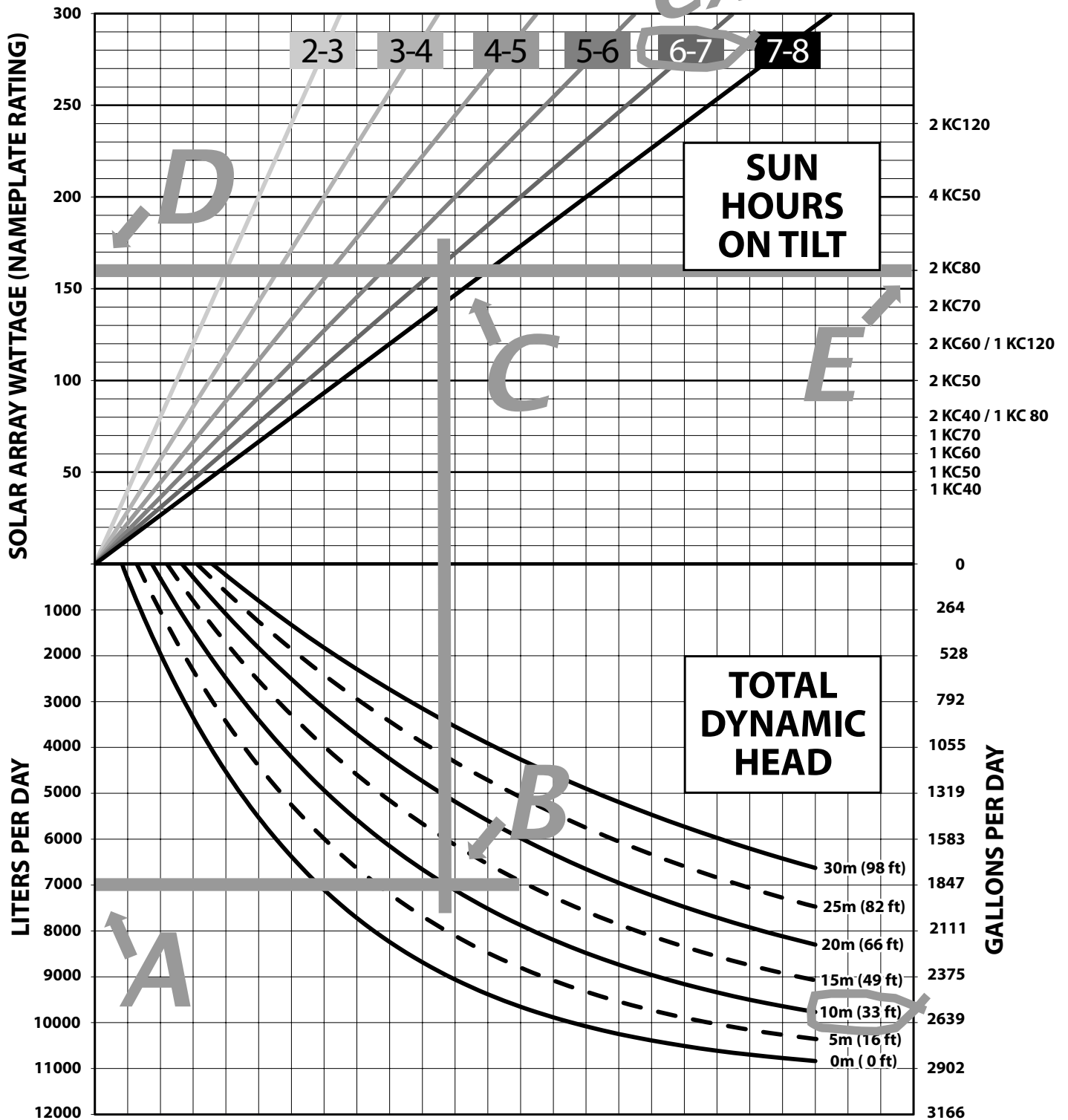

NOTE:

- SD series systems require a CD 300 Pump Controller to provide the performance as shown.
- Single, 12 Volt module systems require CD 300 Pump Controller to operate at full power.
- Systems using 2 solar modules should be wired with the solar modules in series.
- Systems using 4 modules or more should be wired series/parallel. Modules should be connected first in strings of 2 modules in series. These strings should then be paralleled to achieve the required power.

*For approximation purposes only. For more accurate sizing, see sizing software at www.kyocerasolar.com/products/waterpump.htm

SD 12-30 PERFORMANCE GRAPH

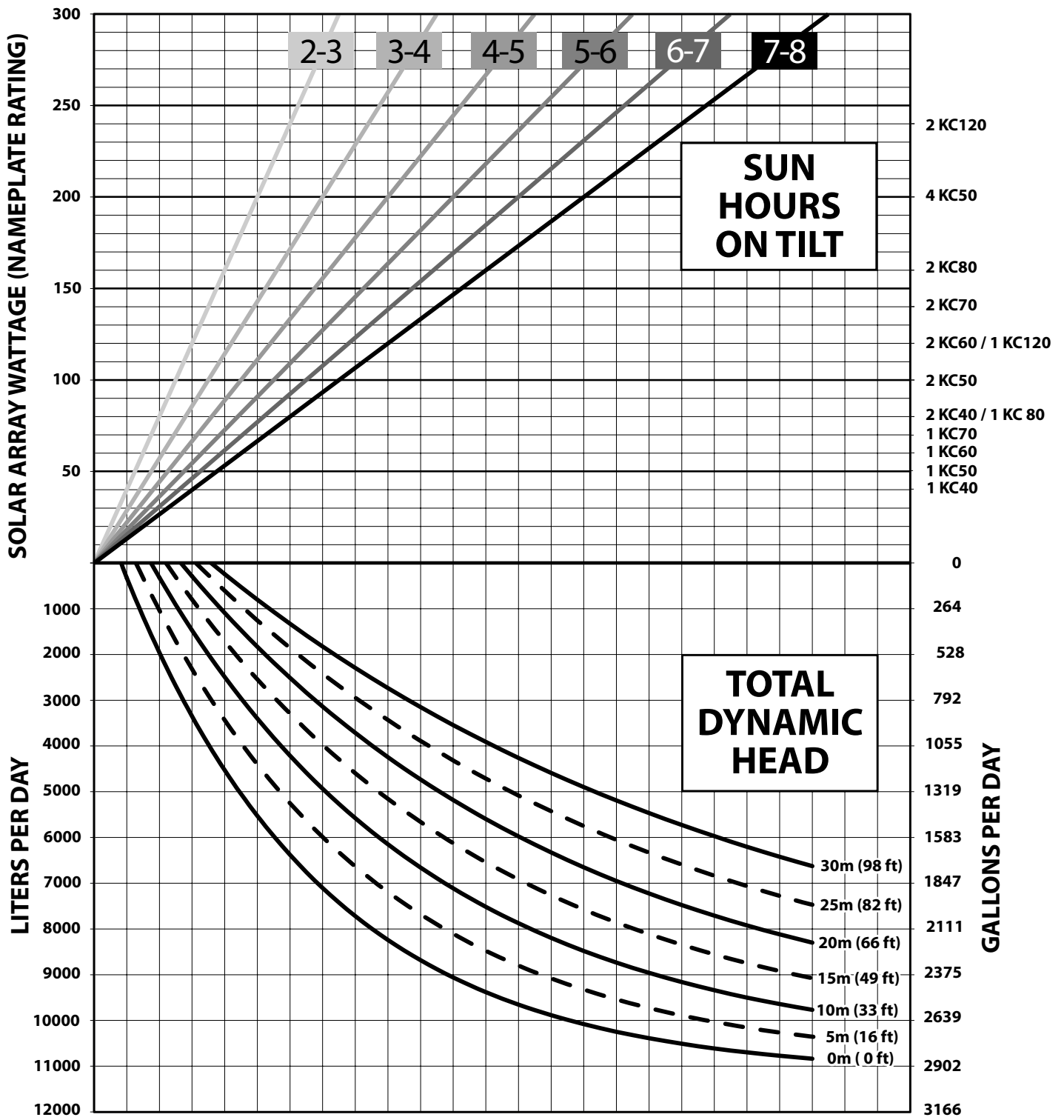

NOTE:

1. SD series systems require a CD 300 Pump Controller to provide the performance as shown.
2. Single, 12 Volt module systems require CD 300 Pump Controller to operate at full power.
3. Systems using 2 solar modules should be wired with the solar modules in series.
4. Systems using 4 modules or more should be wired series/parallel. Modules should be connected first in strings of 2 modules in series. These strings should then be paralleled to achieve the required power.

*For approximation purposes only. For more accurate sizing, see sizing software at www.kyocerasolar.com/products/waterpump.htm

SD 6-35 PERFORMANCE GRAPH

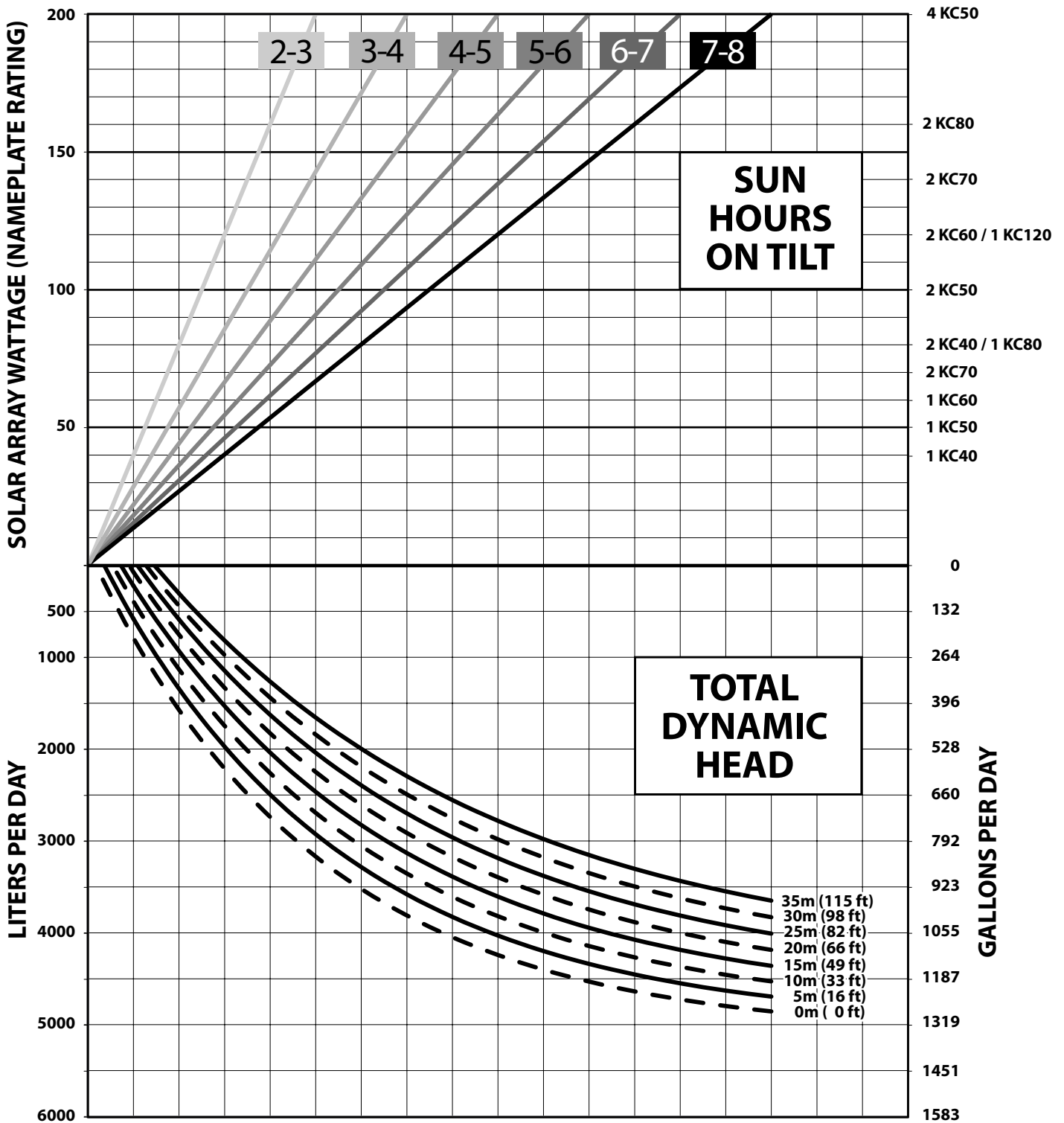

NOTE:

1. SD series systems require a CD 300 Pump Controller to provide the performance as shown.
2. Single, 12 Volt module systems require CD 300 Pump Controller to operate at full power.
3. Systems using 2 solar modules should be wired with the solar modules in series.
4. Systems using 4 modules or more should be wired series/parallel. Modules should be connected first in strings of 2 modules in series. These strings should then be paralleled to achieve the required power.

*For approximation purposes only. For more accurate sizing, see sizing software at www.kyocerasolar.com/products/waterpump.htm

SD 3-70 PERFORMANCE GRAPH

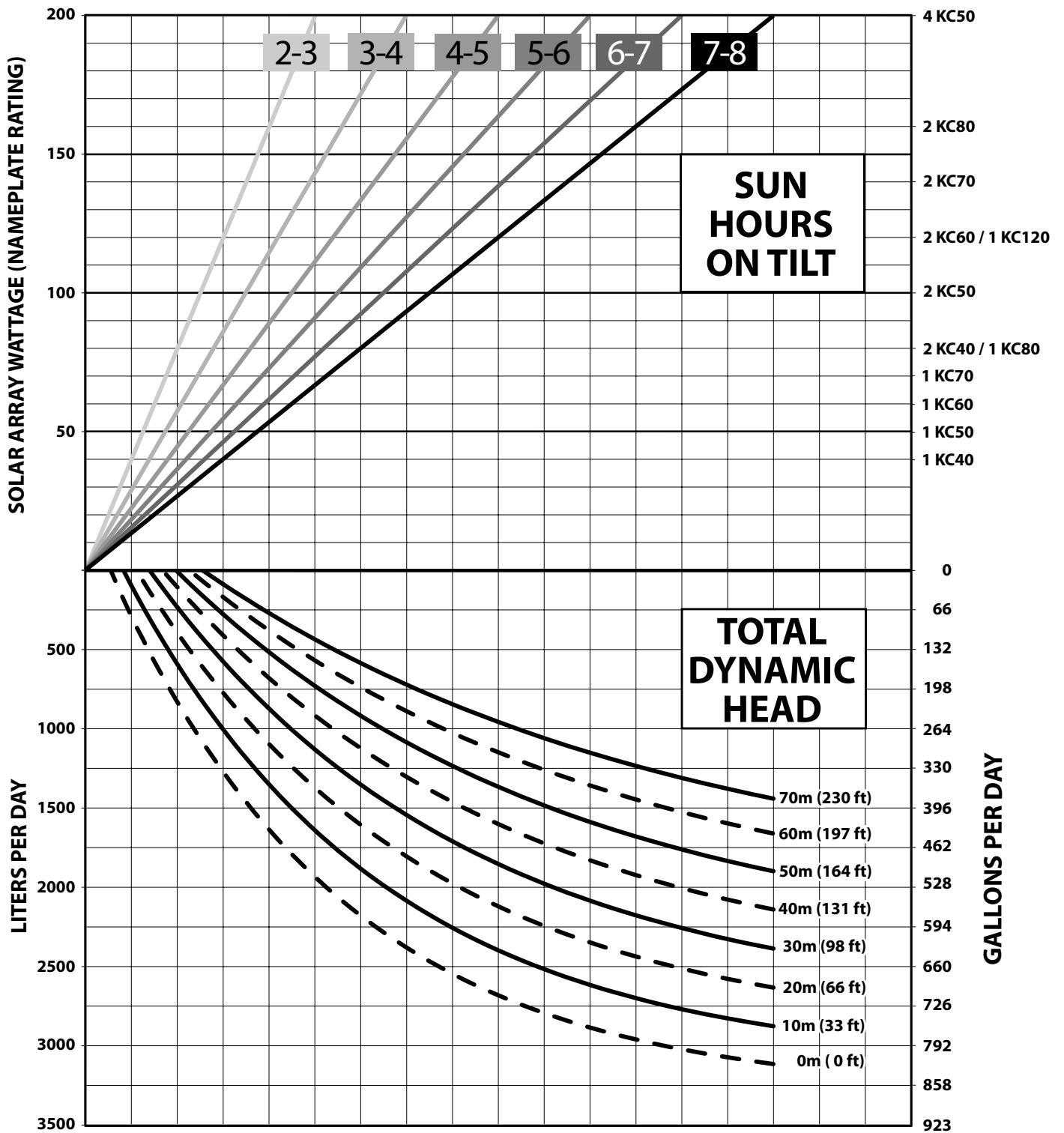

NOTE:

1. SD series systems require a CD 300 Pump Controller to provide the performance as shown.
2. Single, 12 Volt module systems require CD 300 Pump Controller to operate at full power.
3. Systems using 2 solar modules should be wired with the solar modules in series.
4. Systems using 4 modules or more should be wired series/parallel. Modules should be connected first in strings of 2 modules in series. These strings should then be paralleled to achieve the required power.

*For approximation purposes only. For more accurate sizing, see sizing software at www.kyocerasolar.com/products/waterpump.htm



Canada and USA Sun Hours On Tilt (S.H.O.T.) Maps

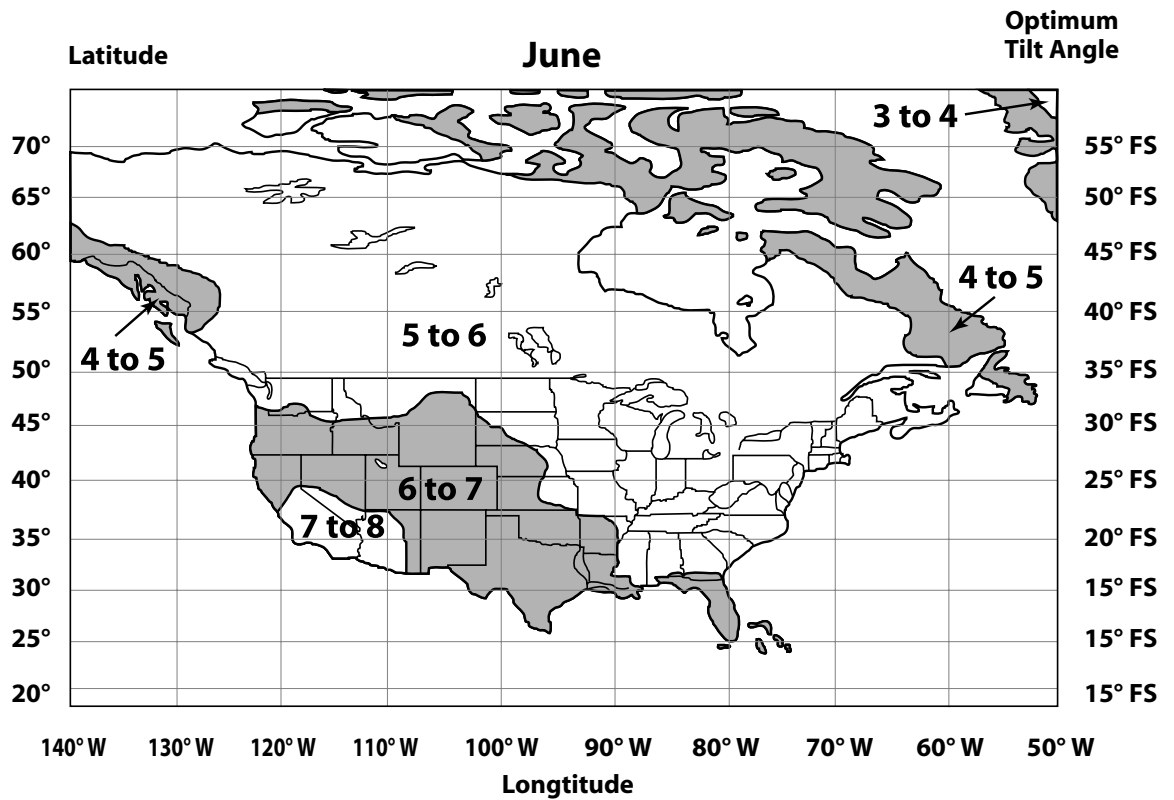
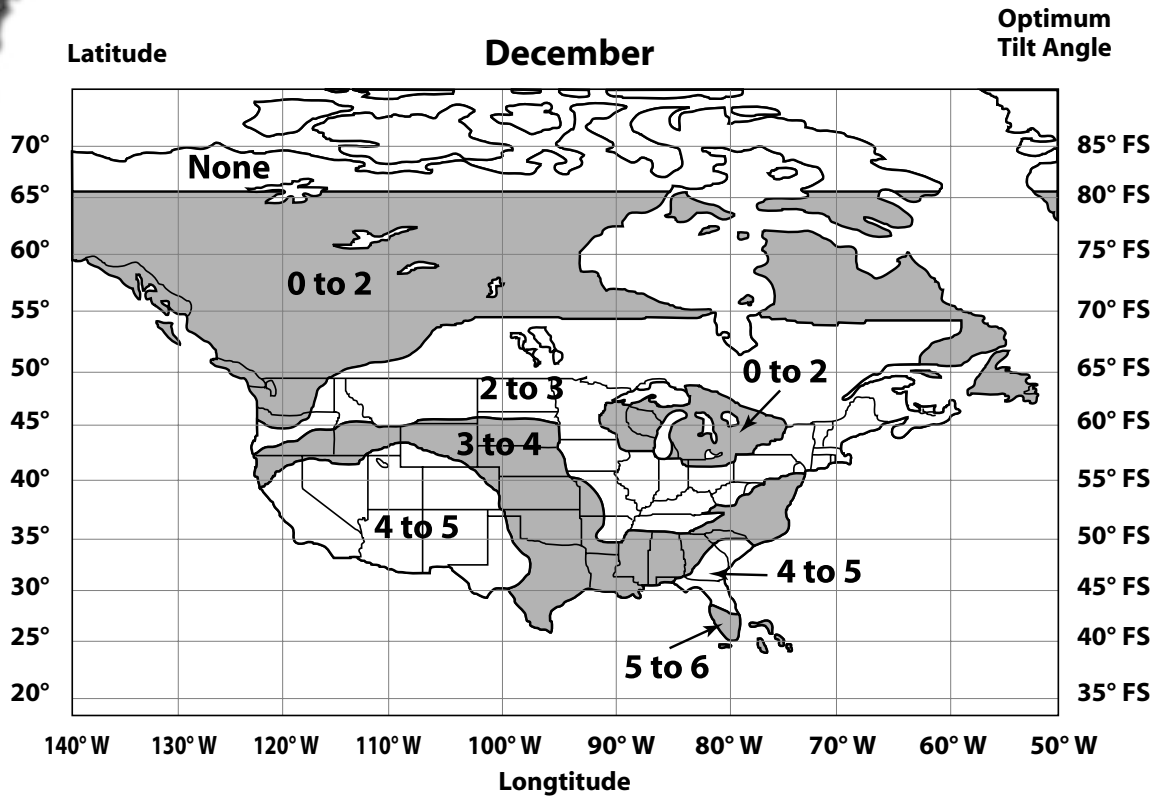

*For approximation purposes only. For more accurate sizing, see sizing software at www.kyocerasolar.com/products/waterpump.htm

Warranty Terms and Conditions

Warranty Performance

Every product offered is fully guaranteed by the manufacturer. The complete warranty detail of each product is available upon request. The manufacturer's warranty sets the terms and conditions for repair or replacement of non-conforming material. Kyocera Solar, Inc. offers no coverage beyond the manufacturer's explicit warranty. Kyocera Solar, Inc. is not responsible for any incidental or consequential damage to persons, property, or other loss or injury resulting from a defect or improper use or installation.

Satisfaction is guaranteed. If you are not satisfied with a product, it may be returned for refund (excluding shipping and handling) within 14 days. All returns are subject to approval. Please contact Kyocera Solar, Inc., Customer Service at 1-800-223-9907 before returning products.

All returns require prior authorization. Before you return a product, Kyocera Solar, Inc. Customer Service must assign a Return Authorization (RA) number. This RA number must appear on the outside of the box of any return. Returns without RA numbers will be refused and returned to the shipper. Some shipping and handling charges may be applied. Please refer to the Kyocera Solar, Inc. Customer Service Return Policy.

Return Authorization (RA) Numbers

Please contact Kyocera Solar, Inc. Customer Service at 1-800-223-9907 to obtain an RA number. You must have the original Sales Order Number or Invoice.

The Customer Service Representative will have specific instructions for you. All products must be returned to Kyocera Solar, Inc. for evaluation. Replacements are not sent automatically except in specific circumstances. You may order a replacement part under dealer terms. If the returned goods are found to be covered under the manufacturer's warranty, you will be credited the cost of the goods. Otherwise, the repaired or replaced item will be shipped freight pre-paid. The customer is responsible for freight costs to Kyocera Solar, Inc.

Receiving an RA number does not guarantee final disposition. All returns are subject to final inspection. Kyocera Solar, Inc. reserves the right to deny any claim.

All merchandise returned for refund or exchange must be received in original factory condition including: packing material, inserts, and manuals. You will be charged for any missing items.

Shipping and Delivery

Replacement parts will be shipped prepaid upon verification of claim. The dealer or consumer is responsible for freight charges to return product to Kyocera Solar, Inc. Merchandise will be shipped by best method.

Shipping Damage and / or Shortage

In the event of shortage of material or visible damage to merchandise, the receiving party must note any damage or shortage on the carrier's delivery receipt. Please notify Kyocera Solar, Inc. Customer Service immediately at 1-800-223-9907. **DO NOT REFUSE A DAMAGED SHIPMENT.** The receiving party will be charged the full freight amount for any damaged shipment returned to Kyocera Solar, Inc. without approval and an RA number assigned.

Special Instructions for Returning Products

1. Never return any product without first obtaining an RA number.
2. The RA number must appear on the outside of the shipping box.
3. We recommend using UPS Ground Service, Insured.
4. Packages sent freight collect will be refused.

Kyocera Solar, Inc. Customer Service Return Policy

All authorized Kyocera Solar, Inc. dealers are required to process warranty claims. The dealer must obtain a Return Authorization (RA) number in order to return goods to Kyocera Solar, Inc. Only refused or undeliverable orders may be returned without an RA number.

Authorized returns will be accepted without a stocking or handling fee under the following conditions:

1. The goods are returned in original condition and packaging within 30 days.
2. The goods were received damaged, failed, or inoperable.
3. The goods were returned due to failure within the manufacturer's warranty period.
4. The goods were returned due to customer order error within 30 days.
5. The goods were returned due to salesperson error.
6. The goods were shipped in error.

Authorized returns will be accepted with a minimum stocking or handling fee under the following conditions:

1. The goods were returned within 30 days, but **not** in original packaging. (Minimum 10% handling fee or cost of re-packaging, whichever is greater).
2. The goods were returned after 30 days. (15% handling fee).
3. Custom or special order products may be charged a higher handling fee.

Authorized returns for non-warranty items will be accepted for repair under the following conditions:

1. The goods were authorized for return to be repaired.
2. The customer must approve the cost amount of repairs.
3. The goods will not be returned until payment in full has been received.
4. If the customer declines the repairs, the parts will be returned.

Refused or non-deliverable goods will be handled in the following manner:

1. In the case of orders refused without prior notification, the receiving party will be charged freight plus 10% handling.
2. In the case of undeliverable goods, the customer will pay freight.

General conditions and terms:

1. Only Kyocera Solar, Inc. Customer Service can issue Return Authorizations.
2. All returns require a RA except as listed above.
3. The customer is responsible for freight to Kyocera Solar, Inc. Except in special circumstances listed above, freight back to the consumer or dealer will be the responsibility of Kyocera Solar, Inc.
4. All questions or concerns must be directed to Kyocera Solar, Inc. Customer Service.

SUN WATER LIFE

Kyocera Solar, Inc., one of the world's largest suppliers of solar electric products, introduces a new link between the sun and one of mankind's essential needs – **WATER**.

Pumping water with solar electricity is a natural fit because water is needed most when and where the sun shines the brightest. Solar electricity is the quiet, reliable solution to remote well and surface water pumping anywhere the sun shines.

With more than 18 years experience and thousands of pumps and controllers, and solar modules in service around the globe, Kyocera is the premier solar pumping system manufacturer. Our mission strives for superior products and services for the well being of all living things on this planet.

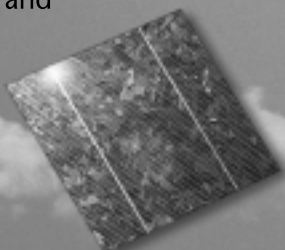

Multocrystal-silicon solar cell



*Kyocera SC 500 Series Water Pump
and CC 2000 Controller*

**27 Years Experience in
Photovoltaic Technology.**

KYOCERA SOLAR, INC.
7812 East Acoma Drive
Scottsdale, Arizona 85260 USA
T: +1.480.951.6330
F: +1.480.951.6329
www.kyocerasolar.com
info@kyocerasolar.com

THE NEW VALUE FRONTIER

KYOCERA

KYOCERA SOLAR, INC.

THE NEW VALUE FRONTIER



KYOCERA SOLAR, INC.

7812 East Acoma Drive
Scottsdale, AZ 85260 USA
480.951.6330
FAX: 480.951.6329
800.544.6466
www.kyocerasolar.com

Free Manuals Download Website

<http://myh66.com>

<http://usermanuals.us>

<http://www.somanuals.com>

<http://www.4manuals.cc>

<http://www.manual-lib.com>

<http://www.404manual.com>

<http://www.luxmanual.com>

<http://aubethermostatmanual.com>

Golf course search by state

<http://golfingnear.com>

Email search by domain

<http://emailbydomain.com>

Auto manuals search

<http://auto.somanuals.com>

TV manuals search

<http://tv.somanuals.com>