

XG-20

LA CROSSE[®]
TECHNOLOGY
technology tools for home & office

Instruction Manual

Download from Www.Somanuals.com. All Manuals Search And Download.

1.0 Introduction



Thanks for your purchase of the XG-20.

Your XG-20 features electronic sensors that measure the compass directions.

Your XG-20 provides directions to you at the time while you are hiking, climbing and doing other outdoor activities.

Your XG-20 also includes normal time, daily alarm, countdown timer, dual time and chronograph.

Your XG-20 is carefully designed and produced for outdoor activities, in order to utilize the features of your watch, it is advisable to read the following instructions:

- Read the instruction before you use the XG-20.
- Avoid exposing your XG-20 to extreme conditions for an unreasonable time.
- Avoid rough uses or severe impacts to your XG-20.
- Do not open the XG-20's case unless a certified service agency because your XG-20 contains precise electronic sensor and components.
- Clean your XG-20 with a soft cloth occasionally to increase the life of your watch.
- Keep your XG-20 away from magnets or appliances which contain magnetic objects such as mobile phones, speakers and motors.
- Store your XG-20 in a dry place when it is not in use.

2.0 Parts and Its Functions



Mode Button

- To select between various modes: Current Time, Alarm Time, Chronograph, Lap Memory Recall, Countdown Timer and Dual Time Mode.
- Press and hold for 2 seconds to change to the setting displays in various modes.
- To select among items to be set during the setting sequence.
- To select between normal compass bearing and backward bearing display in Compass Mode.

Start/Stop Button

- To start/stop the timer/chronograph.
- To lock/unlock the compass bearing.
- To increase the number during setting sequences.
- To review the lap memories by forward reviewing

Compass Button

- To select between Current Time and Compass Mode.
- To decrease the number during setting sequences.
- To select Lap/reset function in Chronograph Mode.
- To reset the timer in Countdown Timer Mode.

Light Button

- Press once to turn on the EL back light for about 3 seconds.
- Press and hold for 2 seconds to enable/disable auto light. If auto light is enabled, pressing any button will turn on the back light for about 3 seconds.

3.0 Major Function Modes

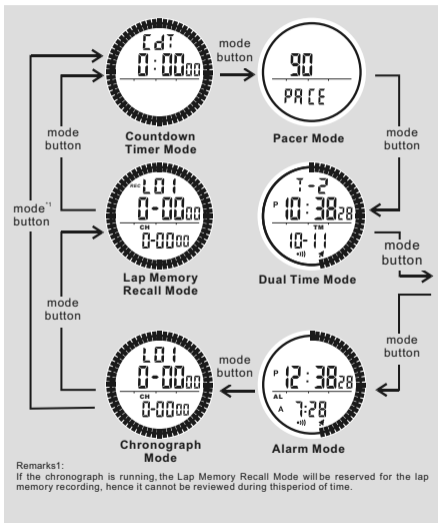

Current Time Mode

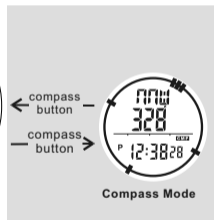

Compass Mode

4.0 Current Time Mode - Current Time & Calendar

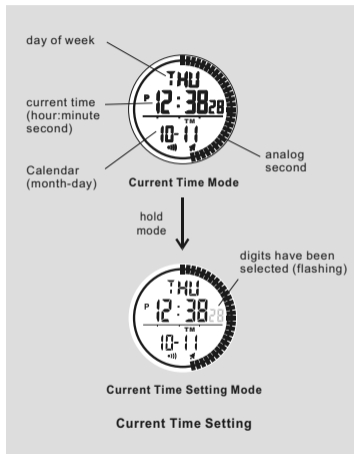

Current Time Mode

- The 1st row of the displays shows the day of week.
- The 2nd row of the display shows the current time: hour, minute and second.
- The 3rd row of the display shows the calendar: month, day.
- The indicators around the display show the current time in 1 second resolution

4.1 Current Time Mode - Setting Current Time & Calendar

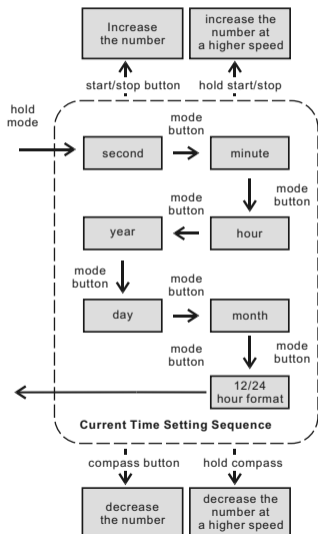

To Set the Current Time and Date

- To set the current time and the date, press and hold the [mode] button for 2 seconds to change the display from the Current Time Mode to Current Time Setting Mode.
- The second digits flash on the display because they are being selected.

The Setting Procedures

- Press [mode] button to change the selections following the Current Time Setting Sequence shown on the left.
- If the digits are flashing, press the [start/stop] button to increase the number; hold the [start/stop] button to change the number at a higher speed. Press the [compass] button to decrease the number; hold the [compass] button to change the number at a higher speed.
- While 12/24 hour format setting is selected, press the [start/stop] or [compass] button once to select between 12 or 24 hour format.
- After you set the current time, calendar and 12/24 hour format, press the [mode] button to exit the Current Time Setting Sequence.
- If no key-stroke has been activated for 30 seconds, the setting display will return to Current Time Mode.

5.0 Alarm Time Mode - Setting the Alarm and Chime On/Off

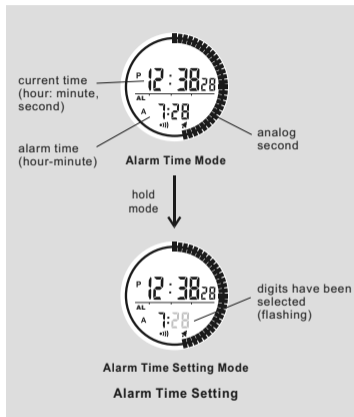

Alarm Time Mode

- The 2nd row of the display shows the current time: hour, minute and second.
- The 3rd row of the display shows the alarm time: hour, minute.
- The indicators around the display show the current time in 1 second resolution.

To Set the Chime ON/OFF

- Press the [compass] button to change the ON/OFF status of the hourly chime, in the Alarm Time Mode.
- When the chime indicator ▲ is shown (chime ON), the XG-20 beeps every hour on the hour.

To Set the Alarm ON/OFF

- Press the [start/stop] button to change the ON/OFF status of the alarm, in the Alarm Time Mode.
- When the alarm indicator ●||) is shown (alarm ON), the XG-20 sounds at the pre-set alarm time every day.

5.1 Alarm Time Mode - Setting the Alarm Time

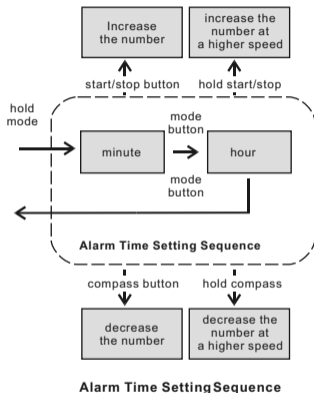

To Set the Alarm Time

- Press and hold the [mode] button for 2 seconds to change from Alarm Time Mode to Alarm Time Setting Mode.
- The minute digits flash on the display because it is being selected.

The Setting Procedures

- Press [mode] button to change the selection following the Alarm Time Setting Sequence shown on the left.
- If the digits are flashing, press the [start/stop] button to increase the number; hold the [start/stop] button to change the number at a higher speed. Press the [compass] button to decrease the number; hold the [compass] button to change the number at a higher speed.
- After you set the alarm time, press the [mode] button to exit the setting sequence.
- If no key-stroke has been activated for 30 seconds, the setting display will auto return to Alarm Time Mode.

6.0 Chronograph Mode - Chronograph 'All Zero' Mode

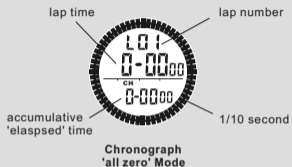

Chronograph Mode

- The Chronograph measures elapsed times and lap times.
- The display shows the 'All Zeros' Mode if the chronograph has been selected the first time or the chronograph has been reset.
- The 1st row of the display shows the current lap number of the chronograph.
- The 2nd row of the display shows the lap time: minute, second and 1/100 second.
- The 3rd row of the display shows the accumulated running time: minute, second and 1/100 second.

NOTE: if the accumulated time is longer than 1 hour, the display shows chronograph time in hour, minute and second instead of minute, second and 1/100 second.

- The indicators around the display shows the chronograph time in 1/10 second

NOTE: The maximum counting range of the chronograph is 9 hours 59 minutes and 59 seconds, hence the chronograph will count continuously until it counts to that value or the [start/stop] button is pressed.

6.1 Chronograph Mode - Start/Stop the Chronograph

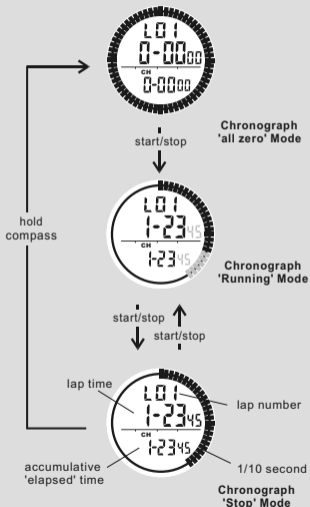

To Start/Stop the Chronograph

- When the chronograph is stopped, press the [start/stop] button once to start the chronograph; press the [start/stop] button once again to stop the chronograph.
- The elapsed time between the two 'start/stop' keystrokes will be shown on 3rd row of the display.
- Repeat the above steps to get the accumulated time the chronograph is running.
*

To Reset the Chronograph

- To record a new set of elapsed time, press and hold the [compass] button for 2 seconds to reset the chronograph to 'All Zeros' display when the chronograph is stopped.

NOTE: If you reset the chronograph, the lap memory will be reset at the same time.

6.2 Chronograph Mode - Record Lap Time

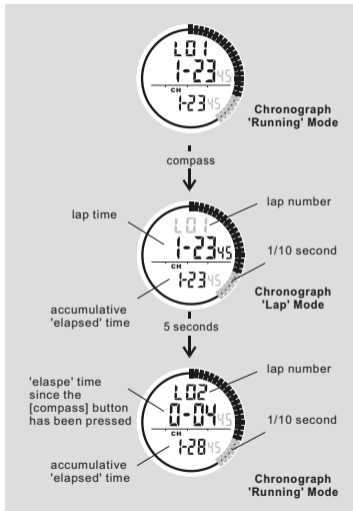

To Record Lap Memory

- The Chronograph Mode allows you to record lap memory (maximum 42 lap memories).
- Press the [compass] button once to record the lap memory while the chronograph is running.
- The lap number will be flashing on the 1st row of the display.
- The lap time is displayed on the 2nd row of the display for 5 seconds, then it shows the 'elapse' time since the [compass] button has been pressed.
- The accumulated 'elapse' time will be displayed on the 3rd row of the display.
- While the lap number and lap time are displaying, the chronograph keeps running.
- Repeat the steps mentioned above to get another set of lap memory.

To Reset Lap Memory

- Press and hold the [compass] button for 2 seconds to reset the lap memory in the Chronograph Mode while the chronograph was stopped.

7.0 Lap Memory Recall Mode - Recall Lap Time



compass button ↑ ↓ start/stop button

2nd lap memory

compass button ↑ ↓ start/stop button

the next recorded lap memories

compass button ↑ ↓ start/stop button

the last recorded lap memory (max. 42 memory)

Lap Memory Recall Sequence

Lap Memory Recall Mode

- The lap number flashes in the 1st row of the display; the 'REC' indicator will appear at the same time.
- The 2nd row of the display shows the lap time of the current lap memory: minute, second and 1/100 second.
- The 3rd row of the display shows the accumulated 'elapse' time: minute, second and 1/100 second.

NOTE: If the chronograph is running, the Lap Memory Recall Mode will be reserved for the lap memory recording and this mode can not be reviewed during this period of time.

To Recall Lap Memory

- Press the [start/stop] button to check the lap memories through forward reviewing from lap 1 to lap 42. Hold the [start/stop] button to change lap memory at a higher speed.
- Press the [compass] button to check the lap memories through backward reviewing from lap 42 to lap 1. Hold the [compass] button to change lap memory at a higher speed.

NOTE: Check the 'To Reset Lap Memory' section for lap memory reset instructions.

8.0 Countdown Timer Mode - Countdown Timer Mode

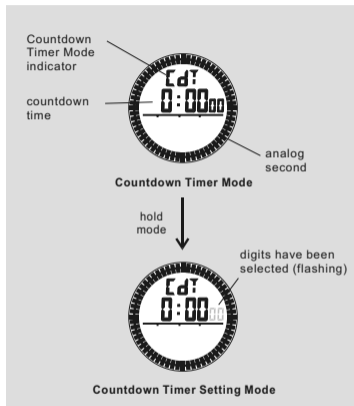

Countdown Timer

- XG-20 has a countdown feature: the Countdown Timer Mode.
- The Countdown Timer starts counting from the preset number to zero and stops at zero.
- The 1st row of the display shows the 'Cd?' indicator.
- The 2nd row of the display shows the countdown time: hour, minute and second.
- The indicators around the display shows the countdown time in 1 second

8.1 Countdown Timer Mode - Setting the Timer

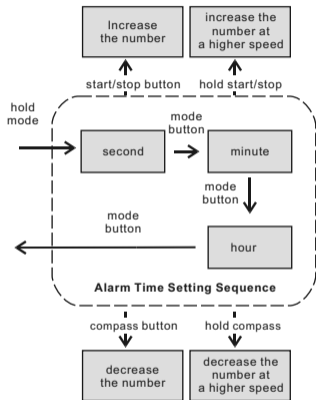

To Set the Countdown Timer

- Press and hold the [mode] button for 2 seconds to change the display from Countdown Timer Mode to Countdown Timer Setting Mode.

NOTE: The setting range of the timer: 0 to 99 hour, 59 minutes, 59 seconds.

- The second digits flash on the display because it is being selected.

The Setting Procedure

- Press [mode] button to change the selection following the Countdown Timer Setting Sequence.
- If the digits are flashing, press the [start/stop] button to increase the number; hold the [start/stop] button to change the number at a higher speed. Press the [compass] button to decrease the number; hold the [compass] button to change the number at a higher speed.
- After you set the timer, press the [mode] button to exit the setting sequence.
- If no key-stroke has been activated for 30 seconds, the setting display will return to Countdown Timer Mode.

8.2 Timer Mode - Using the Timer

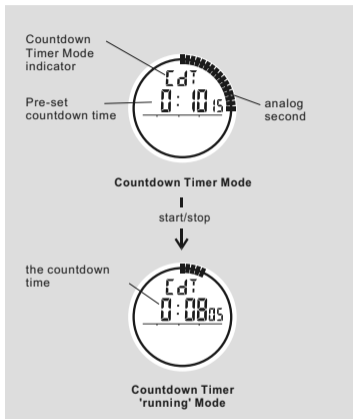

To Use the Timer

- When the timer is set, press the [start/stop] button to start the timer. Press the [start/stop] button again to stop the timer.
- If the timer is started, the countdown time (hour, minute and second) will be shown on the display continuously.
- The timer starts to beep every second when it is 5 seconds to the end of the countdown.
- When the countdown time reaches zero, a long beep lasting for 2 seconds will be heard.
- Press any button in this period to terminate the beep sound prematurely.
- When the countdown time reaches zero, press [compass] button to re-load the preset time, or press [start/stop] button to re-load the preset time and start the countdown simultaneously.

To Reset the Timer

- Press and hold the [compass] button for 2 seconds to reset the timer while the timer is stopped.

9.0 Pacer Mode - Pacer Mode

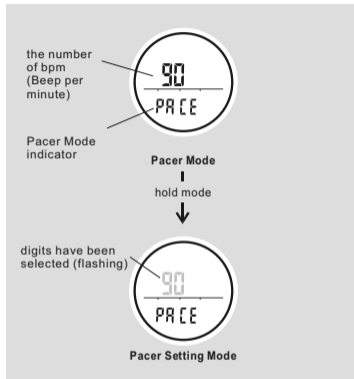

Pacer Mode

- The XG-20 has a built-in a pacer for the user: The Pacer Mode.
- The 2nd row of the display show the current pacer setting.
- The '**PACE**' indicator will appear on the 3rd row of the display.
- If the pacer is activated, the XG-20 will beep at the preset rate(bpm) everyminute.

To Start/Stopthe Pacer

- If the Pacer has been set, press the [start/stop] button to start the pacer. Press the [start/stop] button again to stop the pacer(beeping sound).

9.1 Pacer Mode - Setting the Pacer Rate (bpm)

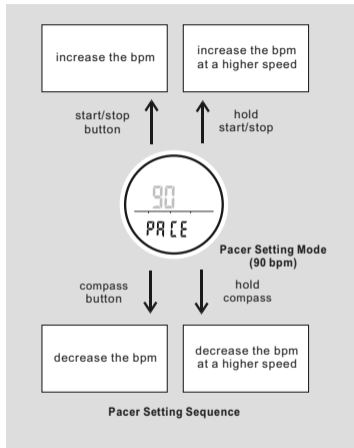

To Set the Pacer Rate (bpm)

- Press and hold the [mode] button for 2 seconds to change the display from Pacer to P a c e r S e t t i n g Mode.

- The digits flash on the display because it is being selected.

The setting procedure

- If the digits are flashing, press the [start/stop] button to increase the number (steps of 5 BPM); hold the [start/stop] button to change the number at a higher speed. Press the [Compass] button to decrease the number (steps of 5 BPM); hold the [Compass] button to change the number at a higher speed.

- After you set the pacer, press the [mode] button to exit the setting sequence.

- If no key-stroke has been activated for 30 seconds, the setting display will return to Pacer Mode.

NOTE: The setting range of the pacer: 40 bpm to 180 bpm.

10.0 Dual Time Mode - Dual Time Mode

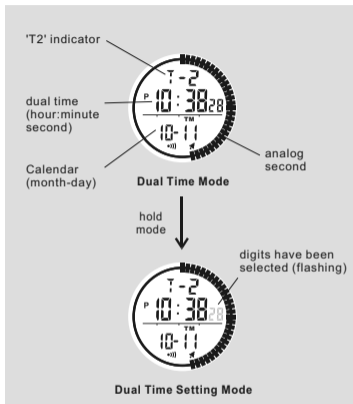

Dual Time Mode

- The 'T-2' indicator will be displayed on the 1st row of the display.
- The 2nd row of the display shows the dual time: hour, minute and second.
- The 3rd row of the display shows the calendar: month, day.
- The indicators around the display show the dual time in 1 second resolution.

NOTE: The calendar readout of the Dual Time Mode will be the same as the Current Time Mode.

10.1 Dual Time Mode - Setting the Dual Time

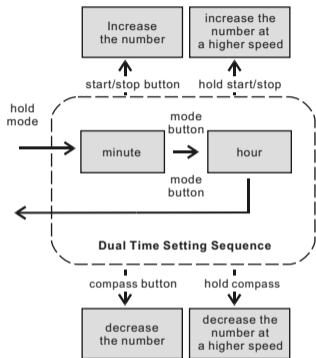

Dual Time Setting Sequence

To Set the Dual Time

- To set the dual time, press and hold the [mode] button for 2 seconds to change the display from the Dual Time Mode to Dual Time Setting Mode.
- The minute digits flash on the display because they are being selected.

The Setting Procedures

- Press [mode] button to change the selections following the Dual Time Setting Sequence shown on the left.
- If the digits are flashing, press the [start/stop] button to increase the number; hold the [start/stop] button to change the number at a higher speed. Press the [Compass] button to decrease the number; hold the [Compass] button to change the number at a higher speed.
- After you set the Dual Timer, press the [mode] button to exit the Dual Time Setting Sequence.
- If no key-stroke has been activated for 30 seconds, the setting display will return to Dual Time Mode.

11.0 Compass Mode - The Precautions



The features of the HiTrax Scout which relate to the Compass Mode

Precautions when Using XG-20

- Keep your XG-20 away from magnets or appliances which may contain magnetic objects such as mobile phones, speakers, motors and etc.
- The XG-20, like most magnetic compass, points to the magnetic North which is slightly different from the true North. Check the 'What is Magnetic Declination' section for more detail.
- Perform the compass calibration in the following conditions: :
 - 1) when the XG-20 is used the first time,
 - 2) when the '**DIST**' indicator is flashing,
 - 3) the battery has been replaced, or
 - 4) when using the compass in a location different from the place in which the compass had been calibrated.
- To achieve an accurate result, you should avoid measuring a direction in the following conditions:
 - 1) the watch is close to magnetic/metal objects,
 - 2) the watch is close to electrical appliances, or
 - 3) the watch is inside a moving object or a ferro-concrete building.

11.1 Compass Mode - Compass Mode

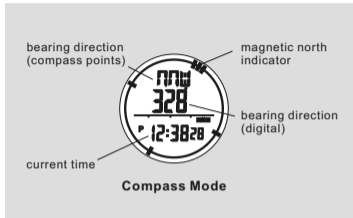

Compass Mode

- In the Compass Mode, the 1st row of the display shows the bearing (compass points) of the direction which the watch's pointer is pointing.
- The 2nd row of the display shows the bearing (digital) of the direction which the watch's pointer is pointing.
- The 3rd row of the display shows the current time: hour, minute and second.
- The indicators around the display show the direction of magnetic North.
- The Compass Mode will change to the standby mode after 1 minute.
- In the standby mode, press any button except [Light] button once to return to the Compass Mode.

11.2 Compass Mode - Magnetic Declination

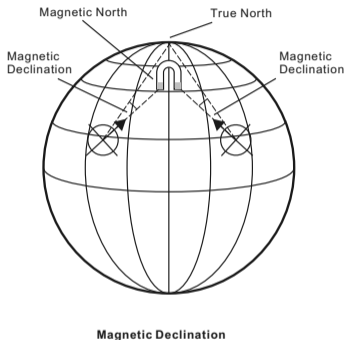

What is Magnetic Declination

- The Magnetic North Pole is slightly different from the True North Pole. The XG-20, like most magnetic compasses, points to the Magnetic North Pole. On the contrary, everything measured from a map is related to the True North Pole.

- The angular difference between Magnetic North Pole and True North Pole is called magnetic declination. Its amount (degrees and minutes) and direction (easterly and westerly) depend on where you are.

- For serious compass user or users who intends to perform accurate navigation, the compass must be adjusted to compensate for magnetic declination.

- XG-20 also includes a compensation setting for Magnetic Declination. Check 'Calibrating the Compass' section for more details on the setting.

Magnetic Declination Information

- Most topographic maps show magnetic north pole and or the magnetic declination information.

- This manual includes the magnetic declination for some major cities. Check the 'Magnetic Declination at Major Cities' section for more detail.

- For those cities whose names are not included in the list, you may like to refer to the online magnetic declination information at:

1. http://www.geolab.nrcan.gc.ca/geomag/e_cgrf.html

2. <http://www.ngdc.noaa.gov/cgi-bin/seg/gmag/fldsnth1.pl>

- Use an atlas to find your latitude and longitude before you use the links above.

11.3 Compass Mode - Magnetic Declination Compensation

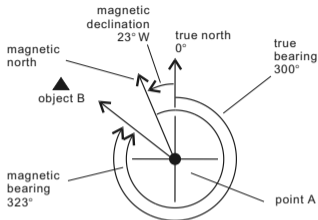

Compensate the Bearing at a place with
Westerly (W) Magnetic Declination

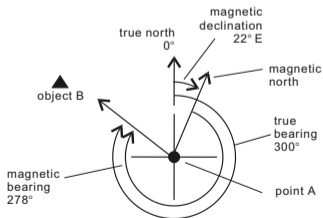

Compensate the Bearing at a place with
Easterly (E) Magnetic Declination

Magnetic Declination Compensation

- Compensate an object's bearing by subtract westerly (W) magnetic declination or add easterly (E) magnetic declination with the magnetic bearing.

Example 1

- 23° Westerly magnetic declination and the compass needle points 323°.
- The bearing will be $323^\circ (\text{MB}) - 23^\circ (\text{W}) = 300^\circ (\text{TB})$.

Example 2

- 22° Easterly magnetic declination and the compass needle points 278°.
- The bearing will be $278^\circ (\text{M}) + 22^\circ (\text{E}) = 300^\circ (\text{TB})$.
- XG-20 will compensate the compass bearing wherever the magnetic declination is either Westerly (-ve) declination or Easterly declination (+ve) automatically, if the user inputs the magnetic declination angle of the city which is close to the user's current location during the calibration.
- Check the 'Calibrating the Compass' section for more details on the calibration.

11.4 Compass Mode - Magnetic Declination at Major Cities

No.	Country/Place	Major City	No.	Country/Place	Major City	Declination
1	Afghanistan	Kabul	2-E	33Netherlands	Amsterdam	1-W
2	Australia	Canberra	12-E	34New Zealand	Wellington	22-E
3	Austria	Vienna	2-E	35Norway	Oslo	0
4	Bahrain	Manama	2-E	36Pakistan	Islamabad	2-E
5	Bangladesh	Dhaka	0	37Philippines	Manila	1-W
6	Belgium	Brussels	1-W	38Portugal	Lisbon	5-W
7	Brazil	Brasilia	19-W	39Russia	Moscow	9-E
8	Canada	Ottawa	14-W	40Singapore	Singapore	0
9	Chile	Santiago	5-E	41South Africa	Cape Town	23-W
10	China	Beijing	6-W	42Spain	Madrid	3-W
11	China	Hong Kong	2-W	43Sweden	Stockholm	3-E
12	Costa Rica	San Jose	0	44Switzerland	Bern	0
13	Cuba	Havana	3-W	45Taiwan	Tai-pei	3-W
14	Czech Republic	Prague	2-E	46Thailand	Bangkok	0
15	Denmark	Copenhagen	1-E	47UAE	Abu Dhabi	1-E
16	Egypt	Cairo	3-E	48United Kingdom	London	3-W
17	Finland	Helsinki	6-E	49United States	Washington, DC	10-W
18	France	Paris	1-W	50	Juneau	25-E
19	Germany	Berlin	1-E	51	Phoenix	12-E
20	Greece	Athens	3-E	52	Little Rock	2-E
21	Hungary	Budapest	4-E	53	Sacramento	16-E
22	India	New Delhi	1-E	54	Denver	10-E
23	Indonesia	Jakarta	1-E	55	Atlanta	4-W
24	Israel	Jerusalem	3-E	56	Honolulu	10-E
25	Italy	Rome	1-E	57	Boston	16-W
26	Japan	Tokyo	7-W	58	Saint Paul	2-E
27	Jordan	Amman	3-E	59	Jackson	1-E
28	Kenya	Nairobi	1-E	60	Santa Fe	10-E
29	Korea	Seoul	7-W	61	Oklahoma City	6-E
30	Malaysia	Kuala Lumpur	1-E	62	Salem	18-E
31	Mexico	Mexico City	6-E	63	Harrisburg	11-W
32	Nepal	Download from Ww	6-E	64	Salt Lake City	14-E

11.5 Compass Mode - Before Calibrate the Compass

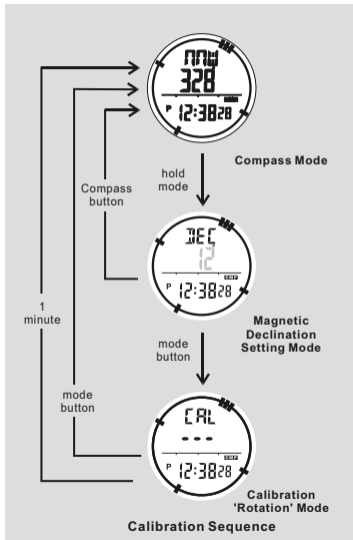

To Calibrate the compass

- Perform the compass calibration in the following conditions:

- 1) when the XG-20 is used the first time,
- 2) when the '**DIST**' indicator is flashing,
- 3) the battery has been replaced,
- 4) when using the compass in a location different from the place in which the compass has been calibrated.

IMPORTANT: If the watch has not been calibrated, the direction reading may be inaccurate.

- Check the 'Magnetic Declination at Major Cities' section to get the magnetic declination of the city closest to your current location

*

*

11.6 Compass Mode - Calibrating the Compass

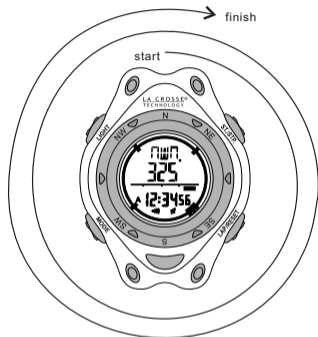

Calibration
'Rotation' Mode

To Calibrate the Compass

- Press and hold the [mode] button for 2 seconds to start the Magnetic Declination Setting, in the Compass Mode.

- The 'DEC' indicator will be appeared on the 1st row of the display. The digit will start flashing, press the [start/stop] button to change the angle (from -90 to 90), until the desired magnetic declination has appeared.

Example 1:

- Compensate the magnetic declination for Wellington in New Zealand (22-E), select +22 in the magnetic declination setting.

Example 2:

- Compensate the magnetic declination in Boston in the USA (16-W), select -16 in the magnetic declination setting.

- Press the [mode] button to go to the Calibration 'Rotation' Mode, the EL back light will turn on automatically for a second. At the same time, the 'CAL' indicator will show on 1st row of the display and the bearing indicators will start to move.

- When the EL back light is off, hold the XG-20 on a flat surface which is parallel to the horizon, then rotate the XG-20 clockwise at the rate as the bearing indicators' moving for 2 turns. The rotation should be completed in a slow and steady practice.

- When the turning is completed, press [mode] button to return to Compass Mode. The Calibration 'Rotation' Mode will return to Compass Mode after 1 minute.

11.7 Compass Mode - Compass Points and Digital Bearings

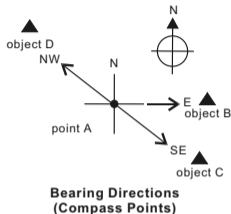

The Direction of an Object

- The direction of an object from a point is specified in either compass points or digital bearing directions.
- The XG-20 provides both compass points or digital bearing directions.

The Compass Points

- The compass points are North, Northeast, East, Southeast, South, Southwest, West and Northwest.
- For example, in the figure on the left, the compass points of object B from point A is East. The compass points of object C from point A is Southeast. The compass points of object D from point A is Northwest.

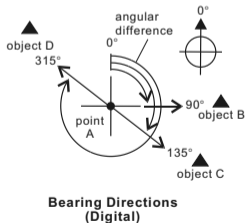

The Digital Bearing

- The digital bearing direction of an object is defined as the angular difference between North and the object. (Assuming that 0° for North, and the measuring range is from 0° to 359°)
- For example, in the figure on the left, the digital bearing direction of object B from point A is 90° . The digital bearing direction of object C from point A is 135° . The digital bearing direction of object D from point A is 315° .

11.8 Compass Mode - Compass Points versus Digital Bearings

Marks	Compass Points	Digital Bearing Directions
N	North	348.75° to 11.25°
NNE	North Northeast	11.25° to 33.75°
NE	Northeast	33.75° to 56.25°
ENE	East Northeast	56.25° to 78.75°
E	East	78.75° to 101.25°
ESE	East Southeast	101.25° to 123.75°
SE	Southeast	123.75° to 146.25°
SSE	South Southeast	146.25° to 168.75°
S	South	168.75° to 191.25°
SSW	South Southwest	191.25° to 213.75°
SW	Southwest	213.75° to 236.25°
WSW	West Southwest	236.25° to 258.75°
W	West	258.75° to 281.25°
WNW	West Northwest	281.25° to 303.75°
NW	Northwest	303.75° to 326.25°
NNW	North Northwest	326.25° to 348.75°

Compass Points versus Digital Bearings

Download from [Www.Somanuals.com](http://www.somanuals.com). All Manuals Search And Download.

11.9 Compass Mode - Measure Compass Directions

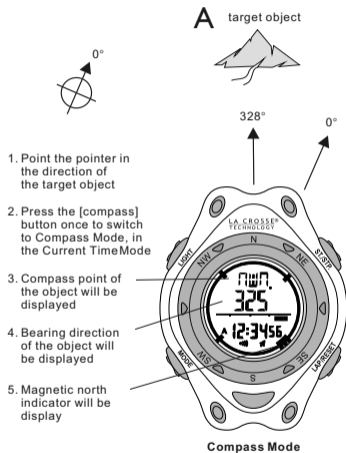

Measure Compass Directions

- When measuring compass directions, make sure that the XG-20 is placed on a flat surface which is parallel to the horizon.

- If you are wearing the XG-20 during the measurement, make sure that your wrist is parallel to the horizon.

IMPORTANT: If the watch is not parallel to the horizon when taking a measurement, the result may be inaccurate.

- Point the pointer which is engraved on the watch in the direction where your target object is.

- Press the [Compass] button once to select the Compass Mode, in the Current Time Mode.

- The Compass points of the target object appears on the 1st row of the display. The digital bearing direction of the target object appears on the 2nd row of the display. The arrow shape indicators on the display points the magnetic north.

Measure Compass Directions

Download from [Www.Somanuals.com](http://www.Somanuals.com). All Manuals Search And Download.

11.10 Compass Mode - Backward Bearing Direction

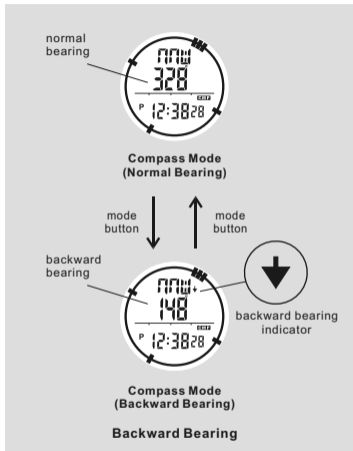

Backward Bearing Directions

- The XG-20 has a built-in a function which shows the backward bearing direction of an object.
- The backward bearing direction is the bearing direction opposite the direction from normal bearing direction.
- When the 'Backward Bearing' indicator "A" is appeared, the XG-20 shows the backward bearing direction of the direction which the watch's pointer is pointing.

NOTE: In Backward Bearing Compass Mode, the magnetic north indicator and the compass points readout will not be affected.

To Select Normal Bearing and Backward Bearing

- Press the [mode] button to select between normal and backward bearing directions, in the Compass Mode.
- The backward bearing will be return to normal bearing automatically in the following conditions:
 - 1) the XG-20 change to standby mode.
 - 2) the XG-20 change to Current Time Mode.

11.11 Compass Mode - Compass Lock

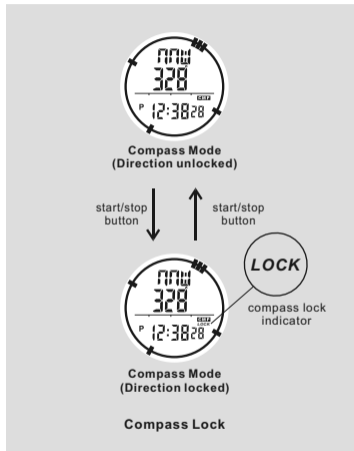

Compass Lock

- The XG-20 built-in a lock function to lock important direction readings, in the Compass Mode.
- When the 'Lock' indicator '**LOCK**' is appeared, the XG-20 locks the direction readings, hence the direction reading will not be changed even the pointer is pointing to another object.

To Lock/Unlock the Compass Lock

- Press the [start/stop] button to lock/unlock the direction readings, in the Compass Mode.
- The compass lock will be released automatically on the following conditions:
 - 1) The XG-20 changes to standby mode.
 - 2) The XG-20 changes to Current Time Mode.

11.12 Compass Mode - Application of the Compass I

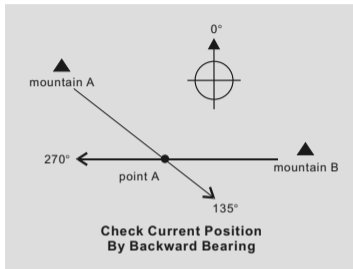

Check your position by Backward Bearing

- The XG-20 can check your position by backward bearing.
- Spot two distant identifiable landmarks (mountains, light-houses, forts and buildings) of your current position, such as the mountain A and B.
- Consult a map to find out the mountain A and B's locations on a map.
- Check out the backward bearing directions of mountain A and B of your current position, such as 135° for mountain A and 270° for mountain B.
- Use a ruler to draw the line 135° on the map which starting from the mountain A. Draw the line 270° on the map which starting from the mountain B.
- Your current position will be at the intersection point (point A) of the lines 135° and 270° .

11.13 Compass Mode - Application of the Compass II

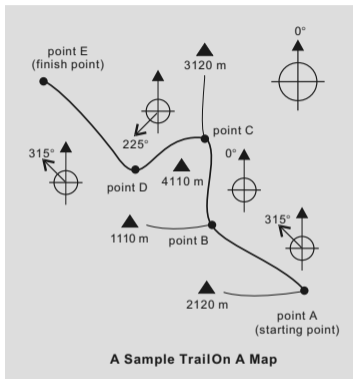

To Check the Track Course Correct

- If you are hiking on a track, the XG-20 can keep your track course correct.
- For example, the correct track is from point A to point D as it is mentioned on the map on the left.

Before the Track

- Mark the points (identifiable landmarks) on a topographic map where the track turns its direction or the track branches its way, such as the point A, B, C and D.
- Check the bearing directions on a topographic map of the following points:
 - 1) point B from point A (315°),
 - 2) point C from point B (0°),
 - 3) point D from point C (225°), and
 - 4) point E from point D (315°).

During the Track

- Check that you are in the correct bearing direction at the turning points or where the trail branches its way.

IMPORTANT: If you doubt of the directions and positions of the track, consult a wrangler or park administration officer before starting your track.

12.0 Low Battery Indication & Auto-Light Indication



Low Battery Indication

- If the battery low indicator  is appeared on the display, it means that the capacity of the battery is low. It is recommended to replace the battery with a new one (CR-2032).
- Complete the battery replacement by a certified service agency, because this XG-20 contains precise electronic sensor and components.
- However, if the appearance of battery low indicator is caused by an extremely low temperature, the indicator will be disappeared when normal temperature returns.

IMPORTANT: Perform the compass calibration immediately, if the battery has been replaced. Refer to the 'Before Calibrate the Compass' and 'Calibrating the Compass' sections for more detail of the calibration.

Auto-Light Indication

- If the auto-light indicator  is appeared, the auto-light feature is enabled.
- If the auto-light is enabled, press any button will turn on the back light for about 3 seconds.

NOTE: Auto-Light feature will consume more battery than that when the auto-light feature is disabled, hence a shorter life cycle for the battery when the auto-light feature is enabled.

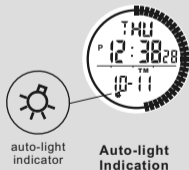

To Enable/Disable Auto-Light

- Press and hold for 2 seconds to enable the auto-light feature when the auto-light is disabled.
- Press and hold for 2 seconds to disable the auto-light feature when the auto-light is enabled.

13.0 Specifications

Current Time Mode

Time System:

- AM, PM, Hour, minute, second, and display with bar graph animation at the rate of 1 second
- 12-hour or 24-hour format

Calendar:

- Month, date and day of week display
- Auto-Calendar function for leap year and day of week

Alarm Mode

Alarm Type:

- 1 daily alarms, hourly chime

Alarm Sound:

- Sounds for 20 seconds at preset time of real time clock

Chronograph Mode

Resolution:

- 1/100 second

Range:

- 9 hours 59 minutes 59.99 seconds

Lap memory:

- 42 lap memories (maximum)

Countdown Timer

Resolution:

- 1 second resolution

Range:

- 99 hours 59 minutes 59 seconds

Operation Mode:

- Countdown to zero and stop at zero

Timer Sounds:

- Beeps once when count to last 10, 5 and 1 minute
- Beeps once for every second when count to last 5 seconds,
- Sounds for 2 seconds when count to zero

Pacer Mode

Range:

- 40 bpm to 180 bpm

Pacer Sounds:

- Pacer beep

Dual Time Mode

Time System:

- AM, PM, Hour, minute, second, and display with bar graph animation at the rate of 1 second

Calendar:

- Month and date

WARRANTY INFORMATION

La Crosse Technology, Ltd provides a 1-year limited warranty on this product against manufacturing defects in materials and workmanship.

This limited warranty begins on the original date of purchase, is valid only on products purchased and used in North America and only to the original purchaser of this product. To receive warranty service, the purchaser must contact La Crosse Technology, Ltd for problem determination and service procedures. Warranty service can only be performed by a La Crosse Technology, Ltd authorized service center. The original dated bill of sale must be presented upon request as proof of purchase to La Crosse Technology, Ltd or La Crosse Technology, Ltd's authorized service center.

La Crosse Technology, Ltd will repair or replace this product, at our option and at no charge as stipulated herein, with new or reconditioned parts or products if found to be defective during the limited warranty period specified above. All replaced parts and products become the property of La Crosse Technology, Ltd and must be returned to La Crosse Technology, Ltd. Replacement parts and products assume the remaining original warranty, or ninety (90) days, whichever is longer. La Crosse Technology, Ltd will pay all expenses for labor and materials for all repairs covered by this warranty. If necessary repairs are not covered by this warranty, or if a product is examined which is not in need or repair, you will be charged for the repairs or examination. The owner must pay any shipping charges incurred in getting your La Crosse Technology, Ltd product to a La Crosse Technology, Ltd authorized service center. La Crosse Technology, Ltd will pay ground return shipping charges to the owner of the product to a USA address only.

Your La Crosse Technology, Ltd warranty covers all defects in material and workmanship with the following specified exceptions: (1) damage caused by accident, unreasonable use or neglect (including the lack of reasonable and necessary maintenance); (2) damage occurring during shipment (claims must be presented to the carrier); (3) damage to, or deterioration of, any accessory or decorative surface; (4) damage resulting from failure to follow instructions contained in your owner's manual; (5) damage resulting from the performance of repairs or alterations by someone other than an authorized La Crosse Technology, Ltd authorized service center; (6) units used for other than home use (7) applications and uses that this product was not intended or (8) the products inability to receive a signal due to any source of interference.. This warranty covers only actual defects within the product itself, and does not cover the cost of installation or removal from a fixed installation, normal set-up or adjustments, claims based on misrepresentation by the seller or performance variations resulting from installation-related circumstances.

LA CROSSE TECHNOLOGY, LTD WILL NOT ASSUME LIABILITY FOR INCIDENTAL, CONSEQUENTIAL, PUNITIVE, OR OTHER SIMILAR DAMAGES ASSOCIATED WITH THE OPERATION OR MALFUNCTION OF THIS PRODUCT. THIS PRODUCT IS NOT TO BE USED FOR MEDICAL PURPOSES OR FOR PUBLIC INFORMATION. THIS PRODUCT IS NOT A TOY. KEEP OUT OF CHILDREN'S REACH.

This warranty gives you specific legal rights. You may also have other rights specific to your State. Some States do not allow the exclusion of consequential or incidental damages therefore the above exclusion of limitation may not apply to you.

For warranty work, technical support, or information contact:

La Crosse Technology, Ltd
2809 Losey Blvd S.
La Crosse, WI 54601
Phone: 608.782.1610
Fax: 608.796.1020

e-mail:

support@lacrossetechnology.com
(warranty work)

sales@lacrossetechnology.com
(information on other products)

web:

www.lacrossetechnology.com

All rights reserved. This handbook must not be reproduced in any form, even in excerpts, or duplicated or processed using electronic, mechanical or chemical procedures without written permission of the publisher.

This handbook may contain mistakes and printing errors. The information in this handbook is regularly checked and corrections made in the next issue. We accept no liability for technical mistakes or printing errors, or their consequences. All trademarks and patents are acknowledged.

Free Manuals Download Website

<http://myh66.com>

<http://usermanuals.us>

<http://www.somanuals.com>

<http://www.4manuals.cc>

<http://www.manual-lib.com>

<http://www.404manual.com>

<http://www.luxmanual.com>

<http://aubethermostatmanual.com>

Golf course search by state

<http://golfingnear.com>

Email search by domain

<http://emailbydomain.com>

Auto manuals search

<http://auto.somanuals.com>

TV manuals search

<http://tv.somanuals.com>