

# Gondo

## 4400EX Heavy Duty Off Road Utility Vehicle



21341

*Cover illustration may show optional equipment not supplied with standard unit*

### **720-051M** **Operator's Manual**



Read the Operator's manual entirely. When you see this symbol, the subsequent instructions and warnings are serious - follow without exception. Your life and the lives of others depend on it!

© Copyright 2008 Printed 7/14/08

*Cover photo may show optional equipment not supplied with standard unit.*



# Table of Contents



<b>Section 1: Introduction</b> .....	1	Shock Absorbers	23
Safety First .....	1	Electrical System	23
Using This Manual .....	1	Battery	24
Terminology .....	1	Jump Starting the Battery	24
Definitions .....	1	Prepare Vehicle to Jump-Start	24
Application .....	1	Connecting Jumper Cables	25
Models Covered	1	Disconnecting Jumper Cables	25
Getting Acquainted with your Gondo	1	Fuel System	25
Owner Assistance	2	Filling the Fuel Tank	26
Serial Number Plate	2	Emptying the Fuel Tank	26
<b>Section 2: Important Safety Information</b> .....	<b>3</b>	Fuel Filter and Fuel Line Maintenance	26
Safety Symbol .....	3	Engine Maintenance	26
Safe Operating Procedures	5	General Information	26
Safety Decals	7	High Altitude Carburetor Kit	27
<b>Section 3: Pre-Delivery and Check List</b> .....	<b>12</b>	Power Steering Belt	27
Pre-Delivery Certificate	12	Engine Air Filter	28
Vehicle Information	12	Air Filter Maintenance Schedule	28
Dealer Service and Inspection List	12	Precleaner Foam Element	28
Dealer Test Ride List	12	Paper Element	28
Dealer Delivery To Customer List	13	Spark Arrester	29
Customer Acceptance List	13	Spark Arrester Maintenance Schedule	29
<b>Section 4: Operating Instructions</b> .....	<b>14</b>	Spark Arrester Maintenance Procedure	29
Operator Responsibilities	14	Replacement Parts	29
Pre-Start Check List	14	Maintenance Schedule	30
General Operation	14	<b>Section 7: Lubrication and Fluids</b> .....	<b>31</b>
Starting the Engine	14	Engine Oil	31
Dashboard Switches and Instruments	14	Differential Oil	33
Foot Operated Controls	15	Transmission Fluid	34
Hand Operated Controls	16	Brake Fluid	34
Fuel Indicator	16	Steering & Cargo Lift Cylinder Fluid	35
Steering	17	Grease Type Lubrication	35
Driving Conditions	17	Driveline U-Joints	35
Towing the Gondo	18	Pillow Block Bearing	36
Traveling Tips From the Trail Masters	19	Rotating Bearing Surfaces	36
<b>Section 5: Options and Accessories</b> .....	<b>21</b>	<b>Section 8: Seasonal Storage</b> .....	<b>37</b>
Gondo Options	21	Engine Preparation for Storage	37
Rear Cargo Box	21	Vehicle Storage Preparation	37
Tires	21	Vehicle Removal From Storage Preparation	37
Gondo Accessories	21	<b>Section 9: Body Repair</b> .....	<b>38</b>
<b>Section 6: Maintenance</b> .....	<b>22</b>	Introduction	38
General Maintenance	22	Light Scuff	38
Prepare Vehicle for Maintenance	22	Scratch	38
Torque Values	22	Deep Gouge	39
Wheel Lug Nuts	22	<b>Section 10: Specifications and Capacities</b> .....	<b>40</b>
Engine Torques	23	<b>Section 11: Troubleshooting</b> .....	<b>41</b>
All Other Torques	23	<b>Section 12: Appendix</b> .....	<b>45</b>
Tire Maintenance	23	Torque Values Chart	45
Jacking the Vehicle	23	Notes	46
		Land Pride Limited Warranty	47

© Copyright 2008 All rights Reserved

Land Pride provides this publication "as is" without warranty of any kind, either expressed or implied. While every precaution has been taken in the preparation of this manual, Land Pride assumes no responsibility for errors or omissions. Neither is any liability assumed for damages resulting from the use of the information contained herein. Land Pride reserves the right to revise and improve its products as it sees fit. This publication describes the state of this product at the time of its publication, and may not reflect the product in the future. The illustrations in this manual are not intended for safe and proper assembly or disassembly of equipment. The illustrations are intended for ordering parts only.

Land Pride is a registered trademark.

All other brands and product names are trademarks or registered trademarks of their respective holders.

Printed in the United States of America.



## Section 1: Introduction

Land Pride welcomes you to its growing family of new product owners. Gondo series trucks are heavy duty utility vehicles that have been designed with care and built by skilled workers using quality materials. Proper set-up, maintenance and safe operating practices will help you get years of satisfactory use from this vehicle.

### Safety First

Land Pride is fully aware of the need for safe operating procedures around all of our equipment. We hope you will make a sincere effort to put safety above all other priorities. The Gondo is designed and built for serious work, recreation and enjoyment; however, improper and irresponsible operation could result in serious injury or death. Since this is an off-road vehicle, operators will seldom see the road safety and warning signs they are accustomed to seeing on highways and public streets. This places additional responsibility on the driver to operate this vehicle well within the safe operational limits and capabilities of the unit.

This manual has been prepared to instruct you in the safe and responsible operation of your Gondo. Please read and abide by all safety alert information about this vehicle. If you do not understand any part of this manual, contact your local dealer for additional information and clarification. As the operator of this piece of equipment, you are in complete control. Only you can prevent an accident from happening!

### Using This Manual

- Prior to any vehicle operation it is absolutely essential that you read and comprehend each section in this manual to develop an understanding of your vehicle and safety practices. After reviewing this manual, store it in a dry and easily accessible place for future reference.
- The Operator's Section is designed to help familiarize you with safety, assembly, operation, adjustments, troubleshooting and maintenance. Read this manual and follow the recommendations to help ensure safe and efficient operation.
- The information contained within this manual was current at the time of printing. Some parts may change slightly to assure you of the best performance.
- To order a new Operator's or Parts Manual contact your authorized dealer. Manuals can also be downloaded, free-of-charge from our website at [www.landpride.com](http://www.landpride.com) or printed from the Land Pride Service & Support Center by your dealer.

### Terminology

Right-hand and left-hand as used in this manual are determined by facing the direction the vehicle will travel while in use unless otherwise stated.

### Definitions

The following terms are used throughout this manual.

**IMPORTANT:** A special point of information related to its preceding topic. Land Pride's intention is that this information should be read and noted before continuing.

**NOTE:** A special point of information that the operator must be aware of before continuing.

### Application

#### Models Covered

4400EX

#### Getting Acquainted with your Gondo

The Land Pride Gondo is an extreme utility vehicle designed exclusively for off-road use. It is not designed, properly equipped, or licensed to be safely operated on public streets and highways. This 2200lb. payload hauler is designed to carry two people in the cab and a generous amount of cargo, gear, and supplies safely and conveniently over extremely difficult or rough terrain.

The Gondo features center articulating power steering coupled with a pivoting interactive frame for unexcelled terrain hugging capability and maximum traction. Traction capabilities are even further maximized with incorporation of full-time shaft driven four-wheeled drive. The Gondo is powered by the proven 624cc 20hp Kohler Command Pro Series Engine and a fully automotive 4 or 5 speed synchromesh manual transmission. Engaging the eight-inch manual clutch delivers power to the automotive grade front and rear open differentials.

The Gondo is equipped with highly dependable four wheel hydraulically activated automotive drum type brakes. A manual park brake is included as standard equipment. Engine braking is inherently available through the standard transmission when needed for traveling down steep or slippery and treacherous grades. All four tires are 26x12-12 4-ply and are available with turf or bar type tread.

The Gondo frame is tractor tough and constructed out of welded and formed heavy wall tubing that is coated with a durable black satin powder paint finish. A certified rollover protection system (ROPS) with seat belts is standard equipment. (But may be left off by customer's choosing.)

The console body and optional cab are constructed of extra tough fiberglass with an attractive gel coat finish. The high capacity cargo beds are made of welded and formed heavy gauge sheet metal finished with black satin powder

## Section 1: Introduction

paint. Customers can choose either a 23 cu. ft. capacity gondola style box or an 18 cu. ft. capacity tilt box with a standard tailgate. Choosing the hydraulic tilt option makes both boxes capable of hydraulically dumping their full 1800lb. payload capacity by simple activation of a lever on the operator's console. A standard receiver type hitch comes as standard equipment and this unit is capable of up to 2500 lbs. of towing capacity.

The operator's station is a cab-forward style console that hinges forward and has aft suspension over two coil-over shocks providing a smoother ride and increased operator and passenger comfort. Two cushioned high back bucket seats are provided as standard equipment and seatbelts are also standard for units equipped with a ROPS. The operators console is equipped with a standard hour meter, voltmeter, 12 volt keyed ignition, and light switch to activate the two standard halogen beam headlights.

Customers needing additional protection from the elements and surrounding environment can also order additional accessories such as cabs with safety glass windshields, powered wipers, and soft sided cab doors. Snowplows and log skidders are also available for added versatility.

Whether you are hauling big game, farming tools, hunting and fishing camp supplies, construction equipment, livestock feed, military cargo, or fire fighting and rescue equipment, the Gondo is capable of getting you and your cargo there and back over tough and extreme terrain and in all kinds of weather.

## Owner Assistance

The safety video should be viewed by the owner and the Warranty Registration card should be filled out by the dealer at the time of purchase. The owner should also receive a copy of the safety video upon purchasing the vehicle as well as have participated in a short drivers training course with the dealer. This information is necessary to provide you with quality customer service.

The parts on your Gondo Heavy Duty Utility Vehicle have been specially designed and should only be replaced with genuine Land Pride parts.

If customer service or repair parts are required contact a Land Pride vehicle dealer. They have trained personnel, genuine repair parts and equipment specially designed to repair Land Pride products.

## Serial Number Plate

*Refer to Figure 1*

Always use serial and model number when ordering parts from your Land Pride dealer. The serial-number plate is located on the driver's side on the center swivel yoke as shown below.

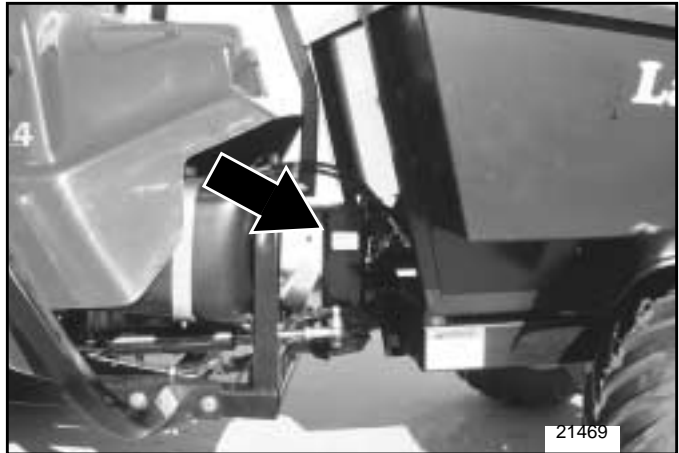

**Serial Number Plate**  
**Figure 1**

Record your vehicle model number (4400EX) and serial number here for quick reference:

Model Number: \_\_\_\_\_

Serial Number: \_\_\_\_\_

Your Land Pride dealer wants you to be satisfied with your new vehicle. If you do not understand any part of this manual or are not satisfied with the service received, please take the following actions.

1. Discuss the matter with your dealership service manager. Make sure they are aware of any problems so they can assist you.
2. If you are still unsatisfied, seek out the owner or general manager of the dealership.
3. For further assistance write to:

## Product Support

**Land Pride Service Department**  
**1525 East North Street**  
P.O. Box 5060  
Salina, Ks. 67402-5060

E-mail address  
lpservicedept@landpride.com

**Section 2: Important Safety Information**

**Important:** Read and understand all pages in this manual thoroughly before operating your vehicle.

**These are common practices that may or may not be applicable to the products described in this manual.**

**Safety Symbol**

**Look for the Safety symbol throughout this manual.** The SAFETY ALERT SYMBOL indicates there is a potential hazard to personal safety involved and extra safety precaution must be taken. When you see this symbol, be alert and carefully read the message that follows it. In addition to design and configuration of equipment, hazard control and accident prevention are dependent upon the awareness, concern, prudence and proper training of personnel involved in the operation, transport, maintenance and storage of equipment.



**Be Aware of Signal Words**

Signal words designate a degree or level of hazard seriousness. The signal words are:

**! DANGER**

*DANGER indicates an imminently hazardous situation which, if not avoided, will result in serious injury or death. This signal word is limited to the most extreme situations, typically for vehicle components that, for functional purposes, cannot be guarded.*

**! WARNING**

*WARNING indicates a potentially hazardous situation which, if not avoided, could result in death or serious injury, and includes hazards that are exposed when guards are removed. It may also be used to alert against unsafe practices.*

**! CAUTION**

*CAUTION indicates a potentially hazardous situation which, if not avoided, may result in minor or moderate injury. It may also be used to alert against unsafe practices.*

**For Your Protection**

- ▲ Thoroughly read and understand the "Safety Decal" section, read all instructions noted on the decals.

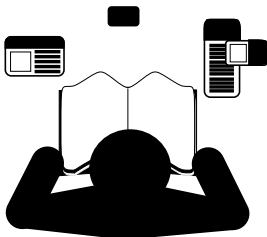

**Before Operating**

- ▲ This Gondo Heavy Duty Utility Vehicle is not to be driven on public roads.
- ▲ Do not operate this vehicle under the influence of alcohol or drugs.
- ▲ Always inspect the vehicle before operating it. See "Pre-Start Check List" on page 14.

- ▲ Do not operate this machine unless all safety shields are in place and all badly worn, broken or missing parts have been properly replaced.
- ▲ Wear appropriate protective gear and clothing such as safety helmet, goggles, gloves, coveralls, etc., when conditions warrant.
- ▲ No driver under age of 16.

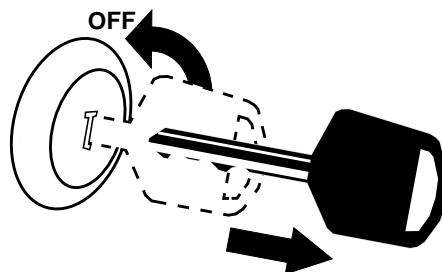

## Section 2: Important Safety Information

### Practice Safe Maintenance

- ▲ Understand procedure before doing work. Use proper tools and equipment. Refer to this manual for additional information.
- ▲ Work in a clean, dry area.
- ▲ Place the vehicle in neutral, set parking brake, turn off engine and remove key before performing maintenance. Chock wheels if you must perform maintenance on a slope.

- ▲ Make sure all moving parts have stopped and all system pressure is relieved.
- ▲ Allow the engine to cool completely.
- ▲ Disconnect battery ground cable (-) before servicing or adjusting electrical systems or before welding.

- ▲ Inspect all parts. Make sure parts are in good condition and installed properly.
- ▲ Remove build-up of grease, oil or debris.
- ▲ Remove all tools and unused parts from the Gondo before operation.

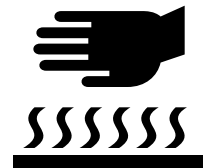
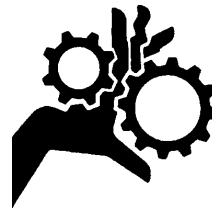
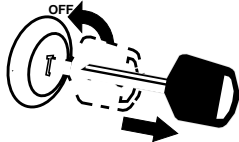

### Prepare for Emergencies

- ▲ Be prepared if a fire starts.
- ▲ Keep a first aid kit and fire extinguisher handy.
- ▲ Keep emergency numbers for doctor, ambulance, hospital and fire department near phone.

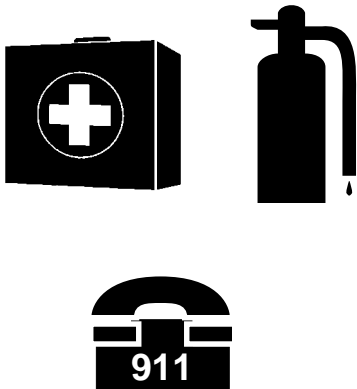

### Wear Protective Equipment

- ▲ Wear protective clothing and equipment.
- ▲ Wear clothing and equipment appropriate for the job. Avoid loose-fitting clothing.
- ▲ Because prolonged exposure to loud noise can cause hearing impairment or hearing loss, it is best to wear suitable hearing protection such as earmuffs or earplugs.
- ▲ Because operating equipment safely requires your full attention, avoid wearing radio headphones while operating machinery.
- ▲ It is the discretion of the operator and passenger to wear Seat Belts when available.



### Tire Safety

Tire changing can be dangerous and should be performed by trained personnel using correct tools and equipment.

- ▲ When inflating tires, use a clip-on chuck and extension hose long enough for you to stand to one side—not in front of or over tire assembly. Use a safety cage if available.
- ▲ When removing and installing wheels, use wheel-handling equipment adequate for weight involved.



## Section 2: Important Safety Information

### Safe Operating Procedures

The safe operation of any machinery is a big concern to all consumers. Your Gondo has been designed with many built-in safety features. However, no one should operate this vehicle before carefully reading this Operator's Manual. Also read all instructions noted on the safety decals.



#### **WARNING**

*Most accidents with off road vehicles occur when traveling up, down, or across the face of a slope. Refer to operation instructions and safety video for proper operation procedures.*

- ▲ Be familiar with all functions of this vehicle.
- ▲ Keep all bystanders away from this vehicle during operation.
- ▲ Do not allow anyone to operate this vehicle who has not fully read and comprehended this manual and who has not been properly trained in the safe operation of this vehicle.
- ▲ Do not operate a vehicle with damaged or defective parts. Repair all damages and defective parts before putting vehicle back in to service.
- ▲ Do not allow anyone under 16 years of age to operate this vehicle.
- ▲ Operator must always use both hands on the steering wheel.
- ▲ A rider may, without knowing it, place his foot on the accelerator pedal while bracing himself against a rough ride. This makes it impossible to slow down the vehicle until the passenger removes his foot from the pedal. Inform the passenger to keep his foot off the accelerator and always slow down before the ride gets rough.
- ▲ Operator and passenger are responsible for deciding if their situation warrants using seat belts if so equipped.
- ▲ Do not use cargo bed as an additional passenger carrier.
- ▲ Do not use cargo bed as a working platform.
- ▲ The cargo power lift is designed to dump cargo only. Do not use it to lift other objects.
- ▲ No riders allowed except in factory designed and supplied seating and no more than one person in a seat. Do not use cargo bed for carrying people. Maximum vehicle occupancy including driver is 2.
- ▲ Operate vehicle from driver's seat only.
- ▲ Do not leave vehicle unattended with engine running.
- ▲ Do not dismount a moving vehicle as serious injury or death could occur.
- ▲ Always operate vehicle with all guards installed. Do not leave pulleys, belts and other rotating components exposed.
- ▲ Wear snug-fitting clothing to avoid entanglement with moving parts.
- ▲ Do not wear clothing or other articles that hangs loosely. Hanging clothing, long hair, jewelry etc. can catch in the tires and other rotating objects.
- ▲ Keep hands, feet, long hair, clothing and jewelry away from moving parts and obvious pinch points to avoid getting caught.
- ▲ Some conditions may warrant extra safety gear to be worn such as safety helmets and/or goggles.
- ▲ Keep hands, arms, feet and all bodily appendages safely inside the confines of the vehicle. Always be aware of and avoid tree limbs and brush that have a potential of hitting and/or poking individuals riding the vehicle. Serious body harm could result.
- ▲ Make sure area behind cargo box is clear of personnel before operating the dump lever. Bodily harm can result from being pinched between the cargo box and another object or from a load dumping and/or rolling onto a bystander.
- ▲ Do not touch engine, engine exhaust pipe and/or muffler while they are hot.
- ▲ Use extreme caution when driving through dry grass, brush and other fire hazard materials. Never stop or park over combustible materials. Keep grass and brush from collecting on and around engine and muffler parts.
- ▲ Battery fumes are explosive. A spark will ignite battery fumes. Wear a face shield when charging or jumping a battery. Follow all battery safety rules outlined in this manual.
- ▲ Always disconnect the negative battery terminal before making adjustments to the vehicle electrical system or welding on this vehicle.
- ▲ Avoid battery acid spills. Do not get battery acid on eyes, face, or other body parts. Flush eyes and other body parts immediately with water for at least 15 minutes if battery acid has gotten on them.
- ▲ Avoid pinch point hazards. Cargo bed, seat platform and vehicle center pivot steering hinge creating pinch points.
- ▲ Do not stand, reach or allow any body part to enter between the cab and cargo bed (articulating area) while vehicle is running. This is an extremely high dangerous pinch point area caused from turning the steering wheel.
- ▲ Always make certain the articulating area between the cab and cargo bed is clear of personnel before turning the steering wheel. The steering wheel will turn the vehicle at its articulation point whether the vehicle is running or not.
- ▲ Do not operate this vehicle on highways, public roads, or where it may be a hazard to faster moving traffic.
- ▲ Never attempt wheelies, jumps, or other stunts. Never drive recklessly. Always operate your vehicle at a safe speed that will allow you to maintain control.
- ▲ Never modify any parts on the vehicle without authorization. Unauthorized modifications will void warranty to all parts directly and indirectly affected by the modification.

## Section 2: Important Safety Information

---

- ▲ Never use this vehicle for racing. This vehicle is designed to achieve ground speeds up to 17mph. Any unauthorized modifications intended to increase the ground speed of this vehicle above 17mph may result in cancellation of the vehicle warranty and may be in direct violation of laws regulating current air quality standards.
- ▲ Avoid sudden stops, starts and turns.
- ▲ Be aware of cargo shifting when stopping or moving. Make sure all cargo is properly secured and tied down. Injury could result from loose cargo.
- ▲ Do not operate vehicle while drinking or under the influence of alcohol or drugs.
- ▲ Always make sure vehicle pathway is clear of all objects when backing up. Know location of persons around vehicle and especially location of small children. Take extra precautions when rear view is hindered by cargo.
- ▲ Do not exceed total payload capacity of this vehicle. Over-loading can cause loss of control resulting in severe injury or death.
- ▲ Always maintain proper tire inflation. See "Tire Maintenance" on page 23.
- ▲ Do not pull a trailer or implement exceeding 2,500 lbs. towing capacity and 250 lbs. tongue weight. Loss of control may result.
- ▲ Do not attach an implement, trailer or other device to the hitch that will produce negative tongue weight.
- ▲ Do not tow or pull the Gondo behind another vehicle except to retrieve it a short distance from an area where a trailer won't go. The Gondo should be loaded on a trailer for towing. Follow all towing instructions in this manual when towing the Gondo.
- ▲ Do not use the vehicle as an anchor device.
- ▲ Beware, tow ropes, cables and chains can break when pulling another vehicle or object causing serious injury or death to anyone in line with the whipping action created when they break. Never jerk when pulling, always ease into a pull gently. Always stay clear of the tow line. Never be in line with the tow line.
- ▲ Reduce speed and payload on hilly, rough, wet, slick or unstable ground.
- ▲ Reduce speed when loaded with cargo. Heavy cargo load takes longer to stop.
- ▲ Always make turns at a speed that will maintain control of vehicle. Never make turns at full speed. Reduce speed when turning empty and reduce speed even more when turning loaded. The heavier the cargo load, the slower the turn should be.
- ▲ The certified ROPS (Roll Over Protection System) serves only as a protection device. Always avoid rollovers.
- ▲ Do not load ROPS with heavy equipment. Rollover could result from such loading.
- ▲ Always park on level ground, stop engine, set park brake and remove ignition key before leaving the vehicle. Chock tires if condition warrants.
- ▲ Use extreme caution when cresting hills or when visibility is limited. Proceed slowly until you are sure trail conditions immediately ahead are safe.
- ▲ Keep front wheels straight when cresting hills or going over bumps.
- ▲ Do not stop, start suddenly or over accelerate on hills. Loss of control and rollover could result.
- ▲ Use extreme caution when descending hills, running on loose slippery surfaces, or when towing at maximum capacity. Towing, braking and tractive capabilities are greatly diminished.
- ▲ Do not operate vehicle on slopes over 15°.
- ▲ Avoid changing direction or making sharp steering corrections on slopes or rollover may occur.
- ▲ If this vehicle begins to tip when crossing a slope, turn the front wheels downhill to regain stability and control.
- ▲ When crossing a slope on soft terrain, turn the front wheels slightly uphill and maintain a constant speed to maintain a straight line of travel.
- ▲ When descending hills or slopes apply steady pressure to the foot brake to avoid potential freewheeling or runaway. Do not shift vehicle out of gear. Take full advantage of engine braking.
- ▲ Never allow vehicle to coast or free wheel in neutral or loss of control may result.
- ▲ If your vehicle loses power and stops on a hill, immediately engage the foot brake. Press down on the clutch and gently release brakes while backing slowly down the hill maintaining a straight downhill line of travel. Do not attempt to turn the vehicle sideways on the hill or a rollover could result.
- ▲ When traveling at night always use your headlights and reduce speed according to visibility, trail and terrain conditions.
- ▲ Avoid water crossings when possible and never cross a body of water where depth is unknown. Loss of power will occur if engine becomes submerged or wet. Unnecessary crossing of streams and waterways erodes shore line and damages water-born habitat. If you must cross, do it at a point where banks are not steep and proceed at a slow and steady speed. Do not travel in water that is higher than the floor board. Water higher than this can damage the engine stalling the vehicle. However, **intermittent** stream crossings where depth of water briefly comes into contact with bottom of engine is acceptable. See "**Going Out on the Trail**" Note 7 on page 19.
- ▲ Front bumper, brush guards and cargo box are not designed as pusher bars. Do not attempt to push other vehicles or implements or damage may result.
- ▲ When refueling use a UL approved non-metallic container that has no screen or filter. Set the container on the ground before fueling to eliminate static discharge and do not use Methanol fuel.



## Section 2: Important Safety Information

- ▲ Do not smoke or use electrical devices including cell phones while refueling.
- ▲ Always check wheel lug nut torque values two hours after initial operation and two hours after each tire repair and/ or replacement. Routinely check lug nut torque valves every 100 hours of operation. See "Wheel Lug Nuts" on page 22.
- ▲ Support this vehicle securely before working beneath. Chock wheels to prevent vehicle from rolling.
- ▲ Do not inspect hydraulic leaks with bare hands. Always use an object such as a stick to inspect for leaks. Severe injury can occur from pressurized oil breaking through skin.
- ▲ Do not operate the vehicle with hydraulic leaks, frayed or kinked hoses. Repair or replace hydraulic leaks and damaged hoses immediately.

## Safety Decals

1. Your Gondo Heavy Duty Utility Vehicle comes equipped with all safety decals in place. They were designed to help you safely operate this vehicle and to serve as a reminder to keep safety uppermost in your mind. Read and follow decal directions.
2. Keep all safety decals clean and legible.
3. Replace all damaged or missing decals. Order new safety decals through your Land Pride dealer.
4. Some new equipment installed during repair requires safety labels to be affixed to the replaced component as specified by Land Pride. When ordering new parts or components, also request corresponding safety decals.
5. Refer to this section for proper label placement. Install new decals as follows
  - a. Clean the area on which the decal is to be placed.
  - b. Spray soapy water on the surface where the decal is to be placed.
  - c. Peel backing from decal. Press firmly on surface, being careful not to cause air bubbles under decal.
  - d. Squeeze out air bubbles with the edge of a credit card.



**818-543C**

Danger: Guard Missing



**838-303C**

Danger: Battery



Section 2: Important Safety Information

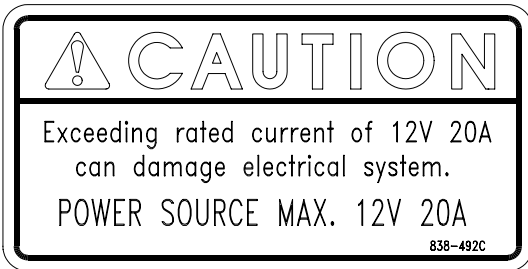

**838-492C**

Caution: Maximum Power Source

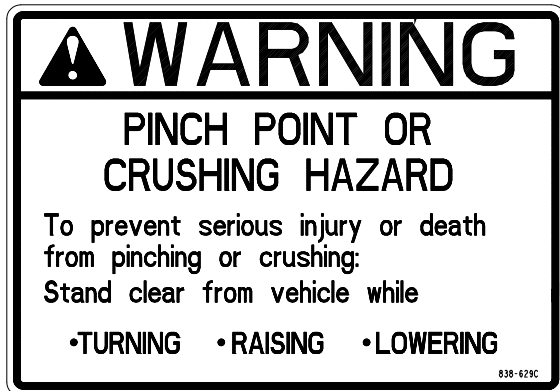

**838-629C**

Warning: Pinch Point or Crushing Hazard



Section 2: Important Safety Information

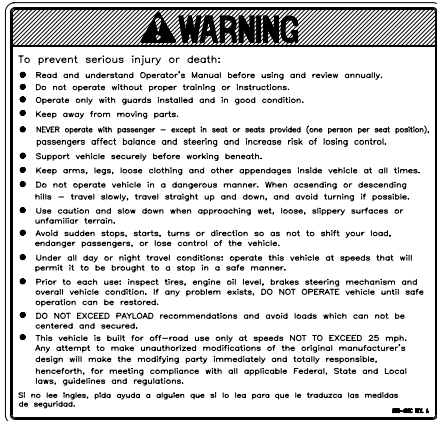

**838-486C**

Warning: General Utility Vehicle



21439



**838-489C**

Warning: Rollover Hazard



21439



**838-491C**

Warning: Improper Use



21439

Section 2: Important Safety Information

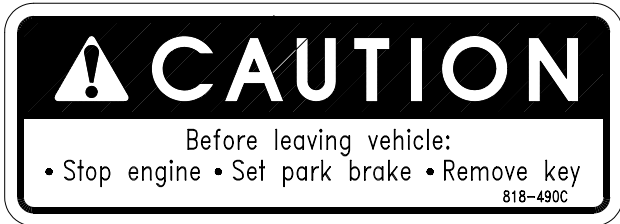

**838-490C**

Caution: Stop Engine

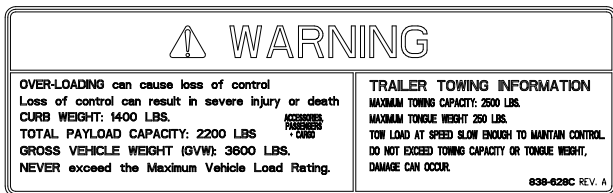

**838-628C**

Warning: Load Rating and Trailer Towing Information



**838-508C**

Warning: Before Filling Tank with Gasoline



Section 2: Important Safety Information

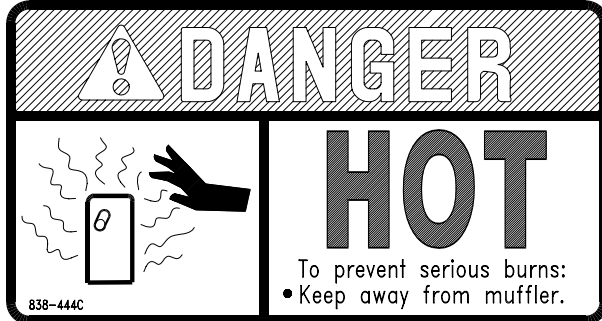

**838-444C**  
Danger: Muffler hot



**Warning Label Included with Seat**  
Warning: Check Seat mounting





## Section 3: Pre-Delivery and Check List

Each vehicle must undergo a Pre-Delivery Inspection by the Dealer. Listed below is an example of the checklist that is included with the Warranty Registration that is to be submitted to Land Pride upon Retail Sale. The Pre-Delivery Certificate and Warranty Registration must be submitted to Land Pride in order to activate the vehicle warranty.

### Pre-Delivery Certificate

The dealer is required to complete Land Pride's "Certificate of Heavy Duty Utility Vehicle Pre-Delivery" form before customer may take possession of the vehicle. The information must be filled in and check list checked off or initialed by individuals performing the checks. Dealership's name, signatures of individuals filling in the form, seller's signature, customer's signature and signing dates are also required before the form is returned to Land Pride. Below is a list of the information found in the form that is required to be completed and checked off.

#### Vehicle Information

Model No. \_\_\_\_\_  
 Date \_\_\_\_\_  
 Serial No. \_\_\_\_\_  
 Engine Serial No. \_\_\_\_\_

#### Dealer Service and Inspection List

- \_\_\_ Fully charge battery. Check battery voltage to verify that it is fully charged.
- \_\_\_ Check tire pressure to make sure front tires have 15 psi and rear tires have 20 psi.
- \_\_\_ Make sure wheel lug bolts/nuts are tightened to 90 Newton meters/(65ft. lbs.).
- \_\_\_ Check master cylinder to make sure it is filled.
- \_\_\_ Check engine oil level at the dipstick. Add SAE 10W30 oil if oil is below the full mark on the dipstick.
- \_\_\_ Check engine for correct RPM. Set to factory specification if needed. (See page 40)
- \_\_\_ Check steering cylinder for tightness.
- \_\_\_ Check choke control. It should move and return freely.
- \_\_\_ Step on foot brake to make sure there is plenty of pedal and that brakes hold pressure and do not bleed off. Add brake fluid and bleed brakes if required.
- \_\_\_ Make sure seats and seat belts are properly fastened to the frame if so equipped.
- \_\_\_ Make sure all safety decals are in place.
- \_\_\_ Check headlights to make sure they are working and are properly mounted.

- \_\_\_ Inspect air cleaner element. Make certain it is clean and in place.
- \_\_\_ Inspect the fuel tank to make sure it is properly installed and that there are no leaks.
- \_\_\_ Check fuel level to make sure there is at least 1/8 of a tank of gas prior to performing initial starting operations.
- \_\_\_ Inspect fuel lines to make sure they are properly installed and that there are no leaks.
- \_\_\_ Check steering by executing a full lock to lock turn in each direction.
- \_\_\_ Check park brake to make sure it will engage, hold and release.
- \_\_\_ Make sure neutral start feature is working by depressing the clutch to start the unit.
- \_\_\_ Check throttle control to make sure it moves and returns freely.
- \_\_\_ Check differential oil level at the differential oil plug. Add 80/90 gear lube if oil is below oil plug outlet.
- \_\_\_ Check overall appearance for cleanliness and for body and molding damage.

#### Dealer Test Ride List

- \_\_\_ Check engine for starting, accelerating, running and idling smoothly.
- \_\_\_ Check steering response. There should be no free-play.
- \_\_\_ Check forward, neutral and reverse shifting response. Also check neutral start response by depressing the clutch to start the vehicle.
- \_\_\_ Check park brake to make sure it engages, holds and disengages.
- \_\_\_ Make sure rocker switches are all working.
- \_\_\_ Make sure throttle is responsive and returns freely.
- \_\_\_ Make sure suspension ride is satisfactory and stable.
- \_\_\_ Make sure there are no fuel or petroleum leaks.
- \_\_\_ Make sure the foot brake has a firm engagement and that stopping is straight.
- \_\_\_ Make sure there are no bad rattles or vibrations.

## Section 3: Pre-Delivery and Check List

---

### Dealer Delivery To Customer List

- Warranty registration form is complete.
- Owner's Manual has been delivered to and reviewed by the customer.
- Engine Manual has been delivered to and reviewed by the customer.
- Warranty Policy limits and requirements have been explained to the customer.
- Customer has reviewed the safety video.
- Location and functions of vehicle controls have been explained.
- Fuel transportation and storage procedures have been explained.
- Fluid fill and lubrication points have been located and explained to the customer.
- Customer has completed the driving course.
- Information on the safety decals have been reviewed with the customer.

### Customer Acceptance List

Customer initials required where accepted as successfully completed.

- Customer has reviewed and understands Land Pride warranty policy.
- Customer has inspected the vehicle and it meets customer's satisfaction.
- Customer understands the importance of following the owner's manual instructions.
- Customer has completed the Land Pride safety training course.

## Section 4: Operating Instructions

### Operator Responsibilities

#### **WARNING**

It is the operator's responsibility to have read this manual thoroughly and to know how to operate this vehicle safely in all situations. See "Section 2: Important Safety Information" starting on page 3.

#### Pre-Start Check List

- Lubricate the vehicle as indicated in the Lubrication portion of "Section 7: Lubrication and Fluids" on page 31.
- Check tire pressure as indicated in the "Tire Inflation Chart" on page 23.
- Make sure wheel lug bolts/nuts are tightened to 65ft. lbs.
- All nuts, bolts, screws and fasteners should be checked. Refer to the Torque Value Chart in "Section 12: Appendix" starting on page 45.
- Turn on headlights to make sure battery has a charge and electrical lighting circuit is working.
- Step on the foot brake and hold down to make sure it can be applied with plenty of pedal movement remaining and that the brakes hold without losing pressure. Add brake fluid as indicated in "Brake Fluid" on page 34. Bleed brakes if required.
- Check park brake to make sure it will engage, hold and release.
- Check steering by executing a full lock to lock turn in each direction.
- Check neutral start feature by depressing the clutch and starting the vehicle. (The vehicle should not start unless the clutch is depressed.)
- Check engine oil level at the dipstick. Add oil as indicated in "Engine Oil" on page 31 if oil is at or below the add mark on the dipstick. Do not overfill or plug fouling will occur.
- Check differential oil level at the differential oil plug. Add gear lub as indicated in "Differential Oil" on page 33 if oil is below oil plug outlet.
- Check fuel level to make sure there is at least 1/8 of a tank of gas prior to performing initial starting operations.
- Allow engine to warm up for 15 minutes or more to reach operating temperature before checking to make sure engine idle speed is set at 1100 +/- 100 rpm and that maximum engine static speed does not exceed 3800 rpm. **Modifying or adjusting the carburetor to increase vehicle speed above factory set specification is a safety violation and could result in voiding the warranty.**

### General Operation

#### Starting the Engine

Follow starting procedures displayed at the gearshift lever and as noted below.

#### **DANGER**

Avoid injury or death from entanglement in the rotating components and pinch points. All shields must be in place and secure when operating. Keep all persons away from rotating components and pinch points.

1. Set park brake.
2. Place gearshift in neutral. Depress clutch pedal. Engine will not start with clutch pedal out.
3. Apply choke fully when engine is cold.
4. Turn ignition key fully clockwise and hold until engine starts.
5. Release ignition key to run position and choke to normal operating position immediately after engine starts.
6. Turn ignition key counterclockwise to stop engine.

Operating a Gondo is like operating a car with a standard transmission that has four or five speeds forward and one reverse. The keyed 12 volt electronic ignition with a neutral start and clutch depressed feature makes for safe and easy starting.

Braking is accomplished by simply depressing the automotive style brake pedal located on the floorboard. This activates both front and rear automotive type hydraulic drum brakes. Depress clutch and brake pedals when coming to a complete stop. A lever action parking brake is mounted on the floor board between operator and passenger seats. Push the lever forward to the horizontal position to engage the park brake and pull back to the vertical position to release.

Raise cargo box by pulling back and holding on the dump lever. Push forward on the lever and hold to lower the cargo box. Stop cargo box movement by releasing the lever.

#### **DANGER**

Make sure area behind cargo box is clear of personnel before operating the dump lever. Bodily harm can result from being pinched between the cargo box and another object or from a load dumping and/or rolling onto a bystander.

### Dashboard Switches and Instruments

Refer to Figure 4-1A and Figure 4-1B on page 15

- #1 **Light Switch:** Turns on two sealed beam head lights when the switch key is on. Press top of light switch to turn on lights and bottom of switch to turn off lights.
- #2 **Auxiliary Switch Slot:** A 12 volt on/off accessory switch may be installed at this location to operate an auxiliary accessory such as a power winch.



## Section 4: Operating Instructions

**#3 Choke Switch:** Used to increase fuel mixture to help start the engine when it is cold. Pull choke knob out and hold to start a cold engine. Release knob after engine has started. Do not choke an engine that is hot from operating. Engine flooding may result. To avoid running the battery down, allow a flooded engine to set 15 to 30 minutes before attempting to restart it. Hold the accelerator pedal all the way down without applying the choke while starting a flooded engine.

**#4 Hour Meter:** Indicates number of hours vehicle has run to the nearest 1/10 of an hour.

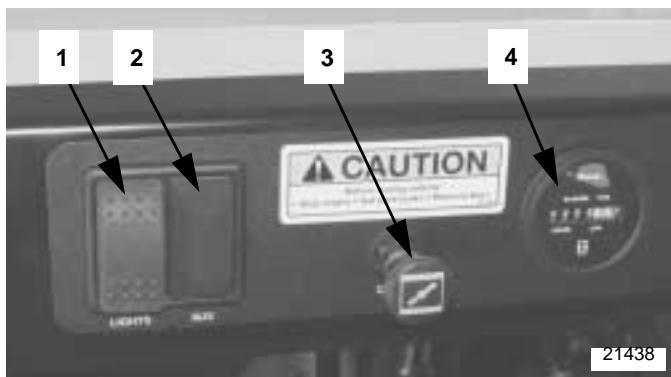

Figure 4-1A

**#5 Volt Meter:** Indicates battery is charging. Check battery if volt meter registers a charge that is lower than normal. See your authorized Land Pride dealer if battery is good and volt meter still register low charge.

**#6 Ignition Switch:** Starts and shuts off the engine. The engine is off when the switch key is in its vertical position. See "Starting the Engine" on page 14 for correct starting procedures.

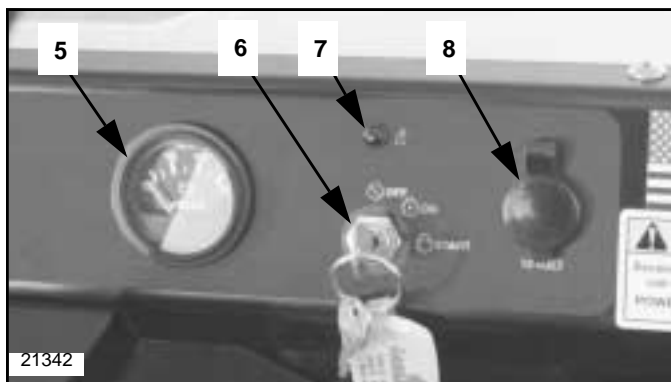

Figure 4-1B

**#7 Oil Light:** Indicates low oil pressure if illuminated while engine is running. Stop engine immediately if light is on. Check oil level and add if low. See your authorized Land Pride dealer if oil level shows full on

the dipstick and oil light stays on after the engine is running.

**NOTE:** It is normal for the oil light to come on when the ignition switch is turned on and stay on until the engine is running.

**#8 Power Plug Outlet:** 12 volt accessories such as a cell phone or light can be connected to this outlet.

### Foot Operated Controls

Refer to Figure 4-2

**#9 Accelerator Pedal:** Changes engine rpm and vehicle ground speed. Press down on the accelerator pedal with your foot to increase speed and let up on the pedal to decrease speed.

**IMPORTANT:** Vehicle should not move on level ground while engine is idling and brakes are not applied. See your nearest Land Pride dealer if vehicle moves.

### WARNING

Always release clutch pedal slowly when starting and changing gears. Sudden release of the pedal can damage the power train and jerk the vehicle injuring the operator and/or passenger.

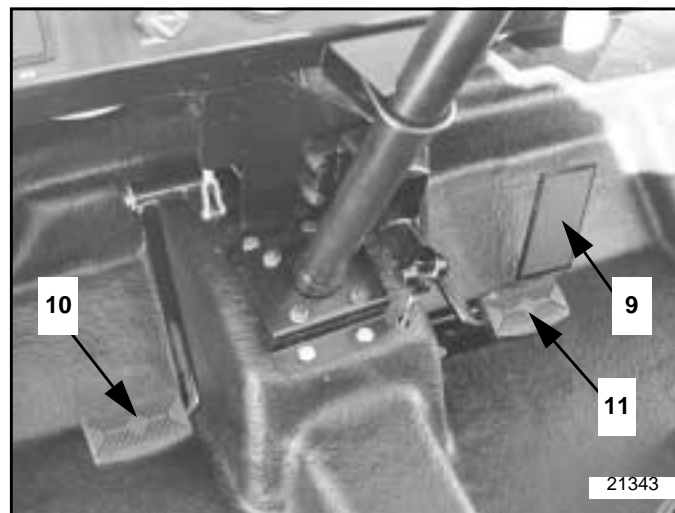

Figure 4-2

**#10 Clutch Pedal:** Stops transfer of engine power to the transmission without stopping the engine from running. Always change gears while holding the clutch pedal down. The clutch and brake must always be applied when bringing the vehicle to a complete stop. See #11, Brake Pedal for stopping the vehicle.

**IMPORTANT:** Always press clutch pedal fully down. Resting your foot on clutch pedal can cause clutch plates to slip and shorten their life.

## Section 4: Operating Instructions

### DANGER

Sudden hard braking pressure can throw occupants forward causing body injury and death. Whenever possible, apply pressure to the brake pedal gently and increase pressure slowly until desired braking force is achieved.

**#11 Brake Pedal:** Slows vehicle speed quickly and stops vehicle. Slow vehicle speed quickly by removing your foot from the accelerator pedal and then apply pressure to the brake pedal. Apply clutch and brake pedal before coming to a complete stop.

**NOTE:** Do not rest foot on brake pedal while driving vehicle except when slowing or stopping. Pressure on the brake pedal will shorten life expectancy of brake liners.

### Hand Operated Controls

Refer to Figure 4-3

**#12 Park Brake Lever:** The park brake lever is located on the floor board right of the operator and should be set at all times the vehicle is not in operation. Push the lever forward to the horizontal position to set the brake. Release the brake by pulling back on the lever to the vertical position. Do not drive vehicle with park brake on.

The knob on the end of the handle may be turned to make minor adjustments to the braking capabilities. Major adjustments should be made at either end of the brake cable.

**#13 Dump Lever:** Dump lever activates the hydraulic cylinder to raise and lower the cargo box. Push lever forward to raise cargo box. Pull lever back to lower cargo box.

**#14 Auxiliary Lever:** Auxiliary lever is used to operate a hydraulic cylinder on a front mounted snow blade or to operate equipment pulled by the Gondo. Additional accessories must be purchased to make hydraulic connections.

**IMPORTANT:** Release dump lever immediately when cargo box is fully up or down to extend hydraulic seal life and to prevent overheating.

**#15 Gear Shift Lever:** Changes transmission gears from neutral to one of the four forward speeds or reverse. Always start engine with gear shift in neutral. Follow the shift pattern on the shift lever to find your selected gear.

Always start in first gear when under load or on an incline. You may start in second gear if on the level with no load and no incline. Shift up to the next higher

gear only after reaching sufficient speed and engine RPM. Continue shifting up to the next higher gear until highest gear is reached. Shift down one or two gears if loss of engine power is noticed.

Always place gearshift in first gear when descending a steep grade under load to make use of the additional braking force provided by the engine.

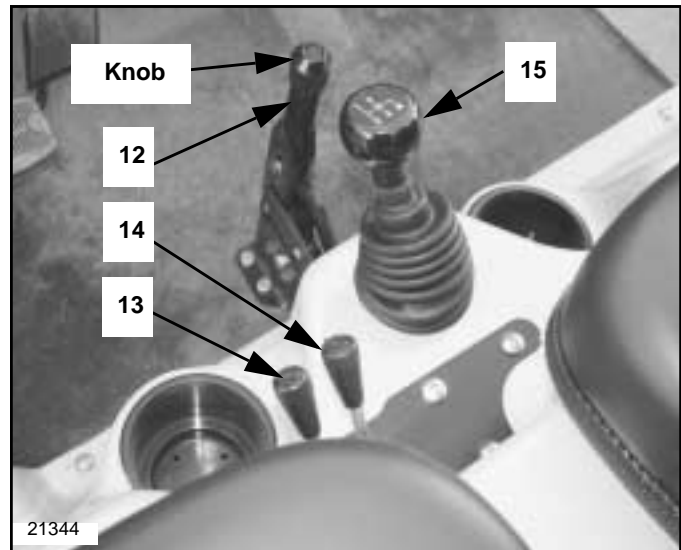

Figure 4-3

### Fuel Indicator

Refer to Figure 4-4

**#16 Fuel Gauge:** The fuel gauge, located on the gas tank, displays approximately how much fuel you have in the fuel tank. Always park the vehicle on level ground to get an accurate reading. The fuel tank is empty when the fuel gauge needle points to E and full when the needle points to F.

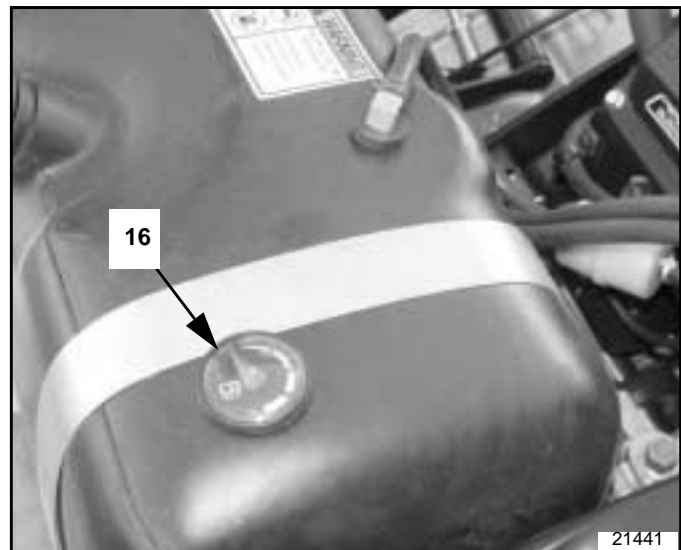

Figure 4-4

## Section 4: Operating Instructions

### Steering

Refer to Figure 4-5

**Steering:** The vehicle steers by pivoting about the center swivel yoke with the aid of a hydraulic cylinder.

**IMPORTANT:** Become familiar with the steering capabilities of the Gondo before putting the vehicle into service. Be certain to practice steering going forward and backing up as it has a different feel than normal front wheel steered vehicles.

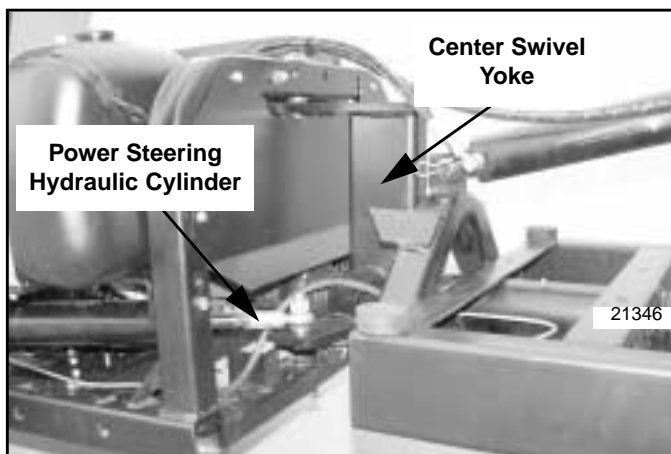

Figure 4-5

### Driving Conditions

Terrains vary creating different driving situations. The following are circumstances you might encounter and suggestions on how to operate the Gondo safely. Always approach each new situation with extreme caution until you have become experienced in handling your vehicle.

We recommend for your safety and the safety of others that you allow only operators experienced in driving a standard transmission, understand all potential dangers of operating this vehicle, has studied this manual, viewed the video safety tape supplied with this vehicle and has received actual hands-on instructions from an experienced operator.

#### Sandy Terrain

Tires with high air pressure perform better in loose sand. Also, stay in low gear to avoid spinning the wheels. Always maintain vehicle control, don't make sharp turns and avoid hard braking when possible.

#### Muddy Terrain

Better traction is achieved by accelerating the vehicle slowly to avoid spinning the wheels. Making sharp turns and hard braking can cause the vehicle to skid out of control. Let up on the accelerator pedal and stop when skidding out of control.

Clean off mud residue stuck to rotating drive shafts and to the tires as quickly as possible. Mud clinging to rotating parts causes an imbalance that can damage vehicle components. Also clean the brake drums of mud to reduce premature brake wear.

#### Watery Terrain

Always determine the depth of water before driving through it. Do not drive through water that is higher than the bottom of the floor board. Always enter the water slowly and continue traveling slowly through the water to minimize splashing. The vehicle could stall if the electrical system gets wet. Never allow water to get up around the engine. A wet engine is likely to stall or become damaged.

Test the brakes for stopping capabilities once through the water. Allow the brakes to dry before proceeding if braking capabilities are reduced. Brakes can be dried faster by driving the vehicle slowly on a level surface while applying light pressure to the brake pedal.

#### Snowy and icy Terrain

Like muddy terrain, accelerate the vehicle slowly to avoid spinning the wheels. Avoid making sharp turns and hard braking. Let up on the accelerator pedal and stop when skidding out of control. Always maintain a steady slow speed allowing time to slow down and stop. Remember slick surfaces require more time to slow down, make turns and stops.

#### Uneven Terrain

The Gondo's center articulating steering enables the four driving wheels to maintain contact in various uneven terrain situations. Because of this, the vehicle is capable of maneuvering over rough surfaces, up and down steep inclines. Avoid operating on excessively steep hills and especially on hills that are steeper than 15 degrees.

#### Climbing Steep Hills

Always approach a steep hill straight on in 1st (low gear) to reduce engine strain and minimize stalling. Continue straight up the hill in low gear moving right or left only to go around obstacles. Do not attempt to turn the vehicle around during a steep climb. If the vehicle stalls or should you decide to stop the climb, place vehicle in reverse gear and back down the hill slowly and as straight as possible to a safe location. If needed, apply the brakes very lightly to assist slowing down vehicle's descent. Hard braking can cause total loss of control and a rollover situation. Don't depress the clutch while backing down except when bringing the vehicle to a complete stop.

Maximum traction and control is achieved while traveling up a steep incline in 1st gear at the lowest possible speed. Also traveling slowly allows more time to correct a dangerous situation.

## Section 4: Operating Instructions

### Descending Steep Hills



#### WARNING

*Do not descend a steep hill with rear cargo box removed. Dangerous forward weight distribution is created.*

Descend most hills straight down in 1st gear. When necessary, use steady pressure on the brakes without locking them up. Hard braking can cause total loss of control and a rollover situation.

Always consider ground conditions and load distributions as outlined below before descending a steep hill:

- Is the ground surface wet or dry? Wet surfaces can result in loss of control and should not be attempted.
- Is the ground surface firm or loose? Loose surfaces can result in loss of control and should not be attempted.
- Is the terrain fairly even or is it eroded and uneven with holes and boulders? Surfaces that are not fairly even can result in loss of control and should not be attempted.
- Can the descent be made fairly straight or will you be required to turn to a degree that is approaching cross-hill travel making the vehicle subject to imbalance and turning over.
- Consider the vehicle's center of gravity. Is it front heavy, loaded high with cargo and is there a passenger along adding weight over the front axle? The rear axle should have sufficient weight over it to counter balance weight distributed over the front axle. A vehicle with poor center of gravity is subject to flipping forward end over end.
- Is the vehicle approaching maximum load rating capacity. Is the vehicle total loaded weight approaching maximum rated gross weight? Too much weight can reduce operator's ability to brake and control the vehicle.
- Is the vehicle towing a trailer and if so is the trailer carrying a load approaching gross weight of the Gondo? Again, too much trailer weight can reduce the operator's ability to brake and control the vehicle.

### Traverse Traveling on Steep Hills

Cross a steep slope only if no other alternative exists. When crossing, consider ground conditions and load distributions outlined in "Descending Steep Hills" on page 18. Make certain that the weight on the uphill side of the vehicle is equal to or heavier than the weight on the downhill side of the vehicle. Cross in 1st gear and if your vehicle starts to tip over, turn the vehicle down hill quickly to regain stability and control.

### Pulling Loads

The Gondo is capable of pulling a load weighing many times more than its own weight. Because of this it is important that you know the vehicle's capability and how to operate it in a way that will not damage the vehicle or injure yourself or others. Always consider the following:

- Does the load exceed the recommend towing capacity? Too much weight will push the vehicle around and hinder its stopping capabilities.
- Is the load front heavy placing too much weight on the hitch? Excessive hitch weight will make the front wheels light on the ground causing you to loose steering and traction capabilities.
- What type of terrain is the load being pulled over? Is the ground soft, wet, dry or inclined. Any of these can hinder vehicle control. See "Descending Steep Hills" on page 18 when considering type of terrain.

When towing always start in 1st gear and shift to a higher gear only if the vehicle has sufficient power. Do not travel in a gear that can not control the load. Heavy loads should be towed in 1st or 2nd gear depending on their ability to hold the load back from pushing the vehicle when letting up on the accelerator pedal. Remember, the heavier the load the longer it takes for the brakes to stop the vehicle.

### Towing the Gondo

The Gondo should be loaded on a trailer for towing. However, it can be towed behind a tractor or another vehicle for a short distance to retrieve it from an area where a trailer won't go.

**IMPORTANT:** Owner assumes all responsibility and liability resulting from towing the Gondo.

**IMPORTANT:** Do not tow the Gondo at speeds over 5 mph. Higher speeds may result in loss of control and damage to the Gondo, vehicle towing the Gondo and personnel.

### Towing Without a Trailer

The following precautions should be followed when towing the Gondo behind a tractor or another vehicle:

- Approved tow chain or rope must be securely attached to the Gondo at a location that will not damage the vehicle or come loose from the vehicle.
- The gear selector must be placed in neutral position.
- The park brake must be off.
- Someone must be steering the vehicle while it is being towed for it to track properly.
- When possible, the engine should be running to operate the power steering. If the engine will not run, the steering will be very heavy and will eventually quit as oil is bled from its steering sector.
- **Do not tow the Gondo at speeds over 5 mph.** Higher speeds may result in loss of control and damage to the Gondo, vehicle towing the Gondo and personnel.
- Do not tow another trailer or vehicle behind a Gondo that is being towed.
- Do not tow the Gondo on roadways or across open areas accessible with a trailer. Instead, load the vehicle onto a trailer for towing.

## Section 4: Operating Instructions

---

### Towing Loaded on a Trailer

The Gondo may be driven or winched onto a trailer. The following precautions should be followed when loading and towing the Gondo on a trailer:

- Always make certain loading ramps are capable of supporting the Gondo's weight, properly spaced for the Gondo wheels and secured to the trailer before loading the Gondo.
- Two people should be present when loading the vehicle. One stands clear of the Gondo as he guides the vehicle up the ramps and onto the trailer. The other sits in the Gondo and steers the vehicle as it is being loaded.
- Drive or winch vehicle onto the trailer slowly to prevent accidents.
- Once loaded, turn the switch key off, set park brake and place transmission in 1st gear.
- Properly secure the vehicle at its four corners to the four corners of the trailer with tie down chains or other approved tie downs. Tie downs must be designed to withstand forces induced into them during acceleration, making turns and applying brakes.
- Always tow at a speed where the driver is in control of his vehicle at all times.
- Always allow enough traveling distance to slow down and stop. The Gondo's added weight to the trailer will require additional time and distance to slow down.
- Slow down when turning to prevent loss of control and rollovers.
- Do not allow anyone to ride in the Gondo while towing it on a trailer.
- Obey all state and local laws for towing.

### Traveling Tips From the Trail Masters

At Land Pride we want you to get maximum working and recreational enjoyment out of your utility vehicle whether you are using one of our All-Terrain Runabouts or one of our terrain hugging Gondo utility trucks. If your work project or recreational adventure is going to take you on an extended ride deep into the wilderness or way out on the prairie, you'll need to seriously consider some of the following tips from experienced pros about safety, gear, clothing, supplies and driving techniques.

### Preparation and Planning

Do a complete equipment check as follows:

1. Make sure you have plenty of fuel and oil to make the trip and then some.
2. Make sure your tires have proper inflation, your lug bolts are tight and that you have a spare and the tools to change, repair and inflate a tire. Consider adding a puncture sealant to your tires as a preventative measure.

3. Check for any loose or missing parts and definitely make those needed repairs before going anywhere. It is especially important that you check steering, braking, throttle, electrical and engine components thoroughly.

### Plan Your Route

1. Plan your route, destination and rendezvous points before starting out.
2. Don't go it alone if at all possible. Taking someone else along reduces the potential for loss of life or major injury to inclement weather, animal attacks, or accidents. Besides, it's more fun when you have someone to share the adventure with.
3. Obtain trail or area maps of your travel routes to and from your destination. Communicate your travel plans to responsible friends and or proper authorities. Plan rendezvous points at conspicuous landmarks along your route just in case you run into unexpected trouble on the trail.
4. Make sure you take a weather radio and two-way communication devices such as cell phones or long range-two way radios. It is also good to have ground flares, a flare gun, a smoke canister, emergency strobe light, a reflecting mirror, matches for a signal fire and a compass.

### Plan Your Gear

1. Check the short and long range weather forecast and take protective gear and clothing to cover all contingencies. It doesn't have to snow for you to fall victim to hypothermia or exposure. Take or wear appropriate eye and head protection, gloves, boots, a long sleeve shirt, long pants, a jacket, rain gear, dry socks and a full change of dry clothing.
2. Plan your gear and gear up for the best and worst of environmental conditions.
3. Pack a first aid kit, sunblocker, lip balm, water, insect repellent, personal medications, tarp or tent, flash light, survival knife, binoculars, camera, tool kit, rope, duct tape, tow strap, winch or come-along, eating utensils, cooking utensils and high energy trail food.
4. Tie and lash down your gear and supplies securely. Keep the bulk of the weight centered and mounted as low as possible on the vehicle in order to maintain a low center of gravity for safe and stable off-road travel.

### Going Out on the Trail

1. Take it all in when hitting the trail but do it safely!
2. Make sure you brief your passenger on proper safety procedures like keeping hands, arms, feet and other bodily appendages inside the vehicle. Passengers should only be transported in factory supplied seating.
3. Operator and passenger are responsible for deciding if their situation warrants using Seat Belts.

## Section 4: Operating Instructions

---

4. Avoid operating on excessively steep hills and especially on hills that are steeper than 15 degrees. Avoid crossing slopes if possible and don't make sharp uphill steering corrections or a rollover could result. If your vehicle starts to tip over on a slope turn the front wheels quickly down hill to regain stability and control. The best way to climb most hills is to drive straight up while maintaining a steady ground speed and constant engine rpm. The best way to descend most hills is straight down while using steady pressure on the brakes without locking them up. Locking up the brakes in a steep downhill situation can result in loss of traction, steering and control. When you must cross a slope on soft terrain, keep the front wheels turned slightly uphill and maintain a constant speed and a straight line of travel.
5. Driving too fast, being inattentive and turning too sharply on slippery surfaces can result in rollovers and accidents almost quicker than any other ground condition we know of. Snow cover, wet trails, loose gravel and frozen ground can all contribute to this dangerous condition. In these conditions maintain sharp focus on the trail ahead. Don't make sharp turns and avoid the need for hard braking if at all possible. Slow down and stop if you do start to slide.
6. Avoid paved surfaces. Land Pride vehicles are designed exclusively for off-road use only. We understand that occasionally operators have to cross public roads or right of ways to gain access to work or recreation sites, but don't get in the way of faster traffic and cross quickly and safely.
7. The Gondo is capable of crossing **intermittent** streams where the depth of the water briefly comes into contact with the bottom of the floorboards, but you must keep these considerations in mind; You must know how deep the water is and the strength of the current. Cross where you have a gradual incline for entry and exit and the bottom is fairly clean and free of obstacles. Maintain a slow steady speed disturbing the stream bed as little as possible. If you submerge the engine, you will lose forward momentum and power. If you submerge the engine or the whole vehicle, do not attempt to start the vehicle but take it to your nearest dealer immediately. After intermittent stream or shallow water crossings, dry out the brake linings by slightly accelerating the engine rpm while riding the brakes momentarily until full drive power and braking are restored.
8. Backing up in an off-road situation might seem a simple thing to do to a novice, but having to back down a hill is a very dangerous situation. If you are on level ground always look behind you and back up slowly. If you find yourself having to back down a hill, apply the brakes very lightly. Hard braking can cause total loss of control and a rollover situation. Try to back straight down the hill without turning. Turning in this situation can also cause a rollover.
9. Whenever possible, park your vehicle on a level surface with the transmission in gear, set the park brake and remove the key. If you do have to park on a hillside make sure to chock the rear wheels on the downhill side to prevent a roll away. It's a good idea to keep your spare key stashed separately.
10. Never operate a vehicle under the influence of drugs or alcohol. When you're driving off-road vehicles you need to keep your senses keen and capable of quick reaction, sharp perception and good balance.
11. Working or recreation in the deep wilderness or on the prairies can be personally rewarding and very enjoyable to those who truly love and understand nature and the outdoors. Good judgement, maturity, proper preparation and planning can turn these adventures into great experiences you'll talk about for a lifetime. Share these adventures with young people whenever you can and show them how to do it properly. Don't let anyone under 16 operate this vehicle. They just aren't mature and experienced enough to take on the serious responsibility of operating a vehicle in the off-road environment without the benefit of an experienced adult with them. Remember, the only one who can prevent and avoid an accident is the operator in control and that's you!

## Section 5: Options and Accessories

### Gondo Options

There are several options Land Pride offers when selecting your Gondo.

#### Rear Cargo Box

There are two styles of rear cargo boxes available for you Land Pride Gondo.

- Gondo style dump bed without tail gate
- Cargo style dump bed with tail gate

#### Tires

*Refer to figure 5-1*

There are two types of tires available for your Land Pride Gondo. See figure 5-1. Both are 4-ply rated. The Bar Tire with its chevron bars is a good tire to choose when traction is your first priority. This tire is a tough tire for going over rough terrain. The Turf Tire is a good selection when one wants to preserve the terrain being traveled over. Golf courses, parks and other maintained areas make the Turf Tire an excellent choice.

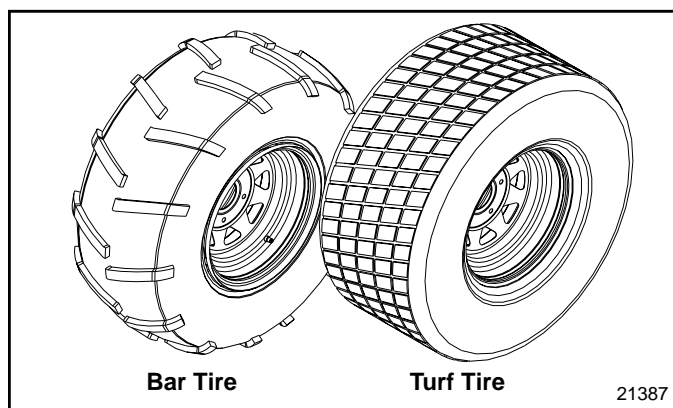

figure 5-1

### Gondo Accessories

A variety of accessory equipment has been designed to complement your needs and make your Land Pride Gondo a very functional and useful vehicle. See your nearest Land Pride Dealer for all accessories available. Accessories available are:

- Grab light
- Rear receiver type hitch
- Hydraulic bed lift
- Pup trailer with lug tires (without cargo box)
- Certified ROPS with seat belts (if not originally equipped with ROPS)
- Cab enclosure with soft doors and windshield wiper
- Front snow blade
- Log skidder
- Cold weather engine kit (Prevents carburetor icing)



**Section 6: Maintenance**

**General Maintenance**

 **WARNING**

*Read and observe all safety warnings in this manual and in the engine service manual.*

 **WARNING**

*Except when checking or changing components, always keep protective shields on for safety as well as for cleanliness.*

 **WARNING**

*Keep engine clean of oil, grease, trash and debris which can cause engine overheating, fires and belt wear. Clean only after the engine has completely cooled. Wear gloves to protect hands from cuts, puncture wounds and burns.*

 **WARNING**

*DO NOT have engine running when servicing or making adjustments to the vehicle. Shut engine off, place transmission in gear, set park brake and remove ignition switch key for maximum safety.*

 **DANGER**

*Repairs or maintenance specifically requiring engine power should be performed by trained personnel only. Transmission gear should be set in neutral with tires properly chocked or with drive tires properly supported off the floor. Enclosed areas should be properly ventilated to prevent carbon monoxide poisoning.*

 **DANGER**

*Exercise extreme caution when working with and around the driveshaft and power steering belt. Make certain the engine cannot be accidentally started. Shut engine off and remove ignition switch key for maximum safety. Repairs or maintenance requiring engine power should be performed by trained personnel only.*

Regular maintenance is the best prevention for costly downtime or expensive, premature repair. The following pages contain suggested maintenance information and schedules which the operator should follow on a routine basis.

Remain alert for unusual noises, they could be signaling a problem. Visually inspect the vehicle for any abnormal wear or damage. A good time to detect potential problems is while performing scheduled maintenance service. Correcting the problem as quickly as possible is the best insurance.

Some repairs require the assistance of a trained service mechanic and should not be attempted by unskilled personnel. Consult your Land Pride dealer when assistance is needed.

**Prepare Vehicle for Maintenance**

Before servicing the vehicle the following procedure must be followed to secure the vehicle:

1. Park vehicle on a level surface. **Don't work under or around a vehicle parked on a steep incline.**
2. Place gear selector in 1st or reverse.
3. Set park brake.
4. Turn ignition switch off and remove switch key.
5. Block pinch point area at the center swivel yoke to prevent movement. (See **DANGER** below.)
6. Chock front and back side of the wheels not being raised off the ground whenever jacking a vehicle or when ground surface slopes.
7. Always use jack stands to support the vehicle when working under the vehicle.

 **DANGER**

*Pivoting about the center swivel yoke must be blocked to prevent movement before working on or around the vehicle. This articulation area is an extremely dangerous pinch point area caused by just a slight turning of the steering wheel even when the vehicle is not running.*

**Torque Values**

**Wheel Lug Nuts**

 **WARNING**

*Particular attention must be given to tightening the wheel lug nuts. Failure to correctly torque these items may result in the loss of a wheel, which can cause personal injury and damage to the vehicle.*

Torque Values		
	FT -lbs.	Nm
<b>Wheel lug nuts</b>	65 - 75	88.14 - 101.7

Always check wheel lug nut torque values two hours after initial operation and two hours after each tire repair and/or replacement. Routinely check lug nut torque valves every 100 hours of operation. See "Maintenance Schedule" on page 30.



## Section 6: Maintenance

### Engine Torques

For engine torque values, see engine owner's manual.

### All Other Torques

For all other torques refer to "Torque Values Chart" page 45.

### Tire Maintenance

Use only tires recommended by Land Pride.

It is important for your safety and the safety of others that the tires have correct air pressure. Check air pressure in all four tires before each use. Visually inspect tires for loss of air throughout each day of operation. See Tire Inflation Chart below for correct tire pressure.

Tire Inflation Chart	
Tire	Inflation PSI
Front Tires	15*
Rear Tires	20*

\*Maximum tire pressure is noted on tire side wall.

### Jacking the Vehicle



#### **DANGER**

*For your safety and safety of others, a jacked vehicle must be supported properly with jack stands before working under and around it. Also the wheels on the ground must be chocked on both sides to prevent the vehicle from rolling forward or backward.*

**IMPORTANT:** Use a hydraulic jack, floor jack, or scissor type jack to lift vehicle. Do not use a handyman jack or bumper jack and don't jack against the bumper, body, differential case, axles or hydraulic lines.

1. Prepare vehicle for maintenance as outlined in steps 1-6 on page 22.
2. Loosen the lug nuts on a wheel being removed approximately 1/2 turn counterclockwise while it is still on the ground.
3. See important note above. Place proper jack under vehicle as follows:
  - a. **Front tires:** Refer to Figure 6-1. Place jack under the main frame just behind the axle.
  - b. **Rear tires:** Refer to Figure 6-2. Place jack under the main frame just in front of the axle.
4. Jack vehicle only high enough to do the work intended.
5. Support vehicle securely with jack stands before working under and around the vehicle.

6. Work may now be performed on the vehicle. Be sure to properly torque all bolts that were loosened. Wheel bolts should be torqued after the vehicle is lowered to the ground.
7. Lower the vehicle by first jacking the vehicle up high enough to remove the jack stands. Then carefully lower the jack until the vehicle is on the ground.
8. Remove wheel chocks.

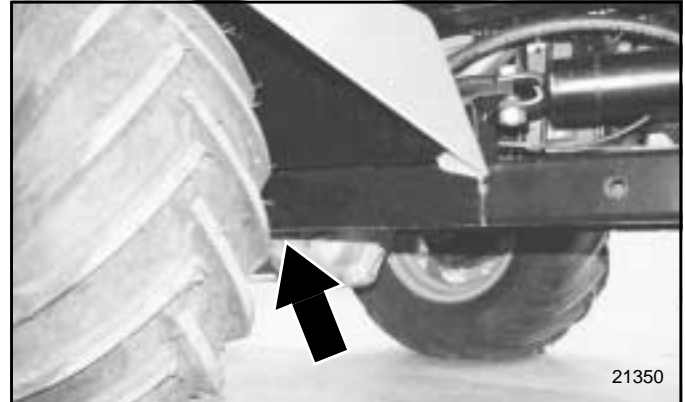

**Figure 6-1**

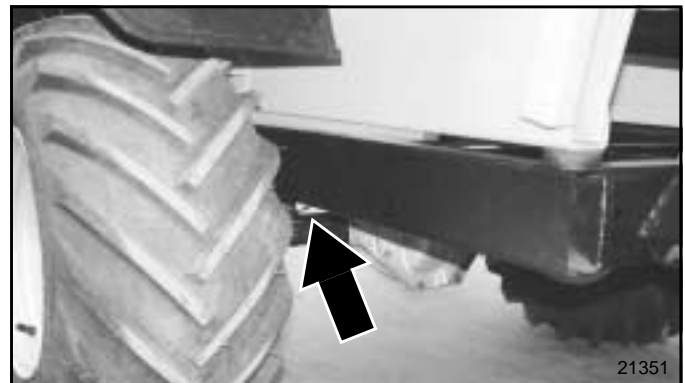

**Figure 6-2**

### Shock Absorbers

Shock absorbers are located under the seat to make the ride more comfortable. Traveling fast may cause the shock absorbers to bottom-out making the ride rough.

### Electrical System

A 12 volt, 25 amp, negative ground electrical system is provided. The electrical system is protected by a fuse located behind the dash near the key switch and a moisture proof self-resetting circuit breaker in the wiring harness near the starter at the engine. The amp ratings are as follows:

- Fuse behind the dash - 30 Amps
- Self-resetting circuit breaker - 30 Amps

## Section 6: Maintenance

---

Common circuit failures can be from “shorts”, corroded or dirty terminals, loose connections, defective wire insulation or broken wires. Switches, solenoids and ignition components can also not function, causing a short or open circuit.

Before attempting any fault diagnosis of the electrical system, use a test light or voltmeter to check the battery voltage. If the battery voltage is satisfactory, check the cleanliness and tightness of the terminals and ground connections. A general understanding of electrical servicing and use of basic test equipment is necessary for troubleshooting and repair.

Major overhaul or repair of the starting motor or alternator should be performed by trained technicians only.

### Battery

The battery is located in the engine compartment. It may be either a maintenance-free sealed battery or a maintenance-free battery with removable vent caps. Inspect your battery and know which battery you have. Water can not be added to sealed batteries as the vent caps are not removable.



#### CAUTION

*Do not overfill battery with water. Electrolytes may overflow and damage paint, wiring or structure. Use soap and water to clean the battery. Be careful not to get soap and water into the battery. Use baking soda mixed in water to clean corrosion off the terminals.*



#### WARNING

*Acid can cause serious injury to skin and eyes. Avoid skin contact with battery acid and always wear eye protection when checking the battery. Flush area with clean water and call a physician immediately. Acid will also damage clothing.*



#### WARNING

*Incorrect battery cable connections can damage vehicle's electrical system and cause battery cables to spark. Sparks around a battery can result in a battery gas explosion and personal injury.*

- Always **disconnect** negative (black) battery cable before disconnecting positive (red) cable.
- Always **reconnect** positive (red) battery cable to the positive (+) post before reconnecting negative (black) cable to the negative (-) post.



#### WARNING

*Sparks can cause a battery gas explosion which will result in personal injury. Keep battery terminals from touching any metal parts when removing or installing the battery. Do not allow metal tools to short between battery terminals and metal vehicle parts.*



#### WARNING

*Do not allow an open flame near the battery when charging. Hydrogen gas forms inside the battery. This gas is both toxic and flammable and may cause an explosion if exposed to a flame.*

Check water level once a year. The water level in each cell should be up to the level indicator. If not, add water. Distilled water should be used to fill each cell in the battery. However, tap water may be used if tap water is not hard or does not have high mineral or alkali content. Do not overfill. Have the charging system checked by your local Land Pride dealer if the battery requires water every few months.

Land Pride recommends a maintenance-free battery size BCI group U1/U1R. The battery should also have a minimum of 300 cold cranking AMP's and 375 cranking AMP's at 32°F. Always follow the manufacturer's maintenance, safety, storing and charging specifications.

### Jump Starting the Battery

*Refer to Figure 6-3*

The battery will discharge if the lights or any other electrical equipment is left on after the engine has stopped running. Also, the battery will discharge if the lights or power plug outlet is used over a prolonged period while the engine is idling.

The engine can be jump-started with a booster battery. Follow procedures listed below when jump-starting.

#### Prepare Vehicle to Jump-Start

1. Use only a 12-volt battery to jump-start the ATR. Higher voltages can damage the starter motor and other electrical components. Do not use a 24 volt battery or two 12-volt batteries connected in series.
2. Do not disconnect the vehicle's battery that needs a jump-start. Disconnecting the battery can damage the vehicle's electrical system.
3. Park the live vehicle close to the vehicle needing a boost without touching the two vehicles together. Set parking brake on both vehicles.
4. Turn off all ignition switches, electric switches, light switches and set parking brakes on both vehicles.

## Section 6: Maintenance

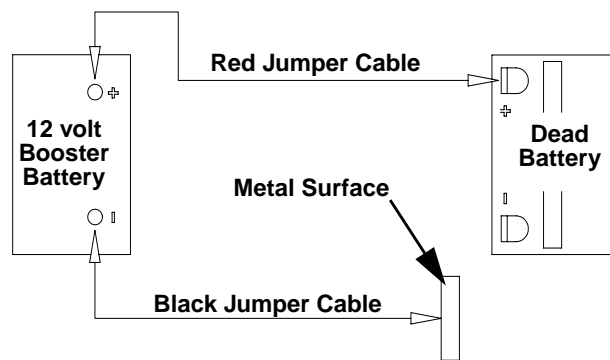

Figure 6-3

### Connecting Jumper Cables

Refer to Figure 6-3

1. Inspect battery terminals for corrosion. Remove excess corrosion before connecting jumper cables.
2. Connect one end of the red jumper cable to the positive (+) terminal on the dead battery.
3. Connect the other end of the red jumper cable to the positive (+) terminal on the booster battery.
4. Connect one end of the black jumper cable to the negative (-) terminal on the booster battery.



### WARNING

Make connection in step 5 below to a metal surface away from the battery. Never connect to the negative (-) post of the dead battery or to a metal surface near the battery. Sparking near the battery can result in a battery gas explosion and personal injury.

5. Connect the other end of the black jumper cable to a metal surface on the vehicle that has the dead battery. Inspect jumper cables to make certain they are not in the way of moving or rotating components. Reposition any cables that will be in the way.



### DANGER

Make certain everyone is clear of all moving and rotating components before starting either vehicle.

6. Start the live vehicle and run it at a moderate speed for a few minutes to charge the dead battery.
7. After waiting a few minutes, start the dead vehicle. It should start within several tries. If the vehicle does not start, then the problem might be something other than the battery.

### Disconnecting Jumper Cables

Refer to Figure 6-3

1. Let both vehicles run for several minutes to charge up the dead battery before removing the jumper cables.

2. Disconnect the black jumper cable from the metal surface on the vehicle that had the dead battery.
3. Disconnect the other end of the black jumper cable from the negative post on the booster battery.
4. Disconnect the red jumper cable from the positive (+) post on the booster battery.
5. Disconnect the other end of the red jumper cable from the positive (+) post on the dead battery.
6. Drive the vehicle that had the dead battery for a while to recharge the battery or recharge the battery with a battery charger. Follow all battery charger instructions when recharging a battery with a battery charger.

### Fuel System



### DANGER

- Observe usual fuel handling precautions.
- Do not smoke while handling fuel.
- Keep fuel away from an open flame or spark.
- Refuel outdoors preferably, or in a well ventilated area.
- Allow engine to cool before servicing the fuel system.
- Do not fill tank with engine running or while engine is hot. Allow the engine to cool before filling. Spilling fuel over the engine, muffler, or a hot object may result in a fire or explosion.
- Clean up any gasoline spills immediately.
- Store the vehicle away from open flame or spark if there is fuel in the tank.
- Use extra caution when handling gasoline and other fuels. They are flammable and vapors are explosive. A fire or explosion from gasoline can burn you and others and can damage property.
- Never attempt to start engine when there is a strong odor of gasoline fumes present. Locate and correct cause.
- Store gasoline in an approved container and keep it out of children's reach.
- Never buy more than a 30 day supply of gasoline.
- Do not fill gasoline containers inside a vehicle, on a truck, or on a trailer. Interior carpets and plastic truck bed liners insulate the container and slow loss of static charge.
- When practical, remove equipment from the truck or trailer and refuel the equipment with its wheels on the ground. If this is not possible, then refuel the equipment on the truck or trailer using a portable container and not a gasoline dispenser nozzle. If a gasoline dispenser nozzle must be used, keep the nozzle in contact with the rim of the fuel tank or container opening at all times until fueling is complete.
- Gasoline is a poison harmful or fatal if swallowed.
- Long-term exposure to vapors can cause serious injury and illness.
- Avoid prolonged breathing of vapors.
- Keep face away from nozzle and gas tank opening.
- Keep gas away from eyes and skin.

## Section 6: Maintenance

### Filling the Fuel Tank

Refer to Figure 6-4 on page 26

The fuel tank is located on the left side under the seat console. Total fuel capacity is 8 gallons.

When filling the fuel tank, place gear shift in 1st or reverse gear, set park brake, turn off engine and remove ignition key. Tilt seat console forward to access fuel tank. Clean dirt from around fuel cap, remove cap and begin filling. When finished, screw cap back on securely and wipe up any spilled gasoline. Use regular unleaded gasoline with an octane rating of 87 or higher.

**IMPORTANT:** Never use methanol, gasoline containing methanol and/or gasohol containing more than 10% ethanol. These fuels can damage the vehicle's fuel system. Do not mix oil with gasoline.

Using a fuel stabilizer/conditioner in the vehicle can provide benefits such as:

1. Keeps gasoline fresh during storage of 90 days or less. The fuel tank should be emptied for longer storage.
2. Cleans the engine during operation.
3. Eliminates gum-like varnish build-up in the fuel system.

**IMPORTANT:** Do not use fuel additives containing methanol or ethanol.

Add the correct amount of gas stabilizer/conditioner to the gas. Follow the gas stabilizer/conditioner manufacturer's directions for best results.

### Emptying the Fuel Tank



#### **DANGER**

*Never siphon a fuel tank by sucking on a hose with your mouth. Gasoline is a poison. Also fuel vapors and gas are harmful to your lungs and can permanently damage them. Always use a siphon pump.*

The fuel tank will need emptying when preparing for long term storage or replacing a damaged one.

1. Prepare vehicle for maintenance as outlined in steps 1-6 on page 22.
2. Follow all Fuel Safety Cautions, Warnings and Dangers.
3. Remove fuel cap and siphon fuel through the fuel fill opening with a siphon pump into an approved gas container. Make sure the container or containers are capable of holding all the gas. Do not dump fuel on the ground.

### Fuel Filter and Fuel Line Maintenance

Refer to Figure 6-4

The fuel filter (Land Pride Part No. 831-031C) is installed in the fuel line between the fuel tank and engine and should be replaced annually. At the same time check the fuel line hoses for any cracks or leaks. Inspect and replace fuel filter and fuel lines as follows:

1. Prepare vehicle for maintenance as outlined in steps 1-6 on page 22.
2. Safely secure the seat console in the raised position.
3. Following all Fuel Safety Cautions and Warnings, remove clamps securing the fuel filter and remove fuel filter for inspection.
4. Check fuel filter for sediment and water accumulation. Check fuel lines for cracks and leaks.
5. Replace damaged fuel lines with new ones.
6. Replace fuel filter when sediment or water is present.
7. Reattach fuel filter to fuel line with arrow on the filter pointing in the same direction fuel flows in the line. Fuel flows towards the engine.

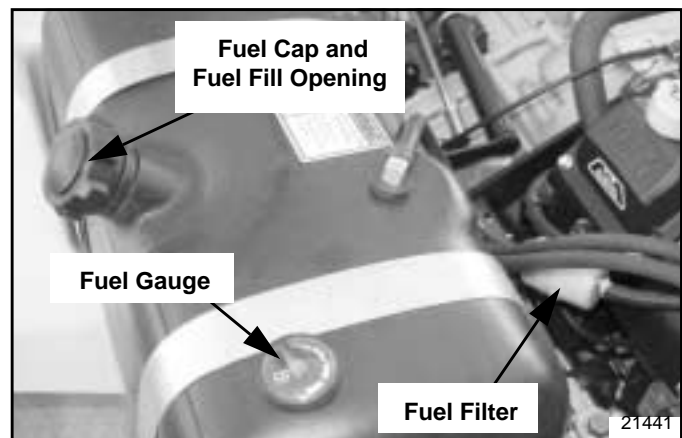

Figure 6-4

8. Install hose clamps around fuel filter.
9. Start vehicle and inspect for fuel leaks along fuel line and fuel filter.
10. Shut off vehicle and remove wheel chocks if used.

## Engine Maintenance

### General Information

Detailed instructions and recommendations for break-in and regular maintenance are specified in the engine operator's manual. Engine warranty is backed by the engine manufacturer. Please refer to engine manufacturer's manual for engine servicing, lubricating oil levels, oil quality and viscosity recommendations, bolt torques, etc. Special attention should be paid to applicable data that is not duplicated here.

## Section 6: Maintenance

### High Altitude Carburetor Kit

**IMPORTANT:** The air-fuel mixture in carburetors modified for high elevation is too lean when operating at elevations below 5,000 feet. Operating engines with modified carburetors below 5,000 feet can result in engine overheating and serious engine damage. Return carburetor to original factory specifications when operating at low elevations.

Gondo vehicles shipped from the factory are equipped with carburetors designed to operate efficiently between 0 and 4,999 feet. Carburetor change over kits for different altitudes may be purchased from your nearest Land Pride Dealer. The following kits are available:

Elevation	Carburetor Kit No.
0' - 7,999'	Engine Standard
8,000' & up	24755125-S

### Power Steering Belt

Refer to Figure 6-5 & Figure 6-6

Power steering belt and pump are positioned behind the engine and are protected by a shield. **Do not remove shield except to service the belt and always replace shield after servicing the belt.**

Replace power steering belt when it shows signs of severe cuts, tears, excessive weather checking and cracking or burns caused by slipping. Slight raveling of belt covering does not indicate failure. Trim ravelings with a sharp knife.

Inspect belt pulley grooves and flanges for wear. A new belt, or one in good condition, should never run against bottom of pulley groove. Replace pulley when this is the case, otherwise belt will lose power and slip excessively.

Never pry a belt to get it on a pulley as this will cut or damage the fibers of the belt covering.

Keep oil and grease away from belts and never use belt dressings. Any of these will destroy the belt composition in a very short time.

### CAUTION

*Make certain to keep fingers from getting caught between belt and pulley when rotating belt over pulley.*

Replace power steering belt as follows:

1. Prepare vehicle for maintenance as outlined in steps 1-6 on page 22.
2. Safely secure the seat console in the raised position.
3. Disconnect negative battery cable.
4. Safely secure cargo box and seat console in the up position to prevent injury.

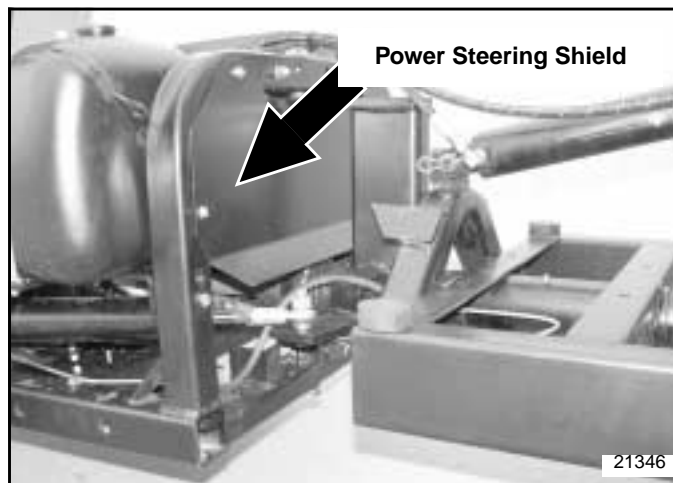

Figure 6-5

Refer to Figure 6-5

5. Remove bolts securing belt cover and remove cover.

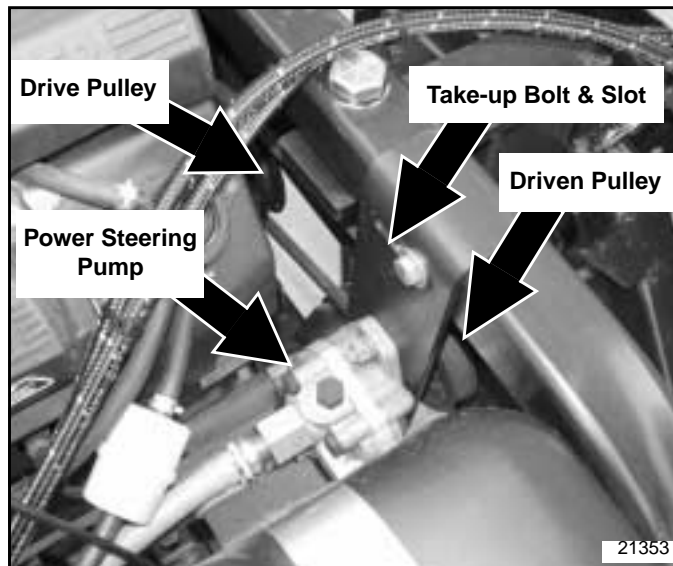

Figure 6-6

Refer to Figure 6-6

6. Loosen belt take-up bolt and hand squeeze belt together. This should allow room to remove the belt.
7. Remove belt by rolling it off over the drive pulley and then lifting it up off the driven pulley.
8. Reinstall new belt by placing it over the driven pulley and then rolling it over the drive pulley.
9. Re-tension power steering belt and tighten take-up bolt.
10. Reinstall belt cover and fasteners.
11. Reconnect battery negative cable.
12. Remove blocks securing cargo box up and lower cargo box.

## Section 6: Maintenance

### Engine Air Filter

Refer to Figure 6-7

A specially designed high density paper filter element surrounded by an oil filled foam precleaner filter element cleans the air supplied to the engine. Protect your engine by ordering only genuine Land Pride parts when replacing the air filter elements.

**NOTE:** Do not operate engine with a damaged air filter or without the air filter elements installed. Dirt will enter the engine and cause a dust ingested engine failure.

### Air Filter Maintenance Schedule

- Check air filter daily before starting engine for dirt and debris buildup. Also check daily for loose and damaged filter components. Tighten loose components and replace damaged components.
- Service precleaner foam element ever 25 hours of operation. Service more often when operating in extremely dusty or dirty conditions.
- Service paper element every 100 hours of operation. Service more often when operating in extremely dusty or dirty conditions.

### Precleaner Foam Element

Refer to Figure 6-7 and Figure 6-8

1. Prepare vehicle for maintenance as outlined in steps 1-6 on page 22.
2. Safely secure the seat console in the raised position.
3. Loosen air cleaner cover knob and remove cover.
4. Remove outside precleaner element from the paper element.
5. Wash precleaner element with warm water and detergent. Rinse thoroughly to remove all traces of detergent. **Do not wring precleaner.** Squeeze excess water out and allow time to air dry.
6. Saturate precleaner with new engine oil and gently squeeze all excess oil out.
7. Inspect precleaner element for holes and tears before reinstalling it. Replace element if damaged.
8. Reinstall precleaner element over the paper element being careful not to damage the elements.
9. Reinstall air cleaner cover and secure with cover retaining knob.

Order genuine Land Pride parts when replacing the precleaner element.

Description	Part No.
-------------	----------

**Precleaner Element (61 mm deep) . . . . 24-083-02-S**

### Paper Element

Refer to Figure 6-7, Figure 6-8 and Figure 6-9

1. Prepare vehicle for maintenance as outlined in steps 1-6 on page 22.
2. Safely secure the seat console in the raised position.

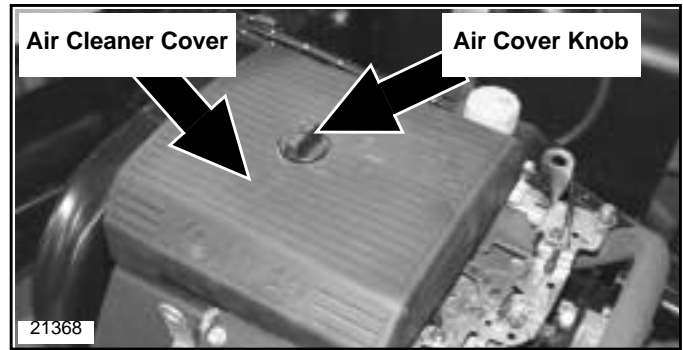

Figure 6-7

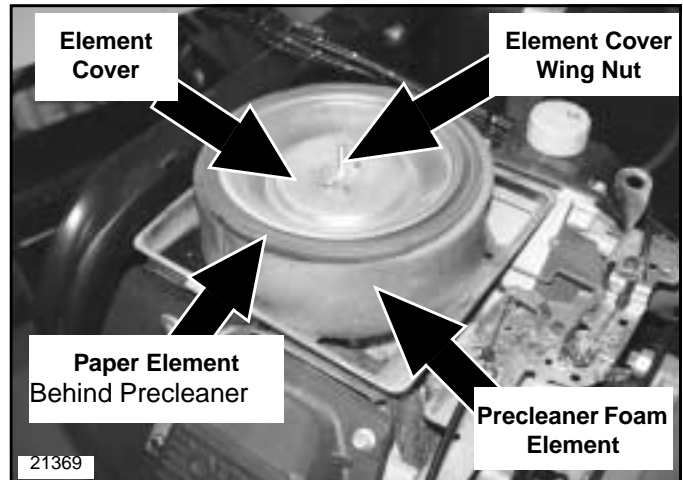

Figure 6-8

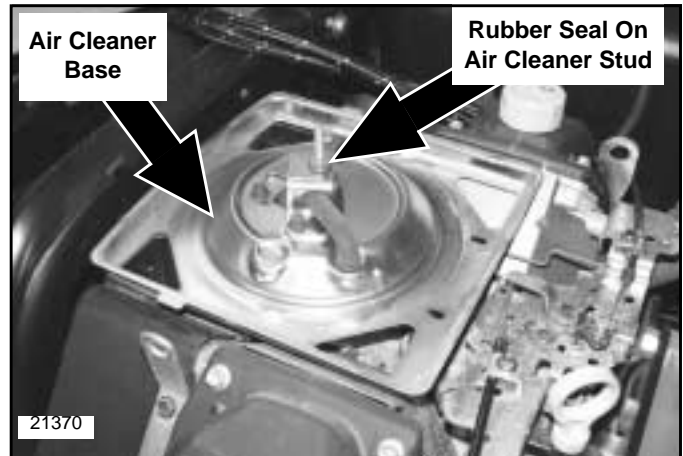

Figure 6-9

3. Loosen air cleaner cover knob and remove cover.
4. Remove element cover nut, element cover and paper element with precleaner element.
5. Remove precleaner element from paper element. Service precleaner as described in Precleaner Service Procedure.
6. **Do not wash paper element or blow pressurized air over and through it.** This will damage the element. Always handle the element, new or used,

## Section 6: Maintenance

carefully to prevent damaging it. Inspect and replace the element if it is dirty, bent or damaged with a genuine Land Pride element. **Do not use an element if its sealing surfaces are bent or damaged.**

7. Check air cleaner base. Make sure it is not bent or damaged and is secured.
8. Check element cover. Make sure it is not bent or damage and that it fits properly. Replace all damaged air cleaner components.
9. Inspect the air cleaner base for loose dirt or debris that may have fallen on it when the element was removed. Be careful that none of the dirt drops into the intake throat, remove base and wipe it clean.
10. Check the condition of the rubber seal on the air cleaner stud, replace it if its condition is questionable in any way. A new rubber seal is provided with the replacement paper element in a sealed packaged.
11. Reinstall paper element, precleaner, element cover, element cover nut, and air cleaner cover. Secure cover with cover retaining knob.

Order genuine Land Pride parts when replacing the paper element.

Description	Part No.
<b>Paper Element (65 mm deep)</b> . . . . .	<b>47-083-03-S</b>

### Spark Arrester



#### **DANGER**

*The spark arrester does not stop all fire emitting sparks from escaping the muffler. Use extreme caution when driving through dry grass, brush and other fire hazard materials. Never stop or park the vehicle over combustible materials.*



#### **WARNING**

*The muffler is very hot and will burn upon contact. Allow time to cool before servicing the spark arrester.*



#### **CAUTION**

*To maintain efficiency, the spark arrester must be serviced every 100 hours.*



#### **CAUTION**

*Be careful not to damage the spark arrester screen when cleaning.*

*Refer to Figure 6-10*

The spark arrester is mounted inside the muffler behind the muffler exhaust deflector. It is designed to suppress sparks from escaping the muffler while they are still glowing.

### Spark Arrester Maintenance Schedule

- Inspect every 100 hours for carbon build-up and screen damage.
- Clean whenever carbon build-up is visible or whenever lost of engine power is detected.
- Replace when damaged.

### Spark Arrester Maintenance Procedure

*Refer to Figure 6-10*

1. Remove spark arrester mounting screws, exhaust deflector and spark arrester from the muffler.
2. Remove carbon deposits from spark arrester screen with a wire bristle brush. Be careful not to damage the spark arrester screen.
3. Inspect the spark arrester for holes or breaks in the screen and replace if damaged.
4. Reattach spark arrester and exhaust deflector to muffler with mounting screws.

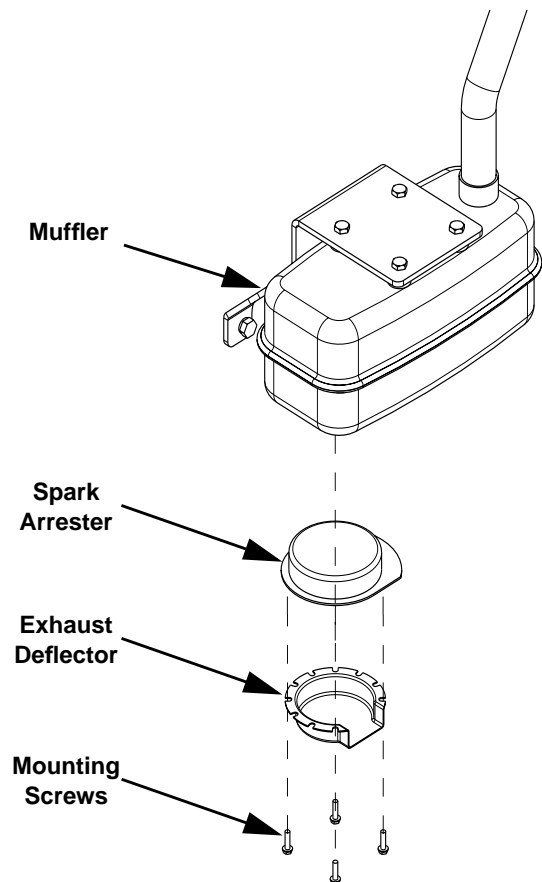

**Figure 6-10**

21349

### Replacement Parts

Description	Part No.
<b>Spark Arrester</b> . . . . .	<b>840-174C</b>

## Table of Contents

### Section 6: Maintenance

<b>Maintenance Schedule</b>							
Maintenance Operation	Daily	Every 25 Hrs	Every 100 Hrs.	Every 200 Hrs.	Every 6 Mos.	Every Season	Refer to Page
Check Engine Oil level	X						31
Check Hydraulic Fluid Level (1)	X						35
Check Tire Pressure	X						23
Check for Fluid Leaks	X						
Inspect All Nuts and Bolts for Tightness	X						22
Check and Clean Area Around Air Intake	X						28
Grease Zerk Fittings for rotating surfaces - 2 places	X						36
Service Air Cleaner Pre-cleaner Foam Element(2)		X					28
Check Wheel Lug Nuts (Torque 65 to 75 Ft. lbs.) (3)			X				22
Grease Zerk Fittings for bearings - 3 places			X				35 & 36
Service Air cleaner Paper Element (4)			X				28
Change Engine Oil (5) & (6)			X		X		32
Change Engine Oil Filter (5) & (6)			X		X		32
Check Differential Fluid Level (7)			X		X		33
Check Transmission Fluid Level (8)			X		X		34
Check Battery Charge and Water Level			X				23
Inspect Drum Brakes			X				
Inspect Parking Brake			X				
Check Master Cylinder Brake Fluid			X				34
Check & Regap Spark Plugs (1.02 mm / .04 in.)				X			
Check Fuel Line Hoses and Clamps						X	26
Replace In-line Fuel Filter						X	26
Clean Battery and Terminals						X	23
Check Power Steering Belt						X	27
Clean Spark Arrester (9)						X	29
Service Bendix starter drive (10)						X	
Disassemble and clean solenoid shift starter (10)						X	

(1) Reservoir should be 3/4 full when all hydraulic accessories are in retract position.

(2) Replace air cleaner pre-cleaner if damaged.

(3) Check tightness after first 2 hours of initial operation and 2 hours after removal for repair and/or replacement.

(4) Replace paper element if extremely dirty or damaged.

(5) Make first oil and filter change after the first month of operation or at 20 hours of operation (whichever comes first).

(6) Service every 100 hours or 6 months (whichever comes first).

(7) Change differential oil ever year or every 400 hours (whichever comes first).

(8) Transmission fluid does not require changing unless contaminated with water. Change immediately if contaminated with water.

(9) Clean spark arrester whenever loss of engine power is noticed or every season (whichever comes first).

(10) Have a Land Pride dealer perform this service every year or every 500 hours (whichever comes first)



Section 7: Lubrication and Fluids

Multi-purpose spray lube	Multi-purpose grease lube	Multi-purpose oil lube	50	Intervals at which lubrication is required
--------------------------	---------------------------	------------------------	----	--

### Engine Oil

Engine lubrication is essential and must be maintained to ensure long engine life. It is extremely important to use proper type and weight of oil in the crankcase. It is also extremely important to check oil daily and change it regularly as outlined in the maintenance schedule.

See Engine Operator's Manual for a detailed description of engine oil maintenance. Also the Engine Operator's Manual provides additional information necessary to keep the engine in top operating condition. Follow all maintenance procedures provided in the Engine Operator's Manual.

**NOTE:** Running engine low on oil can cause engine damage and void engine warranty.

**NOTE:** Overfilling of oil level can cause loss of power, engine damage and void engine warranty.

### Engine Oil Maintenance Schedule

- Check oil level daily before starting engine.
- Make first oil change after the first month of operation or at 20 hours of operation (whichever comes first).
- Make all subsequent oil changes every 6 months or every 100 hours of operation (whichever comes first)

### Engine Oil Type and Capacity

See also "Section 10: Specifications and Capacities" on page 40

- Type of Lubrication based on temperature range expected before next oil change:  
0°F and up - SAE 10W-30  
32°F and down - Synthetic SAE 5W-20 or 5W-30
- Service Class: SG, SH, SJ or higher
- Engine Oil Capacity:  
2 US qts. / 1.9 liters with filter replacement  
or Fill to upper limit mark on dipstick.

### Engine Oil Level Check

Refer to figure 7-1 and figure 7-2

	Daily
--	-------

Check engine oil with the dipstick daily as follows:

1. Prepare vehicle for maintenance as outlined in steps 1-6 on page 22.

2. Allow enough time for engine oil to settle before checking oil level with dipstick.
3. Clean around the dipstick before removing it to keep dirt and debris out of the engine.
4. Remove dipstick and wipe clean.
5. Fully insert dipstick and remove. Oil level on the dipstick should be up to the "F" mark but not over.
6. If oil level on dipstick is low, remove filler cap located on the top left valve cover and fill with recommended oil. Repeat steps 2, 3, 4 and 5 until oil level on dipstick indicates full. **Do not overfill or plug fouling and power loss will occur.**
7. Replace filler cap and dipstick

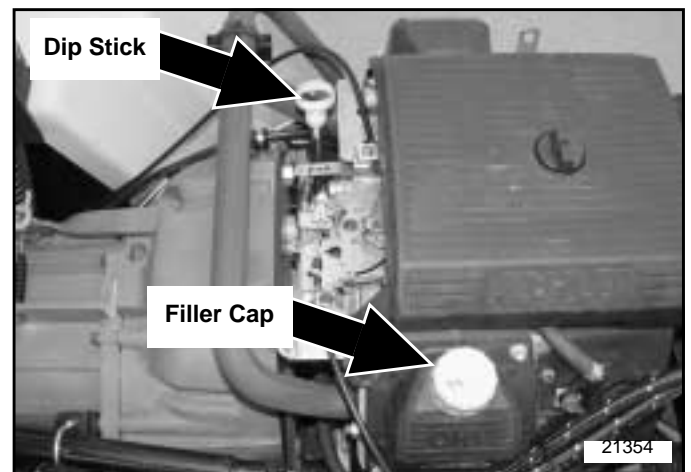

figure 7-1

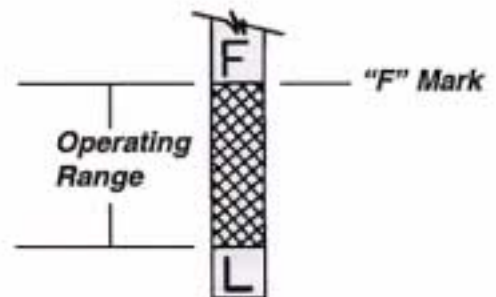

figure 7-2

21372

## Section 7: Lubrication and Fluids

### Engine Oil and Filter Change

Refer to Figures 7-1, 7-2, 7-3, 7-4 & 7-5

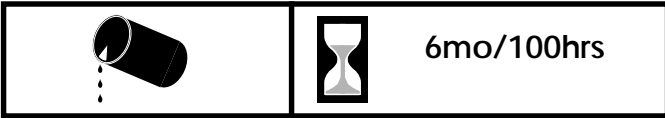

Drain used engine oil while the engine and oil are still warm. The oil will drain more freely and carry away more impurities. Change oil as follows:

1. Prepare vehicle for maintenance as outlined in steps 1-6 on page 22.
2. Clean the area around the oil filter to keep dirt and debris out of the engine.
3. Place a suitable container below the engine to catch used oil as it drains. Remove filler cap. Turn oil drain valve 1/4 turn counterclockwise and pull out to drain oil.
4. Remove oil filter located on left side of engine with a filter wrench. Let remaining oil drain out.
5. Push oil drain valve in and turn clockwise until hand tight. Replace oil drain cap.
6. Clean oil filter base where the oil filter seats against it.
7. Place a new replacement filter in a shallow pan with the open end up. Pour new engine oil in through the threaded center hole until oil reaches the bottom of the threads. Allow one or two minutes for the oil to be absorbed by the filter material.
8. Coat new filter O-ring with clean engine oil and install filter to engine filter base.
9. Hand tighten oil filter until O-ring seats. Finish tightening by turning in the filter an additional 2/3 to 1 turn.
10. Dispose of used motor oil and filter in a manner that is compatible with the environment. Do not throw used oil in the trash, pour it on the ground, or down a drain.
11. Fill engine with recommended oil and quantity. **Do not overfill.** See "Engine Oil Type and Capacity" and "Engine Oil Level Check" on page 31.
12. Replace filler cap, start engine and check engine and oil filter for leaks. Correct any leaks before placing engine into service.
13. Stop engine and check oil level. Add additional oil if not to the full mark "F" on the dipstick.

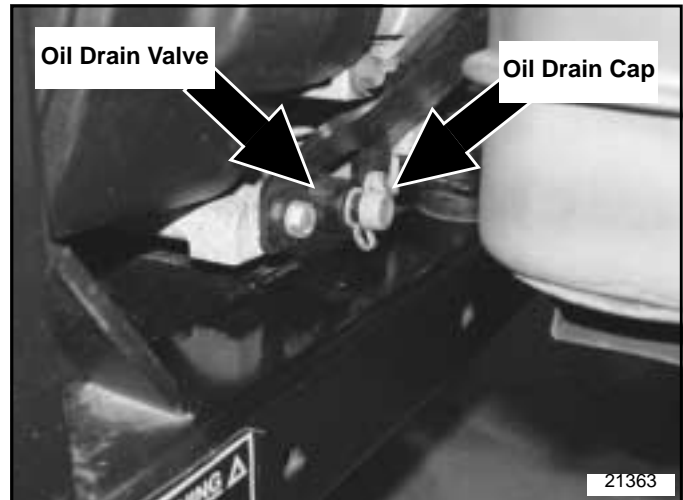

figure 7-3

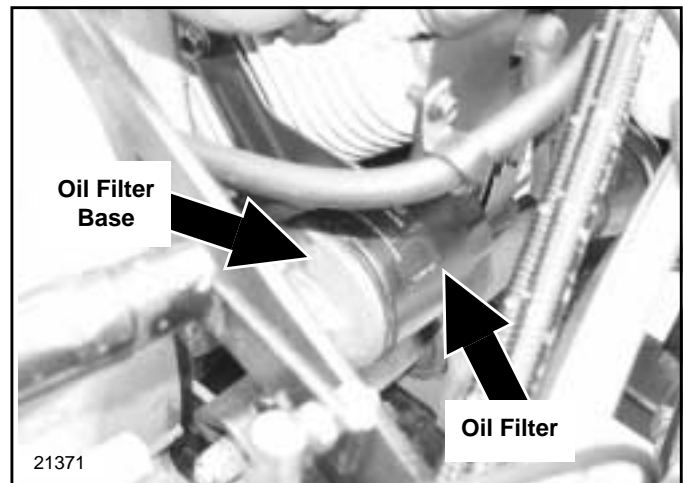
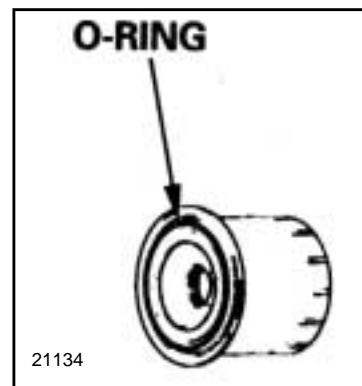

Figure 7-4



Oil Filter O-Ring  
Figure 7-5

## Section 7: Lubrication and Fluids

### Differential Oil

Refer to *Figure 7-6* and *Figure 7-7*

Differential lubrication is essential and must be maintained to ensure long life of the differentials. It is extremely important to use proper type and weight of oil. Also, it is important to check and change oil as outlined in the maintenance schedule below.

**NOTE:** Running vehicle low on differential oil can damage differential and void its warranty.

### Differential Maintenance Schedule

- Check case housing for damage and possible oil leakage after each use.
- Check gear lube level every 6 months or every 100 hours (whichever comes first).
- Change gear lube every 5 years or every 500 hours (whichever comes first).

### Differential Oil Type and Capacity

See also "Section 10: Specifications and Capacities" on page 40.

- Type of lubrication: S.A.E 80-90 wt. GL-5 Gear Lube
- Lubrication capacity: 2 quarts or fill to bottom of check plug opening.

### Differential Oil Level Check

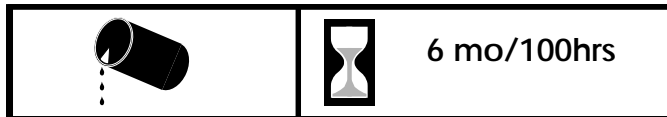

Check differential gear lube level at oil level check plugs (See *Figure 7-6* and *Figure 7-7*). Gear lube level should be filled to edge of oil level check hole.

1. Prepare vehicle for maintenance as outlined in steps 1-6 on page 22.
2. Remove oil level plug and verify oil is level with bottom of plug hole.
3. If low on oil, remove fill plug and add new differential oil until oil is level with bottom of fill hole.
4. Replace both plugs and tighten securely with 5 to 15 in. lbs of torque.

### Differential Oil Change

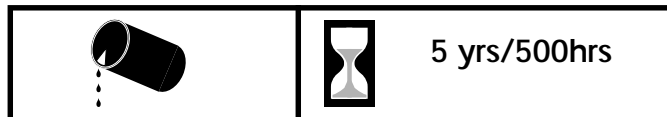

Warm oil drains quickly and completely. Drain used oil while it is still warm as follows:

1. Park vehicle on a level surface, set park brake, turn off ignition switch and remove switch key.
2. Place a suitable container below housing to catch used oil. Remove fill plug, level plug and drain plug.
3. Allow used oil to drain completely and then reinstall drain plug and tighten securely with 5 to 15 in. lbs. of torque.
4. Dispose of used oil in a manner that is compatible with the environment. Do not throw used oil in the trash, pour it on the ground, or down a drain.
5. Fill front and rear differential cases with 2 quarts or to bottom of oil level hole with recommended gear lube. See "Section 10: Specifications and Capacities" on page 40.
6. Replace fill plug and oil level plug. Tighten securely with 5 to 15 in. lbs. of torque.

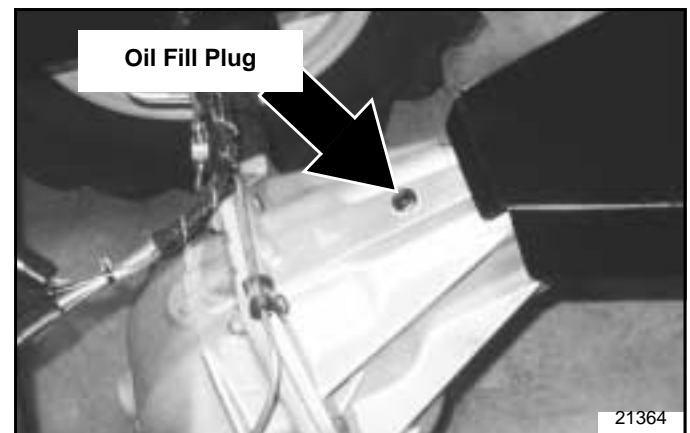

Figure 7-6

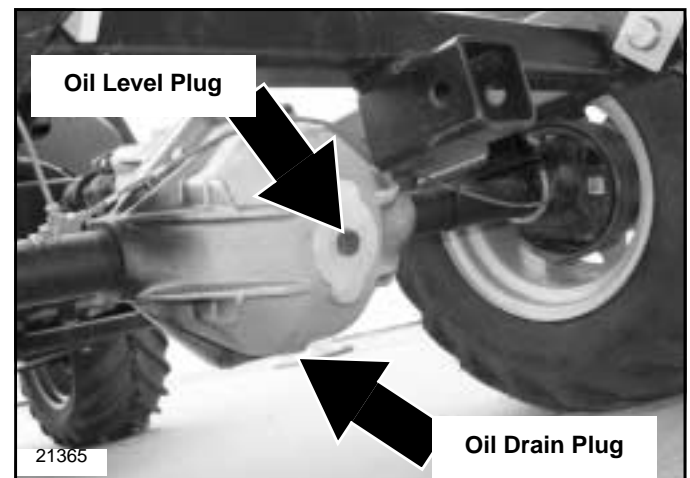

Figure 7-7

## Section 7: Lubrication and Fluids

### Transmission Fluid

Transmission lubrication is essential and must be maintained to ensure long life of the transmission. It is extremely important to use proper fluid. Also, it is important to check and change oil as outlined in the maintenance schedule below.

**NOTE:** Running vehicle low on transmission oil can damage transmission and void its warranty.

### Transmission Maintenance Schedule

- Check case housing for damage and possible fluid leakage after each use.
- Check fluid level every 6 months or every 100 hours (whichever comes first).
- Change fluid once every 4 years or every 400 hours (whichever comes first).

### Transmission Fluid Type and Capacity

See also "Section 10: Specifications and Capacities" on page 40.

- Type of Fluid: Dextron 3 automatic transmission fluid
- Fluid capacity: 2 quarts or fill to bottom of fill plug.

### Transmission Oil Level Check

Refer to Figure 7-8

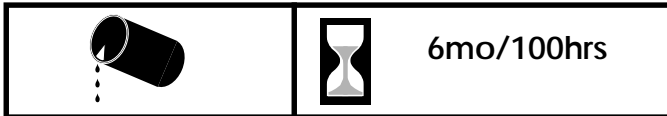

Check transmission oil level at fill plug (See Figure 7-8) as follows:

1. Prepare vehicle for maintenance as outlined in steps 1-6 on page 22.
2. Remove fill plug and verify oil is level with bottom of fill hole.
3. Add new fluid at the check hole if fluid level is low.
4. Replace fill plug and tighten securely.

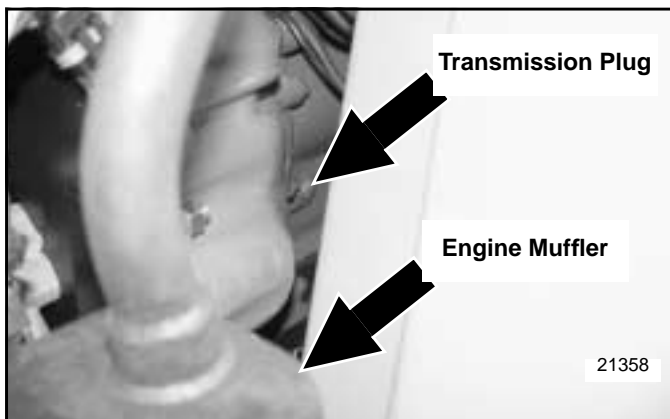
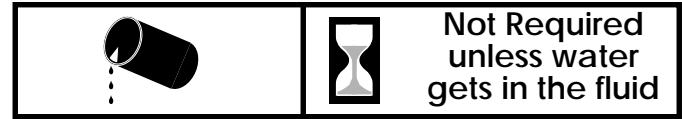

Figure 7-8

### Transmission Fluid Change



The transmission fluid needs to be changed only if water gets into it. Drain transmission fluid by siphoning the fluid out through the fill hole or remove transmission from the vehicle to drain the fluid out through the fill hole.

### Brake Fluid

For your safety and the safety of others it is important that the master cylinder fluid be maintained. Have a Land Pride Service Technician inspect the vehicle if the master cylinder is losing fluid frequently.

### Brake Fluid Maintenance Schedule

- Check fluid reservoir monthly.
- Fill reservoir immediately if low or if braking capabilities begin to fade.

### Brake Fluid Type and Capacity

See also "Section 10: Specifications and Capacities" on page 40

- Type of fluid: DOT 3
- Quantity: Fill to within 1/2" of reservoir opening.

### Brake Fluid Level Check

Refer to Figure 7-9

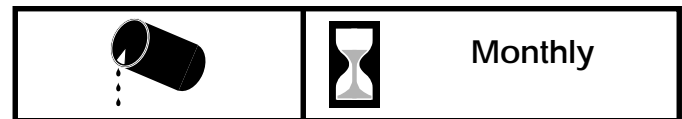

The master cylinder fluid reservoir is located just above the foot pedals. Remove filler cap and visually inspect level of fluid inside the reservoir. Add DOT 3 fluid to the reservoir until filled to within 1/2" of reservoir opening.

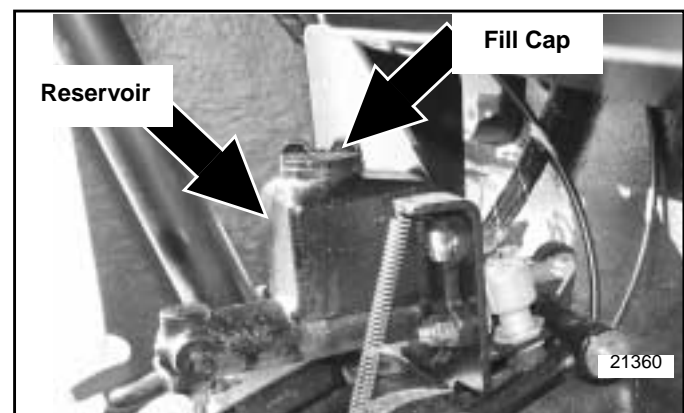

Figure 7-9

**Section 7: Lubrication and Fluids**

**Steering & Cargo Lift Cylinder Fluid**

**! WARNING**

*Hydraulic fluid under pressure can penetrate skin. Wear protective gloves and safety glasses or goggles when working with hydraulic systems. Use a piece of cardboard or wood rather than hands when searching for hydraulic leaks. If hydraulic fluid is injected into the skin, it must be surgically removed within a few hours by a doctor or gangrene may result.*

The hydraulic fluid operates the power steering, cargo lift and hydraulic controlled accessory equipment. For your safety and the safety of others it is important that the hydraulic fluid be maintained. If the reservoir is losing fluid frequently, have a Land Pride Dealer inspect the vehicle.

**Hydraulic Fluid Maintenance Schedule**

- Check fluid reservoir monthly.
- Fill reservoir immediately if low or if hydraulics are operating poorly.

**Hydraulic Fluid Type and Capacity**

See also "Section 10: Specifications and Capacities" on page 40

- Type of fluid: Dextron 3 automatic transmission fluid
- Quantity: 2 quarts. Tank should be 3/4 full when all accessories are in retracted position.

**Hydraulic Fluid Level Check**

Refer to Figure 7-10

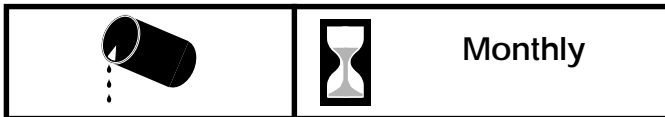

The fluid reservoir is located on the driver's side under the seat. Visually inspect fluid level inside the reservoir. Remove filler cap and add automatic transmission fluid if low.

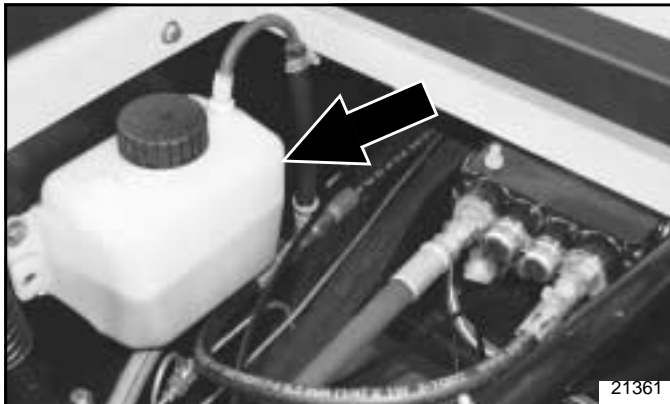

Figure 7-10

**Grease Type Lubrication**

There are several points on the vehicle that require lubrication. It is important that these points be lubricated frequently to maintain ease of lever operation and to ensure long bearing life.

**Driveline U-Joints**

Refer to Figure 7-11 and Figure 7-12

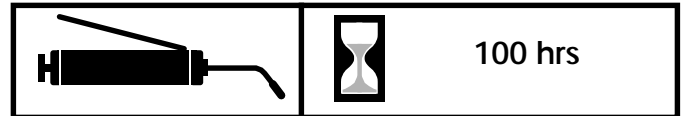

Grease every 100 hours of operation

- Type of Grease: Multipurpose
- Quantity: 3 or 4 pumps of the grease gun. Stop adding grease if lubricant is emerging through the seals.

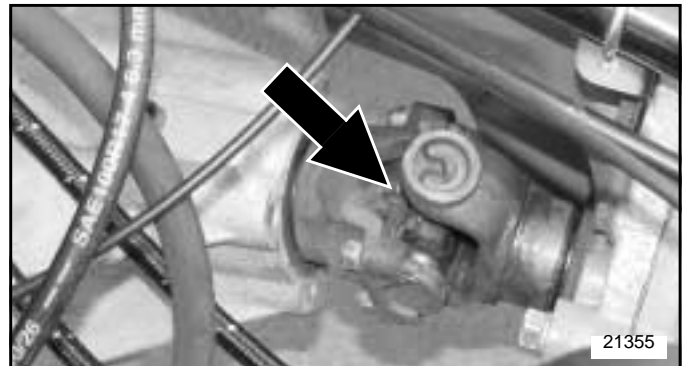

Front Drive Line U-Joint  
Figure 7-11

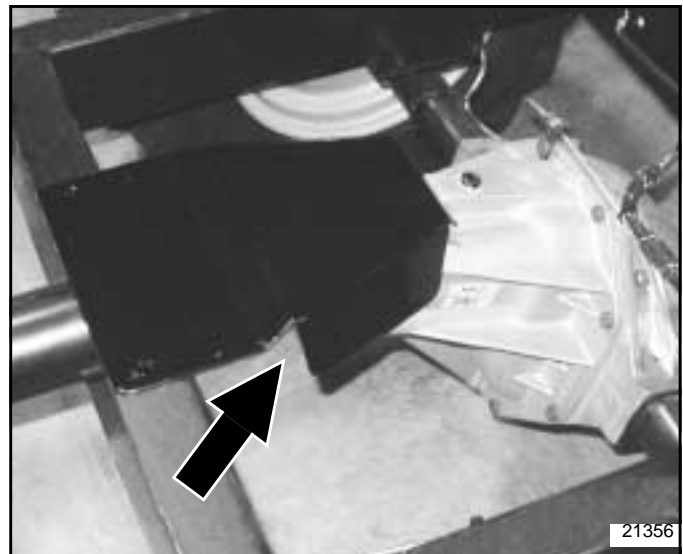

Rear Drive Line U-Joint  
Figure 7-12

## Section 7: Lubrication and Fluids

### Pillow Block Bearing

Refer to Figure 7-13

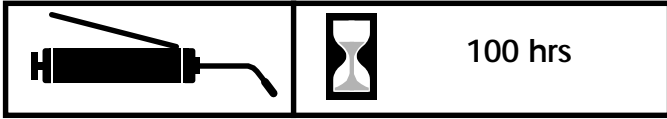

The Pillow block bearing is located along side the left side of the engine below the fuel filter.

- Grease every 100 hours of operation
- Type of Grease: Multipurpose
- Quantity: 3 or 4 pumps of the grease gun.  
Stop adding grease if lubricant emerges through the seals.

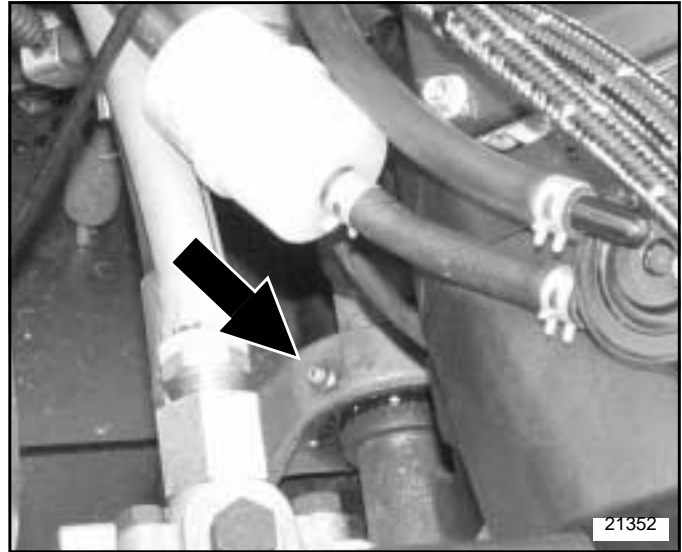
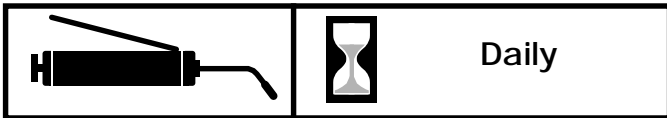

Figure 7-13

### Rotating Bearing Surfaces

Refer to Figure 7-14 and Figure 7-15



The swivel tube is located in the rear frame (See Figure 7-14).

The shift selector vertical pivot is located along the left side of the transmission (See Figure 7-15).

- Grease daily before putting into service
- Type of Grease: Multipurpose
- Quantity: Grease until lubricant emerges from one end of the bushing.

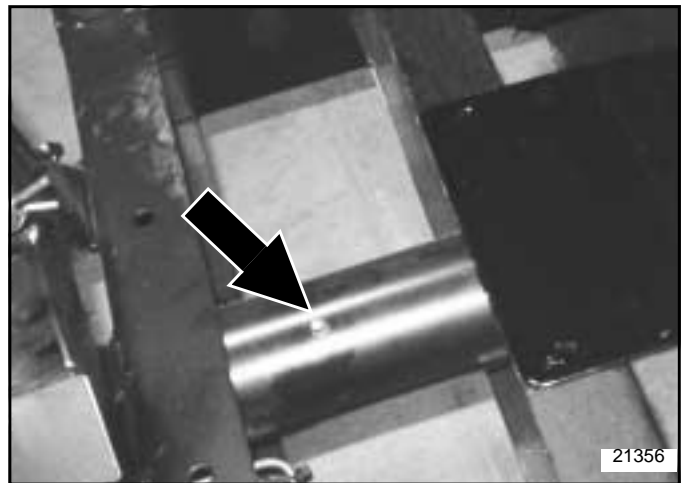

Figure 7-14

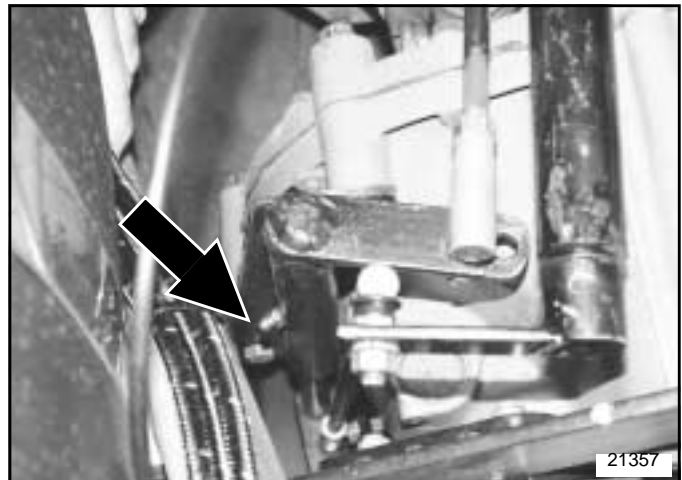

Figure 7-15

## Section 8: Seasonal Storage



### CAUTION

Fuel vapors are flammable and explosive. Do not store a vehicle with fuel in the tank in a building where fumes can reach a spark or an open flame (i.e. plug-in sockets, light switches, light fixtures, power tools, welders, pilot lights and stoves).

Engine exhaust fumes contain carbon monoxide. Do not run a vehicle inside a building any longer than what it takes to move it. Serious illness or death may result from prolonged exposure to carbon monoxide.

### Engine Preparation for Storage

1. Take vehicle out of gear, set park brake and run engine outside for 15 minutes minimum. Then shut vehicle off and remove ignition key.
2. Drain oil from crankcase while engine is still warm.
3. Change oil filter. Refer to page 32.
4. Refill with fresh oil of proper viscosity. Refer to page 31.
5. Replace fuel filter if needed. Refer to page 26.
6. Prepare fuel system as follows:

#### Short term storage (90 days or less):

- a. Siphon most of the fuel from the tank.
- b. Add fuel stabilizer to the tank per manufacturers recommendation.

**IMPORTANT:** Do not use fuel additives containing methanol or ethanol.

- c. Fill fuel tank with fresh fuel to prevent water condensation build-up.
- d. Run engine to circulate fresh fuel throughout engine components.

#### Long term storage (over 90 days):

- a. Siphon most of the fuel from the tank.
- b. Run engine until it stops from lack of fuel.

**NOTE:** Gasoline evaporates if left in carburetor for long periods, forming gum and varnish deposits in the carburetor. These deposits will cause engine flooding and loss of power.

- c. Remove spark plugs and pour a tablespoon of engine oil into each spark plug hole. Install plugs, but do not reconnect plug leads.
  - d. Crank engine with starter at least a dozen revolutions to distribute oil over cylinder walls and valve mechanism.
7. Clean exterior surface of engine. Spread a light film of oil over any exposed metal surfaces of engine that are subject to corrosion.

8. Clean dirt and chaff from cylinders and fins, blower housing and muffler.
9. Check oil fill cap and fuel tank cap to make certain they are securely in place.

### Vehicle Storage Preparation

1. Perform separate engine preparations listed previously before storing the vehicle.
2. Store vehicle in a clean, dry place.
3. Always set park brake, leave vehicle in gear and remove ignition key when parking the vehicle.
4. Before working around or on the vehicle, allow it to cool.
5. Remove all dirt and trash.
6. Clean and touch up all scrapes per "Section 9: Body Repair" on page 38.
7. Check thoroughly for any worn or damaged parts that need replacing including decals and order them from your Land Pride Dealer.
8. Thoroughly lubricate the vehicle according to lubrication instructions.
9. Block vehicle up to take weight off the tires.

**NOTE:** Do not deflate tires.

10. Clean battery and battery post. Check battery electrolyte level. Protect battery from freezing temperatures. Occasionally recharging battery during storage will extend battery life.
11. Secure a waterproof cover over the vehicle if stored outside.

### Vehicle Removal From Storage Preparation

1. Remove waterproof cover if used.
2. Clean vehicle, removing trash and dirt accumulation.
3. Install all safety shields and review safety precautions listed in this manual.
4. Reconnect spark plug leads to spark plugs.
5. Check engine oil level.
6. Check transmission oil level. If 4-wheel drive, check 4-wheel transfer case and front differential transmission oil level.
7. Charge battery.
8. Fill fuel tank with fresh gasoline.
9. Run vehicle at half speed for 5 minutes, checking operation of steering control levers.
10. Stop engine and check for oil leaks, loose fittings and overall condition of the vehicle.
11. Tighten any bolts that may have loosened.
12. Check and inflate tires to correct air pressure.



## Section 9: Body Repair

### Introduction

Land Pride Gondo bodies are constructed of fiberglass. Scuffs, light scratches and deep gouges are in most situations repairable. Land Pride recommends that you use a professional body shop to restore your vehicle's body. For your consideration, we have provided below a list of recommended tools, materials and steps suggested for repairing the fiberglass body.

**NOTE:** Land Pride does not supply the required tools, paint and materials needed to repair the vehicle body. All tools, paint and materials should be purchased locally.

### Light Scuff

#### Required Tools and Materials

(See note above)

- 1,000 rpm buffing tool, DeWalt #849
- Meguiars buffing compound #8432
- Meguiars polish #8232 (optional)
- Meguiars maroon cutting pad #W-7006
- Meguiars tan polishing pad #W-9006 (optional)
- Meguiars backing plate #W-64
- Soft clean cotton cloths

#### Steps to Repair

1. Clean entire area of repair. Clean water is fine for this purpose. **Do not use solvent** as this will damage the body surface.
2. Install cutting pad #7006 on buffer (maroon pad).
3. Spread compound on area of repair, use about as much as it takes to cover a half-dollar coin, this is a good starting point.
4. Set buffing tool to lowest possible speed on dial, do not buff at a high speed as this will heat and warp material.
5. Buff damage area until surface scuff disappears. A second and third application of compound may be required. Keep buffer moving over surface, this will help keep the surface cool. Clean compound residue off surface after each buffing operation. Do not continue to buff compound until dry, or buff the surface when dry. When all scuff marks have been buffed out the surface may still appear a little dull, if so, proceed to #6.
6. Install polish on surface as in step #3.
7. Spread #8232 polish on surface as in step #3.

8. Polish to a high luster or as required to match surrounding material.
9. Wipe clean with **soft clean** cloth; any dirt on cloth will mar surface.

### Scratch

#### Required Tools and Materials

(See note to left)

- 1,000 rpm buffing tool, DeWalt #849
- Meguiars buffing compound #8432
- Meguiars polish #8232 (optional)
- Meguiars maroon cutting pad #W-7006
- Meguiars tan polishing pad #W-9006 (optional)
- Meguiars backing plate #W-64
- Soft clean cotton cloths
- 3M interface sanding pad #05774
- Air Vantage finishing sander with 6-inch hook and loop pad
- 3M-P800 sanding film #00970

#### Steps to Repair

1. Clean entire area of repair. Clean water is fine for this purpose. **Do not use solvent** as this will damage the body surface.
2. Install interface-sanding pad onto finishing sander. Attach sanding film to Interface pad. (Take care in centering sanding pad and film on sander.)
3. Sand surface using about 45 P.S.I. air pressure at tool inlet, do not sand at a high pad speed, because speed causes the sanding film to load with dust and heats the body surface. Proper sander pad speed is based on cut and travel speed of pad, and downward pressure applied by the operator. To clean sanding pad surface, run sander face at 90 degrees on the edge of a piece of cardboard. This cleaning operation will help keep the sanding film clean and run cooler. Continue to sand surface until original scratch damage is no longer visible. Wipe the surface with a cloth then inspect to be sure the entire original scratch has been fully sanded away (very important).
4. Install cutting pad #7006 on buffer (maroon pad).
5. Spread compound #8432 on area of repair, use about as much as it takes to cover a half-dollar coin, this is a good starting point.
6. Set buffing tool to lowest possible speed on dial, do not buff at a high speed as this will heat and warp material.
7. Buff sanded area until surface scuff disappears.



## Section 9: Body Repair

---

8. A second and third application of compound may be required. Keep buffer moving over surface, this will help keep the surface cool. Clean compound residue off surface after each buffing operation. Do not continue to buff compound until dry.
9. Buff the surface of the body when dry. When all scuff marks have been buffed out the surface may still appear a little dull, if so, proceed to #10.
10. Install polishing pad #W-9006 on buffer (tan pad).
11. Spread #8232 polish on surface as in step #3.
12. Polish to a high luster or as required to match surrounding material.
13. Wipe clean with **soft clean** cloth; any dirt on cloth will mar surface.

## Deep Gouge

### Required Tools and Materials

(See note on page 37)

- 1,000 rpm buffing tool, DeWalt #849
- Evercoat Body Filler Easy Sand
- Sanding Pad
- DuPont Full-Thane Primer 421-15
- DuPont 3939 Cleaner
- DuPont Sealer 42470
- DuPont Chroma Base/ Clear Coat Paint System
- HVLP Paint Sprayer

### Steps to Repair

1. Sand damaged area with 500-grit paper to remove raised edges and to create abraded surface for proper adhesion.
2. Fill damaged area with Evercoat body filler (2-part system) and allow to completely dry.
3. Sand down high spots with 500-grit paper. If recesses are still visible due to filler shrinkage, apply second skim coat and again allow to dry completely, then sand surface flush with surrounding area.
4. Apply DuPont Full-Thane Primer 421-15 over body filler.
5. Once primer is completely dry, clean surface with DuPont 3939 Cleaner and again allow surface to dry completely.
6. Apply 42470 Sealer over body filler.
7. Apply color-matched paint system with HVLP paint sprayer according to supplier's recommendations.

## Section 10: Specifications and Capacities

## 4400EX Series

<b>Engine</b>	Kohler Command Pro Series	<b>Steering Wheel Dia.</b>	14"
<b>Engine Type</b>	4 stroke - air cooled V-Twin	<b>Body Cowling</b>	Fiberglass
<b>Horse Power</b>	20	<b>Floorboards</b>	Fiberglass
<b>Displacement</b>	624 cc	<b>Frame Construction</b>	Tube & channel
<b>Cylinders</b>	2	<b>Frame. Suspension</b>	Pivoting interactive
<b>Valving</b>	OHV	<b>Fenders</b>	Front: Integral Rear: Bed mounted
<b>Lubrication</b>	Pressurized	<b>Front Bumper</b>	Standard
<b>Engine Oil Type</b>	SAE 10W30	<b>Front Brush Guard</b>	Optional
<b>Engine Oil Capacity</b>	2 US quarts 1.9 Liters	<b>Seating</b>	Buckets - 2
<b>Engine Idle rpm</b>	1100 rpm +/- 100 rpm	<b>ROPS</b>	Standard
<b>Maximum Engine Static rpm</b>	3800 rpm	<b>Rear Hitch</b>	2" receiver
<b>Max. Torque</b>	32.5 lb@2600	<b>Approximate Curb Weight</b>	1400 lbs.
<b>Cooling</b>	Air	<b>Total Payload of Base Unit</b>	2200 lbs.
<b>ACG Output</b>	12V/20A	<b>Total Gross Vehicle Weight</b>	3600 lbs.
<b>Ignition</b>	Keyed	<b>Rear Cargo Box Capacity</b>	1800 lbs.
<b>Battery</b>	300 cca	<b>Maximum Tongue Weight</b>	250 lbs.
<b>Spark Arrestor</b>	Standard	<b>Maximum Towing Capacity</b>	2500 lbs.
<b>Headlights</b>	Standard	<b>Wheel Base</b>	68"
<b>Tail Lights</b>	Standard	<b>Tread Center Front</b>	43"
<b>Fuel Capacity</b>	8 gallons	<b>Tread Center Rear</b>	43"
<b>Fuel Type</b>	Unleaded fuel with 87 min octane (Methanol fuel not allowed)	<b>Width at front tires</b>	56"
<b>Front &amp; Rear Differential Oil Capacity and Type</b>	2 US qts. S.A.E 80-90wt. GL-5 Gear Lube	<b>Width at rear tires</b>	56"
<b>Transmission Case Fluid Capacity and Type</b>	2 US qts. Dextron 3 automatic transmission fluid	<b>Height</b>	54.5" top of steering wheel 76.5" top of ROPS
<b>Transmission</b>	4 or 5 - speed manual transmission	<b>Length</b>	117" without cargo box 135" with cargo box
<b>Gear Selection</b>	4 - forward and 1- reverse	<b>Floorboard Height</b>	With bar tires: 14" With turf tires: 13.5"
<b>Max. Speed</b>	up to 17 mph	<b>Min. Ground Clearance</b>	7 1/2"
<b>Brakes</b>	Front: Hydraulic drum Rear: Hydraulic drum	<b>Tire Size (Bar &amp; Turf)</b>	4-ply 26x12-12
<b>Brake oil</b>	DOT 3	<b>Tire Pressure (Front)</b>	15 psi
<b>Steering &amp; Cargo Lift Type</b>	Hydrostatic steering Hydraulic lift	<b>Tire Pressure (Rear)</b>	20 psi**
<b>Steering &amp; Cargo Reservoir Fluid Capacity &amp; Type</b>	2 US qts. Dextron 3 automatic transmission fluid		

\*\* Tire pressure may be increased to accommodate additional cargo load. Max.tire pressure is noted on tire side wall.



## Section 11: Troubleshooting

Symptoms	Probable Causes	Suggested Remedies
<b>Battery is dead</b>	Key switch is not in the off position.	Switch key to off position. Disconnect and recharge battery.
	Battery is worn out or defective.	Replace battery.
	Starter solenoid is shorted.	Replace starter solenoid.
<b>Battery will not charge up</b>	Battery connections are loose or corroded.	Clean and tighten battery connections.
	Battery fluid level is low.	Add distilled water to battery cell.
	Battery cell is dead.	Replace battery.
	Battery is worn out or defective.	
<b>Brakes are sticking (won't release)</b>	Master cylinder linkage is out of adjustment.	Adjust master cylinder linkage.
	Master cylinder return spring is broken.	Replace master cylinder return spring.
	Ground debris in brake linkage.	Clean debris from brake linkage.
<b>Brakes don't function</b>	Master cylinder oil level is low.	Add brake fluid to the master cylinder.
	Brake line is broken.	Replace brake line.
	Brake line has air in it.	Bleed brake line and add brake fluid.
	Master cylinder is defective.	Replace master cylinder.
<b>Electrical system does not work</b>	Electrical fuse is blown or missing.	Replace electrical fuse.
	Battery connections are loose or corroded.	Clean and tighten battery connections.
	Battery is worn out or defective.	Replace battery.
	Ignition switch is defective.	Replace ignition switch.
<b>Clutch is malfunctioning</b>	Clutch does not engage.	Readjust clutch linkage and/or replace throw-out bearing.
	Clutch does not disengage.	Readjust clutch linkage and/or replace throw-out bearing.
	Clutch worn out.	Replace clutch.
<b>Engine backfires</b>	Spark plug is fouled.	Replace or clean spark plug.
	Air intake restrictor upstream of air cleaner is missing or incorrectly installed.	Replace or correctly install air intake restrictor.
	Throttle cable is defective or out of adjustment.	Clean and oil throttle cable. Replace worn or damaged cable.
<b>Engine knocks</b>	Engine speed is set too low.	Adjust engine idle screw.
	Engine is overloaded.	Avoid overloading the engine.
	Fuel is stale or dirty.	Replace fuel with new fuel.

# Table of Contents

## Section 11: Troubleshooting

Symptoms	Probable Causes	Suggested Remedies
<b>Engine loses power</b>	Throttle cable is sticking.	Clean and oil throttle cable. Replace worn or damaged cable.
	Choke cable is sticking.	Clean and oil choke cable. Replace worn or damaged cable.
	Spark plugs are defective.	Replace spark plugs.
	Spark plugs are fouled.	Clean spark plugs or replace.
	Fuel supply is restricted.	Check for dirt in fuel tank.
	Fuel line is plugged, pinched, or kinked.	Clean or replace fuel line.
	Fuel leaks into the crankcase.	Clean or replace fouled spark plugs. Verify choke position is not stuck on.
	Engine oil level is high.	Drain excess oil, check for gas in the oil.
	Fuel octane is incorrect.	Use unleaded 87 minimum octane.
	Throttle cable is faulty or out of adjustment.	Adjust or replace throttle cable.
	Air cleaning element is plugged.	Replace or clean air cleaner with air.
	Engine is overheating.	See Symptoms for engine overheating.
<b>Engine overheats</b>	Engine cooling fins are plugged.	Allow engine to cool. Clean cooling fins with high pressure air.
	Engine oil level is low.	Add specified engine oil.
	Carburetor air intake tube is plugged.	Clean air intake tube.
	Air cleaning element is plugged or missing.	Replace or clean air cleaner with air.
<b>Engine runs unevenly</b>	Electrical connections are loose.	Reattach electrical connections.
	Engine cooling fins are plugged.	Allow engine to cool. Clean cooling fins with high pressure air.
	Throttle cable is sticking.	Clean and oil throttle cable. Replace worn or damaged cable.
	Choke cable is sticking.	Clean and oil choke cable. Replace worn or damaged cable.
	Fuel is stale or dirty.	Replace fuel with new fuel.
	Fuel line is plugged.	Clean fuel line.
	Fuel type is incorrect.	Use unleaded 87 minimum octane. (Methanol not allowed).
	Fuel leaks into the crankcase.	Clean or replace fouled spark plugs. Verify choke position is not stuck on.
	Spark Plug wiring is defective.	Replace spark plug wiring.
	Spark plug is defective.	Replace spark plugs.
	Spark plug is fouled.	Clean spark plugs or replace.
	Carburetor is not adjusted correctly.	Adjust carburetor.
	Air cleaner is plugged.	Replace or clean air cleaner with air.

# Table of Contents

## Section 11: Troubleshooting







Symptoms	Probable Causes	Suggested Remedies
<b>Engine starts in gear</b>	Clutch switch is improperly adjusted.	Adjust clutch switch to be engaged with clutch fully down.
<b>Engine stops running</b>	Gas tank is empty.	Refill gas tank.
	Spark Plug wiring is defective.	Replace spark plug wiring.
	Ignition switch is defective.	Replace ignition switch.
	Battery is worn out or defective.	Replace battery
	Crankshaft is broke.	Replace broken crankshaft.
<b>Gear Shift is malfunctioning</b>	Clutch is not fully depressed.	Fully depress clutch.
	Clutch plate does not release.	Adjust clutch linkage
	Shift linkage is out of adjustment.	Adjust shift linkage.
	Synchronizer is defective.	Replace synchronizer.
	Transmission jumps out of gear.	With gear shift in neutral, adjust shifter link at transmission to be in neutral position.
<b>Park brake doesn't work</b>	Park brake cable is broken.	Replace park brake cable.
	Park brake cable is jammed with debris.	Clean debris from park brake cable.
	Park brake is out of adjustment.	Adjust knob on end of park brake lever clockwise to tighten brake tension and counterclockwise to loosen brake tension.
<b>Starter cranks slowly</b>	Battery power is low.	Recharge battery.
	Battery connections are loose or corroded.	Clean and tighten battery connections.
	Battery is worn out or defective.	Replace battery.
	Harness connections are loose.	Reconnect harness connections.
	Harness pin connections are bent.	Straighten harness pins.
	Harness is defective.	Replace harness.
	Ignition switch is defective.	Replace ignition switch.
	Starter is defective.	Replace starter.
Engine oil is too heavy.	Replace with SAE 10W30 oil.	

# Table of Contents

## Section 11: Troubleshooting

Symptoms	Probable Causes	Suggested Remedies
<b>Starter does not work</b>	Neutral switch is not engaged.	Adjust neutral switch to be engaged with gear shift in neutral.
	Neutral switch is defective.	Replace neutral switch.
	Battery power is low.	Recharge battery.
	Battery connections are loose or corroded.	Clean and tighten battery connections.
	Battery is worn out or defective.	Replace battery.
	Harness connections are loose.	Reconnect harness connections.
	Harness pin connections are bent.	Straighten harness pins.
	Harness is defective.	Replace harness.
	Ignition switch is defective.	Replace ignition switch.
Starter is defective.	Replace starter switch.	
<b>Steering does not track correctly</b>	Improper tire inflation.	Inflate all tires to correct tire pressure.
	Hydraulic steering cylinder is not operating properly.	Inspect thoroughly and replace or tighten malfunctioning components.
<b>Steering play is excessive</b>	Worn mounting bushings at hydraulic cylinder connecting pins.	Inspect and replace all worn bushing and connecting pins.
	Malfunctioning steering sector.	Inspect and repair worn parts.
<b>Vehicle speed does not reach 17 MPH</b>	Throttle cable housing is set too close to engine preventing proper cable movement.	Reposition cable housing toward seats until all cable slack is removed between cable housing and engine.
	Carburetor is icing up.	Install Cold Weather Kit.
<b>Vehicle loses ground speed without loosing engine speed</b>	Clutch out of adjustment.	Adjust clutch linkage.
	Clutch worn out.	Replace clutch.



Torque Values Chart													
Bolt Size (Inches)	Bolt Head Identification						Bolt Size (Metric)	Bolt Head Identification					
	 Grade 2		 Grade 5		 Grade 8			 Class 5.8		 Class 8.8		 Class 10.9	
in-tpi <sup>1</sup>	N ·	ft-lb	N ·	ft-lb	N ·	ft-lb	mm x	N ·	ft-lb	N ·	ft-lb	N ·	ft-lb
1/4" - 20	7.4	5.6	11	8	16	12	M 5 X 0.8	4	3	6	5	9	7
1/4" - 28	8.5	6	13	10	18	14	M 6 X 1	7	5	11	8	15	11
5/16" - 18	15	11	24	17	33	25	M 8 X 1.25	17	12	26	19	36	27
5/16" - 24	17	13	26	19	37	27	M 8 X 1	18	13	28	21	39	29
3/8" - 16	27	20	42	31	59	44	M10 X 1.5	33	24	52	39	72	53
3/8" - 24	31	22	47	35	67	49	M10 X 0.75	39	29	61	45	85	62
7/16" - 14	43	32	67	49	95	70	M12 X 1.75	58	42	91	67	125	93
7/16" - 20	49	36	75	55	105	78	M12 X 1.5	60	44	95	70	130	97
1/2" - 13	66	49	105	76	145	105	M12 X 1	90	66	105	77	145	105
1/2" - 20	75	55	115	85	165	120	M14 X 2	92	68	145	105	200	150
9/16" - 12	95	70	150	110	210	155	M14 X 1.5	99	73	155	115	215	160
9/16" - 18	105	79	165	120	235	170	M16 X 2	145	105	225	165	315	230
5/8" - 11	130	97	205	150	285	210	M16 X 1.5	155	115	240	180	335	245
5/8" - 18	150	110	230	170	325	240	M18 X 2.5	195	145	310	230	405	300
3/4" - 10	235	170	360	265	510	375	M18 X 1.5	220	165	350	260	485	355
3/4" - 16	260	190	405	295	570	420	M20 X 2.5	280	205	440	325	610	450
7/8" - 9	225	165	585	430	820	605	M20 X 1.5	310	230	650	480	900	665
7/8" - 14	250	185	640	475	905	670	M24 X 3	480	355	760	560	1050	780
1" - 8	340	250	875	645	1230	910	M24 X 2	525	390	830	610	1150	845
1" - 12	370	275	955	705	1350	995	M30 X 3.5	960	705	1510	1120	2100	1550
1-1/8" - 7	480	355	1080	795	1750	1290	M30 X 2	1060	785	1680	1240	2320	1710
1 1/8" - 12	540	395	1210	890	1960	1440	M36 X 3.5	1730	1270	2650	1950	3660	2700
1 1/4" - 7	680	500	1520	1120	2460	1820	M36 X 2	1880	1380	2960	2190	4100	3220
1 1/4" - 12	750	555	1680	1240	2730	2010							
1 3/8" - 6	890	655	1990	1470	3230	2380							
1 3/8" - 12	1010	745	2270	1670	3680	2710							
1 1/2" - 6	1180	870	2640	1950	4290	3160							
1 1/2" - 12	1330	980	2970	2190	4820	3560							

<sup>1</sup> in-tpi = nominal thread diameter in inches-threads per  
<sup>2</sup> N · m = newton-meters  
<sup>3</sup> ft-lb= foot pounds  
<sup>4</sup> mm x pitch = nominal thread diameter in millimeters x

Torque tolerance + 0%, -15% of torquing values. Unless otherwise specified use torque values listed above.

**Section 12: Appendix**

---

**Notes**



## Section 12: Appendix

## Land Pride Limited Warranty Utility Vehicle

**Land Pride**, A Division of Great Plains Manufacturing, Inc., 1525 East North Street, Salina, Kansas, USA (hereinafter "Land Pride") warrants for a period of twelve (12) months from the date of initial retail purchase from an authorized Land Pride Utility Vehicle dealer that each new Land Pride Utility Vehicle shall be free, under normal use and maintenance, from any defect in material and workmanship subject to the following conditions, exclusions, obligations and limitations.

1. **Coverage** Any material or workmanship found and determined to be defective by Land Pride within the (12) twelve month warranty period shall be remedied without charge for parts or labor at any authorized Land Pride Utility Vehicle dealership.
2. **Owner's Obligations** The following obligations must be fulfilled by the owner to maintain the validity of Land Pride warranty:
  - b. The original owner must service the vehicle according to the periodic maintenance charts contained in the Operator's Manual as neglecting to do so can impede the warranty process. These inspections, maintenance services and adjustments are to be performed at the owner's expense.
  - c. The owner must present a copy of the warranty registration card or other positive proof of initial retail purchase date issued at the time of purchase, to an authorized Land Pride Utility Vehicle dealer at the time the warranty repairs are to be performed on the vehicle.
3. **Exclusions** The following are specifically excluded from this warranty:
  - a. Any Land Pride Utility Vehicle used for rental purposes.
  - b. Any Land Pride Utility Vehicle used to tow loads in excess of the maximum trailer weight specified in the Operator's Manual.
  - c. Any Land Pride Utility Vehicle used to carry loads in excess of the maximum vehicle load rating including occupants and cargo as stated in the Operator's Manual.
  - d. Any Land Pride Utility Vehicle that has been altered or modified without Land Pride's specific recommendation, approval and authorization in writing.
  - e. Any Land Pride accessories that are covered by the Land Pride Parts and Accessories Warranty Policy.
  - f. Any Land Pride Utility Vehicle that has not been completely and properly assembled and pre-delivered by an authorized Land Pride Utility Vehicle dealer.
4. **Limitations** This warranty shall not apply to or include any of the following:
  - a. Repair or replacement required as result of (I) accident, (II) misuse or neglect, (III) lack of reasonable and proper maintenance, (IV) repairs improperly performed or replacements improperly installed, (V) use of replacement parts or accessories not conforming to Land Pride specifications which adversely affect performance and/or durability, (VI) alterations or modifications not recommended or approved in writing by Land Pride and/or (VII) wear and deterioration occasioned by the use of this vehicle.
  - b. Pre-delivery, routine maintenance, service and adjustments.
  - c. Engine (Warranty is covered by the original engine manufacturer).
  - d. Tires, belts, shocks, brakes and body (Considered wear items).
5. **Limited Liability** The liability of Land Pride under the twelve (12) month warranty is limited solely to the remedying of defects in materials or workmanship by an authorized Land Pride Utility Vehicle dealer at its place of business during customary business hours. This warranty does not cover inconvenience, loss of use of the vehicle, or transportation of the vehicle to or from the Land Pride dealer. **Land Pride shall not be liable for any other expense, loss, or damage, whether direct, incidental, consequential, or exemplary arising in connection with the sale or use of or the inability to use the Land Pride Utility Vehicle for any purpose.** Some states, provinces or countries do not allow the exclusion or limitation of any incidental or consequential damages, so the above limitation or exclusion may not apply to you.
  - a. No express warranty is given by Land Pride with respect to the Land Pride Utility Vehicle except as set forth herein. Any warranty implied by law, including any warranty of merchantability or fitness for a particular purpose, is expressly limited to the twelve (12) month warranty terms set forth herein. The foregoing statements of warranty are exclusive and in lieu of all other remedies. Some states, provinces or countries do not allow limitations on how long an implied warranty lasts, so the above limitation may not apply to you.
  - b. No dealer is authorized to modify this Land Pride Utility Vehicle Warranty.
  - c. Any breach of warranty claim must be brought forth within 15 months of original sale.
6. **Legal Rights** This warranty gives you specific legal rights and you may also have other rights which vary from state, province or country.

Effective January 2, 2003



Corporate Office: P.O. Box 5060  
Salina, Kansas 67402-5060 USA

[www.landpride.com](http://www.landpride.com)

## Free Manuals Download Website

<http://myh66.com>

<http://usermanuals.us>

<http://www.somanuals.com>

<http://www.4manuals.cc>

<http://www.manual-lib.com>

<http://www.404manual.com>

<http://www.luxmanual.com>

<http://aubethermostatmanual.com>

Golf course search by state

<http://golfingnear.com>

Email search by domain

<http://emailbydomain.com>

Auto manuals search

<http://auto.somanuals.com>

TV manuals search

<http://tv.somanuals.com>